

seating

price & application guide

09.25.2023



teknion

update summary

Please be advised that information has been updated within the Seating Price & Application Guide. To highlight these updates, a summary has been created for your reference.

new

The following products have been added:

- Around Conference Chair, Mesh Back (NARC)
- Around Conference Chair, Upholstered Back (NARP)

The following products are now available with wood legs:

- Banqs Single-Sided Solo Focus (NBS/NBM)
- Banqs Left Corner Alcove Solo Focus (NBL/NBN)
- Banqs Right Corner Alcove Solo Focus (NBR/NBO)
- Banqs Full Alcove Solo Focus (NBF/NBP)
- Banqs Rectangular Bench, No Back (NBAR/NBWR)
- Banqs Single-Sided Sofa (NBAS/NBWS)
- Banqs Back-to-Back Sofas (NBAB/NBWB)
- Banqs Corner Alcove Sofa (NBAC/NBWC)
- Banqs Full Alcove Sofa (NBAF/NBWF)
- Banqs Freestanding Occasional Table (NBAH/NBWH)
- Banqs Freestanding Occasional Table with Screens (NBAL/NBWL)

Please note, first orders for new products will be accepted on September 25, 2023. All software will also be updated by September 25, 2023. If you have any questions regarding the information enclosed, please contact your Teknion Customer Service Representative.

where to find the information you need

Teknion provides an array of tools and information resources to help you get things done simply and easily. From product pricing to application guidelines to online planning suggestions, you will find what you need when you need it.

guide contents

This guide contains all the information you need to order this product through your specification software. The Introduction section provides everything you need to get started, including an index for product reference. The Application Guide section contains detailed specification guidelines, application and planning information to help you plan your project correctly. The Price Guide sections provide detailed pricing and specification information by product type. Available online at www.teknion.com.

Xpress The Xpress symbol is displayed beside products that are offered in Teknion's Xpress Program. Available online at www.teknion.com.

where to find the information you need

All Teknion marketing materials are available online at www.teknion.com, including:

price & product guide

application guide

planning tool

installation guides

fabrics & finishes

construction notes

product photography & drawings

measurements, weights & volumes

order forms

warranty/terms & conditions of sale

xpress program guide

teknion forms

The following forms are available online at www.teknion.com, to help you specify and place your order if required:

teknipaint

If you require a custom paint color match, you must submit a TekniPaint form.

using your own material (COM)

If you wish to use your own material on fabric-covered products, you must submit a completed COM form including a sample upholstery and safety testing. A COM Order Information Sheet must also be submitted. This form captures all relevant ordering and tracking information. A COM Request for Yardage Calculation form may be sent to Teknion for preliminary yardage requirements.

placing a manual order

Complete an Order Cover Sheet with the information we need to fill your order. This is the most important step. If the Order Cover Sheet is not complete and correct, the order may be delayed.

key requirements

If you require that certain pieces share the same locks you will need to specify Set of Keys Alike (SOKL) located in the Price and Product Guide.

user feedback

How is our marketing material working for you?

Feedback from the user is very important to the quality of Teknion's marketing material. We ask that if you have suggestions on how you think we could improve content OR if you have found an error, that you contact your Teknion Technical Services department.





INTRODUCTION	7
WORK CHAIRS	35
MULTI-USE CHAIRS	181
STACKING CHAIRS	289
SOFT SEATING	327

introduction

introduction

WHERE TO FIND THE INFORMATION YOU NEED.	3
SEATING OVERALL PRODUCT MAP	8
INDEX	24
ERGONOMIC CONSIDERATIONS	28
HOW TO CHOOSE A CHAIR: SEATING APPLICATIONS	30
HOW TO CHOOSE A CHAIR: FAMILY APPLICATION MATRIX	32
HOW TO CHOOSE A CHAIR: FAMILY MECHANISM MATRIX	33

work chairs

Amicus

Pages 50



Mid-Back –
No Arms



Mid-Back –
Fixed T-Arms



Mid-Back –
2D T-Arms



Mid-Back –
3D T-Arms



High-Back –
No Arms



High-Back –
Fixed T-Arms



High-Back –
2D T-Arms



High-Back –
3D T-Arms

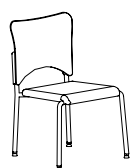

Four-Leg Frame –
No Arms



Four-Leg Frame –
Integrated Arms

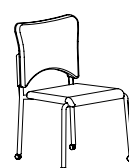

Four-Leg Frame
with Casters –
No Arms



Four Leg Frame
with Casters –
Integrated Arms



Cantilever Frame –
No Arms



Cantilever Frame –
Integrated Arms

Around

Pages 60



Task Chair
Mesh Back –
2D Arms



Task Chair
Mesh Back –
4D Arms



Task Chair
Upholstered
Back –
2D Arms



Task Chair
Upholstered
Back –
4D Arms



Swivel Stool
Mesh Back –
2D Arms



Swivel Stool
Mesh Back –
4D Arms



Swivel Stool
Upholstered
Back –
2D Arms



Swivel Stool
Upholstered
Back –
4D Arms

(also available as a Multi-Use Chair)



Guest Chair
Mesh Back



Guest Chair
Upholstered Back



Conference Chair,
Mesh Back



Conference Chair,
Upholstered Back

work chairs (continued)

AT Chair

Pages 74



Essa Chair

Pages 82



No Arms



Fixed Arms



Height-Adjustable
Arms



High-Back –
T-Arms

Marini

Pages 87

Nuova Contessa

Pages 95



All Mesh
No Headrest –
Fixed Arms



All Mesh
No Headrest –
4D Arms



Dual Upholstered
No Headrest –
Fixed Arms



Dual Upholstered
No Headrest –
4D Arms



With Headrest



With Coat Hanger

Metric Chair

Pages 104



Metric Chair,
Single Upholstered



Metric Chair,
Dual Upholstered



Metric Chair,
Mixed (Outside Inside)
Upholstered

work chairs (continued)

Projek

Pages 110



Task Chair
High Back –
No Arms



Task Chair
High Back –
Fixed T-Arms



Task Chair
High Back –
2D Arms



Task Chair
High Back –
4D Arms



Task Chair
With Headrest



Swivel Stool –
No Arms



Swivel Stool –
2D Arms



Swivel Stool –
4D Arms High



Swivel Stool –
With Headrest

Sabrina

Pages 120

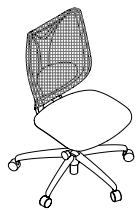

No Arms



Fixed Arms

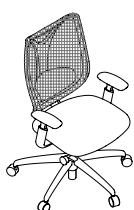

Adjustable Arms

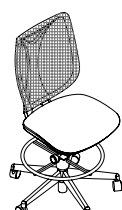

Swivel Stool –
No Arms



Swivel Stool –
Fixed Arms

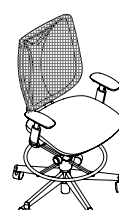

Swivel Stool –
Adjustable Arms

back options

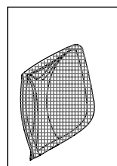

No Headrest –
No Coat
Hanger

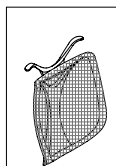

No Headrest –
With Coat
Hanger

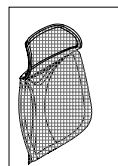

With Headrest –
No Coat
Hanger

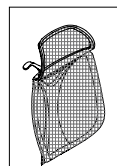

With Headrest –
With Coat
Hanger

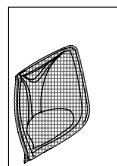

With Lumbar

work chairs (continued)

Savera & Savera XL

Pages 136

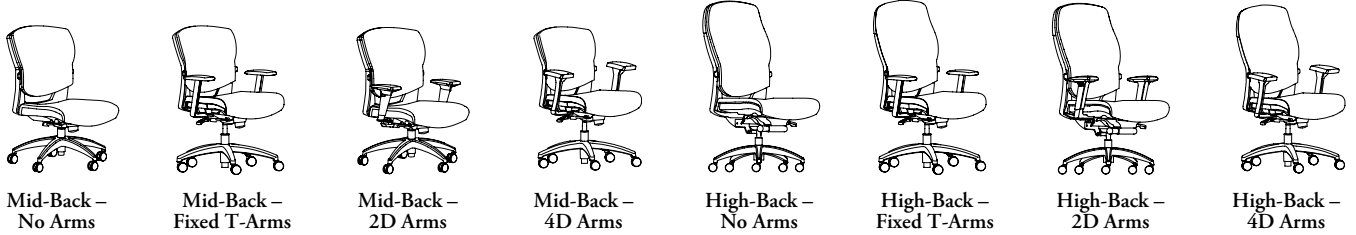

Savera Task is available with a Synchro-Tilt, Multi-Tilt and Swivel-Tilt Mechanism

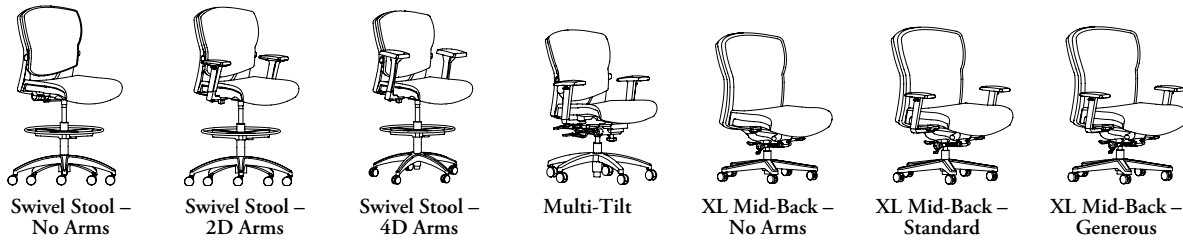

t-3

Pages 148

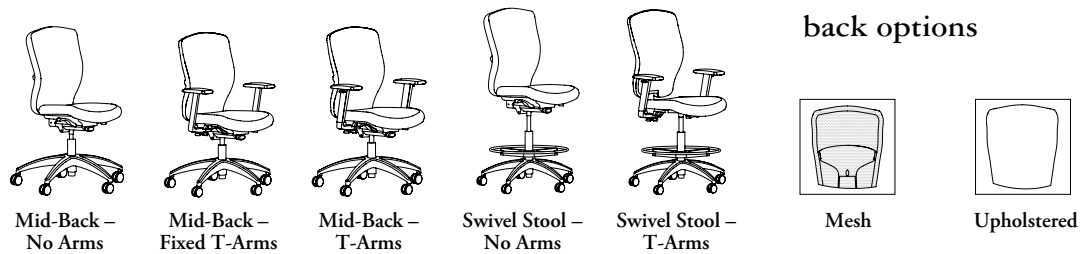

work chairs (continued)

Tone

Pages 164

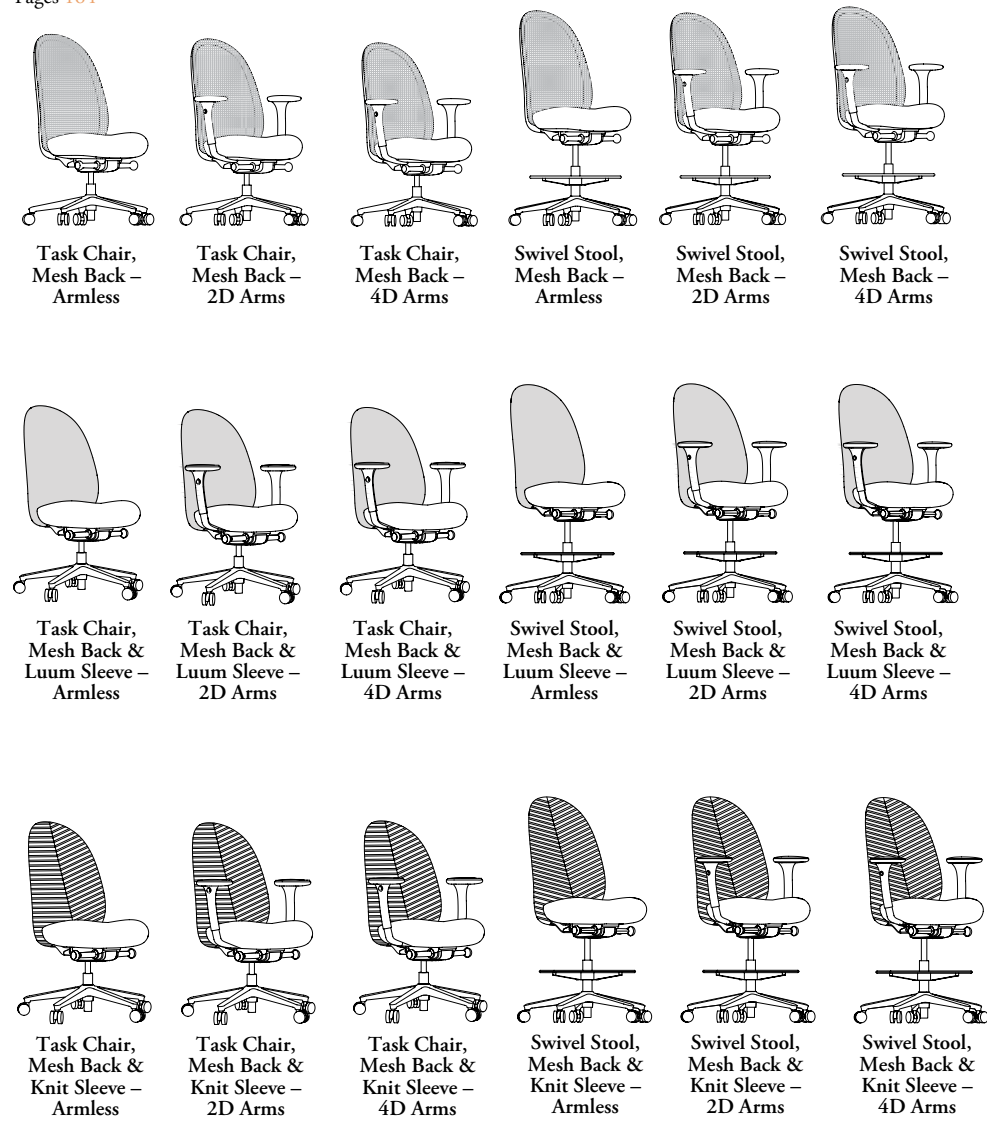

Task Chair,
Mesh Back –
Armless

Task Chair,
Mesh Back –
2D Arms

Task Chair,
Mesh Back –
4D Arms

Swivel Stool,
Mesh Back –
Armless

Swivel Stool,
Mesh Back –
2D Arms

Swivel Stool,
Mesh Back –
4D Arms

Task Chair,
Mesh Back &
Luum Sleeve –
Armless

Task Chair,
Mesh Back &
Luum Sleeve –
2D Arms

Task Chair,
Mesh Back &
Luum Sleeve –
4D Arms

Swivel Stool,
Mesh Back &
Luum Sleeve –
Armless

Swivel Stool,
Mesh Back &
Luum Sleeve –
2D Arms

Swivel Stool,
Mesh Back &
Luum Sleeve –
4D Arms

Task Chair,
Mesh Back &
Knit Sleeve –
Armless

Task Chair,
Mesh Back &
Knit Sleeve –
2D Arms

Task Chair,
Mesh Back &
Knit Sleeve –
4D Arms

Swivel Stool,
Mesh Back &
Knit Sleeve –
Armless

Swivel Stool,
Mesh Back &
Knit Sleeve –
2D Arms

Swivel Stool,
Mesh Back &
Knit Sleeve –
4D Arms

Luum Sleeve

Knit Sleeve

Visio

Pages 179



Mesh Back

multi-use chairs

Ability

Pages 190



Round

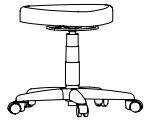

Triangular

Around Guest Chair

Pages 196



Guest Chair
Mesh Back



Guest Chair
Upholstered Back

Around Conference Chair

Page 202



Conference Chair,
Mesh Back



Conference Chair,
Upholstered Back

Just-Us

Pages 208



Just-Us Chair,
Upholstered Seat

Kupp

Pages 216



Kupp Chair,
Plastic Seat



Kupp Chair,
Upholstered Seat



Kupp Chair,
No Arms,
Plastic Seat



Kupp Chair,
No Arms,
Upholstered Seat

Occo

Pages 226



Occo Chair -
4 Legs



Occo Chair -
5-Star Base

Sitara

Pages 230



Sprout

Pages 244

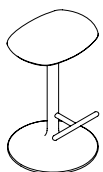

Sprout Stool

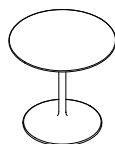

Sprout Round Table

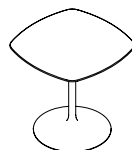

Sprout Soft-Square
Table

Synapse

Pages 250



Mid-Back -
Integrated Arms

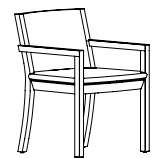

Mid-Back -
Integrated Arms,
Fully Upholstered

multi-use chairs (continued)

Taiga

Pages 254



Upper Back Upholstered



Fully Upholstered



Vertical Wood Slat Back

Variable Swivel Multi-Use Work Chair

Pages 270



Swivel
Work Chair –
No Arms
with Casters



Swivel
Work Chair –
Integrated Arms
with Casters



Swivel
Work Chair –
No Arms
with Glides



Swivel
Work Chair –
Integrated Arms
with Glides



Swivel Stool –
No Arms
with Casters



Swivel Stool –
Integrated Arms
with Casters



Swivel Stool –
No Arms
with Glides



Swivel Stool –
Integrated Arms
with Glides

multi-use chairs (continued)

Variable Conference Chair

Pages 282



Conference Chair – No Arms with Casters Conference Chair – Integrated Arms with Casters Conference Chair – No Arms with Glides Conference Chair – Integrated Arms with Glides HybrED Chair – Storage Tray Base No Worksurface Tablet HybrED Chair – Storage Tray Base With Worksurface Tablet HybrED Chair – Storage Tray Base With Worksurface Tablet and Cup Holder HybrED Chair – Height-Adjustable Worksurface Tablet HybrED Chair – Height-Adjustable Worksurface Tablet and Cup holder

(also available as a Stacking Chairs)

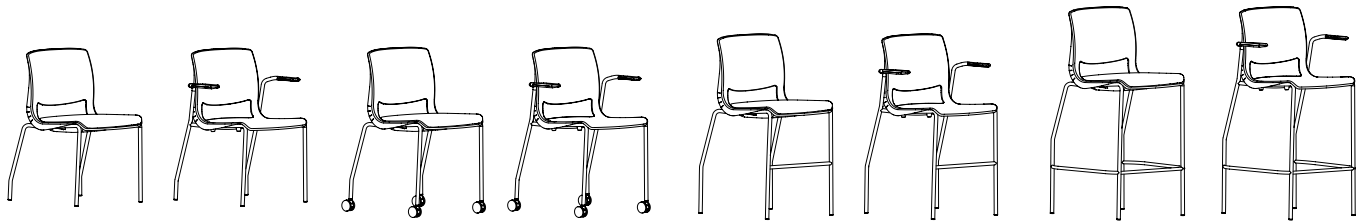

Stacking Chair – With Glides No Arms Stacking Chair – With Glides Integrated Arms Stacking Chair – With Casters No Arms Stacking Chair – With Casters Integrated Arms Stacking Stool – Counter Height No Arms Stacking Stool – Counter Height Integrated Arms Stacking Stool – Bar Height No Arms Stacking Stool – Bar Height Integrated Arms

variable accessories (also available as a Stacking Chairs)



With Tablet (right-handed) With Tablet (left-handed) With Bookrack With Tablet (right-handed) and Bookrack With Tablet (left-handed) and Bookrack

* Ganging Device, Upholstered Seat, Upholstered Seat and Back and Dolly also available

stacking chairs

Nami

Pages 296

nami accessories

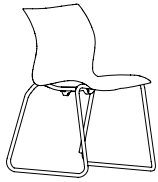

Stacking Chair
Sled Frame –
No Arms
Plastic and
3D Wood Shell

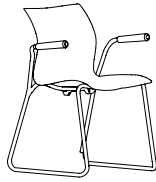

Stacking Chair
Sled Frame –
Integrated Arms
Plastic and
3D Wood Shell



Guest Counter Stool
Sled Frame –
No Arms
Plastic and
3D Wood Shell

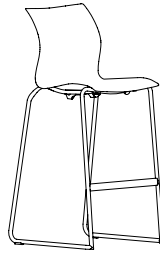

Bar Stool
Sled Frame –
No Arms
Plastic and
3D Wood Shell

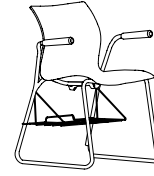

With Bookrack



With Tablet

Variable

Pages 308



Stacking Chair –
With Glides
No Arms



Stacking Chair –
With Glides
Integrated Arms



Stacking Chair –
With Casters
No Arms



Stacking Chair –
With Casters
Integrated Arms



Stacking Stool –
Counter Height
No Arms



Stacking Stool –
Counter Height
Integrated Arms



Stacking Stool –
Bar Height
No Arms

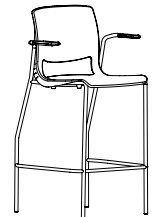

Stacking Stool –
Bar Height
Integrated Arms

variable accessories



With Tablet
(right-handed)



With Tablet
(left-handed)



With Bookrack

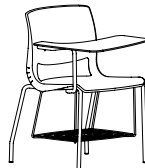

With Tablet
(right-handed) and
Bookrack



With Tablet
(left-handed) and
Bookrack

* Ganging Device, Upholstered Seat, Upholstered Seat and Back and Dolly also available

Volume

Page 320

volume accessories

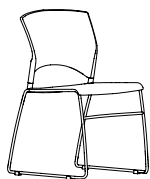

Stacking Chair – No
Arms



With Tablet
(right-handed)

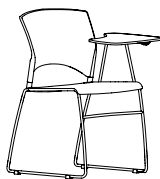

With Tablet
(left-handed)



With Bookrack



With Tablet
(right-handed) and
Bookrack

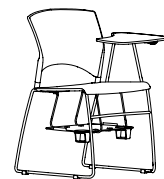

With Tablet
(left-handed) and
Bookrack

* Ganging Device, Upholstered Seat and Dolly also available

stacking chairs (continued)

Zone®

zone accessories

Page 324



Four-Leg –
No Arms



Four-Legs –
Cantilever Arms



With Bookrack

* Ganging Device, Dolly also available



soft seating

Aegis

Pages 340

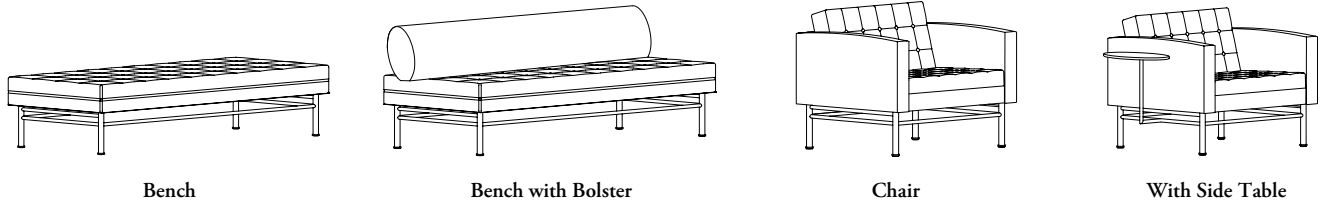

Banqs

Pages 362

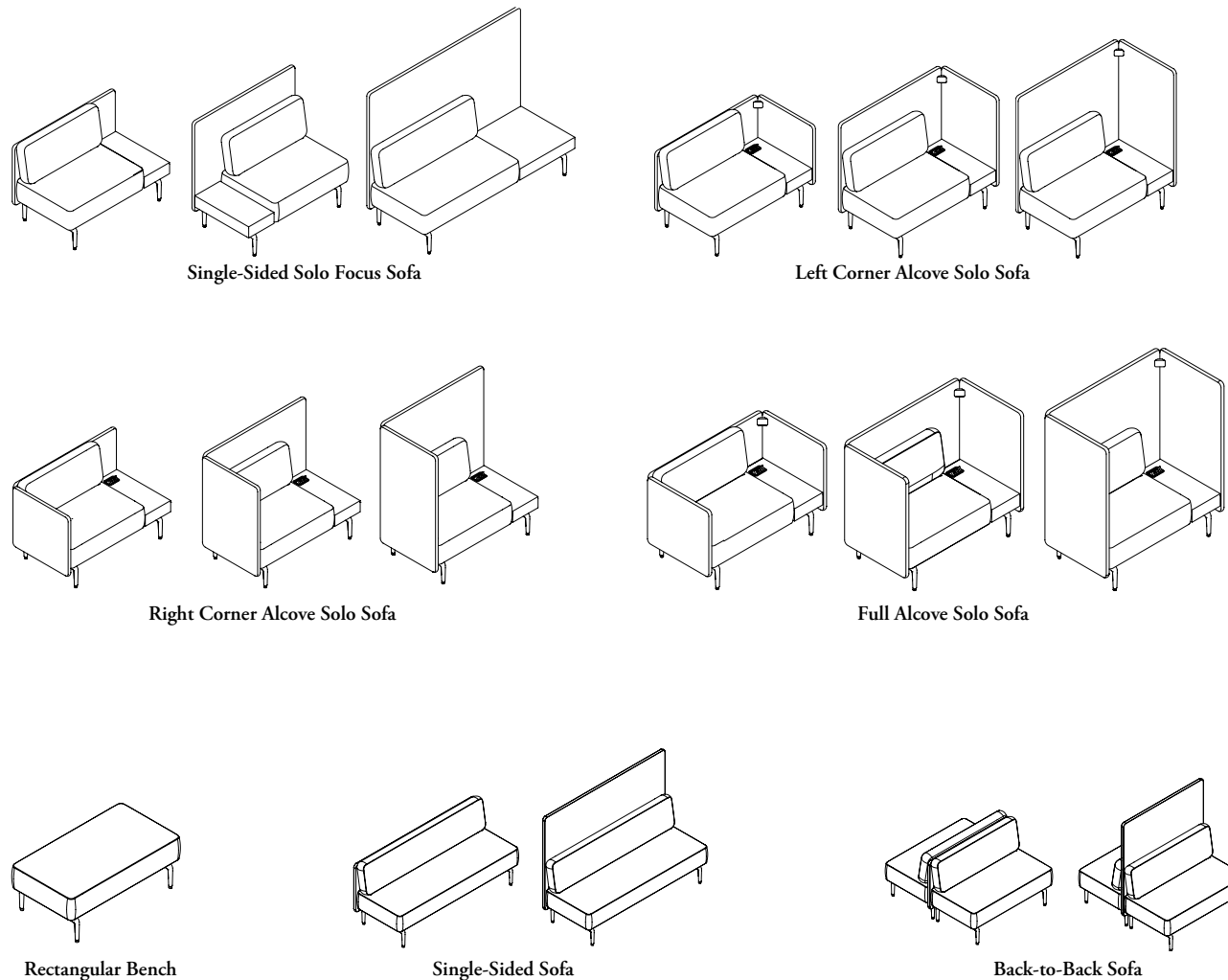

soft seating (continued)

Banqs (Continued)

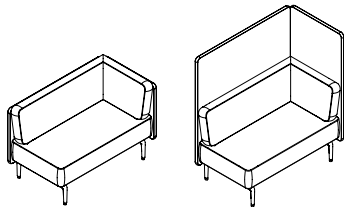

Corner Alcove Solo Sofa

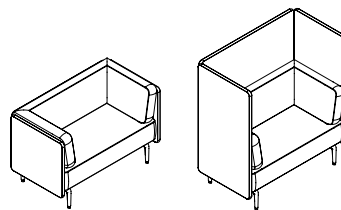

Full Alcove Sofa

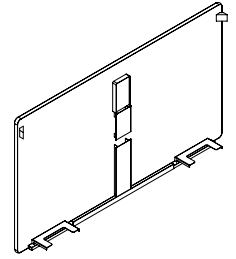

High Spanning Screen

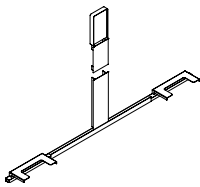

Digital Share Wall Mount Integration Kit

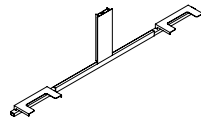

Wire Management Kit for Table with Power Pill at Architectural Wall

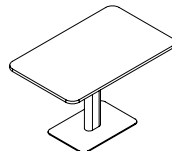

Table with Flat Base

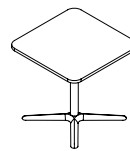
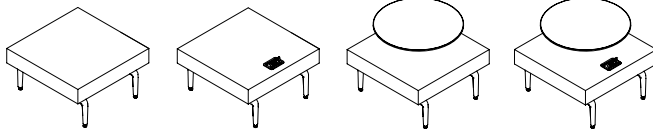
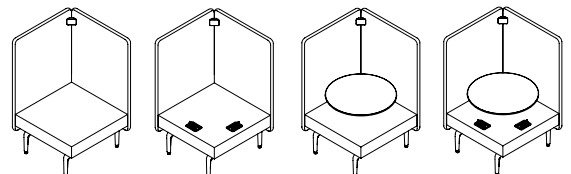

Table with Four-Prong Base



Freestanding Occasional Table



Freestanding Occasional Table with Screen



Untethered Cushion



Repositionable Coat Hook

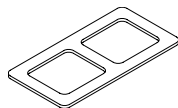

Ganging Plate



Ganging Kit



Sofa Undermount Power

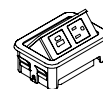

Small Power Flip

soft seating (continued)

Belize

Page 462

side panel options

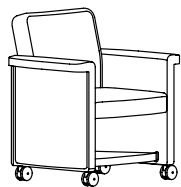

No Accessories

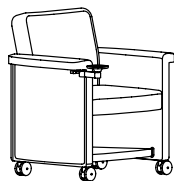

With Cup Holder



With Tablet



With Tablet and Cup Holder



Upholstered



Foundation Laminate

Bonds

Pages 484

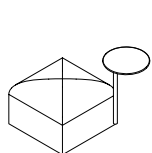

Freestanding Single Block

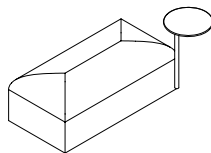

Freestanding Double Block

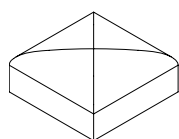

Building Block Seat, Not Strap Compatible

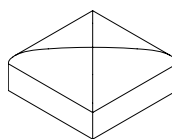

Building Block Seat, Strap Compatible

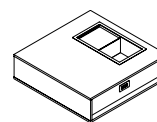

Building Block Table - Square

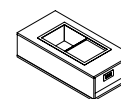

Building Block Table - Rectangular

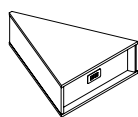

Building Block Table - Triangular

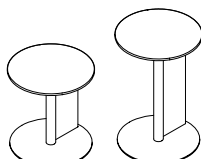

Auxiliary Table

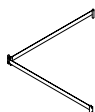

Strap Kit



Ganging Kit

Collaborative Ottoman

Pages 511



Small Round Teknion dna Lounge Height Ottoman



Medium Round Teknion dna Height Ottoman



Small Square Lounge Height Ottoman

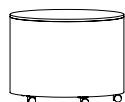

Medium Square Lounge Height Ottoman



Small Square Teknion dna Height Ottoman



Small Square Lounge Height Ottoman

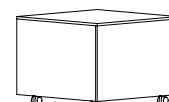

Medium Square Lounge Height Ottoman

soft seating (continued)

Teknion dna

Pages 530

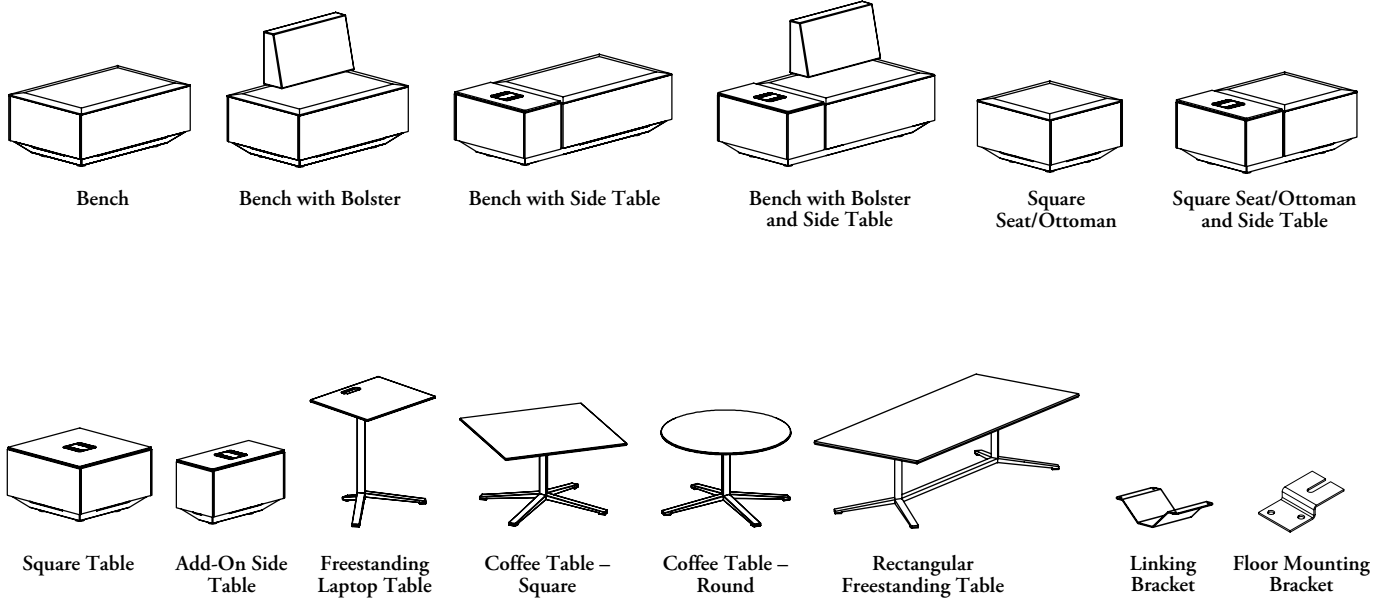

Ferrara

Page 539

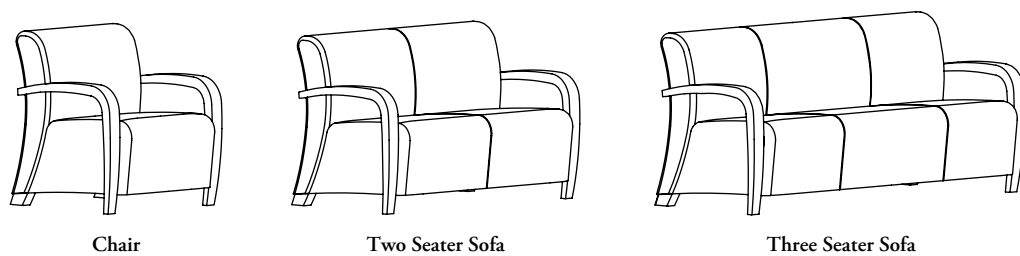

Tux

Page 541

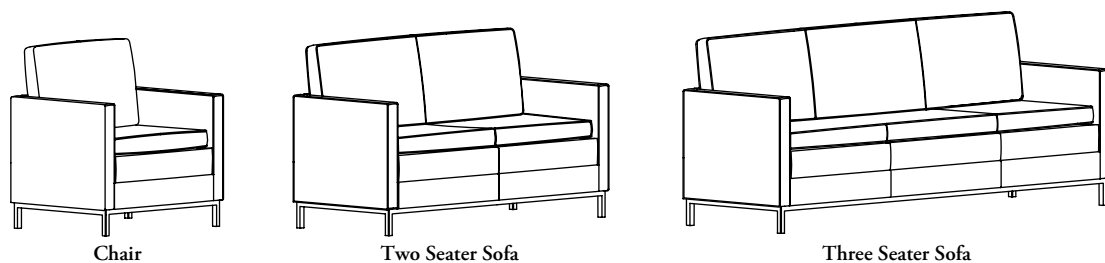

soft seating (continued)

Vasari

Pages 543

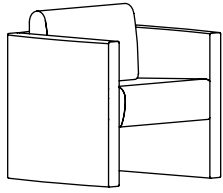

Chair

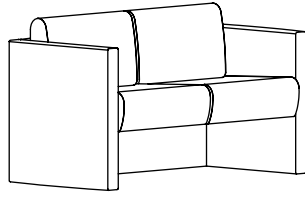

Two Seater Sofa

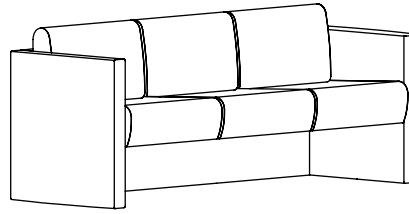

Three Seater Sofa



Tray

Vignette

Pages 547

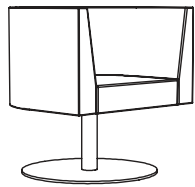

Swivel Lounge Chair

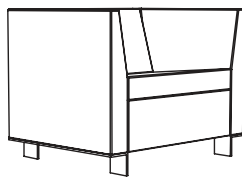

Cube Lounge Chair

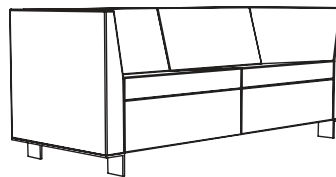

Two Seater Sofa

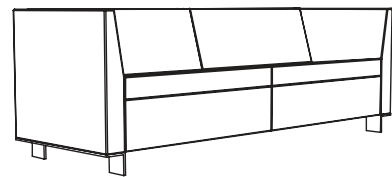

Three Seater Sofa

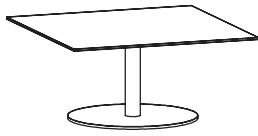

Coffee Table – Square

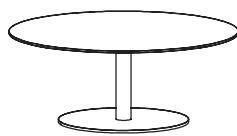

Coffee Table – Round

index

Section Contents	Product Code	Page No.
Introduction		
Where to find the information you need		3
Seating Product Map		8
Ergonomic Considerations		28
How to Choose a Chair		30
Work Chairs		
Work Chairs Product Map		38
Amicus		
Overview		44
Dimensions & Material Requirements		46
Adjustment Features & Instructions		48
Amicus – Synchro-Tilt Task Chair	N A C X	50
Amicus – Guest Chair	N A M G	52
Around		
Overview		54
Dimensions & Material Requirements		56
Adjustment Features & Instructions		58
Around – Synchro-Tilt Task Chair, Mesh Back	N A R M	60
Around – Synchro-Tilt Task Chair, Mesh Back	N A R N	62
Around – Synchro-Tilt Task Chair, Upholstered Back	N A R T	64
Around – Synchro-Tilt Task Chair, Upholstered Back	N A R U	66
Around – Swivel Stool, Mesh Back	N A R H	68
Around – Swivel Stool, Upholstered Back	N A R K	69
AT Chair		
Overview		70
Dimensions & Material Requirements		71
Adjustment Features & Instructions		72
Planning with AT Chair		73
AT Chair	N W A M	74
Essa Chair		
Overview		76
Dimensions & Material Requirements		78
Planning with Essa Chair		79
Adjustment Features & Instructions		80
Essa Chair, Upholstered Back with Plastic Shell, Dual Upholstery	N E S P	82
Essa Chair, Upholstered Back	N E S U	83
Marini		
Overview		84
Dimensions & Material Requirements		85
Adjustment Features & Instructions		86
Marini – Synchro-Tilt Task Chair	N M A X	87
Nuova Contessa		
Overview		88
Dimensions & Material Requirements		90
Adjustment Features & Instructions		92
Nuova Contessa – Synchro-Tilt Task Chair	N C S A	95
Nuova Contessa – Synchro-Tilt Task Chair	N C S M	96
Nuova Contessa – Accessories	N C A A	98

Section Contents	Product Code	Page No.
Metric Chair		
Overview		100
Dimensions & Material Requirements		101
Adjustment Features & Instructions		102
Metric Chair	N M E U	104
Metric Chair, Mixed (Outside Inside) Upholstered	N M E M	105
Projek		
Overview		106
Dimensions & Material Requirements		107
Adjustment Features & Instructions		108
Projek – Synchro-Tilt Task Chair	N P R T	110
Projek – Swivel Stool	N P R D	111
Sabrina		
Overview		112
Dimensions & Material Requirements		116
Adjustment Features & Instructions		118
Sabrina – Synchro-Tilt Task Chair	N S B Y	120
Sabrina – Swivel Stool	N S B D	122
Savera		
Overview		124
Dimensions & Material Requirements		128
Adjustment Features & Instructions		129
Savera – Synchro-Tilt Task Chair	N S A Y	136
Savera XL – Synchro-Tilt Task Chair	N S A X	138
Savera – Multi-Tilt Task Chair	N S A M	139
Savera – Swivel-Tilt General Use Chair	N S A W	140
Savera – Swivel Stool	N S A D	141
t-3		
Overview		142
Dimensions & Material Requirements		144
Adjustment Features & Instructions		146
t-3 – Task Chair	N X X Y	148
t-3 – Swivel Stool	N X X F	149
Tone		
Tone Synchro-Tilt Task Chair & Stool Overview		150
Tone Luum Sleeve, Tone Chair & Stool Overview		152
Tone Knit Sleeve, Tone Chair & Stool Overview		154
Tone Knit Sleeve Overview		157
Tone Knit Sleeve Overview		157
Planning with Tone Chair & Stool		162
Tone Adjustment Features & Instructions		160
Tone Task Chair, Mesh Back	N T T M	164
Tone Swivel Stool, Mesh Back	N T D M	165
Tone Task Chair, Mesh Back & Luum Sleeve	N T T F	166
Tone Swivel Stool, Mesh Back & Luum Sleeve	N T D F	168
Tone Task Chair, Mesh Back & Knit Sleeve	N T T K	170
Tone Swivel Stool, Mesh Back & Knit Sleeve	N T D K	172
Tone Luum Sleeve	N T A F	173
Tone Knit Sleeve	N T A K	174

index (continued)

Section Contents	Product Code	Page No.
Visio		
Overview		176
Dimensions & Material Requirements		177
Adjustment Features & Instructions		178
Visio Chair, Mesh Back	NTEU	179
Multi-Use Chairs		
Multi-Use Chairs Product Map		181
Ability Spinner Stool		
Overview, Dimensions & Material Requirements		189
Ability – Spinner Stool	NACSP	190
Around Guest Chair		
Overview		192
Dimensions & Material Requirements		194
Around Guest Chair, Mesh Chair	NARJ	196
Around Guest Chair, Upholstered Back	NARY	197
Around Conference Chair		
Overview		198
Dimensions & Material Requirements		200
Adjustment Features & Instructions		201
Around Conference Chair, Mesh Back	NARC	202
Around Conference Chair, Upholstered Back	NARP	203
Just-Us		
Overview		204
Dimensions & Material Requirements		205
Planning with Just-Us Chair		207
Just-Us Chair, Upholstered Seat	NJUJ	208
Kupp		
Overview		210
Dimensions & Material Requirements		212
Planning with Kupp Chair		214
Kupp Chair, Plastic Seat	NKUP	216
Kupp Chair, Upholstered Seat	NKUY	217
Kupp Chair, No Arms, Plastic Seat	NKUX	218
Kupp Chair, No Arms, Upholstered Seat	NKUZ	219
Occo		
Overview		220
Dimensions & Material Requirements		222
Planning with Occo Chair		224
Occo Chair - 4 Legs	NWOG	226
Occo Chair - 5-Star Base	NWOW	227
Sitara		
Overview		228
Dimensions & Material Requirements		229
Sitara – Guest Chair	NSIG	230

Section Contents	Product Code	Page No.
Sprout		
Understanding Sprout Stool and Tables		232
Sprout Stool Overview		233
Sprout Dimensions & Material Requirements		234
Planning with Sprout Stools		235
Sprout Table Overview		237
Sprout Table Dimensions & Material Requirements		239
Planning with Sprout tables		242
Sprout Stool	NSPS	244
Sprout Soft Round Table	NSPR	245
Sprout Soft-Square Table	NSPT	246
Synapse		
Overview		248
Dimensions		249
Synapse Wood Guest Chair	NSYN	250
Synapse Fully Upholstered Wood Guest Chair	NSYF	251
Taiga		
Overview		252
Dimensions & Material Requirements		253
Taiga Wood Guest Chair	NTAGK	254
Variable		
Variable Swivel Multi-Use Work Chair Overview		264
Variable Swivel Multi-Use Work Chair Dimensions & Material Requirements		266
Variable Swivel Multi-Use Work Chair Adjustment Features		268
Variable Swivel Multi-Use Work Chair	NVRW	270
Variable Swivel Multi-Use Stool	NVRD	272
Variable Conference Chair Overview		274
Planning with Variable Multipurpose Chair Family		256
Educational Applications		257
Corporate, Commercial & Institutional Applications		261
Corporate Training		263
Variable Conference Chair Dimensions & Material Requirements		277
Variable Conference Chair	NVRC	282
Variable HybrED Chair with Storage Tray Base	NVRE	284
Variable HybrED Height-Adjustable Chair	NVRH	286
Stacking Chairs		
Stacking Chairs Product Map		290
Nami		
Overview		292
Dimensions		293
Nami – Plastic Stacking Guest Chair	NNAC	296
Nami – Plastic Guest Counter Stool	NNAS	297
Nami – Plastic Guest Bar Stool	NNAH	298
Nami – 3D Wood – Stacking Guest Chair	NNWC	299
Nami – 3D Wood – Guest Counter Stool	NNWS	300
Nami – 3D Wood – Guest Bar Stool	NNWH	301
Nami Accessories	NNA	302

index (continued)

Section Contents	Product Code	Page No.
Variable		
Overview		304
Dimensions & Material Requirements		305
Variable Stacking Guest Chair	NVRG	308
Variable Stacking Stool	NVRS	312
Variable – Bookrack	NVRAB	314
Variable – Ganging Device	NVRAG	315
Variable – Tablet	NVRAT	316
Variable – Dolly	NVRAW	317
Volume		
Overview dimensions & material requirements		318
Volume Stack Chair	NHDS	320
Volume Accessories	NHD	321
Zone		
Overview		322
Dimensions		323
Zone Guest Chair	NZOC	324
Zone Accessories	NZO	325
Soft Seating		
Soft Seating Product Map		332
Aegis		
Dimensions & Material Requirements		339
Aegis Lounge Bench	NAE	340
Aegis Lounge Chair	NAE	341
Banqs		
What is Banqs		343
Banqs Single-Sided Solo focus, Standard Overview		358
Banqs Single-Sided Solo focus, Standard Dimensions & Material Requirements		359
Banqs Single-Sided Solo Focus, Wide Overview		360
Banqs Single-Sided Solo Focus, Wide Dimensions & Material Requirements		361
Banqs Single-Sided Solo Focus	NBS / NBM	362
Banqs Corner Alcove Solo Focus, Standard Overview		368
Banqs Corner Alcove Solo Focus, Standard Dimensions & Material Requirements		369
Banqs Corner Alcove Solo Focus, Wide Overview		370
Banqs Corner Alcove Solo Focus, Wide Dimensions & Material Requirements		371
Banqs Left Corner Alcove Solo Focus	NBL / NBN	372
Banqs Right Corner Alcove Solo Focus	NBR / NBO	378
Banqs Full Alcove Solo Focus, Standard Overview		384
Banqs Full Alcove Solo Focus, Standard Dimensions & Material Requirements		385
Banqs Full Alcove Solo Focus, Wide Overview		386
Banqs Full Alcove Solo Focus, Wide Dimensions & Material Requirements		387
Banqs Full Alcove Solo Focus	NBF / NBP	388
Banqs Rectangular Bench, No Back Overview		394
Banqs Rectangular Bench, No Back Dimensions & Material Requirements		395
Banqs Rectangular Bench, No Back	NBAR / NBWR	396

Section Contents	Product Code	Page No.
Banqs Single-Sided Sofa Overview		398
Banqs Single-Sided Sofa Dimensions & Material Requirements		399
Banqs Single-Sided Sofa	NBAS / NBWS	400
Banqs Back-to-Back Sofa Overview		404
Banqs back-to-back Sofa Dimensions & Material Requirements		405
Banqs Back-to-Back Sofas	NBAB / NBWB	406
Banqs Corner Alcove Sofa Overview		410
Banqs corner alcove sofa Dimensions & Material Requirements		411
Banqs Corner Alcove Sofa	NBAC / NBWC	412
Banqs Full Alcove Sofa overview		416
Banqs Full Alcove Sofa Dimensions & Material Requirements		417
Banqs Full Alcove Sofa	NBAF / NBWF	418
Banqs Fabric Pattern and Seam Guidelines		422
Banqs High Spanning Screen Overview		424
Planning with Banqs High Spanning Screen		425
Banqs High Spanning Screen Dimensions & Material Requirements		426
Banqs High Spanning Screen	NBAZ	427
Banqs Digital Share Wall Mount Integration Kit Overview		428
Banqs Digital Share Wall Mount Integration Kit Dimensions & Material Requirements		429
Banqs Digital Share Wall Mount Integration Kit	NBAY	430
Banqs Wire Management Kit for Table with Power Pill at Architectural Wall	NBAX	431
Banqs Table With Flat Base Overview		432
Planning with Banqs Tables		433
Banqs Tables Edge Trim Style Overview		436
Banqs Table with Flat Base Dimensions & Material Requirements		438
Banqs Table with Flat Base	NBAT	440
Banqs Table with Four-Prong Base Overview		442
Banqs Table with Four-Prong Base	NBAU	443
Understanding Banqs Freestanding Tables		444
Banqs Freestanding Occasional Table Overview		445
Banqs Freestanding Occasional Table Dimensions & Material Requirements		446
Banqs Freestanding Occasional Table	NBAH / NBWH	447
Banqs Freestanding Occasional Table with Screens Overview		448
Banqs freestanding Occasional Table with Screens Dimensions & Material Requirements		449
Banqs Freestanding Occasional Table with Screens	NBAL / NBWL	450
Banqs Accessories Overview		453
Banqs Untethered Cushion	NBAP	454
Repositionable Coat Hook	NBAM	455
Banqs Ganging Plate	NBAG	456
Banqs Ganging Kit	NBAEP	457
Banqs Sofa Undermount Power	NBAA	458
Banqs Small Power Flip	NBAJ	459
Belize		
Dimensions & Material Requirements		461
Belize Lounge	NBEC	462

index (continued)

Section Contents	Product Code	Page No.
Bonds		
What Is Bonds		464
Bonds Product Offering		465
Planning with Bonds		467
Bonds Freestanding Seating Dimensions & Material Requirements		482
Planning with Bonds Freestanding Seating		483
Freestanding Single Block	NB0SF	484
Freestanding Double Block	NB0SD	485
Bonds Building Block Seating Overview		486
Bonds Building Block Seating Dimensions & Material Requirements		488
Building Block Seat - Not Strap Compatible	NB0SN	490
Building Block Seat - Strap Compatible	NB0SS	491
Ganging Kit	NB0SG	492
Strap Kit	NB0SK	493
Bonds Building Block Square Table Overview		494
Bonds Building Block Square Table Dimensions & Material Requirements		495
Bonds Building Block Rectangular Table overview		496
Bonds Building Block Rectangular Table Dimensions & Material Requirements		497
Bonds Building Block Triangular Table Overview		498
Bonds Building Block Triangular Table Dimensions & Material Requirements		499
Planning with Bonds Building Block Tables		500
Bonds Auxiliary Table Overview		505
Bonds Auxiliary Table Dimensions & Material Requirements		506
Planning with Bonds Auxiliary Table		507
Building Block Table - Square	NB0TS	502
Building Block Table - Rectangular	NB0TR	503
Building Block Table - Triangular	NB0TT	504
Auxiliary Table	NB0A	508
Collaborative Ottoman		
Collaborative Ottoman Overview		510
Round Collaborative Ottoman	NCOR	511
Square Collaborative Ottoman	NCOS	512
Teknion DNA		
Teknion DNA Overview		514
Idea Starters Overview		515
Teknion DNA Planning Possibilities		516
Teknion DNA Seating Basics		517
Teknion DNA Table Basics		518
Planning with DNA Benches & Tables		519
Understanding Power and Communications		522
Teknion DNA Recessed Data/Electrical Module Details		523
Teknion DNA finishes		524
Teknion DNA Dimensions & Material Requirements		525
DNA – Modular Seating Bench	NDN	530
DNA – Modular Seating Square Seat	NDNC	531
DNA – Modular Square Table	NDNS	532
DNA – Modular Side Table	NDNM	533
DNA – Linking Bracket	NDNJ	534
DNA – Floor Mounting Bracket	NDNF	534
DNA – Freestanding Laptop Table	NDNL	535

Section Contents	Product Code	Page No.
DNA – Freestanding Coffee Table	NDNT	536
DNA – Rectangular Freestanding Coffee Table	NDNU	537
Ferrara		
Dimensions & Material Requirements		538
Ferrara Lounge	L FER	539
Tux		
Dimensions & Material Requirements		540
Tux Lounge	LTUX	541
Vasari		
Dimensions & Material Requirements		542
Vasari Chair	NVAC	543
Vasari Sofa	NVA	544
Vasari Tray	NVAT	545
Vignette		
Dimensions & Material Requirements		546
Vignette – Seating	NVBS	547
Vignette – Coffee Table	NVBT	548

ergonomic considerations



problems:

improperly chosen seating causes the following:

- Over bending – causes lower back pain and fatigue, compresses internal organs. To resolve this problem see solution A) and B) below.
- Folding of Knees – causes pain and compression in thighs. To resolve this problem see solution B) below.
- Extension of Arms – causes neck and shoulder pain and headaches. To resolve this problem see solution C) below.
- Stooping of Head – causes stiffness and pain in neck and shoulders. To resolve this problem see solutions D) and E) below.

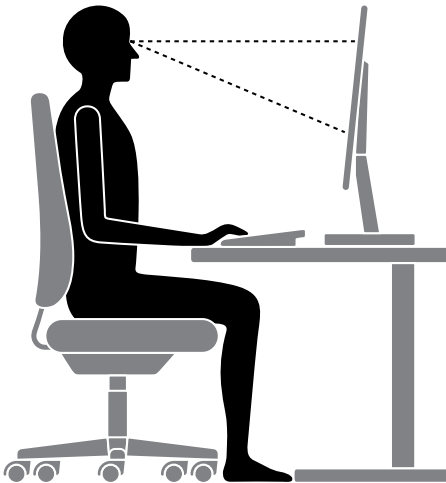

solutions:

proper task seating allows for the following:

- A) Dynamic posture – torso permitted to move freely – reduces fatigue.
- B) Open Angle – legs at least 90° from torso – avoids back strain and compression of organs; calves at least 90° from thighs – avoids compression in thighs.
- C) Arms at Side – shoulders relaxed, arms not more than 15° out from body, hands extended just above desk or keyboard (with or without chair arms) – avoid neck and shoulder strain.
- D) Head Erect – avoids neck and shoulder strain.
- E) Position of source materials and Equipment: Height, Angle and Distance to account for:
 - Axis of Vision – the maximum angle within which task objects can be seen without bending the neck
 - Focal Distance – the distance required to see task objects
 - Reach – the minimum distance required to reach task objects without altering the position of the upper body

ergonomic considerations (continued)

sitting is one of the hardest tasks for the human spine:

- Lying, reclining or standing allow better alignment and better flow of spinal fluid with less load on spinal joints than sitting, especially sitting improperly
- It is extremely important to choose a suitable chair for the task and to adjust it properly for fit and use

sitting properly:

- Occupy the entire seat area in order to take full advantage of the shape and curves of the seat and back
- Adjust the seat and back so that the lumbar support area falls at the proper height, usually 6" to 10" above the seat
- Choose a seat height that allows head to stay erect or inclined slightly toward task and allows the arms and knees to rest at 90° or more with feet flat on the floor
- Adjust the arms of the chair so that shoulders are relaxed with hands extended above the keyboard
- Move often, both in the seat and around the work area
- Adjust your chair frequently according to current task

teknion seating

- In order to satisfy these requirements, Teknion Seating develops products to comply with ANSI/BIFMA requirements and offers a full range of sizes and mechanisms. For more information, see Seating Applications on the following pages

how to choose a chair: seating applications

Chair Type	Application	Typical Use Situation
dedicated task	Used for situations in which the individual performs long-term and/or repetitive operations, usually intensive keyboarding. May also be multi-user.	<ul style="list-style-type: none"> • Data-processing • Switchboard/call center • Computer programmer
multi-task	Used in situations where the individual sits long-term, doing a number of functions on multiple surfaces, with moderate duration of task effort throughout the day, including keyboarding, reading, filing, meeting etc.	<ul style="list-style-type: none"> • Manager, executive • Administrative • Professional
general use	Used for short-term task seating such as light keyboarding or in a conference setting.	<ul style="list-style-type: none"> • Sales office • Meeting room
executive	Individual performs a number of functions, focused on decision making, requiring comfort during extended meetings, with some reading, writing or keyboarding.	<ul style="list-style-type: none"> • Executive, manager • Executive meeting room
meeting/conference	<ul style="list-style-type: none"> • Often short or medium term use for meeting, writing and reading. 	<ul style="list-style-type: none"> • Casual or format meeting room
guest chair	Used for temporary seating.	<ul style="list-style-type: none"> • Complement to task seating in an office area or workstation • Cafeterias • Training rooms, auditoriums
stool	<ul style="list-style-type: none"> • Used for tasks performed on higher worksurfaces • Solutions for Height-Adjustable Tables, Counter Height (36" high worksurfaces) and Bar Height (42" height worksurfaces) 	<ul style="list-style-type: none"> • Lab functions • Tellers • Cafeteria and lounges • Designer, draftsman
lounge	<ul style="list-style-type: none"> • Soft seating for relaxed comfort • Suitable for reception areas or alternative officing 	<ul style="list-style-type: none"> • Waiting area • Collaborative space • Lobby, public area or guest seating in an office
stacking	<ul style="list-style-type: none"> • For spaces that require frequent seating configuration changes • May include options for desk height Counter Height for 36" high worksurfaces, and Bar Height for 42" high worksurfaces 	<ul style="list-style-type: none"> • Cafeterias • Classrooms and campus setting • Libraries • Meeting rooms • General public seating
bariatric	Used for situations in which the individual performs long-term and/or repetitive operations, usually intensive keyboarding. May also be multi-user.	<ul style="list-style-type: none"> • Call center • 24/7

how to choose a chair: seating applications (continued)





Chair Type	Features of Teknion Chairs in this Category	Chair Mechanisms or Configurations
dedicated task	<ul style="list-style-type: none"> Fully responsive mechanism with advanced movement Provides maximum adjustment for personalized support 	<ul style="list-style-type: none"> Synchro-Tilt Mechanism Lumbar or Back Height-Adjustment Height- and Width-Adjustable Arms Seat Depth Adjustment
multi-task	<ul style="list-style-type: none"> Responsive, self adjusting and dynamic With fully-adjustable arms, may also be suitable for dedicated task work Note: Dedicated Task Chairs may also be placed in multi-task or general use areas 	<ul style="list-style-type: none"> Synchro-Tilt Mechanism Knee-Tilt Mechanism Adjustable Arms Lumbar or Back Height-Adjustment
general use	<ul style="list-style-type: none"> Meets basic functional needs Note: Multi-Task and Dedicated Task Chairs may also be placed in general use areas 	<ul style="list-style-type: none"> Knee-Tilt Mechanism Swivel-Tilt Mechanism Swivel Mechanism
executive	<ul style="list-style-type: none"> Responsive, self-adjusting and dynamic Suited to the status of a management position 	<ul style="list-style-type: none"> Synchro-Tilt Mechanism Knee-Tilt Mechanism Swivel-Tilt Mechanism
meeting/conference	<ul style="list-style-type: none"> Full functionality not always required No-fuss solutions required 	<ul style="list-style-type: none"> Fixed Arms Various mechanisms swivel
guest chair	<ul style="list-style-type: none"> Comfortable configuration and construction Many task seating lines offer complementary guest seating 	<ul style="list-style-type: none"> Cantilever Sled Stacking Four-leg Stool
stool	<ul style="list-style-type: none"> Meets basic functional needs for short term use Includes footrest 	<ul style="list-style-type: none"> Swivel Mechanism drafting stool
lounge	<ul style="list-style-type: none"> Various sizes and options Accessories enhance suitability for alternative officing 	<ul style="list-style-type: none"> Single Chair Two Seater Three Seater
stacking	<ul style="list-style-type: none"> Low density Stacking High density applications (may include a storage dolly) Meets basic functional needs for short term use Lightweight, easy to move 	<ul style="list-style-type: none"> Stackable Four-Leg Sled base frames
bariatric	<ul style="list-style-type: none"> Built to fit larger and taller users Seat and back cushions proportioned for better comfort Heavy duty construction, stronger parts 	<ul style="list-style-type: none"> Standard and Generous Arm options Synchro-Tilt Mechanism Tension Control

how to choose a chair: family application matrix

- Dedicated and Multi-Task are both found in the Work Chairs section
- Height-Adjustable Swivel Stools are found in the Work Chairs section
- Bar and Counter Stools are found in the Multi-Use and Stacking Chairs section

	DEDICATED TASK	MULTI-TASK	GENERAL USE	EXECUTIVE	MEETING / CONFERENCE	GUEST	SWIVEL STOOL	LOUNGE	BAR STOOL	COUNTER STOOL	BARIATRIC	24-7	CAFETERIA	TRAINING ROOM / AUDITORIUM	STACKING / NESTING
AEGIS															
AMICUS															
AROUND															
AT															
BELIZE															
BONDS															
COLLABORATIVE OTTOMAN															
ESSA															
FERRARRA															
JUST-US															
KUPP															
MARINI															
METRIC															
NAMI															
NUOVA CONTESSA															
OCCO															
PROJEK															
SABRINA															
SAVERA															
SAVERA XL															
SITARA															
SPROUT STOOLS															
SYNAPSE															
T-3															
TAIGA															
TEKNION DNA															
TONE															
TUX															
VARIABLE															
VASARI															
VIGNETTE															
VISIO															
VOLUME															
ZONE															

how to choose a chair: family mechanism matrix

AMICUS	AROUND	AT	ESSA	JUST-US	MARINI	METRIC	NUOVA CONTESSA	PROJEK	SABRINA	SAVERA	SAVERA XL	SICLA	T-3	STONE	VARIABLE	VIGNETTE	VISIO	ADJUSTABILITY AND ACTION	MECHANISM DIAGRAM
																		<ul style="list-style-type: none"> weight balancing action back and seat adjustment together in a 3.5:1 ratio 3 position travel limiter with back lock in the upright position seat height-adjustment swivels 360° 	SYNCHRO-TILT with weight balancing 
																		<ul style="list-style-type: none"> back and seat adjust together, in a 3:1 or 2:1 ratio chair tilt is lockable in a variety of positions seat height-adjustment swivels 360° 	SYNCHRO-TILT 
																		<ul style="list-style-type: none"> back and seat adjust independently seat height-adjustment swivels 360° 	MULTI-TILT 
																		<ul style="list-style-type: none"> back and seat adjust together, in a fixed 1:1 ratio with pivot point at cylinder seat height-adjustment swivels 360° 	SWIVEL-TILT 
																		<ul style="list-style-type: none"> seat height-adjustment swivels 360° (on stool versions) 	SWIVEL 

	CYLINDER HEIGHT RANGE	CYLINDER STYLE
	3"	Low
	4"	Standard
	4-1/2"	
	5"	High

work chairs

work chairs

PRODUCT MAP / TABLE OF CONTENTS	38
AMICUS OVERVIEW	44
AMICUS DIMENSIONS & MATERIAL REQUIREMENTS	46
AMICUS ADJUSTMENT FEATURES	48
AMICUS PRODUCT LISTING	50
AROUND OVERVIEW	54
AROUND DIMENSIONS & MATERIAL REQUIREMENTS	56
AROUND ADJUSTMENT FEATURES	58
AROUND PRODUCT LISTING	60
AT CHAIR OVERVIEW	70
AT CHAIR DIMENSIONS & MATERIAL REQUIREMENTS	71
AT CHAIR ADJUSTMENT FEATURES	72
PLANNING WITH AT CHAIR	73
AT CHAIR PRODUCT LISTING	74
ESSA CHAIR OVERVIEW	76
ESSA CHAIR DIMENSIONS & MATERIAL REQUIREMENTS	78
PLANNING WITH ESSA CHAIR	79
ESSA CHAIR ADJUSTMENT FEATURES	80
ESSA CHAIR PRODUCT LISTING	82
MARINI OVERVIEW	84
MARINI DIMENSIONS & MATERIAL REQUIREMENTS	85
MARINI ADJUSTMENT FEATURES	86
MARINI PRODUCT LISTING	87
NUOVA CONTESSA OVERVIEW	88
NUOVA CONTESSA DIMENSIONS & MATERIAL REQUIREMENTS	90
NUOVA CONTESSA ADJUSTMENT FEATURES	92
NUOVA CONTESSA PRODUCT LISTING	95
METRIC CHAIR OVERVIEW	100
METRIC CHAIR DIMENSIONS & MATERIAL REQUIREMENTS	101
METRIC CHAIR ADJUSTMENT FEATURES	102
METRIC CHAIR PRODUCT LISTING	104
PROJEK OVERVIEW	106
PROJEK DIMENSIONS & MATERIAL REQUIREMENTS	107
PROJEK ADJUSTMENT FEATURES	108
PROJEK PRODUCT LISTING	110

CONTINUED ON THE FOLLOWING PAGE

work chairs (continued)

SABRINA OVERVIEW	112
SABRINA DIMENSIONS & MATERIAL REQUIREMENTS	116
SABRINA ADJUSTMENT FEATURES	118
SABRINA PRODUCT LISTING	120
SAVERA OVERVIEW	124
SAVERA DIMENSIONS & MATERIAL REQUIREMENTS	128
SAVERA ADJUSTMENT FEATURES	129
SAVERA PRODUCT LISTING	136
T-3 OVERVIEW.	142
T-3 DIMENSIONS & MATERIAL REQUIREMENTS	144
T-3 ADJUSTMENT FEATURES.	146
T-3 PRODUCT LISTING	148
TONE SYNCHRO-TILT TASK CHAIR & STOOL OVERVIEW	150
TONE LUUM SLEEVE, TONE CHAIR & STOOL OVERVIEW	152
TONE KNIT SLEEVE, TONE CHAIR & STOOL OVERVIEW	154
TONE LUUM SLEEVE OVERVIEW	156
TONE KNIT SLEEVE OVERVIEW	157
TONE DIMENSIONS & MATERIAL REQUIREMENTS	158
TONE ADJUSTMENT FEATURES.	160
PLANNING WITH TONE CHAIR & STOOL.	162
TONE PRODUCT LISTING	164
VISIO CHAIR OVERVIEW	176
VISIO DIMENSIONS & MATERIAL REQUIREMENTS	177
VISIO ADJUSTMENT FEATURES.	178
VISIO PRODUCT LISTING	179

product map

Amicus

Pages 50

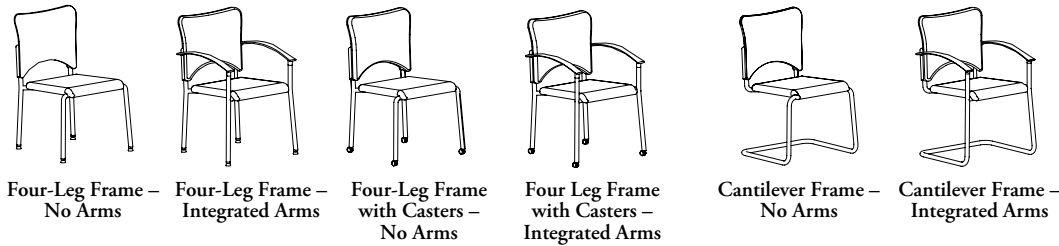
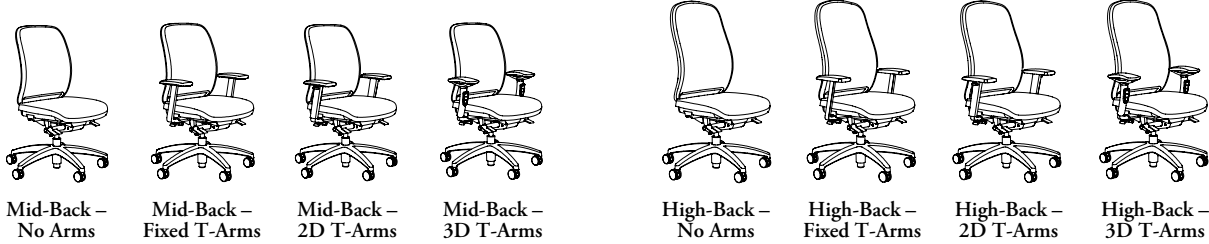

Around

Pages 60

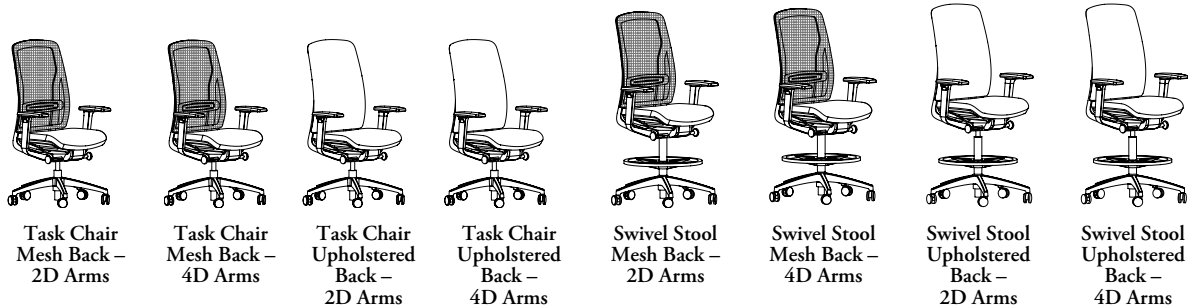

(also available as a Multi-Use Chair)

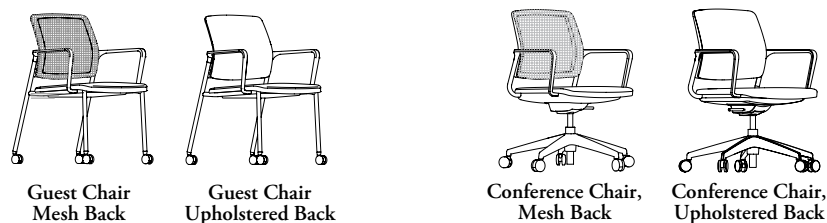

product map

AT Chair

Pages 74



Essa Chair

Pages 82

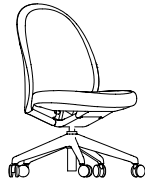

No Arms



Fixed Arms



Height-Adjustable
Arms



High-Back –
T-Arms

Marini

Pages 87

Nuova Contessa

Pages 95



All Mesh
No Headrest –
Fixed Arms



All Mesh
No Headrest –
4D Arms



Dual Upholstered
No Headrest –
Fixed Arms



Dual Upholstered
No Headrest –
4D Arms



With Headrest



With Coat Hanger

Metric Chair

Pages 104



Metric Chair,
Single Upholstered



Metric Chair,
Dual Upholstered



Metric Chair,
Mixed (Outside Inside)
Upholstered

product map

Projek

Pages 110



Task Chair
High Back –
No Arms



Task Chair
High Back –
Fixed T-Arms



Task Chair
High Back –
2D Arms



Task Chair
High Back –
4D Arms



Task Chair
With Headrest

(also available as a Multi-Use Chair)



Swivel Stool –
No Arms



Swivel Stool –
2D Arms



Swivel Stool –
4D Arms High



Swivel Stool –
With Headrest

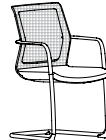

Guest Chair –
Cantilever



Conference
Chair

Sabrina

Pages 120



No Arms



Fixed Arms



Adjustable Arms

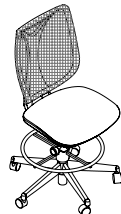

Swivel Stool –
No Arms

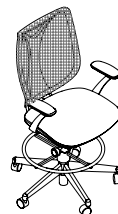

Swivel Stool –
Fixed Arms



Swivel Stool –
Adjustable Arms

back options

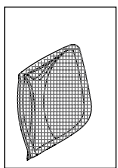

No Headrest –
No Coat
Hanger

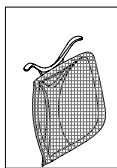

No Headrest –
With Coat
Hanger

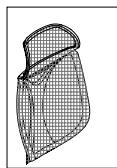

With Headrest –
No Coat
Hanger

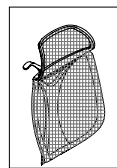

With Headrest –
With Coat
Hanger

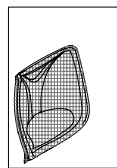

With Lumbar

product map

Savera & Savera XL

Pages 136



Mid-Back – No Arms

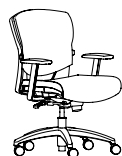

Mid-Back – Fixed T-Arms

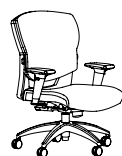

Mid-Back – 2D Arms



Mid-Back – 4D Arms

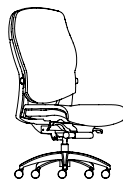

High-Back – No Arms



High-Back – Fixed T-Arms

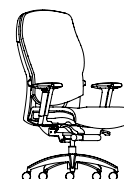

High-Back – 2D Arms



High-Back – 4D Arms

Savera Task is available with a Synchro-Tilt, Multi-Tilt and Swivel-Tilt Mechanism



Swivel Stool – No Arms

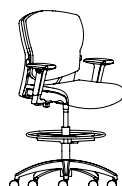

Swivel Stool – 2D Arms

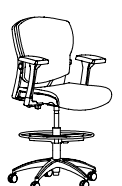

Swivel Stool – 4D Arms



Multi-Tilt



XL Mid-Back – No Arms



XL Mid-Back – Standard



XL Mid-Back – Generous

t-3

Pages 148



Mid-Back – No Arms



Mid-Back – Fixed T-Arms



Mid-Back – T-Arms



Swivel Stool – No Arms



Swivel Stool – T-Arms

back options

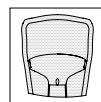

Mesh

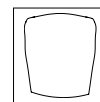

Upholstered

product map

Tone

Page 165



Task Chair,
Mesh Back –
Armless



Task Chair,
Mesh Back –
2D Arms



Task Chair,
Mesh Back –
4D Arms



Swivel Stool,
Mesh Back –
Armless



Swivel Stool,
Mesh Back –
2D Arms



Swivel Stool,
Mesh Back –
4D Arms



Task Chair,
Mesh Back &
Luum Sleeve –
Armless



Task Chair,
Mesh Back &
Luum Sleeve –
2D Arms



Task Chair,
Mesh Back &
Luum Sleeve –
4D Arms

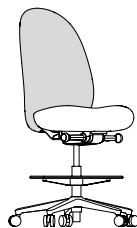

Swivel Stool,
Mesh Back &
Luum Sleeve –
Armless



Swivel Stool,
Mesh Back &
Luum Sleeve –
2D Arms



Swivel Stool,
Mesh Back &
Luum Sleeve –
4D Arms



Task Chair,
Mesh Back &
Knit Sleeve –
Armless



Task Chair,
Mesh Back &
Knit Sleeve –
2D Arms



Task Chair,
Mesh Back &
Knit Sleeve –
4D Arms

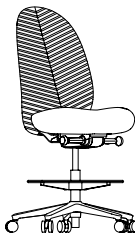

Swivel Stool,
Mesh Back &
Knit Sleeve –
Armless



Swivel Stool,
Mesh Back &
Knit Sleeve –
2D Arms



Swivel Stool,
Mesh Back &
Knit Sleeve –
4D Arms

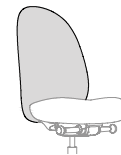

Luum Sleeve



Knit Sleeve

Visio

Pages 179



Mesh Back

amicus overview

Amicus is a fully integrated family of ergonomic seating designed to function for any task or office setting.

It is highly adjustable and offers multiple enhanced ergonomic features based on how people sit and move over the course of a day.

The line includes task seating which offers users heightened performance, an general use chair for short term applications and a guest chair with three leg styles.

Amicus – Synchro-Tilt Task Chair (NACX)



statement of line

single upholstery



Mid-Back – No Arms (NACXFN) Mid-Back – Fixed T-Arms (NACXFF) Mid-Back – 2D T-Arms (NACXFW) Mid-Back – 3D T-Arms (NACXFP) High-Back – No Arms (NACXHN) High-Back – Fixed T-Arms (NACXHF) High-Back – 2D T-Arms (NACXHW) High-Back – 3D T-Arms (NACXHP)

dual upholstery



Mid-Back – No Arms (NACXFN) Mid-Back – Fixed T-Arms (NACXFF) Mid-Back – 2D T-Arms (NACXFW) Mid-Back – 3D T-Arms (NACXFP) High-Back – No Arms (NACXHN) High-Back – Fixed T-Arms (NACXHF) High-Back – 2D T-Arms (NACXHW) High-Back – 3D T-Arms (NACXHP)

amicus overview (continued)

Amicus – Cantilever Frame (NAMG)



statement of line

plastic back



4-Leg Frame –
No Arms
(NAMGDFNZ)



4-Leg Frame –
Integrated Arms
(NAMGDFKZ)



4-Leg Frame with
Casters – No Arms
(NAMGDGNZ)



4-Leg Frame –
Integrated Arms
(NAMGDGKZ)



Cantilever Frame –
No Arms
(NAMGDCNZ)



Cantilever Frame –
No Arms
(NAMGDCKZ)

upholstered pad on plastic back



4-Leg Frame –
No Arms
(NAMGDFNU)



4-Leg Frame –
Integrated Arms
(NAMGDFKU)



4-Leg Frame with
Casters – No Arms
(NAMGDGNU)



4-Leg Frame –
Integrated Arms
(NAMGDGKU)



Cantilever Frame –
No Arms
(NAMGDCNU)



Cantilever Frame –
No Arms
(NAMGDCKU)

amicus dimensions & material requirements

features

- Designed and tested for users up to 300 lbs

weight

Task Mid Back	43 - 46 lbs
Task High Back	43 - 46 lbs

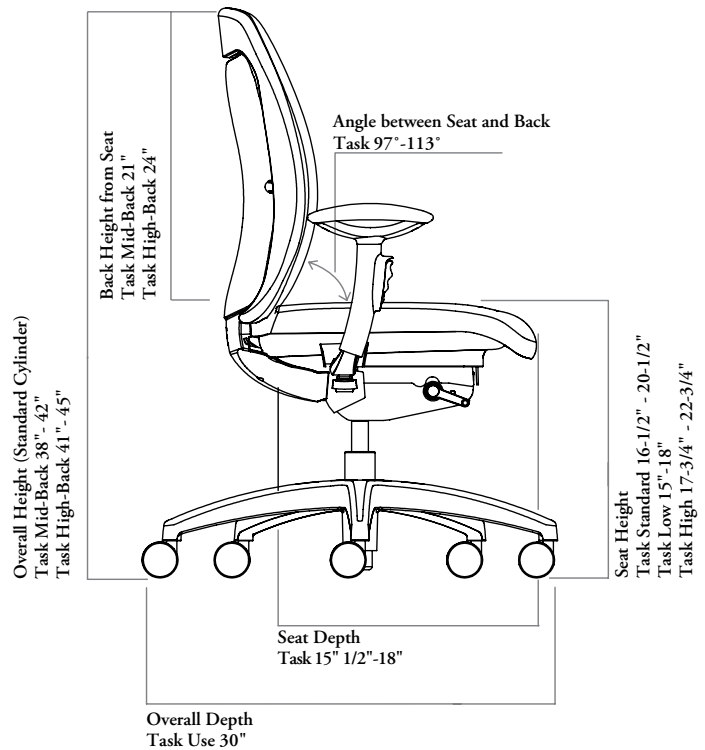
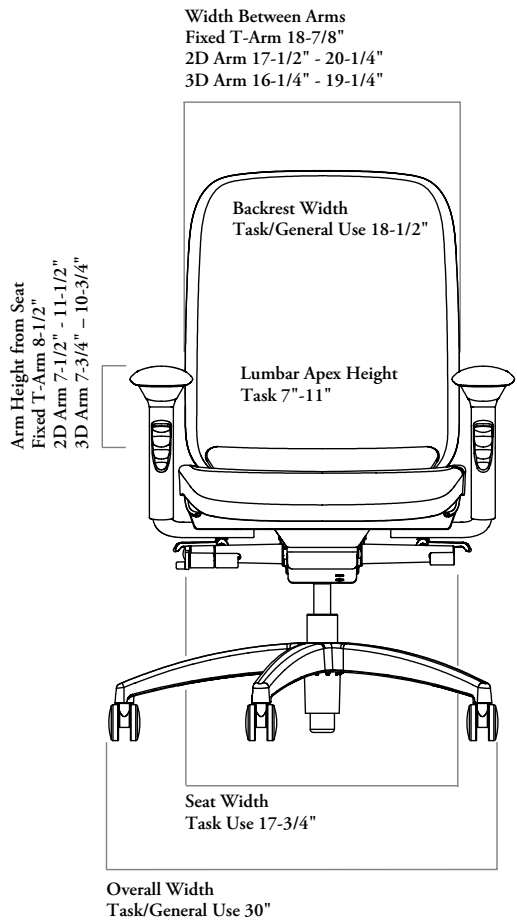

COM/COL material requirement

The pattern, repeat and directionality of fabric may increase the amount of yardage required.

Leather quantities should always be rounded up to the next hide size, as yields vary from 60-80% and are affected by the quality, size and shape of the hide, and by the location and quantity of blemishes.

	SINGLE UPHOLSTERED		DUAL UPHOLSTERED – SEAT		DUAL UPHOLSTERED – BACK	
	COM [yards]	COL [sq. ft]	COM [yards]	COL [sq. ft]	COM [yards]	COL [sq. ft]
Mid-Back	1.5	15	1	8.5	1	10
High-Back	1.75	20	1	8.5	1.25	12

amicus dimensions & material requirements (continued)

weight

Guest Cantilever	20 lbs
Guest Four-Leg	20 lbs

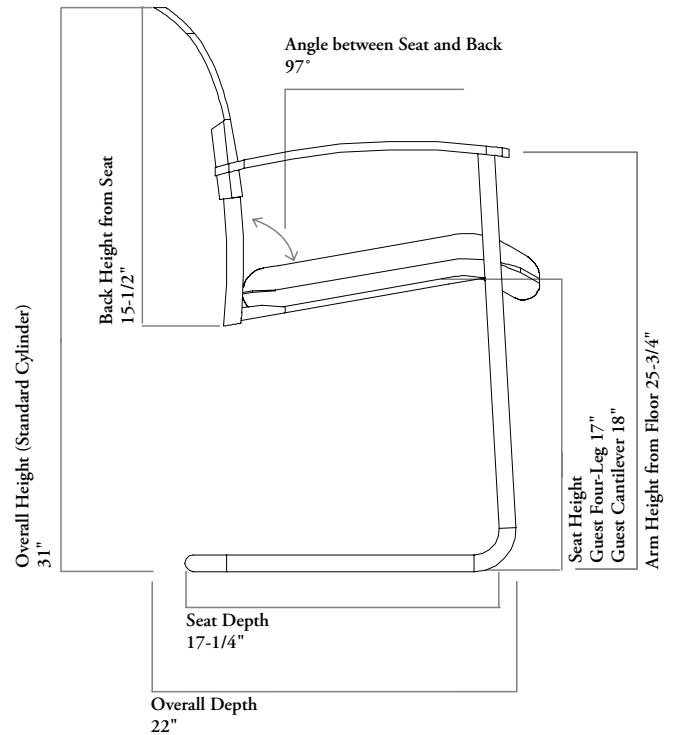
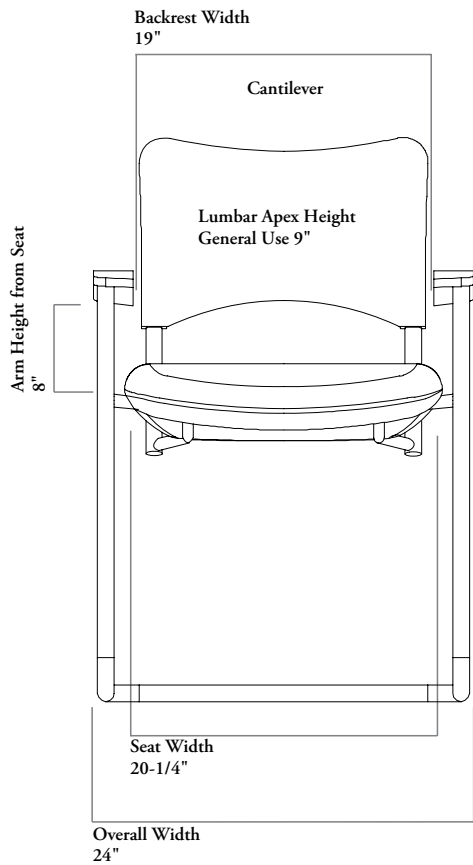

COM/COL Material Requirement

The pattern, repeat and directionality of fabric may increase the amount of yardage required.

Leather quantities should always be rounded up to the next hide size, as yields vary from 60-80% and are affected by the quality, size and shape of the hide, and by the location and quantity of blemishes.

	SINGLE UPHOLSTERED		DUAL UPHOLSTERED – SEAT		DUAL UPHOLSTERED – BACK	
	COM [yards]	COL [sq. ft]	COM [yards]	COL [sq. ft]	COM [yards]	COL [sq. ft]
Guest Chairs Seat only	1	8.5	n/a	n/a	n/a	n/a
Guest Chairs Seat and Back	1	10.5	n/a	n/a	n/a	n/a

amicus adjustment features & instructions

seat height-adjustment (upholstered)

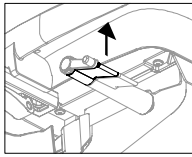

To raise the chair, lift the lever up while lifting your weight from the seat until you reach the desired level, then release to lock in place. To lower the chair, lift the lever up and allow your weight to push the seat down until you reach the desired level, then release to lock in place.

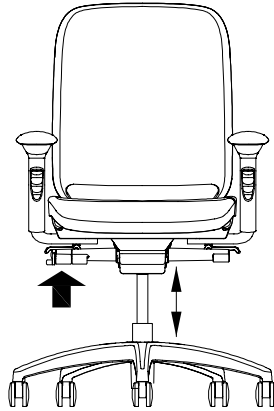

seat depth-adjustment

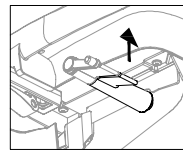

To adjust the seat depth, push the lever down and simultaneously lift your weight from the seat while sliding the seat forward or backward. Release the lever to lock the seat in place. Not available on Amicus General Use Chairs.

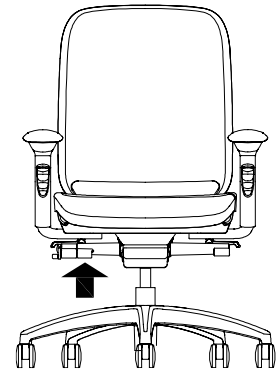

lumbar height-adjustment

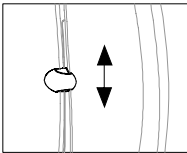

To adjust the lumbar height, grasp both levers and slide them up or down to the desired position. Not available on Amicus General Use Chairs.

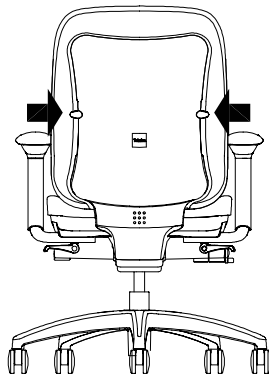

back tilt lock adjustment

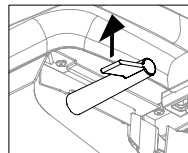

To adjust the angle of recline, pull the lever up to unlock the back and leave the chair in free flow mode. Recline to the desired position and push the lever down to lock the back in place.

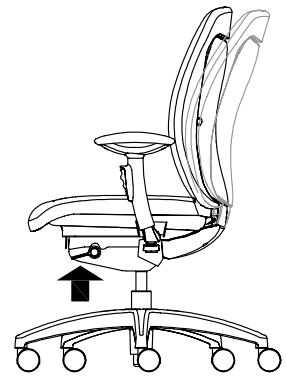

tilt tension adjustment

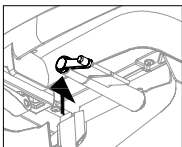

Leaning back, determine if the resistance of the chair is comfortable. For less resistance, pull tension adjustment lever out and turn it counterclockwise. For greater resistance, turn the lever clockwise.

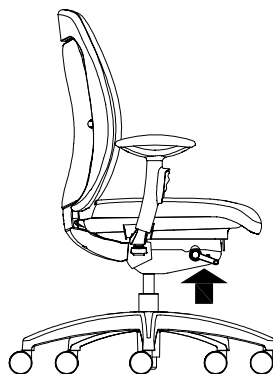

arm width adjustment

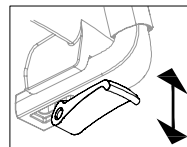

To adjust the width of each arm, push the lever down to release the arm lock. Slide the arm inward or outward to the desired position. Push the lever up to lock the arm in place.

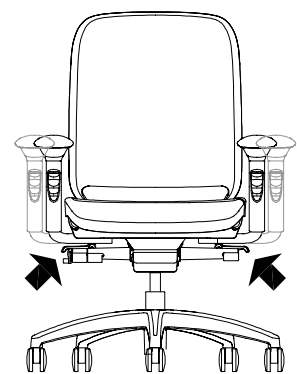

amicus adjustment features & instructions (continued)

2D arm height-adjustment

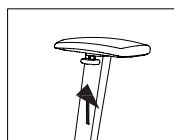

To adjust the arm height, lift the button under the arm cap to raise or lower it to the desired position. Release the button to lock in place.

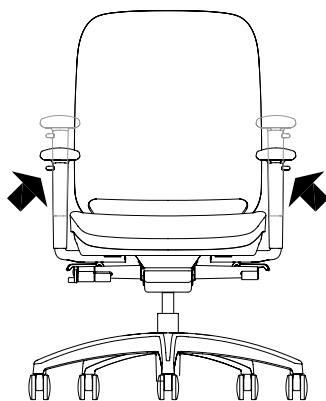

3D arm adjustment

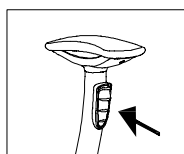

To adjust the arm height, press the top half of the button in and raise or lower it to the desired position. Release the button to lock in place.

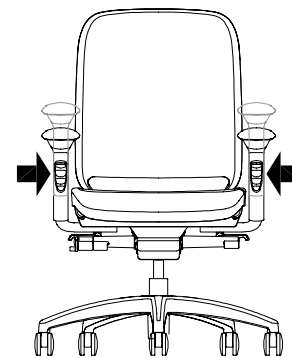

3D arm pivot adjustment

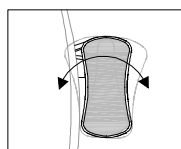

To pivot the arm cap, grasp and rotate inward or outward to the desired position.

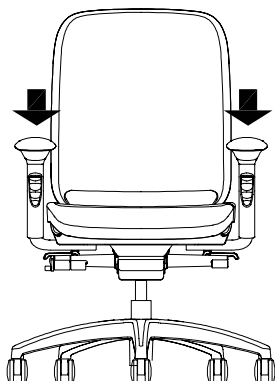

N A C X

Amicus – Synchro-Tilt Task Chair

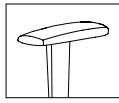
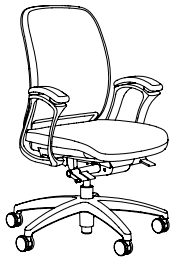

Fixed T-Arm

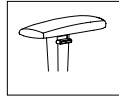

2D Arm



3D Arm

FEATURES

- Standard pneumatic cylinder provides height-adjustment of 4"
- Back tilt can be locked in five positions or left free flow
- Frame, outer back and 5-Star Base are plastic
- Synchro-tilt 2.7:1 ratio
- Tension control
- Seat depth adjustment of 2-1/2"
- Lumbar height-adjustment of 4"
- Hard casters are standard and are well suited for soft flooring such as carpeting
- Soft casters are available for use on hard flooring, such as wood, concrete, or tile

NOTES

Single Upholstered: The same fabric is applied to the seat and inside back.

Dual Upholstered: Two different fabrics are applied to the chair, one fabric to the seat and the other fabric to the inside back. First fabric listed will apply to the back and is the grade of fabric used to price the chair. A dual upholstery upcharge applies.

PRODUCT OPTIONS

Size	Mechanism Style	Arm Style	Upholstery Style	Back Upholstery Finish	Cylinder Style	Frame and Base Finish	Casters/Glides (Optional)
F Mid-Back	1 Standard Synchro-Tilt (with seat slider)	N No Arms	S Single Upholstered	Fabric	1 Standard 2 High 3 Low	E Ebony	A Casters, Soft B Glides, Hard C Glides, Soft
H High-Back		F Fixed T-Arms		D Dual Upholstered			
	W 2D Width and Height-Adjustable T-Arms		Seat Upholstery Finish				
		P 3D Width and Height-Adjustable T-Arms with Pivot		Fabric			
				Leather			

SAMPLE ORDER CODE

NACX H	1	N	S	M501	M502	1	E	
---------------	----------	----------	----------	-------------	-------------	----------	----------	--

DESCRIPTION

MID-BACK (F)

No Arms
Fixed T-Arms
2D Width and Height-Adjustable T-Arms
3D Width and Height-Adjustable T-Arms

PRICE

	COM/ Grade 2	COL/ Grade 3	Grade 4	Grade 5	Grade 6	Grade 7	Grade 8	Grade 9	Grade 10
1217	1276	1332	1390	1449	1505	1563	1622	1679	1878
1354	1413	1467	1525	1583	1643	1698	1756	1814	2011
1383	1445	1500	1557	1616	1674	1730	1789	1847	2044
1451	1509	1567	1624	1681	1740	1797	1854	1912	2112

No Arms
Fixed T-Arms
2D Width and Height-Adjustable T-Arms
3D Width and Height-Adjustable T-Arms

	Leather LA	Leather LB	Leather LC	Leather LD
1677	1745	1952	2023	
1812	1879	2088	2155	
1846	1912	2119	2187	
1911	1979	2185	2257	

If Dual Upholstered (D) is specified	add 256
If Soft Casters (A) are specified	add 28
If Hard Glides (B) are specified	add 28
If Soft Glides (C) are specified	add 43

Pricing is continued on the following pages.

N A C X
Amicus – Synchro-Tilt
Task Chair (Continued)

DESCRIPTION	PRICE									
	Grade 1	COM/ Grade 2	COL/ Grade 3	Grade 4	Grade 5	Grade 6	Grade 7	Grade 8	Grade 9	Grade 10
HIGH-BACK (H)										
No Arms	1376	1445	1510	1579	1645	1710	1779	1848	1913	2146
Fixed T-Arms	1510	1579	1646	1712	1778	1848	1915	1980	2051	2281
2D Width and Height-Adjustable T-Arms	1543	1611	1679	1745	1812	1878	1948	2011	2081	2313
3D Width and Height-Adjustable T-Arms	1611	1677	1745	1812	1878	1945	2011	2081	2146	2383
	Leather LA	Leather LB	Leather LC	Leather LD						
No Arms	1970	2061	2336	2428						
Fixed T-Arms	2107	2197	2471	2562						
2D Width and Height-Adjustable T-Arms	2138	2230	2506	2595						
3D Width and Height-Adjustable T-Arms	2205	2297	2568	2660						
If Dual Upholstered (D) is specified	add 256									
If Soft Casters (A) are specified	add 28									
If Hard Glides (B) are specified	add 28									
If Soft Glides (C) are specified	add 43									

work chairs

Xpress

N A M G

Amicus – Guest Chair

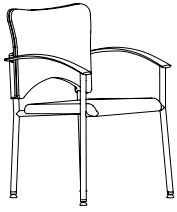

4-Leg with Glides

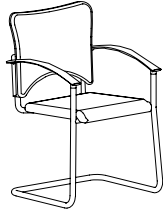

Cantilever with Glides

FEATURES

- Outer back and arms are plastic and finished in Ebony
- Multi-surface glides are standard when the Cantilever or Four-Leg frame style is specified
- Hard casters are standard when the Four-Leg with Casters frame style is specified. Soft casters may be ordered as an option

NOTES

When plastic back style is specified only the seat will be upholstered. When upholstered pad on plastic back is specified both the seat and inside back will be upholstered.

Not all configurations are available as Xpress. Please see Xpress catalogue and/or specification software for details.

PRODUCT OPTIONS

Size	Frame Style	Arm Style	Upholstery/ Back Style	Upholstery Finish	Frame Finish	Casters/Glides (Optional)
D Low-Back	C Cantilever with Glides	N No Arms	Z Plastic	Fabric	E Ebony	A Casters, Soft (For G frame style) D Glides (For C and F frame style)
	F 4-Leg with Glides (Shown)	K Integrated Arms	U Upholstered Pad on Plastic Back	Leather	K Mica Silver	
	G 4-Leg with Casters					

SAMPLE ORDER CODE

NAMG D	C	K	Z		E	
--------	---	---	---	--	---	--

DESCRIPTION

PRICE

WITHOUT CASTERS

FOUR-LEG (F) PLASTIC BACK (Z)	Grade 1	COM/ Grade 2	COL/ Grade 3	Grade 4	Grade 5	Grade 6	Grade 7	Grade 8	Grade 9	Grade 10
No Arms	473	512	553	593	635	675	713	755	795	936
Integrated Arms	530	567	610	652	689	731	769	812	854	992
FOUR-LEG (F) UPHOLSTERED BACK (U)										
No Arms	541	583	625	665	704	742	785	827	865	1007
Integrated Arms	599	638	680	718	761	799	841	883	921	1063
CANTILEVER (C) PLASTIC BACK (Z)										
No Arms	552	592	631	673	712	754	793	833	873	1014
Integrated Arms	609	651	688	730	768	809	851	890	933	1068
CANTILEVER (C) UPHOLSTERED BACK (U)										
No Arms	622	660	703	741	784	822	864	906	944	1086
Integrated Arms	677	717	760	797	838	880	920	962	1000	1143

If Mica is specified add 84
If Soft Casters (A) are specified add 43

Pricing is continued on the following pages.

N A M G
Amicus – Guest Chair (Continued)

DESCRIPTION	PRICE									
WITHOUT CASTERS (CONTINUED)										
FOUR-LEG (F) PLASTIC BACK (Z)	Leather LA	Leather LB	Leather LC	Leather LD						
No Arms	745	788	906	943						
Integrated Arms	804	843	962	999						
FOUR-LEG (F) UPHOLSTERED BACK (U)										
No Arms	818	858	974	1014						
Integrated Arms	873	914	1032	1068						
CANTILEVER (C) PLASTIC BACK (Z)										
No Arms	827	865	983	1022						
Integrated Arms	883	921	1038	1079						
CANTILEVER (C) UPHOLSTERED BACK (U)										
No Arms	896	937	1057	1093						
Integrated Arms	954	993	1111	1148						
WITH CASTERS										
FOUR-LEG (G) PLASTIC BACK (Z)	Grade 1	COM/ Grade 2	COL/ Grade 3	Grade 4	Grade 5	Grade 6	Grade 7	Grade 8	Grade 9	Grade 10
No Arms	519	559	599	639	679	717	760	797	841	980
Integrated Arms	577	614	654	696	735	776	815	856	896	1036
FOUR-LEG (G) UPHOLSTERED BACK (U)										
No Arms	587	628	669	709	748	789	829	871	912	1051
Integrated Arms	644	683	727	766	805	844	885	926	967	1109
FOUR-LEG (G) PLASTIC BACK (Z)	Leather LA	Leather LB	Leather LC	Leather LD						
No Arms	792	832	948	989						
Integrated Arms	850	887	1007	1043						
FOUR-LEG (G) UPHOLSTERED BACK (U)										
No Arms	862	905	1021	1060						
Integrated Arms	918	960	1073	1115						
If Mica is specified	add	84								
If Soft Casters (A) are specified	add	43								

around synchro-tilt task chair & stool overview

The Around Chair, designed by Justus Kolberg, is a task chair and swivel stool collection that achieves two different looks with either an upholstered or mesh back, framed by a sleek sculptural form.

The concealed innovations optimize function and comfort

It offers a distinctive design expression and an opportunity to vary the aesthetic with the product line.

It is available with a mesh or fabric back and fully assembled or not fully assembled.

Around Task Chair (NARM)



finishes

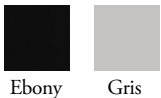

statement of line

with lumbar

without lumbar



around synchro-tilt task chair & stool overview (continued)

Around Task Chair, Upholstered Back (NART)



finishes

Note: When Fine Grain or Leather LA is specified on the back of the chair the back panel of the seat will default to: Percept Essence on Ebony frames Percept Pristine on Gris frames.

statement of line

single upholstery



Task Chair Upholstered Back – 2D Arms (NARTNW / NARUNW) Task Chair, Upholstered Back – 4D Arms (NARTNP / NARUNP) Swivel Stool Upholstered Back – 2D Arms (NARKNW) Swivel Stool Upholstered Back – 4D Arms (NARKNP)

dual upholstery



Task Chair Upholstered Back – 2D Arms (NARTNW / NARUNW) Task Chair, Upholstered Back – 4D Arms (NARTNP / NARUNP) Swivel Stool Upholstered Back – 2D Arms (NARKNW) Swivel Stool Upholstered Back – 4D Arms (NARKNW)

around synchro-tilt task chair & stool dimension & material requirements

features

- Designed and tested for users up to 300 lbs
- Meets ANSI/BIFMA Requirement

weight

Around Task - Mesh	36 lbs
Around Task - Upholstered	36 lbs

task chair

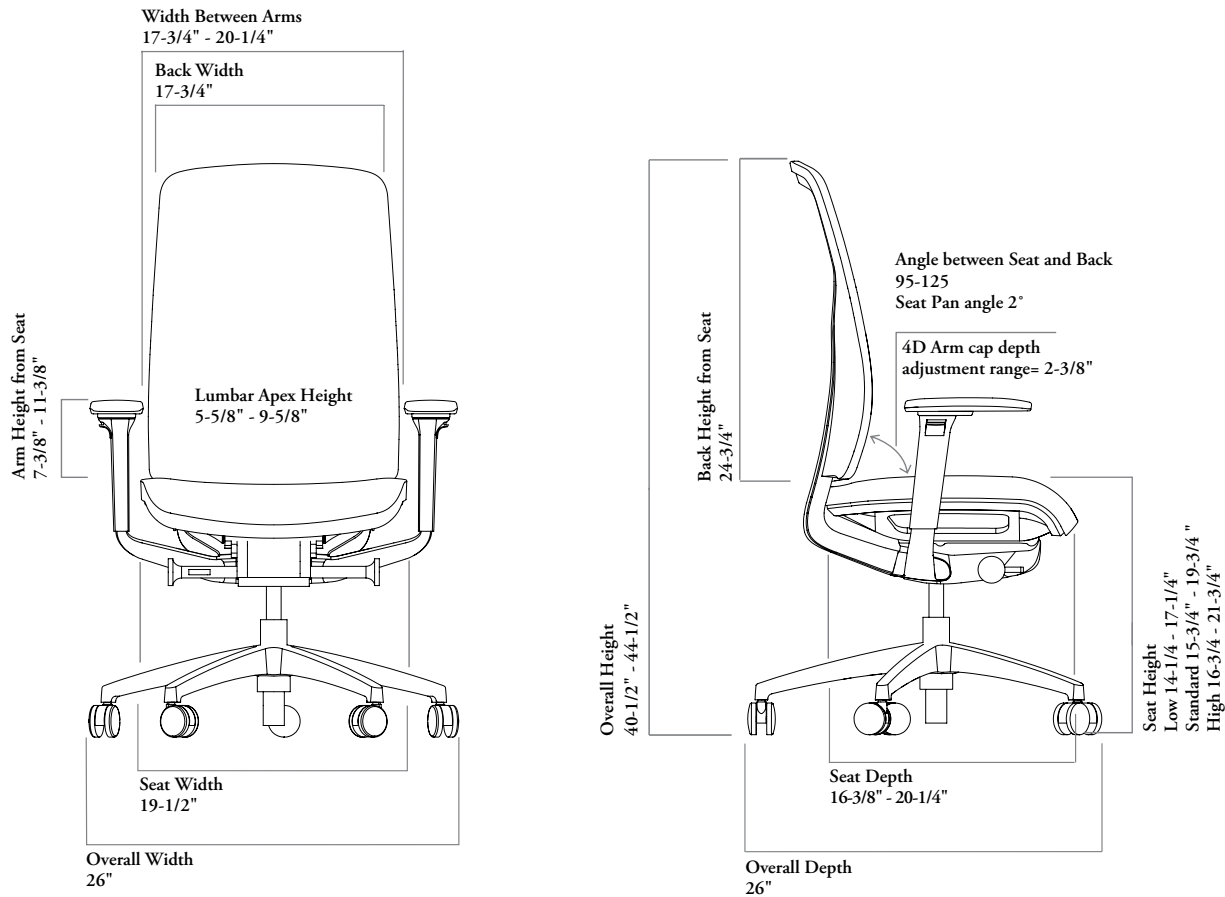

COM/COL material requirement

The pattern, repeat and directionality of fabric may increase the amount of yardage required.

Leather quantities should always be rounded up to the next hide size, as yields vary from 60-80% and are affected by the quality, size and shape of the hide, and by the location and quantity of blemishes.

	SEAT ONLY		SINGLE UPHOLSTERED		DUAL UPHOLSTERED – BACK	
	COM [yards]	COL [sq. ft]	COM [yards]	COL [sq. ft]	COM [yards]	COL [sq. ft]
With Mesh Back	0.5	10	n/a	n/a	n/a	n/a
With Upholstered Back	1	10	2	20	1.5	10

around synchro-tilt task chair & stool dimension & material requirements (continued)

features

- Designed and tested for users up to 300 lbs
- Meets ANSI/BIFMA Requirement

weight

Swivel Stool-Mesh	44 lbs
Swivel Stool-Upholstered	44 lbs

swivel stool

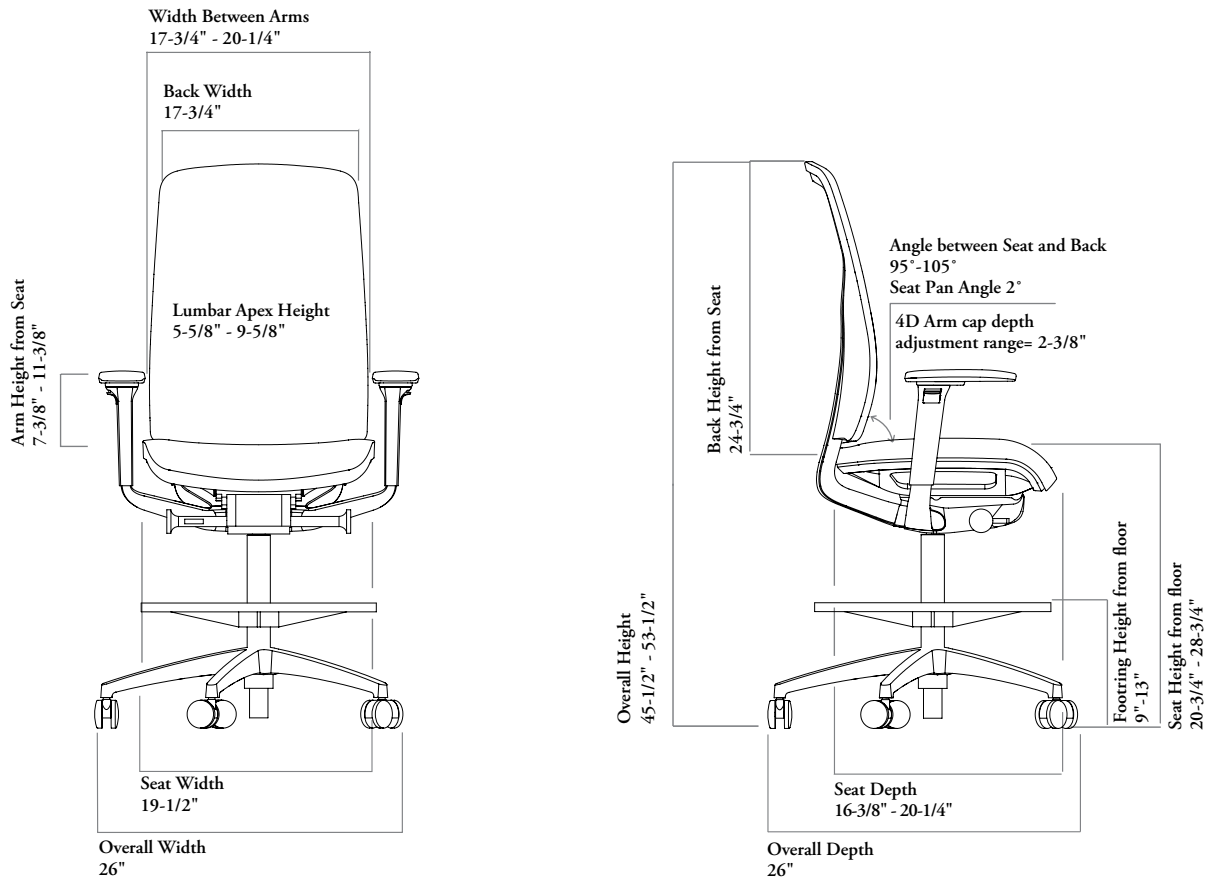

COM/COL material requirement

The pattern, repeat and directionality of fabric may increase the amount of yardage required.

Leather quantities should always be rounded up to the next hide size, as yields vary from 60-80% and are affected by the quality, size and shape of the hide, and by the location and quantity of blemishes.

	SEAT ONLY		SINGLE UPHOLSTERED		DUAL UPHOLSTERED – BACK	
	COM [yards]	COL [sq. ft]	COM [yards]	COL [sq. ft]	COM [yards]	COL [sq. ft]
With Mesh Back	0.5	10	n/a	n/a	n/a	n/a
With Upholstered Back	1	10	2	20	1.5	10

around synchro-tilt task chair & stool adjustment features & instructions

reclining tension override

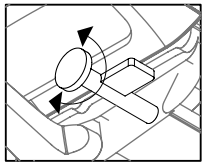

While the weight-balancing mechanism automatically adjusts the tilt-tension to each user, an override grip is located below the seat on the right hand side to enable modification to suit user preference. To fine tune the tilt tension, simply rotate the grip forward to tighten and backwards to loosen.

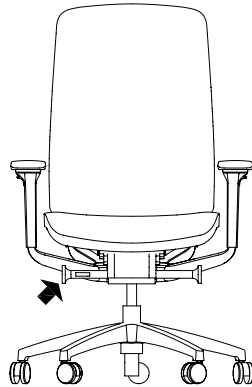

tilt-lock and limiter

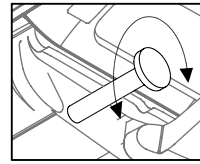

Turning the grip found under the left side of the seat backwards limits the back tilt travel and locks the back when it's rotated fully forward. Travel is limited on 4 positions with back lock in the upright position.

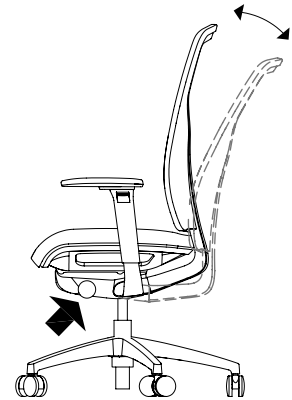

arm width, depth and pivot adjustment

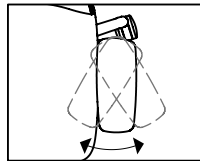
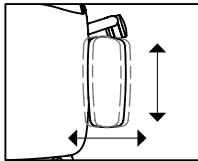

To adjust the width of the 2D and 4D arms, grab the arm pad on both sides and push to the left or to the right to the desired position.

For the 4D arm option, simultaneously pivot the arm pad inward or outward to the desired angle. Arm pad depth can be controlled by grabbing the pad and sliding it forward or backward.

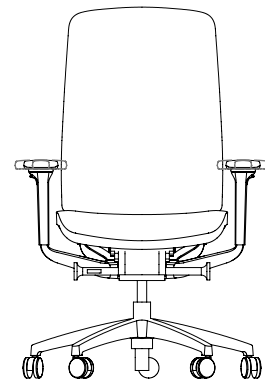
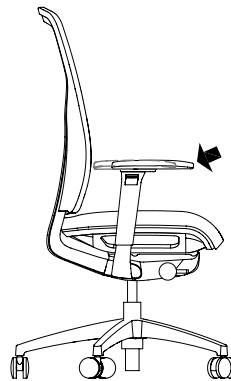
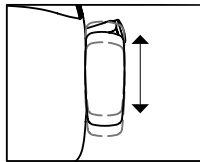

arm height-adjustment

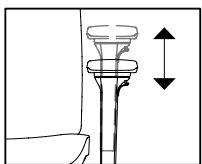

To adjust the height-adjustable arm height, press the button below either arm rest to raise or lower it to the desired position.

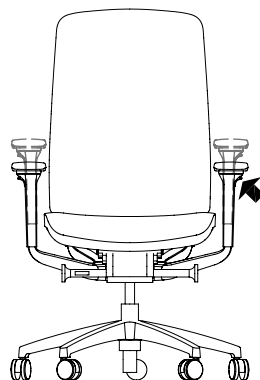

seat height-adjustment

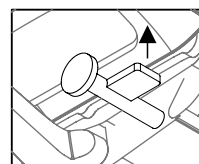

Seat height can be adjusted by pulling up on the lever below the seat on the right hand side. When this lever is pulled, the weight of the body will cause the seat to lower, and releasing it stops the seat at the desired height. Pulling up on the lever with no weight on the seat allows it to rise.

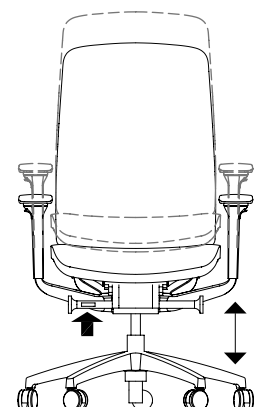

around synchro-tilt task chair & stool adjustment features & instructions (continued)

lumbar support height-adjustment (upholstered)

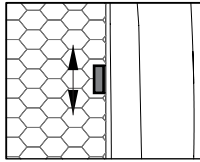

While sitting in the chair, put arms behind back to grab each individual lumbar control knob, slide each element up or down to match your physical requirements, even for asymmetrical positioning.

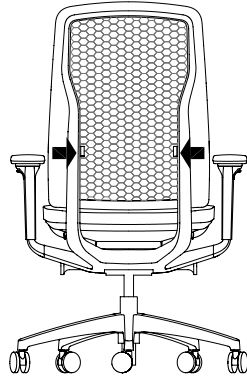

lumbar support height-adjustment (mesh)

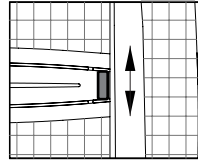

While sitting in the chair, put arms behind back to grab the lumbar control knobs on both sides of lumbar element, slide lumbar up or down to match your physical requirements.

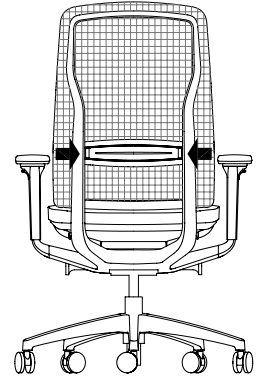

seat depth adjustment

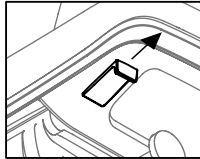

To adjust the seat depth, pull outward on the lever below the seat on the left-hand side and simultaneously lift your weight from the seat while sliding the seat forward. Seat depth reduction is assisted by a spring-loaded motion. For either direction, release button to lock the seat in place.

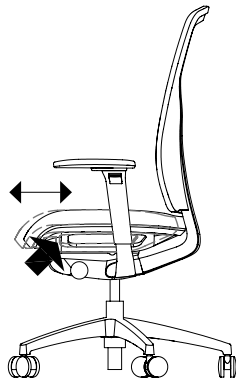

footring adjustment (stool)

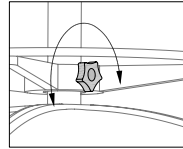

To raise or lower the stool's foot ring, turn the foot ring's knob counter-clockwise to release the foot ring and adjust the ring until you reach desired level. Turn the knob clockwise to lock in place.

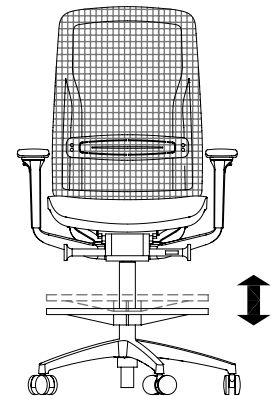

N A R M

Around Synchro-Tilt – Task Chair, Mesh Back, Assembled



With Lumbar Element



No Lumbar Element

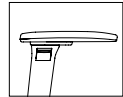

2D + 4D Arm

FEATURES

- Standard pneumatic cylinder provides height-adjustment of 4"
- Weight-balanced Synchro-Tilt mechanism that allows tilt-tension override with one simple rotation of control. Back recline up to 23°
- Back tilt can be locked in the upright position or left to free flow to 4 defined angle ranges
- Unique, cushioned mesh wrapped-back provides comfort and tactile experience. Available in 5 optional colorways that are coordinates with key Luum Fundamentals upholstery colors
- Curated finishes in Ebony Plastic Frame with Ebony plastic 5-Star Base or Gris Plastic Frame with Cool Grey plastic details and Polished Aluminum 5-Star Base
- Integrated FlexAround Seat Pan offers an advanced degree of comfort in a slim, sleek profile.
- Optional Seat Depth Adjustment of 3-7/8"
- Optional 4" height-adjustable Lumbar Element
- Optional plastic arms with 2D (height and width) or 4D (height, width, depth and pivot) adjustments that are easy to access
- Options for Hard and Soft Casters finished in Ebony or Silver and Ebony finish, or Hard and Soft Glides
- Hard Casters are standard and well suited for soft flooring such as carpeting
- Soft Casters are available for use on hard flooring, such as wood, concrete or tile

NOTES

Around Chair with Mesh is offered with Around Mesh on the back and Teknion's Luum standard upholstery available on the seat.

Arm finish and mechanism finish defaults to Frame Finish. Gris plastic Frame Finish option includes Cool Grey plastic finish details on tactile interfaces such as arm pads, lumbar adjustment knob and other adjustment controls. Ebony is base price finish.

Model ships fully assembled. Specify separate model NARN if Not Fully Assembled model is required.

PRODUCT OPTIONS

Headrest	Arm Style	Around Mesh Back Finish	Seat Upholstery Finish	Seat Depth Adjustment
N No Headrest	W 2D Arms P 4D Arms	A123 Banner A124 Lapis A125 Brier A126 Dove A127 Black	Fabric Leather	N No Seat Depth Adjustment S With Seat Depth Adjustment

SAMPLE ORDER CODE

NARM N	W	A127	E523	S
---------------	----------	-------------	-------------	----------

PRODUCT OPTIONS (CONTINUED)

Lumbar Element	Cylinder Style	Frame Finish	Castors/Glides	Caster Finish
N No Lumbar Element Y With Lumbar Element	1 Standard 2 High 3 Low	8B Ebony 9F Gris	Hard Casters A Soft Casters B Hard Glides C Soft Glides	1 Ebony 2 Silver and Ebony

SAMPLE ORDER CODE (CONTINUED)

Y	1	8B	A	1
----------	----------	-----------	----------	----------

See pricing on the following page.

N A R M
Around Synchro-Tilt – Task Chair,
Mesh Back, Assembled (Continued)

DESCRIPTION	PRICE								
	Grade 1	COM/ Grade 2	COL/ Grade 3	Grade 4	Grade 5	Grade 7	Grade 8	Grade 9	Grade 10
2D Arms	992	1018	1043	1059	1071	1099	1115	1126	1144
4D Arms	1066	1093	1119	1136	1147	1175	1189	1203	1218
	Leather LA	Leather LB	Leather LC	Leather LD					
2D Arms	1324	1379	1549	1602					
4D Arms	1400	1453	1623	1679					
With Seat Depth Adjustment	add	70							
With Lumbar Element	add	56							
With Gris Frame Finish	add	153							
If Soft Casters, Ebony are specified	add	28							
If Hard Casters, Silver and Ebony are specified	add	30							
If Soft Casters, Silver and Ebony are specified	add	70							
If Hard Glides are specified	add	28							
If Soft Glides are specified	add	43							

NARN

Around Synchro-Tilt – Task Chair, Mesh Back, Not Fully Assembled



With Lumbar Element



No Lumbar Element

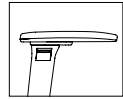

2D + 4D Arm

FEATURES

- Standard pneumatic cylinder provides height-adjustment of 4"
- Weight-balanced Synchro-Tilt mechanism that allows tilt-tension override with one simple rotation of control. Back recline up to 23°
- Back tilt can be locked in the upright position or left to free flow to 4 defined angle ranges
- Unique, cushioned mesh wrapped-back provides comfort and tactile experience. Available in 5 optional colorways that are coordinates with key Luum Fundamentals upholstery colors
- Curated finishes in Ebony Plastic Frame with Ebony plastic 5-Star Base or Gris Plastic Frame with Cool Grey plastic details and Polished Aluminum 5-Star Base
- Integrated FlexAround Seat Pan offers an advanced degree of comfort in a slim, sleek profile.
- Optional Seat Depth Adjustment of 3-7/8"
- Optional 4" height-adjustable Lumbar Element
- Optional plastic arms with 2D (height and width) or 4D (height, width, depth and pivot) adjustments that are easy to access
- Options for Hard and Soft Casters finished in Ebony or Silver and Ebony finish, or Hard and Soft Glides
- Hard Casters are standard and well suited for soft flooring such as carpeting
- Soft Casters are available for use on hard flooring, such as wood, concrete or tile

NOTES

Around Chair with Mesh is offered with Around Mesh on the back and Teknion's Luum standard upholstery available on the seat.

Arm finish and mechanism finish defaults to Frame Finish. Ebony is base price finish. Gris plastic Frame Finish option includes Cool Grey plastic finish details on tactile interfaces such as arm pads, lumbar adjustment knob and other adjustment controls.

Not Fully Assembled model ships compact and customer is responsible for assembly. Innovative "Quick-Snap Assembly" facilitates easy on-site assembly without tools. Specify NARM model for Fully Assembled version.

PRODUCT OPTIONS

Headrest	Arm Style	Around Mesh Back Finish	Seat Upholstery Finish	Seat Depth Adjustment
N No Headrest	W 2D Arms P 4D Arms	A123 Banner A124 Lapis A125 Brier A126 Dove A127 Black	Fabric Leather	N No Seat Depth Adjustment S With Seat Depth Adjustment

SAMPLE ORDER CODE

NARN N	W	A127	E523	S
---------------	----------	-------------	-------------	----------

PRODUCT OPTIONS (CONTINUED)

Lumbar Element	Cylinder Style	Frame Finish	Castors/Glides	Caster Finish
N No Lumbar Element Y With Lumbar Element	1 Standard 2 High 3 Low	8B Ebony 9F Gris	Hard Casters A Soft Casters B Hard Glides C Soft Glides	1 Ebony 2 Silver and Ebony

SAMPLE ORDER CODE (CONTINUED)

Y	1	8B	A	1
----------	----------	-----------	----------	----------

See pricing on the following page.

N A R N
Around Synchro-Tilt – Task Chair,
Mesh Back, Not Fully Assembled
(Continued)

DESCRIPTION	PRICE									
	Grade 1	COM/ Grade 2	COL/ Grade 3	Grade 4	Grade 5	Grade 7	Grade 8	Grade 9	Grade 10	
2D Arms	992	1018	1043	1059	1071	1099	1115	1126	1144	
4D Arms	1066	1093	1119	1136	1147	1175	1189	1203	1218	
	Leather LA	Leather LB	Leather LC	Leather LD						
2D Arms	1324	1379	1549	1602						
4D Arms	1400	1453	1623	1679						
With Seat Depth Adjustment	add	70								
With Lumbar Element	add	56								
With Gris Frame Finish	add	153								
If Soft Casters, Ebony are specified	add	28								
If Hard Casters, Silver and Ebony are specified	add	30								
If Soft Casters, Silver and Ebony are specified	add	70								
If Hard Glides are specified	add	28								
If Soft Glides are specified	add	43								

NART

Around Synchro-Tilt – Task Chair, Upholstered Back, Fully Assembled

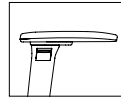
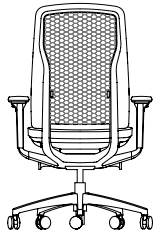

2D + 4D
Arm

FEATURES

- Standard pneumatic cylinder provides height-adjustment of 4"
- Weight-balanced Synchro-Tilt mechanism that allows tilt-tension override with one simple rotation of control. Back recline up to 23°
- Back tilt can be locked in the upright position or left to free flow to 4 defined angle ranges
- Cushioned, wrapped-upholstered back provides comfort and tactile experience. Unique flexing, Around Hex Suspension System combines comfort, support, flexibility and the characteristic look
- Curated finishes in Ebony Plastic Frame with Ebony plastic 5-Star Base or Gris Plastic Frame with Cool Grey plastic details and Polished Aluminum 5-Star Base
- Includes standard innovative Lumbar Elements with 4" of height-adjustment, including asymmetrical positioning.
- Integrated FlexAround Seat Pan offers an advanced degree of comfort in a slim, sleek profile
- Optional Seat Depth Adjustment of 3-7/8"
- Optional plastic arms with 2D (height and width) or 4D (height, width, depth and pivot) adjustments that are easy to access
- Options for Hard and Soft Casters finished in Ebony or Silver and Ebony finish, or Hard and Soft Glides
- Hard Casters are standard and well suited for soft flooring such as carpeting
- Soft Casters are available for use on hard flooring, such as wood, concrete or tile

NOTES

Around Chair with Upholstery is offered with selected Teknion LUUM upholstery on the back and Standard LUUM upholstery available on the seat. When Fine Grain or Leather LA is specified on the back in Single or Dual Upholstery Style, the upholstery panel behind the plastic Hex Suspension System defaults to Percept-Essence to coordinate with Ebony Frame Finish and Percept-Pristine upholstery to coordinate with Gris Frame Finish.

Single Upholstered: The same fabric colorway is applied to the seat and wrapped back.

Dual Upholstered: Two different fabrics or colorways are applied to the chair, one fabric to the wrapped back and one to the seat. First fabric listed will apply to the back and is the grade of fabric used to price the chair. A dual upholstery upcharge applies.

Arm finish and mechanism finish defaults to Frame Finish. Gris plastic Frame Finish option includes Cool Grey plastic finish details on tactile interfaces such as arm pads, lumbar adjustment knob and other adjustment controls. Ebony is base finish price.

Model ships fully assembled. Specify separate model NARU if Not Fully Assembled model is required.

PRODUCT OPTIONS

Headrest	Arm Style	Upholstery Style	Back Upholstery Finish	Seat Upholstery Finish
N No Headrest	W 2D Arms P 4D Arms	S Single Upholstery D Dual Upholstery	Fabric	Fabric Leather

SAMPLE ORDER CODE

NART N	W	D	E531	E523
--------	---	---	------	------

PRODUCT OPTIONS (CONTINUED)

Seat Depth Adjustment	Cylinder Style	Frame Finish	Castors/Glides	Caster Finish
N No Seat Depth Adjustment	1 Standard	8B Ebony	Hard Casters	1 Ebony
S With Seat Depth Adjustment	2 High 3 Low	9F Gris	A Soft Casters B Hard Glides C Soft Glides	2 Silver and Ebony

SAMPLE ORDER CODE (CONTINUED)

S	1	8B	A	1
---	---	----	---	---

See pricing on the following page.

N A R T
Around Synchro-Tilt – Task Chair,
Upholstered Back, Fully Assembled
(Continued)

DESCRIPTION	PRICE		
	Grade 1	Grade 2	Grade 3
2D Arms	1268	1312	1428
4D Arms	1344	1386	1356
	Leather LA		
2D Arms	1518		
4D Arms	1593		
With Seat Depth Adjustment	add	70	
With Gris Frame Finish	add	153	
If Dual Upholstered (D) is specified	add	256	
If Soft Casters, Ebony are specified	add	28	
If Hard Casters, Silver and Ebony are specified	add	30	
If Soft Casters, Silver and Ebony are specified	add	70	
If Hard Glides are specified	add	28	
If Soft Glides are specified	add	43	

N A R U

Around Synchro-Tilt – Task Chair, Upholstered Back, Not Fully Assembled

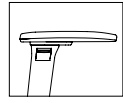
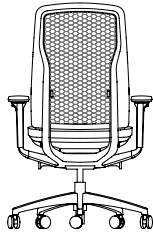

2D + 4D
Arm

FEATURES

- Standard pneumatic cylinder provides height-adjustment of 4"
- Weight-balanced Synchro-Tilt mechanism that allows tilt-tension override with one simple rotation of control. Back recline up to 23°
- Back tilt can be locked in the upright position or left to free flow to 4 defined angle ranges
- Cushioned, wrapped-upholstered back provides comfort and tactile experience. Unique flexing, Around Hex Suspension System combines comfort, support, flexibility and the characteristic look
- Curated finishes in Ebony Plastic Frame with Ebony plastic 5-Star Base or Gris Plastic Frame with Cool Grey plastic details and Polished Aluminum 5-star Base
- Includes standard innovative Lumbar Elements with 4" of height-adjustment, including asymmetrical positioning.
- Integrated FlexAround Seat Pan offers an advanced degree of comfort in a slim, sleek profile
- Optional Seat Depth Adjustment of 3-7/8"
- Optional plastic arms with 2D (height and width) or 4D (height, width, depth and pivot) adjustments that are easy to access
- Options for Hard and Soft Casters finished in Ebony or Silver and Ebony finish, or Hard and Soft Glides
- Hard Casters are standard and well suited for soft flooring such as carpeting
- Soft Casters are available for use on hard flooring, such as wood, concrete or tile

NOTES

Around Chair with Upholstery is offered with selected LUUM upholstery on the back and Standard LUUM upholstery available on the seat. See NART for more fabric and finish details.

Single Upholstered: The same fabric colorway is applied to the seat and wrapped back.

Dual Upholstered: Two different fabrics or colorways are applied to the chair, one fabric to the wrapped back and one to the seat. First fabric listed will apply to the back and is the grade of fabric used to price the chair. A dual upholstery upcharge applies.

Arm finish and mechanism finish defaults to Frame Finish. Gris plastic Frame Finish option includes Cool Grey plastic finish details on tactile interfaces such as arm pads, lumbar adjustment knob and other adjustment controls. Ebony is base finish price.

Not Fully Assembled model ships compact and customer is responsible for assembly. Innovative "Quick-Snap Assembly" facilitates easy on-site assembly without tools. Specify NART model for Fully Assembled version.

PRODUCT OPTIONS

Headrest	Arm Style	Upholstery Style	Back Upholstery Finish	Seat Upholstery Finish
N No Headrest	W 2D Arms P 4D Arms	S Single Upholstery D Dual Upholstery	Fabric	Fabric Leather

SAMPLE ORDER CODE

NARU N	W	D	E531	E523
---------------	----------	----------	-------------	-------------

PRODUCT OPTIONS (CONTINUED)

Seat Depth Adjustment	Cylinder Style	Frame Finish	Castors/Glides	Caster Finish
N No Seat Depth Adjustment	1 Standard	8B Ebony	Hard Casters	1 Ebony
S With Seat Depth Adjustment	2 High 3 Low	9F Gris	A Soft Casters B Hard Glides C Soft Glides	2 Silver and Ebony

SAMPLE ORDER CODE (CONTINUED)

S	2	9F	A	1
----------	----------	-----------	----------	----------

See pricing on the following page.

N A R U
Around Synchro-Tilt –
Task Chair, Upholstered Back,
Not Fully Assembled (Continued)

DESCRIPTION	PRICE		
	Grade 1	Grade 2	Grade 3
2D Arms	1268	1312	1428
4D Arms	1344	1386	1356
	Leather		
	LA		
2D Arms	1518		
4D Arms	1593		
With Seat Depth Adjustment	add	70	
With Gris Frame Finish	add	153	
If Dual Upholstered (D) is specified	add	256	
If Soft Casters, Ebony are specified	add	28	
If Hard Casters, Silver and Ebony are specified	add	30	
If Soft Casters, Silver and Ebony are specified	add	70	
If Hard Glides are specified	add	28	
If Soft Glides are specified	add	43	

NARH Around Swivel Stool, Mesh Back

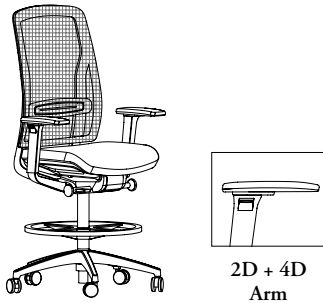

FEATURES

- Standard pneumatic cylinder provides height-adjustment of 8"
- Includes all-aluminum foot ring with 4" height-adjustment
- Weight-balanced Synchro-Tilt mechanism that allows tilt-tension override with one simple rotation of control. Back recline up to 10°
- Back tilt can be locked in the upright position or left to free flow to defined angle ranges
- Unique, cushioned mesh wrapped-back provides comfort and tactile experience. Available in 5 optional colorways that are coordinates with key Luum Fundamentals upholstery colors
- Curated finishes in Ebony Plastic Frame with Ebony plastic 5-Star Base or Gris Plastic Frame with Cool Grey plastic details and Polished Aluminum 5-Star Base
- Integrated FlexAround Seat Pan offers an advanced degree of comfort in a slim, sleek profile.
- Optional Seat Depth Adjustment of 3-7/8"
- Optional 4" height-adjustable Lumbar Element
- Optional plastic arms with 2D (height and width) or 4D (height, width, depth and pivot) adjustments that are easy to access
- Options for Hard and Soft Casters finished in Ebony or Silver and Ebony finish, or Hard and Soft Glides
- Hard Casters are standard and well suited for soft flooring such as carpeting
- Soft Casters are available for use on hard flooring, such as wood, concrete or tile

NOTES

Around Chair with Mesh is offered with Around Mesh on the back and Teknion's Luum standard upholstery available on the seat.

Arm finish and mechanism finish defaults to Frame Finish. Ebony is base price finish. Gris plastic Frame Finish option includes Cool Grey plastic finish details on tactile interfaces such as arm pads, lumbar adjustment knob and other adjustment controls.

Ships compact and customer is responsible for assembly.

PRODUCT OPTIONS

Headrest	Arm Style	Mesh Back Finish	Seat Upholstery Finish	Seat Depth Adjustment	Lumbar Element	Frame Finish	Castors/Glides	Caster Finish
N No Headrest	W 2D Arms	A123 Banner	Fabric	N No Seat Depth Adjustment	N No Lumbar Element	8B Ebony	Casters Hard	1 Ebony
	P 4D Arms	A124 Lapis						
		A125 Brier					B Glides Hard	
		A126 Dove					C Glides Soft	
		A127 Black						

SAMPLE ORDER CODE

NARH N	W	A127	E523	S	Y	8B	A	1
--------	---	------	------	---	---	----	---	---

DESCRIPTION

PRICE

	COM/		COL/						
	Grade 1	Grade 2	Grade 3	Grade 4	Grade 5	Grade 7	Grade 8	Grade 9	Grade 10
2D Arms	1551	1578	1602	1618	1630	1658	1674	1687	1703
4D Arms	1625	1652	1679	1695	1706	1734	1748	1763	1777
	Leather LA	Leather LB	Leather LC	Leather LD					
2D Arms	1883	1938	2108	2161					
4D Arms	1959	2013	2182	2238					

With Seat Depth Adjustment	add	70
With Lumbar Element	add	56
With Gris Frame Finish	add	153
If Soft Casters, Ebony are specified	add	28
If Hard Casters, Silver and Ebony are specified	add	30
If Soft Casters, Silver and Ebony are specified	add	70
If Hard Glides are specified	add	28
If Soft Glides are specified	add	43

FEATURES

- Standard pneumatic cylinder provides height-adjustment of 8"
- Includes all-aluminum foot ring with 4" height-adjustment
- Weight-balanced Synchro-Tilt mechanism that allows tilt-tension override with one simple rotation of control. Back recline up to 10°
- Back tilt can be locked in the upright position or left to free flow to defined angle ranges
- Cushioned, wrapped-upholstered back provides comfort and tactile experience. Unique flexing, Around Hex Suspension System combines comfort, support, flexibility and the characteristic look
- Curated finishes in Ebony Plastic Frame with Ebony plastic 5-Star Base or Gris Plastic Frame with Cool Grey plastic details and Polished Aluminum 5-Star Base
- Includes standard innovative Lumbar Elements with 4" of height-adjustment, including asymmetrical positioning.
- Integrated FlexAround Seat Pan offers an advanced degree of comfort in a slim, sleek profile
- Optional Seat Depth Adjustment of 3-7/8"
- Optional plastic arms with 2D (height and width) or 4D (height, width, depth and pivot) adjustments that are easy to access
- Options for Hard and Soft Casters finished in Ebony or Silver and Ebony finish, or Hard and Soft Glides
- Hard Casters are standard and well suited for soft flooring such as carpeting
- Soft Casters are available for use on hard flooring, such as wood, concrete or tile

NOTES

Around Chair with Upholstery is offered with selected Teknion LUUM upholstery on the back and LUUM Standard upholstery available on the seat. See NART for more fabric and finish details. Single Upholstered: The same fabric colorway is applied to the seat and back.

Dual Upholstered: Two different fabrics or colorways are applied to the chair, one fabric to the wrapped back and one to the seat. First fabric listed will apply to the back and is the grade of fabric used to price the chair. A dual upholstery upcharge applies.

Arm finish and mechanism finish defaults to Frame Finish. Gris plastic Frame Finish option includes Cool Grey plastic finish details on tactile interfaces such as arm pads, lumbar adjustment knob and other adjustment controls. Ebony is base finish price.

Ships compact and customer is responsible for assembly.

N A R K
Around Swivel Stool,
Upholstered Back

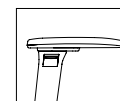

2D + 4D
Arm

PRODUCT OPTIONS

Headrest	Arm Style	Upholstery Style	Back Upholstery Finish	Seat Upholstery Finish	Seat Depth Adjustment	Frame Finish	Casters/ Glides	Caster Finish
N No Headrest	W 2D Arms P 4D Arms	S Single Upholstery D Dual Upholstery	Fabric	Fabric	N No Seat Depth Adjustment S With Seat Depth Adjustment	8B Ebony 9F Gris	Casters Hard A Casters Soft B Glides Hard C Glides Soft	1 Ebony 2 Silver and Ebony

SAMPLE ORDER CODE

NARK N	W	D	E531	E523	S	9G	A	1
---------------	----------	----------	-------------	-------------	----------	-----------	----------	----------

DESCRIPTION

PRICE

	Grade 1	Grade 2	Grade 3
2D Arms	1827	1869	1986
4D Arms	1904	1945	1911

	Leather LA
2D Arms	2078
4D Arms	2152

With Seat Depth Adjustment	add	70
With Gris Frame Finish	add	153
If Dual Upholstered (D) is specified	add	256
If Soft Casters, Ebony are specified	add	28
If Hard Casters, Silver and Ebony are specified	add	30
If Soft Casters, Silver and Ebony are specified	add	70
If Hard Glides are specified	add	28
If Soft Glides are specified	add	43

AT chair overview

The AT chair, a partnership between Wilkhahn and Teknion is an award winning upholstered task chair with fluid lines and harmonious forms. It has a beautiful sculpted design, and its simplicity makes it human and approachable.

It has an intuitive Free-2-move capability with integrated, synchronously supporting 3D kinematics and Trimension and the self-centering suspension shell is combined with automatic weight adjustment.

AT Chair, Upholstered Seat and Back (NWAM)



frame finishes



statement of line



AT Chair,
Upholstered Seat
and Back
(NWAM)

AT chair dimensions & material requirements

features

- Designed and tested for users up to 300 lbs
- Meets ANSI/BIFMA requirements

weight

AT Chair - Upholstered	41 lbs
------------------------	--------

Multi-Use Chair

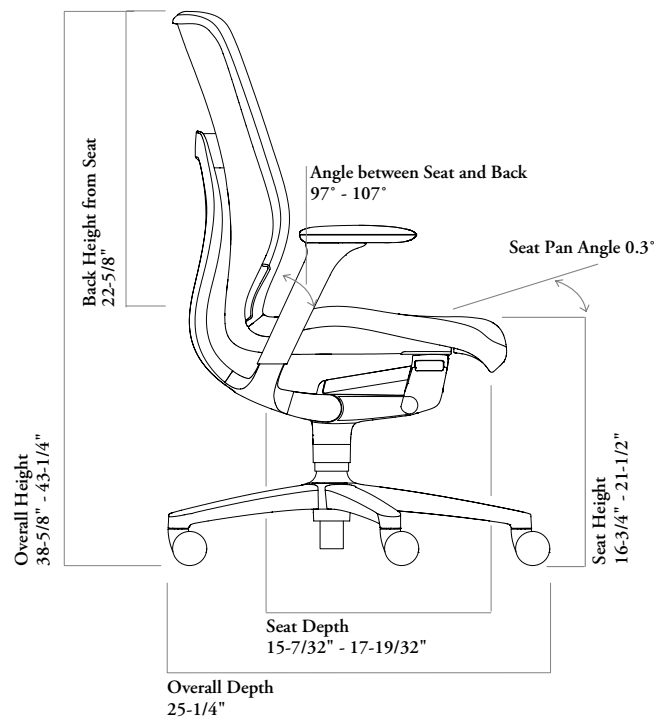
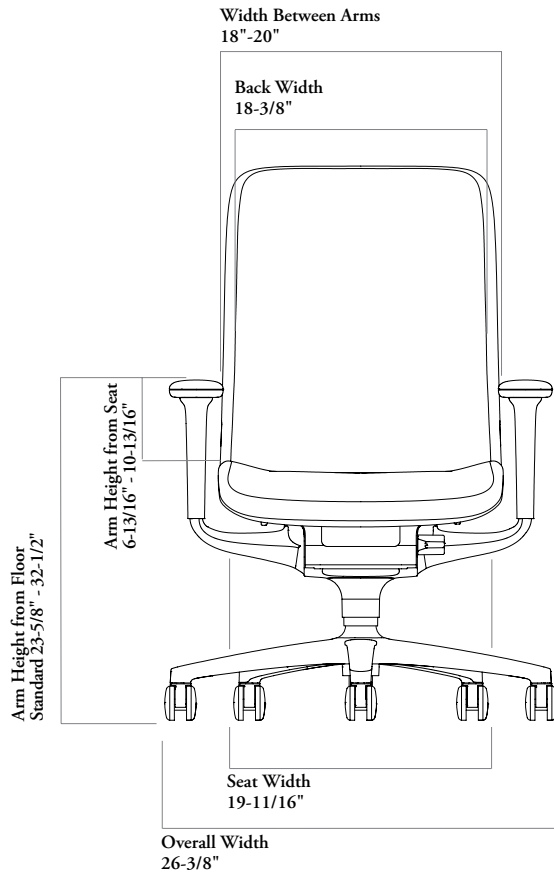

COM/COL material requirement

The pattern, repeat and directionality of fabric may increase the amount of yardage required.

Leather quantities should always be rounded up to the next hide size, as yields vary from 60-80% and are affected by the quality, size and shape of the hide, and by the location and quantity of blemishes.

SINGLE UPHOLSTERED

	COM [yards]	COL [sq. ft]
Seat and Back	1	12

AT chair adjustment features & instructions

seat height adjustment

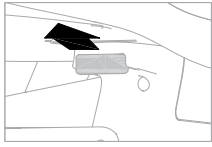

To raise the chair, pull the lever out while lifting your weight from the seat until you reach the desired level, then release the lever to lock in place. To lower the chair, pull the lever out and allow your weight to push the seat down until you reach the desired level, then release the lever to lock.

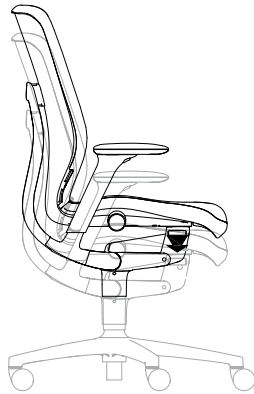

seat depth adjustment

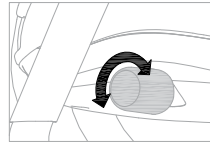

To adjust the seat depth, pull the knob out and rotate it clockwise to extend the seat. Rotate the knob counterclockwise to shorten the seat depth. Push the knob in after adjustment.

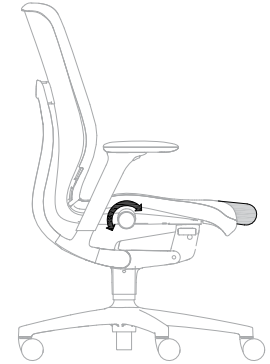

back tilt lock adjustment

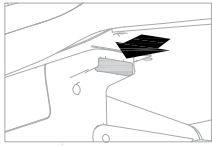

Pull the button out to unlock the back and leave the chair in free flow mode. Push the button to lock the back in the upright position.

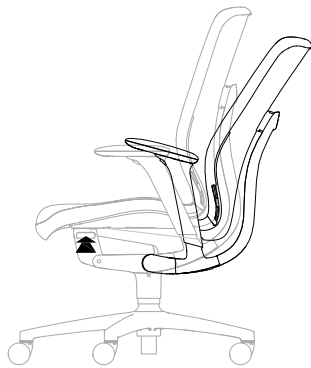

lumbar height adjustment

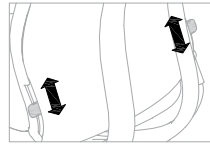

While sitting in the chair, put arms behind backrest to grab both tabs of the lumbar element and slide lumbar up or down to the desired position.

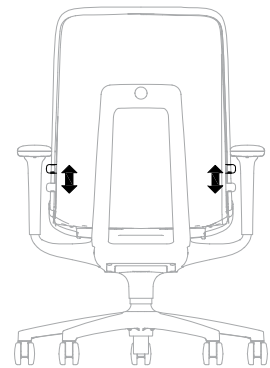

4D arm - width, depth, pivot and height adjustment



To adjust the width of the 4D arms, grab the arm pad on both sides and push to the left or to the right to the desired position. Simultaneously pivot the arm pad inward or outward to the desired angle. Arm pad depth can be controlled by grabbing the pad and sliding it forward or backward.

To adjust arm height, press the button below the armpad to raise or lower it to the desired position. Release the button.

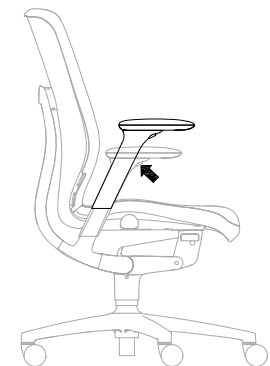

planning with AT chair

The AT chair can be used in a variety of applications throughout a workspace.

workstations

The AT chair is suitable for long term use in any type of workstation settings.



office suites

The aesthetic of the AT chair makes it ideal in private office settings.



meeting and conference rooms

The AT chairs swivel tilt mechanism and seat height is adjusted with one lever making it suitable for short term use in meeting rooms. The fixed height arms look consistent and professional.



NWAM AT Chair



FEATURES

- 300 lbs weight capacity
- Comes standard with 4D Arms providing width, depth, and pivot control
- AT Chairs are available in two frame finishes and are single upholstered (seat and back)
- Standard pneumatic cylinder provides height-adjustment of 12 cm, highest seating position is 52cm
- Back-tilt can be locked in one position at 0° or left free flow
- The height of the lumbar support can be adjusted in eight positions by a total of 50mm
- Seat depth-adjustment is continuous and is integrated into seat front
- Synchro-tilt 1:1.62 ratio and Tilt-Tension Control
- Hard casters are standard and are well suited for soft flooring such as carpeting
- Soft casters are available for use on hard flooring, such as wood, concrete, or tile

NOTES

Plastic Arm finish matches frame finish (Grey arm pads with Atrium White frame , Black arm pads with Ebony frames).

PRODUCT OPTIONS

Upholstery Finish	Racer Fabric	Cylinder Style	Frame Finish	Casters
Fabric	W125 Black	1 Standard	8B Ebony	Casters, Hard
Leather	W126 Anthracite W127 Light Grey		8D Atrium White	A Casters, Soft

SAMPLE ORDER CODE

NWAM E532	W125	1	8B	A
------------------	-------------	----------	-----------	----------

PRICE

Grade 1	COM/ Grade 2	COL/ Grade 3	Grade 4	Grade 5	Grade 6	Grade 7	Grade 8	Grade 9	Grade 10
1724	1793	1857	1924	1993	2058	2127	2196	2261	2493
Leather LA	Leather LB	Leather LC	Leather LD						
2317	2409	2684	2775						

If Atrium White is specified add 173

If Soft Casters (A) are specified add 28

essa chair overview

Essa is designed for Teknion by Pearson Lloyd and takes its name from the work essence.

It has a pared down scale and a pure sculptural shape that takes cues from a classic club chair.

It is a less technical task chair that combines elegance with ergonomics, providing just the right amount of support through curves and contours rather than multiple adjustment mechanisms.

It is available with a plastic or upholstery back.

Essa Chair, Upholstered Back with Plastic Shell (NESP)



frame finishes



statement of line

single upholstery



Essa Chair,
Upholstered Back
with Plastic Shell
No Arms
(NESP)



Essa Chair,
Upholstered Back
with Plastic Shell
Fixed Arms
(NESP)



Essa Chair,
Upholstered Back
with Plastic Shell
Height-Adjustable Arms
(NESP)

dual upholstery



Essa Chair,
Upholstered Back
with Plastic Shell
No Arms
(NESP)



Essa Chair,
Upholstered Back
with Plastic Shell
Fixed Arms
(NESP)



Essa Chair,
Upholstered Back
with Plastic Shell
Height-Adjustable Arms
(NESP)

essa chair overview (continued)

Essa Chair, Upholstered Back (NESU)



frame finishes



statement of line

single upholstery



Essa Chair,
Upholstered Back
No Arms
(NESUN)



Essa Chair,
Upholstered Back
Fixed Arms
(NESUF)



Essa Chair,
Upholstered Back
Height-Adjustable Arms
(NESPUH)

dual upholstery



Essa Chair,
Upholstered Back
No Arms
(NESUN)



Essa Chair,
Upholstered Back
Fixed Arms
(NESUF)



Essa Chair,
Upholstered Back
Height-Adjustable Arms
(NESPUH)

essa chair dimensions & material requirements

features

- Designed and tested for users up to 300 lbs
- Meets ANSI/BIFMA requirements
- Equipped with hard casters intended for use on carpet
- Soft casters are available for hard surfaces
- Weight Balanced Synchro-Tilt

weight

Essa Chair - Upholstered Seat with Plastic Back	39 lbs
Essa Chair - Upholstered Back	39 lbs

Multi-Use Chair

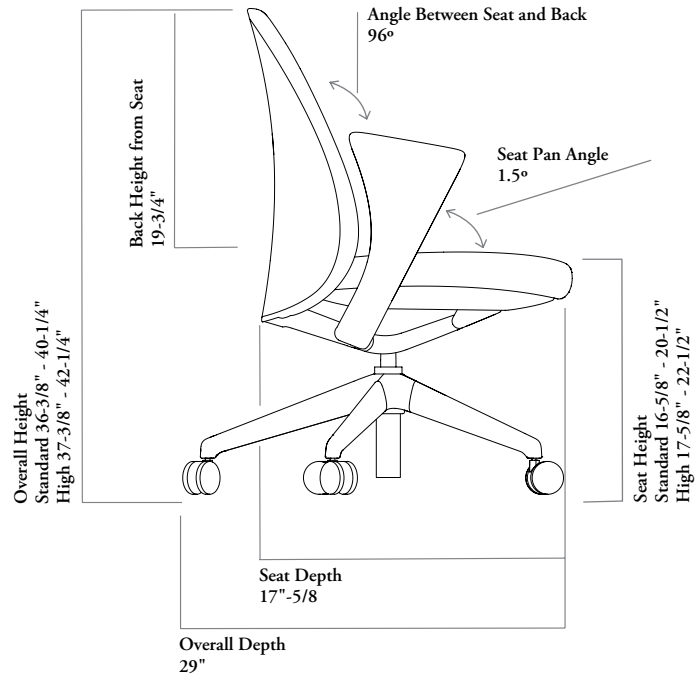
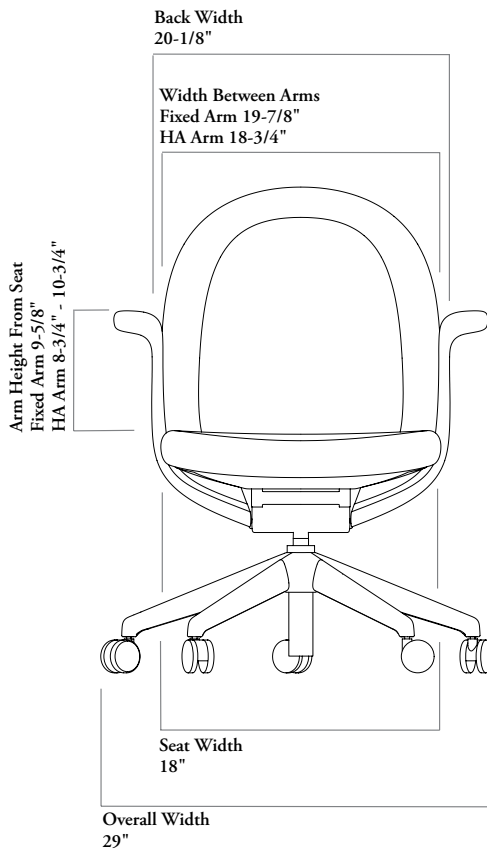

COM/COL material requirement

The pattern, repeat and directionality of fabric may increase the amount of yardage required.

Leather quantities should always be rounded up to the next hide size, as yields vary from 60-80% and are affected by the quality, size and shape of the hide, and by the location and quantity of blemishes.

	SINGLE UPHOLSTERED		DUAL UPHOLSTERED - SEAT		DUAL UPHOLSTERED - BACK	
	COM [yards]	COL [sq. ft]	COM [yards]	COL [sq. ft]	COM [yards]	COL [sq. ft]
Seat						
NESP	1.5	15.5	1	9	1	6.5
NESU	1.75	21	1	9	1	12

planning with essa chair

The following can be considered when planning with the Essa chair.

workstations

The Essa chair with height-adjustable arms is suitable for use in any workstation settings.



enclaves

The Essa chair with no arms is ideal in enclaves and touchdown stations where the end user needs a space to get some quick work completed.



meeting and conference rooms

Essa's contemporary look with curves and comfort is suitable for short-term use in meeting and conference rooms. Fixed arms look consistent and professional.



essa adjustment features & instructions

seat height adjustment

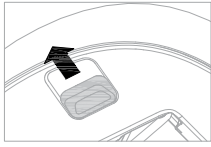

To raise the chair, pull the lever outwards while lifting your weight from the seat until you reach the desired level, then release to lock in place. To lower the chair, pull the lever outwards and allow your weight to push the seat down until you reach the desired level, then release to lock in place.



back tilt adjustment

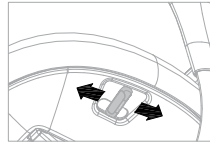

To adjust the angle of recline, move the lever forward to unlock the back and leave the chair in free flow mode. Recline to the desired position and move the lever rearward to lock the back in place.

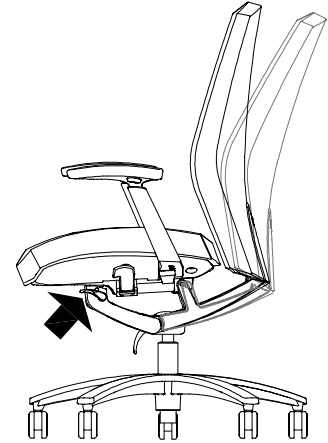

arm height adjustment

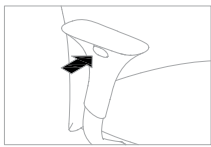

To adjust the arm height, press the button in the upper part of the armrest to raise or lower it to the desired position. Release the button to lock in place.

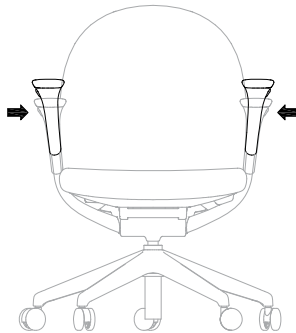

NESP

Essa Chair, Upholstered Back with Plastic Shell, Dual Upholstery

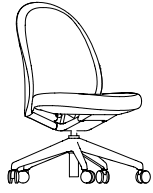

No Arms



Fixed Arms

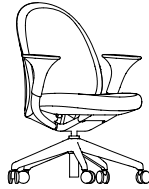

Height-Adjustable Arms

FEATURES

- Standard pneumatic cylinder provide height-adjustment of 4"
- Weight-balanced Synchro-Tilt mechanism. Back recline up to 17°
- Back tilt can be locked in the upright position and 2 defined angles
- Curated finishes in Blackstone, Atrium White, and Clay
- Options for no arm, fixed arm, or height adjust arms
- Options for hard and soft casters or glides
- Hard casters are standard and well suited for soft flooring such as carpeting
- Soft casters are available for use on hard flooring, such as wood, concrete, or tile

NOTES

- When Blackstone (NF) Frame Finish is specified, defaults include Upholstered Back, 5-Point Base, Under Seat, Gas Cylinder, Arms, and Mechanism. Arm Pads, Buttons, and Mechanism Levers default to Dark Grey. Caster selection will be finished Ebony.
- When Atrium White (8D) Frame Finish is specified, defaults include Upholstered Back, 5-Point Base, Under Seat, Gas Cylinder, Arms, and Mechanism. Arm Pads, Buttons, and Mechanism Levers default to Lighter Beige. Caster selection will be finished Grey.
- When Clay (NH) Frame Finish is specified, defaults include Upholstered Back, 5-Point Base, Under Seat, Gas Cylinder, Arms, and Mechanism. Arm Pads, Buttons, and Mechanism Levers default to Lighter Beige. Caster selection will be finished Grey.
- Model ships fully assembled

PRODUCT OPTIONS

Arm Style	Upholstery Style	Back Upholstery Finish	Seat Upholstery Finish	Cylinder Style	Frame Finish	Casters/Glides (Optional)
N No Arms	S Single Upholstery	Fabric	Fabric	1 Standard	8D Atrium White	Hard Casters
F Fixed Arms	D Dual Upholstery	Leather	Leather	2 High	NF Blackstone	A Soft Casters
H Height-Adjustable Arms					NH Clay	B Hard Glides C Soft Glides

SAMPLE ORDER CODE

NESP F	S	E523	E523	1	NH	B
---------------	----------	-------------	-------------	----------	-----------	----------

DESCRIPTION

BACK FABRIC

	Grade 1	COM/ Grade 2	COL/ Grade 3	Grade 4	Grade 5	Grade 6	Grade 7	Grade 8	Grade 9	Grade 10
No Arms (N)	1180	1220	1264	1306	1349	1391	1435	1476	1520	1561
Fixed Arms (F)	1292	1334	1377	1419	1463	1503	1547	1589	1630	1674
Height-Adjustable Arms (H)	1391	1435	1476	1520	1561	1602	1646	1688	1731	1772

BACK LEATHER

	Leather LA	Leather LB	Leather LC	Leathr LD
No Arms (N)	1529	1566	1601	1639
Fixed Arms (F)	1650	1684	1720	1759
Height-Adjustable Arms (H)	1738	1772	1808	1847

If Soft Casters (A) are specified	add	28
If Hard Glides (B) are specified	add	28
If Soft Glides (C) are specified	add	43
If Dual Upholstered (D) is specified	add	256

FEATURES

- Standard pneumatic cylinder provide height-adjustment of 4"
- Weight-balanced Synchro-Tilt mechanism. Back recline up to 17°
- Back tilt can be locked in the upright position and 2 defined angles
- Curated finishes in Blackstone, Atrium White, and Clay
- Options for no arm, fixed arm, or height adjust arms
- Options for hard and soft casters or glides
- Hard casters are standard and well suited for soft flooring such as carpeting
- Soft casters are available for use on hard flooring, such as wood, concrete, or tile

NOTES

- When Blackstone (NF) Frame Finish is specified, defaults include PLASTIC BACK, 5-Point Base, Under Seat, Gas Cylinder, Arms, and Mechanism. Arm Pads, Buttons, and Mechanism Levers default to Dark Grey. Caster selection will be finished Ebony.
- When Atrium White (8D) Frame Finish is specified, defaults include PLASTIC BACK, 5-Point Base, Under Seat, Gas Cylinder, Arms, and Mechanism. Arm Pads, Buttons, and Mechanism Levers default to Lighter Beige. Caster selection will be finished Grey.
- When Clay (NH) Frame Finish is specified, defaults include PLASTIC BACK, 5-Point Base, Under Seat, Gas Cylinder, Arms, and Mechanism. Arm Pads, Buttons, and Mechanism Levers default to Lighter Beige. Caster selection will be finished Grey.
- Model ships fully assembled

N E S U
Essa Chair, Upholstered Back

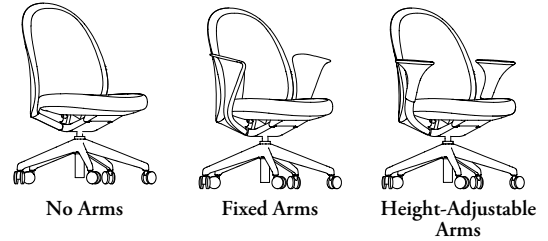

PRODUCT OPTIONS

Arm Style	Upholstery Style	Back Upholstery Finish	Seat Upholstery Finish	Cylinder Style	Frame Finish	Casters/Glides (Optional)
N No Arms	S Single Upholstery	Fabric	Fabric	1 Standard	8D Atrium White	Hard Casters
F Fixed Arms	D Dual Upholstery	Leather	Leather	2 High	NF Blackstone	A Soft Casters
H Height-Adjustable Arms					NH Clay	B Hard Glides C Soft Glides

SAMPLE ORDER CODE

NESU H	S	E523	E523	1	8D	A
---------------	----------	-------------	-------------	----------	-----------	----------

DESCRIPTION

BACK FABRIC

	Grade 1	COM/Grade 2	COL/Grade 3	Grade 4	Grade 5	Grade 6	Grade 7	Grade 8	Grade 9	Grade 10
No Arms (N)	1239	1292	1346	1397	1450	1503	1557	1611	1662	1716
Fixed Arms (F)	1364	1418	1471	1524	1578	1629	1682	1735	1790	1843
Height-Adjustable Arms (H)	1459	1510	1564	1617	1670	1724	1775	1828	1882	1935

BACK LEATHER

	Leather LA	Leather LB	Leather LC	Leathr LD
No Arms (N)	1790	1846	1897	1953
Fixed Arms (F)	1907	1966	2023	2073
Height-Adjustable Arms (H)	1938	2050	2103	2160

If Soft Casters (A) are specified	add	28
If Hard Glides (B) are specified	add	28
If Soft Glides (C) are specified	add	43
If Dual Upholstered (D) is specified	add	256

PRICE

marini overview

Marini is a high performance executive task chair designed with fine details and classic elegance.

Luxurious yet subtle in style, Marini is well suited for executive offices and boardrooms.

Marini – Synchro-Tilt Task Chair (NMAX)



statement of line

single upholstery

dual upholstery



High-Back –
Height and Width
Adjustable T-Arms
(NMAXW)



High-Back –
Height and Width
Adjustable T-Arms
(NMAXW)

marini dimensions & material requirements

features

- Designed and tested for users up to 300 lbs
- Meets ANSI/BIFMA Requirement

weight

Task Chair	51 lbs
------------	--------

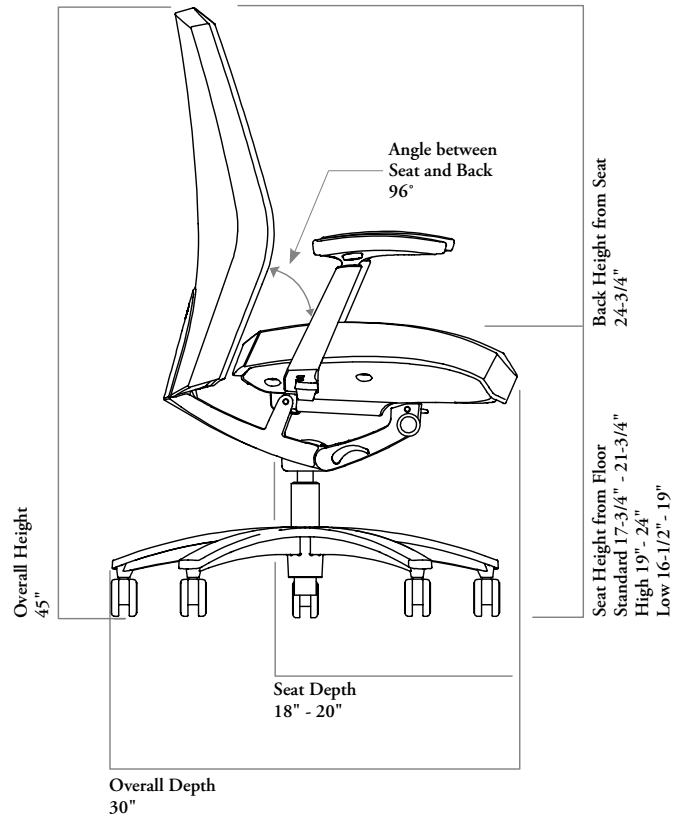
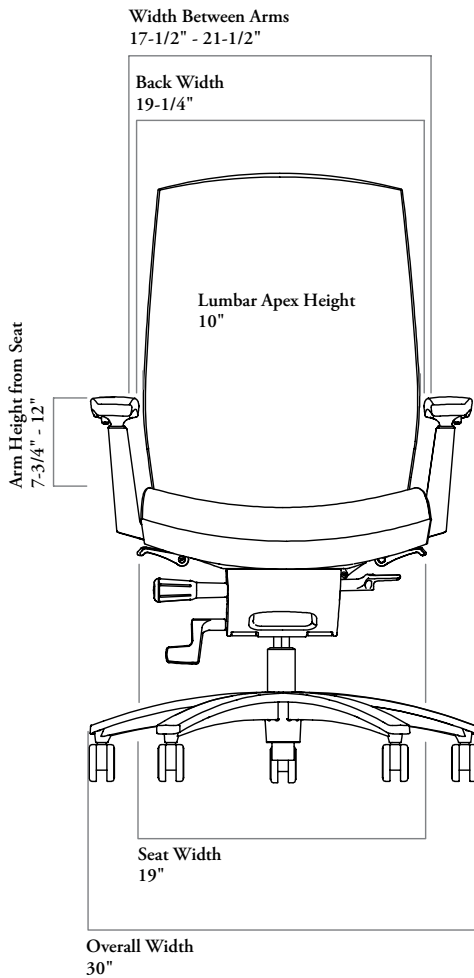

COM/COL material requirement

The pattern, repeat and directionality of fabric may increase the amount of yardage required.

Leather quantities should always be rounded up to the next hide size, as yields vary from 60-80% and are affected by the quality, size and shape of the hide, and by the location and quantity of blemishes.

	SINGLE UPHOLSTERED		DUAL UPHOLSTERED - SEAT		DUAL UPHOLSTERED - BACK	
	COM [yards]	COL [sq. ft]	COM [yards]	COL [sq. ft]	COM [yards]	COL [sq. ft]
High-Back	2	28	1	11	1	17

marini adjustment features & instructions

seat height-adjustment

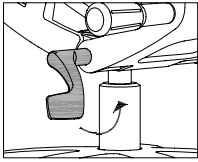

To raise the chair, lift the lever up while lifting your weight from the seat until you reach the desired level, then release to lock in place. To lower the chair, lift the lever up and allow your weight to push the seat down until you reach the desired level, then release to lock in place.

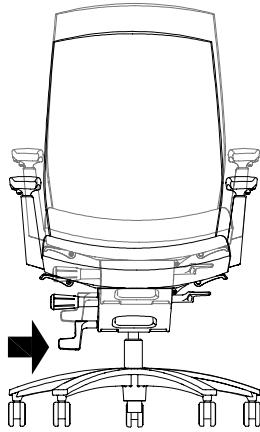

back tilt adjustment

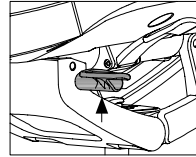

To adjust the angle of recline, push the lever down to unlock the back. Recline to the desired position and lift the lever up to lock in place or leave to allow backrest to recline freely.

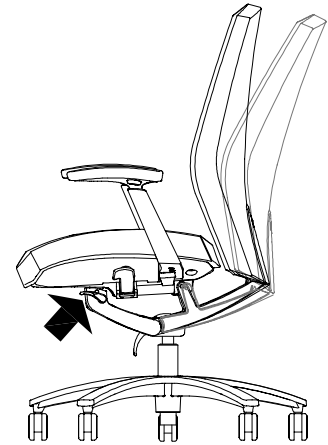

seat depth adjustment

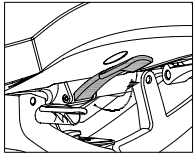

To adjust the seat depth, lift the lever up and simultaneously lift your weight from the seat while sliding the seat forward or backward. Release lever to lock the seat in place.

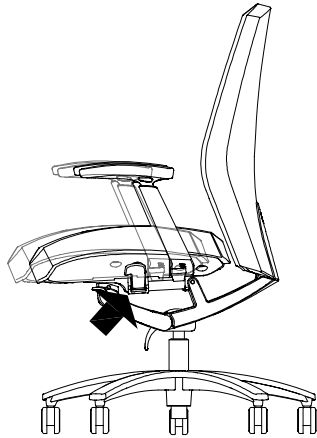

tilt tension adjustment

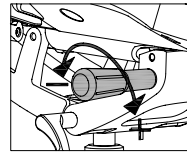

Leaning back, determine if the resistance of the chair is comfortable. For less resistance, pull tension adjustment knob out and turn it counter clockwise. For greater resistance, turn the knob clockwise.

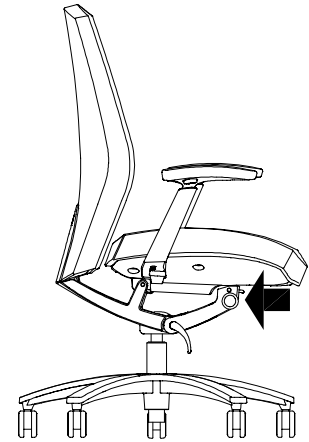

arm height-adjustment

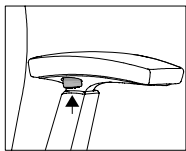

To adjust the arm height, press the button located under the armrest to raise or lower it to the desired position. Release the button to lock in place.

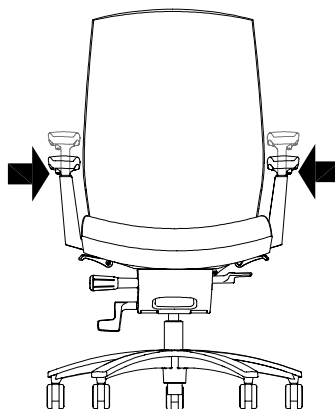

arm width adjustment

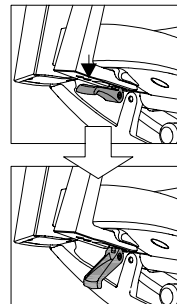

To adjust width of each arm, push the lever down and slide the arm to the desired position. Push the lever up to lock the arm in place.

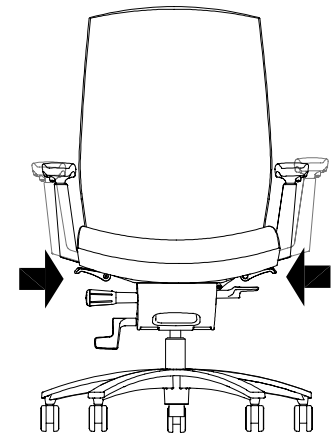

FEATURES

- Standard pneumatic cylinder provides height-adjustment of 4"
- Back-tilt can be locked in three positions or left free flow
- Frame and base is Aluminum
- Synchro-tilt 2:1 ratio
- Tension control
- Hard casters are standard and are well suited for soft flooring such as carpeting
- Soft casters are available for use on hard flooring, such as wood, concrete, or tile

N M A X
Marini – Synchro-Tilt Task Chair



NOTES

Single Upholstered: The same fabric is applied to the seat and back.

Dual Upholstered: Two different fabrics are applied to the chair, one fabric to the back and the other fabric to the seat. The first fabric listed will apply to the back and is the grade of fabric used to price the chair. A dual upholstery upcharge applies.

PRODUCT OPTIONS

Headrest	Back Style	Arm Style	Upholstery Style	Back Upholstery Finish	Cylinder Style	Frame and Base Finish	Casters/ Glides (Optional)
N No Headrest	H High Back	W Height and Width Adjustable T-Arms	S Single Upholstered D Dual Upholstered	Fabric Leather Seat Upholstery Finish (For Dual) Fabric Leather	1 Standard 2 High 3 Low	C9 Polished Aluminum	A Casters, Soft B Glides, Hard C Glides, Soft

SAMPLE ORDER CODE

NMAX N	H	W	D	M315	M309	1	C9	
--------	---	---	---	------	------	---	----	--

DESCRIPTION

PRICE

	Grade 1	COM/ Grade 2	COL/ Grade 3	Grade 4	Grade 5	Grade 6	Grade 7	Grade 8	Grade 9	Grade 10
Height and Width-Adjustable T-Arms	1808	1882	1950	2020	2086	2155	2227	2296	2362	2603
	Leather LA	Leather LB	Leather LC	Leather LD						
Height and Width-Adjustable T-Arms	2593	2720	3103	3234						

- If Dual Upholstered (D) is specified add 256
- If Polished Aluminum (C9) is specified add 81
- If Soft Casters (A) are specified add 28
- If Hard Glides (B) are specified add 28
- If Soft Glides (C) are specified add 43

nuova contessa overview

Nuova Contessa is a redesigned and enhanced version of Teknion’s classic Contessa task chair.

A refined aesthetic, advanced adjustment mechanisms, increased strength and durability deliver uncompromised comfort and performance for diverse body types.

Refinement of function, comfort and style.

Nuova Contessa – Synchro-Tilt Task Chair, Assembled, All Mesh (NCSA)



mesh finishes

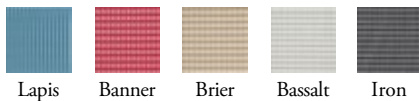

frame and base finishes

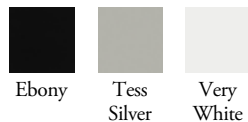

statement of line



nuova contessa overview (continued)

Nuova Contessa – Synchro-Tilt Task Chair, Assembled, Dual Upholstery (NCSM)



mesh finishes

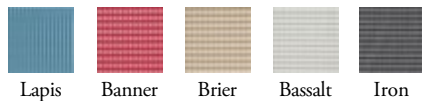

frame and base finishes

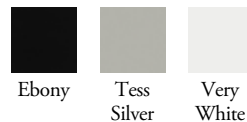

- Dual Upholstery
No Headrest,
Fixed Arms,
No Lumbar
(NCSMNFN)
- Dual Upholstery
No Headrest,
Fixed Arms,
With Lumbar
(NCSMNFY)
- Dual Upholstery
No Headrest,
4D Arms,
No Lumbar
(NCSMNPN)
- Dual Upholstery
No Headrest,
4D Arms,
With Lumbar
(NCSMNPY)
- Dual Upholstery
With Headrest,
Fixed Arms,
No Lumbar
(NCSMHFN)
- Dual Upholstery
With Headrest,
Fixed Arms,
With Lumbar
(NCSMHFY)
- Dual Upholstery
With Headrest,
4D Arms,
No Lumbar
(NCSMHPN)
- Dual Upholstery
With Headrest,
4D Arms,
With Lumbar
(NCSMHPY)

nuova contessa dimensions & material requirements

features

- Designed and tested for users up to 300 lbs
- Meets ANSI/BIFMA Requirement

weight

Task Chair No Headrest or Lumbar	47 lbs
Task Chair with Lumbar and Headrest	54 lbs

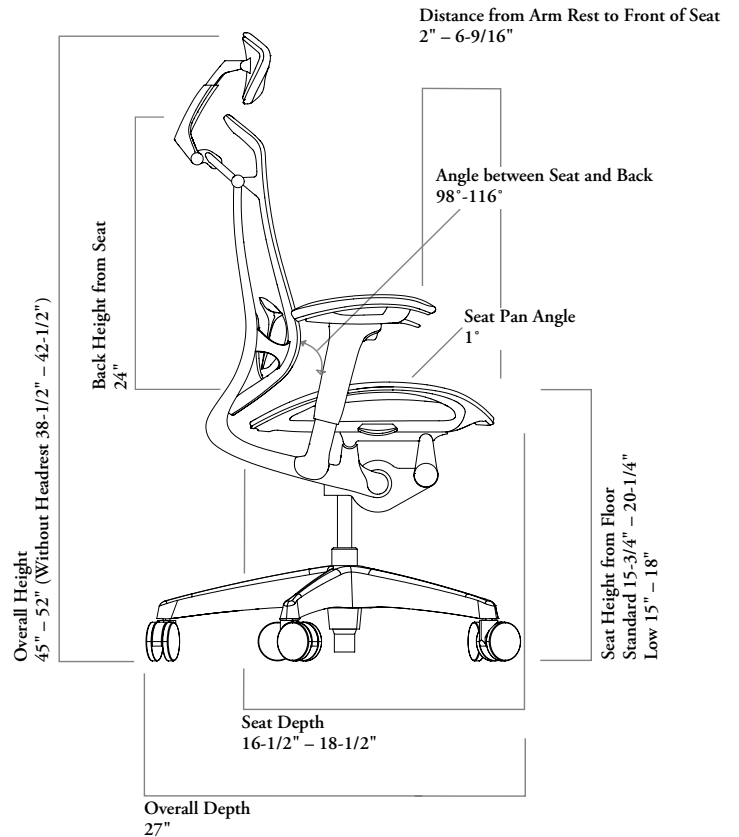
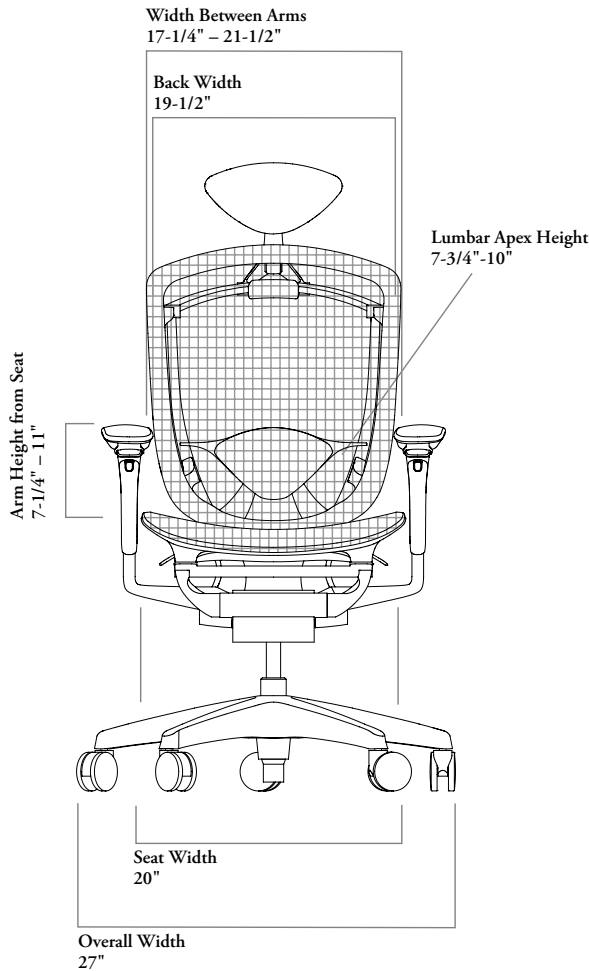

COM/COL material requirement

The pattern, repeat and directionality of fabric may increase the amount of yardage required.

Leather quantities should always be rounded up to the next hide size, as yields vary from 60-80% and are affected by the quality, size and shape of the hide, and by the location and quantity of blemishes.

DUAL UPHOLSTERED SEAT

COM [yards]	COL [sq. ft]
0.75	13.5

nuova contessa adjustment features & instructions

seat height-adjustment

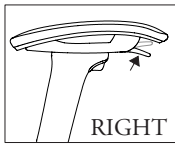

Seat height can be adjusted by lifting the lever at the front of the right armrest. When this lever is lifted, the weight of the body will cause the seat to lower, and releasing it stops the seat at the desired height. Lifting the lever with no weight on the seat allows it to rise.

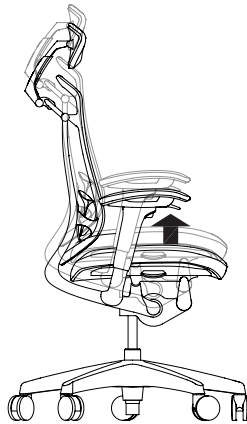

back tilt adjustment

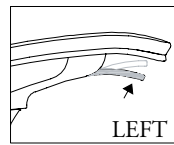

When the chair back is at the desired angle, press the lever once to lock it in position. Pressing the lever again frees the chair back.

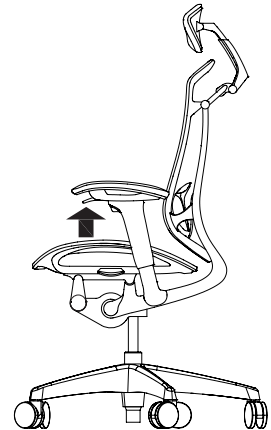

4D arm-width, depth, pivot and height-adjustment

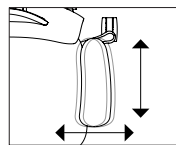
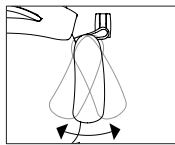

To adjust the width of the 4D arms, grab the arm pad on both sides and push to the left or to the right to the desired position.

Simultaneously pivot the arm pad inward or outward to the desired angle. Arm pad depth can be controlled by grabbing the pad and sliding it forward or backward.

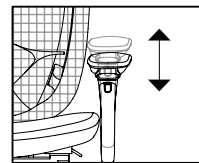
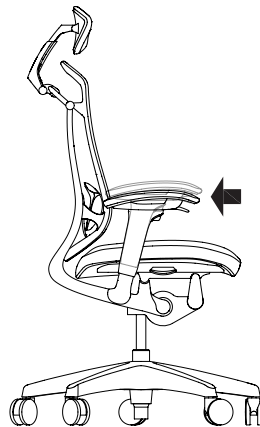

To adjust the arm height, press the button below either arm rest to raise or lower it to the desired position.

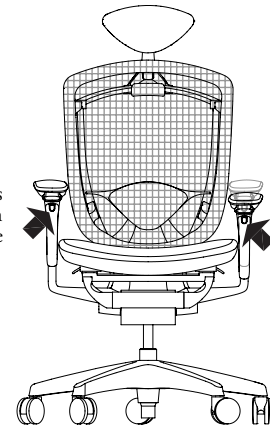

back tension adjustment

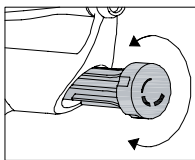

With an unlocked back setting, turn the dial found under the right side of the seat to adjust tension. This dial increases or reduces the resistance of the chair back while reclining. There are 1 - 4 settings, with 4 being the stiffest. Rotating this dial clockwise will reduce the tension and rotating the dial counterclockwise will increase the tension.

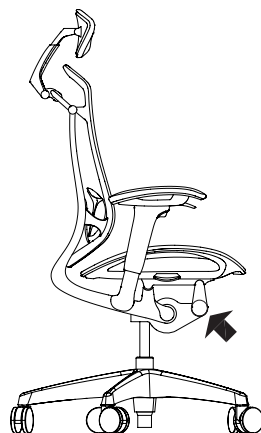

seat depth adjustment

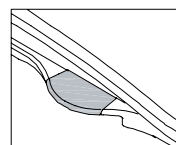

Lifting the slide levers under both sides of the seat allows it to be adjusted forwards and backwards.

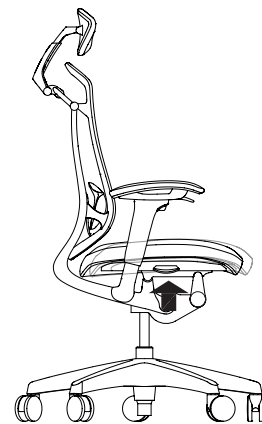

nuova contessa adjustment features & instructions (continued)

lumbar height-adjustment



The lumbar height-adjustment levers can be found on either side of the chair back frame.

The height of the lumbar support can be adjusted by sliding it up and down.

Lumbar responds uniquely to user's back curve depth and pressure.

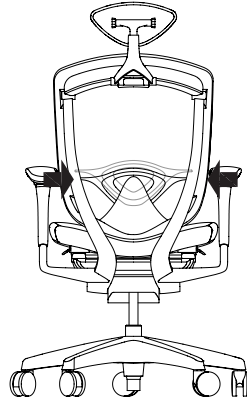

FEATURES

- Aluminum finish option, arm pads are Grey for durability
- Standard pneumatic cylinder provides height-adjustment of 4-1/2"
- Back-tilt can be locked in five positions or left free flow
- Seat depth adjustment of 2"
- Optional Lumbar Element has an apex height-adjustment of 2-1/4" and responds uniquely to user's back curve depth and pressure
- Frame and 5-Star Base are Aluminum
- Synchro-tilt 2.8:1 ratio and Tilt-Tension Control

NOTES

Headrest accessory must be installed on-site by customer.

Optional Headrest:

- Ebony Upholstered pad for Ebony frames
- Grey upholstered pad for Tess Silver and Very White plastic frames

Arm finish color corresponds with Body/Plastic finish color

- For Very White with Polished Aluminum finish option, arm pads are Grey for durability

Xpress NCSA

Nuova Contessa – Synchro-Tilt Task Chair, Assembled, All Mesh

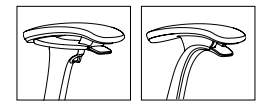

4D Arm

Fixed Arm

PRODUCT OPTIONS

Headrest	Arm Style	Lumbar Element	Back Finish (NuTess Mesh Back)	Cylinder Style	Frame and Base Finish	Casters
N No Headrest	F Fixed Arms	N No Lumbar Element	SB15 Iron	1 Standard	52 Ebony (Body finished in Ebony)	A Casters, Soft
H With Headrest	P 4D Arms	Y With Lumbar Element	SB16 Basalt SB19 Brier SB20 Banner SB21 Lapis	3 Low	99 Tess Silver (Body finished in Grey) C8 Very White with Polished Aluminum (Very White Plastic, Polished Aluminum Frame and Base) C9 Ebony with Polished Aluminum (Ebony plastic, Polished Aluminum Frame and Base)	

SAMPLE ORDER CODE

NCSA N	P	Y	SB15	1	52	A
---------------	----------	----------	-------------	----------	-----------	----------

DESCRIPTION

NO HEADREST (N)

	Ebony	Tess Silver	Very White with Polished Aluminum	Ebony with Polished Aluminum
Fixed Arms, No Lumbar	1901	1901	2140	2140
Fixed Arms, With Lumbar	1999	1999	2238	2238
4D Arms, No Lumbar	2038	2038	2279	2279
4D Arms, With Lumbar	2138	2138	2379	2379

WITH HEADREST (H)

Fixed Arms, No Lumbar	2140	2140	2381	2381
Fixed Arms, With Lumbar	2238	2238	2479	2479
4D Arms, No Lumbar	2279	2279	2521	2521
4D Arms, With Lumbar	2379	2379	2618	2618

If Soft Casters (A) are specified

add 27

N C S M **Xpress**

Nuova Contessa – Synchro-Tilt Task Chair, Assembled, Dual Upholstery

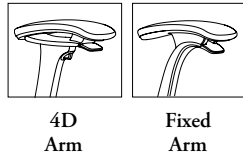

FEATURES

- Aluminum finish option, arm pads are Grey for durability
- Standard pneumatic cylinder provides height-adjustment of 4-1/2"
- Back-tilt can be locked in five positions or left free flow
- Seat depth adjustment of 2"
- Optional Lumbar Element has an apex height-adjustment of 2-1/4" and responds uniquely to user's back curve depth and pressure
- Frame and 5-Star Base are Aluminum
- Synchro-tilt 2.8:1 ratio and Tilt-Tension Control

NOTES

Headrest accessory must be installed on-site by costumer.

Optional Headrest:

- Ebony Upholstered pad for Ebony frames
- Grey upholstered pad for Tess Silver and Very White plastic frames

Arm finish color corresponds with Body/Plastic finish color

- For Very White with Polished Aluminum finish option, arm pads are Grey for durability

PRODUCT OPTIONS

Headrest	Arm Style	Lumbar Element	Back Finish (NuTess Mesh Back)	Seat Upholstery Finish	Cylinder Style	Finish	Casters
N No Headrest	F Fixed Arms	N No Lumbar Element	SB15 Iron	Fabric	1 Standard	52 Ebony (Body finished in Ebony)	A Casters, Soft
H With Headrest	P 4D Arms	Y With Lumbar Element	SB16 Basalt SB19 Brier SB20 Banner SB21 Lapis		3 Low	99 Tess Silver (Body finished in Grey) C8 Very White with Polished Aluminum (Very White Plastic, Polished Al Frame and Base) C9 Ebony with Polished Aluminum (Ebony Plastic, Polished Al Frames and Base)	

SAMPLE ORDER CODE

NCSM N	P	Y	SB15	E523	1	C9	A
---------------	----------	----------	-------------	-------------	----------	-----------	----------

See pricing on the following page.

Xpress N C S M

**Nuova Contessa – Synchro-Tilt
Task Chair, Assembled, Dual
Upholstery(Continued)**

DESCRIPTION	PRICE									
	Grade 1	COM/ Grade 2	COL/ Grade 3	Grade 4	Grade 5	Grade 6	Grade 7	Grade 8	Grade 9	Grade 10
NO HEADREST (N)										
Fixed Arms, No Lumbar	1901	1923	1950	1975	2001	2025	2052	2078	2100	2187
Fixed Arms, With Lumbar	1999	2023	2050	2073	2098	2122	2149	2175	2198	2286
4D Arms, No Lumbar	2038	2062	2089	2115	2140	2162	2189	2214	2239	2328
4D Arms, With Lumbar	2138	2160	2187	2212	2238	2262	2289	2314	2336	2424
	Leather LA	Leather LB	Leather LC	Leather LD						
Fixed Arms, No Lumbar	2187	2241	2406	2460						
Fixed Arms, With Lumbar	2286	2339	2502	2558						
4D Arms, No Lumbar	2328	2383	2543	2597						
4D Arms, With Lumbar	2424	2480	2642	2697						
WITH HEADREST (H)										
Fixed Arms, No Lumbar	2140	2162	2189	2214	2240	2264	2291	2317	2339	2428
Fixed Arms, With Lumbar	2238	2262	2289	2314	2337	2362	2388	2414	2438	2526
4D Arms, No Lumbar	2279	2304	2330	2356	2381	2406	2433	2456	2480	2567
4D Arms, With Lumbar	2379	2402	2428	2453	2479	2502	2529	2554	2579	2667
	Leather LA	Leather LB	Leather LC	Leather LD						
Fixed Arms, No Lumbar	2428	2482	2645	2699						
Fixed Arms, With Lumbar	2526	2582	2742	2797						
4D Arms, No Lumbar	2567	2622	2786	2839						
4D Arms, With Lumbar	2667	2719	2883	2938						
Ebony with Polished Aluminum (C9) is specified	add 239									
If Very White with Polished Aluminum (C8) is specified	add 239									
If Soft Casters (A) are specified	add 27									

N C A A Nuova Contessa – Accessories



Coat Hanger



Headrest

FEATURES

- Retrofitable on all Nuova Contessa Chairs
- Fixed Coat Hanger can also be used as a handle to move the chair
- The Nuova Contessa Accessories are not compatible with the original Contessa model
- Original Contessa Accessories (NCAY) are not compatible with the Nuova Contessa model

NOTES

Optional Headrest is finished with Ebony Upholstered pad for Ebony frames and Grey upholstered pad for Tess Silver and Very White plastic frame finishes.

Arm finish color corresponds with Body/Plastic finish color. For Very White with Polished.

Aluminum finish option, arm pads are Grey for durability.

Headrest accessory must be installed on-site by customer.

Coat Hanger and Headrest accessory can be used in conjunction.

PRODUCT OPTIONS

Style	Finish
1 Coat Hanger 2 Headrest	52 Ebony 30 Grey 8C Very White

SAMPLE ORDER CODE

NCAA 1	52
--------	----

PRICE

239

metric chair overview

Metric gives task seating fresh possibilities with a trio of upholstery concepts – single fabric, dual fabric and a mixed upholstery option. Unique to Metric, a double layer of cushioning allows for one fabric to be applied to the seat and inner back, and a second fabric to the seat underside and outer back.

This distinctive mixed upholstery option invites expressive combinations of color, pattern and texture to convey a message or create a mood.

Metric Chair, Single Upholstered (NMEU)



frame finish



Ebony

statement of line



Metric Chair,
Single Upholstered
(NMEU)



Metric Chair,
Dual Upholstered
(NMEUD)



Metric Chair,
Mixed (Outside Inside)
Upholstered
(NMEM)

metric dimensions & material requirements

features

- Designed and tested for users up to 300 lbs
- Meets ANSI/BIFMA Requirement

weight

Metric Chair	41 lbs
--------------	--------

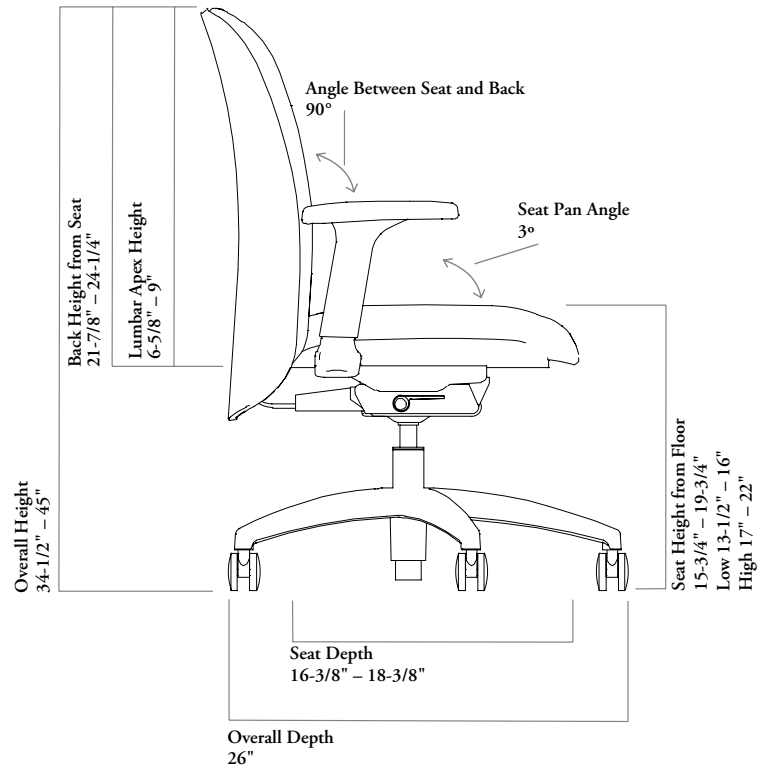
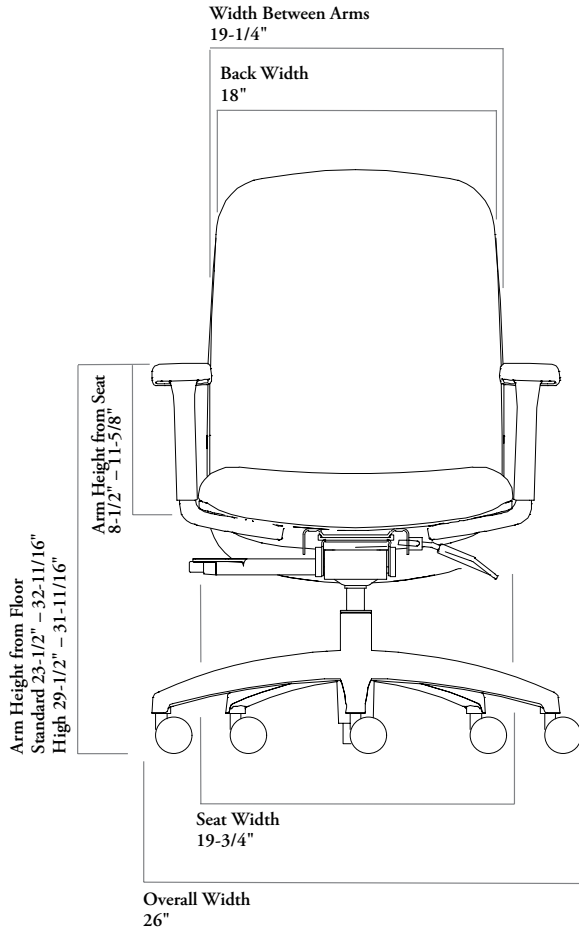

COM/COL material requirement

The pattern, repeat and directionality of fabric may increase the amount of yardage required.

Leather quantities should always be rounded up to the next hide size, as yields vary from 60-80% and are affected by the quality, size and shape of the hide, and by the location and quantity of blemishes.

	SINGLE UPHOLSTERED		DUAL UPHOLSTERED		MIXED UPHOLSTERED	
	COM [yards]	COL [sq. ft]	COM [yards]	COL [sq. ft]	COM [yards]	COL [sq. ft]
Single Upholstery	1.75	18.50				
Seat			0.75	8.00		
Back					1	10.50
Seat and Back Inner Upholstery					1	9.25
Seat and Back Outer Upholstery					1	9.25

metric chair adjustment features & instructions

seat height adjustment

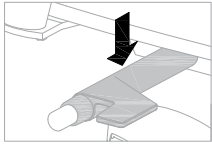

To raise the chair, push the lever down while lifting your weight from the seat until you reach the desired level, then release the lever to lock in place. To lower the chair, push the lever down and allow your weight to push the seat down until you reach the desired level, then release the lever to lock in place.

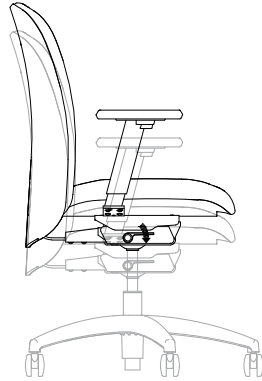

seat depth adjustment

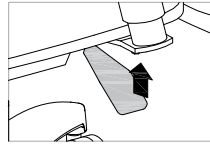

To adjust the seat depth, pull the lever up and simultaneously lift your weight from the seat while sliding the seat forward or backward. Release the lever to lock the seat in place.

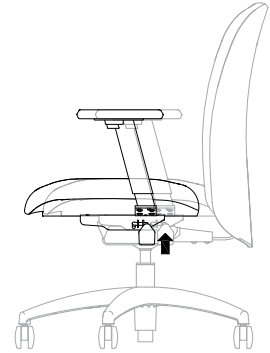

back tilt lock adjustment

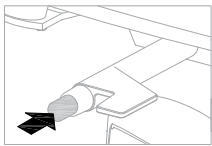

To adjust the angle of recline, push the button to unlock the back and leave the chair in free flow mode. Recline to the desired position and push the lever down to lock the back in place.

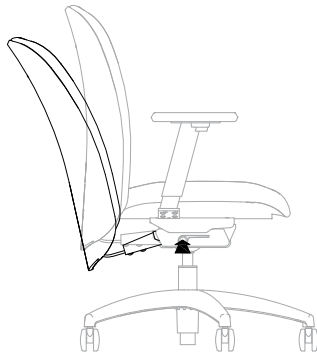

lumbar height adjustment

The back height-adjustment is activated by the chair's back. To adjust the lumbar height, lean forward and grasp both sides of the lower portion of the outside back. To raise, slide the back up. To lower, slide the back all the way to the top and then lower it to the bottom. To raise, slide the back up. Release to lock in place.

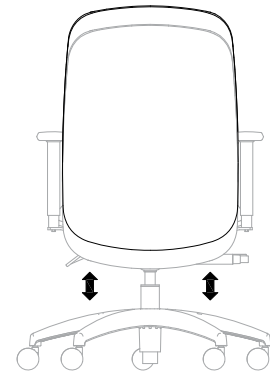

arm height adjustment

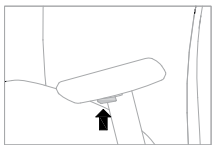

To adjust arm height, press the button underneath the armpad to raise or lower the armrest to the desired position. Release the button to lock in place.

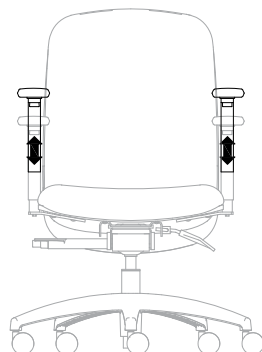

work chairs

N M E U Metric Chair



Metric Chair,
Single Upholstered



Metric Chair,
Dual Upholstered

FEATURES

- The Single Upholstered has all one fabric
- The Dual Upholstered has one fabric on the back and a different fabric on the seat
- Height-Adjustable Arms
- Synchro tilt ratio 1:4.6
- 3 cylinder options to provide height adjustment of high 5", standard 4" or low 3"
- Back height adjustment of 2-1/2"
- Seat depth adjustment of 2"
- 60mm hard/soft casters
- Designed and tested for users up to 300 lbs
- Item can be ordered Fully Assembled or Assembly Required

PRODUCT OPTIONS

Arm Style	Upholstery Style	Upholstery Finish	Seat Depth Adjustment	Cylinder Style	Casters/ Slides	Seat Assembly Style
W Height-Adjustable Arms	S Single D Dual Upholstered	Fabric	S With Seat Depth Adjustment	1 Standard 2 High 3 Low	Hard Casters A Soft Casters B Hard Glides C Soft Glides	K Assembly Required F Fully Assembled

SAMPLE ORDER CODE

NMEU W	S	E523	S	1	A	K
---------------	----------	-------------	----------	----------	----------	----------

PRICE

SINGLE UPHOLSTERY (S)

Grade 1	COM/ Grade 2	COL/ Grade 3	Grade 4	Grade 5	Grade 6	Grade 7	Grade 8	Grade 9	Grade 10
920	979	1037	1095	1154	1212	1270	1328	1387	1445

DUAL UPHOLSTERY (D)

Grade 1	COM/ Grade 2	COL/ Grade 3	Grade 4	Grade 5	Grade 6	Grade 7	Grade 8	Grade 9	Grade 10
1119	1177	1237	1295	1353	1412	1470	1528	1587	1645

If soft casters (A) are specified,	add 28
If hard glides (B) are specified,	add 28
If soft glides (C) are specified,	add 43
If fully assembled (F) is specified,	add 158
If dual upholstery (D) is specified,	add 256

FEATURES

- The Mixed Upholstered has one fabric on the outside back and seat bottom and another fabric on the inside back and seat
- Height-Adjustable Arms
- Synchro tilt ratio 1:4.6
- 3 cylinders options to provide height adjustment of high 5", standard 4" or low 3"
- Back height adjustment of 2-1/2"
- 3" Seat Depth
- 60mm hard/soft casters
- Designed and tested for users up to 300 lbs
- Item can be ordered Fully Assembled or Assembly Required

N M E M
Metric Chair, Mixed
(Outside Inside) Upholstered



PRODUCT OPTIONS

Arm Style	Upholstery Style	Outside Upholstery Finish	Inside Upholstery Finish	Seat Depth Adjustment	Cylinder Style	Casters / Slides	Seat Assembly Style
W Height-Adjustable Arms	M Mixed (Outside Inside)	Fabric	Fabric	S With Seat Depth Adjustment	1 Standard 2 High 3 Low	Hard Casters A Soft Casters B Hard Glides C Soft Glides	K Assembly Required F Fully Assembled

SAMPLE ORDER CODE

NMEM W	M	E523	E524	S	1	A	K
---------------	----------	-------------	-------------	----------	----------	----------	----------

PRICE

MIXED (OUTSIDE INSIDE) UPHOLSTERY (M)

	COM/ Grade 1	COL/ Grade 2	Grade 3	Grade 4	Grade 5	Grade 6	Grade 7	Grade 8	Grade 9	Grade 10
	1119	1186	1253	1319	1385	1450	1518	1583	1650	1716

- If soft casters (A) are specified, add 28
- If hard glides (B) are specified, add 28
- If soft glides (C) are specified, add 43
- If fully assembled (F) is specified, add 158

projek overview

Projek is smart, simple seating designed for today's workplace where shared workspaces are increasingly common.

Projek has a clean and unassuming look that allows for visual fit in varied office settings.

It offers a fresh take on finishes and aesthetics, with the ability to mix and match finishes for each part of the chair.

Projek is available in a task chair and a swivel stool.

Projek – Synchro-Tilt Task Chair (NPRT) (shown)



statement of line

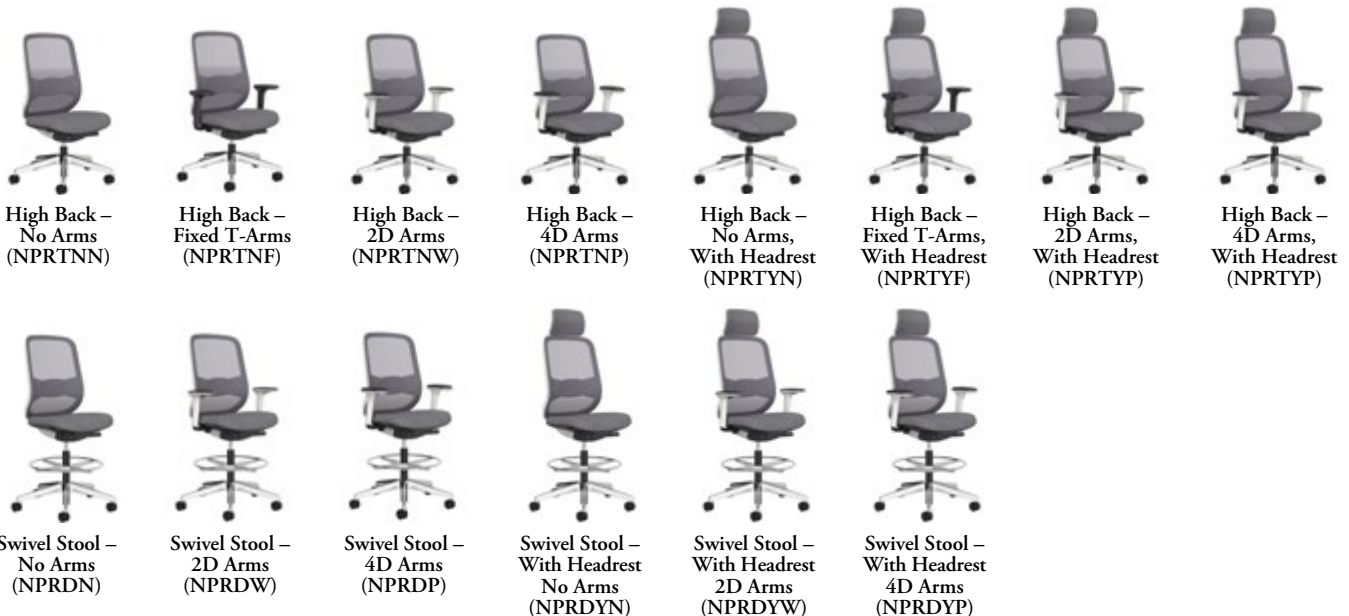

projek dimensions & material requirements

features

- Designed and tested for users up to 300 lbs
- Meets ANSI/BIFMA Requirement

weight

General Use/Executive Task	35 lbs
Swivel Stool	41.8 lbs

Task Chair

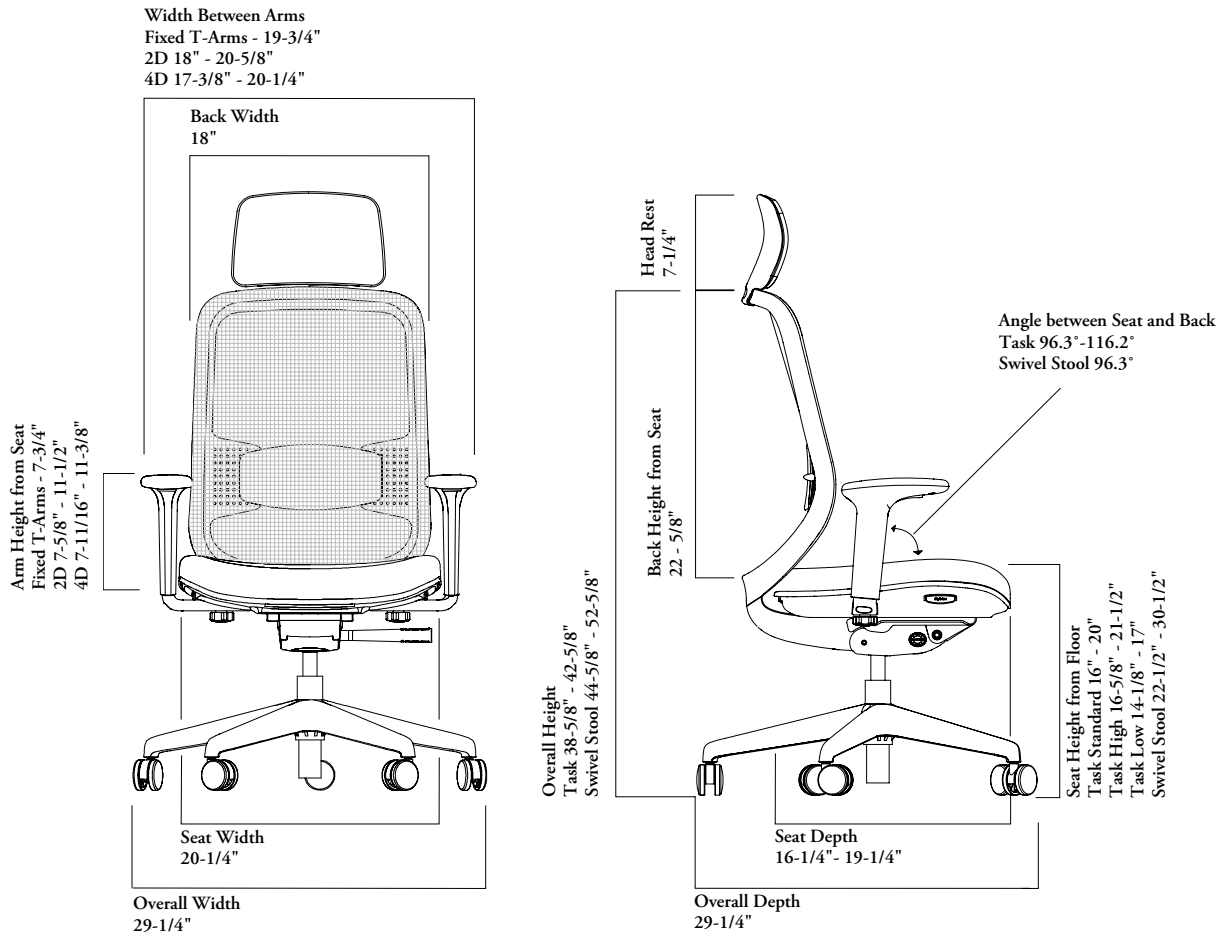

COM/COL material requirement

The pattern, repeat and directionality of fabric may increase the amount of yardage required.

Leather quantities should always be rounded up to the next hide size, as yields vary from 60-80% and are affected by the quality, size and shape of the hide, and by the location and quantity of blemishes.

	DUAL UPHOLSTERED	
	COM [yards]	COL [sq. ft]
Seat	0.875	8.75
Headrest	0.5	4.875

projek adjustment features & instruction

seat height-adjustment

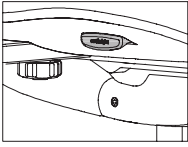

Seat height can be adjusted by pulling outward on the button below the seat on the right hand side. When this button pulled, the weight of the body will cause the seat to lower, and releasing it stops the seat at the desired height. Pulling outward on the button with no weight on the seat allows it to rise.

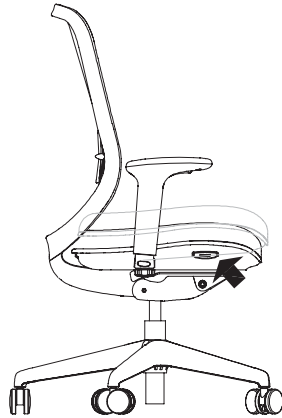

seat depth adjustment

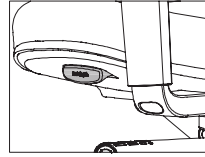

To adjust the seat depth, pull outward on the button below the seat on the left-hand side and simultaneously lift your weight from the seat while sliding the seat forward or backward. Release button to lock the seat in place.

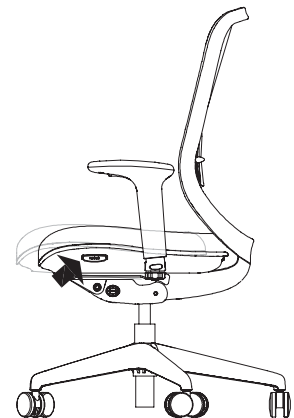

4D arm pivot adjustment

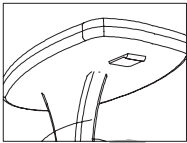

To pivot the arm cap, depress the auto safety lock button on the outside of the armrest and pivot 210° degrees to desired position. Release the button to lock in place. 180° arm rotation adjusts the arm depth.

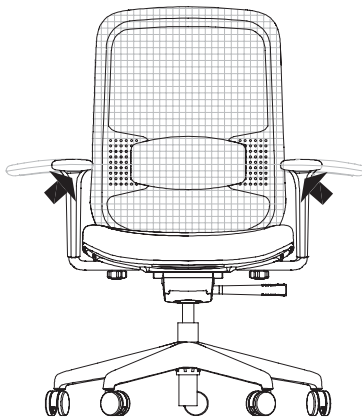

arm height-adjustment

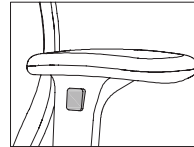

To adjust the arm height, press the button below either arm rest to raise or lower it to the desired position. Release the button to lock in place.

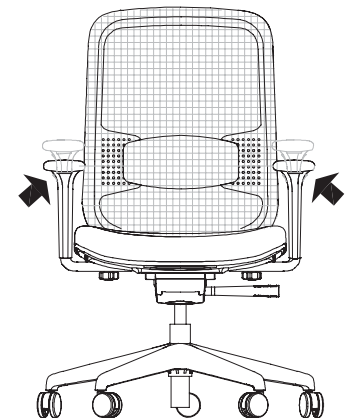

back tilt adjustment

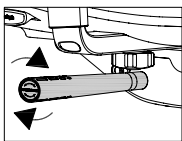

Turning the grip found under the left side of the seat limits the back tilt travel and locks the back. Travel is limited on 3 positions with back lock in the upright position.



tilt tension adjustment

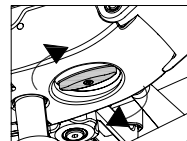

Fine tune the weight balanced tension by rotating the dial located below the seat center to suit personal preference.

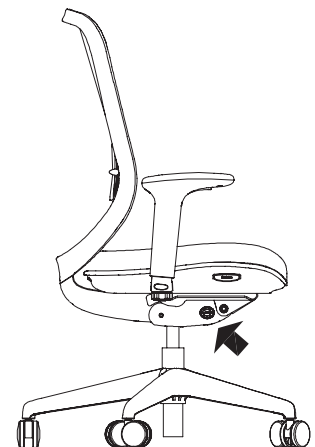

projek adjustment features & instruction (continued)

lumbar height-adjustment

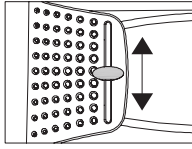

The lumbar height-adjustment knobs can be found on the back where the Inner Frame connects to the Lumbar Element.

The height of the lumbar support can be adjusted by sliding them up and down.



arm width adjustment

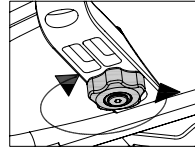

To adjust the width of each arm, turn the dial clockwise to release the arm lock. Slide the arm inward or outward to the desired position. Tighten the knob to lock the arm in place.

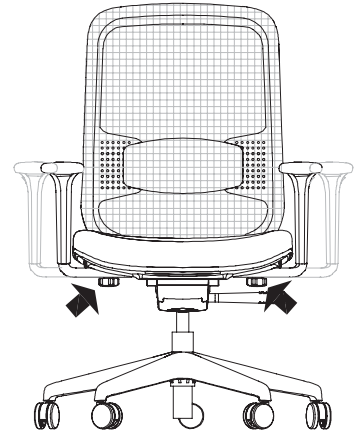

stool foot ring height

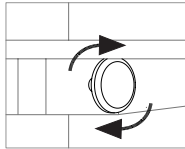

To raise or lower the stool's foot ring, turn the foot ring's knob counter clockwise to release the foot ring and adjust the ring until you reach the desired level. Turn the knob clockwise to lock in place.

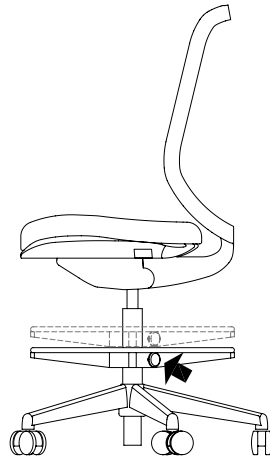

work chairs

Xpress

N P R T

Projek – Synchro-Tilt Task Chair

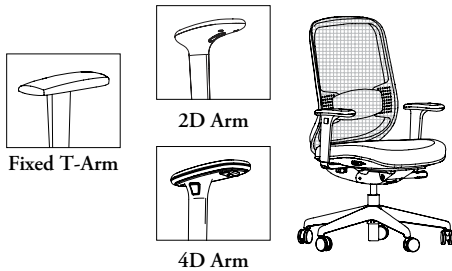

FEATURES

- Standard pneumatic cylinder provides height-adjustment of 4"
- Seat depth adjustment of 3" and Lumbar height-adjustment of 4"
- Back tilt can be locked in the upright position or left to free flow to 3 defined angle ranges
- Weight-balancing with a travel limiter synchro-tilt mechanism (3.5:1 tilt ratio) with unique preference control to tilt tension. Back recline angle range is 0° - 20° and seat adjustment range angle is 0° - 6.5°
- Ebony base is available in plastic only
- Hard casters are standard and are well suited for soft flooring such as carpeting
- Soft casters are available for use on hard flooring, such as wood, concrete or tile
- Headrest option is only available on Fully Assembled style

NOTES

Headrest's frame and fabric finishes default to Outer Frame Finish and Seat fabric finish.

2D and 4D Arm finish defaults to the Outer Frame Finish. For Very White the arm rest will be finished same as outer frame. Arm Rest Pad and Arm Support finished in Ebony. Fixed Arm is available in Ebony only

Projek Chair is Dual Upholstery with Shrinx Mesh available on the back only and Teknion's Standard and Graded-In-Fabrics on seat. See Projek Finish Guide to define Plastic Outer Frame, Plastic Inner Frame and Lumbar Element finish details.

Not all configurations are available in the Xpress program.

Assembly Required (K) is further knocked-down and customer is responsible for assembly.

PRODUCT OPTIONS

Headrest	Arm Style	Shrinx Mesh Back	Seat Upholstery Finish	Cylinder Style	Plastic Outer Frame Finish	Plastic Inner Frame Finish	Plastic Lumbar Element Finish	Base Finish	Casters/Glides (Optional)	Assembly Style
N No Headrest Y With Headrest	N No Arms	S2 Ebony Original	Fabric Leather	1 Standard 2 High 3 Low	8B Ebony 8C Very White	8B Ebony 8C Very White	8B Ebony 8C Very White	52 Ebony C9 Polished Aluminum	A Casters, Soft B Glides, Hard C Glides, Soft	F Fully Assembled
	F Fixed T-Arms	S4 Veil Noir								N Not Fully Assembled
	W 2D Width and Height-Adjustable T-Arms	S5 Veil Blanc S6 Veil Grau								K Assembly Required
	P 4D Width and Height-Adjustable T-Arms with Pivot Arm Cap	F1 Fleck Charcoal F2 Fleck Smoke F3 Fleck Dune F4 Fleck Peat								

SAMPLE ORDER CODE

NPRT N	N	S2	L207	1	8C	8B	8B	52	A	F
---------------	----------	-----------	-------------	----------	-----------	-----------	-----------	-----------	----------	----------

DESCRIPTION

NO HEADREST (N)

	Grade 1	COM/ Grade 2	COL/ Grade 3	Grade 4	Grade 5	Grade 6	Grade 7	Grade 8	Grade 9	Grade 10
No Arms	1039	1067	1094	1122	1150	1176	1206	1234	1260	1354
Fixed Arms	1154	1183	1210	1238	1266	1292	1321	1348	1373	1470
2D Width, Height-Adjustable T-Arms	1190	1217	1245	1273	1299	1327	1357	1383	1409	1503
4D Width, Height-Adjustable T-Arms with Pivot Arm Cap	1264	1291	1319	1347	1373	1401	1430	1453	1480	1578
	Leather LA	Leather LB	Leather LC	Leather LD						
No Arms	1275	1314	1420	1455						
Fixed Arms	1391	1426	1535	1571						
2D Width, Height-Adjustable T-Arms	1426	1464	1571	1608						
4D Width, Height-Adjustable T-Arms with Pivot Arm Cap	1499	1535	1645	1680						

If Headrest (Y) is specified	add 172
If Polished Aluminum (C9) Base is specified	add 80
If Soft Casters (A) are specified	add 28
If Hard Glides (B) are specified	add 28
If Soft Glides (C) are specified	add 43
If Fully Assembled (F) is specified	add 0

FEATURES

- Standard pneumatic cylinder provides height-adjustment of 8"
- Swivels 360°
- Includes Chrome footring
- Seat depth adjustment of 3"
- Lumbar height-adjustment of 4"
- Ebony base is available in plastic only
- Hard casters are standard and are well suited for soft flooring such as carpeting
- Soft casters are available for use on hard flooring, such as wood, concrete or tile

**N P R D
Projek – Swivel Stool**



NOTES

Headrest's frame and fabric finishes default to Outer Frame Finish and Seat fabric finish. 2D and 4D Arm finish defaults to the Outer Frame Finish. For Very White the arm rest will be finished same as outer frame. Arm Rest Pad and Arm Support finished in Ebony. Fixed Arm is available in Ebony only

Projek Chair is Dual Upholstery with Shrinx Mesh available on the back only and Teknion's Standard and Graded-In-Fabrics on seat.

See Projek Finish Guide to define Plastic Outer Frame, Plastic Inner Frame and Lumbar Element finish details.

When Headrest + accessory is specified, Stool ships Not Fully Assembled and must be assembled by customer on-site.

PRODUCT OPTIONS

Headrest	Arm Style	Shrinx Mesh Back	Seat Upholstery Finish	Plastic Outer Frame Finish	Plastic Lumbar Element Finish	Base Finish	Casters/Glides (Optional)
N No Headrest	N No Arms	S2 Ebony Original	Fabric	8B Ebony	8B Ebony	52 Ebony	Casters, Hard
Y With Headrest	W 2D Width and Height-Adjustable T-Arms	S4 Veil Noir	Leather	8C Very White	8C Very White	C9 Polished Aluminum	A Casters, Soft
		S5 Veil Blanc					
Y With Headrest	P 4D Width and Height-Adjustable T-Arms with Pivot Arm Cap	S6 Veil Grau	Leather	8C Very White	8C Very White	C9 Polished Aluminum	A Casters, Soft
		F1 Fleck Charcoal					
		F2 Fleck Smoke					
		F3 Fleck Dune					
Y With Headrest	P 4D Width and Height-Adjustable T-Arms with Pivot Arm Cap	F4 Fleck Peat	Leather	8C Very White	8C Very White	C9 Polished Aluminum	A Casters, Soft

SAMPLE ORDER CODE

NPRD N	N	S2	L207		8B	52	A
---------------	----------	-----------	-------------	--	-----------	-----------	----------

DESCRIPTION

PRICE

NO HEADREST (N)	COM/		COL/		Grade 4	Grade 5	Grade 6	Grade 7	Grade 8	Grade 9	Grade 10
	Grade 1	Grade 2	Grade 3	Grade 3							
No Arms	1114	1141	1168	1196	1224	1248	1277	1304	1329	1426	
2D Width, Height-Adjustable T-Arms	1335	1363	1391	1418	1445	1473	1501	1528	1554	1650	
4D Width, Height-Adjustable T-Arms with Pivot Arm Cap	1264	1291	1319	1347	1373	1401	1430	1453	1480	1578	
	Leather LA	Leather LB	Leather LC	Leather LD							
No Arms	1426	1453	1494	1529							
2D Width, Height-Adjustable T-Arms	1650	1679	1717	1750							
4D Width, Height-Adjustable T-Arms with Pivot Arm Cap	1578	1607	1645	167							

If Headrest (Y) is specified add 172
 If Polished Aluminum (C9) Base is specified add 80
 If Soft Casters (A) are specified add 28

sabrina overview

Sabrina is an infinitely classic, yet modern, mesh back task chair.

Visually sculptural in frame and profile, Sabrina features an innovative ack rung structure symbolizing the interconnection of comfort and design.

Sabrina's design incorporates a ring-shaped backrest for both fix and flex comfort and an inner ring provides support and backwards bending body's natural position, while the outer frame gently twists to either side for extra flexing.

Sabrina – Synchro-Tilt Task Chair (NSBYNYA)



statement of line



No Headrest –
No Coat Hanger,
No Arms,
No Lumbar
(NSBYNNN)



No Headrest –
No Coat Hanger,
Fixed Polished
Aluminum Arms,
No Lumbar
(NSBYNNA)



No Headrest –
No Coat Hanger,
Height-Adjustable
T-Arms,
No Lumbar
(NSBYNNH)



No Headrest –
No Coat Hanger,
No Arms,
Lumbar
(NSBYNYN)



No Headrest –
No Coat Hanger,
Fixed Polished
Aluminum Arms,
Lumbar
(NSBYNYA)



No Headrest –
No Coat Hanger,
Height-Adjustable
T-Arms,
Lumbar
(NSBYNYH)



No Headrest –
Coat Hanger,
No Arms,
No Lumbar
(NSBYCNN)



No Headrest –
Coat Hanger,
Height-Adjustable
T-Arms,
No Lumbar
(NSBYCNH)



No Headrest –
Coat Hanger,
Fixed Polished
Aluminum Arms,
No Lumbar
(NSBYCNN)



No Headrest –
Coat Hanger,
No Arms,
Lumbar
(NSBYNYN)



No Headrest –
Coat Hanger,
Height-Adjustable
T-Arms,
Lumbar
(NSBYNYH)



No Headrest –
Coat Hanger,
Fixed Polished
Aluminum Arms,
Lumbar
(NSBYNYA)

sabrina overview (continued)

Sabrina – Synchro-Tilt Task Chair (NSBYYYA)



- Arm Styles:
 - No arm
 - Fixed Polished Aluminum arm with plastic arm pad
 - Height-Adjustable T-Arm with arm pad
- T-Arm Adjustment:
 - 20" inward and outward
 - Forward and backward slide
- Seat Depth Adjustment: 2"
- Seat Depth Adjustment: 2"
- Reclining Tension Adjustment

statement of line



sabrina overview (continued)

Sabrina – Swivel Stool (NSBDCYA)



statement of line



No Headrest,
No Coat Hanger,
No Arms,
No Lumbar
(NSBDNNN)



No Headrest,
No Coat Hanger,
Fixed Polished
Aluminum Arms,
No Lumbar
(NSBYHNA)



No Headrest,
No Coat Hanger,
Height-Adjustable
T-Arms,
No Lumbar
(NSBDNNH)



No Headrest,
No Coat Hanger,
No Arms,
Lumbar
(NSBDNYN)



No Headrest,
No Coat Hanger,
Fixed Polished
Aluminum Arms,
Lumbar
(NSBDNYA)



No Headrest,
No Coat Hanger,
Height-Adjustable
T-Arms,
Lumbar
(NSBDNYH)



No Headrest,
With Coat
Hanger,
No Arms,
No Lumbar
(NSBDCYNN)



No Headrest,
With Coat
Hanger,
Fixed Polished
Aluminum Arms,
No Lumbar
(NSBDCNA)



No Headrest,
With Coat
Hanger,
Height-Adjustable
T-Arms,
No Lumbar
(NSBDCNH)



No Headrest,
With Coat
Hanger,
No Arms,
Lumbar
(NSBDCYN)



No Headrest,
With Coat
Hanger,
Fixed Polished
Aluminum Arms,
Lumbar
(NSBDCYA)



No Headrest,
With Coat
Hanger,
Height-Adjustable
T-Arms,
Lumbar
(NSBDCYH)

sabrina overview (continued)

Sabrina – Swivel Stool (NSBDCYA)



Arm Styles:
 - No arm
 - Fixed Polished Aluminum arm with plastic arm pad
 - Height-Adjustable T-Arm with arm pad

T-Arm Adjustment:
 - 20" inward and outward
 - Forward and backward slide

Seat Depth Adjustment: 2"
 Seat Depth Adjustment: 2"

Reclining Tension Adjustment

statement of line



sabrina dimensions & material requirements

features

- Designed and tested for users up to 300 lbs
- Meets ANSI/BIFMA Requirement

weight

Task Chair with Headrest	42 lbs
Task Chair no Headrest	41 lbs

Task Chair

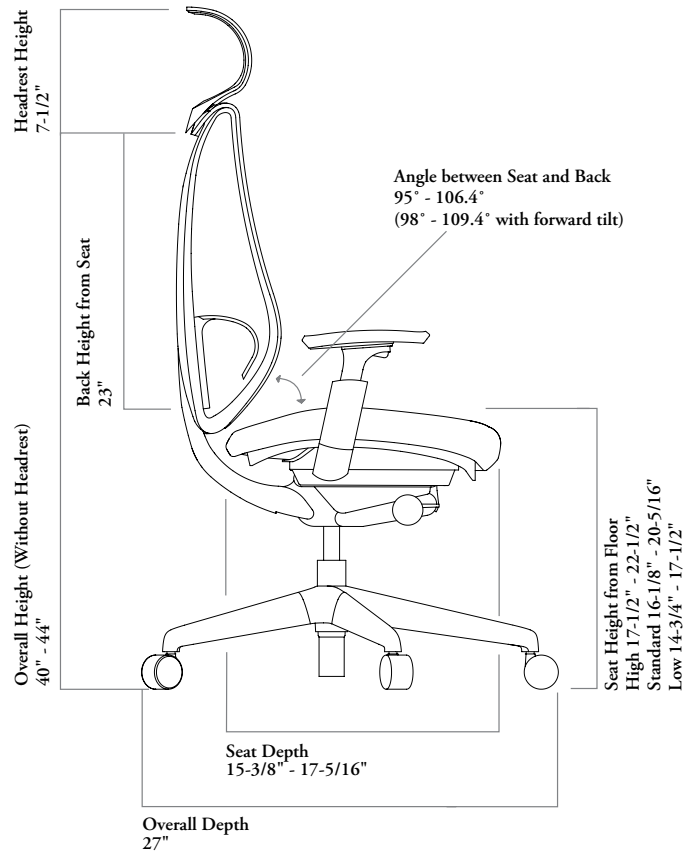
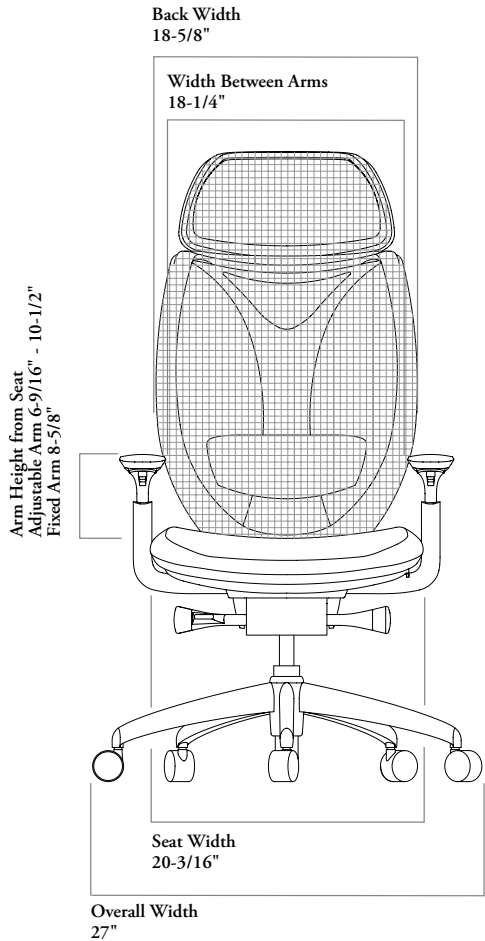

COM/COL material requirement

The pattern, repeat and directionality of fabric may increase the amount of yardage required.

Leather quantities should always be rounded up to the next hide size, as yields vary from 60-80% and are affected by the quality, size and shape of the hide, and by the location and quantity of blemishes.

DUAL UPHOLSTERED

	COM [yards]	COL [sq. ft]
Seat only	0.875	8.75

sabrina dimensions & material requirements (continued)

features

- Designed and tested for users up to 300 lbs
- Meets ANSI/BIFMA Requirement

weight

Swivel Stool with Headrest	41 - 45.5 lbs
Swivel Stool no Headrest	40 - 44.5lbs

Swivel Stool

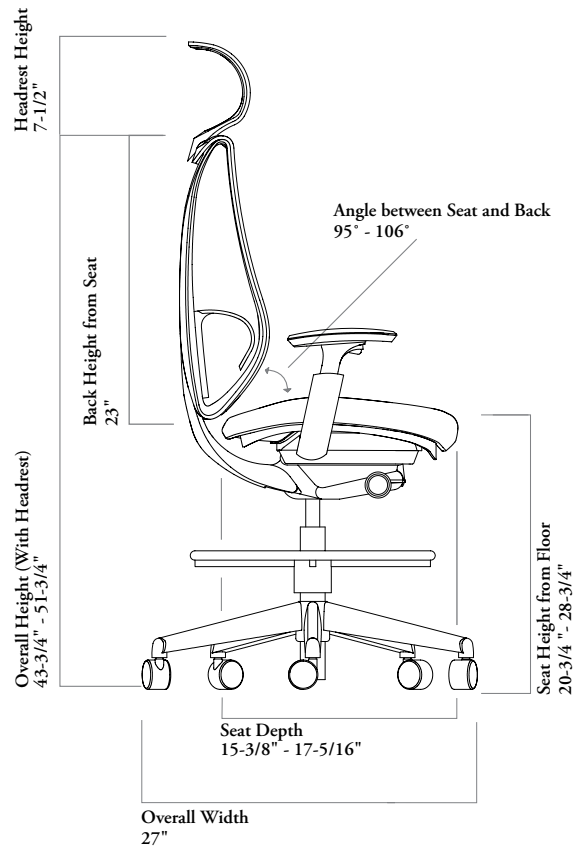
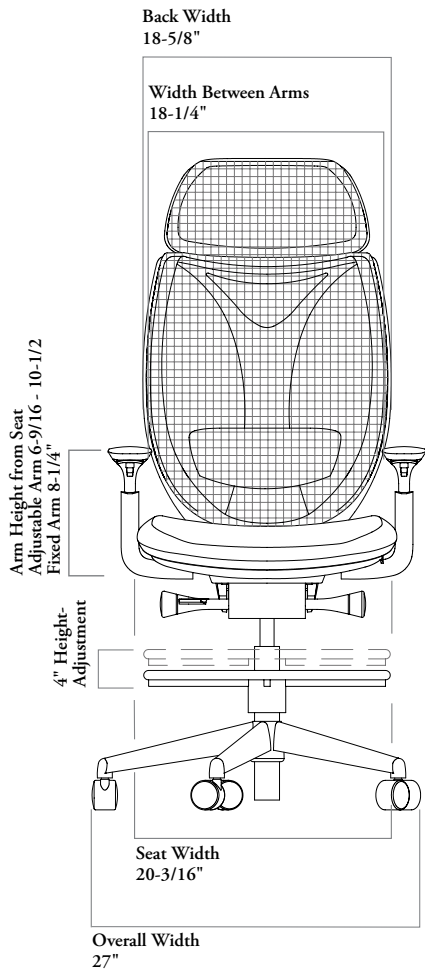

COM/COL material requirement

The pattern, repeat and directionality of fabric may increase the amount of yardage required.

Leather quantities should always be rounded up to the next hide size, as yields vary from 60-80% and are affected by the quality, size and shape of the hide, and by the location and quantity of blemishes.

DUAL UPHOLSTERED

	COM [yards]	COL [sq. ft]
Seat only	0.875	8.75

sabrina adjustment features & instructions

reclining tension adjustment

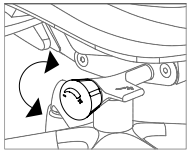

Turning the grip found under the right side of the seat increases or reduces the resistance of the chair back while reclining and forward-tilt when specified. Rotate forward to tighten and backwards to loosen.

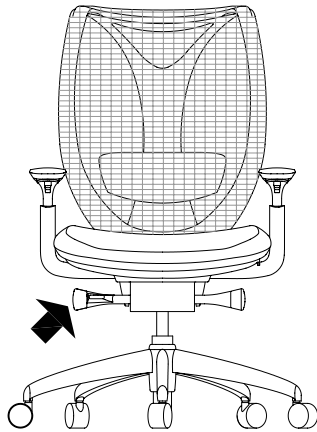

tilt lock and limiter

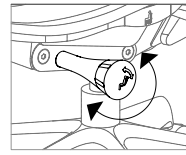

Turning the grip found under the left side of the seat locks and unlocks the recline and forward-tilt seat, when specified. Rotate forward to unlock and backward to lock. Unlock, completely recline and return to an upright to re-set.

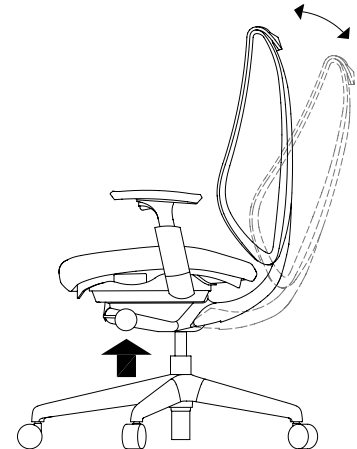

arm height-adjustment

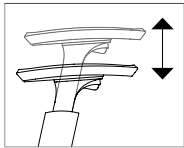

To adjust the height-adjustable arm height, press the button below either arm rest to raise or lower it to the desired position.

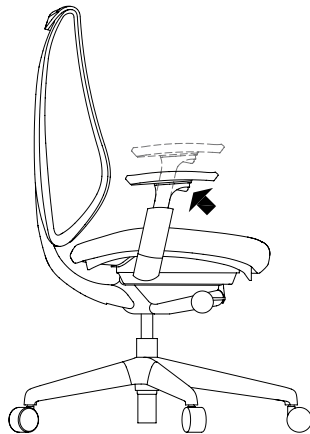

arm pad adjustment

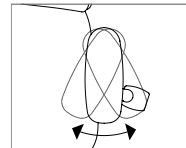
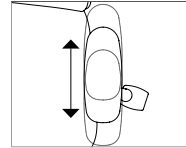

While sitting in the chair, grab the height-adjustable arm pad from the top and slide it away from your body, along the length of the arm cap, or towards you to match your physical requirements. Once positioned, rotate the arm pad angle toward your body or away from you to match your physical requirements.

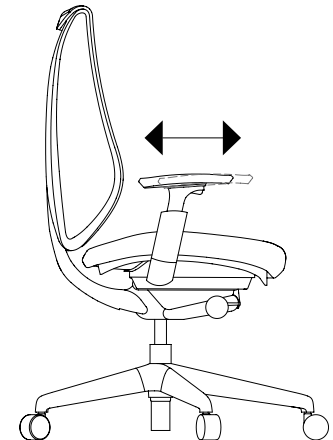

lumbar support

While sitting in the chair, put arms behind back to grab both sides of lumbar element, slide lumbar up or down to match your physical requirements.

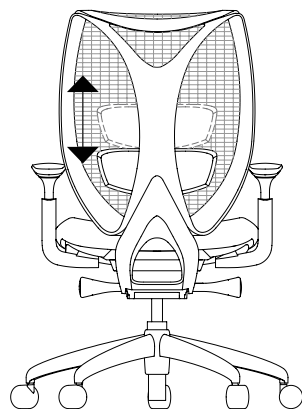

seat depth adjustment

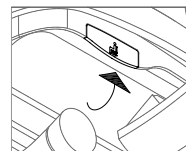

To adjust the seat depth, pull outward on the button below the seat on the left-hand side and simultaneously lift your weight from the seat while sliding the seat forward or backward. Release button to lock the seat in place.

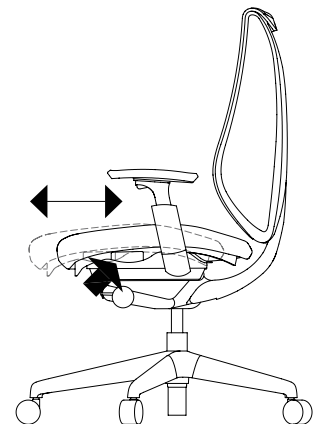

sabrina adjustment features & instructions (continued)

seat height-adjustment

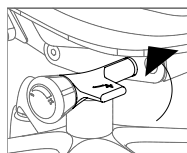

Seat height can be adjusted by pulling up on the lever below the seat on the right hand side. When this lever is pulled, the weight of the body will cause the seat to lower, and releasing it stops the seat at the desired height. Pulling up on the lever with no weight on the seat allows it to rise.

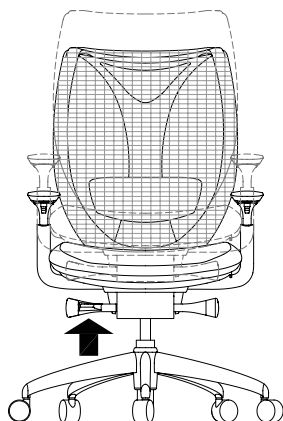

fit and flex back

While the center frame firmly supports the user sitting, the slide frame allows passive forking right and left as the user twists, or flexes torsionally.



stool foot ring height

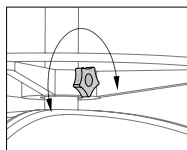

To raise or lower the stool's foot ring, turn the foot ring's knob counter-clockwise to release the foot ring and adjust the ring until you reach desired level. Turn the knob clockwise to lock in place.

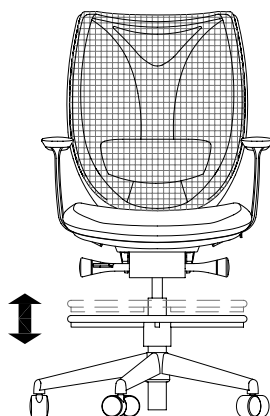

work chairs

Xpress

NSBY

Sabrina – Synchro-Tilt Task Chair

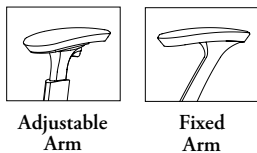
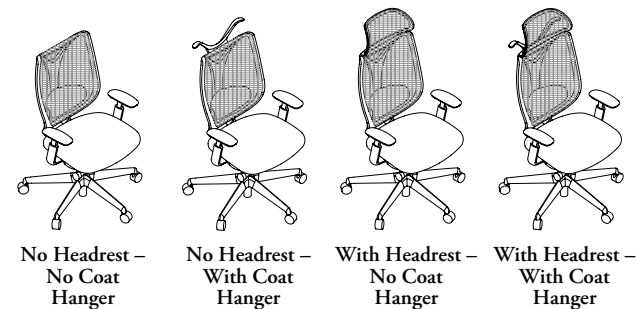

FEATURES

- Synchro-tilt mechanism (2.78:1 tilt ratio) with Tilt-Tension and Lock. Back recline up to 23°
- Optional forward tilt seat
- Innovative, organic structured back frame with FIT & FLEX capability
- Seat Depth Adjustment of 2"
- Standard pneumatic cylinder provides height-adjustment of 4"
- Ebony Plastic or Polished Aluminum base
- Optional Plastic height-adjustable arms with pivoting arm pads and arm pad depth adjustment or Fixed Polished Aluminum arms
- Optional 2-3/8" height-adjustable Lumbar Element, fixed mesh Headrest and Coat Hanger
- Hard casters are standard and well suited for soft flooring such as carpeting
- Soft casters are available for use on hard flooring, such as wood, concrete or tile

NOTES

Headrest finishes default to Back Mesh finish and Frame finish. Lumbar membrane is translucent Ebony finish. Coat Hanger finish defaults to frame finish. Plastic Arm finish matches frame finish (Very White arm has Grey arm pad). Polished Aluminum arm has Ebony arm pad to match Ebony frame and Grey arm pad with Very White frame.

Sabrina Chair is Dual Upholstered with Sabrina Mesh available on the back and Teknion's Standard and Graded-In fabrics on seat.

Headrest and Coat Hanger Accessories must be installed on-site by customer to Fully Assembled (F) chairs.

Not Fully Assembled (N) option is only available when Accessories option No Headrest-No Coat Hanger (N) is specified.

Not all configurations are available as Xpress. Please see Xpress catalogue and/or specification software for details.

PRODUCT OPTIONS

Accessories	Lumbar Element	Arm Style	Back Upholstery Finish (Sabrina Mesh Back)	Seat Upholstery Finish (For Dual)	Cylinder Style	Frame Finish	Base Finish	Casters/ Glides (Optional)	Other Options
N No Headrest – No Coat Hanger	N No Lumbar Element	N No Arms	SB15 Iron	Fabric	1 Standard 2 High 3 Low Mechanism Style F Standard with Forward Tilt	52 Ebony	52 Ebony	A Casters, Soft B Glides, Hard C Glides, Soft	F Fully Assembled (accessories require installation) N Not Fully Assembled
C No Headrest – With Coat Hanger	Y With Lumbar Element	H Height-Adjustable T-Arms with Pivot and Depth-Adjustable Arm Pads	SB16 Basalt SB17 Chainlink SB19 Brier SB20 Banner SB21 Lapis	Leather		8C Very White	C9 Polished Aluminum		
H With Headrest – No Coat Hanger		A Fixed Polished Aluminum Arms							
Y With Headrest – With Coat Hanger									

SAMPLE ORDER CODE

NSBY N	Y	N	SB17	E523	1	F	52	52	A	F
---------------	----------	----------	-------------	-------------	----------	----------	-----------	-----------	----------	----------

See pricing on the following page.

NSBD Sabrina – Swivel Stool

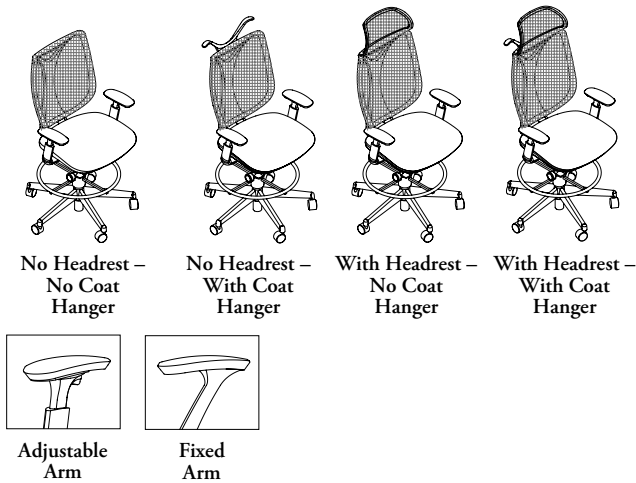

FEATURES

- Synchro-Tilt mechanism (2.78:1 tilt ratio) with Tilt-Tension and Lock. Back recline up to 9°
- Includes all-aluminum foot ring with 4" height-adjustment
- Innovative, organic structured back frame with FIT & FLEX capability
- Seat Depth Adjustment of 2"
- Standard pneumatic cylinder provides height-adjustment of 8"
- Ebony Plastic or Polished Aluminum base
- Optional Plastic height-adjustable arms with pivoting arm pads and arm pad depth adjustment or Fixed Polished Aluminum arms
- Optional 2-3/8" height-adjustable Lumbar Element, fixed mesh Headrest and Coat Hanger
- Hard casters are standard and well suited for soft flooring such as carpeting
- Soft casters are available for use on hard flooring, such as wood, concrete or tile

NOTES

Headrest finishes default to Back Upholstered finish and Frame finish. Lumbar membrane is translucent Ebony finish. Coat Hanger finish defaults to frame finish.

Plastic Arm finish matches frame finish (Very White arm has Grey arm pad).

Polished Aluminum arm has Ebony arm pad to match Ebony frame and Grey arm pad with Very White frame.

Sabrina Chair is Dual Upholstery with Sabrina Mesh available on the back and Teknion's Standard and Graded-In fabrics on seat.

Not Fully Assembled (N) option is only available when Accessories option No Headrest-No Coat Hanger (N) is specified.

PRODUCT OPTIONS

Accessories	Lumbar Element	Arm Style	Back Upholstery Finish (Sabrina Mesh Back)	Seat Upholstery Finish (For Dual)	Frame Finish	Base Finish	Casters/ Glides (Optional)	Other Options
N No Headrest – No Coat Hanger	N No Lumbar Element	N No Arms	SB15 Iron	Fabric	52 Ebony	52 Ebony	Casters, Hard	F Fully Assembled
C No Headrest – With Coat Hanger	Y With Lumbar Element	H Height-Adjustable T-Arms with Pivot and Depth-Adjustable Arm Pads	SB16 Basalt	Leather	8C Very White	C9 Polished Aluminum	A Casters, Soft	N Not Fully Assembled
H With Headrest – No Coat Hanger		A Fixed Polished Aluminum Arms	SB17 Chainlink				B Glides, Hard	
Y With Headrest – With Coat Hanger			SB19 Brier				C Glides, Soft	
			SB20 Banner					
			SB21 Lapis					

SAMPLE ORDER CODE

NSBD N	Y	N	SB17	E523	52	52	A	F
---------------	----------	----------	-------------	-------------	-----------	-----------	----------	----------

DESCRIPTION

PRICE

	Grade 1	COM/ Grade 2	COL/ Grade 3	Grade 4	Grade 5	Grade 6	Grade 7	Grade 8	Grade 9	Grade 10
No Arms	1916	1946	1975	1992	2006	2024	2037	2053	2068	2086
With Height-Adjustable T-Arms	2156	2184	2214	2231	2246	2262	2277	2292	2307	2325
With Fixed Polished Aluminum Arms	2248	2278	2307	2323	2339	2356	2368	2386	2402	2417
	Leather LA	Leather LB	Leather LC	Leather LD						
No Arms	2286	2349	2536	2596						
With Height-Adjustable T-Arms	2526	2588	2772	2837						
With Fixed Polished Aluminum Arms	2619	2681	2868	2929						

If No Headrest, With Coat Hanger (C) is specified	add 184	If Polished Aluminum Base (C9) is specified	add 108
If With Headrest, No Coat Hanger (H) is specified	add 239	If Soft Casters (A) are specified	add 28
If With Headrest, With Coat Hanger (Y) is specified	add 426	If Hard Glides (B) are specified	add 28
If Lumbar Element (Y) is specified	add 74	If Soft Glides (C) are specified	add 43

savera overview

Savera is an affordable line of ergonomically sophisticated seating – one design that takes many elegant forms. The collection includes mid-back or high-back chairs, an oversized version with a wider scale, and a stool.

Savera – Synchro-Tilt Task Chair (NSAY)



statement of line

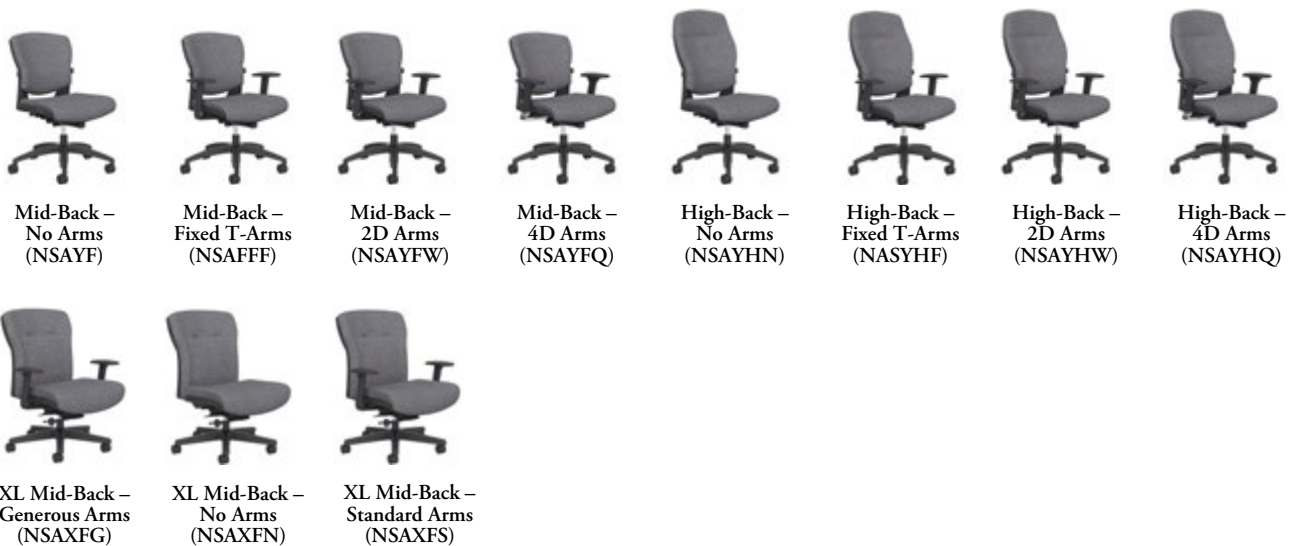

savera overview (continued)

Savera – Swivel Tilt (NSAW)



statement of line



savera overview (continued)

Savera – Swivel Stool (NSAD)



statement of line



savera overview (continued)

Savera – Multi Tilt (NSAM)



statement of line



Mid-Back –
No Arms
(NSAMFN)



Mid-Back –
Fixed T-Arms
(NSAMFF)



Mid-Back –
Width and
Height-Adjustable
T-Arms
(NSAMFW)



Mid-Back –
4D Width and
Height Depth
Pivot Arms
(NSAMFQ)



High-Back –
No Arms
(NSAMHN)



High-Back –
Fixed T-Arms
(NSAMHF)



High-Back –
Height-Adjustable
T-Arms
(NSAMHW)



High-Back –
4D Width and
Height Depth
Pivot Arms
(NSAMHQ)

savera dimensions & material requirements

features

- Designed and tested for users up to 300 lbs (Savera XL: 400 lbs)
- Meets ANSI/BIFMA Requirement

weight

General Use/Synchro-Tilt Task	40 lbs
Multi-Tilt Task	67 lbs
Stool	41 lbs
Executive/XL	64 lbs

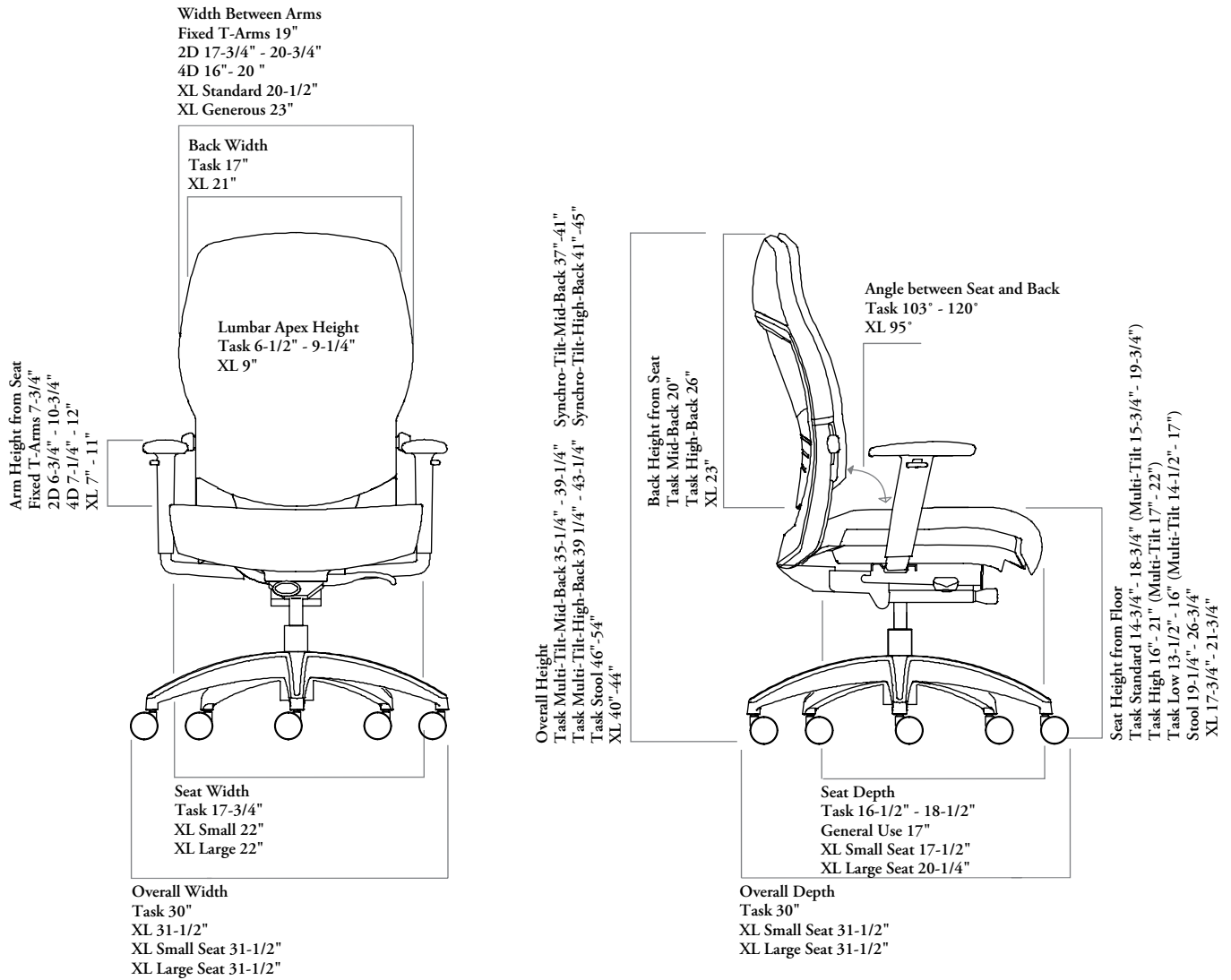

COM/COL material requirement

The pattern, repeat and directionality of fabric may increase the amount of yardage required.

Leather quantities should always be rounded up to the next hide size, as yields vary from 60-80% and are affected by the quality, size and shape of the hide, and by the location and quantity of blemishes.

	SINGLE UPHOLSTERED		DUAL UPHOLSTERED – SEAT		DUAL UPHOLSTERED – BACK	
	COM [yards]	COL [sq. ft]	COM [yards]	COL [sq. ft]	COM [yards]	COL [sq. ft]
Mid-Back	1	9	1	6	0.75	4
Mid-Back (XL)	1.5	19.5	1	10.5	1	9.25
High-Back	1	11.5	1	8	1.5	7.5

savera arm adjustment features & instructions

arm width adjustment

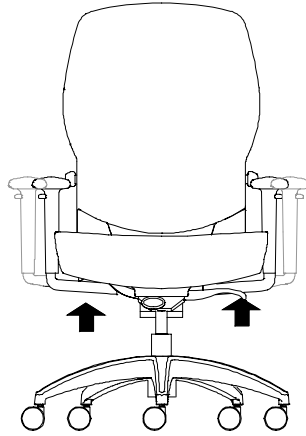
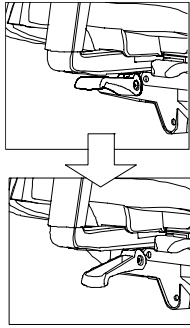

To adjust the arm width on Savera Synchro-Tilt, Multi-Tilt, Swivel-Tilt and Stool, push the lever down and slide the arm to the desired position. Push the lever up to lock the arm in place.

Savera XL arms are fixed prior to shipping in either standard or generous position.

arm height-adjustment

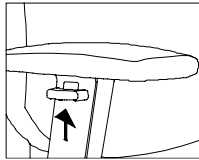

2D ARMS:

To adjust the arm height, lift the small button on the outside of either arm to raise or lower it to the desired position.

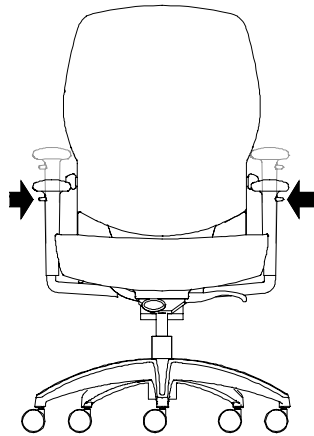

arm height-adjustment

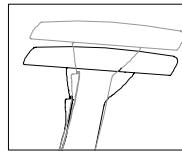

4D ARMS:

To adjust the arm height, press the button located behind either arm to raise or lower it to the desired position. Release the button to lock in place.

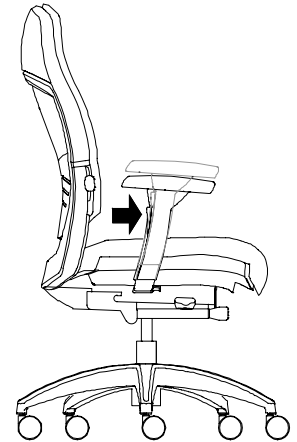

4D arm pivot adjustment

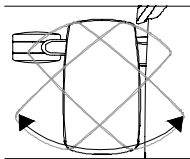

To pivot the armrest, grasp the arm cap, rotate inward or outward and release at the desired position. Not available on Savera XL.

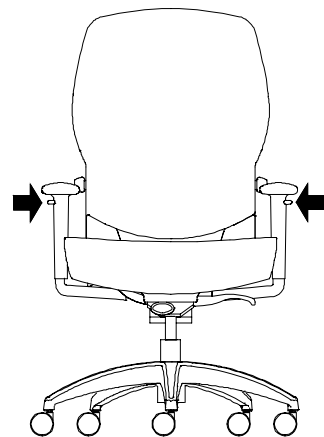

4D arm slider adjustment

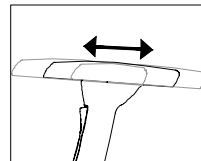

To adjust the arm cap depth position, grasp the arm cap and firmly slide forward or backward to the desired position.

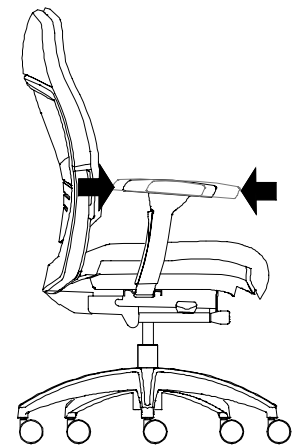

savera synchro-tilt adjustment features & instructions

back tilt adjustment

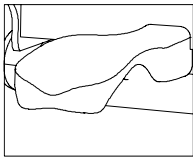

SYNCHRO-TILT TASK:

The tilt control paddle on the left locks the chair into four different positions.

To tilt the chair, sit in the chair and unlock the paddle by pushing it down, which will release the back to free flow. To lock in position, pull the paddle up and the back will lock in position.

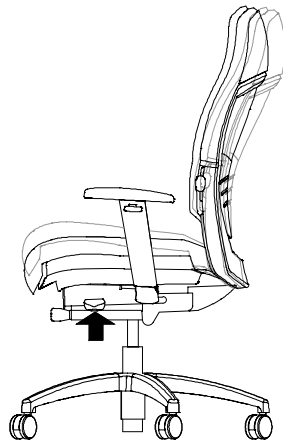

tension control

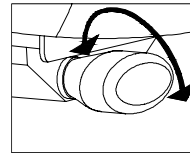

SYNCHRO-TILT TASK:

The tension-adjustment knob for the Synchro-Tilt Task chair is located in the center below the front of the seat. Leaning back, decide if the resistance of the chair is comfortable. If it is too stiff, turn the tension adjustment knob counter-clockwise. If the chair back does not provide enough resistance, rotate the knob clockwise.

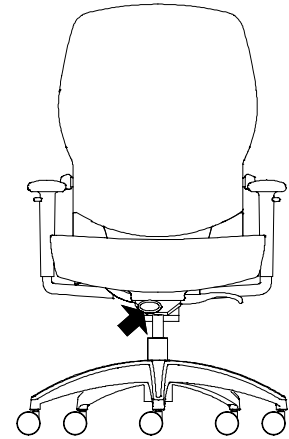

lumbar height-adjustment

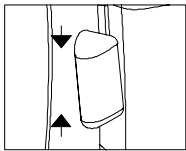

The lumbar height-adjustment levers for Savera Synchro-Tilt, Multi-Tilt, Swivel-Tilt and Stool are found on both sides of the chair. Pull both levers up or down to the desired position.

Savera XL does not have lumbar height-adjustment.

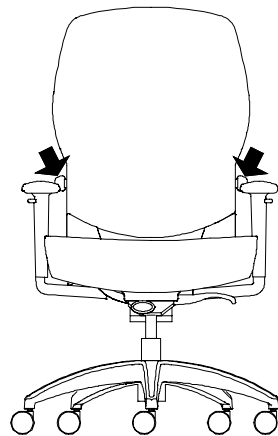

seat height-adjustment

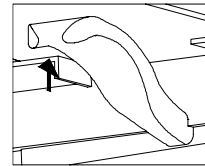

The seat height-adjustment paddle for Savera Synchro-Tilt, Swivel-Tilt and XL is located underneath the seat on the right side.

To raise the chair, lift the paddle up, while lifting your weight from the seat, until you reach the desired height, then release. To lower the chair, lift the paddle up, allowing your weight to push the seat down until you reach the desired height, then release.

The seat height-adjustment paddle for Savera Stool functions the same but the paddle is located on the left side.

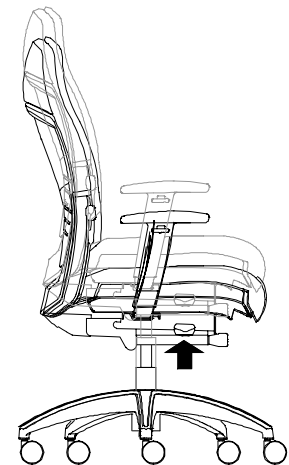

seat depth adjustment

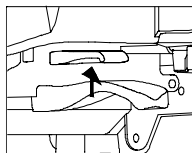

SWIVEL-TILT AND SYNCHRO-TILT-TASK:

The lever is located on the left-hand side, near the front. To adjust the seat depth, lift lever up. Simultaneously lift your weight from the seat while sliding the seat forward or backward. Release the lever to lock the seat in place.

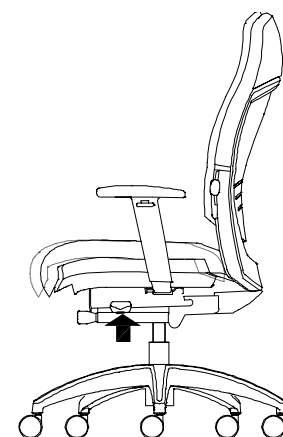

See "Savera arm adjustment features and instructions" page at the beginning of this section for arm details.

savera XL adjustment features & instructions

back tilt adjustment

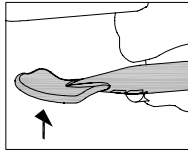

SYNCHRO-TILT XL:

The back tilt adjustment paddle is located underneath the seat on the left side. The back tilt adjustment provides the ability to lock the back into four different positions or leave in free flow.

To tilt the chair, sit in the chair and unlock the paddle by pulling it up, which will release the back to free flow. To lock the desired position, push the paddle down and the back will lock.

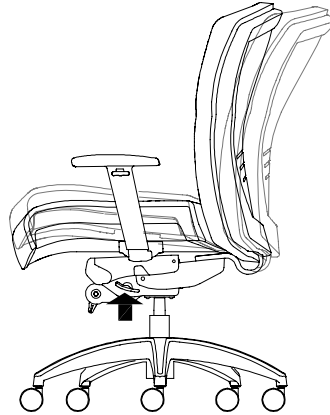

tension control

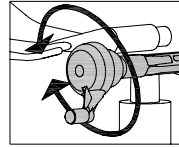

SYNCHRO-TILT XL:

The tension-adjustment wheel is located underneath the seat on the right side.

Leaning back with the back tilt adjustment paddle in the up position, determine if the resistance of the chair is comfortable. If the resistance is too stiff, turn the tension adjustment wheel counter-clockwise. If the chair back does not provide enough resistance, turn the wheel clockwise.

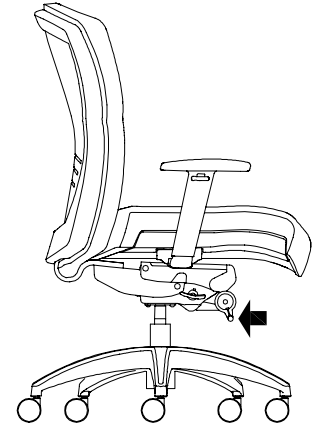

seat height-adjustment

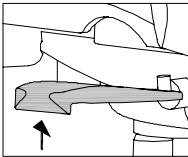

The seat height-adjustment paddle for Savera Synchro-Tilt, Swivel-Tilt and XL is located underneath the seat on the right side.

To raise the chair, lift the paddle up, while lifting your weight from the seat, until you reach the desired height, then release. To lower the chair, lift the paddle up, allowing your weight to push the seat down until you reach the desired height, then release.

The seat height-adjustment paddle for Savera Stool functions the same but the paddle is located on the left side.

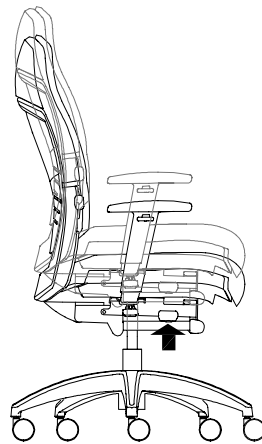

See “Savera arm adjustment features and instructions” page at the beginning of this section for arm details.

savera multi-tilt adjustment features & instructions

back tilt adjustment

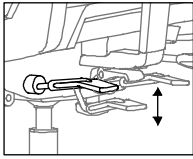

The Tilt control lever is on the right-hand side and is located at the farther back position.

To lock the back, lean back to the desired angle and firmly push the lever down to engage it. To unlock and free-float, firmly pull up the lever to the horizontal position.

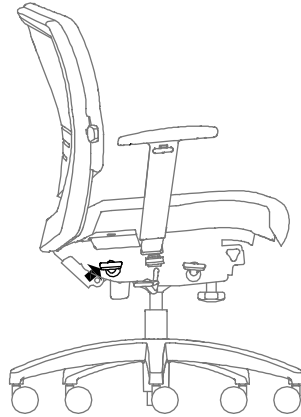

tension control

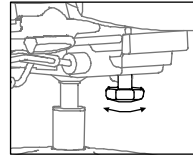

The tension adjustment knob for the multi-tilt is located in the middle, directly under the front of the seat. Turning the knob counter-clockwise will increase the tension and clockwise will decrease the tension.

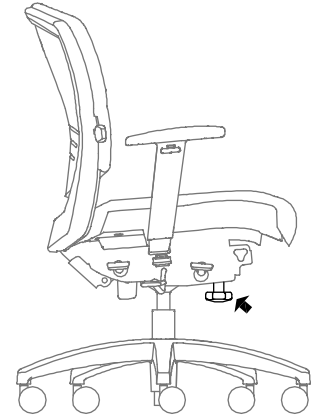

lumbar height-adjustment

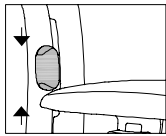

The lumbar height-adjustment levers for Savera Synchro-Tilt, Multi-Tilt, Swivel-Tilt and Stool are found at the sides of the chair. Pull levers up or down to the desired position.

Savera XL does not have lumbar height-adjustment.

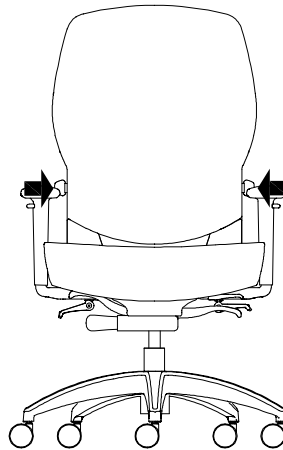

seat height-adjustment

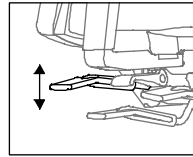

The seat height-adjustment paddle on the Multi-Tilt is located on the right-hand side, underneath the arm post.

To raise the chair, lift the paddle up, while lifting your weight from the seat, until you reach the desired height, then release. To lower the chair, lift the paddle up, allowing your weight to push the seat down until you reach the desired height, then release.

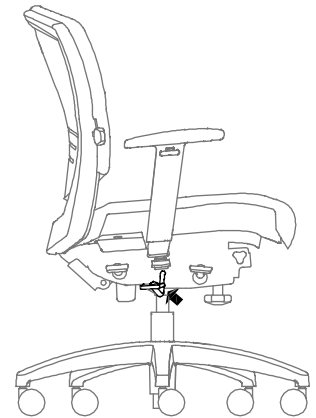

seat depth adjustment

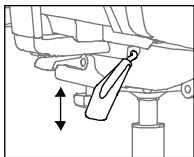

The paddle is located on the left-hand side, near the back. To adjust the seat depth, lift lever up. Simultaneously lift your weight from the seat while sliding the seat forward or backward. Release the lever to lock the seat in place.

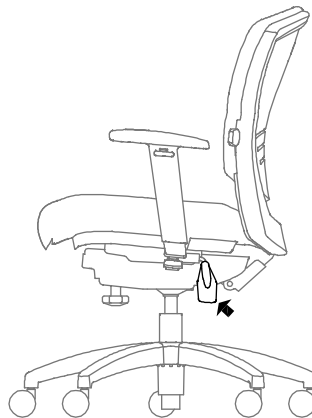

seat angle adjustment

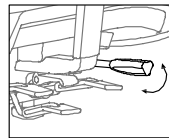

The Forward-Tilt knob is located closest to the front. Rotate it forward and rearward to adjust the seat angle incline.

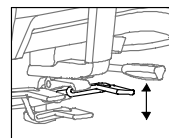

The seat angle may be infinitely adjusted when the paddle is in the horizontal position. Firmly push the lever down to lock the seat angle and pull up to the horizontal position to allow free floating.

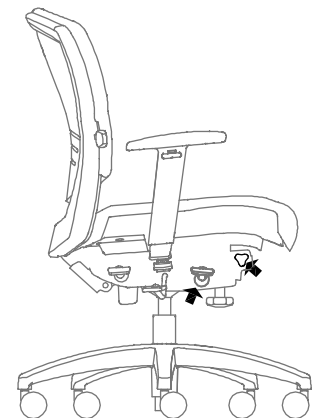

savera swivel-tilt adjustment features & instructions

back tilt adjustment

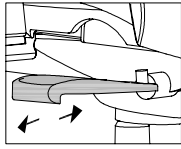

SWIVEL-TILT TASK:

The back-tilt control lever is located on the right near the front. To tilt the chair, sit in the chair and pull the handle outward. Leaving the handle in this position, the chair is now in free flow mode and can reach any position between upright and fully reclining. To lock (upper position only), bring chair to upright position and push the handle in.

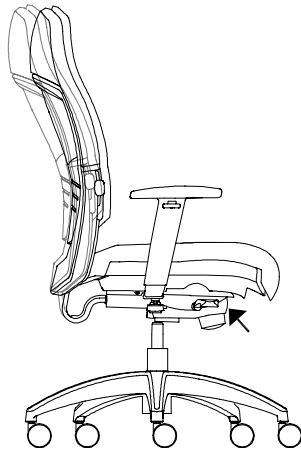

tension control

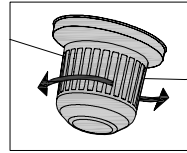

SWIVEL-TILT TASK:

The tension-adjustment knob for the swivel-tilt is located in the middle directly under the seat. Turning the knob will increase or decrease tension.

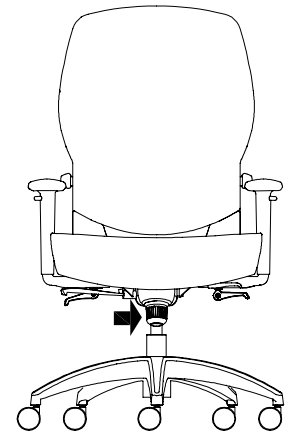

lumbar height-adjustment

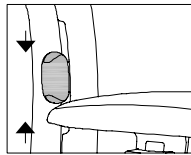

The lumbar height-adjustment levers for Savera Synchro-Tilt, Multi-Tilt, Swivel-Tilt and Stool are found at both sides of the chair. Pull both levers up or down to the desired position.

Savera XL does not have lumbar height-adjustment.

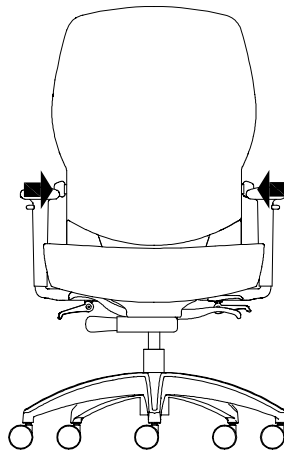

seat height adjustment

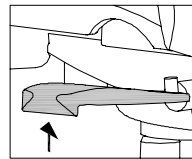

The seat height-adjustment paddle for Savera Synchro-Tilt, Swivel-Tilt and XL is located underneath the seat on the right side.

To raise the chair, lift the paddle up, while lifting your weight from the seat, until you reach the desired height, then release. To lower the chair, lift the paddle up, allowing your weight to push the seat down until you reach the desired height, then release.

The seat height-adjustment paddle for Savera Stool functions the same but the paddle is located on the left side.

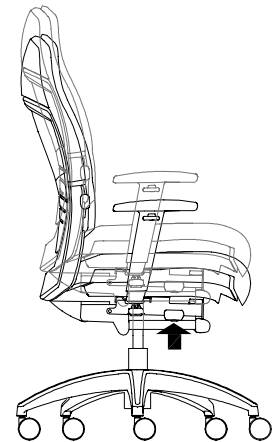

seat depth adjustment

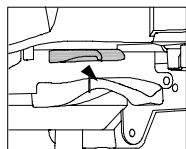

SWIVEL-TILT AND SYNCHRO-TILT-TASK:

The lever is located on the left-hand side, near the front. To adjust the seat depth, lift lever up. Simultaneously lift your weight from the seat while sliding the seat forward or backward. Release the lever to lock the seat in place.

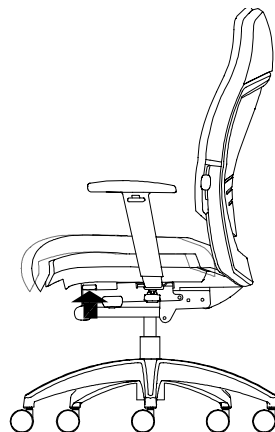

See “Savera arm adjustment features and instructions” page at the beginning of this section for arm details.

savera swivel-stool adjustment features & instructions

stool seat height

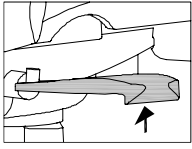

To raise the chair, lift the paddle up while lifting your weight from the seat until you reach the desired level and then release to lock in place. To lower the chair, lift the paddle up allowing your weight to push the seat down to the desired level and then release to lock in place.

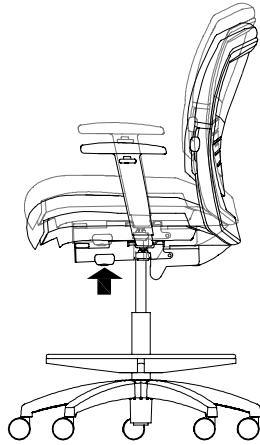

stool foot ring height

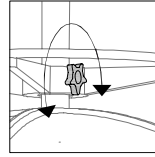

To raise or lower the stool's foot ring, turn the foot ring's knob counter clockwise to release the foot ring and adjust the ring until you reach the desired level. Turn the knob clockwise to lock in place.

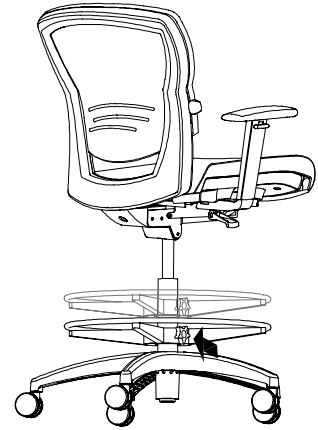

lumbar height-adjustment

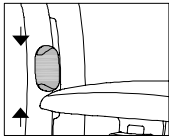

The lumbar height-adjustment levers for Savera Synchro-Tilt, Swivel-Tilt and Stool are found at the sides of the chair. Pull levers up or down to the desired position.

Savera XL does not have lumbar height-adjustment.

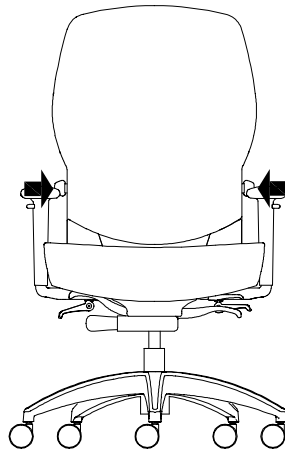

See "Savera arm adjustment features and instructions" page at the beginning of this section for arm details.

work chairs

Xpress

NSAY

Savera – Synchro-Tilt Task Chair

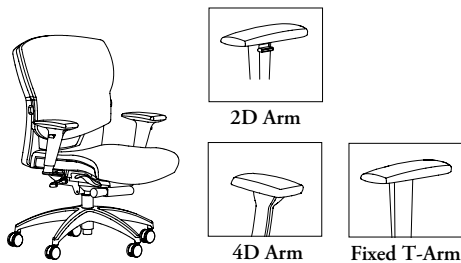

FEATURES

- Standard pneumatic cylinder provides height-adjustment of 4"
- Seat depth adjustment of 2"
- Lumbar height-adjustment of 2-3/4"
- Back-tilt can be locked in four positions or left free flow
- Frame, 5-Star Base and outer back are plastic
- Synchro-tilt 3:1 ratio
- Tension control
- Hard casters are standard and are well suited for soft flooring such as carpeting
- Soft casters are available for use on hard flooring, such as wood, concrete, or tile

NOTES

Not all configurations are available as Xpress. Please see Xpress catalogue and/or specification software for details.

PRODUCT OPTIONS

Size	Mechanism Style	Arm Style	Upholstery/Back Style	Seat Upholstery Finish	Seat Depth Adjustment	Cylinder Style	Base Finish	Casters/Glides (Optional)	Other Options
F Mid-Back	1 Standard	N No Arms	P Single Upholstered	Fabric Leather	N No Seat Depth Adjustment	1 Standard 2 High 3 Low	E Ebony	Casters, Hard	Not Fully Assembled F Fully Assembled
H High-Back		F Fixed T-Arms			S With Seat Depth Adjustment			A Casters, Soft B Glides, Hard C Glides, Soft	
		W 2D Height and Width-Adjustable T-Arms							
		Q 4D Width, Height and Depth-Adjustable T-Arms with Pivoting Arm Caps							

SAMPLE ORDER CODE

NSAY F	1	N	P	L207	S	1	E		F
---------------	----------	----------	----------	-------------	----------	----------	----------	--	----------

DESCRIPTION

MID-BACK (F)	
No Arms	
Fixed T-Arms	
2D Height and Width-Adjustable T-Arms	
4D Width, Height and Depth-Adjustable T-Arms	
<hr/>	
No Arms	
Fixed T-Arms	
2D Height and Width-Adjustable T-Arms	
4D Width, Height and Depth-Adjustable T-Arms	

PRICE

Grade 1	COM/Grade 2	COL/Grade 3	Grade 4	Grade 5	Grade 6	Grade 7	Grade 8	Grade 9	Grade 10
912	949	992	1034	1070	1112	1151	1194	1235	1373
1046	1087	1124	1167	1205	1245	1288	1326	1368	1506
1087	1124	1167	1206	1245	1288	1326	1368	1409	1549
1130	1170	1210	1248	1290	1329	1372	1413	1451	1593
<hr/>									
Leather LA	Leather LB	Leather LC	Leather LD						
1198	1239	1363	1405						
1332	1373	1498	1539						
1375	1415	1539	1580						
1418	1459	1582	1623						

If Seat Depth Adjustment (S) is specified	add	84
If Soft Casters (A) are specified	add	28
If Hard Glides (B) are specified	add	28
If Soft Glides (C) are specified	add	43
If Fully Assembled (F) is specified	add	5

Pricing is continued on the following pages.

Xpress

NSAY
Savera – Synchro-Tilt Task Chair
(Continued)

DESCRIPTION	PRICE									
	Grade 1	COM/ Grade 2	COL/ Grade 3	Grade 4	Grade 5	Grade 6	Grade 7	Grade 8	Grade 9	Grade 10
HIGH-BACK (H)										
No Arms	945	988	1024	1066	1109	1147	1188	1228	1270	1409
Fixed T-Arms	1082	1119	1159	1201	1241	1283	1322	1363	1405	1543
2D Height and Width-Adjustable T-Arms	1119	1161	1201	1241	1283	1322	1363	1405	1445	1583
4D Width, Height and Depth-Adjustable T-Arms	1166	1205	1244	1286	1325	1366	1408	1448	1489	1625
	Leather LA	Leather LB	Leather LC	Leather LD						
No Arms	1289	1339	1500	1553						
Fixed T-Arms	1421	1474	1637	1687						
2D Height and Width-Adjustable T-Arms	1465	1518	1677	1730						
4D Width, Height and Depth-Adjustable T-Arms	1506	1560	1720	1772						
If Seat Depth Adjustment (S) is specified	add	84								
If Soft Casters (A) are specified	add	28								
If Hard Glides (B) are specified	add	28								
If Soft Glides (C) are specified	add	43								
If Fully Assembled (F) is specified	add	5								

work chairs

NSAX Savera XL – Synchro-Tilt Task Chair



FEATURES

- Standard pneumatic cylinder provides height-adjustment of 4"
- Synchro-tilt 3:1 ratio
- Seat and back inner construction are plywood
- Frame, 5-Star Base and outer back are plastic
- Tension control
- Frame, 5-Star Base and outer back are plastic
- Hard casters are standard and are well suited for soft flooring such as carpeting
- Soft casters are available for use on hard flooring, such as wood, concrete, or tile

NOTES

Standard vs Generous Arms: Arms are the same height-adjustable style, width clearance is 20-1/2" for Standard and 23" for Generous. Arm placement is done by plant prior to shipping.

Single Upholstered: The same fabric is applied to the seat and inside back.

PRODUCT OPTIONS

Size	Mechanism Style	Arm	Upholstery Style	Back Upholstery Finish	Seat Depth	Cylinder Style	Base Finish	Casters/Glides (Optional)
F Mid-Back	1 Standard	N No Arms S Standard G Generous	P Single Upholstered	Fabric Leather Seat Upholstery Finish (For Dual) Fabric Leather	S Small L Large	1 Standard	E Ebony	Casters, Hard A Casters, Soft B Glides, Hard C Glides, Soft

SAMPLE ORDER CODE

NSAX F	1	S	P	L207		L	1	E	A
--------	---	---	---	------	--	---	---	---	---

DESCRIPTION

No Arms
Standard
Generous
No Arms
Standard
Generous

PRICE

	Grade 1	COM/ Grade 2	COL/ Grade 3	Grade 4	Grade 5	Grade 6	Grade 7	Grade 8	Grade 9	Grade 10
No Arms	1732	1786	1843	1897	1951	2006	2061	2115	2172	2358
Standard	1891	1945	2001	2057	2110	2162	2219	2274	2329	2520
Generous	1891	1945	2001	2057	2110	2162	2219	2274	2329	2520
	Leather LA	Leather LB	Leather LC	Leather LD						
No Arms	2290	2380	2646	2736						
Standard	2445	2535	2804	2893						
Generous	2445	2535	2804	2893						

If Soft Casters (A) are specified add 28
 If Hard Glides (B) are specified add 28
 If Soft Glides (C) are specified add 43

FEATURES

- Standard pneumatic cylinder provides height-adjustment of 4"
- Seat depth adjustment of 2"
- Lumbar height-adjustment of 2-3/4"
- Allows for independent adjustment of the back angle and seat tilt. Includes forward seat tilt and lock and infinite position seat tilt lock
- Frame, 5-Star Base and outer back are plastic
- Center-tilt action
- Tension control
- Hard casters are standard and are well suited for soft flooring such as carpeting
- Soft casters are available for use on hard flooring, such as wood, concrete, or tile

NOTES

Single Upholstered: The same fabric is applied to the seat and inside back.
 Not all configurations are available as Xpress. Please see Xpress catalogue and/or specification software for details.
 Seat depth adjustment is included as a standard feature.

**NSAM
Savera Multi-Tilt Task Chair**

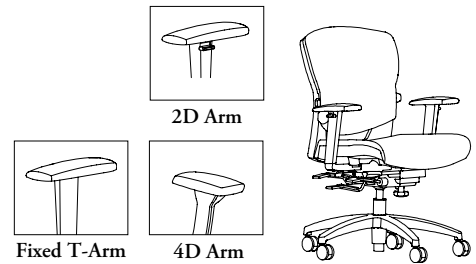

PRODUCT OPTIONS

Size	Mechanism Style	Arm Style	Upholstery Back Style	Back Upholstery Finish	Cylinder Style	Base Finish	Casters/Glides (Optional)	Assembled
F Mid-Back	1 Standard	N No Arms	P Single Upholstered	Fabric	1 Standard - 4" range 2 Higher (taller) - 5" range 3 Lower (shorter) - 3" range	E Ebony	Casters, Hard A Casters, Soft B Glides, Hard C Glides, Soft	F Fully Assembled
H High-Back		F Fixed T-Arm		Seat Upholstery Finish				
	W Width and Height-Adjustable T-Arms	Fabric						
		Q 4D Width, Height and Depth pivot arm						

SAMPLE ORDER CODE

NSAM F	1	N	P	L207		1	E	A	F
---------------	----------	----------	----------	-------------	--	----------	----------	----------	----------

DESCRIPTION

PRICE

MID-BACK (F)	Grade 1	COM/ Grade 2	COL/ Grade 3	Grade 4	Grade 5	Grade 6	Grade 7	Grade 8	Grade 9	Grade 10
No Arms	1083	1122	1165	1205	1242	1284	1324	1363	1406	1544
Fixed T-Arms	1217	1259	1297	1336	1377	1418	1459	1499	1539	1679
4D Width, Height and Depth Pivot Arms	1302	1343	1380	1421	1462	1502	1543	1583	1624	1764
2D Height and Width-Adjustable T-Arms	1259	1297	1336	1378	1418	1459	1499	1539	1581	1718

	Leather LA	Leather LB	Leather LC	Leather LD
No Arms	1371	1411	1535	1578
Fixed T-Arms	1503	1544	1669	1710
4D Width, Height and Depth Pivot Arms	1589	1629	1755	1795
2D Height and Width-Adjustable T-Arms	1547	1587	1710	1750

HIGH-BACK (H)	Grade 1	COM/ Grade 2	COL/ Grade 3	Grade 4	Grade 5	Grade 6	Grade 7	Grade 8	Grade 9	Grade 10
No Arms	1118	1158	1197	1239	1277	1320	1360	1401	1443	1581
Fixed T-Arms	1253	1292	1329	1373	1413	1452	1495	1535	1578	1714
4D Width, Height and Depth Pivot Arms	1335	1377	1415	1455	1498	1538	1580	1621	1658	1798
2D Height and Width-Adjustable T-Arms	1292	1333	1373	1413	1452	1495	1535	1578	1617	1756

	Leather LA	Leather LB	Leather LC	Leather LD
No Arms	1460	1510	1673	1726
Fixed T-Arms	1593	1647	1806	1858
4D Width, Height and Depth Pivot Arms	1679	1732	1892	1944
2D Height and Width-Adjustable T-Arms	1637	1688	1850	1902

If Soft Casters (A) are specified add 28
 If Hard Glides (B) are specified add 28
 If Soft Glides (C) are specified add 43

work chairs

Xpress

NSAW

Savera – Swivel-Tilt General Use Chair

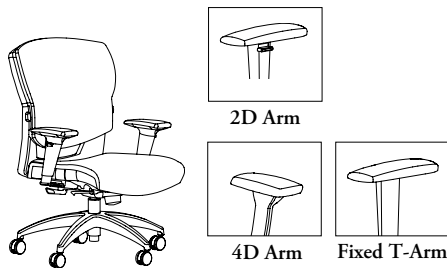

FEATURES

- Standard pneumatic cylinder provides height-adjustment of 4"
- Seat depth adjustment of 2"
- Lumbar height-adjustment of 2-3/4"
- Back-tilt locks in the upright position
- Frame, 5-Star Base and outer back are plastic
- Swivel-tilt
- Tension control
- Hard casters are standard and are well suited for soft flooring such as carpeting
- Soft casters are available for use on hard flooring, such as wood, concrete, or tile

NOTES

Single Upholstered: The same fabric is applied to the seat and inside back.
Not all configurations are available as Xpress. Please see Xpress catalogue and/or specification software for details.

PRODUCT OPTIONS

Size	Mechanism Style	Arm Style	Upholstery Style	Back Upholstery Finish	Seat Depth Adjustment	Cylinder Style	Base Finish	Casters/Glides (Optional)	Other Options
F Mid-Back	1 Standard	N No Arms	P Single Upholstered	Fabric	N No Seat Depth Adjustment	1 Standard	E Ebony	Casters, Hard	Not Fully Assembled
H High-Back		F Fixed T-Arms		Leather				S With Seat Depth Adjustment	
		W 2D Height and Width-Adjustable T-Arms		Seat Upholstery Finish (For Dual)		3 Low		B Glides, Hard	F Fully Assembled
		Q 4D Width, Height and Depth-Adjustable T-Arms with Pivoting Arm Caps			Fabric		C Glides, Soft		
				Leather					

SAMPLE ORDER CODE

NSAW H	1	W	P	A101	N	3	E	F
---------------	----------	----------	----------	-------------	----------	----------	----------	----------

DESCRIPTION

MID-BACK (F)

No Arms
Fixed T-Arms
2D Height and Width-Adjustable T-Arms
4D Width, Height and Depth-Adjustable T-Arms

No Arms

Fixed T-Arms
2D Height and Width-Adjustable T-Arms
4D Width, Height and Depth-Adjustable T-Arms

HIGH-BACK (H)

No Arms
Fixed T-Arms
2D Height and Width-Adjustable T-Arms
4D Width, Height and Depth-Adjustable T-Arms

No Arms

Fixed T-Arms
2D Height and Width-Adjustable T-Arms
4D Width, Height and Depth-Adjustable T-Arms

PRICE

Grade 1	COM/Grade 2	COL/Grade 3	Grade 4	Grade 5	Grade 6	Grade 7	Grade 8	Grade 9	Grade 10
822	864	906	944	983	1023	1065	1108	1146	1286
959	999	1038	1080	1117	1158	1199	1240	1278	1419
999	1038	1080	1118	1158	1199	1240	1278	1321	1460
1042	1083	1122	1165	1202	1242	1284	1324	1365	1503

Leather LA	Leather LB	Leather LC	Leather LD
1112	1151	1275	1319
1245	1288	1411	1451
1288	1326	1450	1494
1328	1371	1495	1535

Grade 1	COM/Grade 2	COL/Grade 3	Grade 4	Grade 5	Grade 6	Grade 7	Grade 8	Grade 9	Grade 10
860	901	938	979	1020	1060	1100	1143	1183	1321
994	1035	1071	1114	1152	1195	1237	1275	1318	1453
1035	1072	1114	1152	1195	1237	1275	1318	1357	1496
1079	1117	1155	1198	1239	1277	1320	1361	1402	1540

Leather LA	Leather LB	Leather LC	Leather LD
1201	1253	1414	1466
1335	1389	1549	1600
1376	1429	1588	1643
1419	1472	1630	1683

If Seat Depth Adjustment (S) is specified add 84
 If Soft Casters (A) are specified add 28
 If Soft Glides (C) are specified add 43

If Hard Glides (B) are specified add 28
 If Fully Assembled (F) is specified add 5

FEATURES

- Standard pneumatic cylinder provides height-adjustment of 8" travel
- Swivels 360°
- Frame, 5-Star Base and outer back are plastic
- Hard casters are standard and are well suited for soft flooring such as carpeting
- Soft casters are available for use on hard flooring, such as wood, concrete, or tile

NOTES

Single Upholstered: The same fabric is applied to the seat and inside back.

**NSAD
Savera – Swivel Stool**

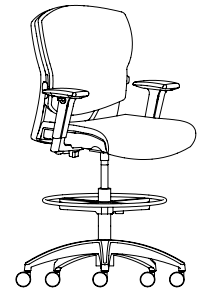

PRODUCT OPTIONS

Size	Mechanism Style	Arm Style	Upholstery Style	Back Upholstery Finish	Base Finish	Casters/Glides (Optional)	Other Options (Optional)
F Mid-Back	1 Standard	N No Arms	P Single Upholstered	Fabric	E Ebony	Casters, Hard A Casters, Soft B Glides, Hard C Glides, Soft	Not Fully Assembled F Fully Assembled
		W 2D Height and Width-Adjustable T-Arms		Leather			
		Q 4D Width, Height and Depth-Adjustable T-Arms with Pivoting Arm Caps		Seat Upholstery Finish (For Dual)			
				Fabric			
				Leather			

SAMPLE ORDER CODE

NSAD F	1	W	P	A101	E	F
---------------	----------	----------	----------	-------------	----------	----------

DESCRIPTION

PRICE

	Grade 1	COM/ Grade 2	COL/ Grade 3	Grade 4	Grade 5	Grade 6	Grade 7	Grade 8	Grade 9	Grade 10
No Arms	960	1003	1049	1093	1139	1183	1227	1269	1315	1466
2D Height and Width-Adjustable T-Arms	1151	1196	1240	1284	1327	1373	1416	1460	1502	1656
4D Width, Height and Depth-Adjustable T-Arms	1199	1242	1289	1329	1376	1420	1465	1506	1552	1706
		Leather LA	Leather LB	Leather LC	Leather LD					
No Arms	1253	1293	1418	1460						
2D Height and Width-Adjustable T-Arms	1448	1489	1611	1652						
4D Width, Height and Depth-Adjustable T-Arms	1496	1535	1656	1701						

If Soft Casters (A) are specified	add	28
If Hard Glides (B) are specified	add	28
If Soft Glides (C) are specified	add	43
If Fully Assembled (F) is specified	add	5

t-3 overview

t-3 achieves maximum comfort at an affordable price, providing simple, yet effective ergonomic seating.

t-3 – Task Chair (NXXY)



statement of line



t-3 overview (continued)

t-3 – Swivel Stool (NXXFWM)



statement of line



Swivel Stool –
No Arms
Upholstered Back
(NXXFNF)



Swivel Stool –
2D Width and
Height-Adjustable
-T-Arms
Upholstered Back
(NXXFWF)



Swivel Stool –
No Arms
Mesh Back
(NXXFNM)



Swivel Stool –
2D Width and
Height-Adjustable
-T-Arms
Mesh Back
(NXXFWM)

t-3 dimensions & material requirements

features

- Designed and tested for users up to 275 lbs
- Meets ANSI/BIFMA Requirement

weight

Task Chair	37 lbs
Stool	38 lbs

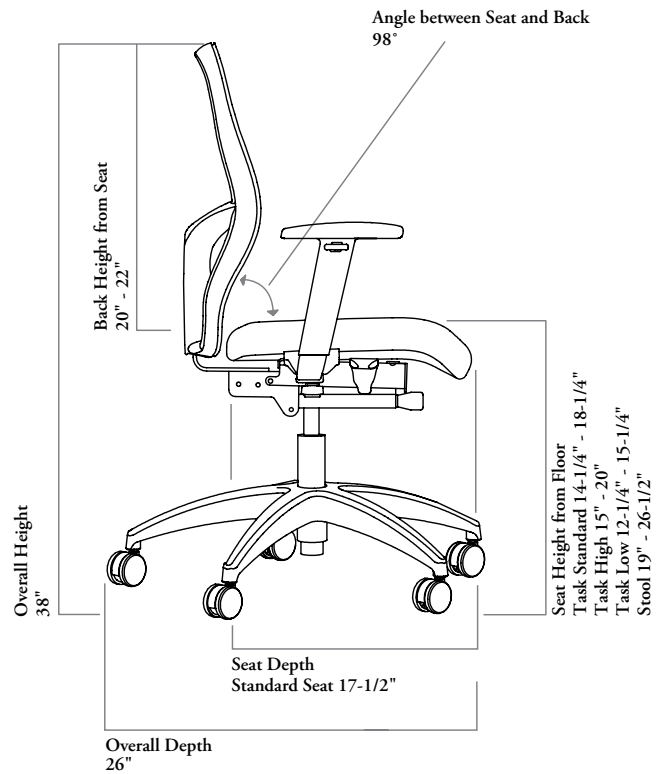
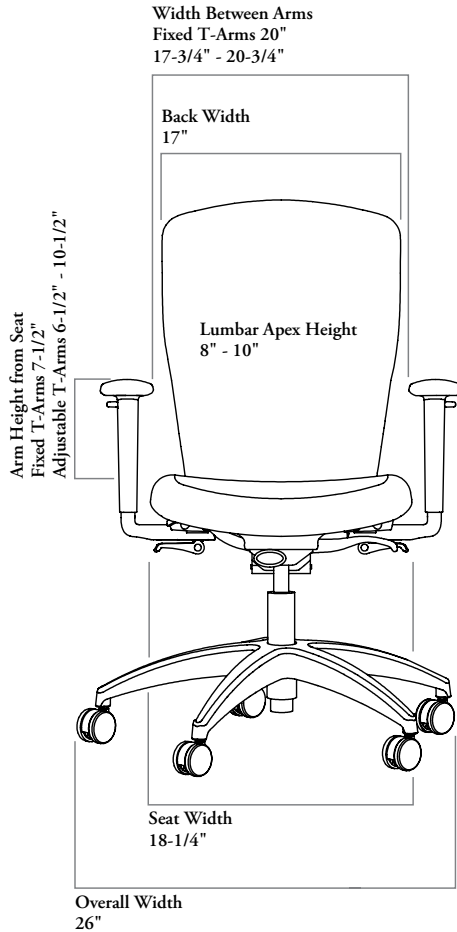

COM/COL material requirement

The pattern, repeat and directionality of fabric may increase the amount of yardage required.

Leather quantities should always be rounded up to the next hide size, as yields vary from 60-80% and are affected by the quality, size and shape of the hide, and by the location and quantity of blemishes.

	FULLY UPHOLSTERED		SEAT ONLY	
	COM [yards]	COL [sq. ft]	COM [yards]	COL [sq. ft]
Mid-Back	1	17.5	0.5	8.5

t-3 adjustment features & instructions

seat height-adjustment

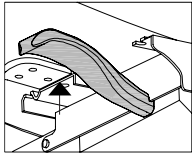

To raise the chair, lift the paddle up while lifting your weight from the seat until you reach the desired level and then release to lock in place. To lower the chair, lift the paddle up allowing your weight to push the seat down to the desired level and then release to lock in place.

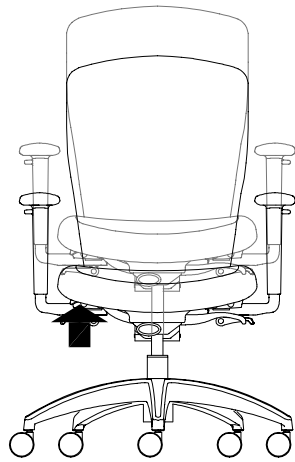

back tilt adjustment

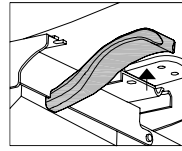

The tilt control paddle on the left locks the chair in four positions. To adjust the recline angle, push the paddle down to unlock it. Recline to the desired position and lift the paddle up to lock in place.

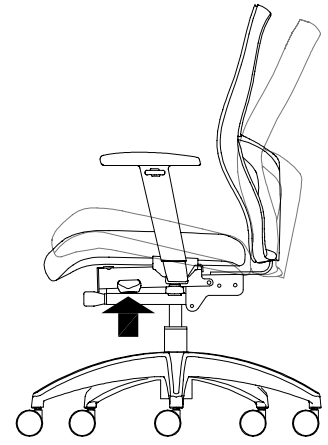

arm height-adjustment

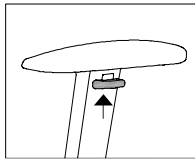

To adjust the arm height, press the small button on the outside of either arm to raise or lower it to the desired position. Release the button to lock in place.

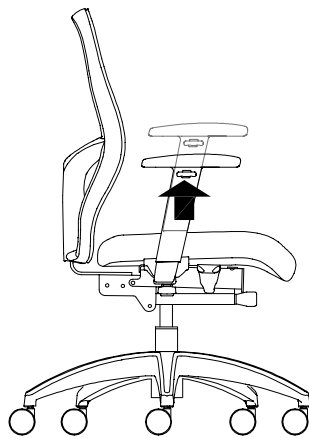

tension adjustment

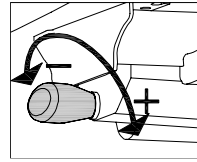

Lean back to determine if the resistance is comfortable. If it is too stiff, turn the knob counter-clockwise to decrease tension. If it does not provide enough resistance, turn the knob clockwise to increase tension.

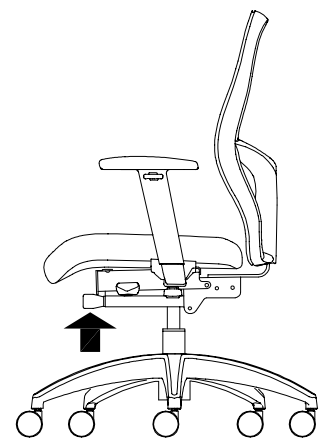

back height-adjustment

The back height-adjustment is activated by the chair's back. To adjust the lumbar height, lean forward and grasp both sides of the lower portion of the outside back. To raise, slide the back up. To lower, slide the back all the way to the top and then lower to desired height. Release to lock in place.

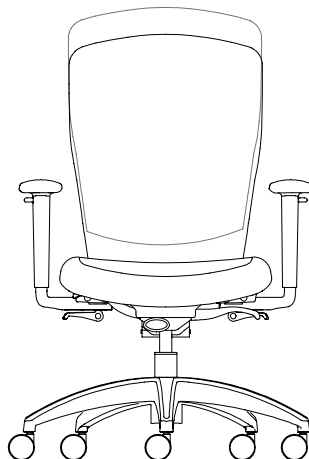

arm width adjustment

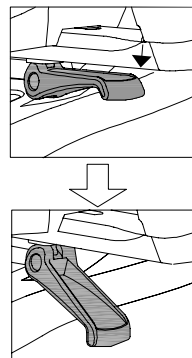

To adjust the arm width push the lever down and slide the arm to the desired position. Push the lever up to lock the arm in place.

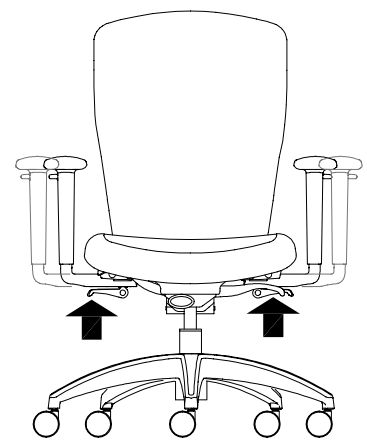

t-3 adjustment features & instructions (continued)

stool height-adjustment

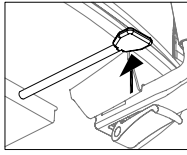

To raise the chair, lift the paddle up while lifting your weight from the seat until you reach the desired level and then release to lock in place. To lower the chair, lift the paddle up allowing your weight to push the seat down to the desired level and then release to lock in place.

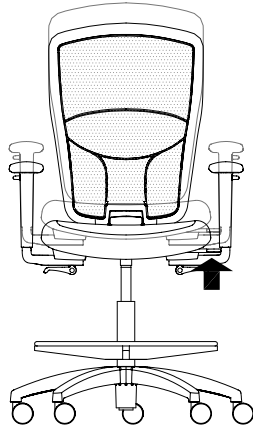

stool footring height-adjustment

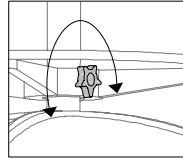

To raise or lower the stool's foot ring, turn the foot ring's knob counter clockwise to release the foot ring and adjust the ring until you reach the desired level. Turn the knob clockwise to lock in place.

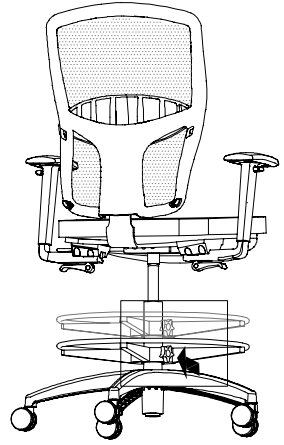

work chairs

Xpress

N X X Y

t-3 – Task Chair

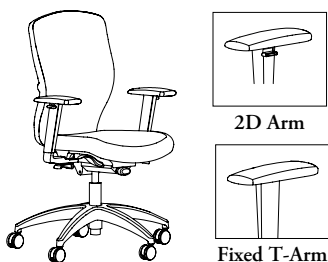

FEATURES

- Standard pneumatic cylinder provides height-adjustment of 4"
- Back-Tilt can be locked in five positions or left free flow
- Frame and 5-Star Base are Plastic
- Back Height-Adjustment of 2"
- Synchro-tilt 2.8:1 ratio
- Tilt control
- Hard casters are standard and are well suited for soft flooring such as carpeting
- Soft casters are available for use on hard flooring, such as wood, concrete, or tile

NOTES

Fully Upholstered: Fabric will be applied to both the seat and the back.

Mesh: Fabric will apply to the seat only.

Not all configurations are available as Xpress. Please see Xpress catalogue and/or specification software for details.

PRODUCT OPTIONS

Size	Mechanism Style	Arm Style	Upholstery/Back Style	Upholstery Finish	Cylinder Style	Frame and Base Finish	Casters/Glides (Optional)	Other Options
F Mid-Back	1 Standard	N No Arms F Fixed T-Arms W 2D Width and Height-Adjustable T-Arm (Shown)	M Mesh (Black) F Upholstered	Fabric Leather	1 Standard 2 High 3 Low	E Ebony	A Casters, Soft B Glides, Hard C Glides, Soft	Not Fully Assembled F Fully Assembled

SAMPLE ORDER CODE

NXXY F	1	W	F	M205	2	E	F
---------------	----------	----------	----------	-------------	----------	----------	----------

DESCRIPTION

MESH BACK (M)

No Arms
Fixed T-Arms
2D Width and Height-Adjustable T-Arms

PRICE

Grade 1	COM/Grade 2	COL/Grade 3	Grade 4	Grade 5	Grade 6	Grade 7	Grade 8	Grade 9	Grade 10
753	769	789	809	828	846	865	885	906	970
885	906	922	943	964	981	1000	1021	1038	1108
916	937	956	974	994	1014	1034	1053	1070	1140

No Arms

Fixed T-Arms
2D Width and Height-Adjustable T-Arms

Leather LA	Leather LB	Leather LC	Leather LD
970	1023	1143	1181
1108	1158	1275	1317
1140	1190	1312	1346

UPHOLSTERED BACK (F)

No Arms
Fixed T-Arms
2D Width and Height-Adjustable T-Arms

Grade 1	COM/Grade 2	COL/Grade 3	Grade 4	Grade 5	Grade 6	Grade 7	Grade 8	Grade 9	Grade 10
805	844	885	926	967	1008	1049	1088	1129	1270
941	980	1021	1063	1101	1144	1184	1225	1267	1405
980	1021	1063	1101	1144	1184	1225	1267	1302	1445

No Arms

Fixed T-Arms
2D Width and Height-Adjustable T-Arms

Leather LA	Leather LB	Leather LC	Leather LD
1270	1366	1608	1687
1405	1501	1742	1824
1445	1543	1784	1864

If Soft Casters (A) are specified	add 28
If Hard Glides (B) are specified	add 28
If Soft Glides (C) are specified	add 43
If Fully Assembled (F) is specified	add 5

FEATURES

- Standard pneumatic Cylinder provides height-adjustment of 7-1/2"
- Swivels 360°
- Arms and 5-Star Base finished in Ebony
- t-3 is BIFMA G1 compatible
- Hard casters are standard and are well suited for soft flooring such as carpeting
- Soft casters are available for use on hard flooring, such as wood, concrete, or tile

NOTES

Fully Upholstered: Fabric will be applied to both the seat and the back.

Mesh: Fabric will apply to the seat only.

N X X F
t-3 – Swivel Stool

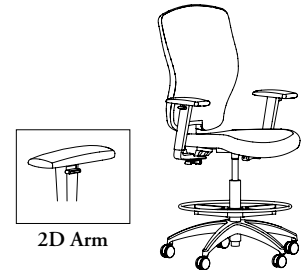

PRODUCT OPTIONS

Size	Mechanism Style	Arm Style	Upholstery/Back Style	Upholstery Finish	Frame and Base Finish	Casters/Glides (Optional)	Other Options
F Mid-Back	I Standard	N No Arms W 2D Width and Height-Adjustable T-Arm (Shown)	M Mesh F Upholstered	Fabric Leather	E Ebony	A Casters, Soft B Glides, Hard C Glides, Soft	F Fully Assembled

SAMPLE ORDER CODE

NXXF F	I	W	F	M205	E		F
---------------	----------	----------	----------	-------------	----------	--	----------

DESCRIPTION

PRICE

	Grade 1	COM/ Grade 2	COL/ Grade 3	Grade 4	Grade 5	Grade 6	Grade 7	Grade 8	Grade 9	Grade 10
MESH BACK (M)										
No Arms	841	862	882	905	920	943	964	981	1002	1070
2D Width and Height-Adjustable T-Arms	1017	1037	1058	1079	1097	1117	1140	1155	1180	1245
	Leather LA	Leather LB	Leather LC	Leather LD						
No Arms	1070	1115	1234	1271						
2D Width and Height-Adjustable T-Arms	1245	1290	1408	1447						
UPHOLSTERED BACK (F)										
No Arms	860	901	938	979	1020	1060	1100	1143	1183	1321
2D Width and Height-Adjustable T-Arms	1035	1072	1114	1152	1195	1237	1275	1318	1357	1496
	Leather LA	Leather LB	Leather LC	Leather LD						
No Arms	1321	1419	1658	1740						
2D Width and Height-Adjustable T-Arms	1496	1595	1833	1915						

If Soft Casters (A) are specified	add	28
If Hard Glides (B) are specified	add	28
If Soft Glides (C) are specified	add	43
If Fully Assembled (F) is specified	add	5

tone synchro-tilt task chair & stool overview

Quiet, yet spirited, design. Visually soft and minimalist, Tone is designed to blend seamlessly with its setting. Its rounded frame invites touch and a pure silhouette balances simplicity with superior comfort.

Tone allows for an expressive and efficient use of materials. Two different mesh styles are available in an uplifting color palette.

Thoughtful in each detail at an accessible price, Tone marries the needs of people, place and planet in an elegant whole.

Tone is available in a task chair and swivel stool. Task chair is available fully assembled or knocked down.

Tone Task Chair, Mesh Back (NTTM)



frame finishes



Ebony



Dimpse

performance/lifestyle mesh finishes



Pearl



Pebble



Charcoal



Onyx



Ochre



Rooibos



Umber



Coral



Eucalyptus



Indigo



Seaweed



Minit

statement of line

without lumbar



Task Chair –
No Arms
(NTTMN)



Task Chair –
2D Arms
(NTTMWN)



Task Chair –
4D Arms
(NTTMPN)

with lumbar



Task Chair –
No Arms
(NTTMNY)



Task Chair –
2D Arms
(NTTMWY)



Task Chair –
4D Arms
(NTTMPY)

tone synchro-tilt task chair & stool overview (continued)

Tone Swivel Stool, Mesh Back (NTDM)



frame finishes



Ebony



Dimpse



Pearl



Pebble



Charcoal



Onyx



Ochre



Rooibos



Umber



Coral



Eucalyptus



Indigo



Seaweed



Minuit

performance/lifestyle mesh finishes

statement of line

without lumbar



Swivel Stool –
No Arms
(NTDMNN)



Swivel Stool –
2D Arms
(NTDMWN)



Swivel Stool –
4D Arms
(NTDMPN)

with lumbar



Swivel Stool –
No Arms
(NTDMNY)



Swivel Stool –
2D Arms
(NTDMWY)



Swivel Stool –
4D Arms
(NTDMPY)

tone luum sleeve, tone chair & stool overview

Sleeve add-ons are tailor fitted to drape over the Tone back rest, utilizing the same chair to refresh a space with minimal additional investment. A curated collection of Luum textiles in a range of colors and patterns expands design options to create a more quite, or spirited, setting.

Tone Luum Sleeve can be ordered installed on the chair, on the stool or separately.

Tone Task Chair with Mesh Back & Luum Sleeve (NTTF)



Luum sleeve finishes:

- | | | | |
|------------------------|---------------------|------------------------|--------------------------|
| Bitstream (Grade 1) | Flex Wool (Grade 7) | Equilux (Grade 9) | Navigate (Grade 16) |
| Fundamentals (Grade 1) | Construct (Grade 8) | Heather Felt (Grade 9) | Second Nature (Grade 16) |
| Elastic Wool (Grade 4) | Full Wool (Grade 8) | Fleece (Grade 10) | |

frame finishes



performance/lifestyle mesh finishes



statement of line



Tone Task Chair, Mesh Back & Luum Sleeve (NTTFN) – Armless



Tone Task Chair, Mesh Back & Luum Sleeve (NTTFW) – 2D Arms



Tone Task Chair, Mesh Back & Luum Sleeve (NTTFP) – 4D Arms



Luum Sleeve (NTAF)

tone luum sleeve, tone chair & stool overview (continued)

Tone Swivel Stool, Mesh Back & Luum Sleeve (NTDF)



Luum sleeve finishes:

Bitstream (Grade 1)	Flex Wool (Grade 7)	Equilux (Grade 9)	Navigate (Grade 16)
Fundamentals (Grade 1)	Construct (Grade 8)	Heather Felt (Grade 9)	Second Nature (Grade 16)
Elastic Wool (Grade 4)	Full Wool (Grade 8)	Fleece (Grade 10)	

frame finishes



Ebony



Dimpse



Pearl



Pebble



Charcoal



Onyx



Ochre



Rooibos



Umber



Coral



Eucalyptus



Indigo



Seaweed



Minuit

performance/lifestyle mesh finishes

statement of line



Tone Swivel Stool, Mesh Back & Knit Sleeve (NTDFN) - Armless



Tone Swivel Stool, Mesh Back & Knit Sleeve (NTDFW) - 2D Arms



Tone Swivel Stool, Mesh Back & Knit Sleeve (NTDFP) - 4D Arms



Luum Sleeve (NTAF)

tone knit sleeve, tone chair & stool overview

An innovative knit sleeve, adapted from the organic structure of a leaf, adds tactile softness and comfort to the Tone chair. Artisanal in design and craftsmanship, dual yarn pairings create organic mélangé details. Made to fit, the knit sleeve adds texture with minimal fabric waste and environmental impact.

Tone Knit Sleeve can be ordered installed on the chair, on the stool or separately.

Tone Task Chair with Mesh Back & Knit Sleeve (NTTK)



frame finishes



mesh finishes

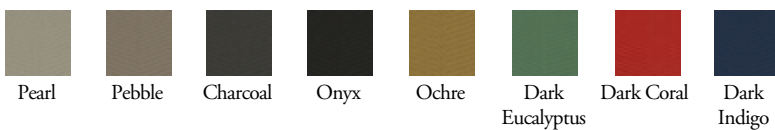

knit sleeve finishes

statement of line



Tone Task Chair, Mesh Back & Knit Sleeve (NTTKN) – Armless



Tone Task Chair, Mesh Back & Knit Sleeve (NTTKW) – 2D Arms



Tone Task Chair, Mesh Back & Knit Sleeve (NTTKP) – 4D Arms



Knit Sleeve (NTAK)

tone knit sleeve, tone chair & stool overview (continue)

Tone Swivel Stool, Mesh Back & Knit Sleeve (NTDK)



frame finishes



mesh finishes

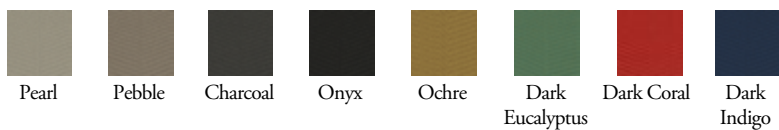

knit sleeve finishes

statement of line



Tone Swivel Stool, Mesh Back & Knit Sleeve (NTDKN) – Armless



Tone Swivel Stool, Mesh Back & Knit Sleeve (NTDKW) – 2D Arms



Tone Swivel Stool, Mesh Back & Knit Sleeve (NTDKP) – 4D Arms



Knit Sleeve (NTAK)

tone luum sleeve overview

Sleeve add-ons are tailor fitted to drape over the Tone back rest, utilizing the same chair to refresh a space with minimal additional investment. A curated collection of Luum textiles in a range of colors and patterns expands design options to create a more quiet, or spirited, setting.

Tone Luum Sleeves can also be ordered installed on the chair/stool. Please previous pages for product codes.

Tone Luum Sleeve (NTAF)

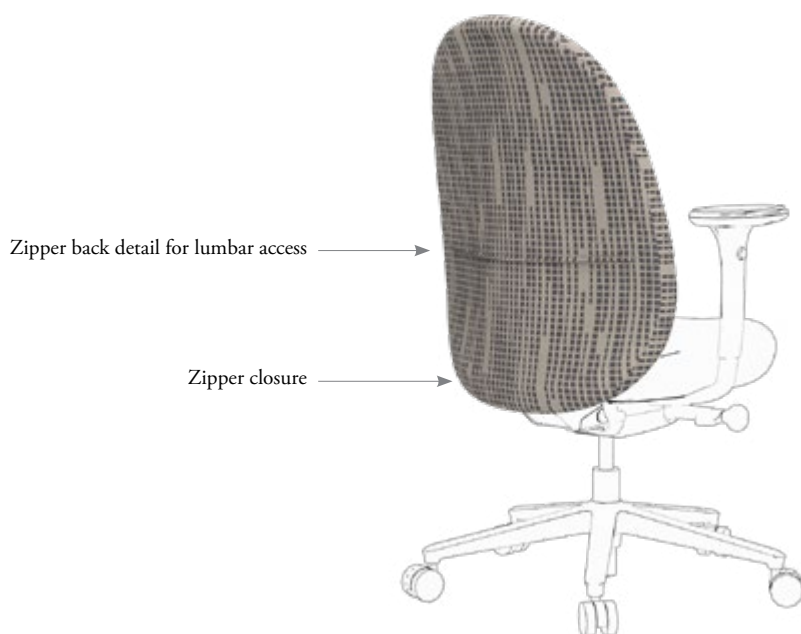

Luum sleeve finishes:

Bitstream (Grade 1)	Flex Wool (Grade 7)	Equilux (Grade 9)	Navigate (Grade 16)
Fundamentals (Grade 1)	Construct (Grade 8)	Heather Felt (Grade 9)	Second Nature (Grade 16)
Elastic Wool (Grade 4)	Full Wool (Grade 8)	Fleece (Grade 10)	

statement of line



Luum Sleeve
(NTAF)

tone knit sleeve overview

An innovative knit sleeve, adapted from the organic structure of a leaf, adds tactile softness and comfort to the Tone chair. Artisanal in design and craftsmanship, dual yarn pairings create organic mélangé details. Made to fit, the knit sleeve adds texture with minimal fabric waste and environmental impact.

Tone Knit Sleeves can also be ordered installed on the chair/stool. Please previous pages for product codes.

Tone Knit Sleeve (NTAK)



knit sleeve finishes



statement of line



Knit Sleeve
(NTAK)

tone dimensions & material requirements

features

- Designed and tested for users up to 300 lbs
- Meets ANSI/BIFMA Requirement

weight

Tone Task - Mesh, No Arms	31.5 lbs
Tone Task - Mesh, 2D Arms, 4D Arms	36.5 lbs

Task Chair

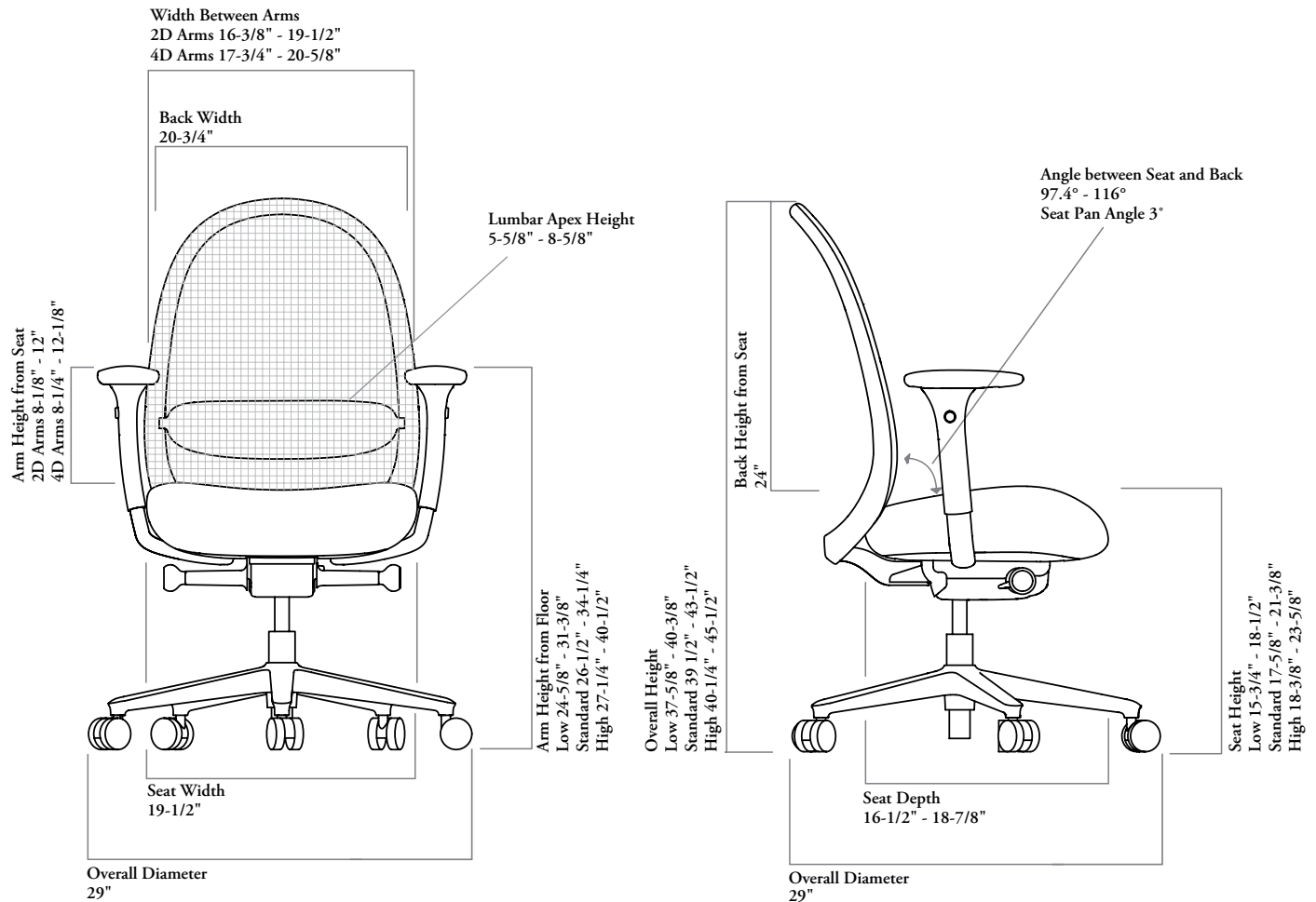

COM/COL material requirement

The pattern, repeat and directionality of fabric may increase the amount of yardage required.

Leather quantities should always be rounded up to the next hide size, as yields vary from 60-80% and are affected by the quality, size and shape of the hide, and by the location and quantity of blemishes.

SEAT ONLY		
	COM [yards]	COL [sq. ft.]
With Mesh Back	0.75	12.7

tone dimensions & material requirements (continued)

features

- Designed and tested for users up to 300 lbs
- Meets ANSI/BIFMA Requirement

weight

Swivel Stool - Mesh, No Arms	36.5 lbs
Swivel Stool - Mesh, 2D Arms, 4D Arms	41.5 lbs

Swivel Stool

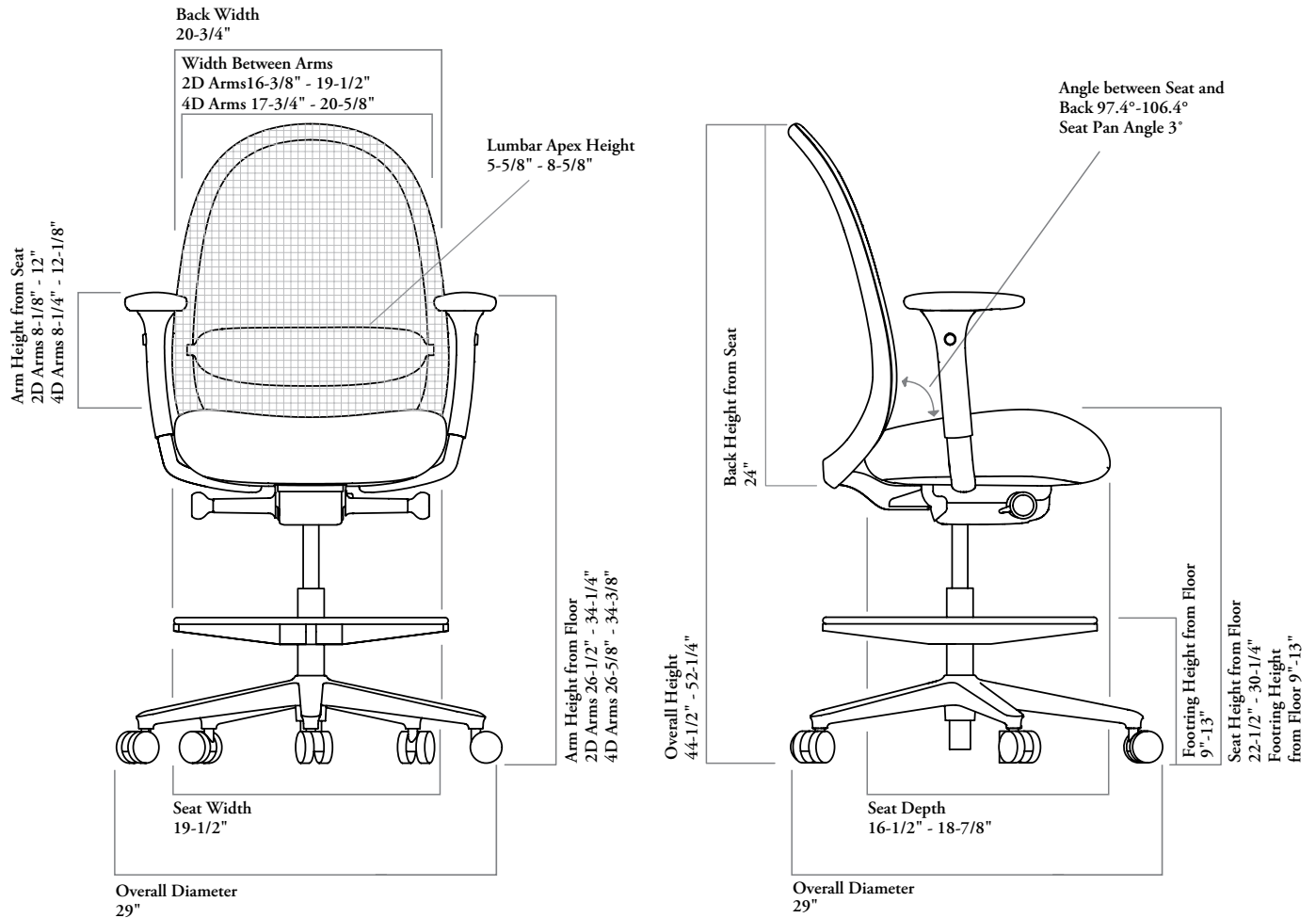

COM/COL material requirement

The pattern, repeat and directionality of fabric may increase the amount of yardage required.

Leather quantities should always be rounded up to the next hide size, as yields vary from 60-80% and are affected by the quality, size and shape of the hide, and by the location and quantity of blemishes.

SEAT ONLY

	COM [yards]	COL [sq. ft]
With Mesh Back	0.75	12.7

tone adjustment features & instructions

tilt tension adjustment

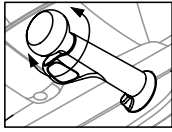

Rotating the knob found under the right side of the seat increases or reduces the resistance of the reclining chair back. Rotate forward to tighten tension. Rotate knob backwards to loosen tension.

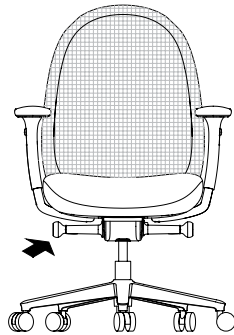

back tilt lock adjustment

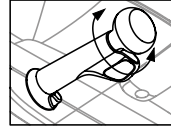

Turning the knob found under the left side of the seat locks and unlocks the recline. Rotate backwards to unlock and rotate forward to lock. To reset the chair to an upright position, unlock and completely recline the chair back. Chair can be locked in four positions.

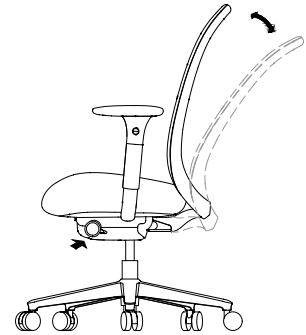

arm width, depth and pivot adjustment

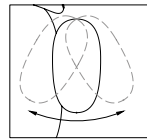
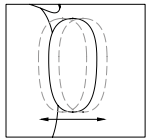

To adjust the width of the 2D and 4D arms, grab the arm pad on both sides and push to the left or right to the desired position.

For the 4D arm option, simultaneously pivot the arm pad inward or outward to desired angle. Arm pad depth can be controlled by grabbing the pad and sliding it forward or backward.

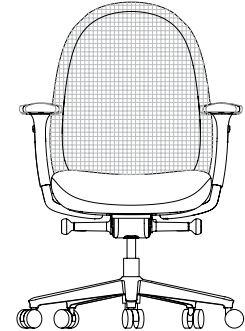
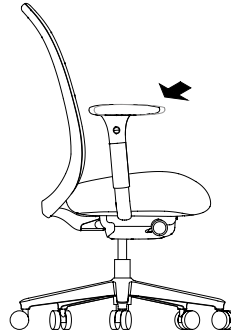
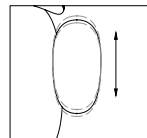

arm height-adjustment

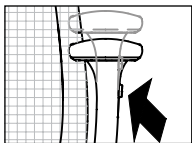

To adjust the arm height, press the button below either arm rest to raise or lower it to the desired position.

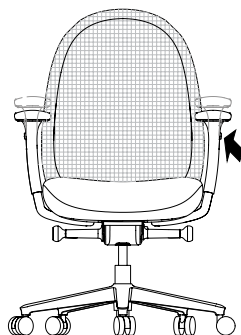

seat height-adjustment

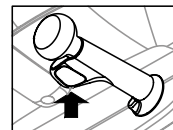

Seat height can be adjusted by pulling the lever underneath the seat on the right side. When the lever is pulled upward, the weight of the body will cause the seat to lower, and releasing it stops the seat at the desired height. Pulling up on the lever with no weight on the seat allows it to rise.

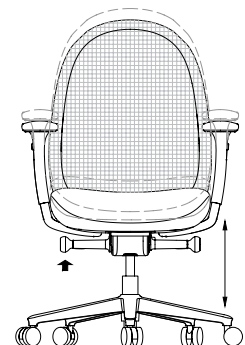

tone adjustment features & instructions (continued)

lumbar support height-adjustment

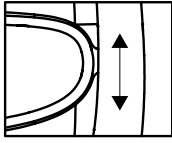

While sitting on the chair, put arms behind back to grab both ends of the lumbar support element. Slide lumbar up or down to required height.

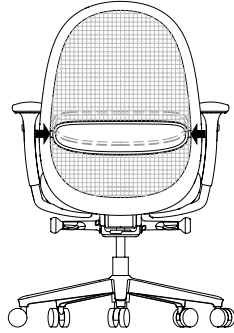

seat depth adjustment

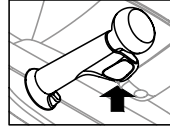

Seat depth adjustment can be found under the left hand side of the seat. To adjust the seat depth, pull the lever upward and simultaneously lift your weight from the seat while sliding the seat forward. For either direction, release the lever to lock the seat in place.

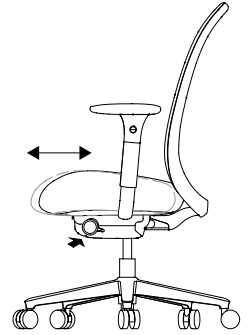

foot ring adjustment (stool)

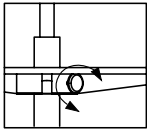

To raise or lower the stool's foot ring, turn the foot ring's knob counter-clockwise to release the foot ring and adjust the ring until you reach the desired level. Turn the knob clockwise to lock into place.

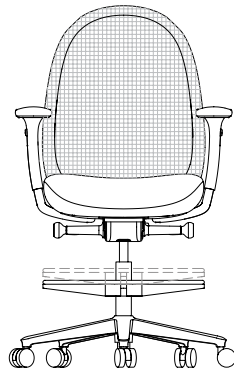

planning with tone task chair & stool

workplace

Planning with Tone chair for Workplace space.



private space

Planning with Tone chair with Knit Sleeve for private space.



collaborative space

Planning with Tone chair with LUUM Sleeve for collaboration space.



home office

Planning with Tone chair with LUUM Sleeve for home office.



work chairs

NTTM Tone Task Chair, Mesh Back



FEATURES

- Full synchro-tilt mechanism (2.5:1 tilt ratio) with four position lock
- Reclining tension adjustment
- Standard pneumatic cylinder provides a height-adjustment of 4" for task chair
- Seat depth adjustment of 2-3/8"
- Available armless, with 2D arms (height and width) or 4D arms (height, width, depth and pivot) adjustments
- Optional 3" height-adjustable lumbar support
- Frame finish available in Ebony or Dimpse with 5-star base defaulting to match frame finish
- Back available in lifestyle or performance mesh, 12 color options
- Hard casters are standard and are well suited for soft flooring such as carpeting
- Soft casters are available for use on hard flooring, such as wood, concrete or tile
- Hard and soft glides also available

NOTES

Caster finish will default to co-ordinate with frame finish. Dimpse frame finish will have Grey casters/Grey glides. Ebony frame finish will have Ebony casters/Ebony glides. Assembly Required (K) is shipped knocked down and customer is responsible for assembly.

PRODUCT OPTIONS

Arm Style	Lumbar Support	Back Mesh Finish	Seat Upholstery Finish	Cylinder Style	Frame Finish	Casters/ Glides	Assembly Style
N No Arms	N No Lumbar Support	Tone Performance Mesh	Fabric	1 Standard	8B Ebony	Hard Casters	F Fully Assembled
W 2D Arms	Y With Lumbar Support	Tone Lifestyle Mesh	Leather	2 High	GQ Dimpse	A Soft Casters	K Assembly Required
P 4D Arms				3 Low		B Hard Glides	

SAMPLE ORDER CODE

NTTM N	Y	KK01	E523	1	8B	A	F
---------------	----------	-------------	-------------	----------	-----------	----------	----------

DESCRIPTION

PRICE

	Grade 1	COM/ Grade 2	COL/ Grade 3	Grade 4	Grade 5	Grade 6	Grade 7	Grade 8	Grade 9	Grade 10
No Arms, No Lumbar Support	798	826	854	882	910	938	966	994	1022	1050
No Arms, With Lumbar Support	825	853	881	909	937	965	993	1021	1049	1077
2D Arms, No Lumbar Support	872	900	928	956	984	1012	1040	1068	1096	1124
2D Arms, With Lumbar Support	899	927	955	983	1011	1039	1067	1095	1123	1151
4D Arms, No Lumbar Support	903	931	959	987	1015	1043	1071	1099	1127	1155
4D Arms, With Lumbar Support	930	958	986	1014	1042	1070	1098	1126	1154	1182
	Leather LA	Leather LB	Leather LC	Leather LD						
No Arms, No Lumbar Support	1078	1106	1134	1162						
No Arms, With Lumbar Support	1105	1133	1161	1189						
2D Arms, No Lumbar Support	1152	1180	1208	1236						
2D Arms, With Lumbar Support	1179	1207	1235	1263						
4D Arms, No Lumbar Support	1183	1211	1239	1267						
4D Arms, With Lumbar Support	1210	1238	1266	1294						

If Soft Casters (A) are specified add 18
 If Hard Glides (B) are specified add 96
 If Soft Glides (C) are specified add 142
 If Frame Finish, Dimpse (GQ) is specified add 121

FEATURES

- Full synchro-tilt mechanism (2.5:1 tilt ratio) with four position lock
- Reclining tension adjustment
- Standard pneumatic cylinder provides a height-adjustment of 7-3/4" for stool
- Seat depth adjustment of 2-3/8"
- Available armless, with 2D arms (height and width) or 4D (height, width, depth and pivot) adjustments
- Optional 3" height-adjustable lumbar support
- Frame finish available in Ebony or Dimpse
- Swivel Stool includes an Aluminum foot ring
- Back available in lifestyle or performance mesh, 12 color options
- Hard casters are standard and are well suited for soft flooring such as carpeting
- Soft casters are available for use on hard flooring, such as wood, concrete or tile
- Hard and soft glides also available

NOTES

Caster finish will default to frame finish. Dimpse frame finish will have Grey casters/Grey glides. Ebony frame finish will have Ebony casters/Ebony glides. Stool is shipped semi knocked down and customer is responsible for assembly.

**NTDM
Tone Swivel Stool, Mesh Back**



PRODUCT OPTIONS

Arm Style	Lumbar Element	Back Mesh Finish	Seat Upholstery Finish	Frame Finish	Casters/ Glides
N No Arms	N No Lumbar Support	Tone Performance Mesh	Fabric	8B Ebony	Hard Casters
W 2D Arms	Y With Lumbar Support	Tone Lifestyle Mesh	Leather	GQ Dimpse	A Soft Casters
P 4D Arms					B Hard Glides
					C Soft Glides

SAMPLE ORDER CODE

NTDM N	Y	KK01	E523	8B	A
---------------	----------	-------------	-------------	-----------	----------

DESCRIPTION

PRICE

	Grade 1	COM/ Grade 2	COL/ Grade 3	Grade 4	Grade 5	Grade 6	Grade 7	Grade 8	Grade 9	Grade 10
No Arms, No Lumbar Support	947	975	1003	1031	1059	1087	1115	1143	1171	1199
No Arms, With Lumbar Support	974	1002	1030	1058	1086	1114	1142	1170	1198	1226
2D Arms, No Lumbar Support	1021	1049	1077	1105	1133	1161	1189	1217	1245	1273
2D Arms, With Lumbar Support	1048	1076	1104	1132	1160	1188	1216	1244	1272	1300
4D Arms, No Lumbar Support	1052	1080	1108	1136	1164	1192	1220	1248	1276	1304
4D Arms, With Lumbar Support	1079	1107	1135	1163	1191	1219	1247	1275	1303	1331
	Leather LA	Leather LB	Leather LC	Leather LD						
No Arms, No Lumbar Support	1227	1255	1283	1311						
No Arms, With Lumbar Support	1254	1282	1310	1338						
2D Arms, No Lumbar Support	1301	1329	1357	1385						
2D Arms, With Lumbar Support	1328	1356	1384	1412						
4D Arms, No Lumbar Support	1332	1360	1388	1416						
4D Arms, With Lumbar Support	1359	1387	1415	1443						

If Soft Casters (A) are specified add 18
 If Hard Glides (B) are specified add 96
 If Soft Glides (C) are specified add 142
 If Frame Finish, Dimpse (GQ) is specified add 121

NTTF

Tone Task Chair, Mesh Back & Luum Sleeve



FEATURES

- Luum sleeve comes installed
- Full synchro-tilt mechanism (2.5:1 tilt ratio) with four position lock
- Reclining tension adjustment
- Standard pneumatic cylinder provides a height-adjustment of 4" for task chair
- Seat depth adjustment of 2-3/8"
- Available armless, with 2D arms (height and width) or 4D arms (height, width, depth and pivot) adjustments
- Optional 3" height-adjustable lumbar support
- Frame finish available in ebony or dimpse with 5-star base defaulting to frame finish
- Back available in lifestyle or performance mesh, 12 color options
- Hard casters are standard and are well suited for soft flooring such as carpeting
- Soft casters are available for use on hard flooring, such as wood, concrete or tile
- Hard and soft glides also available

NOTES

Caster finish will default to co-ordinate with frame finish. Dimpse frame finish will have Grey casters / Grey glides. Ebony frame finish will have Ebony casters/Ebony glides. Assembly Required (K) is shipped knocked down and customer is responsible for assembly.

PRODUCT OPTIONS

Arm Style	Lumbar Support	Back Mesh Finish	Seat Upholstery Finish	Back Fabric Sleeve Finish
N No Arms	N Lumbar Support	Tone Performance Mesh	Fabric	Fabric
W 2D Arms	Y With Lumbar Support	Tone Lifestyle Mesh	Leather	
P 4D Arms				

SAMPLE ORDER CODE

NTTF N	Y	KK01	E523	E523
---------------	----------	-------------	-------------	-------------

PRODUCT OPTIONS (CONTINUED)

Cylinder Style	Frame Finish	Casters/Glides	Assembly Style
1 Standard	8B Ebony	Hard Casters	F Fully Assembled
2 High	GQ Dimpse	A Soft Casters	K Assembly Required
3 Low		B Hard Glides	
		C Soft Glides	

SAMPLE ORDER CODE (CONTINUED)

1	8B	A	F
----------	-----------	----------	----------

See pricing on the following page.

NTTF
Tone Task Chair, Mesh Back
& Luum Sleeve (Continued)

DESCRIPTION	PRICE									
	Grade 1	COM/ Grade 2	COL/ Grade 3	Grade 4	Grade 5	Grade 6	Grade 7	Grade 8	Grade 9	Grade 10
No Arms, No Lumbar Support	798	826	854	882	910	938	966	994	1022	1050
No Arms, With Lumbar Support	825	853	881	909	937	965	993	1021	1049	1077
2D Arms, No Lumbar Support	872	900	928	956	984	1012	1040	1068	1096	1124
2D Arms, With Lumbar Support	899	927	955	983	1011	1039	1067	1095	1123	1151
4D Arms, No Lumbar Support	903	931	959	987	1015	1043	1071	1099	1127	1155
4D Arms, With Lumbar Support	930	958	986	1014	1042	1070	1098	1126	1154	1182
	Leather	Leather	Leather	Leather						
	LA	LB	LC	LD						
No Arms, No Lumbar Support	1078	1106	1134	1162						
No Arms, With Lumbar Support	1105	1133	1161	1189						
2D Arms, No Lumbar Support	1152	1180	1208	1236						
2D Arms, With Lumbar Support	1179	1207	1235	1263						
4D Arms, No Lumbar Support	1183	1211	1239	1267						
4D Arms, With Lumbar Support	1210	1238	1266	1294						

Add the below based on the Luum Sleeve grade chosen for (NTTF)

	Grade 1	Grade 4	Grade 7	Grade 8	Grade 9	Grade 10	Grade 16
Luum Sleeve Grade	180	255	330	355	380	405	555

- If Soft Casters (A) are specified add 18
- If Hard Glides (B) are specified add 96
- If Soft Glides (C) are specified add 142
- If Frame Finish, Dimpse (GQ) is specified add 121

work chairs

NTDF

Tone Swivel Stool, Mesh Back & Luum Sleeve

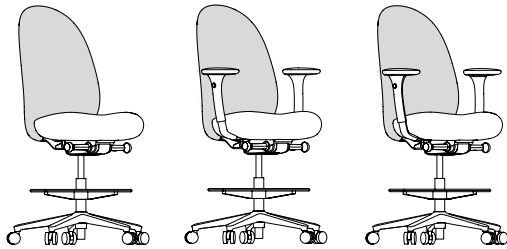

FEATURES

- Luum sleeve comes installed
- Full synchro-tilt mechanism with four position lock
- Reclining tension adjustment
- Standard pneumatic cylinder provides a height-adjustment of 7-3/4" for stool
- Seat depth adjustment of 2-3/8"
- Available armless, with 2D arms (height and width) or 4D arms (height, width, depth and pivot) adjustments
- Optional 3" height-adjustable lumbar support
- Frame finish available in ebony or dimpse
- Swivel Stool includes an Aluminum Foot Ring
- Back available in lifestyle or performance mesh, 12 color options
- Hard casters are standard and are well suited for soft flooring such as carpeting
- Soft casters are available for use on hard flooring, such as wood, concrete or tile
- Hard and soft glides also available

NOTES

Caster finish will default to frame finish. Dimpse frame finish will have Grey casters/Grey glides. Ebony frame finish will have Ebony casters/Ebony glides. Stool is shipped semi knocked down and customer is responsible for assembly.

PRODUCT OPTIONS

Arm Style	Lumbar Element	Back Mesh Finish	Seat Upholstery Finish	Back Fabric Sleeve Finish	Frame Finish	Casters/ Glides
N No Arms	N No Lumbar Support	Tone Performance Mesh	Fabric	Fabric	8B Ebony	Hard Casters
W 2D Arms	Y With Lumbar Support	Tone Lifestyle Mesh	Leather		GQ Dimpse	A Soft Casters
P 4D Arms						B Hard Glides
						C Soft Glides

SAMPLE ORDER CODE

NTDF N	Y	KK01	E523	E523	8B	A
---------------	----------	-------------	-------------	-------------	-----------	----------

DESCRIPTION

PRICE

	Grade 1	COM/ Grade 2	COL/ Grade 3	Grade 4	Grade 5	Grade 6	Grade 7	Grade 8	Grade 9	Grade 10
No Arms, No Lumbar Support	947	975	1003	1031	1059	1087	1115	1143	1171	1199
No Arms, With Lumbar Support	974	1002	1030	1058	1086	1114	1142	1170	1198	1226
2D Arms, No Lumbar Support	1021	1049	1077	1105	1133	1161	1189	1217	1245	1273
2D Arms, With Lumbar Support	1048	1076	1104	1132	1160	1188	1216	1244	1272	1300
4D Arms, No Lumbar Support	1052	1080	1108	1136	1164	1192	1220	1248	1276	1304
4D Arms, With Lumbar Support	1079	1107	1135	1163	1191	1219	1247	1275	1303	1331
	Leather LA	Leather LB	Leather LC	Leather LD						
No Arms, No Lumbar Support	1227	1255	1283	1311						
No Arms, With Lumbar Support	1254	1282	1310	1338						
2D Arms, No Lumbar Support	1301	1329	1357	1385						
2D Arms, With Lumbar Support	1328	1356	1384	1412						
4D Arms, No Lumbar Support	1332	1360	1388	1416						
4D Arms, With Lumbar Support	1359	1387	1415	1443						

Add the below based on the Luum Sleeve grade chosen for (NTDF)

Luum Sleeve Grade	Grade 1	Grade 4	Grade 7	Grade 8	Grade 9	Grade 10	Grade 16
	180	255	330	355	380	405	555

If Soft Casters (A) are specified	add 18
If Hard Glides (B) are specified	add 96
If Soft Glides (C) are specified	add 142
If Frame Finish, Dimpse (GQ) is specified	add 121

NTTK Tone Task Chair, Mesh Back & Knit Sleeve



FEATURES

- Luum sleeve comes installed
- Full synchro-tilt mechanism (2.5:1 tilt ratio) with four position lock
- Reclining tension adjustment
- Standard pneumatic cylinder provides a height-adjustment of 4" for task chair
- Seat depth adjustment of 2-3/8"
- Available armless, with 2D arms (height and width) or 4D arms (height, width, depth and pivot) adjustments
- Optional 3" height-adjustable lumbar support
- Frame finish available in Ebony or Dimpse with 5-star base defaulting to frame finish
- Back available in lifestyle or performance mesh, 12 color options
- Hard casters are standard and are well suited for soft flooring such as carpeting
- Soft casters are available for use on hard flooring, such as wood, concrete or tile
- Hard and soft glides also available

NOTES

Caster finish will default to co-ordinate with frame finish. Dimpse frame finish will have Grey casters/Grey glides. Ebony frame finish will have Ebony casters/Ebony glides.

Assembly Required (K) is shipped knocked down and customer is responsible for assembly.

PRODUCT OPTIONS

Arm Style	Lumbar Support	Back Mesh Finish	Seat Upholstery Finish	Back Knit Sleeve Finish
N No Arms	N Lumbar Support	Tone Performance Mesh	Fabric	Tone Knit
W 2D Arms	Y With Lumbar Support	Tone Lifestyle Mesh	Leather	
P 4D Arms				

SAMPLE ORDER CODE

NTTK N	Y	KK01	E523	KN22
---------------	----------	-------------	-------------	-------------

PRODUCT OPTIONS (CONTINUED)

Cylinder Style	Frame Finish	Casters/Glides	Assembly Style
1 Standard	8B Ebony	Hard Casters	F Fully Assembled
2 High	GQ Dimpse	A Soft Casters	K Assembly Required
3 Low		B Hard Glides	
		C Soft Glides	

SAMPLE ORDER CODE (CONTINUED)

1	8B	A	F
----------	-----------	----------	----------

See pricing on the following page.

NTTK
Tone Task Chair, Mesh Back
& Knit Sleeve (Continued)

DESCRIPTION	PRICE									
	Grade 1	COM/ Grade 2	COL/ Grade 3	Grade 4	Grade 5	Grade 6	Grade 7	Grade 8	Grade 9	Grade 10
No Arms, No Lumbar Support	1178	1206	1234	1262	1290	1318	1346	1374	1402	1430
No Arms, With Lumbar Support	1205	1233	1261	1289	1317	1345	1373	1401	1429	1457
2D Arms, No Lumbar Support	1252	1280	1308	1336	1364	1392	1420	1448	1476	1504
2D Arms, With Lumbar Support	1279	1307	1335	1363	1391	1419	1447	1475	1503	1531
4D Arms, No Lumbar Support	1283	1311	1339	1367	1395	1423	1451	1479	1507	1535
4D Arms, With Lumbar Support	1310	1338	1366	1394	1422	1450	1478	1506	1534	1562
	Leather LA	Leather LB	Leather LC	Leather LD						
No Arms, No Lumbar Support	1458	1486	1514	1542						
No Arms, With Lumbar Support	1485	1513	1541	1569						
2D Arms, No Lumbar Support	1532	1560	1588	1616						
2D Arms, With Lumbar Support	1559	1587	1615	1643						
4D Arms, No Lumbar Support	1563	1591	1619	1647						
4D Arms, With Lumbar Support	1590	1618	1646	1674						

If Soft Casters (A) are specified add 18
 If Hard Glides (B) are specified add 96
 If Soft Glides (C) are specified add 142
 If Frame Finish, Dimpse (GQ) is specified add 121

NTDK Tone Swivel Stool, Mesh Back & Knit Sleeve



FEATURES

- Luum sleeve comes installed
- Full synchro-tilt mechanism with 4 position lock
- Reclining tension adjustment
- Standard pneumatic cylinder provides a height-adjustment of 7-3/4" for stool
- Seat depth adjustment of 2-3/8"
- Available armless, with 2D arms (height and width) or 4D (height, width, depth and pivot) adjustments
- Optional 3" height-adjustable lumbar support
- Frame finish available in Ebony or Dimpse
- Swivel Stool includes an Aluminum foot ring
- Back available in lifestyle or performance mesh, 12 color options
- Hard casters are standard and are well suited for soft flooring such as carpeting
- Soft casters are available for use on hard flooring, such as wood, concrete or tile
- Hard and soft glides also available

NOTES

Caster finish will default to frame finish. Dimpse frame finish will have Grey casters/Grey glides. Ebony frame finish will have Ebony casters/Ebony glides.
Stool is shipped semi knocked down and customer is responsible for assembly.

PRODUCT OPTIONS

Arm Style	Lumbar Element	Back Mesh Finish	Seat Upholstery Finish	Back Knit Sleeve Finish	Frame Finish	Casters/ Glides
N No Arms	N No Lumbar Support	Tone Performance Mesh	Fabric	Tone Knit	8B Ebony	Hard Casters
W 2D Arms	Y With Lumbar Support	Tone Lifestyle Mesh	Leather		GQ Dimpse	A Soft Casters
P 4D Arms						B Hard Glides C Soft Glides

SAMPLE ORDER CODE

NTDK N	Y	KK01	E523	KN22	8B	A
---------------	----------	-------------	-------------	-------------	-----------	----------

DESCRIPTION

PRICE

	Grade 1	COM/ Grade 2	COL/ Grade 3	Grade 4	Grade 5	Grade 6	Grade 7	Grade 8	Grade 9	Grade 10
No Arms, No Lumbar Support	1327	1355	1383	1411	1439	1467	1495	1523	1551	1579
No Arms, With Lumbar Support	1354	1382	1410	1438	1466	1494	1522	1550	1578	1606
2D Arms, No Lumbar Support	1401	1429	1457	1485	1513	1541	1569	1597	1625	1653
2D Arms, With Lumbar Support	1428	1456	1484	1512	1540	1568	1596	1624	1652	1680
4D Arms, No Lumbar Support	1432	1460	1488	1516	1544	1572	1600	1628	1656	1684
4D Arms, With Lumbar Support	1459	1487	1515	1543	1571	1599	1627	1655	1683	1711
	Leather LA	Leather LB	Leather LC	Leather LD						
No Arms, No Lumbar Support	1607	1635	1663	1691						
No Arms, With Lumbar Support	1634	1662	1690	1718						
2D Arms, No Lumbar Support	1681	1709	1737	1765						
2D Arms, With Lumbar Support	1708	1736	1764	1792						
4D Arms, No Lumbar Support	1712	1740	1768	1796						
4D Arms, With Lumbar Support	1739	1767	1795	1823						

If Soft Casters (A) are specified add 18
 If Hard Glides (B) are specified add 96
 If Soft Glides (C) are specified add 142
 If Frame Finish, Dimpse (GQ) is specified add 121

FEATURES

- Retrofittable on all Tone Task Chairs and Stools
- Back zipper allows lumbar access
- Bottom zipper closure
- Available in 11 Luum collections
- Bitstream, Fundamentals, Elastic Wool , Flex Wool, Construct, Equilux, Heather Felt, Fleece, Navigate

**NTAF
Tone Luum Sleeve**

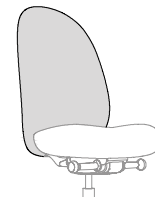

PRODUCT OPTIONS

Back Mesh Finish

Fabric

SAMPLE ORDER CODE

NTAF E523

DESCRIPTION

PRICE

	Grade 1	Grade 4	Grade 7	Grade 8	Grade 9	Grade 10	Grade 16
Tone Luum Sleeve	220	295	370	395	420	445	595

NTAK **Tone Knit Sleeve**

FEATURES

- Retrofittable on all Tone Task Chairs and Stools
- Venation detailing
- Bottom zipper closure
- Available in eight color options

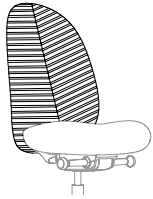

PRODUCT OPTIONS

Back Knit Sleeve Finish

Tone Knit

SAMPLE ORDER CODE

NTAK KN22

PRICING

420

visio chair overview

Visio elevates the affordable work chair.

Simple and polished, Visio has a lighter scale and a slim, graceful profile with mesh back that molds to the body for essential support. A comfortable chair with refined details, Visio offers discreet ergonomics that suit the corporate or residential setting.

Visio Chair, Mesh Back (NTEU)



fabric finishes (grade 2 percept)

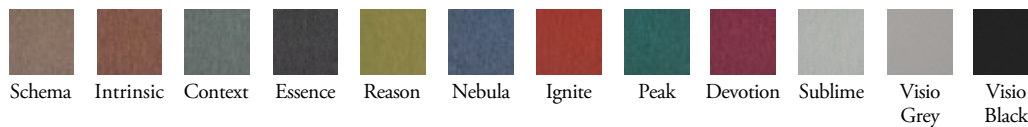

mesh & frame finishes



Note: Only applicable to chairs with "Fully Assembled (F)" selected.

statement of line



Visio Chair,
Mesh Back
(NTEU)

visio chair dimensions & material requirements

features

- Designed and tested for users up to 275 lbs
- Meets ANSI/BIFMA requirement

weight

Visio Chair, Mesh Back 31 lbs

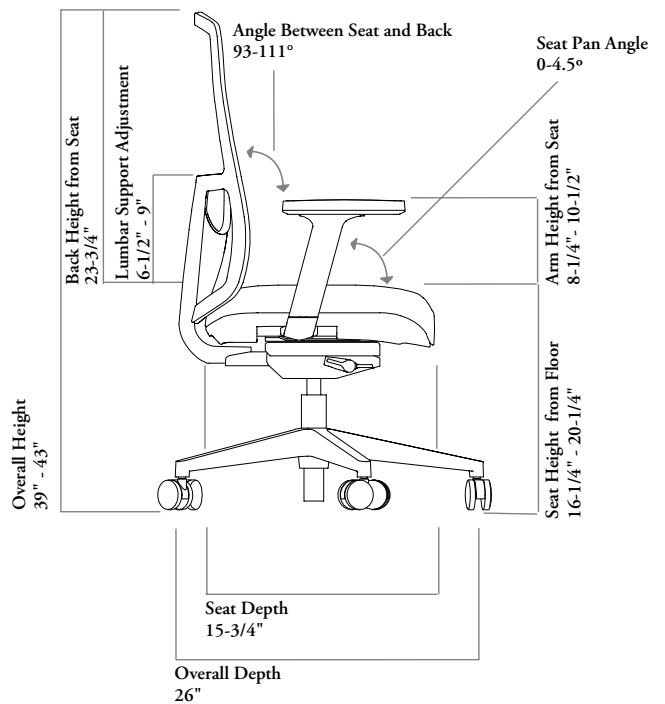
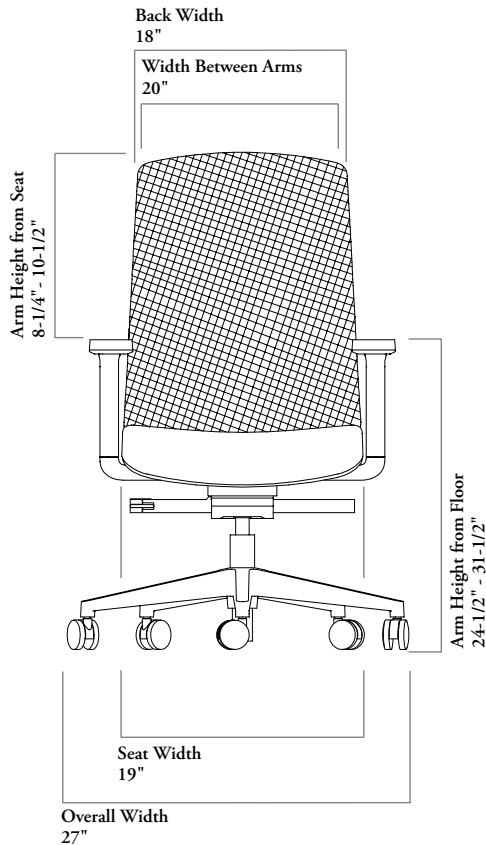

COM/COL material requirement

The pattern, repeat and directionality of fabric may increase the amount of yardage required.

Leather quantities should always be rounded up to the next hide size, as yields vary from 60-80% and are affected by the quality, size and shape of the hide, and by the location and quantity of blemishes.

SINGLE UPHOLSTERED

	COM [yards]	COL [sq. ft]
Visio Chair, Mesh Back	1	6.00

visio chair adjustment features & instructions

seat height-adjustment



To raise the chair, lift the lever up while lifting your weight from the seat until you reach the desired level, then release to lock in place. To lower the chair, lift the lever up and allow your weight to push the seat down until you reach the desired level, then release to lock in place.

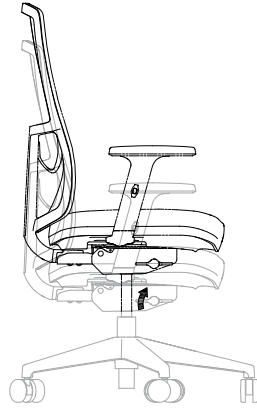

seat depth-adjustment

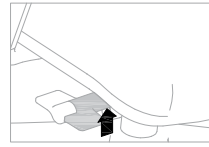

To adjust the seat depth, push the lever down and simultaneously lift your weight from the seat while sliding the seat forward or backward. Release the lever to lock the seat in place.

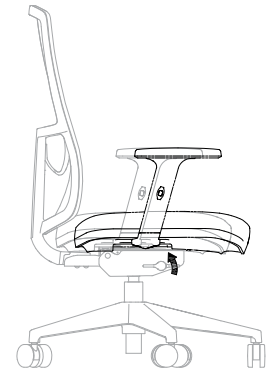

back tilt lock adjustment

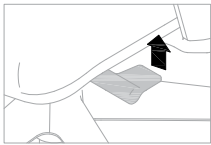

The chair is in free flow mode when the lever is in a level position. While in free flow mode, recline to the desired position and then twist the lever forward to lock.

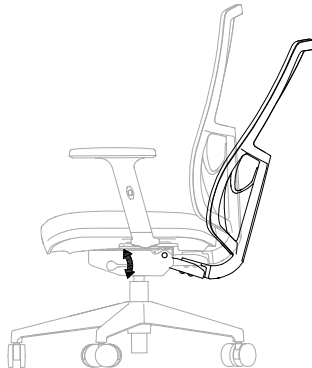

lumbar height-adjustment

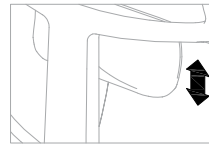

While sitting in the chair, put arms behind backrest to grab both sides of lumbar element and slide lumbar up or down to the desired position.

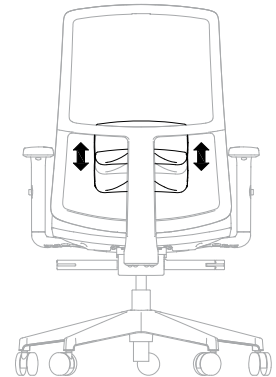

arm height adjustment

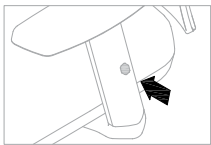

To adjust arm height, press the button in the middle of arm rest to raise or lower it to the desired position. Release the button to lock in place.

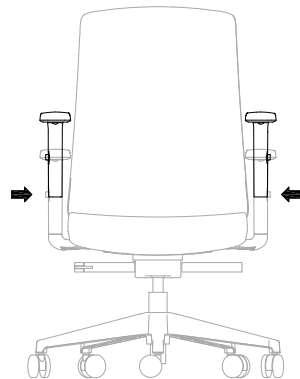

FEATURES

- Mesh back and fabric seat
- Height- Adjustable Arms
- Nylon base with 60mm soft casters
- Weight-balanced synchronized mechanism with height-adjustment, back tilt and tilt lock at 3 positions
- Lumbar support height-adjustment of 2.5"
- Designed and tested for users up to 275 lbs

NOTES

Item can be ordered Fully Assembled or Assembly Required.
Grade 2 Percept Upholstery Finish is only available when Fully Assembled (F) is selected.

**N T E U
Visio Chair, Mesh Back**



Mesh Back

PRODUCT OPTIONS

Arm Style	Assembly Style	Mesh / Frame Finish	Upholstery Finish
H Height-Adjustable Arms	K Assembly Required	52 Ebony Coordinate	VC01 Visio Fabric Black
	F Fully Assembled	30 Grey Coordinate	VC02 Visio Fabric Grey
			P106 Schema
			P108 Intrinsic
			P110 Sublime
			P111 Context
			P112 Essence
			P117 Reason
			P119 Nebula
			P121 Ignite
			P123 Peak
			P124 Devotion

SAMPLE ORDER CODE

NTEU H	K	52	VC01
---------------	----------	-----------	-------------

DESCRIPTION

PRICE

ASSEMBLY REQUIRED (K)

Standard Fabric

Ebony Coordinate Mesh / Frame

698

Grey Coordinate Mesh / Frame

735

FULLY ASSEMBLED (F)

Standard Fabric Grade 2 - Percept

Ebony Coordinate Mesh / Frame

850

907

Grey Coordinate Mesh / Frame

887

944

multi-use chairs

multi-use chairs

PRODUCT MAP / TABLE OF CONTENTS	184
ABILITY OVERVIEW	188
ABILITY DIMENSIONS & MATERIAL REQUIREMENTS	189
ABILITY PRODUCT LISTING	190
AROUND GUEST CHAIR OVERVIEW	194
AROUND GUEST DIMENSIONS & MATERIAL REQUIREMENTS	194
AROUND GUEST PRODUCT LISTING	196
 AROUND CONFERENCE CHAIR OVERVIEW	198
AROUND CONFERENCE DIMENSIONS & MATERIAL REQUIREMENTS	200
AROUND CONFERENCE CHAIR ADJUSTMENT FEATURES	201
AROUND CONFERENCE PRODUCT LISTING	202
JUST-US CHAIR OVERVIEW	204
JUST-US CHAIR DIMENSIONS & MATERIAL REQUIREMENTS	205
JUST-US CHAIR ADJUSTMENT FEATURES	205
PLANNING WITH JUST-US CHAIR	207
JUST-US PRODUCT LISTING	208
KUPP CHAIR OVERVIEW	210
KUPP CHAIR DIMENSIONS & MATERIAL REQUIREMENTS	212
PLANNING WITH KUPP CHAIR	214
KUPP PRODUCT LISTING	216
OCCO CHAIR OVERVIEW	220
OCCO CHAIR DIMENSIONS & MATERIAL REQUIREMENTS	222
PLANNING WITH OCCO CHAIR	224
OCCO CHAIR PRODUCT LISTING	226
SITARA OVERVIEW	228
SITARA DIMENSIONS & MATERIAL REQUIREMENTS	229
SITARA PRODUCT LISTING	230
UNDERSTANDING SPROUT STOOL AND TABLES	232
SPROUT STOOL OVERVIEW	233
SPROUT DIMENSIONS & MATERIAL REQUIREMENTS	234
PLANNING WITH SPROUT STOOLS	235
SPROUT TABLE OVERVIEW	237
SPROUT TABLES DIMENSIONS & MATERIAL REQUIREMENTS	239
PLANNING WITH SPROUT TABLES	242
SPROUT PRODUCT LISTING	244

CONTINUED ON THE FOLLOWING PAGE

multi-use chairs (continued)

SYNAPSE OVERVIEW	248
SYNAPSE DIMENSIONS & MATERIAL REQUIREMENTS	249
SYNAPSE PRODUCT LISTING	250
TAIGA OVERVIEW	252
TAIGA DIMENSIONS & MATERIAL REQUIREMENTS	253
TAIGA PRODUCT LISTING	254
VARIABLE OVERVIEW	256
PLANNING WITH VARIABLE MULTI-PURPOSE CHAIR FAMILY	256
EDUCATIONAL APPLICATIONS	257
CORPORATE, COMMERCIAL & INSTITUTIONAL APPLICATIONS	261
CORPORATE TRAINING	263
VARIABLE SWIVEL MULTI-USE WORK CHAIR OVERVIEW	264
VARIABLE SWIVEL MULTI-USE WORK CHAIR DIMENSIONS & MATERIAL REQUIREMENTS	266
VARIABLE SWIVEL MULTI-USE WORK CHAIR ADJUSTMENT FEATURES	268
VARIABLE SWIVEL MULTI-USE WORK CHAIR PRODUCT LISTING	270
VARIABLE CONFERENCE CHAIR OVERVIEW	274
VARIABLE CONFERENCE CHAIR DIMENSIONS & MATERIAL REQUIREMENTS	277
VARIABLE HYBRED CHAIR ADJUSTMENT FEATURES & INSTRUCTIONS	280
VARIABLE CONFERENCE & HYBRED CHAIR PRODUCT LISTING	282

product map

Ability

Pages 190

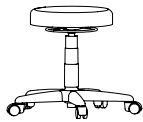

Round



Triangular

Around Guest Chair

Pages 196



Guest Chair
Mesh Back



Guest Chair
Upholstered Back

Around Conference Chair

Page 202



Conference Chair,
Mesh Back

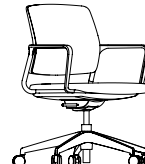

Conference Chair,
Upholstered Back

Just-Us

Pages 208



Just-Us Chair,
Upholstered Seat

Kupp

Pages 216



Kupp Chair,
Plastic Seat



Kupp Chair,
Upholstered Seat



Kupp Chair,
No Arms,
Plastic Seat



Kupp Chair,
No Arms,
Upholstered Seat

Occo

Pages 226



Occo Chair -
4 Legs



Occo Chair -
5-Star Base

Sitara

Pages 230



Sprout

Pages 244

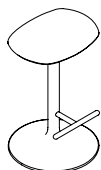

Sprout Stool

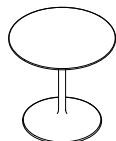

Sprout Round Table

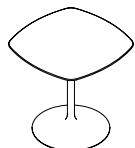

Sprout Soft-Square
Table

Synapse

Pages 250



Mid-Back –
Integrated Arms



Mid-Back –
Integrated Arms,
Fully Upholstered

product map

Taiga

Pages 254



Upper Back Upholstered Fully Upholstered Vertical Wood Slat Back

Variable Swivel Multi-Use Work Chair

Pages 270

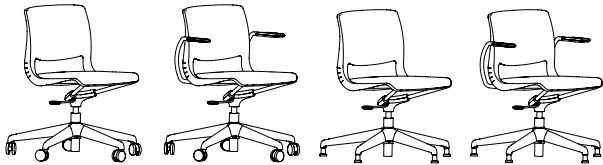

Swivel Work Chair – No Arms with Casters Swivel Work Chair – Integrated Arms with Casters Swivel Work Chair – No Arms with Glides Swivel Work Chair – Integrated Arms with Glides



Swivel Stool – No Arms with Casters Swivel Stool – Integrated Arms with Casters Swivel Stool – No Arms with Glides Swivel Stool – Integrated Arms with Glides

product map

Variable Conference Chair

Pages 282



Conference Chair – No Arms with Casters Conference Chair – Integrated Arms with Casters Conference Chair – No Arms with Glides Conference Chair – Integrated Arms with Glides HybrED Chair – Storage Tray Base No Worksurface Tablet HybrED Chair – Storage Tray Base With Worksurface Tablet HybrED Chair – Storage Tray Base With Worksurface Tablet and Cup Holder HybrED Chair – Height-Adjustable With Worksurface Tablet HybrED Chair – Height-Adjustable With Worksurface Tablet and Cup holder

(also available as a Stacking Chairs)

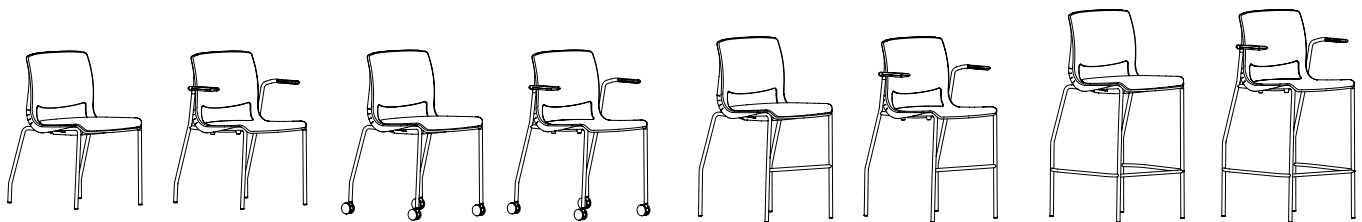

Stacking Chair – With Glides No Arms Stacking Chair – With Glides Integrated Arms Stacking Chair – With Casters No Arms Stacking Chair – With Casters Integrated Arms Stacking Stool – Counter Height No Arms Stacking Stool – Counter Height Integrated Arms Stacking Stool – Bar Height No Arms Stacking Stool – Bar Height Integrated Arms

variable accessories (also available as a Stacking Chairs)



With Tablet (right-handed) With Tablet (left-handed) With Bookrack With Tablet (right-handed) and Bookrack With Tablet (left-handed) and Bookrack

* Ganging Device, Upholstered Seat, Upholstered Seat and Back and Dolly also available

ability spinner stool overview

Ability Spinner Stools provide a simple and affordable solution for mobile and casual guest seating.

Ability Stools are equipped with casters intended for use on carpeted surfaces. Use of these casters on hard surfaces could result in unexpected rolling and tipping. Casters designed for use on hard surfaces are available. If in doubt, see your dealer for appropriate selection.

Ability Spinner Stool (NACSP)

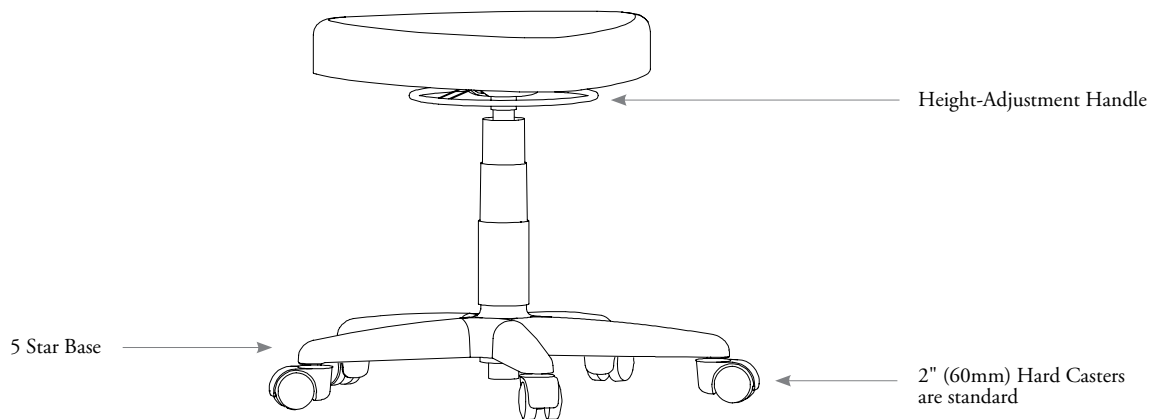

statement of line

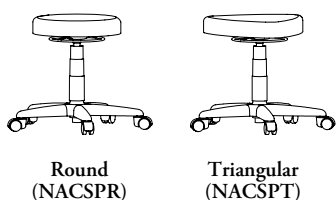

ability spinner stool dimensions & material requirements

features

- Designed and tested for users up to 250 lbs

weight

Stool	15 lbs
-------	--------

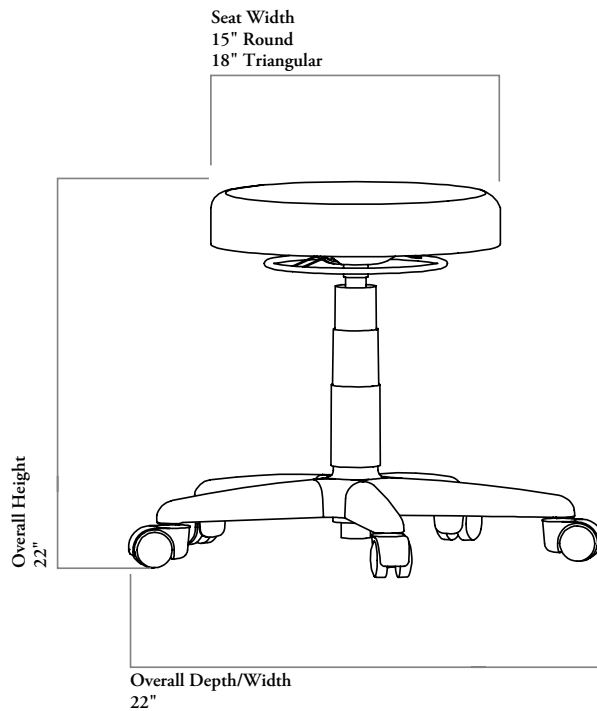

COM/COL material requirement

The pattern, repeat and directionality of fabric may increase the amount of yardage required.

Leather quantities should always be rounded up to the next hide size, as yields vary from 60-80% and are affected by the quality, size and shape of the hide, and by the location and quantity of blemishes.

SINGLE UPHOLSTERED

	COM [yards]	COL [sq. ft]
Round	0.5	8
Triangular	0.75	8

multi-use chairs

Xpress

N A C S P

Ability Spinner Stool

FEATURES

- Pneumatic cylinder provides height-adjustment of 6"
- 5 star base is finished in Ebony
- Hard casters are standard, unless otherwise specified

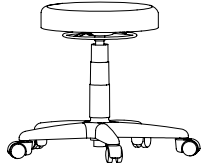

Round

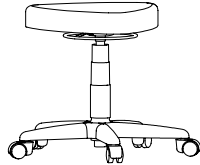

Triangular

PRODUCT OPTIONS

Seat Shape	Seat Upholstery Finish	Base Finish	Casters (Optional)
R Round T Triangular	Fabric Leather	E Ebony	SC Casters, Soft

SAMPLE ORDER CODE

NACSP R	A103	E	
----------------	-------------	----------	--

PRICE

Grade 1	COM/ Grade 2	COL/ Grade 3	Grade 4	Grade 5	Grade 6	Grade 7	Grade 8	Grade 9	Grade 10
384	413	447	477	506	536	566	599	628	734
Leather LA	Leather LB	Leather LC	Leather LD						
629	667	777	814						

If Soft Casters (SC) are specified add 28

multi-use chairs

around guest chair overview

The Around Guest Chair is part of the Around family of Task and Swivel Stool chairs. They can be used as side or casual meeting chairs in the workstation environment, private office or traditional reception area. They are available with a mesh or upholstered back.

Gris frame is not recommended for high traffic use or minimized maintenance.

Around Guest Chairs can be equipped with casters or glides. Select Soft Casters or Glides for hard floors and Hard Casters or Glides for soft floors. If in doubt, see your dealer for appropriate selection.

Around Guest Chair, Mesh Back (NARJ)

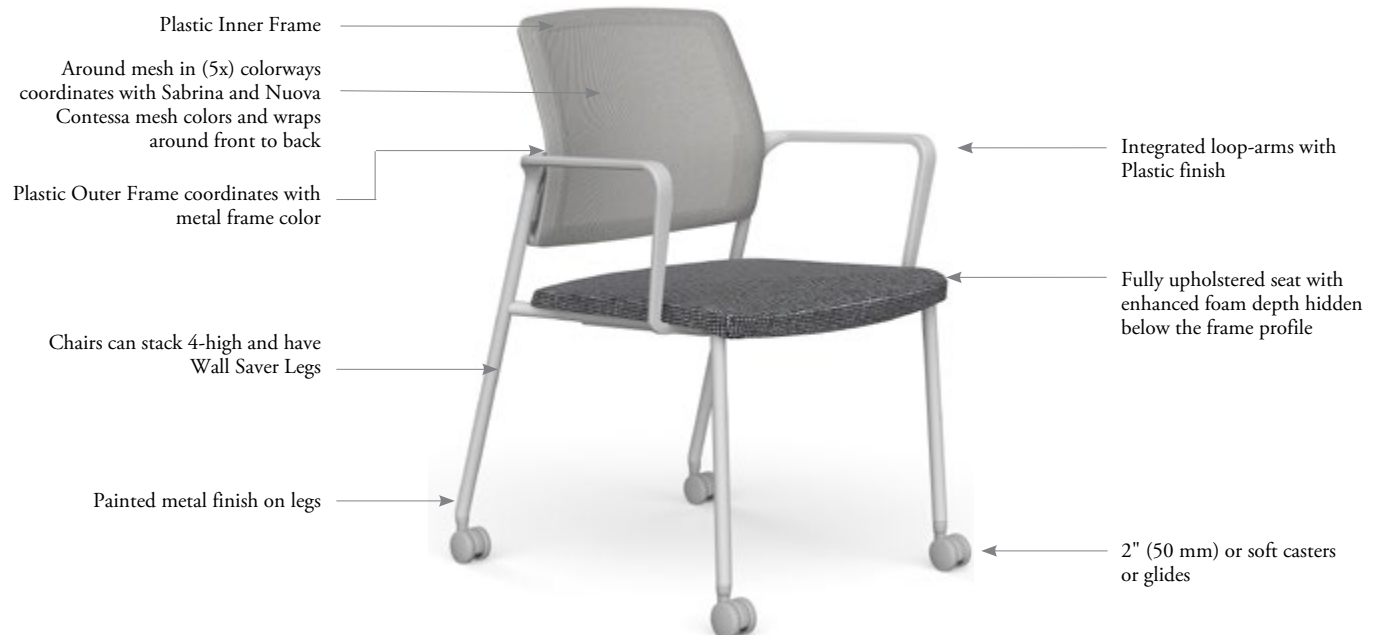

See Around Finish Guide in Work Chairs Section for more details on Plastic Inner and Outer Frame.
See Work Chair Section for Around Task and Swivel Stool chairs.

statement of line



Mesh Back
(NARJ)

around guest chair overview (continued)

The Around Guest Chair is part of the Around family of Task and Swivel Stool chairs. They can be used as side or casual meeting chairs in the workstation environment or private office. They are available with a mesh or upholstered back.

Gris frame is not recommended for high traffic use or minimized maintenance.

Around Guest Chairs can be equipped with casters or glides. Select Soft Casters or Glides for hard floors and Hard Casters or Glides for soft floors. If in doubt, see your dealer for appropriate selection.

Around Guest Chair, Upholstered Back (NARY)

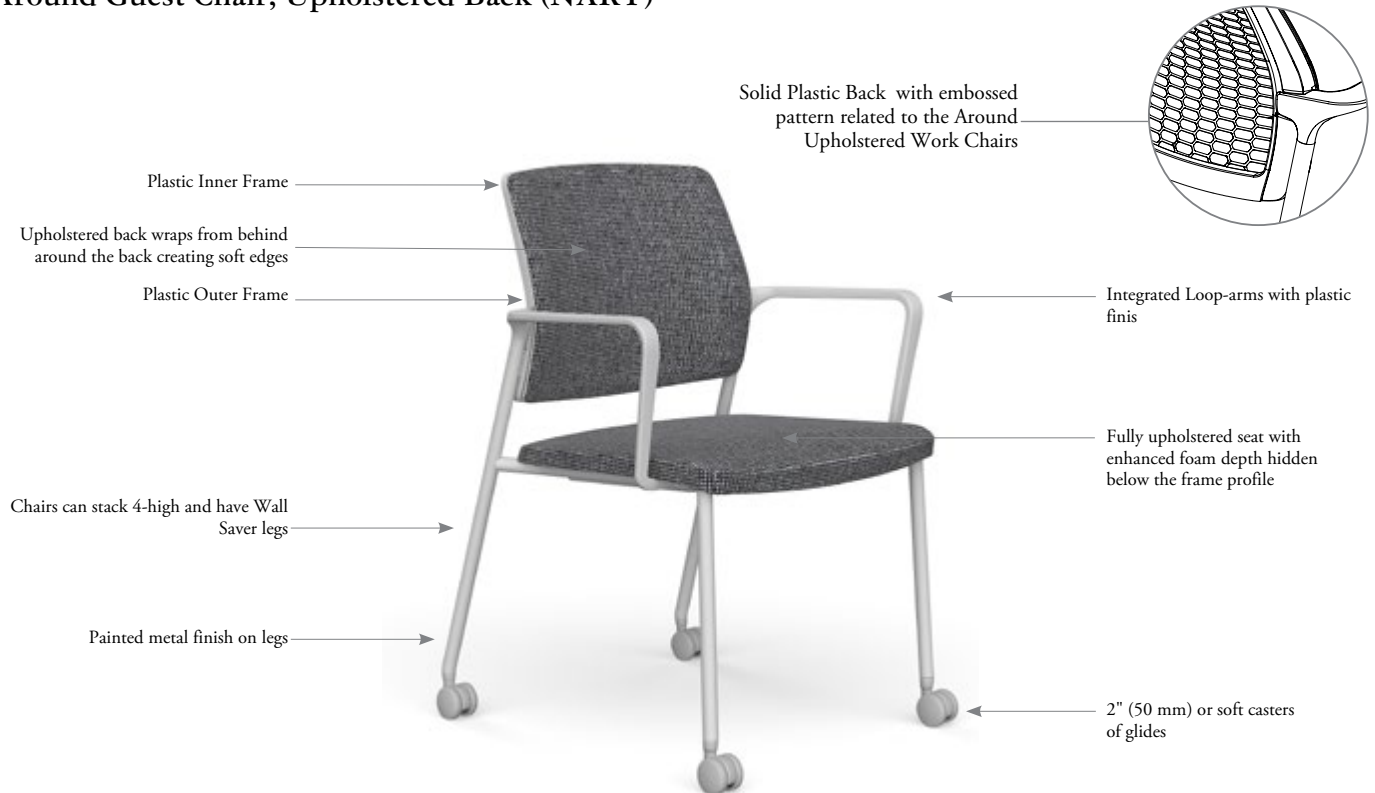

See Around Finish Guide in Work Chairs Section for more details on Plastic Inner and Outer Frame.
See Work Chair Section for Around Task and Swivel Stool chairs.

statement of line



Upholstered Back
(NARY)

multi-use chairs

around guest chair dimensions & material requirements

features

- Designed and tested for users up to 300 lbs
- Meets ANSI/BIFMA requirements

weight

Guest Chair, Mesh Back	20 lbs
Guest Chair, Upholstered	20 lbs

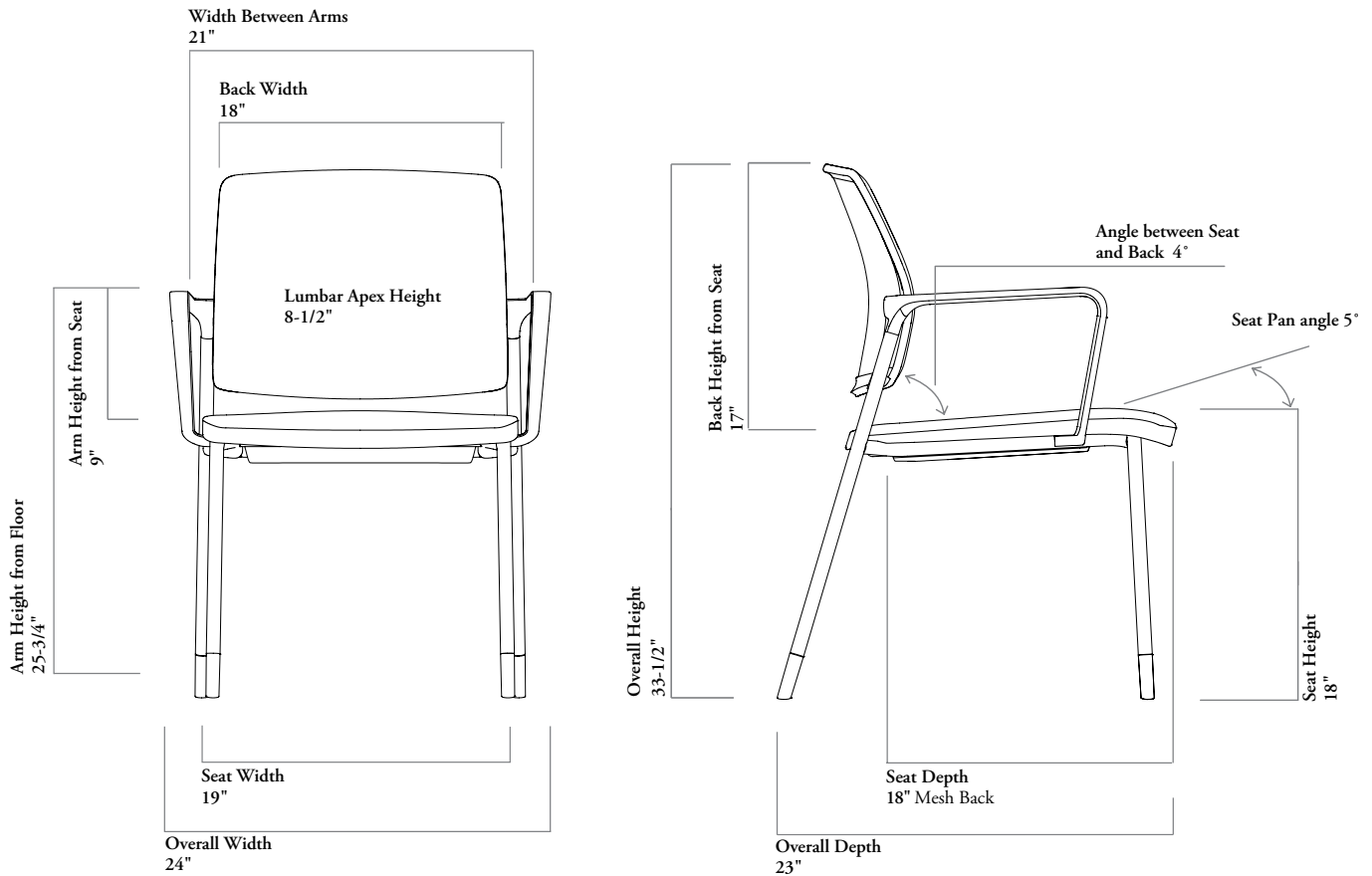

COM/COL material requirement

The pattern, repeat and directionality of fabric may increase the amount of yardage required.

Leather quantities should always be rounded up to the next hide size, as yields vary from 60-80% and are affected by the quality, size and shape of the hide, and by the location and quantity of blemishes.

	SINGLE UPHOLSTERED		DUAL UPHOLSTERED – SEAT		DUAL UPHOLSTERED – BACK	
	COM [yards]	COL [sq. ft]	COM [yards]	COL [sq. ft]	COM [yards]	COL [sq. ft]
Guest Chair, Mesh Back	0.75	13	n/a	n/a	n/a	n/a
Guest Chair, Upholstered	1.75	30	1	17	0.75	13

multi-use chairs

NARJ

Around Guest Chair, Mesh Back

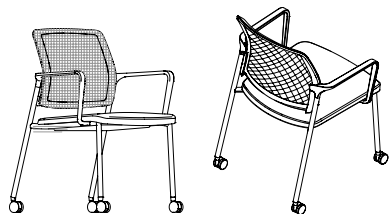

FEATURES

- Chairs stack up to four high, regardless of caster or glide option
- Integrated loop arms
- Arms and back frame are plastic finish. Tubular steel frame and legs are painted metal finish
- Mesh wraps around back, creating soft-edges

NOTES

For Frame Style, select Soft Casters or Glides for hard floors and Hard Casters or Glides for soft floors.

Always Dual Upholstery - Around Mesh on back and LUUM Upholstery and COM/ COL on seat.

Around Mesh colorways coordinate with Nuova Contessa and Sabrina mesh colorways.

Frame Finish selection determines the color palette of the finishes. When (9F) Gris is selected, the plastic back is Gris, painted metal frame is Gris, and the plastic arms and casters are Cool Grey. When (8B) Ebony is selected, the plastic back, plastic arms, painted metal frame and casters are finished in Ebony.

PRODUCT OPTIONS

Frame Style	Around Mesh Back Finish	Seat Upholstery Finish	Frame Finish
G Four-Leg with Casters, Hard	A123 Banner	Fabric	8B Ebony
A Four-Leg with Casters, Soft	A124 Lapis	Leather	9F Gris
B Four-Leg with Glides, Hard	A125 Brier		
C Four-Leg with Glides, Soft	A126 Dove		
	A127 Black		

SAMPLE ORDER CODE

NARJ A	A127	E523	8B
---------------	-------------	-------------	-----------

DESCRIPTION

Four-Leg with Glides, Hard
Four Leg with Glides, Soft
Four Leg with Casters, Hard
Four Leg with Casters, Soft
Four-Leg with Glides, Hard
Four Leg with Glides, Soft
Four Leg with Casters, Hard
Four Leg with Casters, Soft

PRICE

Grade 1	COM/ Grade 2	COL/ Grade 3	Grade 4	Grade 5	Grade 6	Grade 7	Grade 8	Grade 9	Grade 10
628	681	711	734	754	770	793	817	838	862
654	708	738	761	778	797	820	843	864	889
687	740	770	793	813	831	854	877	899	921
711	764	795	818	835	855	878	901	921	945
Leather LA	Leather LB	Leather LC	Leather LD						
977	1030	1148	1215						
1003	1057	1175	1241						
1036	1089	1209	1274						
1060	1114	1233	1298						

If Gris Frame Finish (9F) is specified add 80

FEATURES

- Chairs stack up to four high, regardless of caster or glide option
- Integrated loop arms
- Arms and back frame are plastic finish. Tubular steel frame and legs are painted metal finish
- Fully upholstered seat with enhanced foam depth hidden below the frame profile
- Durable solid plastic on the rear side of the back with embossed pattern that is related to the Around Work Chair

NOTES

For Frame Style, select Soft Casters or Glides for hard floors and Hard Casters or Glides for soft floors.

Upholstery options for the back of the Guest Chair correspond with the LUUM upholstery options on the back of the Around Upholstered Task Chair

Frame Finish selection determines the color palette of the finishes. When (9F) Gris is selected, the plastic back is Gris, painted metal frame is Gris, and the plastic arms and casters are Cool Grey. When (8B) Ebony is selected, the plastic back, plastic arms, painted metal frame and casters are finished in Ebony.

N A R Y
**Around Guest Chair,
Upholstered Back**

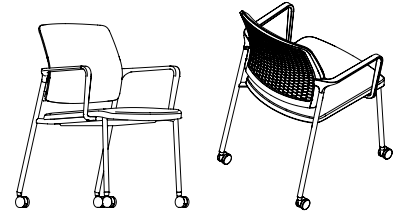

PRODUCT OPTIONS

Frame Style	Upholstery Style	Back Upholstery Finish	Seat Upholstery Finish	Frame Finish
G Four-Leg with Casters, Hard	S Single	Fabric	Fabric	8B Ebony
A Four-Leg with Casters, Soft	D Dual Upholstered Seat and Back	Leather	Leather	9F Gris
B Four-Leg with Glides, Hard				
C Four-Leg with Glides, Soft				

SAMPLE ORDER CODE

NARY A	D	E524	E523	8B
---------------	----------	-------------	-------------	-----------

DESCRIPTION

PRICE

DESCRIPTION	SINGLE UPHOLSTERY (S)		
	Grade 1	Grade 2	Grade 3
Four-Leg with Glides, Hard	710	797	913
Four-Leg with Glides, Hard	Leather LA 1391		

- For Dual Upholstered (D), add Seat Upholstery price:
- Grades 1-4 add 130
 - Grades 5-10 add 232
 - Leather add 298
- If Soft Glides (C) are specified add 27
- If Hard Casters (G) are specified add 59
- If Soft Casters (A) are specified add 84
- With Gris Frame Finish add 93

multi-use chairs

around conference overview

The Around Conference chair is part of the Around family of Guest, Task and Swivel Stool chairs. Around Conference is versatile for meeting and touchdown spaces. Available in mesh or with an upholstered seat back, mix and match fabrics and finishes for unique design expressions.

Around Conference Chair, Mesh Back (NARC)



frame finishes

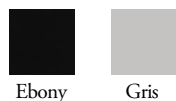

mesh colorways



statement of line



Around
Conference Chair,
Mesh Back
(NARC)

around conference overview (continued)

The Around Conference chair is part of the Around family of Guest, Task and Swivel Stool chairs. Around Conference is versatile for meeting and touchdown spaces. Available in mesh or with an upholstered seat back, mix and match fabrics and finishes for unique design expressions.

Around Conference Chair, Upholstered Back (NARP)

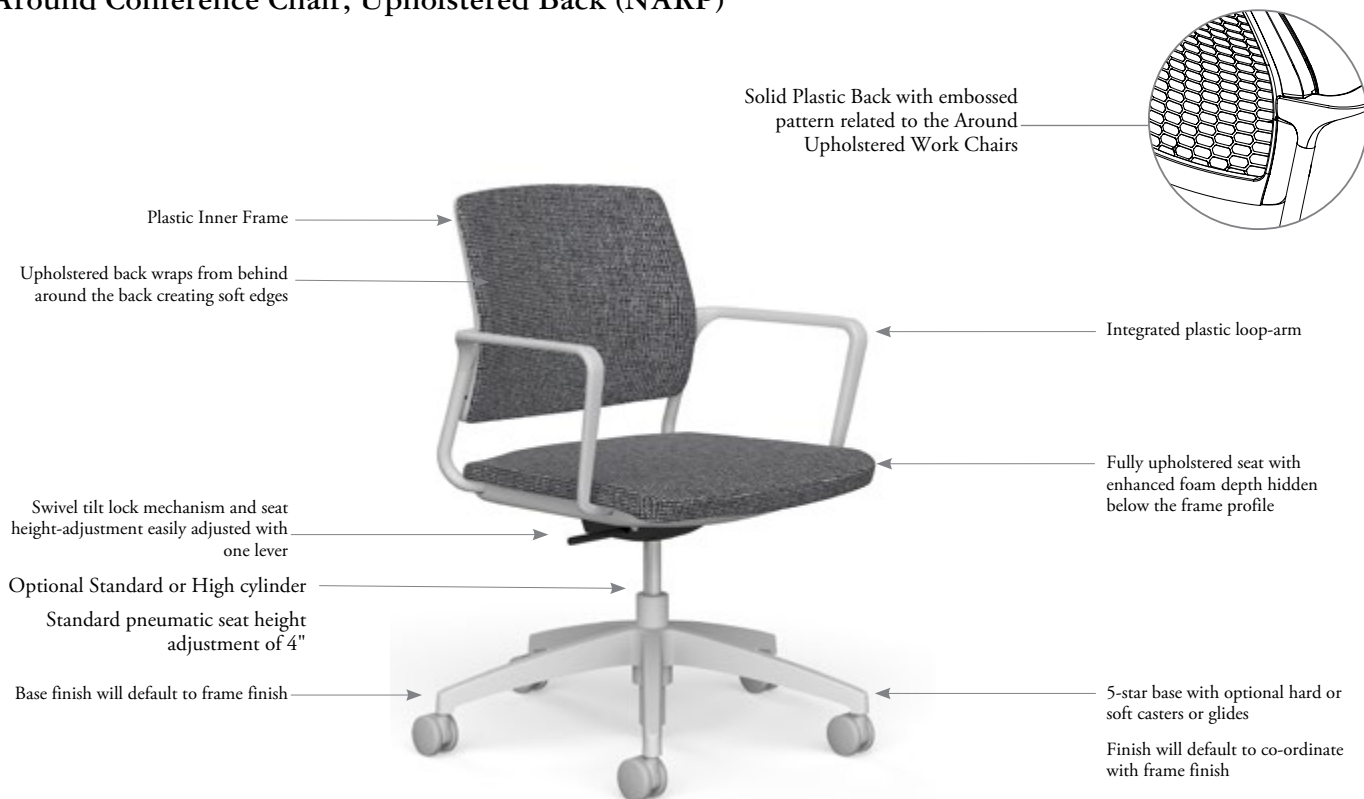

frame finishes



statement of line



Around Conference Chair, Upholstered Back (NARP)

around conference chair dimensions & material requirements

features

- Designed and tested for users up to 300 lbs
- Meets ANSI/BIFMA requirements

weight

Conference Chair, Mesh Back	32 lbs
Conference Chair, Upholstered Back	33 lbs

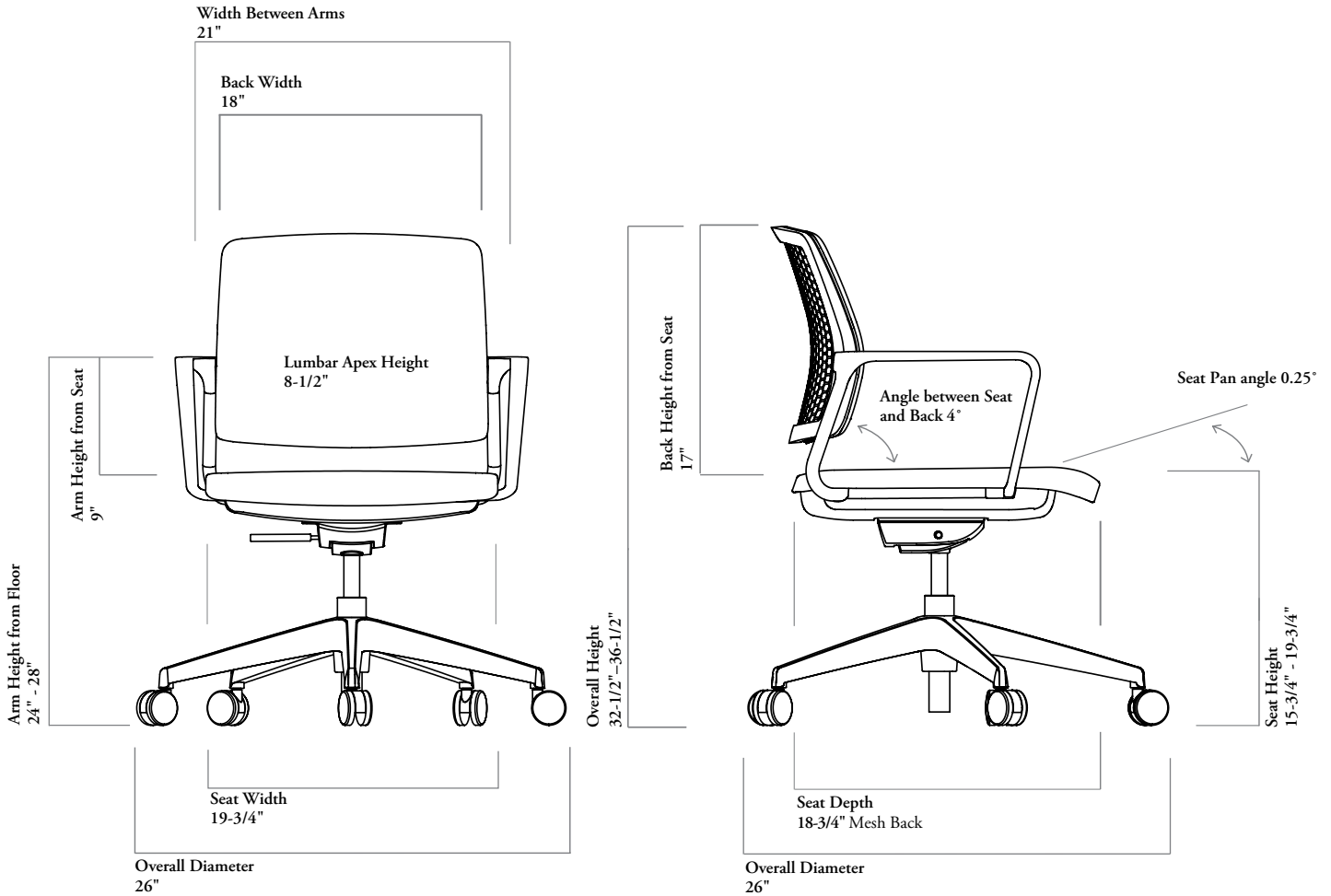

COM/COL material requirement

The pattern, repeat and directionality of fabric may increase the amount of yardage required.

Leather quantities should always be rounded up to the next hide size, as yields vary from 60-80% and are affected by the quality, size and shape of the hide, and by the location and quantity of blemishes.

	SINGLE UPHOLSTERED		DUAL UPHOLSTERED - SEAT		DUAL UPHOLSTERED - BACK	
	COM [yards]	COL [sq. ft]	COM [yards]	COL [sq. ft]	COM [yards]	COL [sq. ft]
Conference Chair, Mesh Back	0.75	13	n/a	n/a	n/a	n/a
Conference Chair, Upholstered	1.75	30	1	17	0.75	13

around conference adjustment features & instructions

seat height-adjustment

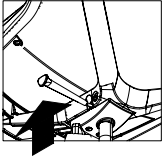

Seat height can be adjusted by lifting the lever underneath the seat on the right side. When the lever is lifted up, the weight of the body will cause the seat to lower. Releasing the lever stops the seat at the desired height. Lifting the lever up with no weight on the seat allows it to rise.

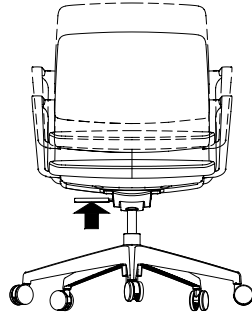

back tilt lock adjustment

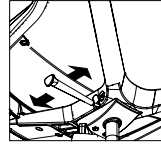

Moving the lever found under the right side of the seat locks and unlocks the recline. Push lever forward to lock chair in upright position. Pull the lever backwards to unlock for tilting action.



multi-use chairs

NARC 

Around Conference Chair, Mesh Back

FEATURES

- Integrated loop arms
- Mesh wraps around back, creating soft-edge
- Fully upholstered seat with enhanced foam depth hidden below the frame profile

NOTES

Soft Casters or Glides for hard floors and Hard Casters or Glides for soft floors.

Gris Frame Finish includes Gris plastic frame, cylinder and 5-star base and co-ordinating casters/glides. Ebony Frame Finish includes all Ebony frame, cylinder, 5-star base and casters/glides.



PRODUCT OPTIONS

Around Mesh Back Finish	Seat Upholstery Finish	Cylinder Style	Frame Finish	Casters / Glides
A123 Banner	Fabric	1 Standard	8B Ebony	Hard Casters
A124 Lapis	Leather	2 High	9F Gris	A Soft Casters
A125 Brier				B Hard Glides
A126 Dove				C Soft Glides
A127 Black				

SAMPLE ORDER CODE

NARC A127	E524	1	8B	A
-----------	------	---	----	---

DESCRIPTION

PRICE

	Grade 1	COM/ Grade 2	COL/ Grade 3	Grade 4	Grade 5	Grade 6	Grade 7	Grade 8	Grade 9	Grade 10
Around Conference Chair, Mesh Back	936	989	1019	1042	1062	1080	1103	1126	1148	1170
	Leather LA	Leather LB	Leather LC	Leather LD						
Around Conference Chair, Mesh Back	1285	1338	1458	1523						

If Gris Frame Finish (9F) is specified	add	89
If Soft Glides (C) are specified	add	43
If Hard Glides (B) are specified	add	28
If Soft Casters (A) are specified	add	28



Around Conference Chair, Upholstered Back

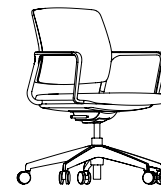

FEATURES

- Integrated loop arms
- Upholstered back wraps from behind around the back creating soft edges
- Fully upholstered seat with enhanced foam depth hidden below the frame profile
- Durable solid plastic on the rear side of the back with embossed pattern that is related to the Around Work Chair

NOTES

Soft Casters or Glides for hard floors and Hard Casters or Glides for soft floors.

Upholstery options for the back of the Conference Chair correspond with the LUUM upholstery options on the back of the Around Upholstered Task Chair.

Gris Frame Finish includes Gris plastic frame, cylinder and 5-star base and co-ordinating casters/glides. Ebony Frame Finish includes all Ebony frame, cylinder, 5-star base and casters/glides.

PRODUCT OPTIONS

Upholstery	Back Upholstery Finish	Seat Upholstery Finish	Cylinder Style	Frame Finish	Casters / Glides
S Single	Fabric	Fabric	1 Standard	8B Ebony	Hard Casters
D Dual Upholstered Seat and Back	Leather	Leather	2 High	9F Gris	A Soft Casters B Hard Glides C Soft Glides

SAMPLE ORDER CODE

NARP D	E524	E523	1	8B	A
---------------	-------------	-------------	----------	-----------	----------

DESCRIPTION

PRICE

DESCRIPTION	SINGLE UPHOLSTERY (S)		
	Grade 1	Grade 2	Grade 3
Around Conference Chair	1035	1122	1716
Around Conference Chair	Leather LA 1716		

- For Dual Upholstered (D), add Seat Upholstery price:
- Grades 1-4 add 133
 - Grades 5-10 add 232
 - Leather add 298
- If Soft Glides (C) are specified add 43
- If Hard Casters (G) are specified add 28
- If Soft Casters (A) are specified add 28
- If Gris Frame Finish is specified add 89

multi-use chairs

just-us chair overview

Just-Us Chair is a multi-purpose chair that is easy to use, comfortable and light spirited and is available with a mesh back and upholstered seat. It is ideal for light work, touchdown and meeting use, and as a conference chair.

Just-Us Chair, Upholstered Seat (NJUU)



frame finishes



Gris Ebony

around mesh finishes



Black Lapis Banner Brier Dove

just-us finishes



Black Charcoal Fleece Khaki Smoke Spice Surf

finishes

Frame Finish Palettes are designed to provide a curated and cohesive frame in light or dark finishes that work with both neutral and contrasting fabrics.

Ebony Frame Finish Palette:

- Ebony frame, cylinder, 5 star base, casters and polished aluminum mechanism

Gris Frame Finish Palette:

- Gris plastic frame, cylinder, 5 star base, medium grey casters and polished aluminum mechanism

statement of line



Just-Us Chair,
Upholstered Seat
(NJUU)

just-us chair dimensions & material requirements

features

- Designed and tested for users up to 300 lbs
- Meets ANSI/BIFMA requirements
- Equipped with hard casters intended for use on carpet
- Soft casters are available for hard surfaces
- Swivel-tilt mechanism

weight

Just-Us Chair - Upholstered	35 lbs
-----------------------------	--------

Multi-Use Chair

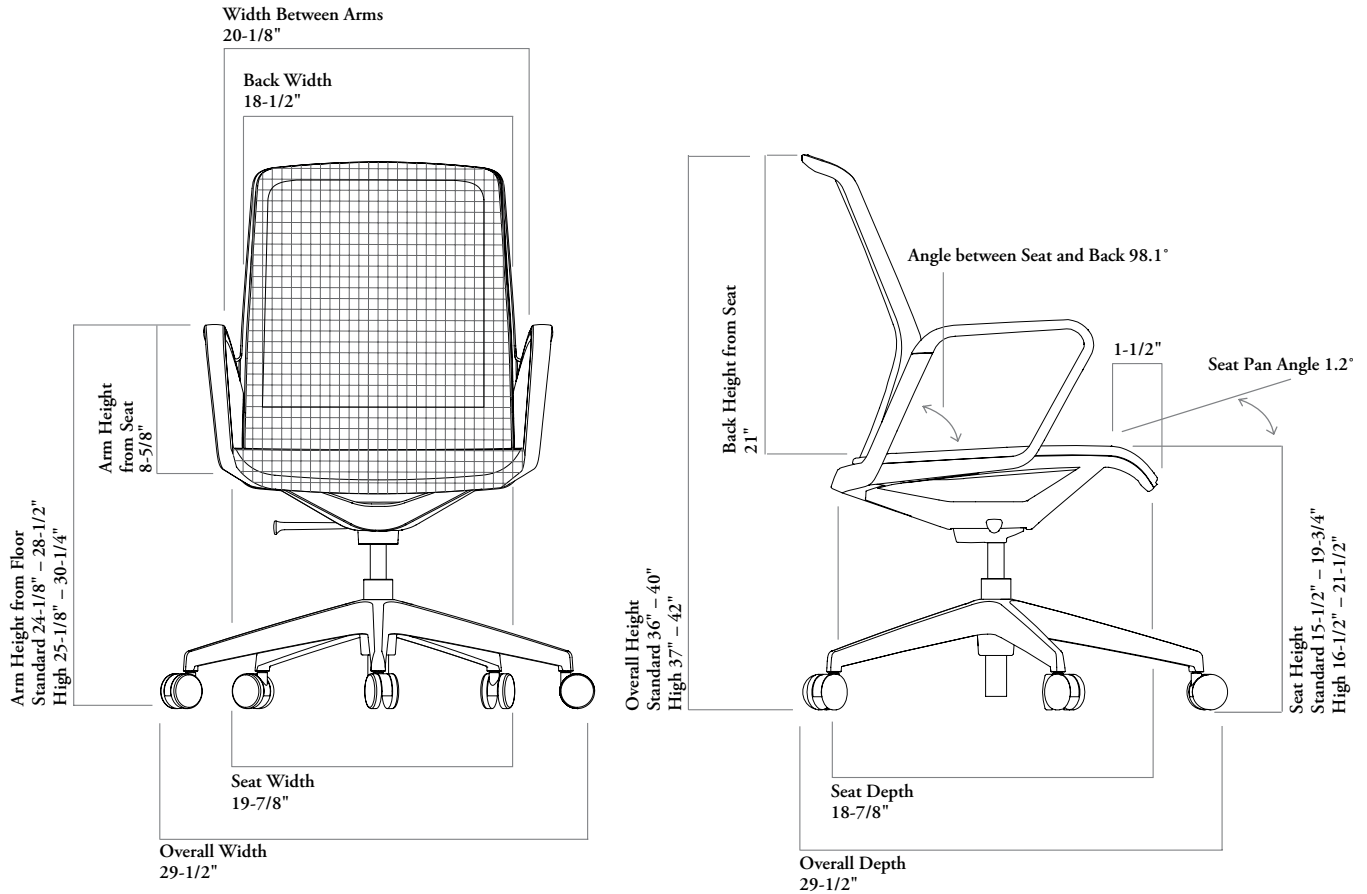

COM/COL material requirement

The pattern, repeat and directionality of fabric may increase the amount of yardage required.

Leather quantities should always be rounded up to the next hide size, as yields vary from 60-80% and are affected by the quality, size and shape of the hide, and by the location and quantity of blemishes.

UPHOLSTERED

	COM [yards]	COL [sq. ft]
Seat	0.875	15"

just-us adjustment features & instructions

seat height-adjustment

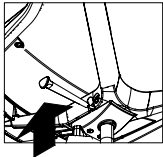

Seat height can be adjusted by lifting the lever underneath the seat on the right side. When the lever is lifted up, the weight of the body will cause the seat to lower. Releasing the lever stops the seat at the desired height. Lifting the lever up with no weight on the seat allows it to rise.

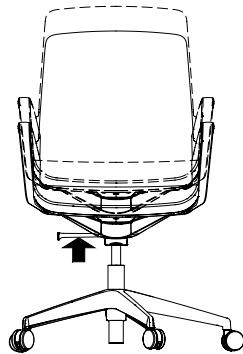

back tilt lock adjustment

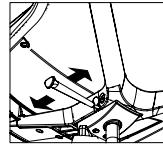

Moving the lever found under the right side of the seat locks and unlocks the recline. Push lever forward to lock chair in upright position. Pull the lever backwards to unlock for tilting action.

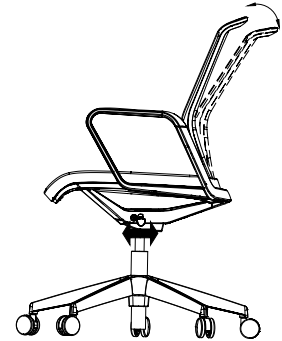

planning with just-us chair

The Just-Us chair can be used in a variety of applications throughout a workspace.

private offices

Just Us is available with the Around Chair Mesh so coordinates well with the Around Chair in a private office setting.



touch-down workstations

The Just-Us chair is suitable for short term use in a touch-down workstation environment where the end user requires a non-dedicated space to work.



meeting and conference rooms

The swivel-tilt mechanism and seat height is easily adjusted with one lever which makes this chair suitable for short-term use in meeting rooms. Fixed height arms look consistent and professional.



enclaves

The Just-Us chair is easy-to-use and works well in enclaves and touchdown workstations where the end user needs a space to get some quick work completed.



multi-use chairs

N J U U Just-Us Chair, Upholstered Seat

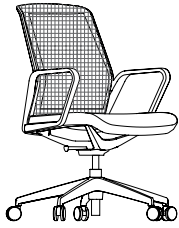

FEATURES

- With fixed-loop arms for a clean look in meeting spaces & no-fuss operation
- Simple to operate with one lever
- Swivel-tilt mechanism locks in upright position
- Standard pneumatic cylinder provides seat height-adjustment of 4"; High pneumatic cylinder adjustment is 5"
- Swivel-tilt mechanism with 11° recline
- To allow coordination with other Teknion Work Chairs, Around or Just-Us mesh is applied on the chair's back
- The cushioned seat is upholstered with LUUM upholstery
- Gris Frame Finish includes Gris plastic frame, cylinder and 5-star base with Medium Grey casters. Ebony Frame Finish includes all Ebony frame, cylinder, base and casters. Mechanism is always Polished Aluminum.
- Hard casters are standard and are well suited for soft flooring such as carpeting
- Soft casters are available for use on hard flooring, such as wood, concrete or tile

NOTES

Just-Us Chair-Upholstered Seat is Dual Upholstered with Around or Just-Us Mesh available on the back & LUUM Upholstery options on the seat.

PRODUCT OPTIONS

Mesh Back		Seat Upholstery Finish	Cylinder Style	Frame Finish	Casters/Glides
Around	Just-Us	Fabric	1 Standard	8B Ebony	Hard Casters
A123 Banner	J100 Black	Leather	2 High	9F Gris	A Soft Casters
A124 Lapis	J101 Charcoal				B Hard Glides
A125 Brier	J102 Smoke				C Soft Glides
A126 Dove	J103 Fleece				
A127 Black	J104 Khaki				
	J105 Spice				
	J106 Surf				

SAMPLE ORDER CODE

NJUU A127	E523	8B	8B	A
------------------	-------------	-----------	-----------	----------

PRICE

COM/ Grade 1	COL/ Grade 2	Grade 3	Grade 4	Grade 5	Grade 6	Grade 7	Grade 8	Grade 9	Grade 10
1002	1029	1056	1068	1083	1096	1111	1124	1139	1154

Leather LA	Leather LB	Leather LC	Leather LD
1334	1390	1558	1615

If Soft Casters (A) are specified	add 28
If Hard Glides (B) are specified	add 28
If Soft Glides (C) are specified	add 43
If Gris (9F) frame is specified	add 103

kupp chair overview

Kupp is inspired by the classic typology of the café chair and addresses the need for simple, portable seating in office, commercial and higher learning spaces where seating needs can change from moment to moment.

A fresh approach to stacking chair design, horizontal nesting solves constraints and contributes to employee safety as chairs can be nested with minimal physical effort.

Kupp is available with or without arms.

It's strong, slender frame, flip-up seat and integrated nesting bumper allow it to be easily moved and stored with minimal damage.

Kupp Chair, Upholstered Seat (NKUY)



frame finishes

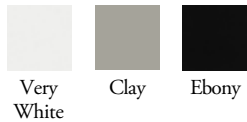

chair finishes

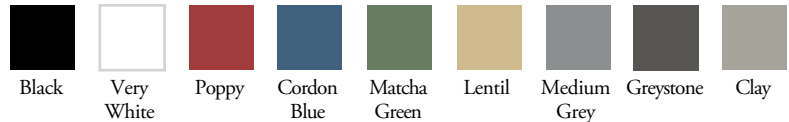

statement of line



Kupp Chair,
Plastic Seat
(NKUP)

Kupp Chair,
Upholstered Seat
(NKUY)

kupp chair overview (continued)

Kupp Chair, No Arms, Upholstered Seat (NKUZ)



frame finishes

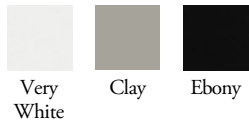

chair finishes

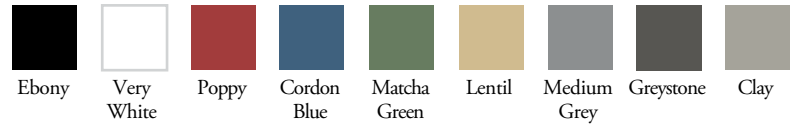

statement of line



Kupp Chair,
No Arms,
Plastic Seat
(NKUX)

Kupp Chair,
No Arms,
Upholstered Seat
(NKUZ)

kupp chair dimensions & material requirements

features

- Designed and tested for users up to 300 lbs
- Meets ANSI/BIFMA requirements
- Hard and soft glides available
- A mixture of glides and casters are also available

weight

Kupp Chair - Plastic	19 lbs
Kupp Chair - Upholstered	19 lbs

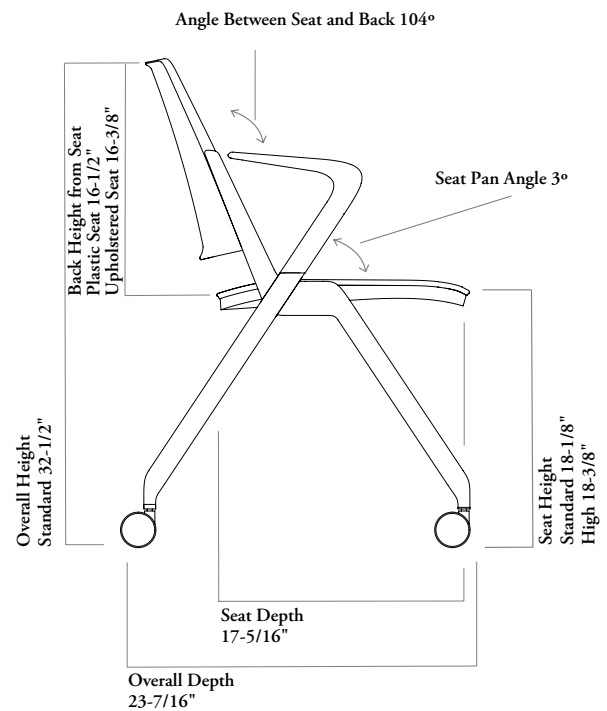
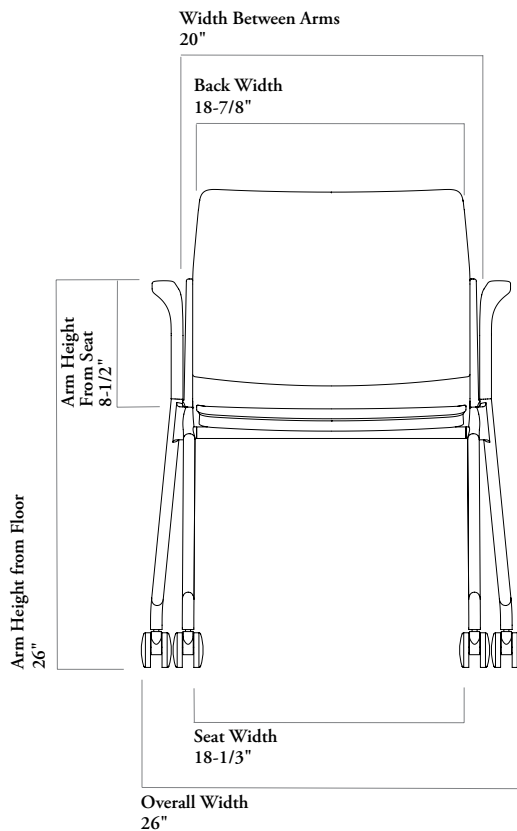

COM/COL material requirement

The pattern, repeat and directionality of fabric may increase the amount of yardage required.

Leather quantities should always be rounded up to the next hide size, as yields vary from 60-80% and are affected by the quality, size and shape of the hide, and by the location and quantity of blemishes.

UPHOLSTERED

	COM [yards]	COL [sq. ft]
Upholstered Seat	0.7	4.5

kupp chair dimensions & material requirements (continued)

features

- Designed and tested for users up to 300 lbs
- Meets ANSI/BIFMA requirements
- Equipped with hard casters intended for use on carpet
- Soft casters are available for hard surfaces
- Hard and soft glides available
- A mixture of glides and casters are also available

weight

Kupp Chair, No Arms - Plastic	18 lbs
Kupp Chair, No Arms - Upholstered	18 lbs

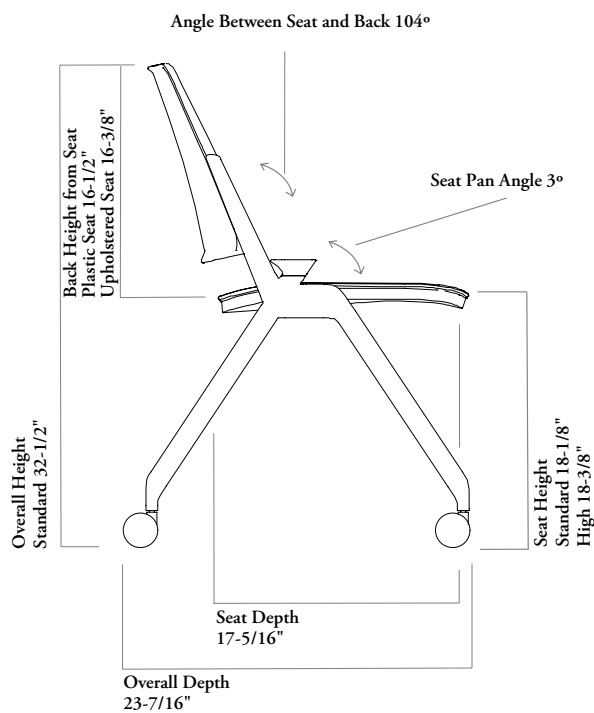
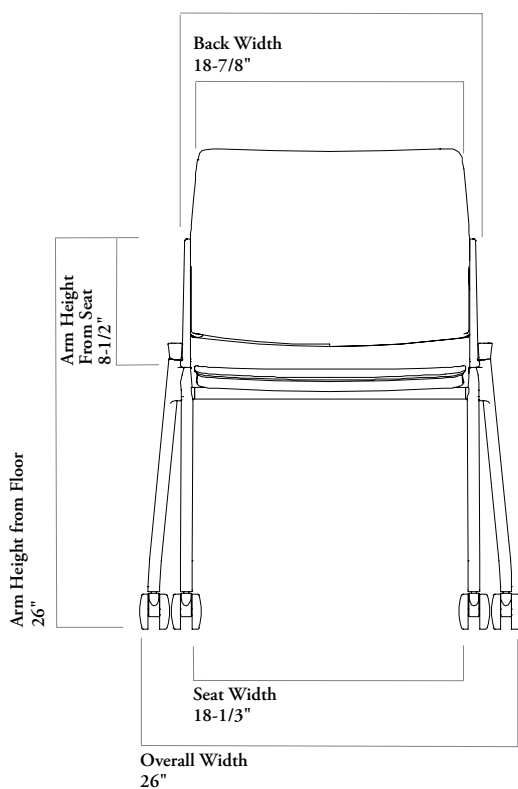

COM/COL material requirement

The pattern, repeat and directionality of fabric may increase the amount of yardage required.

Leather quantities should always be rounded up to the next hide size, as yields vary from 60-80% and are affected by the quality, size and shape of the hide, and by the location and quantity of blemishes.

UPHOLSTERED

	COM [yards]	COL [sq. ft]
Upholstered Seat	0.7	4.5

multi-use chairs

planning with kupp chair

The Kupp chair is versatile and agile and can be used throughout a workspace.

education



cafe



planning with kupp chair (continued)

meeting



multi-purpose



multi-use chairs

N K U P

Kupp Chair, Plastic Seat



FEATURES

- Seat flips up to allow chairs to nest
- Chair frame is painted aluminum
- Integrated plastic arms are the same color as the frame
- Hard or soft casters
- Hard or soft glides
- Mixture of casters and glides

NOTES

Light grey casters for very white and clay frames.

Ebony casters for ebony frames.

PRODUCT OPTIONS

Chair Finish		Frame Finish	Casters
HG Ebony		52 Ebony	Hard Casters
HF Very White		83 Very White	A Soft Casters
HN Poppy		85 Clay	B Hard Glides
HR Cordon Blue			C Soft Glides
HQ Matcha Green			E Hard Front Glides & Hard Rear Casters
HP Lentil			F Soft Front Glides & Soft Rear Casters
HH Medium Grey			G Hard Front Casters & Hard Rear Glides
HK Greystone			H Soft Front Casters & Soft Rear Glides
NH Clay			

SAMPLE ORDER CODE

NKUP HG	52	A
----------------	-----------	----------

PRICE

Hard Casters	Soft Casters	Hard Glides	Soft Glides	Hard Front Glides & Hard Rear Casters	Soft Front Glides & Soft Rear Glides	Hard Front Casters & Hard Rear Glides	Soft Front Casters & Soft Rear Glides
741	769	769	785	769	785	769	785

N K U Y

Kupp Chair, Upholstered Seat

FEATURES

- Seat flips up to allow chairs to nest
- Chair frame is painted aluminum
- Integrated plastic arms are the same color as the frame
- Hard or soft casters
- Hard or soft glides
- Mixture of casters and glides

NOTES

Light grey casters for very white and clay frames.

Ebony casters for ebony frames.



PRODUCT OPTIONS

Seat Upholstery Finish	Chair Finish	Frame Finish	Casters
Fabric	HG Ebony	52 Ebony	Hard Casters
Leather	HF Very White	83 Very White	A Soft Casters
	HN Poppy	85 Clay	B Hard Glides
	HR Cordon Blue		C Soft Glides
	HQ Matcha Green		E Hard Front Glides & Hard Rear Casters
	HP Lentil		F Soft Front Glides & Soft Rear Casters
	HH Medium Grey		G Hard Front Casters & Hard Rear Glides
	NH Clay		H Soft Front Casters & Soft Rear Glides

SAMPLE ORDER CODE

NKUY E523	HG	52	A
------------------	-----------	-----------	----------

PRICE

COM/ Grade 1	COL/ Grade 2	Grade 3	Grade 4	Grade 5	Grade 6	Grade 7	Grade 8	Grade 9	Grade 10
815	834	850	863	879	892	908	921	937	951
Leather LA	Leather LB	Leather LC	Leather LD						
951	966	980	995						

If Items Below are Specified:

Soft Casters (A)	add 28
Hard Glides (B)	add 28
Soft Glides (C)	add 43
Hard Front Glides & Hard Rear Glides (E)	add 28
Soft Front Glides & Soft Rear Glides (F)	add 43
Hard Front Casters & Hard Rear Glides (G)	add 28
Soft Front Casters & Soft Rear Glides (H)	add 43

multi-use chairs

N K U X

Kupp Chair, No Arms, Plastic Seat



FEATURES

- Seat flips up to allow chairs to nest
- Chair frame is painted aluminum
- Hard or soft casters
- Hard or soft glides
- Mixture of casters and glides

NOTES

Light grey casters for very white and clay frames.
Ebony casters for ebony frames.

PRODUCT OPTIONS

Chair Finish		Frame Finish	Casters
HG	Ebony	52 Ebony	Hard Casters
HF	Very White	83 Very White	A Soft Casters
HN	Poppy	85 Clay	B Hard Glides
HR	Cordon Blue		C Soft Glides
HQ	Matcha Green		E Hard Front Glides & Hard Rear Casters
HP	Lentil		F Soft Front Glides & Soft Rear Casters
HH	Medium Grey		G Hard Front Casters & Hard Rear Glides
HK	Greystone		H Soft Front Casters & Soft Rear Glides
NH	Clay		

SAMPLE ORDER CODE

NKUX HG	52	A
----------------	-----------	----------

PRICE

Hard Casters	Soft Casters	Hard Glides	Soft Glides	Hard Front Glides & Hard Rear Casters	Soft Front Glides & Soft Rear Glides	Hard Front Casters & Hard Rear Glides	Soft Front Casters & Soft Rear Glides
675	703	703	718	703	718	703	718

FEATURES

- Seat flips up to allow chairs to nest
- Chair frame is painted aluminum
- Hard or soft casters
- Hard or soft glides
- Mixture of casters and glides

NOTES

Light grey casters for very white and clay frames.
Ebony casters for ebony frames.

N K U Z
Kupp Chair, No Arms,
Upholstered Seat



PRODUCT OPTIONS

Upholstery Finish	Chair Finish	Frame Finish	Casters
Fabric	HG Ebony	52 Ebony	Hard Casters
Leather	HF Very White	83 Very White	A Soft Casters
	HN Poppy	85 Clay	B Hard Glides
	HR Cordon Blue		C Soft Glides
	HQ Matcha Green		E Hard Front Glides & Hard Rear Casters
	HP Lentil		F Soft Front Glides & Soft Rear Casters
	HH Medium Grey		G Hard Front Casters & Hard Rear Glides
	NH Clay		H Soft Front Casters & Soft Rear Glides

SAMPLE ORDER CODE

NKUZ E523	HG	52	A
------------------	-----------	-----------	----------

PRICE

Grade 1	COM/ Grade 2	COL/ Grade 3	Grade 4	Grade 5	Grade 6	Grade 7	Grade 8	Grade 9	Grade 10
746	767	783	796	812	826	841	855	870	884

Leather LA	Leather LB	Leather LC
899	913	929

If Items Below are Specified:

Soft Casters (A)	add 28
Hard Glides (B)	add 28
Soft Glides (C)	add 43
Hard Front Glides & Hard Rear Glides (E)	add 28
Soft Front Glides & Soft Rear Glides (F)	add 43
Hard Front Casters & Hard Rear Glides (G)	add 28
Soft Front Casters & Soft Rear Glides (H)	add 43

multi-use chairs

occo chair overview

The Occo Chair is a contemporary, comfortable and light spirited multi-purpose chair.

It allows a whole host of design options for furnishing cafés and bistros, seminar and multipurpose spaces and meeting areas and conference rooms.

Occo Chair, 4-Legs (NWOG)



chair finishes



statement of line



Occo Chair,
4-Legs
(NWOG)

occo chair overview (continued)

Occo Chair, 5-Star Base (NWOW)



chair finishes

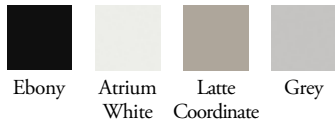

statement of line



Occo Chair,
5-Star Base
(NWOW)

multi-use chairs

occo chair dimensions & material requirements

features

- Designed and tested for users up to 300 lbs
- Meets ANSI/BIFMA Requirements

weight

Occo Chair - 4-Legs	13 lbs
---------------------	--------

Occo Chair - 4-Legs

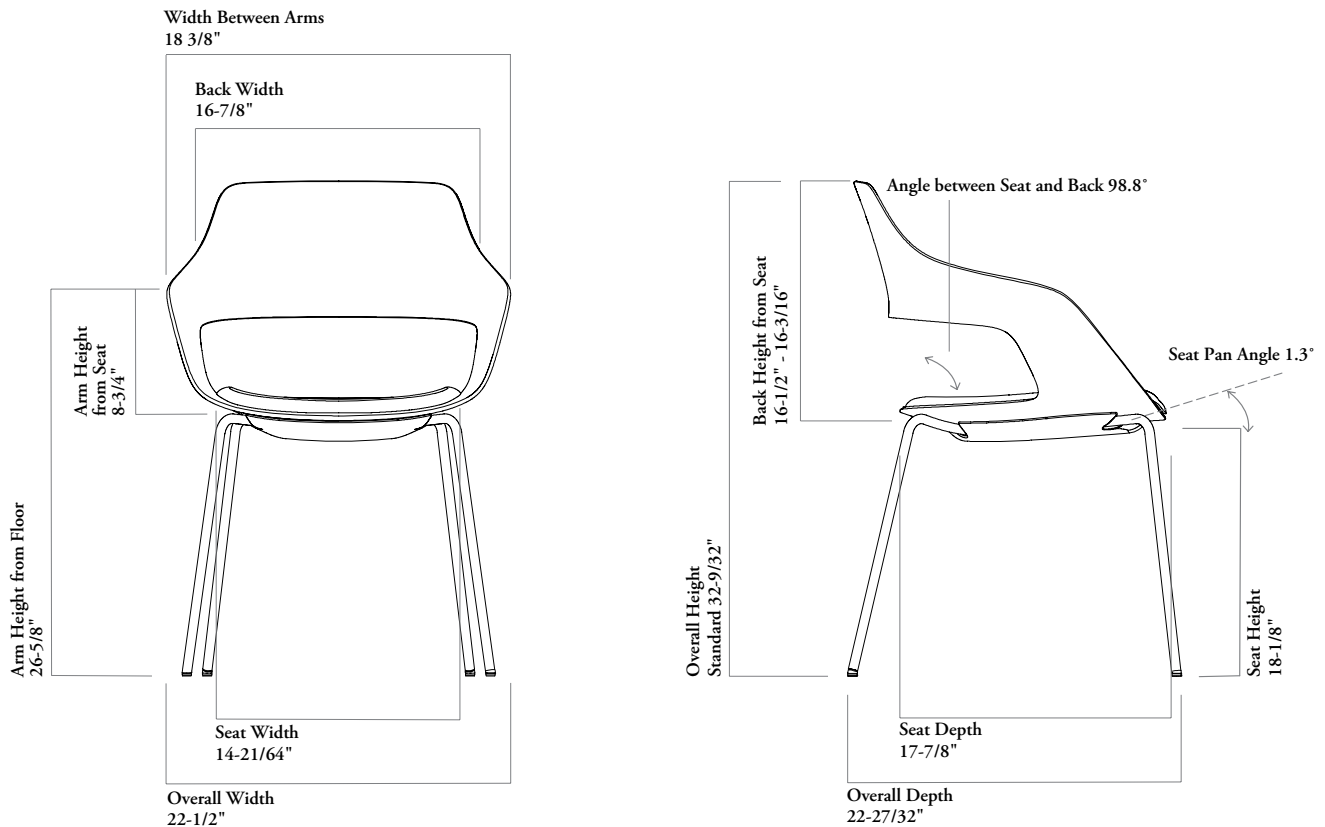

COM/COL material requirement

The pattern, repeat and directionality of fabric may increase the amount of yardage required.

Leather quantities should always be rounded up to the next hide size, as yields vary from 60-80% and are affected by the quality, size and shape of the hide, and by the location and quantity of blemishes.

UPHOLSTERED

	COM [yards]	COL [sq. ft]
Chair, 4-Legs	0.35	5

occo chair dimensions & material requirements (continued)

features

- Designed and tested for users up to 300 lbs
- Meets ANSI/BIFMA Requirements
- Equipped with hard casters intended for use on carpet
- Soft casters are available for hard surfaces
- Swivel-tilt mechanism

weight

Occo Chair - 5-Star Base	25 lbs
--------------------------	--------

Occo Chair - 5-Star Base

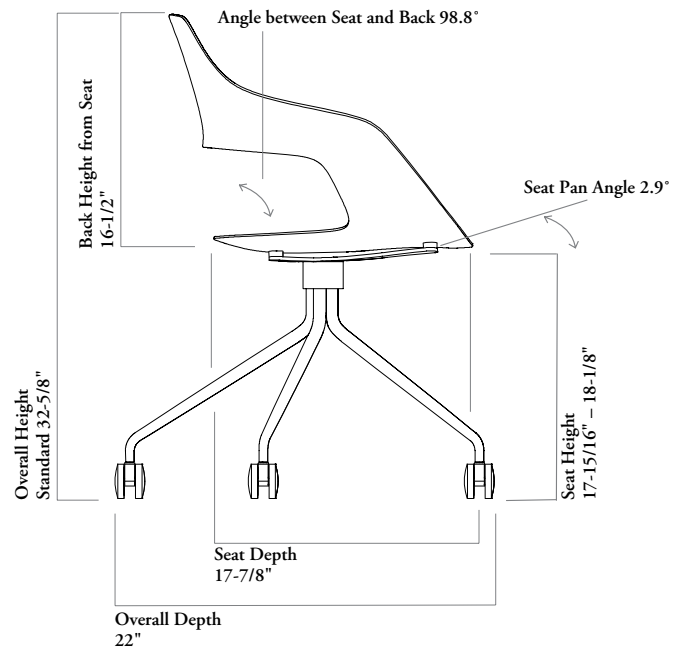
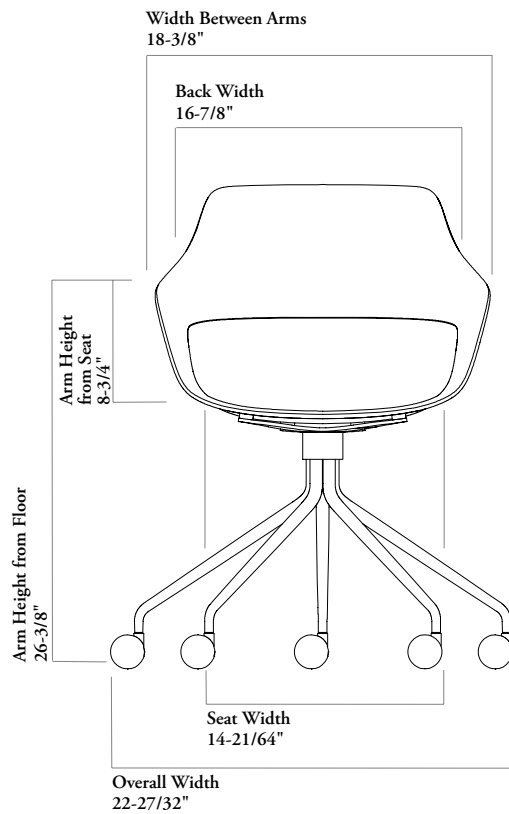

COM/COL material requirement

The pattern, repeat and directionality of fabric may increase the amount of yardage required.

Leather quantities should always be rounded up to the next hide size, as yields vary from 60-80% and are affected by the quality, size and shape of the hide, and by the location and quantity of blemishes.

UPHOLSTERED

	COM [yards]	COL [sq. ft]
Chair, 5-Star Base	0.35	5

planning with occo chair

The Occo chair can be used in a variety of application throughout a workspace.

multipurpose

The Occo chair is ideal for short term use in cafeterias, bistros and casual meeting areas.



meeting and conference rooms

The Occo chair with casters is suitable for short-term use in meeting rooms.



enclaves

The Occo chair works well in enclaves and touchdown workstations where the end user needs a space to get some quick work completed.



open environment

The Occo chair is suitable for short term use in an open environment where the end user requires a non-dedicated space to work. The Occo chair with and without casters complement each other.



multi-use chairs

N W O G

Occo Chair - 4-Legs

FEATURES

- Molded seat shell with cut out
- Optional upholstered seat in fabric or leather
- Designed and tested for users up to 300lbs
- Equipped with hard glides, soft glides are optional
- Occo Chair - 4 Legs is not stackable



PRODUCT OPTIONS

Seat Upholstery	Upholstery Finish	Chair Finish	Glides
N No	Fabric	8B Ebony	Glides, Hard
Y Yes	Leather	8D Atrium White 7R Latte Coordinate 7T Grey	B Glides, Soft

SAMPLE ORDER CODE

NWOG Y	E532	8B	B
---------------	-------------	-----------	----------

DESCRIPTION

No Seat Upholstery, with Glides, Hard
No Seat Upholstery, with Glides, Soft

PRICE

564

581

	Grade 1	COM/ Grade 2	COL/ Grade 3	Grade 4	Grade 5	Grade 6	Grade 7	Grade 8	Grade 9	Grade 10
With Seat Upholstery	739	760	778	799	822	838	858	879	899	918
	Leather LA	Leather LB	Leather LC	Leather LD						
With Seat Upholstery	918	938	959	959						

If Soft Glides (B) are specified add 17

FEATURES

- Molded seat shell with cut out
- Optional upholstered seat in fabric or leather
- Designed and tested for users up to 300lbs
- Equipped with hard casters, soft casters are optional
- Equipped with swivel-tilt mechanism

N W O W
Occo Chair - 5-Star Base



No Upholstery

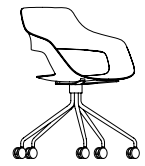

With Upholstery

PRODUCT OPTIONS

Seat Upholstery	Upholstery Finish	Chair Finish	Casters
N No	Fabric	8B Ebony	Casters, Hard
Y Yes	Leather	8D Atrium White 7R Latte Coordinate 7T Grey	A Casters, Soft

SAMPLE ORDER CODE

NWOW Y	E532	8B	B
---------------	-------------	-----------	----------

DESCRIPTION

PRICE

No Seat Upholstery, with Hard Casters

947

No Seat Upholstery, with Soft Casters

974

With Seat Upholstery

Grade 1	COM/ Grade 2	COL/ Grade 3	Grade 4	Grade 5	Grade 6	Grade 7	Grade 8	Grade 9	Grade 10
1122	1143	1161	1182	1202	1220	1241	1262	1283	1300

With Seat Upholstery

Leather LA	Leather LB	Leather LC	Leather LD
1300	1321	1342	1342

If Soft Casters (A) are specified add 28

multi-use chairs

sitara overview

Sitara features a polite and timeless design with outstanding comfort.

Sitara – Guest Chair (NSIG)



statement of line



Sitara – Guest Chair
(NSIG)

sitara dimensions & material requirements

features

- Designed and tested for users up to 300 lbs

weight

Multi-use Chair	22 lbs
-----------------	--------

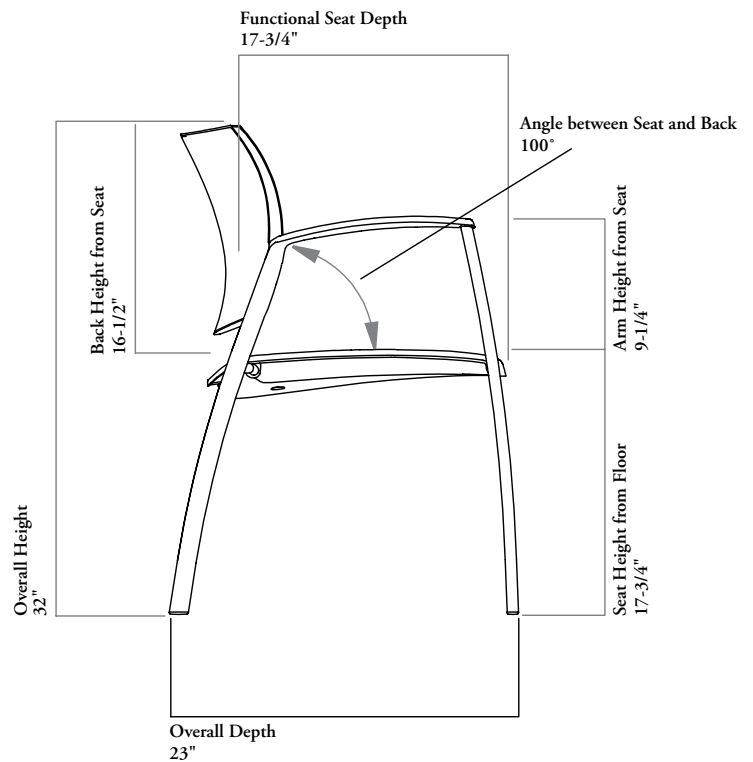
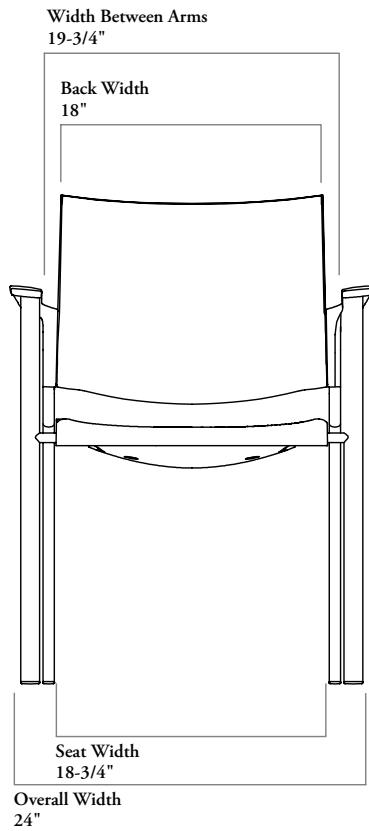

COM/COL material requirement

The pattern, repeat and directionality of fabric may increase the amount of yardage required.

Leather quantities should always be rounded up to the next hide size, as yields vary from 60-80% and are affected by the quality, size and shape of the hide, and by the location and quantity of blemishes.

	SINGLE UPHOLSTERED		DUAL UPHOLSTERED – SEAT		DUAL UPHOLSTERED – BACK	
	COM [yards]	COL [sq. ft]	COM [yards]	COL [sq. ft]	COM [yards]	COL [sq. ft]
Exposed Plastic Back	1	18	0.75	6.5	0.75	11.5
Stitched Back and Seat	2	23	0.75	6.5	1.5	16.5

multi-use chairs

NSIG

Sitara – Guest Chair



FEATURES

- Frame is finished in Ebony
- Ebony arms are plastic
- Optional Polished Aluminum arm has brushed Aluminum finish detail on the top surface of the armrest

NOTES

Exposed Plastic Back: The outer back is exposed plastic. The inner back is upholstered.

Stitched Back and Seat: Both the inner and outer back is upholstered with enhanced stitching. Seat pad is enhanced.

Single Upholstered: The same fabric is applied to the seat and inside back.

Dual Upholstered: Two different fabrics are applied to the chair, one fabric to the seat and the other fabric to the inside back. First fabric listed will apply to the back and is the grade of fabric used to price the chair. A dual upholstery upcharge applies.

Leather LD is **not** available on Sitara Guest Chair.

PRODUCT OPTIONS

Back Style	Upholstery Style	Upholstery Finish	Arm Finish
X Exposed Plastic Back	S Single Upholstered	Fabric	52 Ebony
F Stitched Back and Seat	D Dual Upholstered	Leather	C9 Polished Aluminum

SAMPLE ORDER CODE

NSIG F	S	A101	52
---------------	----------	-------------	-----------

DESCRIPTION

Exposed Plastic Back
Stitched Back and Seat

Exposed Plastic Back
Stitched Back and Seat

If Dual Upholstered (D) is specified add 256
If Polished Aluminum (C9) is specified add 169

PRICE

Grade 1	COM/ Grade 2	COL/ Grade 3	Grade 4	Grade 5	Grade 6	Grade 7	Grade 8	Grade 9	Grade 10
788	828	867	909	948	991	1029	1067	1110	1247
964	1023	1086	1145	1203	1268	1325	1384	1447	1654
Leather LA	Leather LB	Leather LC	Leather LD						
1247	1364	1611	n/a						
1612	1717	2031	n/a						

understanding sprout stools and tables

The Sprout collection of stools and tables is inspired by nature – budding flowers, foliage and branches at varying stages of size and growth. Each can be displayed solo, like a small flower in a bud vase, or be part of a larger arrangement of similar or varying colors and textures.



sprout stools

Sprout Stools are portable and casual and ideal for use in workplaces, phone booths, cafeterias, retail and educational settings.

They are available in three heights:

- Task Height
- Counter Height
- Bar Height



sprout round tables

Sprout Round Tables also with trumpet bases, are ideal for use in any setting and complement Sprout Stools.

They are available in four heights:

- Lounge Height
- Task Height
- Counter Height
- Bar Height



sprout soft square tables

Sprout Soft Square Tables with trumpet bases are ideal for use in any setting and complement sprout stools.

They are available in four heights:

- Lounge Height
- Task Height
- Counter Height
- Bar Height

sprout stool overview

The Sprout Stool is a portable, casual stool ideal for use in workplaces, phone booths, cafeterias, cafes, retail and educational settings. Optional Seat Heights are fixed in task, counter or bar height which is more safe and ideal for commercial applications.

Sprout Stool (NSPS)

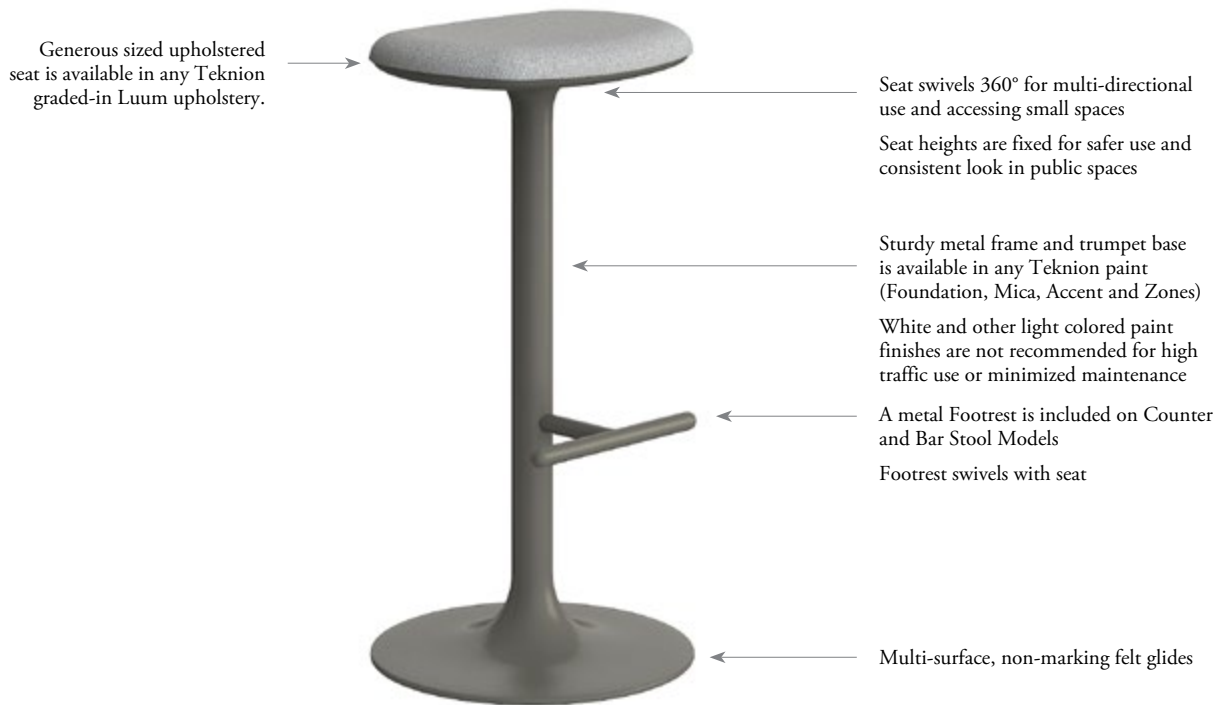

statement of line



sprout dimensions & material requirements

features

- Designed and tested for users up to 300 lbs
- Meets ANSI/BIFMA Requirements
- The Sprout Stool seat is generously proportioned and has rounded edges for added comfort

weight

Task Height	17 lbs
Counter Height	19 lbs
Bar Height	20 lbs

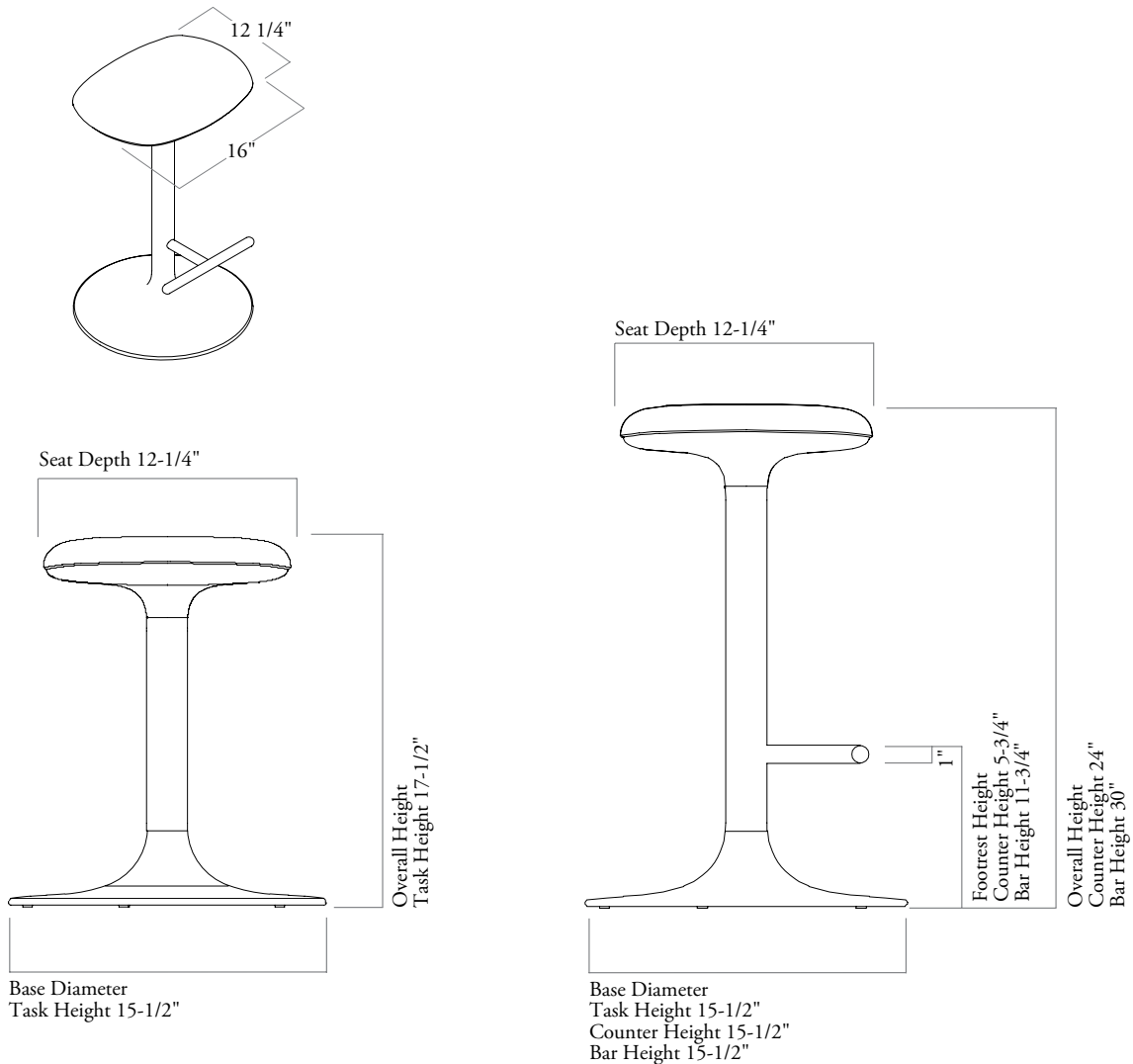

COM/COL material requirement

The pattern, repeat and directionality of fabric may increase the amount of yardage required.

Leather quantities should always be rounded up to the next hide size, as yields vary from 60-80% and are affected by the quality, size and shape of the hide, and by the location and quantity of blemishes.

SINGLE UPHOLSTERED

	COM [yards]	COL [sq. ft]
Task Height	0.5	2.5
Bar Height	0.5	2.5
Counter Height	0.5	2.5

planning with sprout stools

The Sprout Stool can be used in a variety of application throughout a workspace.

- Sprout Stools can be used on their own, with millwork or tables. Sprout Tables complement the Sprout Stools and are available in coordinating sizes

Sprout Stools are available in three different heights:

- Task Height
- Counter Height
- Bar Height

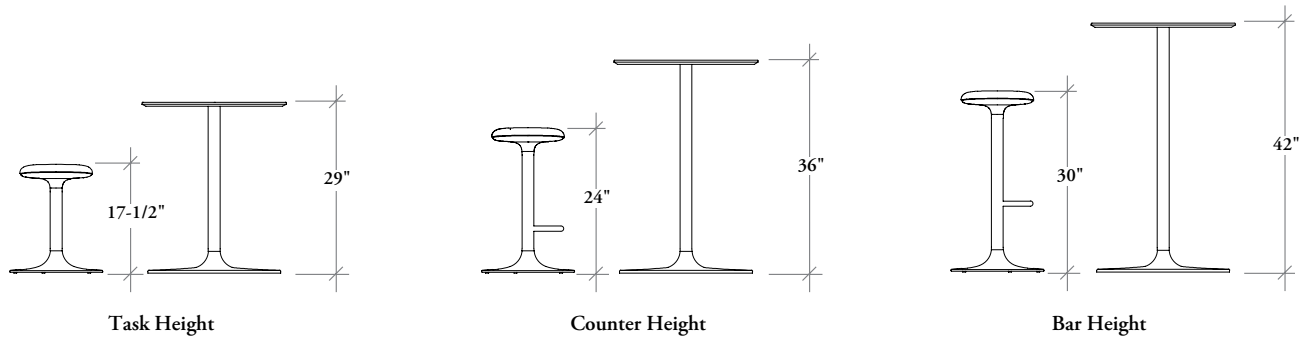

Sprout Stools can be planned in a variety of ways to create different workspaces and environments within a corporate, commercial, public or residential space.

workspaces



A contemporary, compact, fun solution for casual guest seating in a workstation.

casual privacy



Sprout Stools at Bar Height complement the Tek Booth phone booth. The swivel seat enables you to easily get in and out of the space.

planning with sprout stools (continued)

lounge & casual



Blend with other products like Zones, Banqs and Teknion DNA to provide more casual solutions.

cafes & hospitality



Blend with Sprout Tables and Banqs banquettes to create interesting spaces and varying heights across a cafeteria.

collaborative



educational



Apply Luum polyurethane upholstery to the seat to make a more durable solution.

retail



Consider as a casual customer perching stool or to rest your bags at a teller or retail counter.

sprout table overview

Sprout Round Table (NSPR) (shown)

Table surface is 1" thick
 Top Finish:
 Foundation Laminate, Zones
 Laminate, Flintwood or Natural
 Veneer Options
 Table Edge trim Style:
 Flat trim or Full Knife Edge



Base:
 Sturdy painted metal frame and base
 corresponds with Sprout Stools.
 Available in any Teknion paint:
 Foundation, Mica, Accent or Zones.
 White and other light colored paint
 finishes are not recommended
 for high traffic use or minimized
 maintenance.
 Multi-surface non-marking felt glides

(Sprout Round Table, 24" diameter,
 Bar Height Shown)

Available in the following sizes:
 - 24" diameter
 - 30" diameter

statement of line

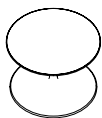

Sprout Round Table,
 Lounge Height
 (NSPRL)

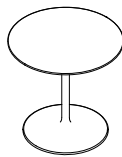

Sprout Round Table,
 Task Height
 (NSPRT)

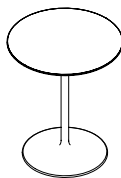

Sprout Round Table,
 Counter Height
 (NSPRC)

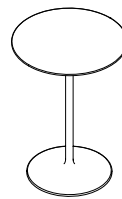

Sprout Round Table,
 Bar Height
 (NSPRB)

sprout table overview (continued)

Sprout Soft Square Table (NSPT)

Table surface is 1" thick
Top Finish:
Foundation Laminate,
Zones Laminate, Flintwood
or Natural Veneer Options



Table Edge Trim Style:
Flat Trim or Full Knife Edge

Base:
Sturdy painted metal
frame and base
corresponds with Sprout
Stools. Available in
any Teknion paint:
Foundation, Mica, Accent
or Zones.
White and other light
colored paint finishes are
not recommended for high
traffic use or minimized
maintenance.

Multi-surface non-marking
felt glides

(Sprout Soft-Square Table, 30" deep x
30" wide, Task Height Shown)

Available in the following sizes:

- 24" deep x 24" wide
- 30" deep x 30" wide

statement of line

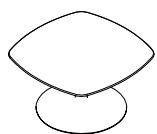

Sprout Soft-Square
Table, Lounge Height
(NSPTL)

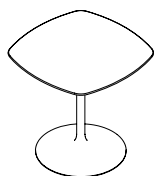

Sprout Soft-Square
Table, Task Height
(NSPTT)

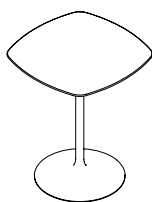

Sprout Soft-Square
Table, Counter Height
(NSPTC)



Sprout Soft-Square
Table, Bar Height
(NSPTB)

sprout tables dimensions & material requirements

weight

Sprout Round Table, Lounge Height, 24" diameter	69 lbs
Sprout Round Table, Lounge Height, 30" diameter	76 lbs
Sprout Round Table, Task Height, 24" diameter	71 lbs
Sprout Round Table, Task Height, 30" diameter	78 lbs
Sprout Round Table, Counter Height, 24" diameter	72 lbs
Sprout Round Table, Counter Height, 30" diameter	79 lbs
Sprout Round Table, Bar Height, 24" diameter	73 lbs
Sprout Round Table, Bar Height, 30" diameter	80 lbs

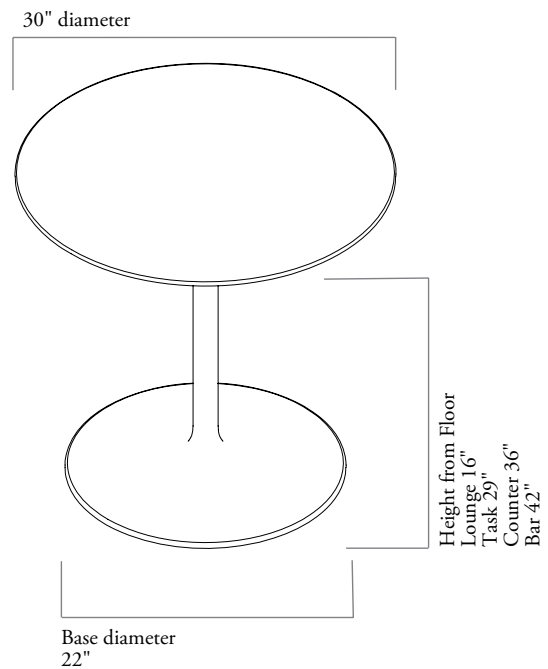
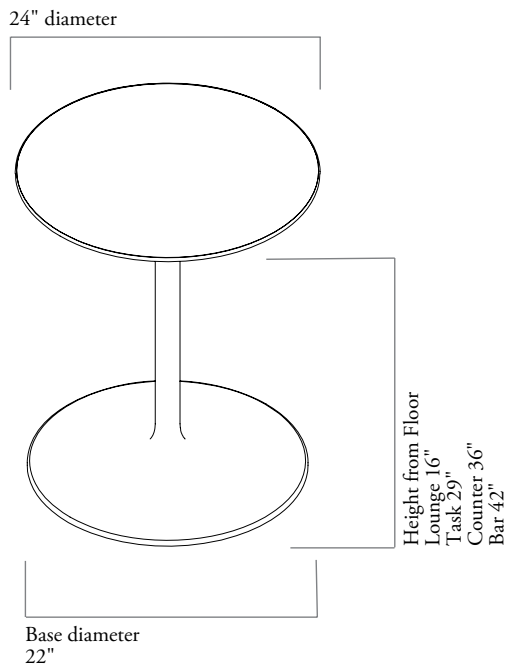

sprout tables dimensions & material requirements (continued)

weight

Sprout Soft-Square Table, Lounge Height, 24"l	71 lbs
Sprout Soft-Square Table, Lounge Height, 30"l	79 lbs
Sprout Soft-Square Table, Task Height, 24"l	73 lbs
Sprout Soft-Square Table, Task Height, 30"l	81 lbs
Sprout Soft-Square Table, Counter Height, 24"l	74 lbs
Sprout Soft-Square Table, Counter Height, 30"l	82 lbs
Sprout Soft-Square Table, Bar Height, 24"l	75 lbs
Sprout Soft-Square Table, Bar Height, 30"l	83 lbs

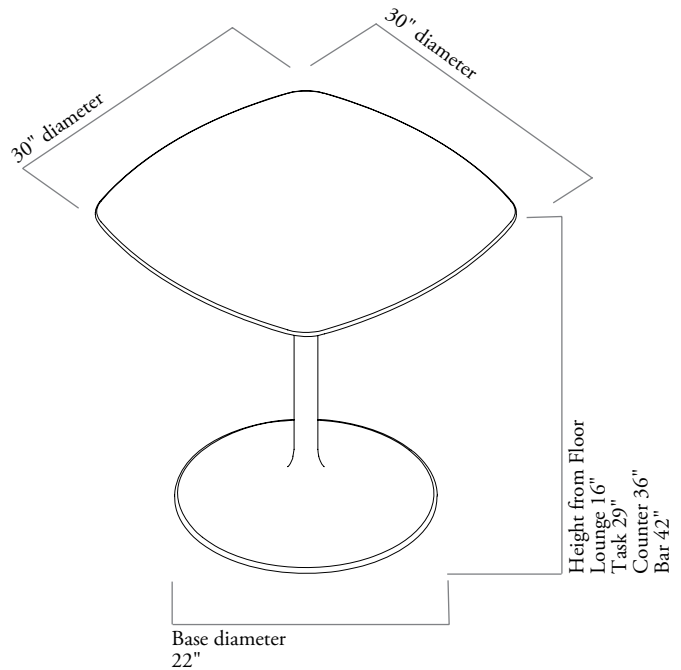
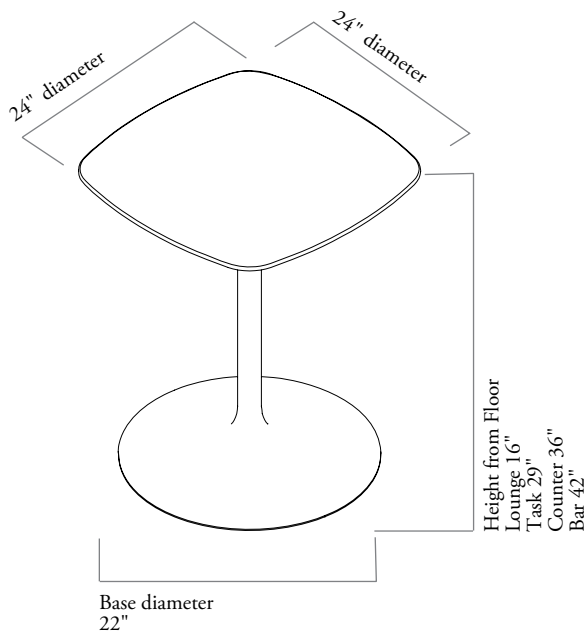

planning with sprout tables

Sprout Tables can be used with Sprout Stools, with other chairs and stools or own their own for stand-up applications.

Sprout Tables are available in lounge, task, counter and bar height to allow for different meeting styles.

lounge

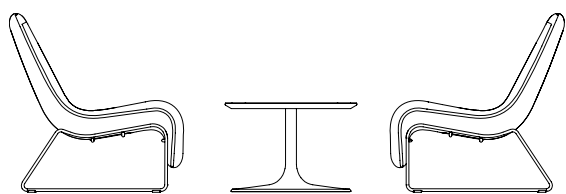

Lounge Height 16" High

touch-down working and meeting

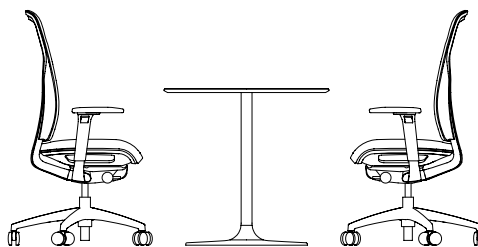

Task Height 29" High

casual workspace

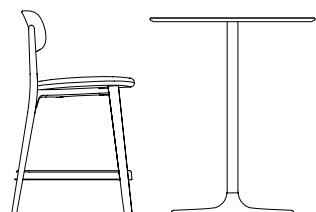

Counter Height 36" High

hospitality and cocktail receptions

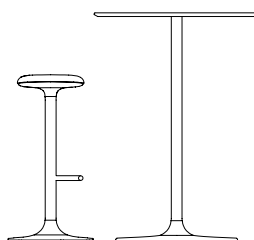

Bar Height 42" High

planning with sprout tables (continued)

Task, Counter and Bar Height Sprout Stools have heights that correspond with tables of the same name. The following should be considered when planning with Sprout Tables.

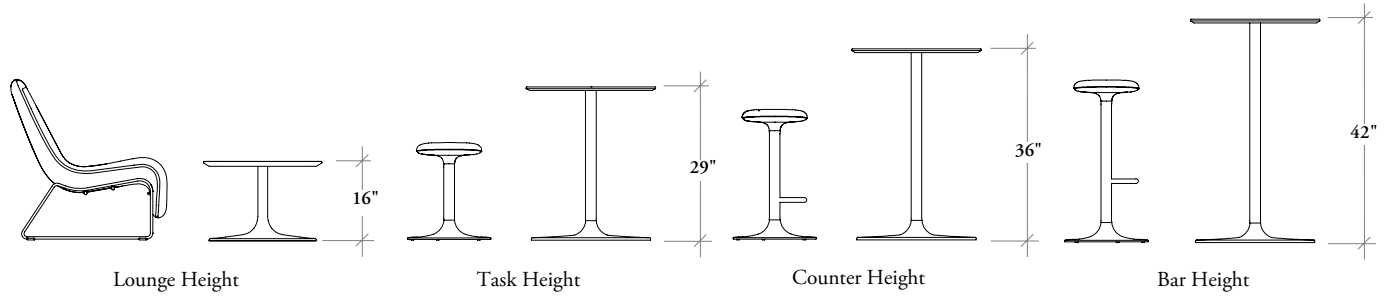

recommended occupancy

The following demonstrates the recommended table occupancy to allow for adequate personal and casual working space on Sprout Tables.

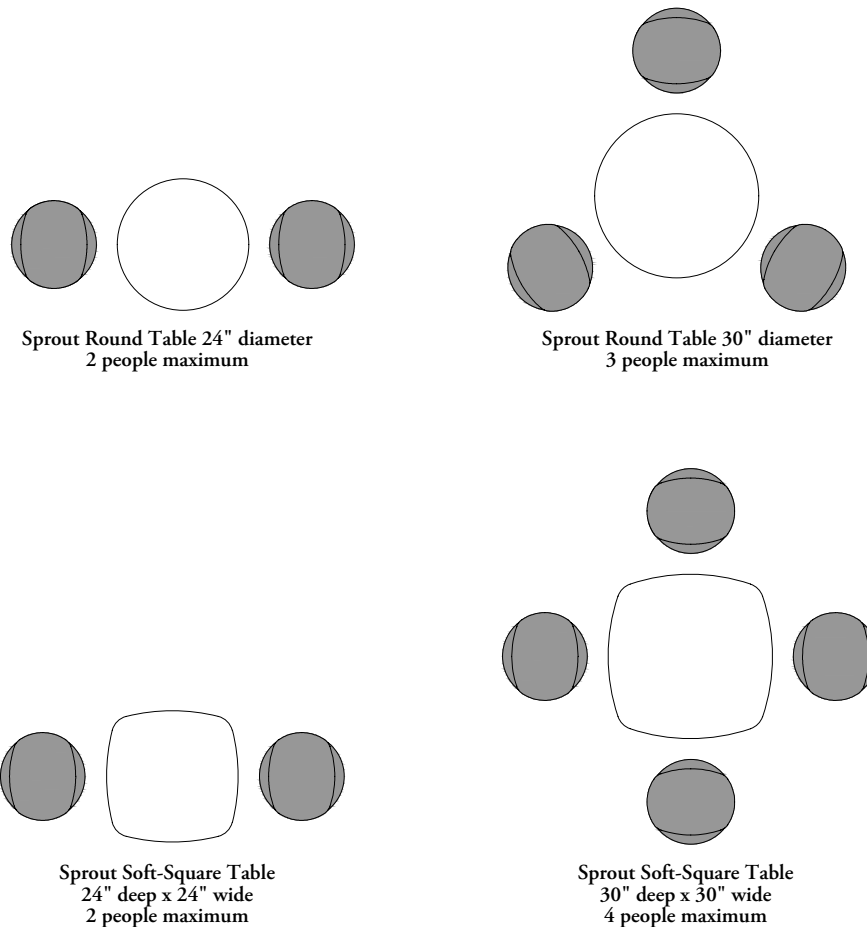

multi-use chairs

NSPS Sprout Stool

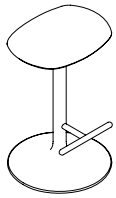

FEATURES

- Portable, casual stool ideal for use in workplaces, phone booths, cafeterias, cafes, retail & educational settings
- Coordinate with Sprout Tables or other. Task Height for 29" high table or worksurface, Counter Height for 36" high counter & Bar Height for 42" high bar surface
- 300 pound weight capacity
- Seat is generously proportioned. Seat swivels 360° which is beneficial for use in small spaces & for encouraging movement
- Seat heights are fixed for safer use and consistent look in public spaces
- Counter & Bar Height model includes footrest which swivels with seat
- Single Upholstered Seat
- Multi-surface, non-marking felt glides
- Fully assembled

NOTES

Robustly constructed metal frame & base sub-assembly can be painted any Teknion paint finish allowing coordination with Sprout Tables & LUUM upholstery

PRODUCT OPTIONS

Height Style	Seat Upholstery Finish	Base Finish
T Task Height	Fabric	Foundation
C Counter Height	Leather	Mica
B Bar Height		Accent

SAMPLE ORDER CODE

NSPS C	E515	25
--------	------	----

DESCRIPTION

Task Height (T)
Counter Height (C)
Bar Height (B)
Task Height (T)
Counter Height (C)
Bar Height (B)

PRICE

Grade 1	COM/ Grade 2	COL/ Grade 3	Grade 4	Grade 5	Grade 6	Grade 7	Grade 8	Grade 9	Grade 10
596	623	650	665	677	690	705	718	733	748
664	688	715	731	742	759	770	786	799	815
730	756	783	796	809	825	836	853	864	882
Leather LA	Leather LB	Leather LC	Leather LD						
930	984	1152	1209						
995	1051	1218	1274						
995	1051	1218	1274						

If Mica Base is specified	add 35
If Accent Base is specified	add 50
If Greystone Base is specified	add 35

FEATURES

- Casual Tables with trumpet bases that are ideal for use in workplaces, enclaves, cafeterias, cafes, retail & educational settings
- Table tops offered in any of Teknion’s Laminate, Flintwood, or Veneer finishes. Boutique surfaces available as a Special
- Multi-surface, non-marking felt glides

NOTES

Table tops are cozy in size- offered as 24” and 30” Round Table (NSPR) shapes. The 24” tops are ideal as a cocktail table to rest your beverage while the larger diameter table provides more space for a couple of people to eat, socialize or work- all in the same space. Coordinates with Sprout Stools (NSPS) & Sprout Soft Square Tables (NSPT). Task Height for 29” high table or worksurface, Counter Height for 36” high counter & Bar Height for 42” high bar surface. Additional 16” High Lounge model is offered to be used with lounge seating. Robustly constructed metal frame & base sub-assembly can be painted any Teknion paint finish allowing coordination with Sprout Stools.

**NSPR
Sprout Round Table**

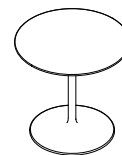

PRODUCT OPTIONS

Height Style	Diameter	Surface Finish	Edge Trim Style	Edge Trim Finish	Base Finish
L Lounge	24	Foundation Laminate	8 Flat Trim	Edge Trim Colors	Foundation
T Task	30	Zones Exclusive Laminate	9 Flat Edge		Mica
C Counter		Flintwood	H Full Knife Edge		Accent
B Bar		Natural Veneer			

SAMPLE ORDER CODE

NSPR T	24	2T	8	ST	24
---------------	-----------	-----------	----------	-----------	-----------

DESCRIPTION

PRICE

	FOUNDATION LAMINATE		FLINTWOOD		ZONES EXCLUSIVE LAMINATE		VENEER	
	Flat Trim	Full Knife Trim	Flat Trim	Full Knife Trim	Flat Trim	Full Knife Trim	Flat Trim	Full Knife Trim
Lounge Height, 24" diameter	1226	1385	1934	2011	1226	1385	2275	2355
Lounge Height, 30" diameter	1257	1426	1981	2061	1257	1426	2334	2414
Task Height, 24" diameter	1212	1372	1920	2000	1212	1372	2262	2341
Task Height, 30" diameter	1242	1414	1970	2050	1242	1414	2322	2402
Counter Height, 24" diameter	1151	1312	1470	1550	1151	1312	1822	1902
Counter Height, 30" diameter	1176	1348	1702	1779	1176	1348	2054	2132
Bar Height, 24" diameter	1177	1336	1496	1576	1177	1336	1849	1927
Bar Height, 30" diameter	1203	1375	1728	1806	1203	1375	2081	2159

- If Mica Base is specified add 56
- If Accent Base is specified add 71
- If Zones Exclusive Base is specified add 56

multi-use chairs

NSPT Sprout Soft-Square Table

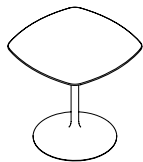

FEATURES

- Casual Tables with trumpet bases that are ideal for use in workplaces, enclaves, cafeterias, cafes, retail & educational settings.
- Table tops offered in any of Teknion's Laminate, Flintwood, or Veneer finishes. Boutique surfaces available as a Special
- Multi-surface, non-marking felt glides

NOTES

Table tops are cozy in size- offered as 24" x 24" and 30" x 30" Soft-Square shapes that are radiused at the corners. The 24" tops are ideal as a cocktail table to rest your beverage while the larger diameter table provides more space for a couple of people to eat, socialize or work- all in the same space.

Coordinates with Sprout Stools (NSPS) & Sprout Round Tables (NSPR). Task Height for 29" high table or worksurface, Counter Height for 36" high counter & Bar Height for 42" high bar surface. Additional 16" high Lounge Height model is offered to be used with lounge seating.

Robustly constructed metal frame & base sub-assembly can be painted any Teknion paint finish allowing coordination with Sprout Stools.

PRODUCT OPTIONS

Height Style	Length	Surface Finish	Edge Trim Style	Edge Trim Finish	Base Finish
L Lounge	24	Foundation Laminate	8 Flat Trim	Edge Trim Colors	Foundation
T Task	30	Zones Exclusive Laminate	9 Flat Edge		Mica
C Counter		Flintwood	H Full Knife Edge		Accent
B Bar		Natural Veneer			

SAMPLE ORDER CODE

NSPT T	24	2T	8	ST	24
--------	----	----	---	----	----

DESCRIPTION

PRICE

	FOUNDATION LAMINATE		FLINTWOOD		ZONES EXCLUSIVE LAMINATE		VENEER	
	Flat Trim	Full Knife Trim	Flat Trim	Full Knife Trim	Flat Trim	Full Knife Trim	Flat Trim	Full Knife Trim
Lounge Height, 24"	1155	1326	1629	1709	1155	1326	1995	2073
Lounge Height, 30"	1180	1337	1853	1933	1180	1337	2214	2296
Task Height, 24"	1143	1314	1617	1697	1143	1314	1980	2060
Task Height, 30"	1167	1325	1839	1919	1167	1325	2203	2281
Counter Height, 24"	1109	1267	1414	1494	1109	1267	1777	1857
Counter Height, 30"	1131	1302	1637	1714	1131	1302	2000	2080
Bar Height, 24"	1136	1293	1441	1521	1136	1293	1804	1884
Bar Height, 30"	1158	1328	1661	1741	1158	1328	2027	2107

If Mica Base is specified	add	56
If Accent Base is specified	add	71
If Zones Exclusive Base is specified	add	56

multi-use chairs

synapse overview

Synapse is a contemporary wood side chair that combines traditional joinery with a unique ready-to-assemble construction.

Synapse – Wood Guest Chair (NSYN)

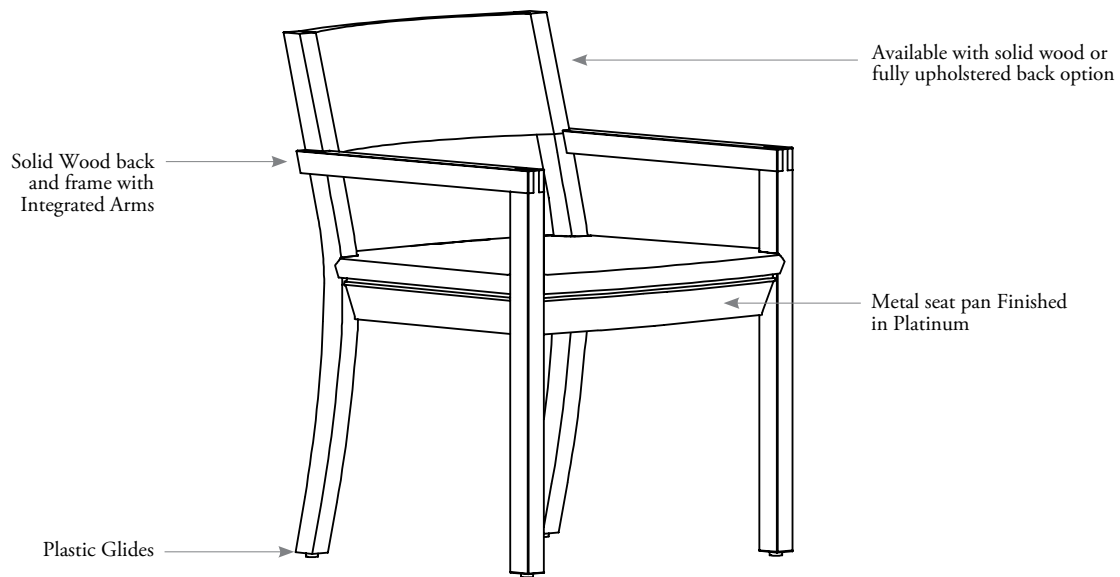

statement of line



Mid-Back –
Integrated Arms,
Single Upholstered
(NSYN)



Mid-Back –
Integrated Arms,
Fully Upholstered
(NSYF)

synapse dimensions & material requirements

features

- Designed and tested for users up to 250 lbs

weight

Multi-Use Chair	20 lbs
-----------------	--------

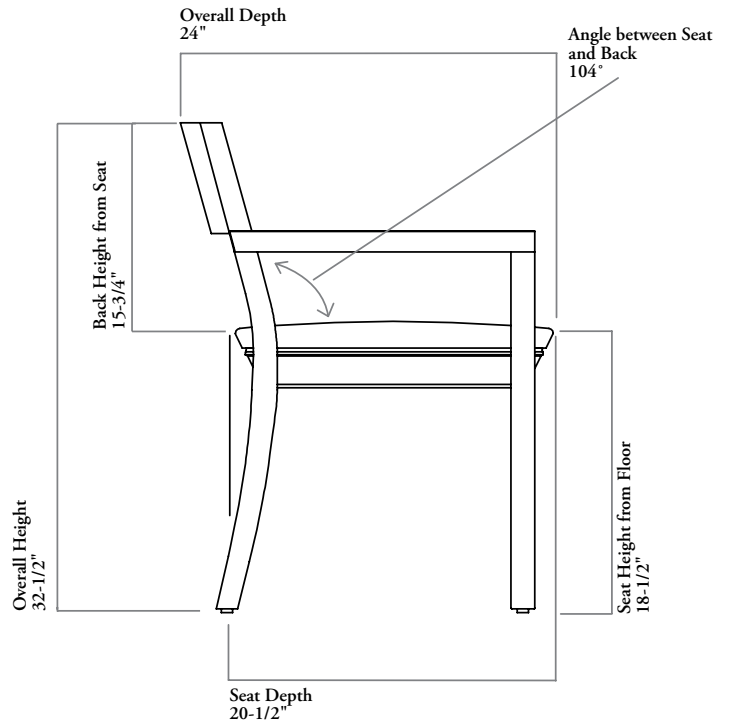
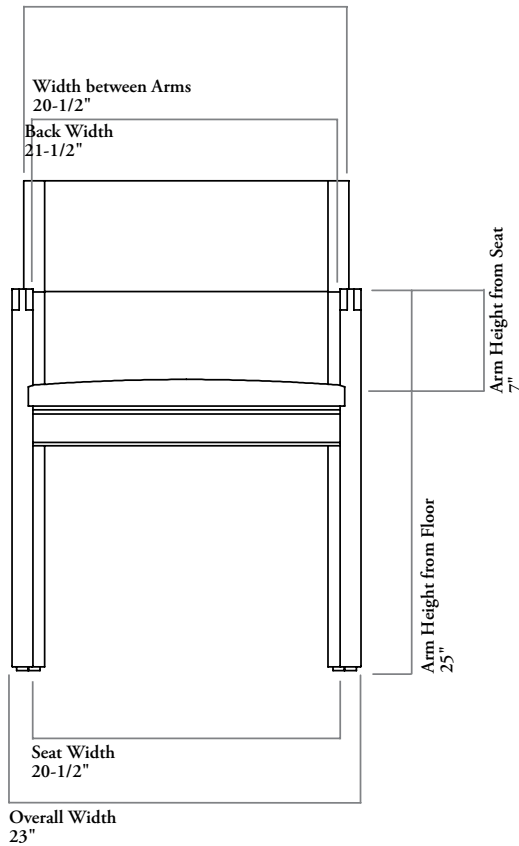

COM/COL material requirement

The pattern, repeat and directionality of fabric may increase the amount of yardage required.

Leather quantities should always be rounded up to the next hide size, as yields vary from 60-80% and are affected by the quality, size and shape of the hide, and by the location and quantity of blemishes.

	COM [yards]	COL [sq. ft]
Single Slat Back, Upholstered Seat	1	6
Fully Upholstered	1.25	14

multi-use chairs

Xpress

NSYN

Synapse – Wood Guest Chair



Mid-Back –
Integrated Arms

FEATURES

- Floor glides are standard

NOTES

Single Stain: The same stain is applied to the entire chair.

A TekniStain form is required if a Teknion Wood product is needed in colors outside our standard offering. To order a Custom Wood Stain please use the seating code NOCWS. A one time upcharge per color applies. Please forward a purchase order and TekniStain form to your Customer Service Representative. Allow two (2) weeks for the TekniStain approval process. The Custom Wood Stain sample must be signed off prior to placing product order. Allow (3) extra weeks to the total lead time of the chair when using a custom wood stain. The total lead time will begin once final approved samples have been received from customer to Teknion. The custom wood stain sample must be signed off prior to placing product order.

PRODUCT OPTIONS

Assembly Style	Wood Species	Arm Style	Finish Style	Upholstery Finish	Maple Back and Frame Finish
F Fully Assembled	M Maple	I Integrated Arms	S Single Stain	Fabric Leather	Maple Stains Custom Stains

SAMPLE ORDER CODE

NSYN F	M	I	S	M501	
---------------	----------	----------	----------	-------------	--

DESCRIPTION

Maple Wood – Integrated Arms (Single Stain)

Maple Wood – Integrated Arms (Single Stain)

PRICE

COM/		COL								
Grade 1	Grade 2	Grade 3	Grade 4	Grade 5	Grade 6	Grade 7	Grade 8	Grade 9	Grade 10	
1383	1414	1447	1474	1503	1535	1567	1595	1624	1731	

Leather	Leather	Leather	Leather
LA	LB	LC	LD
1530	1611	1695	1720

To order a Custom Wood Stain Color for Seating please use the code NOCWS. A one time 1141 list charge per color applies.

FEATURES

- Floor glides are standard

NOTES

Single Stain: The same stain is applied to the entire chair.

Dual Stain: Two different stains are applied to the Beech Chair, one stain to the back end rear legs and the other stain to the arms and front legs.

Single Upholstered: The same fabric is applied to the seat and back.

Dual Upholstered: Two different fabrics are applied to the chair, one fabric to the seat and the other fabric to the back. First fabric listed will apply to the back and is the grade of fabric used to price the chair. A dual upholstery upcharge applies.

NSYF

Synapse – Fully Upholstered Wood Guest Chair

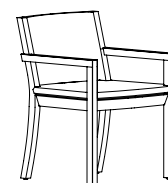

Mid-Back – Integrated Arms

PRODUCT OPTIONS

Wood Species	Arm Style	Finish Style	Upholstery Style	Back Upholstery Finish	Maple Back and Frame Finish
M Maple	I Integrated Arms	S Single Stain	S Single Upholstered	Fabric Leather	Maple Stains Custom Wood Stains

SAMPLE ORDER CODE

NSYF M	I	S	S	M501	
---------------	----------	----------	----------	-------------	--

DESCRIPTION

PRICE

	COM/		COL/		Grade 4	Grade 5	Grade 6	Grade 7	Grade 8	Grade 9	Grade 10
	Grade 1	Grade 2	Grade 3	Grade 3							
Maple Wood – Integrated Arms (Single Stain)	1648	1687	1727	1768	1806	1849	1887	1930	1969	2110	
Maple Wood – Integrated Arms (Single Stain)	2110	2141	2304	2365							

If Dual Upholstered (D) is specified, add 256

To order a Custom Wood Stain Color for Seating please use the code NOCWS. A one time 1141 list charge per color applies.

multi-use chairs

taiga overview

Taiga is a classic wood side chair with a wood slat back or upholstered full and half-back options.

Taiga – Wood Guest Chair (NTAGK)

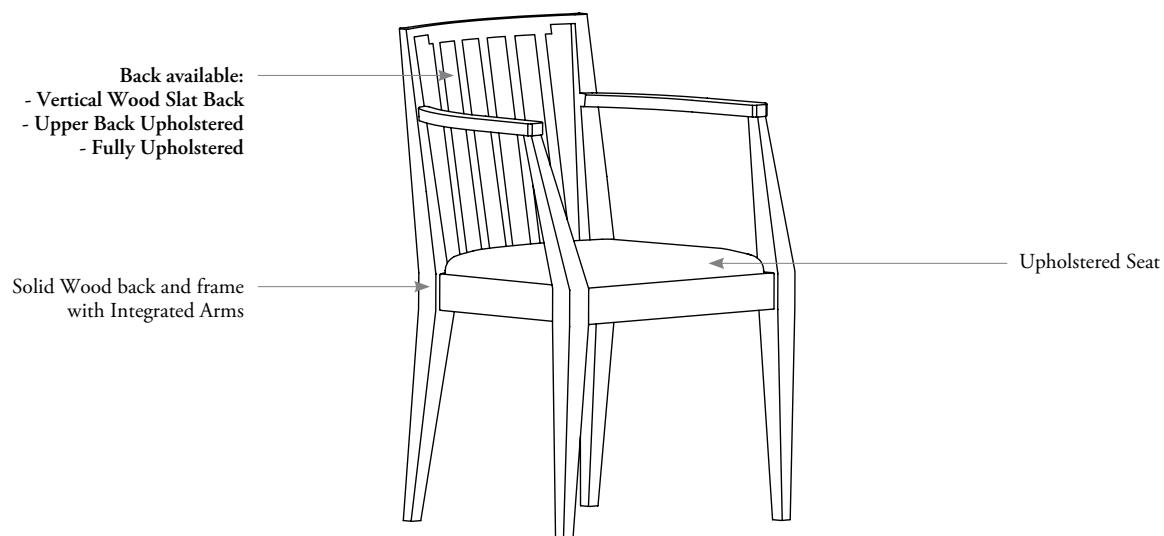

statement of line



Upper Back Upholstered (NTAGKM)



Fully Upholstered (NTAGKF)



Vertical Wood Slat Back (NTAGKV)

taiga dimensions & material requirements

features

- Designed and tested for users up to 250 lbs

weight

Multi-Use Chair	25 lbs
-----------------	--------

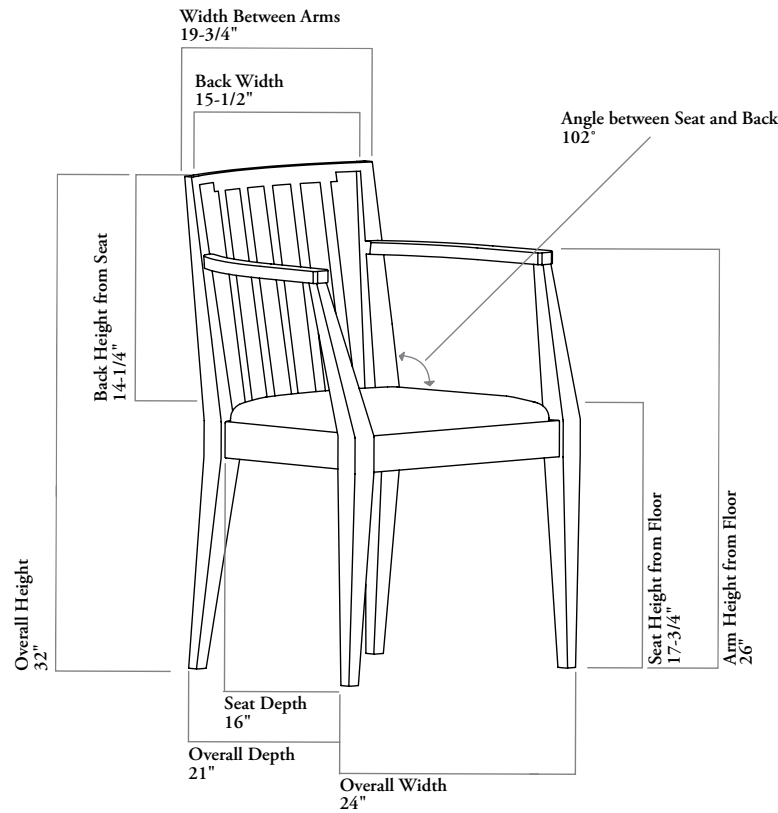

COM/COL material requirement

The pattern, repeat and directionality of fabric may increase the amount of yardage required.

Leather quantities should always be rounded up to the next hide size, as yields vary from 60-80% and are affected by the quality, size and shape of the hide, and by the location and quantity of blemishes.

	COM [yards]	COL [sq. ft]
Upper Back and Seat Upholstered	1	17
Fully Upholstered Back and Seat	1.25	26
Vertical Wood Slat Back, Upholstered Seat	1	17

multi-use chairs

Xpress

NTAGK

Taiga – Wood Guest Chair

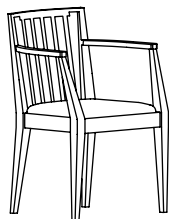

NOTES

Upper Back Upholstered (M): The upper portion of the back and complete seat are upholstered.

Fully Upholstered (F): The complete back and seat are upholstered.

Vertical Wood Slat Back (V): Only the seat will be upholstered. The finish for the vertical wood slats defaults to the specified frame finish.

A TekniStain form is required if a Teknion Wood product is needed in colors outside our standard offering. To order a Custom Wood Stain please use the seating code NOCWS. A one time upcharge per color applies. Please forward a purchase order and TekniStain form to your Customer Service Representative. Allow two (2) weeks for the TekniStain approval process. The Custom Wood Stain sample must be signed off prior to placing product order. Allow (3) extra weeks to the total lead time of the chair when using a custom wood stain. The total lead time will begin once final approved samples have been received from customer to Teknion. The custom wood stain sample must be signed off prior to placing product order.

PRODUCT OPTIONS

Back Style	Upholstery Finish	Frame Finish
V Vertical Wood Slat Back (Shown)	Fabric	Wood Stain Coordinates
M Upper Back Upholstered	Leather	Custom Wood Stains
F Fully Upholstered		

SAMPLE ORDER CODE

NTAGK F	M107	NM
----------------	-------------	-----------

DESCRIPTION

PRICE

	Grade 1	COM/ Grade 2	COL/ Grade 3	Grade 4	Grade 5	Grade 6	Grade 7	Grade 8	Grade 9	Grade 10
Upper Back Upholstered	1501	1540	1579	1618	1654	1696	1732	1770	1806	1942
Fully Upholstered	1619	1668	1713	1761	1807	1858	1908	1953	2002	2169
Vertical Wood Slat Back	1637	1674	1710	1749	1789	1827	1865	1906	1942	2078
	Leather LA	Leather LB	Leather LC	Leather LD						
Upper Back Upholstered	1969	2044	2278	2357						
Fully Upholstered	2310	2433	2787	2907						
Vertical Wood Slat Back	2078	2180	2412	2491						

To order a Custom Wood Stain Color for Seating please use the code NOCWS. A one time 1141 list charge per color applies.

planning with variable multi-purpose chair family

Designed by Alessandro Piretti, this broad family of chairs can be used throughout the workplace to provide a common chair solution for multiple needs. It is suited to the educational market, corporate collaborative areas, auditoriums and lunch and meeting rooms.

key features:

- Variable Multi-Purpose Chair collection includes a HybrED Chair, a 4-Leg Stacking Guest Chair, 4-Leg Stacking Bar and Counter Height Stool, Swivel Multi-Use Work Chair, Swivel Stool and Conference Chair
- Flexible zones in seat and backrest that are optimized for user comfort based on the pressure maps
- Variable Chairs have been designed and tested for users up to 300 lbs
- The design aesthetic, upholstery and finish options compliment Thesis Educational Training Tables and Desking
- Can be integrated across an entire Teknion floor plate
- 12 different Plastic finishes
- Optional Bookracks, Tablets, Ganging Devices and a Dolly are available

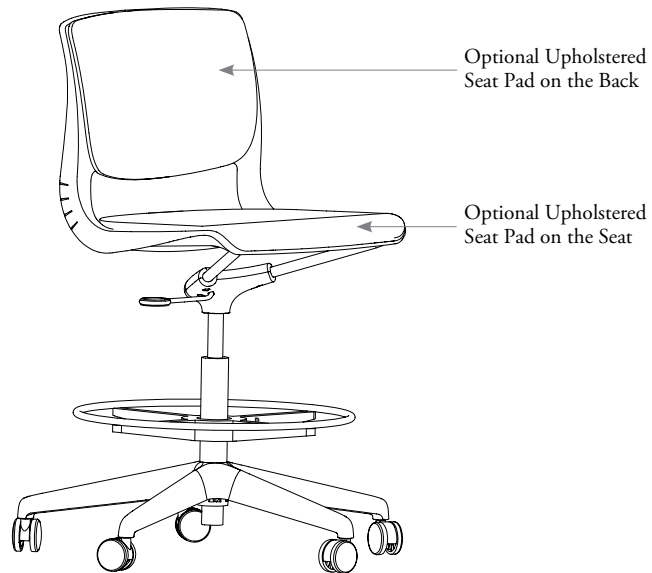
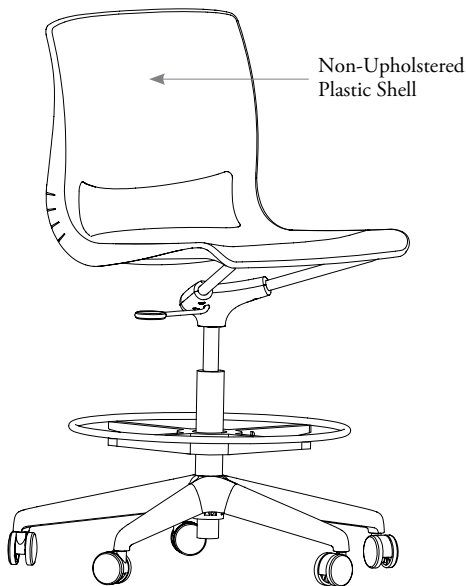

Variable Chairs are available Not Upholstered, Single Upholstered Seat only, Single Upholstered Seat and Back or Dual Upholstered Seat and Back.

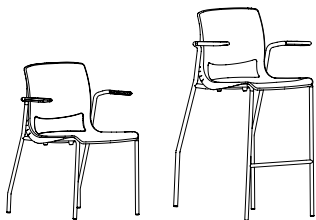

4-Leg Guest Chairs and Stools with arms and without arms may be stacked on the floor and Guest Chairs may also be stacked on the Dolly. Guest Chairs are stackable when either caster or glide options are specified.

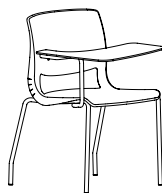

The Tablet can be applied to any type of armless Variable Chair. The 4-Leg Stacking Guest Chairs and Stools with Tablets may be stacked.



The Bookrack can be installed on the 4-Leg Stacking Guest Chair or Stacking Stools. Chairs with Bookracks do not stack.

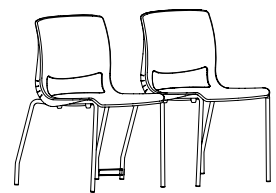

A Ganging Device is available to help align Guest Chairs in a linear pattern. Ganging devices must be specified for application with chairs with no arms or for chairs with arms or tablets.

educational applications

High performance standards, contemporary aesthetics and reconfigurable furniture help shape minds of all ages. The Variable chair is ideal for single student, project group, classroom and lecture hall applications.

single students

Study carrels or focused touch-down areas can be created with Thesis and Variable 4-Leg Guest Chairs. Chairs stack for easy facility maintenance. Options are available with casters or glides and with or without arms.

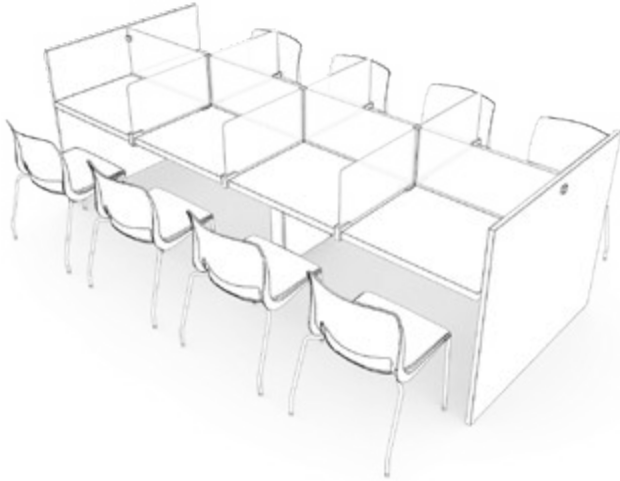

For more details on this model of chair, please refer to the Stacking Chairs section.



Focus



For more details on this model of chair, please refer to later in this section.



Privacy

Variable HybrED Chairs can be used for Single-Student Focused Work such as studying or for Privacy during test-taking. It can be combined with the Thesis Mobile Screen for more spontaneous configurations and options for space division.

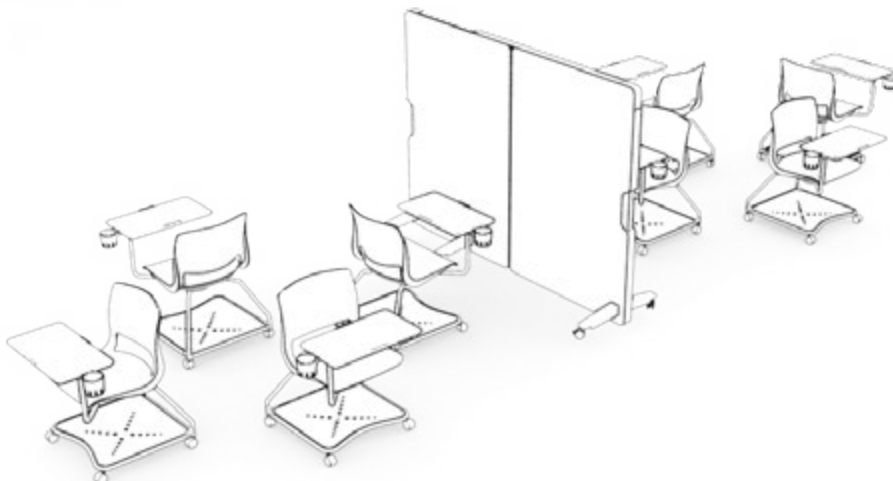

For more details on this model of chair, please refer to later in this section.



educational applications (continued)

project groups

Project or team meeting areas can be created with Thesis Tables and Variable Multi-Use Work Chairs or Conference Chairs. Both chair types swivel and are available with or without arms. While the Conference Chair is fixed-height and no fuss, the Work Chair is height-adjustable; perfect to accommodate users who may be sitting in the chair for a longer period of time and require a bit more adjustability.

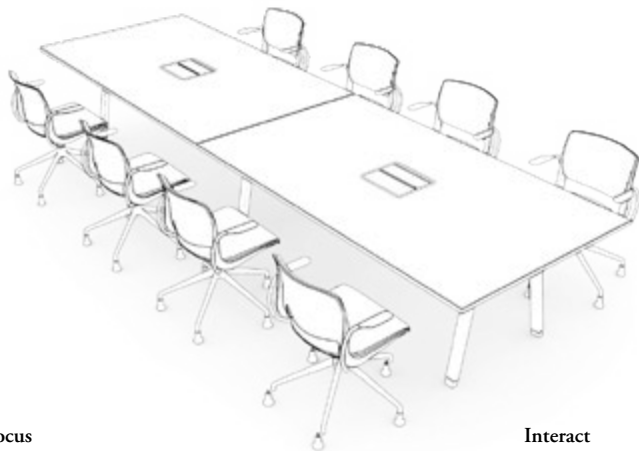

For more details on this model of chair, please refer to Work Chair section.



Focus

Interact



For more details on this model of chair, please refer to later in this section.



Variable HybrED Chairs with work surface tablets can be configured together, face-to-face and with tablets rotated to create shared workspaces. After group huddles, HybrED Chairs can later be reassembled in an open space for presentations on Mobile Screens.

Open Space



For more details on this model of chair, please refer to later in this section.



educational applications (continued)

classrooms

Focus

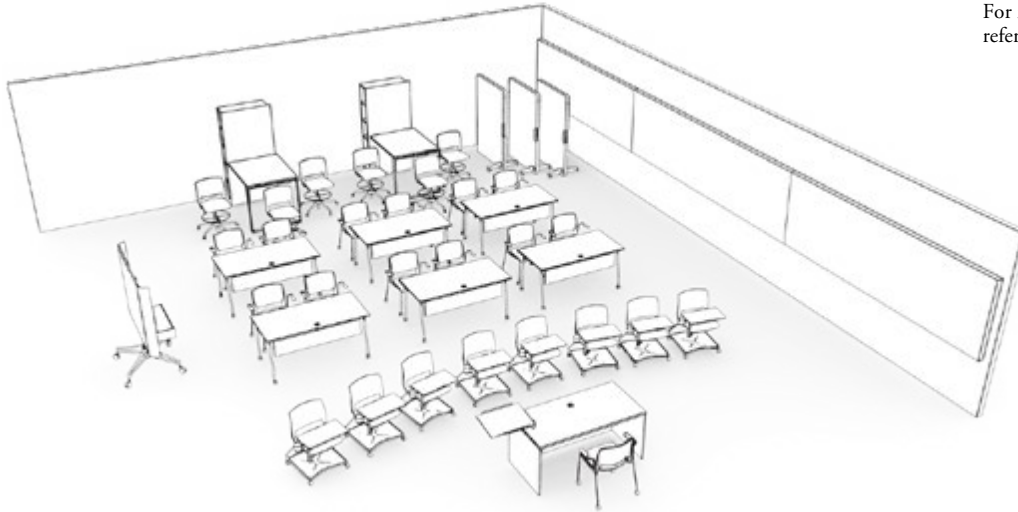

For more details on this model of chair, please refer to Work Chair section.



Classroom or training environments can be created with Thesis Training Tables Variable 4-Leg Stacking Guest Chairs, Swivel Stools and HybrEd Chairs. The caster option provide mobility for quick classroom reconfigurations depending on class size and task. Stackability allows the chairs to be stacked out of the way when not needed, or assist in quick facility maintenance. Reconfigure the furnishings and to suit Focused, Interactive and open Space needs.

Interact

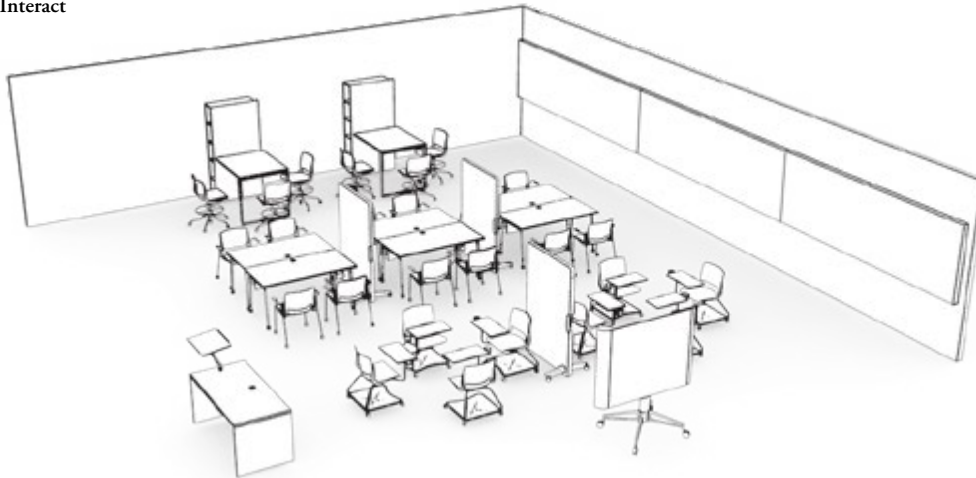

For more details on this model of chair, please refer to Stacking Chair section.



Open Space

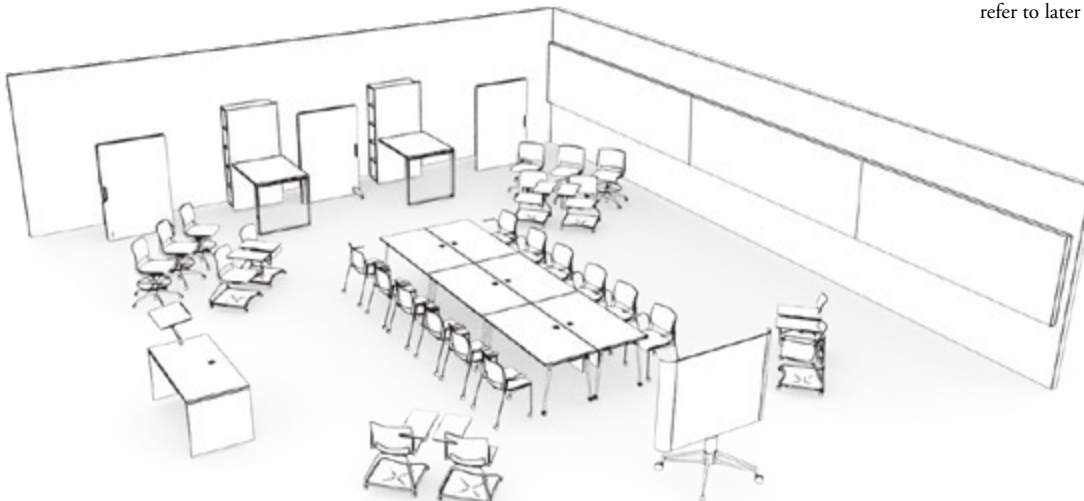

For more details on this model of chair, please refer to later in this section.



educational applications (continued)

lecture halls

Focus

For more details on this model of chair, please refer to the Stacking Chairs section.

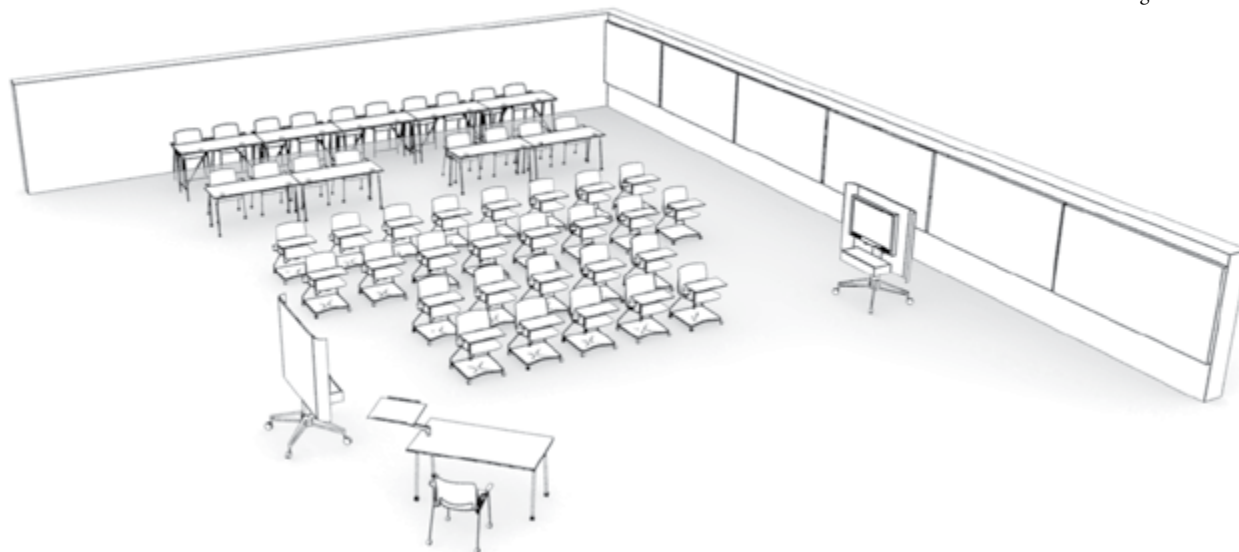

Classroom or training environments can be created with Thesis Training Tables and Variable 4-Leg Stacking Guest Chairs. Options with casters provide mobility for quick classroom reconfigurations depending on class size and task. Stackability allows the chairs not required to be stacked out of the way when not needed, or assist in quick facility maintenance.

Interact

For more details on this model of chair, please refer to Stacking Chair section.

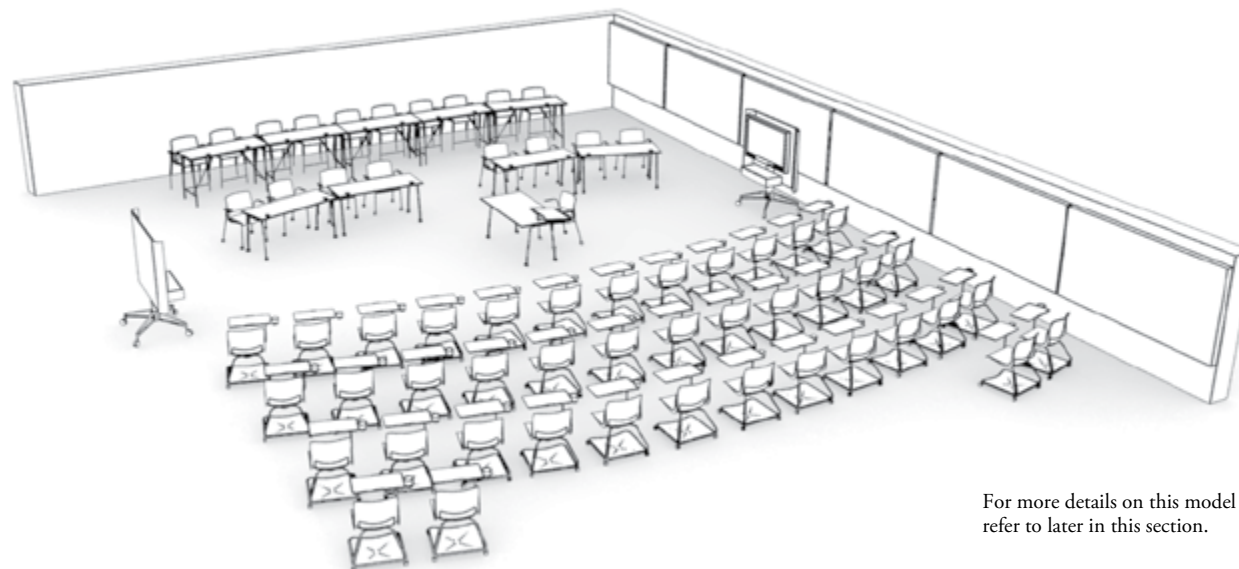

For more details on this model of chair, please refer to later in this section.



corporate, commercial & institutional applications

Today's workplace hosts fixed, motion, mobile and distance workers. They will have different needs for privacy and collaboration. Many people are not dedicated to a single workstation for all of their day.

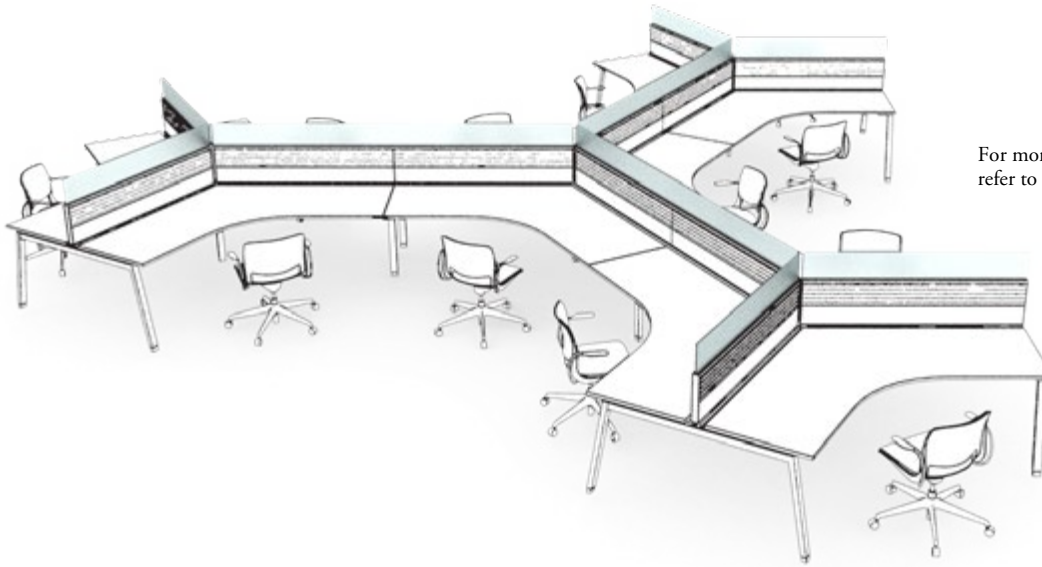

For more details on this model of chair, please refer to the Work Chairs section.



Swivel Multi-Use Work Chairs are ideal for medium term use or touch down workstations. They swivel, provide height-adjustability and the patented Variable back flex. Arm rests provide additional support.



For more details on this model of chair, please refer to the Work Chairs section.



Technology Bars provide a more casual space to do individual work or collaborate. Swivel stools provide seat height-adjustment, footrest height-adjustment and the integrated back tilt. The 4-Leg Counter or Bar height Stools are another option where use may be more short term and as a result a fixed height is preferred.

multi-use chairs

corporate, commercial & institutional applications (continued)



For more details on this model of chair, please refer to the Stacking Chairs section.



Today's conference or meeting rooms are often integrated with technology such as CLUBtalk. The Variable Conference Chairs swivel and have a fixed seat height and fixed arms for a clean meeting room solution with no need to search for adjustment controls.



For more details on this model of chair, please refer to the Stacking Chairs section.

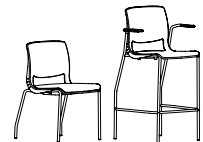

Cafeterias, cafes and bars, whether they be large or small scale, provide a space for people to relax, recharge and collaborate. Providing alternative table heights of 29", 36" counter or 42" bar height, creates a more modern landscape and the ability to separate areas. Stacking Variable 4-Leg Guest Chairs and Stools are ideal for impromptu reconfigurations as well as facility maintenance.

corporate training

Various levels of training can be achieved in corporate sett ups by rearranging existing furniture to accommodate different sizes of training sessions.

Corporate Training Rooms can be created with Thesis Training Tables, Variable 4-Leg Stacking Guest Chairs and Variable HybrED Chair with a 5 star base. Most users will be permanent residents in the office therefore the lower storage tray is not needed as most employees will keep their belongings at their desk.

Focus

For more details on this model of chair, please refer to later in this section.

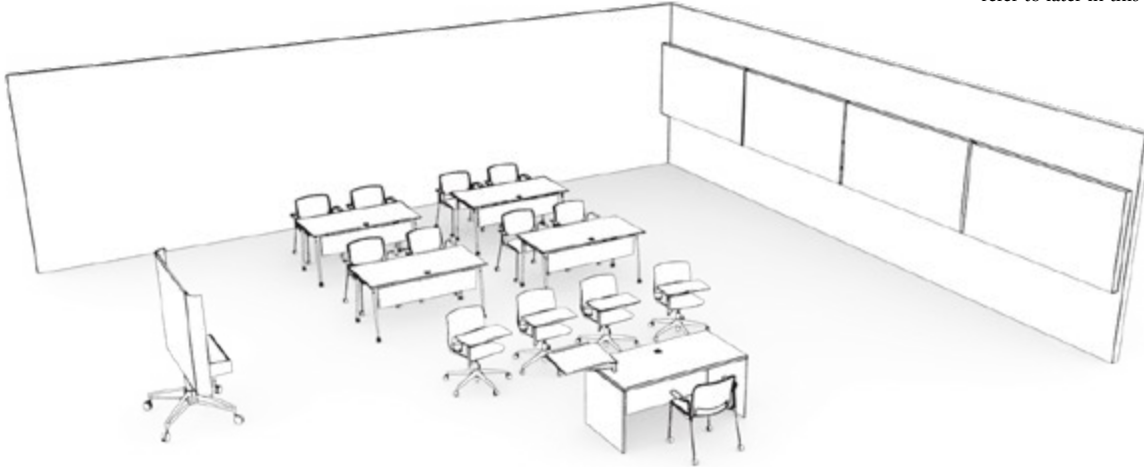

Interact

For more details on this model of chair, please refer to the Stacking Chairs section.

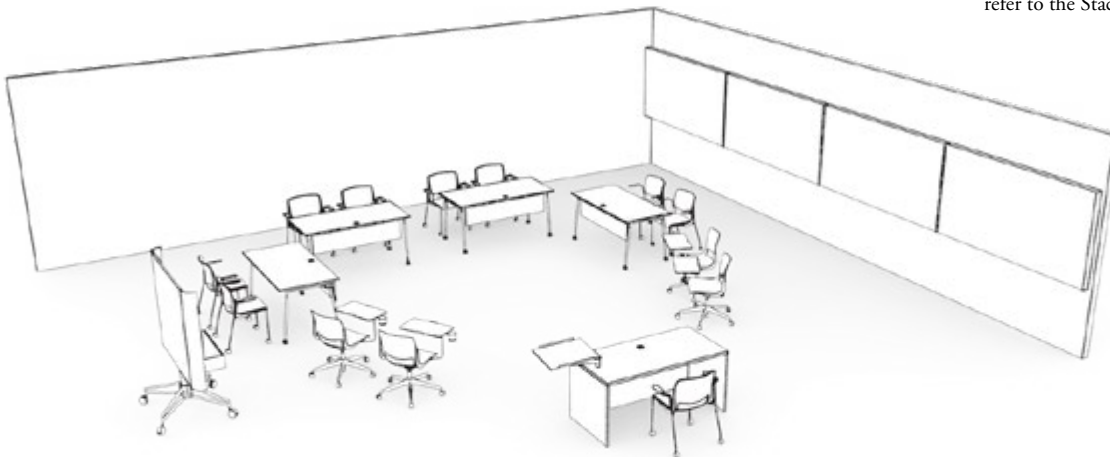

variable swivel multi-use work chair overview

The Swivel Work Multi-Use Chair is ideal where the functionality of a loaded Task Chair may be unnecessary for the application. Teknion's first all-Plastic Swivel Work Chairs are height-adjustable, have a swivel mechanism and the patented integrated back tilt. Very White shell finish is not recommended for high traffic use or minimized maintenance. See "Multi-Use Chairs" section for Variable Conference Chairs, HybrED Chairs and Application Guidelines for all Variable Chair types. See "Stacking Chairs" section for Variable Stacking Guest Chairs and Stacking Stools (Counter and Bar heights).

Variable Swivel Multi-Use Work Chair (NVRW)

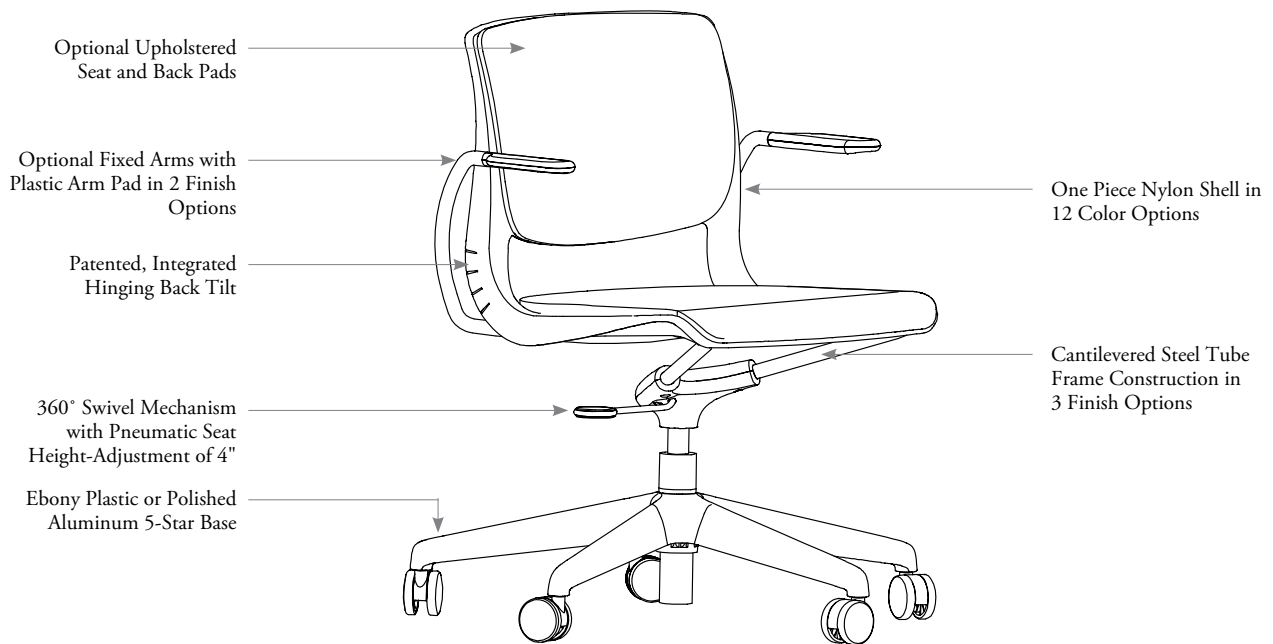

statement of line



Swivel Work Chair – No Arms with Casters (NVRWN)



Swivel Work Chair – Integrated Arms with Casters (NVRWK)



Swivel Work Chair – No Arms with Glides (NVRWNB)



Swivel Work Chair – Integrated Arms with Glides (NVRWKB)

variable swivel multi-use work chair overview (continued)

The Swivel Multi-Use Stool is perfect for counter-height users such as tellers with walk-up guests as well as for those in working in labs. It is height-adjustable, includes the patented integrated back-tilt and a footring.

Very White shell finish is not recommended for high traffic use or minimized maintenance.

See “Multi-Use Chairs” section for Variable Conference Chairs, HybrED Chairs and Application Guidelines for all Variable Chair types

See “Stacking Chairs” section for Variable Stacking Guest Chairs and Stacking Stools (Counter and Bar heights).

Variable Swivel Multi-Use Stool (NVRD)



statement of line



Swivel Stool – No Arms with Casters (NVRDN)



Swivel Stool – Integrated Arms with Casters (NVRDK)



Swivel Stool – No Arms with Glides (NVRDNB)



Swivel Stool – Integrated Arms with Glides (NVRDKB)

variable swivel multi-use work chair dimensions & material requirements

features

- Designed and tested for users up to 300 lbs
- Meets ANSI/BIFMA Requirement

weight

Swivel Work Chair without Arms	24.8 lbs
Swivel Work Chair with Arms	28.3 lbs
Optional Tablet	6 lbs

Weight includes Casters and Aluminum Base

Swivel Multi-Use Work Chair

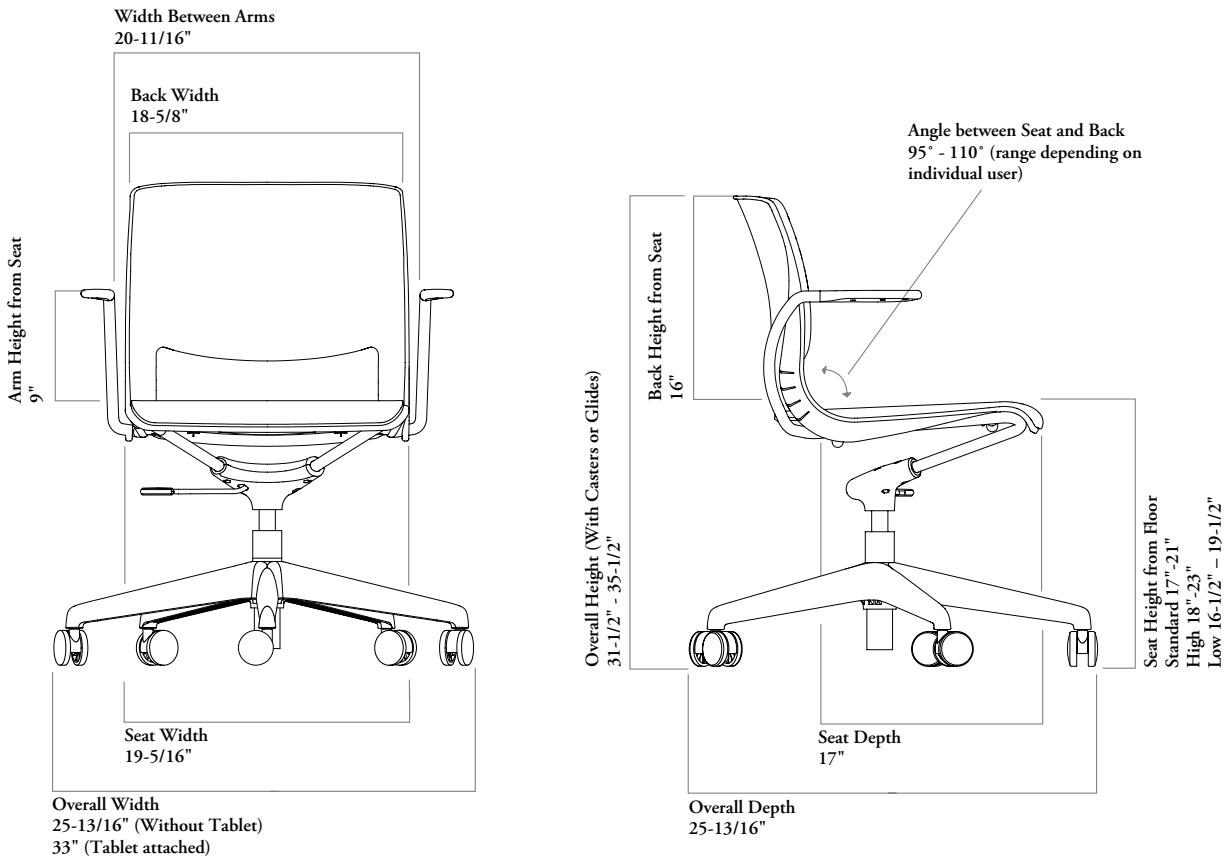

COM/COL material requirement

The pattern, repeat and directionality of fabric may increase the amount of yardage required.

Leather quantities should always be rounded up to the next hide size, as yields vary from 60-80% and are affected by the quality, size and shape of the hide, and by the location and quantity of blemishes.

BACK	SINGLE UPHOLSTERED		DUAL UPHOLSTERED		SEAT DUAL UPHOLSTERED –	
	COM [yards]	COL [sq. ft]	COM [yards]	COL [sq. ft]	COM [yards]	COL [sq. ft]
Seat only	1	8.5	n/a	n/a	n/a	n/a
Seat and Back	1	10.5	1	8.5	1	8.5

variable swivel multi-use work chair dimensions & material requirements (continued)

features

- Designed and tested for users up to 300 lbs
- Meets ANSI/BIFMA Requirement

weight

Swivel Stool without Arms	28.9 lbs
Swivel Stool with Arms	32.3 lbs

Weight includes Casters and Aluminum Base

Swivel Multi-Use Stool

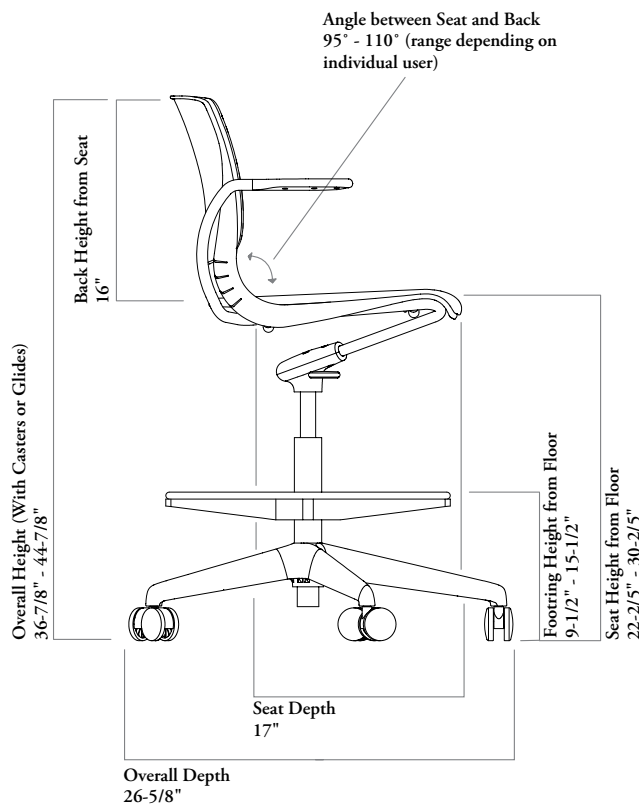
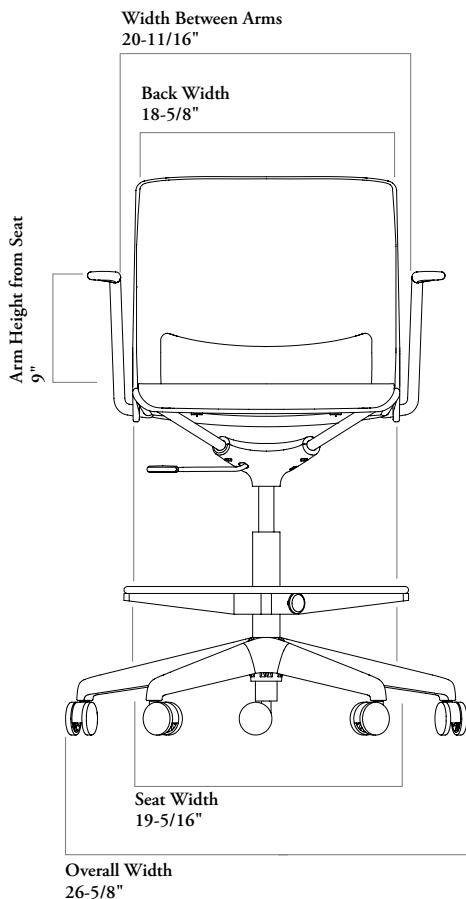

COM/COL material requirement

The pattern, repeat and directionality of fabric may increase the amount of yardage required.

Leather quantities should always be rounded up to the next hide size, as yields vary from 60-80% and are affected by the quality, size and shape of the hide, and by the location and quantity of blemishes.

BACK	SINGLE UPHOLSTERED		DUAL UPHOLSTERED		SEAT DUAL UPHOLSTERED –	
	COM [yards]	COL [sq. ft]	COM [yards]	COL [sq. ft]	COM [yards]	COL [sq. ft]
Seat only	1	8.5	n/a	n/a	n/a	n/a
Seat and Back	1	10.5	1	8.5	1	8.5

variable swivel multi-use work chair dimensions & material requirements adjustment features & instructions

tilt adjustment

Actively recline in all Variable Chairs and return to an upright position with the patented Variable integrated hinged back-tilt. Amount of flex varies dependent on user.

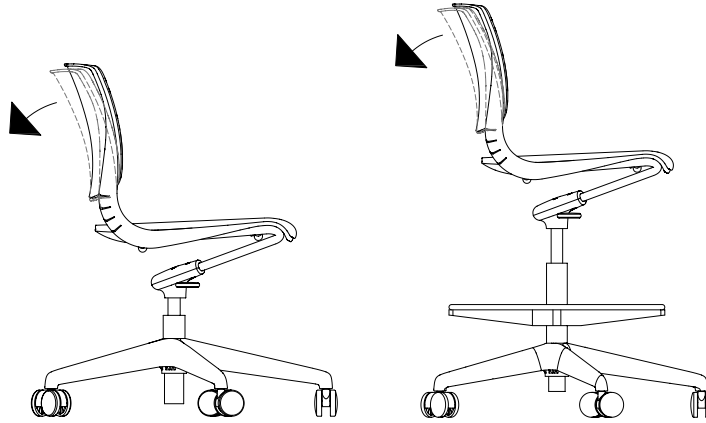

swivel mechanism

The Swivel Multi-Use Work Chair, Swivel Multi-Use Stool and Conference Chair freely swivel 360°.

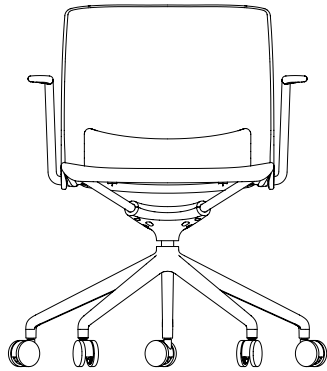

footring height-adjustment

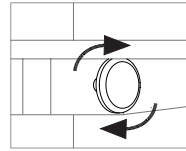

To raise or lower the footring on the Swivel Stool, turn the footring's knob counter-clockwise to release the footring and adjust the ring until you reach the desired level. Turn the knob clockwise to lock in place.

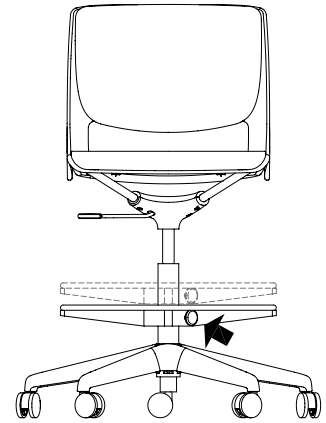

seat height-adjustment

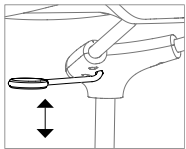

While in the seated position in the Swivel Multi-Use Chair or Stool, pull-up the paddle located below the chair on the right-hand side to lower the chair to the desired position. Depress the paddle. Transfer your weight to your feet and pull-up the paddle to raise the chair height. Depress the paddle.

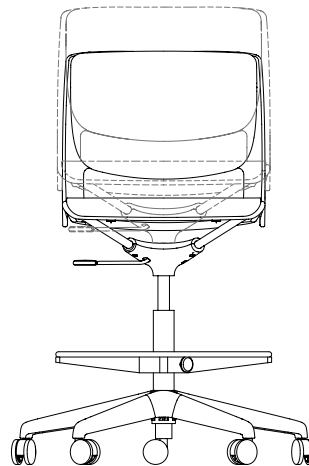
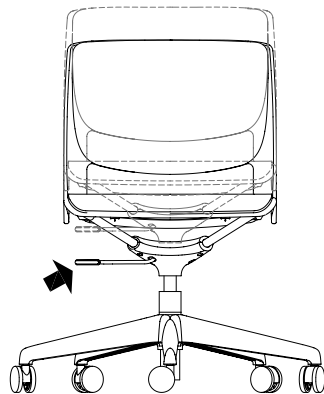

multi-use chairs

N V R W Variable Swivel Multi-Use Work Chair

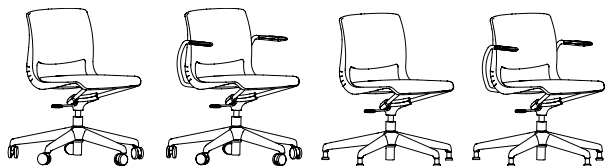

Swivel
Work Chair –
No Arms
with Casters

Swivel
Work Chair –
Integrated Arms
with Casters

Swivel
Work Chair –
No Arms
with Glides

Swivel
Work Chair –
Integrated Arms
with Glides

FEATURES

- Pneumatic cylinder provides height-adjustment of 4"
- Swivel seat rotates 360°
- Includes the patented Variable integrated back-tilt
- Ebony (Plastic) Base option or Polished Aluminum Base
- Optional Frame finishes are Ebony (Paint), Platinum (Paint) or Chrome
- Options for Hard and Soft Casters in Ebony or Silver and Ebony finish, or Hard and Soft Glides
- Mechanism finished in Polished Aluminum
- Optional fixed arms with plastic arm pad

NOTES

Upholstery options available include: Not Upholstered, Single Upholstered Seat only, Single Upholstered Seat and Back, or Dual Upholstered Seat and Back.

Arm frame finish matches chair frame finish. Plastic arm pads have optional Ebony or Platinum Grey finish.

Tablet may be applied to No Arm styles and can be retrofit on site.

Leather LD is not available on Variable.

PRODUCT OPTIONS

Arm Style	Upholstery Style	Back Upholstery (For Dual)	Cylinder Style	Frame Finish	Plastic Shell Finish	Plastic Arm Finish	Base Finish	Casters/ Glides	Assembly Style
N No Arms K Integrated Arms	N Not Upholstered	Fabric	1 Standard 2 High 3 Low	E Ebony	6A Deep Verde 6C Blue 6E Dark Grey 6G Medium Taupe 6H Medium Grey 6J Orange 7F Ebony 7H Light Grey 8C Very White	7F Ebony YN Platinum Grey	52 Ebony (Satin) C9 Polished Aluminum	A Casters, Soft B Glides, Hard C Glides, Soft	F Fully Assembled N Not Fully Assembled
	P Single Upholstered Seat Only	Leather LA Leather LB Leather LC		C Chrome					
	S Single Upholstered Seat and Back	Seat Upholstery Finish							
	D Dual Upholstered Seat and Back			Fabric Leather LA Leather LB Leather LC					

SAMPLE ORDER CODE

NVRW K	P	E523	2	C	7F	7F	52	A	1	F
---------------	----------	-------------	----------	----------	-----------	-----------	-----------	----------	----------	----------

DESCRIPTION

No Arms, Not Upholstered
Integrated Arms, Not Upholstered

PRICE

	Ebony Frame	Platinum Frame	Chrome Frame
No Arms, Not Upholstered	738	719	738
Integrated Arms, Not Upholstered	827	827	842

Pricing and options are continued on the following pages.

N V R W
Variable Swivel
Multi-Use Work Chair (Continued)

DESCRIPTION	PRICE									
	Grade 1	COM/ Grade 2	COL/ Grade 3	Grade 4	Grade 5	Grade 6	Grade 7	Grade 8	Grade 9	Grade 10
No Arms, Upholstered Seat Only	894	912	926	937	947	959	969	979	991	1002
Integrated Arms, Upholstered Seat Only	1000	1017	1032	1041	1053	1063	1072	1085	1094	1109
No Arms, Upholstered Seat and Back	1071	1099	1129	1148	1169	1187	1209	1226	1246	1268
Integrated Arms, Upholstered Seat and Back	1176	1205	1235	1254	1273	1292	1314	1329	1351	1373
	Leather LA	Leather LB	Leather LC							
No Arms, Upholstered Seat Only	947	951	966							
Integrated Arms, Upholstered Seat Only	1053	1058	1070							
No Arms, Upholstered Seat and Back	1172	1180	1209							
Integrated Arms, Upholstered Seat and Back	1275	1286	1314							
If Dual Upholstered (D) is specified	add	256								
If Polished Aluminum Base (C9) is specified	add	82								
If Hard Casters are specified with Silver and Ebony	add	31								
If Soft Casters are specified with Ebony	add	28								
If Soft Casters are specified with Silver and Ebony	add	72								
If Hard Glides (B) are specified	add	28								
If Soft Glides (C) are specified	add	46								
If Chrome Frame (C) is specified	add	17								

multi-use chairs

NVRD Variable Swivel Multi-Use Stool

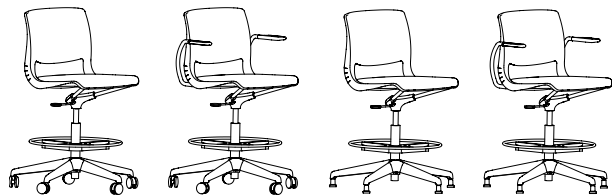

Swivel Stool –
No Arms
with Casters

Swivel Stool –
Integrated Arms
with Casters

Swivel Stool –
No Arms
with Glides

Swivel Stool –
Integrated Arms
with Glides

FEATURES

- Pneumatic cylinder provides height-adjustment of 8"
- Swivel seat rotates 360°
- Includes footring with 6" height-adjustment
- Includes the patented Variable integrated back-tilt
- Ebony (Plastic) base option or Polished Aluminum Base
- Optional Frame finishes are Ebony (Paint), Platinum (Paint) or Chrome
- Options for Hard and Soft Casters in Ebony or Silver and Ebony finish, or Hard and Soft Glides
- Mechanism finished in Polished Aluminum
- Optional fixed arms with plastic arm pad

NOTES

Upholstery options available include: Not Upholstered, Single Upholstered Seat only, Single Upholstered Seat and Back, or Dual Upholstered Seat and Back.

Arm frame finish matches chair frame finish. Plastic arm pads have optional Ebony or Platinum Grey finish.

Tablet may be applied to No Arm styles and can be retrofit on site.

Leather LD is not available on Variable.

PRODUCT OPTIONS

Arm Style	Upholstery Style	Back Upholstery (For Dual)	Frame Finish	Plastic Shell Finish	Plastic Arm Finish	Base Finish	Casters/ Glides	Assembly Style
N No Arms K Integrated Arms	N Not Upholstered	Fabric	E Ebony	6A Deep Verde	7F Ebony	52 Ebony	Casters, Hard	F Fully Assembled
	P Single Upholstered Seat Only	Leather LA Leather LB Leather LC	7 Platinum (Satin) C Chrome	6C Blue 6E Dark Grey 6G Medium Taupe 6H Medium Grey 6J Orange	YN Platinum Grey	C9 Polished Aluminum	A Casters, Soft B Glides, Hard C Glides, Soft	N Not Fully Assembled
	S Single Upholstered Seat and Back	Seat Upholstery Finish		7F Ebony 7H Light Grey 8C Very White			Optional Caster Finish 1 Ebony 2 Silver and Ebony	
	D Dual Upholstered Seat and Back		Fabric Leather LA Leather LB Leather LC					

SAMPLE ORDER CODE

NVRD K	P	E523	C	7F	7F	52	A	1	
--------	---	------	---	----	----	----	---	---	--

See pricing on the following page.

NVRD
Variable Swivel Multi-Use Stool
(Continued)

DESCRIPTION	PRICE									
	Ebony Frame	Platinum Frame	Chrome Frame							
No Arms, Not Upholstered	829	829	844							
Integrated Arms, Not Upholstered	935	935	948							
	Grade 1	Grade 2	Grade 3	Grade 4	Grade 5	Grade 6	Grade 7	Grade 8	Grade 9	Grade 10
No Arms, Upholstered Seat Only	1003	1020	1035	1043	1057	1065	1076	1087	1096	1111
Integrated Arms, Upholstered Seat Only	1110	1123	1140	1148	1160	1170	1181	1190	1202	1215
No Arms, Upholstered Seat and Back	1180	1209	1238	1257	1275	1295	1317	1333	1354	1376
Integrated Arms, Upholstered Seat and Back	1286	1314	1343	1362	1380	1400	1420	1440	1460	1479
	Leather LA	Leather LB	Leather LC							
No Arms, Upholstered Seat Only	1057	1060	1072							
Integrated Arms, Upholstered Seat Only	1160	1166	1177							
No Arms, Upholstered Seat and Back	1277	1289	1317							
Integrated Arms, Upholstered Seat and Back	1384	1392	1420							
If Dual Upholstered (D) is specified	add	256								
If Polished Aluminum Base (C9) is specified	add	82								
If Hard Casters are specified with Silver and Ebony	add	31								
If Soft Casters are specified with Ebony	add	28								
If Soft Casters are specified with Silver and Ebony	add	72								
If Hard Glides (B) are specified	add	28								
If Soft Glides (C) are specified	add	46								
If Chrome Frame (C) is specified	add	17								

variable conference chair overview

The Conference Chair provides a contemporary seating option for meeting, seminar and conference spaces. Fixed arms, swivel fixed-height mechanism and the backs integrated passive tilt deliver a clean, uncluttered and comfortable chair in any meeting environment.

Variable Chairs have been designed and tested for users up to 300 lbs.

Very White shell finish is not recommended for high traffic use or minimized maintenance.

See “Work-Use Chairs” section for Variable Swivel Multi-Use Work Chairs and Stools.

See “Stacking Chairs” section for Variable Stacking Guest Chairs and Stacking Stools (Counter and Bar heights).

Variable Conference Chair (NVRC) (shown)

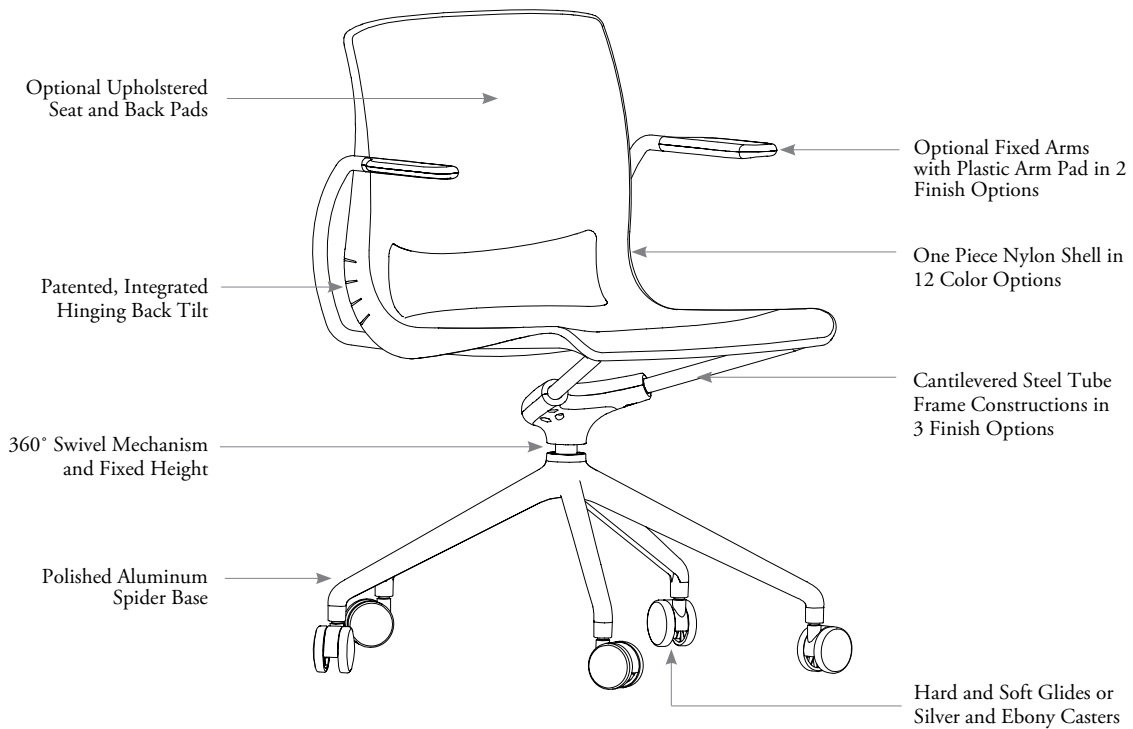

statement of line



Conference Chair –
No Arms
with Casters
(NVRCN)



Conference Chair –
Integrated Arms
with Casters
(NVRCK)



Conference Chair –
No Arms
with Glides
(NVRGN)



Conference Chair –
Integrated Arms
with Glides
(NVRCK)

variable conference chair overview (continued)

The Variable HybrED Chair is a mobile, compact, self-contained individual desk and chair suitable for educational, corporate and residential environments. The version with the Storage Tray Base maximizes storage below the seat and provides unobstructed access.

Variable Chairs have been designed and tested for users up to 300 lbs. The maximum load on the Storage Tray base is 60 lbs. The Worksurface Tablet complies with ANSI BIFMA x 6.1-2012 Educational Seating and has a maximum load capacity of 15 lbs when the seat is unoccupied.

Very White shell finish is not recommended for high traffic use or minimized maintenance.

See “Work Chairs” section for Variable Work Chairs and Swivel Stools.

See “Stacking Chairs” section for Variable Stacking Guest Chairs and Stacking Stools (Counter and Bar heights).

Variable HybrED Chair with Storage Tray Base (NVRE) (shown)

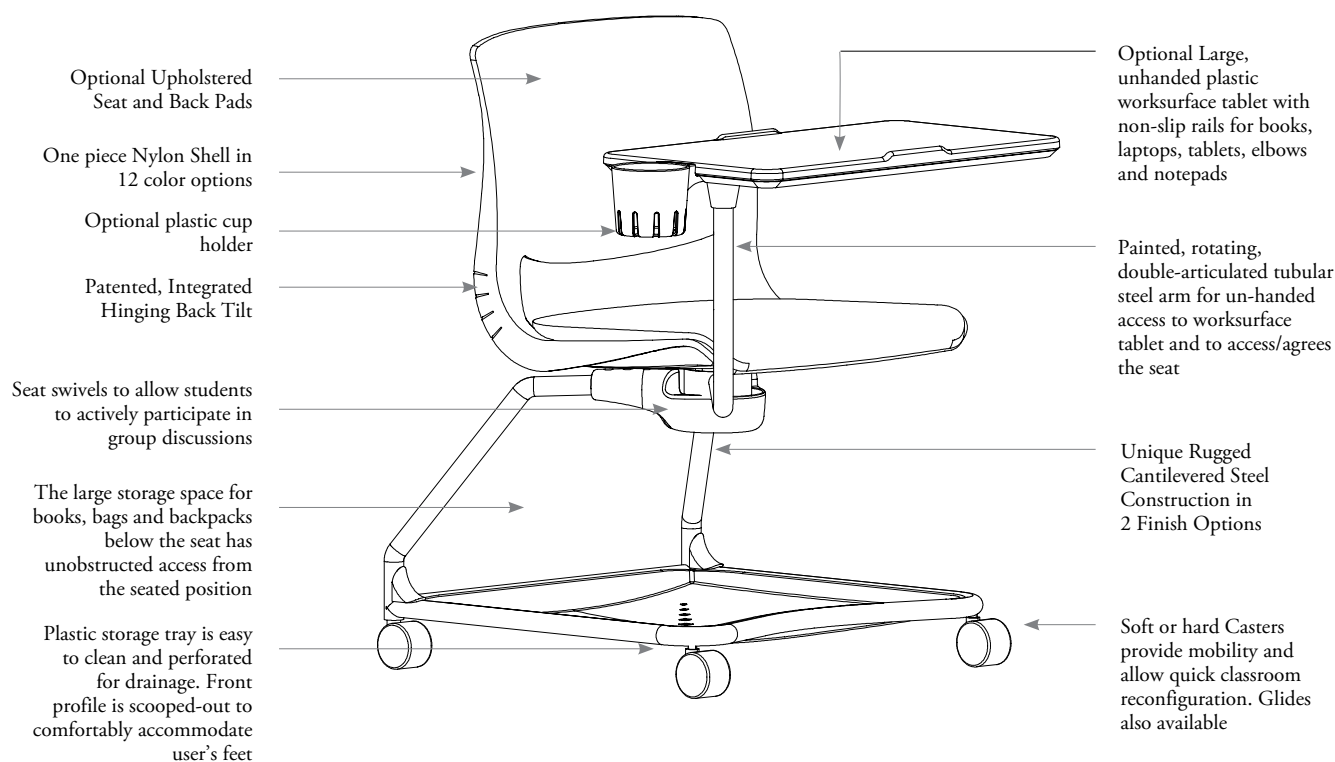

statement of line

Variable HybrED Chair with Storage Tray Base



No Worksurface Tablet (NVREN)

With Worksurface Tablet (NVREU)

With Worksurface Tablet and Cup Holder (NVREUY)

variable conference chair overview (continued)

The Variable HybrED Chair with Height-Adjustment and 5-Star Base is ideal for training and seminar scenarios where users don't require additional storage below the seat and desire seat height-adjustment.

The Worksurface Tablet complies with ANSI BIFMA x 6.1-2012 Educational Seating and has a maximum load capacity of 15 lbs when the seat is unoccupied.

Very White shell finish is not recommended for high traffic use or minimized maintenance.

See "Work" section for Variable Work Chairs and Swivel Stools.

See "Stacking Chairs" section for Variable Stacking Guest Chairs and Stacking Stools (Counter and Bar heights).

Variable HybrED Height-Adjustable Chair

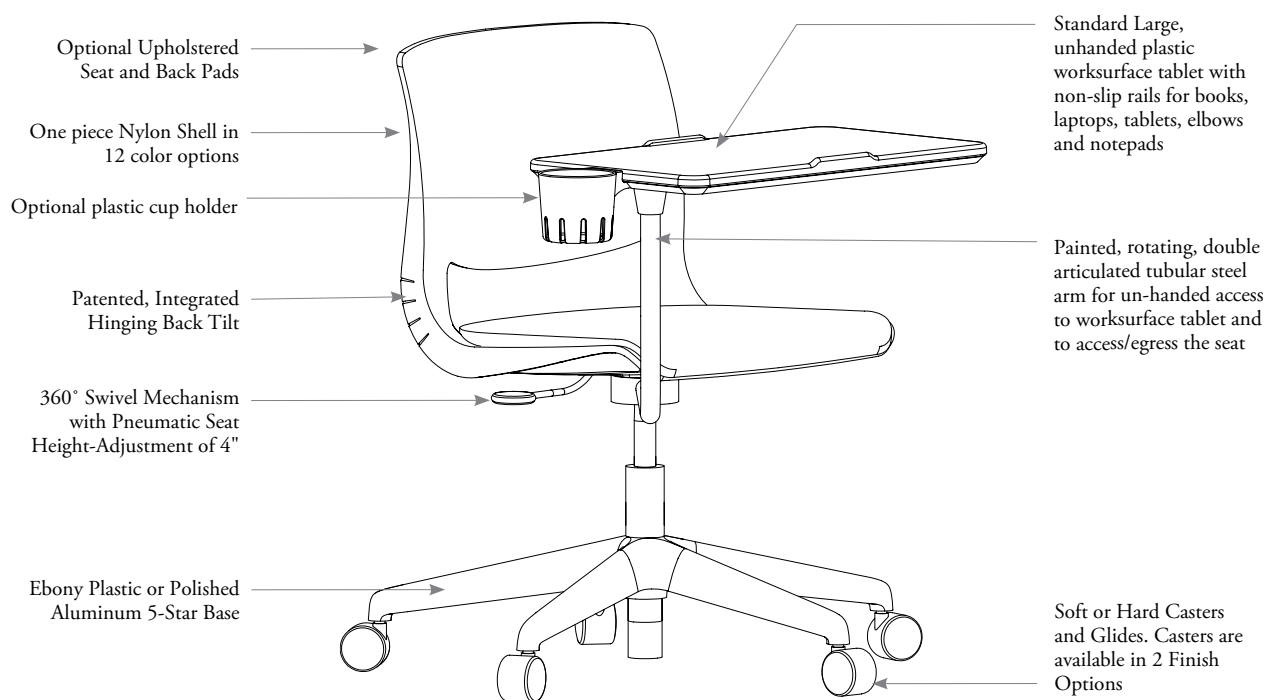

statement of line

Variable HybrED Chair with Height-Adjustment



With Worksurface Tablet
(NVRH)

With Worksurface Tablet
and Cup holder
(NVRHY)

variable conference chair dimensions & material requirements

features

- Designed and tested for users up to 300 lbs

weight

Conference Chair with Arms	26.8 lbs
Conference Chair without Arms	23.4 lbs

Conference Chair

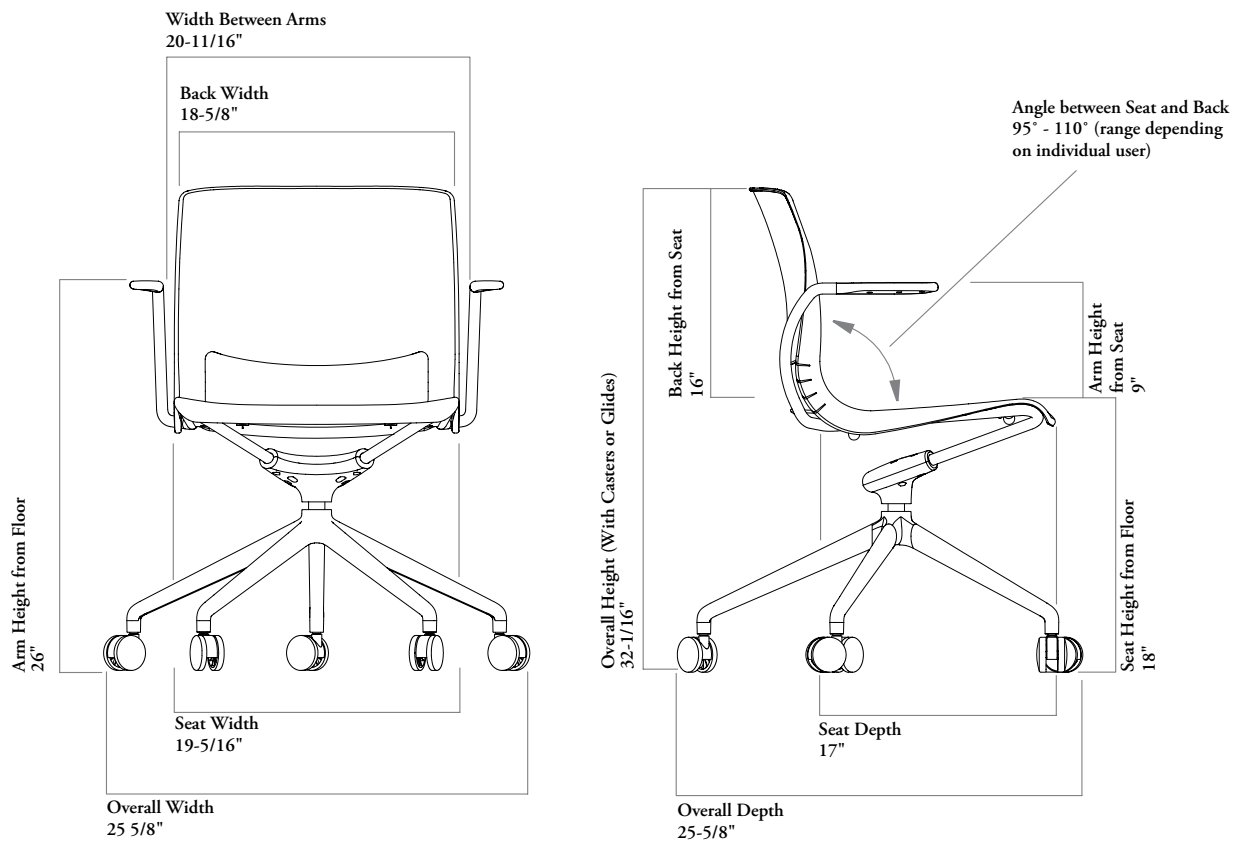

COM/COL material requirement

The pattern, repeat and directionality of fabric may increase the amount of yardage required.

Leather quantities should always be rounded up to the next hide size, as yields vary from 60-80% and are affected by the quality, size and shape of the hide, and by the location and quantity of blemishes.

BACK	SINGLE UPHOLSTERED		DUAL UPHOLSTERED		SEAT DUAL UPHOLSTERED –	
	COM [yards]	COL [sq. ft]	COM [yards]	COL [sq. ft]	COM [yards]	COL [sq. ft]
Seat only	1	8.5	n/a	n/a	n/a	n/a
Seat and Back	1	10.5	1	8.5	1	8.5

multi-use chairs

variable hybrid dimensions & material requirements (continued)

features

- Designed and tested for users up to 300 lbs

weight

HybrED Chair with Tray Base and worksurface	35 lbs
HybrED Chair with Tray Base no worksurface	26 lbs

HybrED Chair with Storage Tray Base (NVRE)

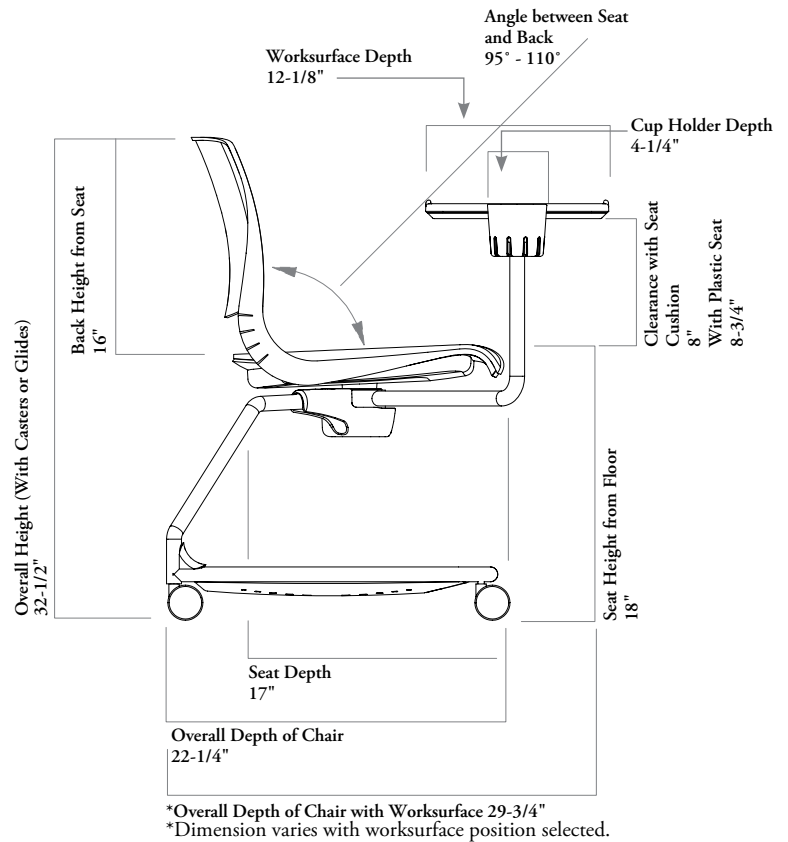
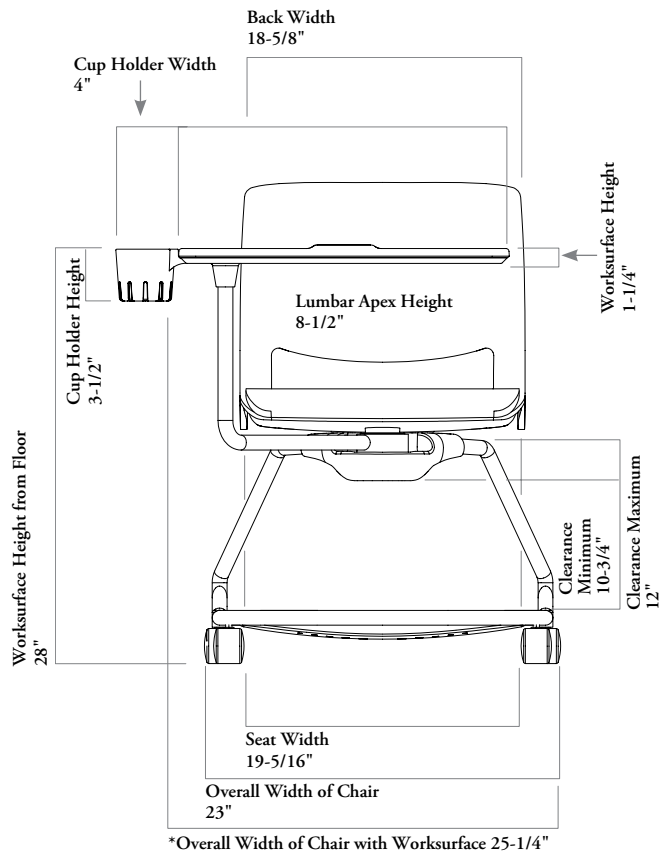

COM/COL material requirement

The pattern, repeat and directionality of fabric may increase the amount of yardage required.

Leather quantities should always be rounded up to the next hide size, as yields vary from 60-80% and are affected by the quality, size and shape of the hide, and by the location and quantity of blemishes.

BACK	SINGLE UPHOLSTERED		DUAL UPHOLSTERED		SEAT DUAL UPHOLSTERED -	
	COM [yards]	COL [sq. ft]	COM [yards]	COL [sq. ft]	COM [yards]	COL [sq. ft]
Seat only	1	8.5	n/a	n/a	n/a	n/a
Seat and Back	1	10.5	1	8.5	1	8.5

variable hybrid dimensions & material requirements (continued)

features

- Designed and tested for users up to 300 lbs

weight

5-Star Base and Worksurface	27 lbs
-----------------------------	--------

HybrED Chair Height-Adjustable with 5-Star Base

There are two pivot points on the HybrED Tablet that allows the user to work independently, with a group or move it out of the way when is not needed.

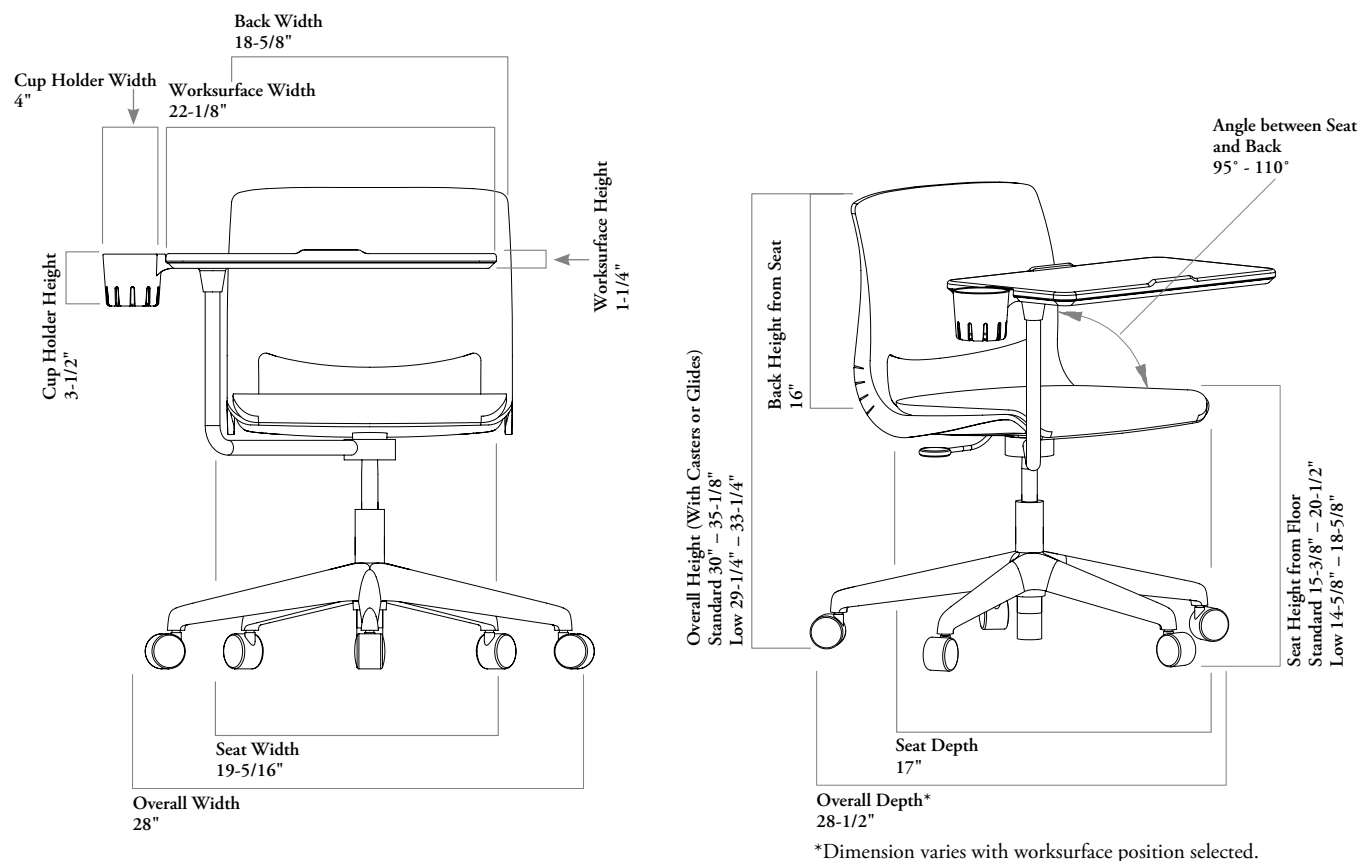

COM/COL material requirement

The pattern, repeat and directionality of fabric may increase the amount of yardage required.

Leather quantities should always be rounded up to the next hide size, as yields vary from 60-80% and are affected by the quality, size and shape of the hide, and by the location and quantity of blemishes.

BACK	SINGLE UPHOLSTERED		DUAL UPHOLSTERED		SEAT DUAL UPHOLSTERED -	
	COM [yards]	COL [sq. ft]	COM [yards]	COL [sq. ft]	COM [yards]	COL [sq. ft]
Seat only	1	8.5	n/a	n/a	n/a	n/a
Seat and Back	1	10.5	1	8.5	1	8.5

variable hybrid chair adjustment features & instructions

hybrid chair worksurface tablet

The pivoting worksurface tablet allows right and left handed use and access/egress from the seat. The worksurface is generously proportioned so you can rest your elbows on it, read, write or use your laptop or tablet. There are two pivot-points for the worksurface. Rotation through both pivot point allows you to create multiple worksurface positions and varied seat depths to suit smaller and larger users.

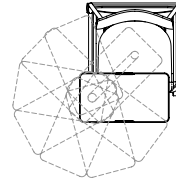
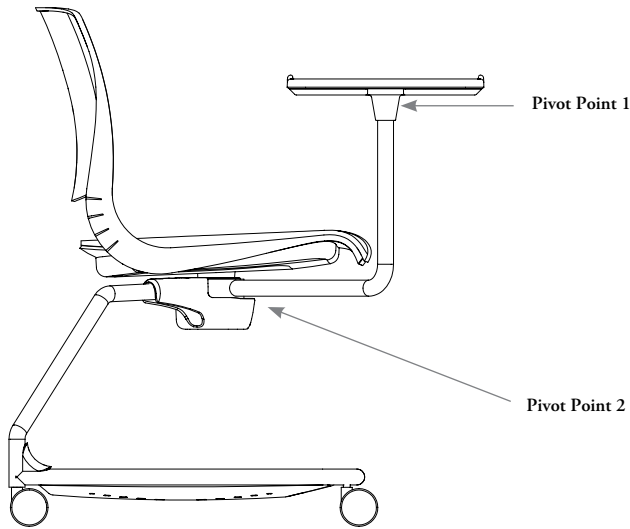

Pivot Point 1 is under the tablet and allows 360 degrees of rotation, limited only by its location.

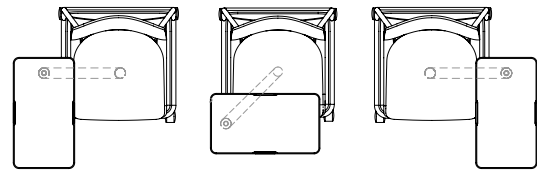

Pivot Point 2 is centered under the chair and allows 180 degrees of rotation.

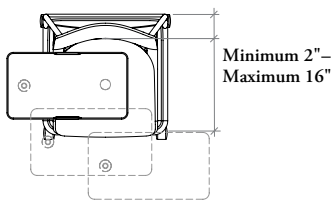

Rotate both points to locate the tablet in front to minimum and maximum depths suitable for the users

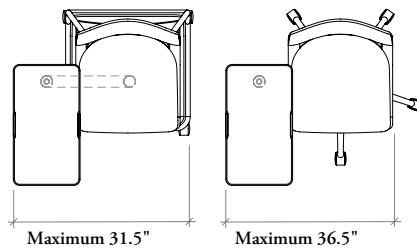

Consider all maximum clearances when the tablets are placed in the side position, perpendicular to the seat on the model with Storage Tray Base or the 5-Star Base.

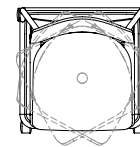

Seat swivels at Pivot Point 2 to allow students to actively participate in group discussions

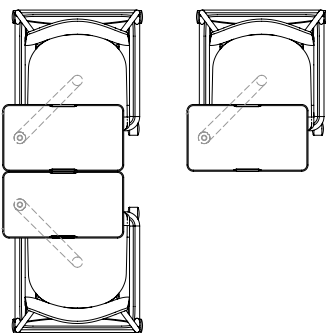

Position worksurface tablet in front for individual or face-to-face use in groups

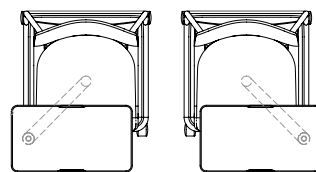

Position worksurface tablet in a right or left handed position

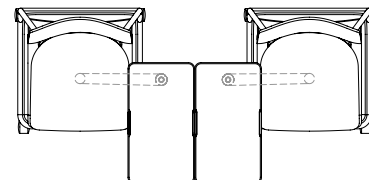

Position worksurface tablet on the side of the chair to create groupings in pairs

multi-use chairs

N V R C

Variable Conference Chair

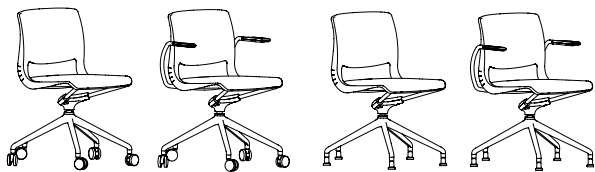

Conference Chair – No Arms with Casters

Conference Chair – Integrated Arms with Casters

Conference Chair – No Arms with Glides

Conference Chair – Integrated Arms with Glides

FEATURES

- Swivel seat rotates 360°
- Includes the patented Variable integrated back-tilt
- Fixed height mechanism with Polished Aluminum finish
- Standard Polished Aluminum Spider Base
- Optional frame finishes are Ebony (paint), Platinum (paint) or Chrome
- Options for Hard and Soft Casters or Hard and Soft Glides
- Casters are finished in Silver and Ebony
- Optional fixed arms with Plastic arm pad

NOTES

Upholstery options available include: Not Upholstered, Single Upholstered Seat only, Single Upholstered Seat and Back, or Dual Upholstered Seat and Back.

Arm frame finish matches chair frame finish. Plastic arm pads have optional Ebony or Platinum Grey finish.

Tablet must be field installed.

Leather LD is not available on Variable.

PRODUCT OPTIONS

Frame Style	Arm Style	Upholstery Style	Back Upholstery (For Dual)	Frame Finish	Plastic Shell Finish	Plastic Arm Finish	Tablet Option	Tablet Surface Finish
G Spider Base with Casters, Hard	N No Arms	N Not Upholstered	Fabric	E Ebony	6A Deep Verde	7F Ebony	N No Tablet	Compact laminate
A Spider Base with Casters, Soft	K Integrated Arms	P Single Upholstered Seat Only	Leather LA	7 Platinum (Satin)	6C Blue	YN Platinum Grey	R Tablet (Right Handed)	
B Spider Base with Glides, Hard		S Single Upholstered Seat and Back	Leather LB	C Chrome	6E Dark Grey		L Tablet (Left Handed)	
C Spider Base with Glides, Soft		D Dual Upholstered Seat and Back	Leather LC		6G Medium Taupe			
			Seat Upholstery Finish		6H Medium Grey			
			Fabric		6J Orange			
			Leather LA		7F Ebony			
			Leather LB		7H Light Grey			
			Leather LC		8C Very White			

SAMPLE ORDER CODE

NVRC C	K	P	E523	E	7F	7F	N	
---------------	----------	----------	-------------	----------	-----------	-----------	----------	--

DESCRIPTION

PRICE

	Ebony Frame	Platinum Frame	Chrome Frame
SPIDER BASE WITH CASTERS, HARD (G)			
No Arms, Not Upholstered	963	963	977
Integrated Arms, Not Upholstered	1065	1065	1082
SPIDER BASE WITH CASTERS, SOFT (A)			
No Arms, Not Upholstered	988	988	1002
Integrated Arms, Not Upholstered	1094	1094	1111
SPIDER BASE WITH GLIDES, HARD (B)			
No Arms, Not Upholstered	988	988	1002
Integrated Arms, Not Upholstered	1094	1094	1111
SPIDER BASE WITH GLIDES, SOFT (C)			
No Arms, Not Upholstered	1007	1007	1022
Integrated Arms, Not Upholstered	1111	1111	1124

Pricing and options is continued on the following pages.

N V R C
Variable Conference Chair
(Continued)

DESCRIPTION

PRICE

SPIDER BASE WITH CASTERS, HARD (G)

	Grade 1	COM/ Grade 2	COL/ Grade 3	Grade 4	Grade 5	Grade 6	Grade 7	Grade 8	Grade 9	Grade 10
No Arms – Upholstered Seat Only	1138	1151	1168	1176	1188	1198	1210	1218	1231	1242
Integrated Arms – Upholstered Seat Only	1240	1256	1270	1278	1292	1300	1314	1322	1333	1347
No Arms – Upholstered Seat and Back	1314	1342	1371	1390	1409	1426	1448	1467	1489	1507
Integrated Arms – Upholstered Seat and Back	1416	1444	1473	1494	1513	1530	1552	1569	1592	1612

	Leather LA	Leather LB	Leather LC
No Arms – Upholstered Seat Only	1188	1194	1206
Integrated Arms – Upholstered Seat Only	1292	1296	1312
No Arms – Upholstered Seat and Back	1413	1420	1448
Integrated Arms – Upholstered Seat and Back	1515	1524	1552

SPIDER BASE WITH CASTERS, SOFT (A)

	Grade 1	COM/ Grade 2	COL/ Grade 3	Grade 4	Grade 5	Grade 6	Grade 7	Grade 8	Grade 9	Grade 10
No Arms – Upholstered Seat Only	1161	1176	1194	1202	1213	1224	1235	1244	1256	1268
Integrated Arms – Upholstered Seat Only	1269	1286	1299	1312	1321	1329	1343	1351	1363	1376
No Arms – Upholstered Seat and Back	1337	1365	1394	1415	1435	1451	1473	1493	1513	1532
Integrated Arms – Upholstered Seat and Back	1445	1473	1502	1523	1542	1560	1581	1598	1621	1643

	Leather LA	Leather LB	Leather LC
No Arms – Upholstered Seat Only	1213	1217	1232
Integrated Arms – Upholstered Seat Only	1321	1325	1339
No Arms – Upholstered Seat and Back	1438	1445	1473
Integrated Arms – Upholstered Seat and Back	1544	1553	1581

SPIDER BASE WITH GLIDES, HARD (B)

	Grade 1	COM/ Grade 2	COL/ Grade 3	Grade 4	Grade 5	Grade 6	Grade 7	Grade 8	Grade 9	Grade 10
No Arms – Upholstered Seat Only	1161	1176	1194	1202	1213	1224	1235	1244	1256	1268
Integrated Arms – Upholstered Seat Only	1269	1286	1299	1312	1321	1329	1343	1351	1363	1376
No Arms – Upholstered Seat and Back	1337	1365	1394	1415	1435	1451	1473	1493	1513	1532
Integrated Arms – Upholstered Seat and Back	1445	1473	1502	1523	1542	1560	1581	1598	1621	1643

	Leather LA	Leather LB	Leather LC
No Arms – Upholstered Seat Only	1213	1217	1232
Integrated Arms – Upholstered Seat Only	1321	1325	1339
No Arms – Upholstered Seat and Back	1438	1445	1473
Integrated Arms – Upholstered Seat and Back	1544	1553	1581

SPIDER BASE WITH GLIDES, SOFT (C)

	Grade 1	COM/ Grade 2	COL/ Grade 3	Grade 4	Grade 5	Grade 6	Grade 7	Grade 8	Grade 9	Grade 10
No Arms – Upholstered Seat Only	1181	1197	1212	1220	1234	1242	1254	1264	1274	1289
Integrated Arms – Upholstered Seat Only	1286	1299	1317	1325	1336	1347	1357	1366	1378	1391
No Arms – Upholstered Seat and Back	1357	1386	1415	1435	1452	1472	1494	1510	1531	1553
Integrated Arms – Upholstered Seat and Back	1462	1491	1520	1538	1557	1576	1596	1616	1637	1655

	Leather LA	Leather LB	Leather LC
No Arms – Upholstered Seat Only	1234	1238	1249
Integrated Arms – Upholstered Seat Only	1336	1342	1354
No Arms – Upholstered Seat and Back	1455	1466	1494
Integrated Arms – Upholstered Seat and Back	1560	1568	1596

If Dual Upholstered (D) is specified add 256
 If Chrome Frame (C) is specified add 17
 If Tablet Arm (R) or (L) is specified add 278

multi-use chairs

N V R E Variable HybrED Chair with Storage Tray Base



No Worksurface
Tablet

With
Worksurface
Tablet

With Worksurface
Tablet and Cup
Holder

FEATURES

- Unique, rugged cantilevered frame maximizes storage while providing unobstructed access
- Optional Worksurface Tablet is unhandled and has 360° double-articulated rotation in arm
- Swivel seat rotates for active student participation
- Includes the patented Variable integrated back-tilt
- Optional Frame, Tablet Surface, and Plastic Storage tray in coordinating finishes Ebony and Platinum
- Options for Hard and Soft Casters in Ebony or Silver and Ebony finish, or Hard and Soft Glides
- Mechanism and seat pan finished in Polished Aluminum
- Optional plastic Cup Holder

NOTES

Upholstery options available include: Not Upholstered, Single Upholstered Seat only, or Single Upholstered Seat and Back.

Articulating Arm frame finish matches chair frame finish. Cup Holder finish matches Tablet Surface Finish.

Ships sub-assembled in 3-pieces for easy on-site assembly without tools.

Leather LD is not available on Variable.

PRODUCT OPTIONS

Worksurface Tablet	Cup Holder	Upholstery Style	Upholstery Seat	Tablet Surface Finish (Plastic)	Frame Finish	Plastic Shell Finish	Plastic Storage Tray	Caster /Glide	Caster Finish
N No Worksurface	N No Cup Holder	N Not Upholstered	Fabric	7F Ebony	E Ebony	6A Deep Verde	7F Ebony	Hard Casters	1 Ebony
U Unhanded Worksurface Tablet	Y With Cup Holder	P Single Upholstered Seat Only	Leather LA	YN Platinum Grey	7 Platinum (Satin)	6C Blue	YN Platinum Grey	A Soft Casters	2 Silver and Ebony
		S Single Upholstered Seat and Back	Leather LB			6E Dark Grey		B Hard Glides	
			Leather LC			6G Medium Taupe		C Soft Glides	
						6H Medium Grey			
						6J Orange			
						7F Ebony			
						7H Light Grey			
						8C Very White			

SAMPLE ORDER CODE

NVRE U	Y	N	-	YN	7	6F	YN	A	1
---------------	----------	----------	----------	-----------	----------	-----------	-----------	----------	----------

DESCRIPTION

PRICE

	Hard Caster, Ebony	Hard Caster, Silver and Ebony	Soft Casters, Ebony	Soft Casters, Silver and Ebony	Hard Glides	Soft Glides
No Worksurface, No Cup Holder, Not Upholstered	841	872	867	913	867	885
Unhanded Worksurface Tablet, No Cup Holder, Not Upholstered	1041	1072	1068	1115	1068	1087
Unhanded Worksurface Tablet, With Cup Holder, Not Upholstered	1096	1125	1123	1168	1123	1143

Pricing and options are continued on the following pages.

N V R E
Variable HybrED Chair
with Storage Tray Base
(Continued)

DESCRIPTION	PRICE									
	Grade 1	COM/ Grade 2	COL/ Grade 3	Grade 4	Grade 5	Grade 6	Grade 7	Grade 8	Grade 9	Grade 10
No Worksurface, No Cup Holder, Single Upholstery Seat Only	1014	1031	1046	1057	1066	1076	1088	1096	1110	1121
No Worksurface, No Cup Holder, Single Upholstery Seat and Back	1190	1218	1247	1268	1289	1304	1326	1346	1365	1387
Unhanded Worksurface Tablet, No Cup Holder, Single Upholstery Seat Only	1216	1232	1246	1257	1268	1276	1290	1298	1312	1322
Unhanded Worksurface Tablet, No Cup Holder, Single Upholstery Seat and Back	1392	1420	1449	1470	1491	1506	1528	1547	1567	1588
Unhanded Worksurface Tablet, With Cup Holder, Single Upholstery Seat Only	1271	1289	1302	1314	1324	1333	1346	1354	1365	1378
Unhanded Worksurface Tablet, With Cup Holder, Single Upholstery Seat and Back	1448	1476	1505	1525	1544	1563	1583	1601	1623	1645
	Leather LA	Leather LB	Leather LC							
No Worksurface, No Cup Holder, Single Upholstery Seat Only	1066	1070	1086							
No Worksurface, No Cup Holder, Single Upholstery Seat and Back	1291	1298	1326							
Unhanded Worksurface Tablet, No Cup Holder, Single Upholstery Seat Only	1268	1271	1288							
Unhanded Worksurface Tablet, No Cup Holder, Single Upholstery Seat and Back	1493	1500	1528							
Unhanded Worksurface Tablet, With Cup Holder, Single Upholstery Seat Only	1324	1327	1343							
Unhanded Worksurface Tablet, With Cup Holder, Single Upholstery Seat and Back	1549	1556	1583							
If Hard Casters are specified with Silver and Ebony	add	31								
If Soft Casters are specified with Ebony	add	28								
If Soft Casters are specified with Silver and Ebony	add	72								
If Hard Glides (B) are specified	add	28								
If Soft Glides (C) are specified	add	46								

multi-use chairs

NVRH Variable HybrED Height-Adjustable Chair



With Worksurface Tablet
No Cup holder

With Worksurface Tablet with Cup holder

FEATURES

- Includes unhandled Worksurface Tablet with 360° double-articulated rotation in arm
- Pneumatic cylinder provides height-adjustment of 4"
- Swivel seat rotates 360°
- Includes the patented Variable integrated back-tilt
- Ebony (Plastic) or Polished Aluminum 5-star base finish option
- Optional Frame Finish Tablet Surface Finish in coordinating Ebony and Platinum
- Options for Hard and Soft Casters in Ebony or Silver and Ebony finish, or Hard and Soft Glides
- Mechanism and seat pan finished in Polished Aluminum
- Optional plastic Cup Holder

NOTES

Upholstery options available include: Not Upholstered, Single Upholstered Seat only, or Single Upholstered Seat and Back.

Articulating Arm frame finish matches chair frame finish.

Cup Holder finish matches Tablet Surface Finish.

Leather LD is not available on Variable.

PRODUCT OPTIONS

Cup Holder	Upholstery Style	Upholstery Seat	Tablet Surface Finish (Plastic)	Cylinder Style	Frame Finish	Plastic Shell Finish	Base Finish	Caster/Glide	Caster Finish
N No Cup Holder	N Not Upholstered	Fabric	7F Ebony	1 Standard	E Ebony	6A Deep Verde	52 Ebony (Satin)	Hard Casters	1 Ebony
Y With Cup Holder	P Single Upholstered Seat Only	Leather LA	YN Platinum Grey	3 Low	7 Platinum (Satin)	6C Blue	C9 Polished Aluminum	A Soft Casters	2 Silver and Ebony
	S Single Upholstered Seat and Back	Leather LB				6E Dark Grey		B Hard Glides	
		Leather LC				6G Medium Taupe		C Soft Glides	
						6H Medium Grey			
						6J Orange			
						7F Ebony			
						7H Light Grey			
						8C Very White			

SAMPLE ORDER CODE

NVRH N	P	T228	YN	1	7	6F	C9	A	2
---------------	----------	-------------	-----------	----------	----------	-----------	-----------	----------	----------

DESCRIPTION

No Cup Holder, Not Upholstered

With Cup Holder, Not Upholstered

PRICE

	Ebony Base	Polished Aluminum Base
No Cup Holder, Not Upholstered	995	1082
With Cup Holder, Not Upholstered	1050	1137

Pricing and options are continued on the following pages.

N V R H
Variable HybrED
Height-Adjustable Chair
(Continued)

DESCRIPTION	PRICE									
	Grade 1	COM/ Grade 2	COL/ Grade 3	Grade 4	Grade 5	Grade 6	Grade 7	Grade 8	Grade 9	Grade 10
No Cup Holder, Single Upholstery Seat Only	1170	1186	1201	1211	1220	1232	1242	1253	1264	1275
No Cup Holder, Single Upholstery Seat and Back	1347	1375	1404	1422	1443	1462	1480	1500	1522	1542
With Cup Holder, Single Upholstery Seat Only	1225	1240	1256	1266	1275	1288	1297	1306	1319	1329
With Cup Holder, Single Upholstery Seat and Back	1401	1429	1459	1477	1498	1515	1536	1554	1576	1596
	Leather LA	Leather LB	Leather LC							
No Cup Holder, Single Upholstery Seat Only	1220	1226	1240							
No Cup Holder, Single Upholstery Seat and Back	1445	1452	1480							
With Cup Holder, Single Upholstery Seat Only	1275	1278	1295							
With Cup Holder, Single Upholstery Seat and Back	1500	1507	1536							
If Polished Aluminum Base (C9) is specified	add	82								
If Hard Casters are specified with Silver and Ebony	add	31								
If Soft Casters are specified with Silver and Ebony	add	72								
If Soft Casters are specified with Ebony	add	28								
If Hard Glides (B) are specified	add	28								
If Soft Glides (C) are specified	add	46								

stacking chairs

stacking chairs

PRODUCT MAP / TABLE OF CONTENTS	290
NAMI OVERVIEW	292
NAMI DIMENSIONS	293
NAMI PRODUCT LISTING	296
VARIABLE OVERVIEW	304
VARIABLE DIMENSIONS & MATERIAL REQUIREMENTS	305
VARIABLE PRODUCT LISTING	308
VOLUME OVERVIEW	318
VOLUME DIMENSIONS & MATERIAL REQUIREMENTS	319
VOLUME PRODUCT LISTING	320
ZONE OVERVIEW	322
ZONE DIMENSIONS & MATERIAL REQUIREMENTS	323
ZONE PRODUCT LISTING	324

stacking chairs

product map

Nami

Pages 296

nami accessories

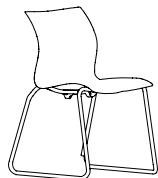

Stacking Chair
Sled Frame –
No Arms
Plastic and
3D Wood Shell

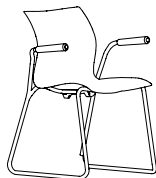

Stacking Chair
Sled Frame –
Integrated Arms
Plastic and
3D Wood Shell

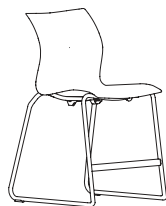

Guest Counter Stool
Sled Frame –
No Arms
Plastic and
3D Wood Shell

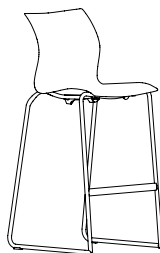

Bar Stool
Sled Frame –
No Arms
Plastic and
3D Wood Shell



With Bookrack

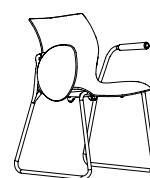

With Tablet

Variable

Pages 308



Stacking Chair –
With Glides
No Arms



Stacking Chair –
With Glides
Integrated Arms



Stacking Chair –
With Casters
No Arms



Stacking Chair –
With Casters
Integrated Arms



Stacking Stool –
Counter Height
No Arms



Stacking Stool –
Counter Height
Integrated Arms



Stacking Stool –
Bar Height
No Arms



Stacking Stool –
Bar Height
Integrated Arms

variable accessories



With Tablet
(right-handed)



With Tablet
(left-handed)



With Bookrack



With Tablet
(right-handed) and
Bookrack



With Tablet
(left-handed) and
Bookrack

* Ganging Device, Upholstered Seat, Upholstered Seat and Back and Dolly also available

product map

Volume

volume accessories

Page 320

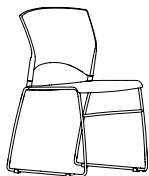

Stacking Chair – No Arms

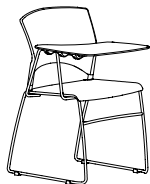

With Tablet (right-handed)

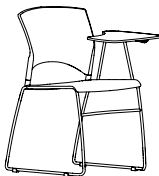

With Tablet (left-handed)



With Bookrack

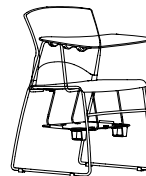

With Tablet (right-handed) and Bookrack



With Tablet (left-handed) and Bookrack

* Ganging Device, Upholstered Seat and Dolly also available

Zone®

zone accessories

Page 324



Four-Leg – No Arms



Four-Legs – Cantilever Arms



With Bookrack

* Ganging Device, Dolly also available



nami overview

Nami is a contemporary European designed stacking chair, whose name and form are inspired by a cresting wave. Its flexing plastic or 3D wood shell provides lumbar and thoracic support as well as comfort and beauty.

Nami – Plastic Stacking Guest Chair (NNAC)

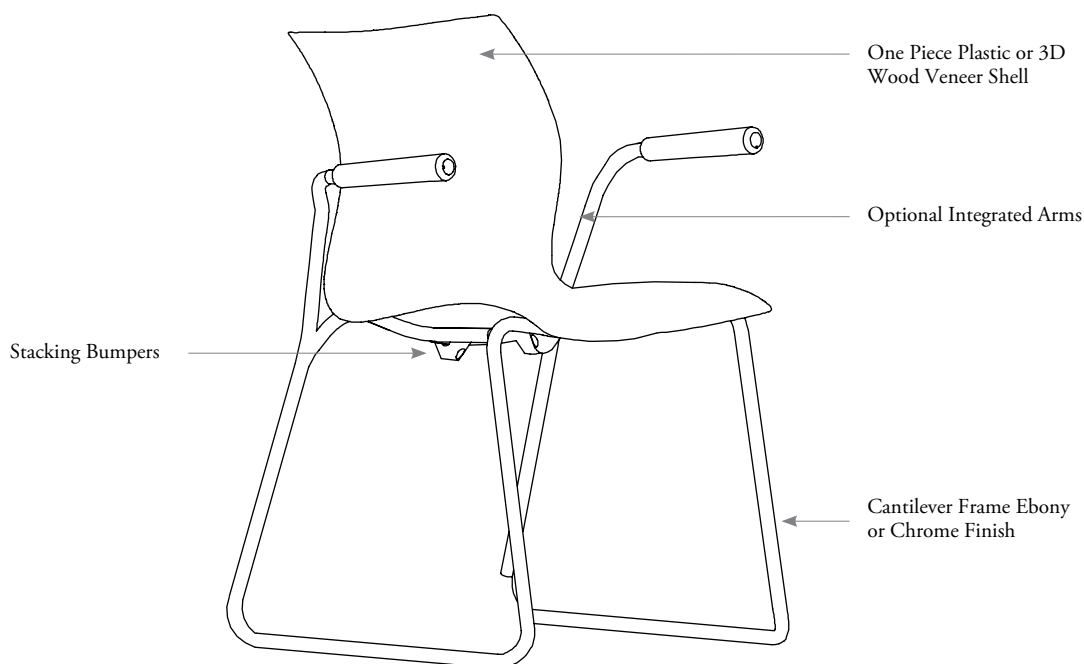

statement of line

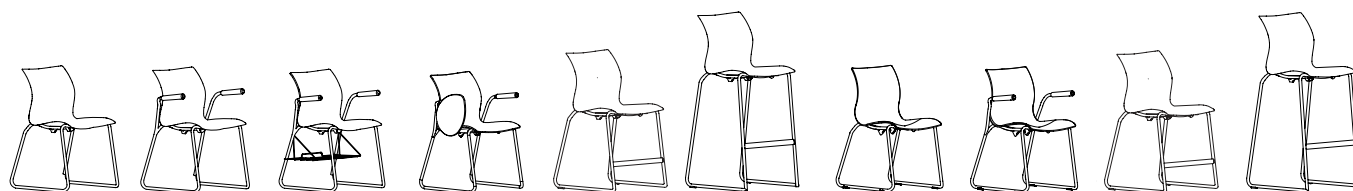

Cantilever Frame – No Arms (NNACN)

Cantilever Frame – Integrated Arms (NNACK)

with Bookrack (NNACKN)
with Tablet (NNACKT)
* Ganging Device and Dolly also available

Guest Counter Stool Sled Frame – No Arms (NNASN)

Guest Bar Stool Sled Frame – No Arms (NNAHN)

3D Wood – No Arms (NNWCN)

3D Wood – Integrated Arms (NNWCK)

3D Wood – No Arms (NNWSN)

3D Wood – No Arms (NNWHN)

nami dimensions & material requirements

features

- Designed and tested for users up to 300 lbs

Guest Chair

weight

Bar Stool	20 lbs
Counter Stool	19 lbs
Chair	17 lbs

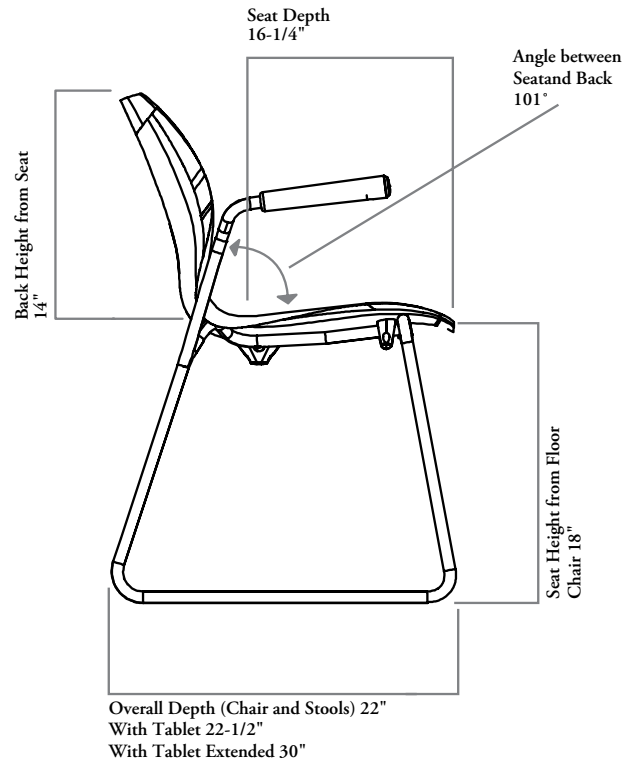
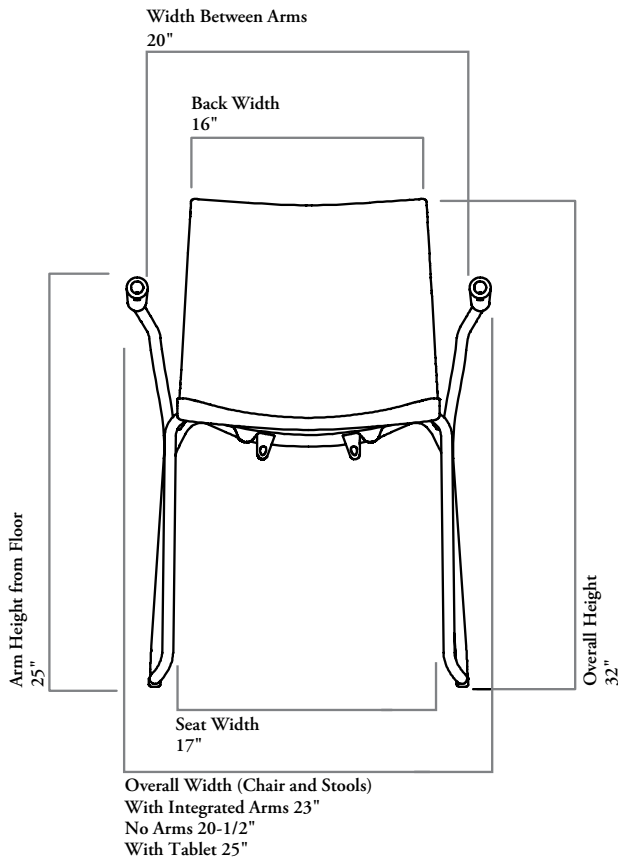

Other Dimensions

- Dolly Dimensions – x 40" d x 51" h x 25" w
- Dolly Dimensions with 20 stacked chairs – 40" d x 74" h x 25" w
- Tablet Dimensions – 10-3/8" d x 13-1/8" w
- Bookrack Dimensions – 15-3/4" d 10 h x 12" w

nami dimensions & material requirements (continued)

features

- Designed and tested for users up to 300 lbs

weight

Bar Stool	20 lbs
Counter Stool	19 lbs
Chair	17 lbs

Bar Stool

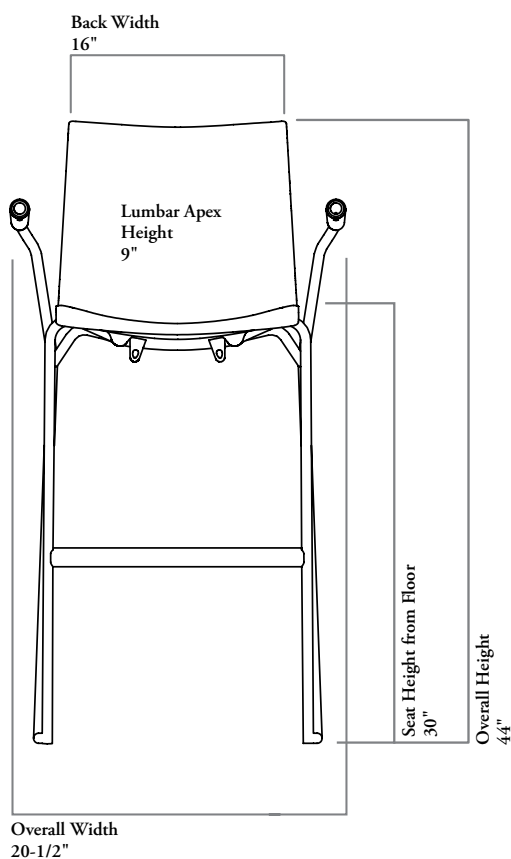

Counter Stool

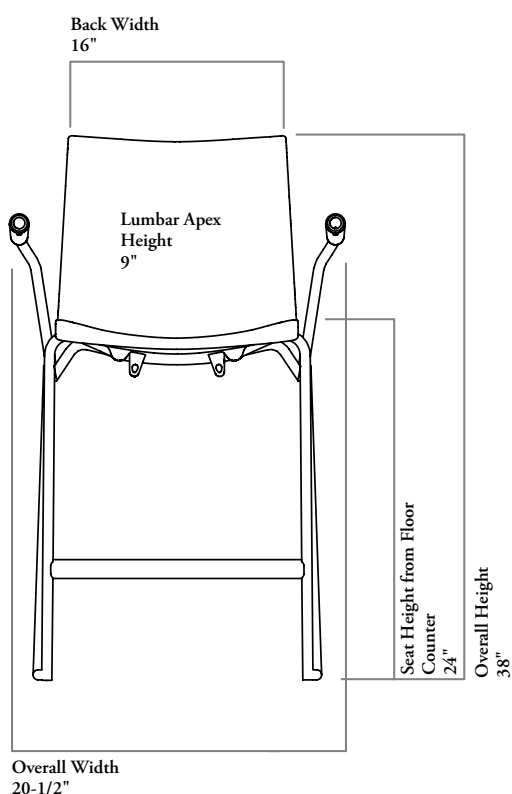

Other Dimensions

- Dolly Dimensions – x 40" d x 51" h x 25" w
- Dolly Dimensions with 20 stacked chairs – 40" d x 74" h x 25" w
- Tablet Dimensions – 10-3/8" d x 13-1/8" w
- Bookrack Dimensions – 15-3/4" d 10 h x 12" w

stacking chairs

Xpress

NNAC

Nami – Plastic Stacking Guest Chair

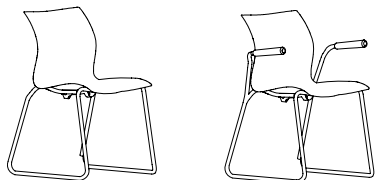

FEATURES

- One piece, flexing, plastic shell
- Stacks 20 high on the dolly
- Stacks 8 high on the floor
- Ganging device can gang any combination of arm option (including tablet arm)
- Multi-surface glides

NOTES

Tablet can only be specified on chairs with arms. Tablet is standard on the right and finished in Ebony.

When Tablet is specified, chair is no longer stackable.

When With Ganging (G) is selected, a ganging device is included to connect two chairs.

Not all configurations are available as Xpress. Please see Xpress catalogue and/or specification software for details.

PRODUCT OPTIONS

Frame Style	Arm Style	Frame Finish	Shell Finish	Tablet Option (If Applicable)	Other Options
C Sled	N No Arms	52 Ebony	7A Fearless Red	N No Tablet (Shown)	N No Ganging
	K Integrated Arms (Shown)	C6 Chrome	7F Ebony 7H Light Grey 7K Deep Ocean 7P Lunar Grey 7Y Storm White 8C Very White	T With Tablet	G With Ganging

SAMPLE ORDER CODE

NNAC C	N	52	7P	N	G
--------	---	----	----	---	---

DESCRIPTION

PRICE

No Arms

455

Integrated Arms

614

If Chrome Finish (C6) is specified add 142

If Tablet (T) is specified add 246

If Ganging Device (G) is specified add 87

FEATURES

- One piece, flexing, plastic shell
- Guest Counter Stool is not stackable
- Designed for 36" high counter applications
- Includes a footrest

NNAS

Nami – Plastic Guest Counter Stool



PRODUCT OPTIONS

Frame Style	Arm Style	Frame Finish	Shell Finish
C Sled	N No Arms	52 Ebony C6 Chrome	7A Fearless Red 7F Ebony 7H Light Grey 7K Deep Ocean 7P Lunar Grey 7Y Storm White 8C Very White

SAMPLE ORDER CODE

NNAS C	N	52	7A
---------------	----------	-----------	-----------

DESCRIPTION

PRICE

No Arms

683

If Chrome Finish (C6) is specified add 181

stacking chairs

N N A H

Nami – Plastic Guest Bar Stool

FEATURES

- One piece, flexing, plastic shell
- Bar Stool is not stackable
- Designed for 42" high bar applications
- Includes a footrest

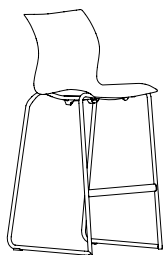

PRODUCT OPTIONS

Frame Style	Arm Style	Frame Finish	Shell Finish
C Sled	N No Arms	52 Ebony C6 Chrome	7A Fearless Red 7F Ebony 7H Light Grey 7K Deep Ocean 7P Lunar Grey 7Y Storm White 8C Very White

SAMPLE ORDER CODE

NNAH C	N	52	7A
---------------	----------	-----------	-----------

DESCRIPTION

PRICE

No Arms

683

If Chrome Finish (C6) is specified add 181

FEATURES

- Innovative one-piece 3D Wood shell in rotary-cut Beech with surface finish in four colors to fit within the range of Teknion's V2-V4 stain finishes
- Stacks 3 high on the floor. Does not stack on dolly.
- Ganging device can gang any combination of arm option (including tablet arm)
- Multi-surface glides

NOTES

Tablet can only be specified on chairs with arms. Tablet is standard on the right and finished in Ebony.

When Tablet is specified, chair is no longer stackable.

When With Ganging (G) is selected, a ganging device is included to connect two chairs.

A TekniStain form is required if a Teknion Wood product is needed in colors outside our standard offering. To order a Custom Wood Stain please use the seating code NOCWS. A one time upcharge per color applies. Please forward a purchase order and TekniStain form to your Customer Service Representative. Allow two (2) weeks for the TekniStain approval process. The Custom Wood Stain sample must be signed off prior to placing product order. Allow (3) extra weeks to the total lead time of the chair when using a custom wood stain. The total lead time will begin once final approved samples have been received from customer to Teknion. The custom wood stain sample must be signed off prior to placing product order.

NNWC
Nami – 3D Wood – Stacking Guest Chair



PRODUCT OPTIONS

Frame Style	Arm Style	Frame Finish	Wood Shell Finish	Tablet Option (If Applicable)	Other Options
C Sled	N No Arms	52 Ebony	BV Manila	N No Tablet (Shown)	N No Ganging
	K Integrated Arms (Shown)	C6 Chrome	BW Clove BX Tobacco BY Ginger Custom Wood Stains	T With Tablet	G With Ganging

SAMPLE ORDER CODE

NNWC C	N	C6	DY	N	G
---------------	----------	-----------	-----------	----------	----------

DESCRIPTION

PRICE

No Arms	1042
Integrated Arms	1201

- If Chrome Finish (C6) is specified add 142
- If Tablet (T) is specified add 246
- If Ganging Device (G) is specified add 87

To order a Custom Wood Stain Color for Seating please use the code NOCWS. A one time 1141 list charge per color applies.

stacking chairs

NNWS

Nami – 3D Wood – Guest Counter Stool

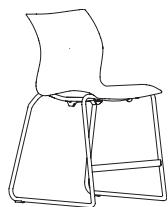

FEATURES

- Innovative one-piece 3D Wood shell in rotary-cut Beech with surface finish in four colors to fit within the range of Teknion's V2-V4 stain finishes
- Guest Counter Stool is not stackable
- Designed for 36" high counter applications
- Includes a footrest

A TekniStain form is required if a Teknion Wood product is needed in colors outside our standard offering. To order a Custom Wood Stain please use the seating code NOCWS. A one time upcharge per color applies. Please forward a purchase order and TekniStain form to your Customer Service Representative. Allow two (2) weeks for the TekniStain approval process. The Custom Wood Stain sample must be signed off prior to placing product order. Allow (3) extra weeks to the total lead time of the chair when using a custom wood stain. The total lead time will begin once final approved samples have been received from customer to Teknion. The custom wood stain sample must be signed off prior to placing product order.

PRODUCT OPTIONS

Frame Style	Arm Style	Frame Finish	Wood Shell Finish
C Sled	N No Arms	52 Ebony C6 Chrome	BV Manila BW Clove BX Tobacco BY Ginger Custom Wood Stains

SAMPLE ORDER CODE

NNWS C	N	C6	DY
---------------	----------	-----------	-----------

DESCRIPTION

PRICE

No Arms

1266

If Chrome Finish (C6) is specified add 181

To order a Custom Wood Stain Color for Seating please use the code NOCWS. A one time 1141 list charge per color applies.

FEATURES

- Innovative one-piece 3D Wood shell in rotary-cut Beech with surface finish in four colors to fit within the range of Teknion’s V2-V4 stain finishes
- Bar Stool is not stackable
- Designed for 42" high bar applications
- Includes a footrest

A TekniStain form is required if a Teknion Wood product is needed in colors outside our standard offering. To order a Custom Wood Stain please use the seating code NOCWS. A one time upcharge per color applies. Please forward a purchase order and TekniStain form to your Customer Service Representative. Allow two (2) weeks for the TekniStain approval process. The Custom Wood Stain sample must be signed off prior to placing product order. Allow (3) extra weeks to the total lead time of the chair when using a custom wood stain. The total lead time will begin once final approved samples have been received from customer to Teknion. The custom wood stain sample must be signed off prior to placing product order.

NNWH
Nami – 3D Wood – Guest Bar Stool

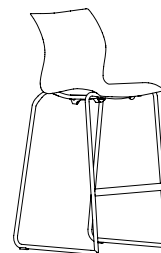

PRODUCT OPTIONS

Frame Style	Arm Style	Frame Finish	Wood Shell Finish
C Sled	N No Arms	52 Ebony C6 Chrome	BV Manila BW Clove BX Tobacco BY Ginger Custom Wood Stains

SAMPLE ORDER CODE

NNWH C	N	C6	DY
---------------	----------	-----------	-----------

DESCRIPTION

PRICE

No Arms

1266

If Chrome Finish (C6) is specified add 181

To order a Custom Wood Stain Color for Seating please use the code NOCWS. A one time 1141 list charge per color applies.

stacking chairs

N N A

Nami – Chair Accessories



Dolly



Bookrack



Tablet



Ganging Device

FEATURES

- Ganging Device can gang any combination of arm option (including tablet arm)
- Hard casters are standard on the Dolly
- Dolly is finished in Ebony

NOTES

The Ganging Device is used to attach two Nami Stacking Plastic Chairs (NNAC) or 3D Wood Chairs (NNWC) that were not previously ordered with the Ganging option.

Bookrack must be field installed.

Tablet is finished in Ebony.

Dolly will hold 20 Plastic Nami Chairs (NNAC) without Tablet Arm. Not to be used for 3D Wood Chairs (NNWC).

PRODUCT OPTIONS

Accessories	Bookrack Finish (If applicable)
G Ganging Device	52 Ebony
B Bookrack	C6 Chrome
T Tablet	
W Dolly	

SAMPLE ORDER CODE

NNA B	C6
--------------	-----------

DESCRIPTION

PRICE

Ganging Device

87

Bookrack

124

Tablet

246

Dolly

527

stacking chairs

variable overview

The 4-Leg Stacking Guest Chair is the ultimate multi-purpose chair as it can be used in various applications and environments, and because its medium density stackability makes it easy to store.

Very White shell finish is not recommended for high traffic use or minimized maintenance.

See “Work-Use Chairs” section for Variable Swivel Multi-Use Work Chairs and Stools.

See “Multi-Use Chairs” section for Variable Conference Chairs, HybrED Chairs and Application Guidelines for all Variable Chair types.

Variable Stacking Guest Chair (NVRG)

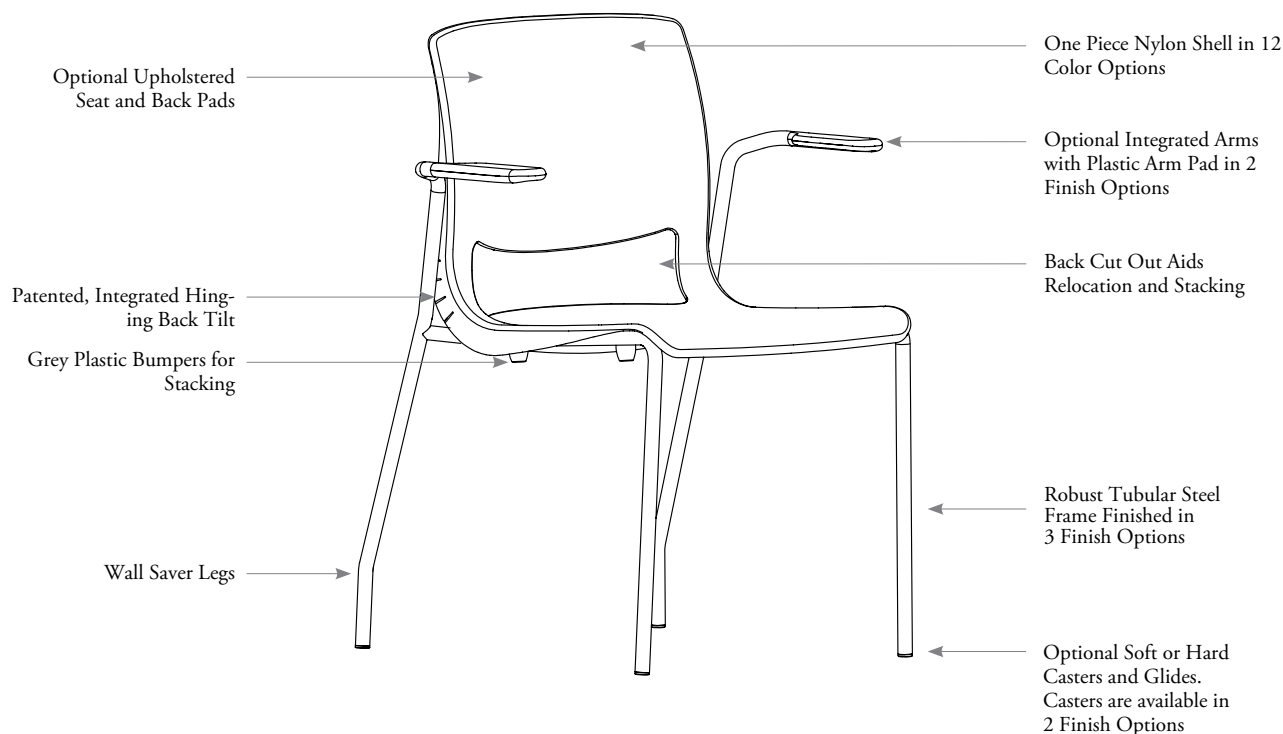

statement of line

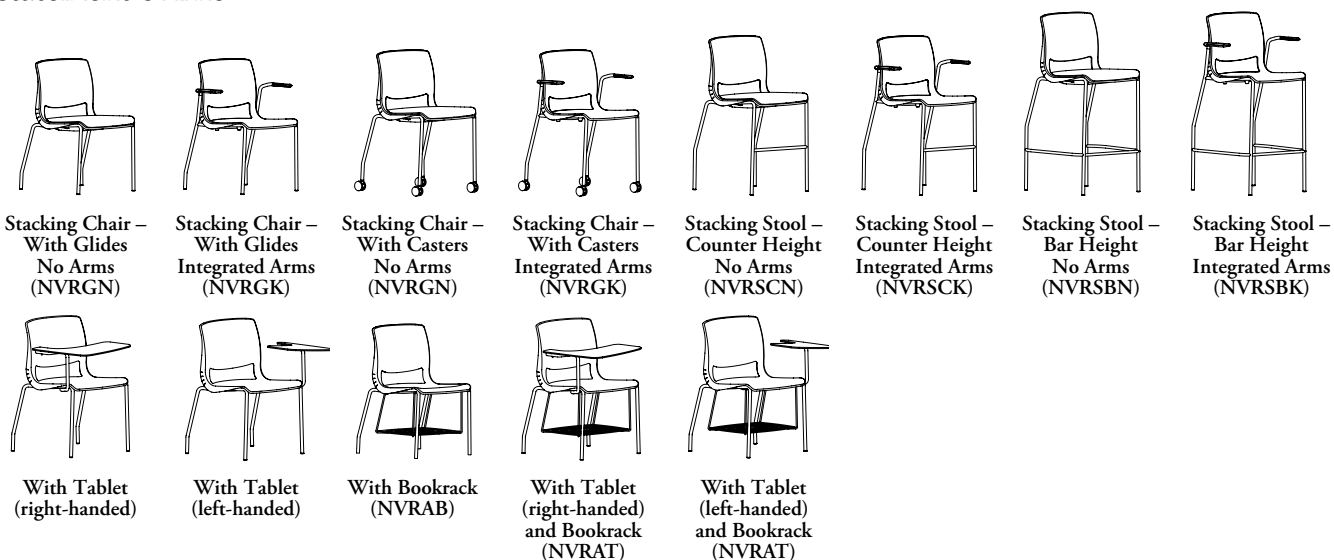

variable dimensions

features

- Designed and tested for users up to 300 lbs

weight

Guest Chair without Arms	13.4 lbs
Guest Chair with Arms	16.8 lbs

Guest Stacking Chair

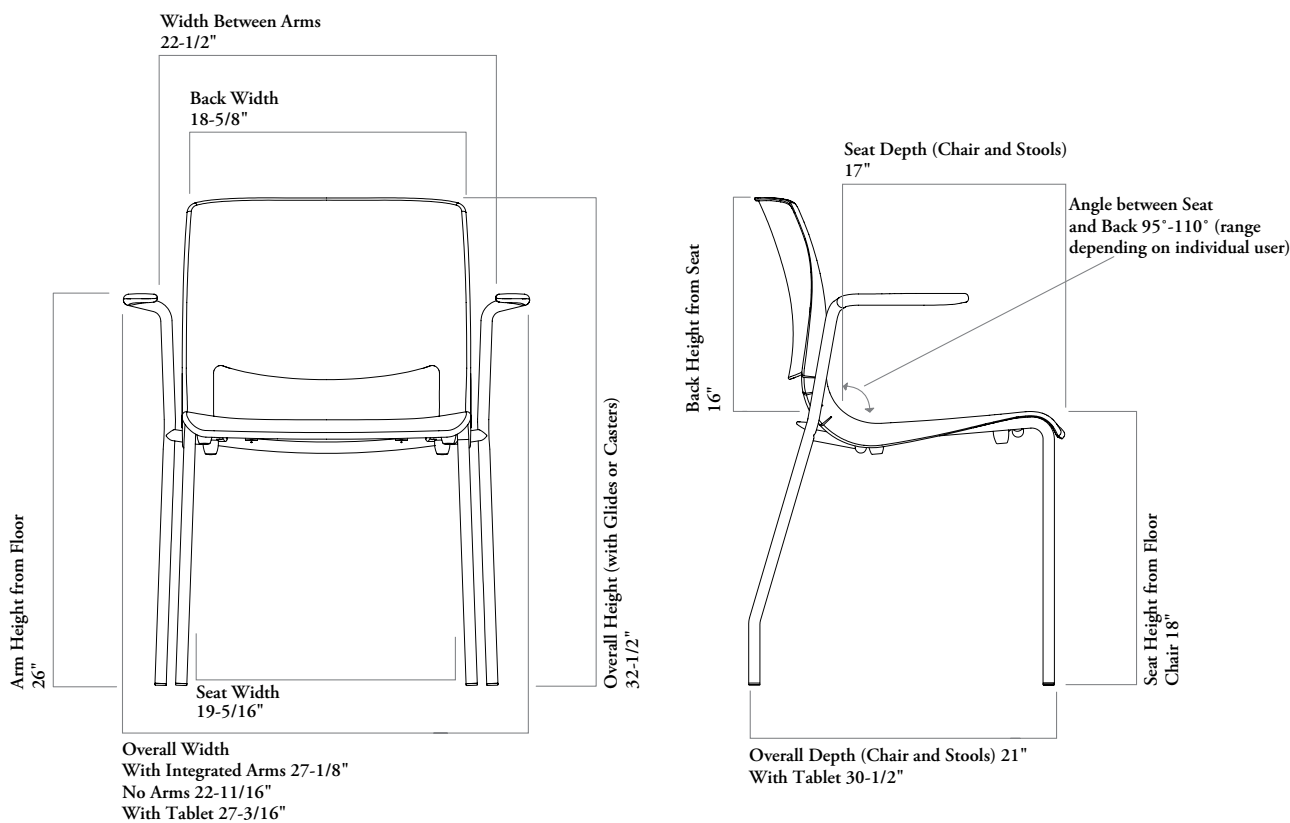

Other Dimensions

- Dolly Dimensions – 52-1/8" d x 35-1/2" h x 27-3/8" w
Unloaded- 52-1/8" d x 35-1/2" h x 27-3/8" w
Loaded with max. 18x Un-upholstered Chairs (Casters or Glides) - 52-1/8" d x 77" h x 27-3/8" w
Loaded with max. 12x Upholstered Chairs (Casters or Glides) - 52-1/8" d x 70" h x 27-3/8" w
- Tablet Dimensions – 10" d x 15-7/8" w
- Bookrack Dimensions – 14-13/16" d x 11-1/2" h x 18" w

COM/COL material requirement

The pattern, repeat and directionality of fabric may increase the amount of yardage required.

Leather quantities should always be rounded up to the next hide size, as yields vary from 60-80% and are affected by the quality, size and shape of the hide, and by the location and quantity of blemishes.

BACK	SINGLE UPHOLSTERED		DUAL UPHOLSTERED		SEAT DUAL UPHOLSTERED –	
	COM [yards]	COL [sq. ft]	COM [yards]	COL [sq. ft]	COM [yards]	COL [sq. ft]
Seat only	1	8.5	n/a	n/a	n/a	n/a
Seat and Back	1	10.5	1	8.5	1	8.5

stacking chairs

variable dimensions (continued)

features

- Designed and tested for users up to 300 lbs

weight

Counter Stool without Arms	15.5 lbs
Counter Stool with Arms	19.1 lbs
Bar Stool without Arms	18.8 lbs
Bar Stool with Arms	22.5 lbs

Bar Stool

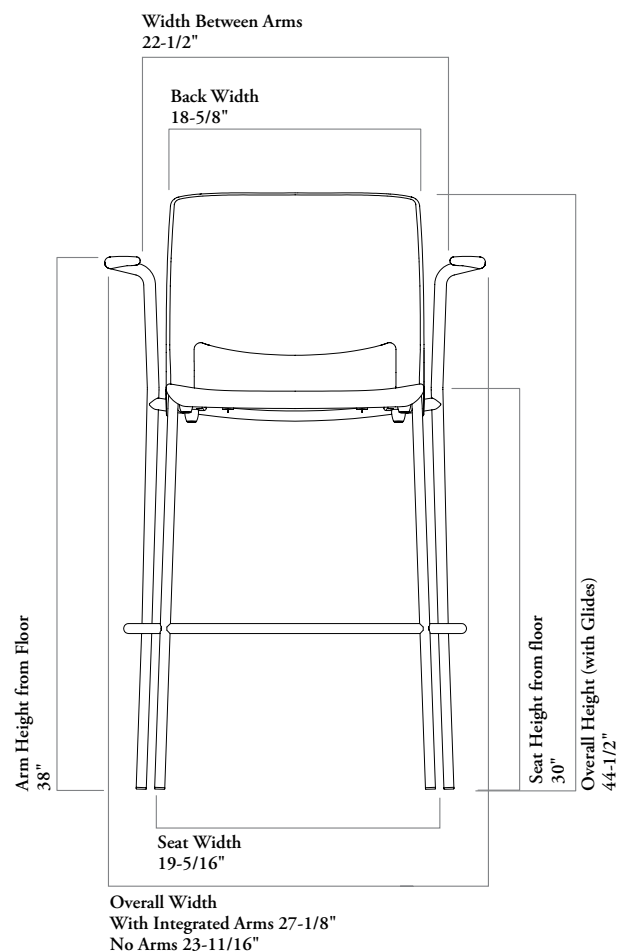

Counter Stool

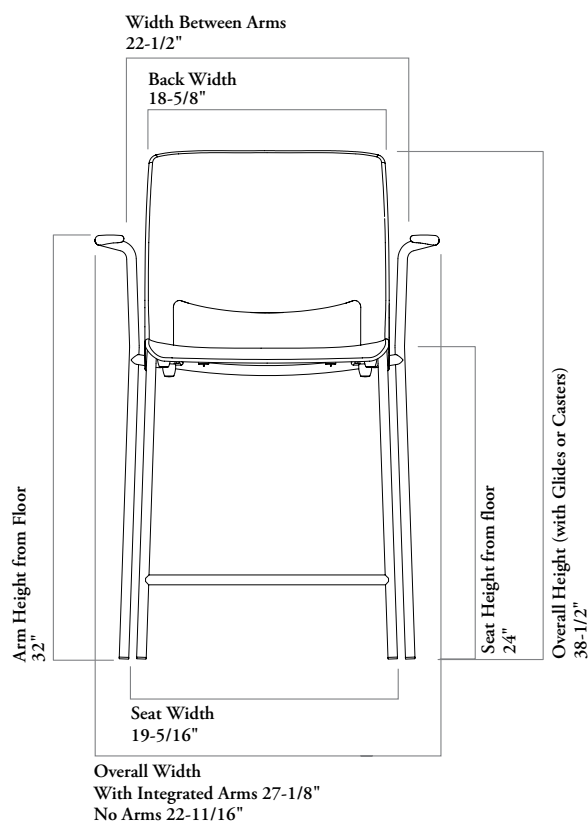

COM/COL material requirement

The pattern, repeat and directionality of fabric may increase the amount of yardage required.

Leather quantities should always be rounded up to the next hide size, as yields vary from 60-80% and are affected by the quality, size and shape of the hide, and by the location and quantity of blemishes.

BACK	SINGLE UPHOLSTERED		DUAL UPHOLSTERED		SEAT DUAL UPHOLSTERED –	
	COM [yards]	COL [sq. ft]	COM [yards]	COL [sq. ft]	COM [yards]	COL [sq. ft]
Seat only	1	8.5	n/a	n/a	n/a	n/a
Seat and Back	1	10.5	1	8.5	1	8.5

stacking chairs

NVRG

Variable Stacking Guest Chair

FEATURES

- Not upholstered 4-Leg Guest Chairs with casters, glides, no arms, or with arms stack 7 high on the floor (4 high when upholstered). Not upholstered chairs stack 18 high on the dolly (12 high when upholstered)
- Durable tubular steel construction with wall saver legs
- Includes the patented Variable integrated back-tilt
- Tablets can be applied all Variable Chairs that have been specified without arms and can be retrofit on-site. Guest Chairs with tablets stack 9 high on dolly.
- Optional Frame finishes are Ebony (paint), Platinum (paint) or Chrome
- Optional Integrated fixed arms with Plastic arm pad
- Can field-alter components- tablet, bookrack, ganging bracket

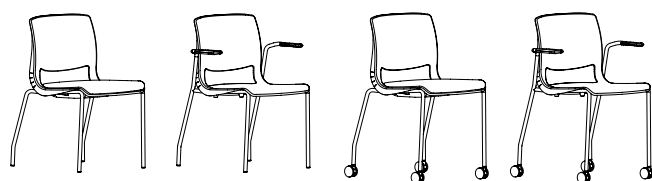

No Arms –
With Glides

Integrated Arms –
With Glides

No Arms –
With Casters

Integrated Arms –
With Casters

NOTES

Upholstery options available include: Not Upholstered, Single Upholstered Seat only, Single Upholstered Seat and Back, or Dual Upholstered Seat and Back.

Arm frame color matches chair frame finish. Plastic arm pads have optional Ebony or Platinum Grey finish.

Available with optional soft and hard casters or glides. Casters can be finished in Ebony or upgraded to Silver and Ebony finish.

Tablet and Bookrack must be field installed.

Leather LD is not available on Variable.

PRODUCT OPTIONS

Frame Style	Arm Style	Upholstery Style	Back Upholstery (For Dual)	Frame Finish	Plastic Shell Finish	Plastic Arm Finish	Caster Finish	Bookrack	Tablet Option	Tablet Surface Finish
G 4-Leg with Casters, Hard	N No Arms K Integrated Arms	N Not Upholstered	Fabric Leather LA Leather LB Leather LC	E Ebony 7 Platinum (Satin) C Chrome	6A Deep Verde 6C Blue 6E Dark Grey 6G Medium Taupe 6H Medium Grey 6J Orange 7F Ebony 7H Light Grey 8C Very White	7F Ebony YN Platinum Grey	1 Ebony 2 Silver and Ebony	O No Bookrack B With Bookrack	N No Tablet R Tablet (Right Handed) L Tablet (Left Handed)	Compact laminate
A 4-Leg with Casters, Soft										
B 4-Leg with Glides, Hard										
C 4-Leg with Glides, Soft										
			Seat Upholstery Finish							
			Fabric Leather LA Leather LB Leather LC							

SAMPLE ORDER CODE

NVRG A	K	P	E523	C	7F	7F	1	O	N	
---------------	----------	----------	-------------	----------	-----------	-----------	----------	----------	----------	--

See pricing on the following page.

N V R G
Variable Stacking Guest Chair
(Continued)

DESCRIPTION	PRICE		
4-LEG WITH CASTERS, HARD (G)	Ebony Frame	Platinum Frame	Chrome Frame
No Arms, Not Upholstered	420	420	452
Integrated Arms, Not Upholstered	525	525	558
4-LEG WITH CASTERS, SOFT (A)			
No Arms, Not Upholstered	448	448	480
Integrated Arms, Not Upholstered	553	553	586
4-LEG WITH GLIDES, HARD (B)			
No Arms, Not Upholstered	361	361	396
Integrated Arms, Not Upholstered	466	466	501
4-LEG WITH GLIDES, SOFT (C)			
No Arms, Not Upholstered	379	379	412
Integrated Arms, Not Upholstered	483	483	517
If Dual Upholstered (D) is specified	add	256	
If Chrome Frame (C) is specified	add	32	
If Silver and Ebony Casters, Soft (A) is specified	add	43	
If Silver and Ebony Casters, Hard (G) is specified	add	43	
If Bookrack (A) is specified	add	109	
If Tablet Arm (R) or (L) is specified	add	278	

Pricing is continued on the following pages.

stacking chairs

N V R G

Variable Stacking Guest Chair (Continued)

DESCRIPTION	PRICE									
	Grade 1	COM/ Grade 2	COL/ Grade 3	Grade 4	Grade 5	Grade 6	Grade 7	Grade 8	Grade 9	Grade 10
4-LEG WITH CASTERS, HARD (G)										
No Arms – Upholstered Seat Only	593	610	625	636	645	655	667	677	687	702
Integrated Arms – Upholstered Seat Only	701	713	731	739	753	761	770	783	792	805
No Arms – Upholstered Seat and Back	769	797	828	847	865	885	907	922	944	966
Integrated Arms – Upholstered Seat and Back	876	905	934	951	971	991	1010	1029	1050	1070
Leather										
No Arms – Upholstered Seat Only	645	651	665							
Integrated Arms – Upholstered Seat Only	753	756	768							
No Arms – Upholstered Seat and Back	870	879	907							
Integrated Arms – Upholstered Seat and Back	973	983	1010							
4-LEG WITH CASTERS, SOFT (A)										
No Arms – Upholstered Seat Only	622	638	653	664	675	683	695	705	715	730
Integrated Arms – Upholstered Seat Only	728	741	759	767	778	789	799	809	820	833
No Arms – Upholstered Seat and Back	797	827	856	876	893	913	935	951	972	994
Integrated Arms – Upholstered Seat and Back	905	933	962	980	999	1018	1038	1058	1079	1097
Leather										
No Arms – Upholstered Seat Only	675	679	690							
Integrated Arms – Upholstered Seat Only	778	784	796							
No Arms – Upholstered Seat and Back	896	907	935							
Integrated Arms – Upholstered Seat and Back	1002	1010	1038							
4-LEG WITH GLIDES, HARD (B)										
No Arms – Upholstered Seat Only	536	553	566	579	588	599	610	618	630	643
Integrated Arms – Upholstered Seat Only	641	657	673	682	694	704	713	725	735	746
No Arms – Upholstered Seat and Back	712	740	769	790	809	828	848	865	887	909
Integrated Arms – Upholstered Seat and Back	818	846	876	893	914	934	954	971	993	1013
Leather										
No Arms – Upholstered Seat Only	588	592	608							
Integrated Arms – Upholstered Seat Only	694	698	711							
No Arms – Upholstered Seat and Back	813	820	848							
Integrated Arms – Upholstered Seat and Back	916	923	954							
4-LEG WITH GLIDES, SOFT (C)										
No Arms – Upholstered Seat Only	554	567	585	593	607	615	626	637	647	659
Integrated Arms – Upholstered Seat Only	658	675	688	701	710	718	732	740	754	764
No Arms – Upholstered Seat and Back	731	759	788	806	827	844	864	884	906	923
Integrated Arms – Upholstered Seat and Back	834	862	891	912	933	948	970	989	1009	1031
Leather										
No Arms – Upholstered Seat Only	607	610	624							
Integrated Arms – Upholstered Seat Only	710	713	730							
No Arms – Upholstered Seat and Back	829	836	864							
Integrated Arms – Upholstered Seat and Back	935	942	970							
If Dual Upholstered (D) is specified	add			256						
If Chrome Frame (C) is specified	add			32						
If Silver and Ebony Casters, Soft (A) is specified	add			43						
If Silver and Ebony Casters, Hard (G) is specified	add			43						
If Bookrack (A) is specified	add			109						
If Tablet Arm (R) or (L) is specified	add			278						

stacking chairs

N V R S

Variable Stacking Stool

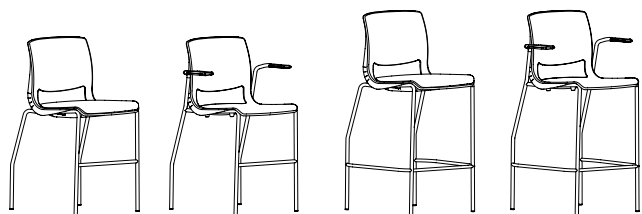

Counter Height
No Arms

Counter Height
Integrated Arms

Bar Height
No Arms

Bar Height
Integrated Arms

FEATURES

- Counter Height Stools are for 36" high counters. Bar Height Stools are for 42" high bars
- Both Counter and Bar heights are stackable 3 high
- Includes the patented Variable integrated back-tilt
- Durable tubular steel construction with wall saver legs and footrest
- Optional frame finishes are Ebony (paint), Platinum (paint) or Chrome
- Optional integrated fixed arms with Plastic pads
- Can field-alter components- tablet, bookrack

NOTES

Upholstery options available include: Not Upholstered, Single Upholstered Seat only, Single Upholstered Seat and Back, or Dual Upholstered Seat and Back.

Arm frame finish matches chair frame finish. Plastic arm pads have optional Ebony or Platinum Grey finish.

Available with optional soft and hard glides.

Leather LD is not available on Variable.

PRODUCT OPTIONS

Frame Style	Stool Height	Arm Style	Upholstery Style	Upholstery Seat	Frame Finish	Plastic Shell Finish	Plastic Arm Finish
B 4-Leg with Glides, Hard	C Counter Height	N No Arms	N Not Upholstered	Fabric	E Ebony	6A Deep Verde	7F Ebony
C 4-Leg with Glides, Soft	B Bar Height	K Integrated Arms	P Single Upholstered Seat Only	Leather LA	7 Platinum (Satin)	6C Blue	YN Platinum Grey
			S Single Upholstered Seat and Back	Leather LB	C Chrome	6E Dark Grey	
			D Dual Upholstered Seat and Back	Leather LC		6G Medium Taupe	
						6H Medium Grey	
						6J Orange	
						7F Ebony	
						7H Light Grey	
						8C Very White	

SAMPLE ORDER CODE

NVRS B	C	K	S	E523	C	7F	7F
---------------	----------	----------	----------	-------------	----------	-----------	-----------

DESCRIPTION

PRICE

COUNTER HEIGHT

4-LEG WITH GLIDES, HARD (B)

No Arms, Not Upholstered

Integrated Arms, Not Upholstered

Ebony Frame	Platinum Frame	Chrome Frame
593	593	641
701	701	745

4-LEG WITH GLIDES, SOFT (C)

No Arms, Not Upholstered

Integrated Arms, Not Upholstered

610	610	658
715	715	763

BAR HEIGHT

4-LEG WITH GLIDES, HARD (B)

No Arms, Not Upholstered

Integrated Arms, Not Upholstered

Ebony Frame	Platinum Frame	Chrome Frame
631	631	680
737	737	785

4-LEG WITH GLIDES, SOFT (C)

No Arms, Not Upholstered

Integrated Arms, Not Upholstered

754	754	799
647	647	695

Pricing is continued on the following pages.

N V R S
Variable Stacking Stool
(Continued)

DESCRIPTION	PRICE									
COUNTER HEIGHT										
4-LEG WITH GLIDES, HARD (B)	Grade 1	COM/ Grade 2	COL/ Grade 3	Grade 4	Grade 5	Grade 6	Grade 7	Grade 8	Grade 9	Grade 10
No Arms – Upholstered Seat Only	768	785	799	809	820	831	842	851	862	876
Integrated Arms – Upholstered Seat Only	873	889	906	914	923	936	945	956	967	980
No Arms – Upholstered Seat and Back	944	972	1002	1022	1041	1060	1082	1097	1119	1141
Integrated Arms – Upholstered Seat and Back	1050	1079	1109	1125	1146	1166	1186	1203	1225	1245
	Leather LA	Leather LB	Leather LC							
No Arms – Upholstered Seat Only	820	825	838							
Integrated Arms – Upholstered Seat Only	923	931	943							
No Arms – Upholstered Seat and Back	1043	1053	1082							
Integrated Arms – Upholstered Seat and Back	1148	1158	1186							
4-LEG WITH GLIDES, SOFT (C)	Grade 1	COM/ Grade 2	COL/ Grade 3	Grade 4	Grade 5	Grade 6	Grade 7	Grade 8	Grade 9	Grade 10
No Arms – Upholstered Seat Only	785	799	815	825	835	846	857	865	879	890
Integrated Arms – Upholstered Seat Only	890	907	920	933	942	951	964	972	984	996
No Arms – Upholstered Seat and Back	962	989	1018	1037	1058	1073	1095	1115	1137	1155
Integrated Arms – Upholstered Seat and Back	1066	1094	1123	1144	1165	1181	1202	1219	1241	1263
	Leather LA	Leather LB	Leather LC							
No Arms – Upholstered Seat Only	835	841	855							
Integrated Arms – Upholstered Seat Only	942	945	962							
No Arms – Upholstered Seat and Back	1060	1067	1095							
Integrated Arms – Upholstered Seat and Back	1167	1174	1202							
BAR HEIGHT										
4-LEG WITH GLIDES, HARD (B)	Grade 1	COM/ Grade 2	COL/ Grade 3	Grade 4	Grade 5	Grade 6	Grade 7	Grade 8	Grade 9	Grade 10
No Arms – Upholstered Seat Only	806	821	836	847	858	867	880	889	901	913
Integrated Arms – Upholstered Seat Only	912	926	942	951	964	972	984	994	1006	1018
No Arms – Upholstered Seat and Back	983	1010	1039	1060	1080	1096	1118	1138	1158	1177
Integrated Arms – Upholstered Seat and Back	1088	1116	1145	1166	1184	1202	1224	1241	1263	1284
	Leather LA	Leather LB	Leather LC							
No Arms – Upholstered Seat Only	858	862	877							
Integrated Arms – Upholstered Seat Only	964	967	981							
No Arms – Upholstered Seat and Back	1083	1090	1118							
Integrated Arms – Upholstered Seat and Back	1187	1196	1224							
4-LEG WITH GLIDES, SOFT (C)	Grade 1	COM/ Grade 2	COL/ Grade 3	Grade 4	Grade 5	Grade 6	Grade 7	Grade 8	Grade 9	Grade 10
No Arms – Upholstered Seat Only	821	836	854	862	873	884	893	906	915	930
Integrated Arms – Upholstered Seat Only	926	942	959	967	979	989	999	1009	1021	1034
No Arms – Upholstered Seat and Back	998	1025	1057	1073	1094	1114	1136	1151	1173	1195
Integrated Arms – Upholstered Seat and Back	1101	1130	1160	1180	1199	1217	1239	1257	1276	1298
	Leather LA	Leather LB	Leather LC							
No Arms – Upholstered Seat Only	873	879	891							
Integrated Arms – Upholstered Seat Only	979	983	996							
No Arms – Upholstered Seat and Back	1096	1108	1136							
Integrated Arms – Upholstered Seat and Back	1202	1211	1239							
If Dual Upholstered (D) is specified	add 256									
If Chrome Frame (C) is specified	add 49									

stacking chairs

N V R A B

Variable – Bookrack



FEATURES

- Can be applied to 4-Leg Guest Chairs, 4-Leg Counter Height and Bar Height Stools and can be retrofit on-site.
- Must be field installed.

NOTES

Available with a Chrome frame finish.

Guest Chairs and Stools with Bookracks installed are not stackable.

PRODUCT OPTIONS

Finish

C Chrome

SAMPLE ORDER CODE

NVRAB C

PRICE

109

FEATURES

- Can gang any combination of 4-Leg Guest Chairs
- Optional Ganging Devices will accommodate ganging of chairs with no arms, chairs with integrated arm option or with tablet option
- Ships in a quantity of 10

NOTES

Finished in Ebony Plastic.

NVRAG
Variable – Ganging Device



PRODUCT OPTIONS

Size
N For Use on Chairs With No Arms, Package of 10
F For Use on Chairs With Arms or Tablet, Package of 10

SAMPLE ORDER CODE

NVRAG F

PRICE

96

stacking chairs

N V R A T

Variable – Tablet



With Tablet
(right-handed)



With Tablet
(left-handed)

FEATURES

- Right or left-handed
- Pivots up for easy egress
- Must be field installed

NOTES

Tablets can be applied to all Variable Chairs that have been specified without arms and can be retrofit on-site.

Guest Chairs with the Tablet option are stackable 4 high on the floor and 9 high on the dolly.

Available with a Chrome frame finish.

Very White Tablet surface finish is not recommended for high frequency, low maintenance use.

PRODUCT OPTIONS

Tablet Orientation	Frame Finish	Tablet Surface Finish
R Tablet (Right-Handed) L Tablet (Left-Handed)	C Chrome	Compact Laminate

SAMPLE ORDER CODE

NVRAT R	C	N9
---------	---	----

PRICE

278

FEATURES

- Hard Casters are standard on the Dolly.

NOTES

Dolly will hold up to a 18 non upholstered Guest Chairs or 12 upholstered Guest Chairs with or without arms, casters or glides. Dolly will hold 9 Guest Chairs with tablets.

Finished in Ebony.

N V R A W
Variable – Dolly

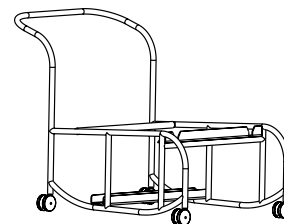

PRODUCT OPTIONS

Finish

E Ebony

SAMPLE ORDER CODE

NVRAW E

PRICE

829

stacking chairs

volume overview

Volume is a high-density stacking chair ideal for small and large spaces including cafeterias, auditoriums, training rooms, classrooms and conference rooms.

Volume – Stacking Chair (NHDS)

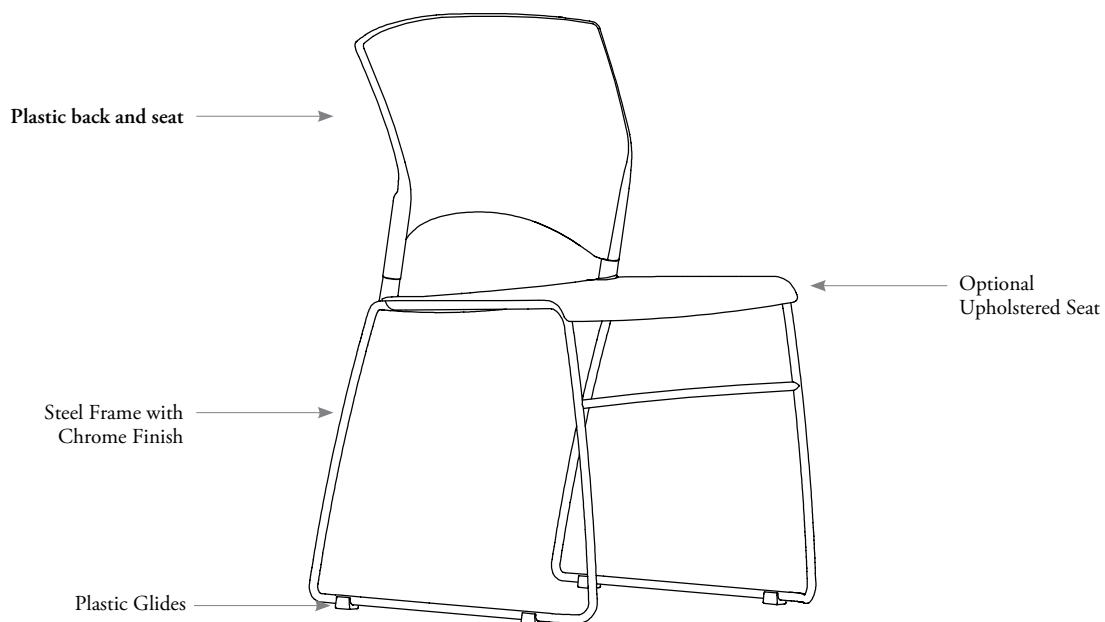

statement of line

* Ganging Device, Upholstered Seat and Dolly also available



Stacking Chair –
No Arms
(NHDSN)



With Tablet
(right-handed)
(NHDSR)



With Tablet
(left-handed)
(NHDSL)



With Bookrack
(NHDSB)



With Tablet
(right-handed)
and Bookrack
(NHDSBR)



With Tablet
(left-handed) and
Bookrack
(NHDSBL)

volume dimensions & material requirements

features

- Designed and tested for users up to 300 lbs

weight

Chair	15 lbs
-------	--------

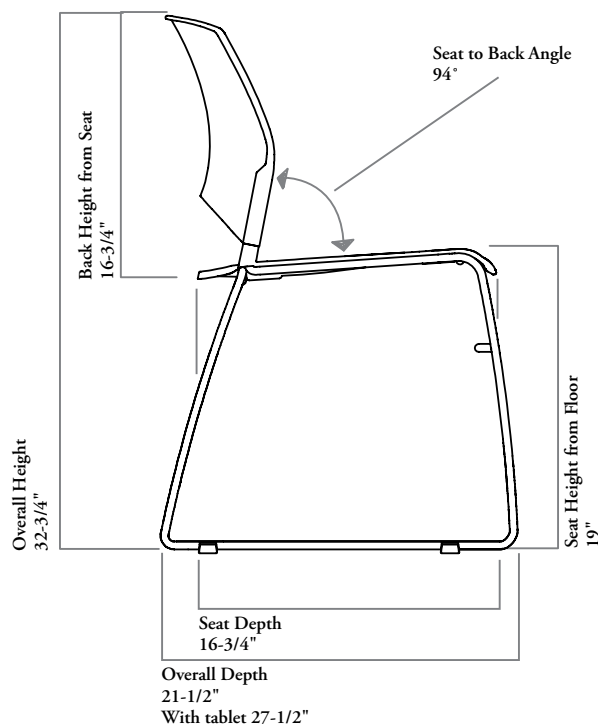
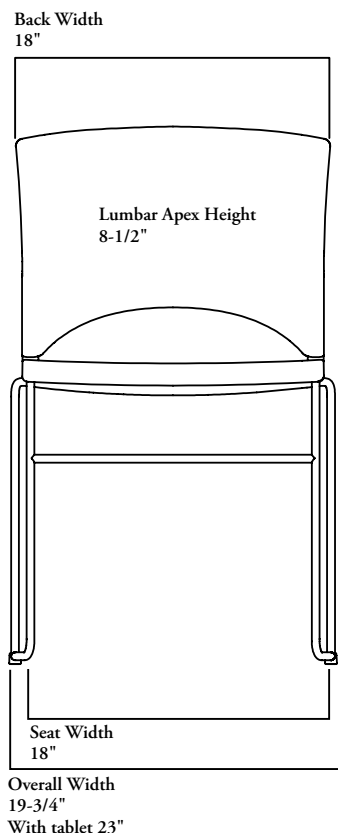

Other Dimensions

- Dolly Dimensions – 40" d x 25" w x 35" h
- Dolly Dimensions with 35 stacked plastic chairs or 25 stacked upholstered chairs – 76" h x 25" w x 42" d
- Tablet Dimensions – 17-1/2" d x 16 -3/4" w
- Bookrack Dimensions – 12" w x 14" l

COM/COL material requirement

The pattern, repeat and directionality of fabric may increase the amount of yardage required.

Leather quantities should always be rounded up to the next hide size, as yields vary from 60-80% and are affected by the quality, size and shape of the hide, and by the location and quantity of blemishes.

SEAT UPHOLSTERY

	COM [yards]	COL [sq. ft]
Medium	0.75	6.5

stacking chairs

Xpress

NHDS

Volume Stack Chair

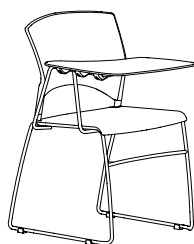

FEATURES

- Non upholstered chairs stack 35 high on the dolly and 10 high on the floor
- Upholstered chairs stack 25 high on the dolly and 8 high on the floor

NOTES

When Tablet Arm is specified, chair is no longer stackable.

When Bookrack is specified, chair is no longer stackable.

Tablet surface is finished in Ebony and frame is finished in Chrome.

Bookrack is finished in Chrome frame with Ebony plastic shelf details.

PRODUCT OPTIONS

Arm Style	Upholstered/Seat Style	Back Finish	Seat Finish	Upholstery Finish (If applicable)	Frame Finish	Bookrack	Tablet Arm
N No Arms	U Upholstered	6H Medium Grey	6H Medium Grey	Fabric	C Chrome	N No Bookrack B With Bookrack	N No Tablet Arm R With Tablet Arm (right-handed) L With Tablet Arm (left-handed)
	N Not Upholstered	7E Espresso	7E Espresso				
		7F Ebony	7F Ebony				
		7K Deep Ocean	7K Deep Ocean				
		7Y Storm White	7Y Storm White				

SAMPLE ORDER CODE

NHDS N	U	7Y	7E	M501	C	B	R
--------	---	----	----	------	---	---	---

DESCRIPTION

PRICE

	COM/		COL/		Grade 4	Grade 5	Grade 6	Grade 7	Grade 8	Grade 9	Grade 10
	Grade 1	Grade 2	Grade 3	Grade 3							
Not Upholstered Seat	271	n/a	n/a	n/a	n/a	n/a	n/a	n/a	n/a	n/a	n/a
Upholstered Seat	n/a	403	432	463	493	524	552	583	612	644	745

If Bookrack (B) is specified add 123

If Tablet Arm Right (R) or Left (L) is specified add 210

N H D

Volume – Chair Accessories

FEATURES

- Hard casters are standard on the Dolly

NOTES

Bookrack and Tablet Arm must be field installed.

Dolly will hold 35 non upholstered Volume Chairs (NHDS) without Tablet Arm or Bookrack.

Dolly will hold 25 upholstered Volume Chairs (NHDS) without Tablet Arm or Bookrack.

Tablet surface is finished in Ebony and frame is finished in Chrome.

Bookrack is finished in Chrome frame with Ebony plastic shelf details.

Ganging Device ships in quantities of 10.



Dolly



Bookrack



Tablet
(right or
left-handed)

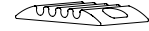

Ganging Device

PRODUCT OPTIONS

Accessories

B Bookrack

G Ganging Device

R Tablet (Right-Handed)

L Tablet (Left-Handed)

W Dolly

SAMPLE ORDER CODE

NHD B

DESCRIPTION	PRICE
Bookrack (B)	123
Ganging Device (G) (quantity: 10)	87
Tablet (R/L) (Right or Left-Handed)	210
Dolly (W)	534

stacking chairs

zone overview

The form-fitting Zone Chair is a classic stacking chair, simple, practical and comfortable.

Zone – Stacking Guest Chair (NZOC)

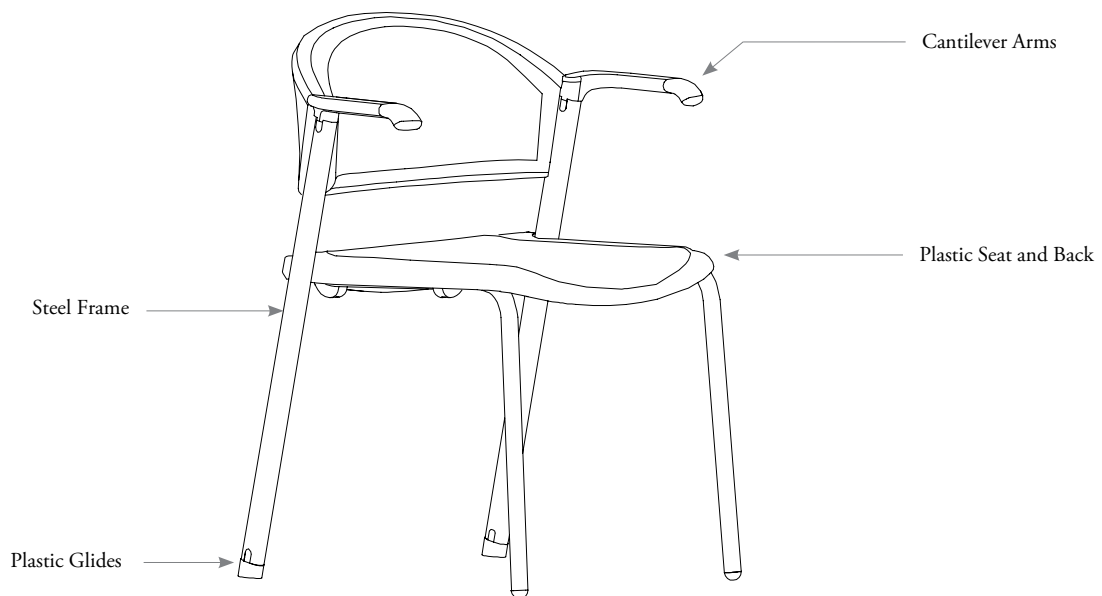

statement of line



Four-Leg –
No Arms
(NZOCN)



Four-Legs –
Cantilever Arms
(NZOCF)



With Bookrack
(NZOCB)
*Ganging Device,
Dolly also available

zone dimensions & material requirements

features

- Designed and tested for users up to 275 lbs

weight

Chair	22 lbs
-------	--------

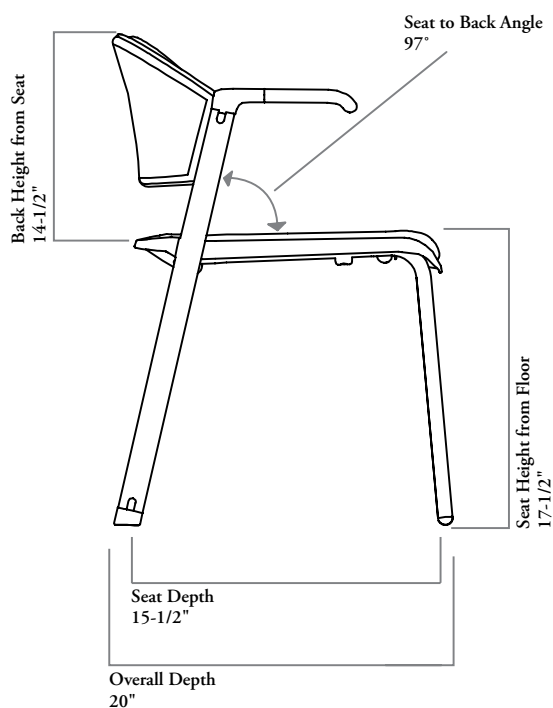
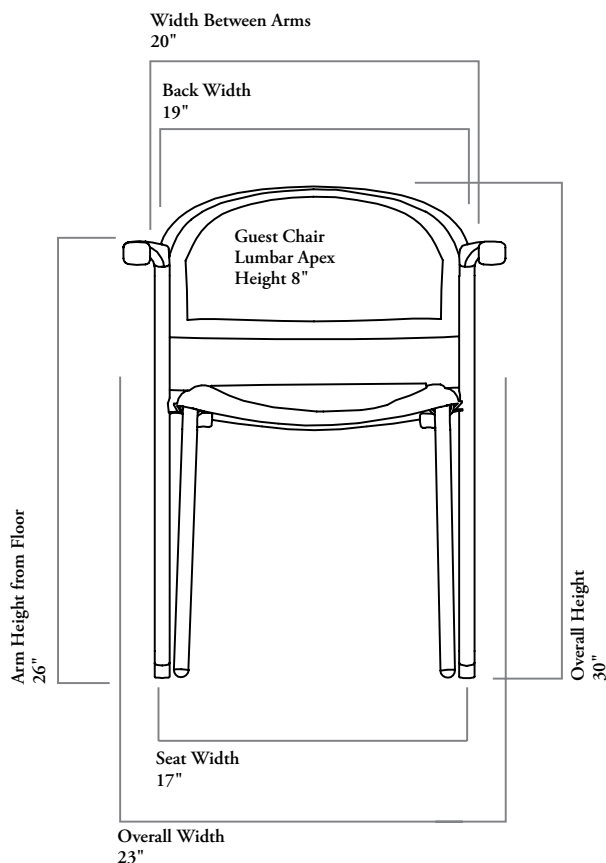

Other Dimensions

- Dolly Dimensions – 18" h x 2-3/4" w x 27" d
- Dolly Dimensions with 10 stacked chairs – 59-1/2" h x 22-3/4" w x 40-1/2" d
- Bookrack Dimensions – 14" w x 14-1/2" l

stacking chairs

Xpress

N Z O C

Zone – Stacking Guest Chair

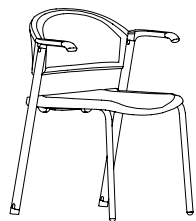

FEATURES

- Stacks 10 high on a dolly, stacks 5 on the floor
- Multi-surface glides

NOTES

When bookrack is specified, chair is no longer stackable.

Not all configurations are available as Xpress. Please see Xpress catalogue and/or specification software for details.

PRODUCT OPTIONS

Size	Frame Style	Arm Style	Upholstered/ Back Style	Frame Finish	Seat Plastic Finish (If applicable)	Back Plastic Finish	Other Options	Bookrack Finish
A Small	F Four-Legs	N No Arms F Cantilever Arms (Shown)	N Not Upholstered	E Ebony	E Ebony	E Ebony	B Bookrack 0 No Bookrack	E Ebony

SAMPLE ORDER CODE

NZOC A	F	N	N	E	E	E	B	E
---------------	----------	----------	----------	----------	----------	----------	----------	----------

DESCRIPTION

NOT UPHOLSTERED PLASTIC (N) **Xpress**

No Arms

Cantilever Arms

PRICE

299

365

If Bookrack (B) is specified, add 97

N Z O

Zone – Chair Accessories

FEATURES

Hard Casters are standard on Dolly.

NOTES

Ganging devices are used to attach Zone Stacking Chair (NZOC) in a line. Ganging Device should be attached from the back of the chair frame between the back and the seat. Select Ganging Device size option for chair with arms or with no arms.

Bookrack attaches to Zone Chair (NZOC) only.



Dolly



Bookrack



Ganging Device

PRODUCT OPTIONS

Accessories	Ganging Device Size	Bookrack Finish
W Dolly G Ganging Devices T Bookrack	N For Chairs with no Arms F For Chairs with Arms	E Ebony

SAMPLE ORDER CODE

NZO W	N	E
--------------	----------	----------

DESCRIPTION

PRICE

Dolly	350
Ganging Devices	87 (package of 10)
Bookrack	87

soft seating

soft seating

PRODUCT MAP / TABLE OF CONTENTS	332
AEGIS DIMENSIONS & MATERIAL REQUIREMENTS	339
AEGIS PRODUCT LISTING	340
WHAT IS BANQS	343
PLANNING WITH BANQS	344
BANQS FABRICS AND FINISHES	346
BANQS PRODUCT OFFERING	350
UNDERSTANDING BANQS SEATING	356
BANQS SINGLE-SIDED SOLO FOCUS, STANDARD OVERVIEW	358
BANQS SINGLE-SIDED SOLO FOCUS, STANDARD DIMENSIONS & MATERIAL REQUIREMENTS	359
BANQS SINGLE-SIDED SOLO FOCUS, WIDE OVERVIEW	360
BANQS SINGLE-SIDED SOLO FOCUS, WIDE DIMENSIONS & MATERIAL REQUIREMENTS	361
PRODUCT LISTING	362
BANQS CORNER ALCOVE SOLO FOCUS, STANDARD OVERVIEW	368
BANQS CORNER ALCOVE SOLO FOCUS, STANDARD DIMENSIONS & MATERIAL REQUIREMENTS	369
BANQS CORNER ALCOVE SOLO FOCUS, WIDE OVERVIEW	370
BANQS CORNER ALCOVE SOLO FOCUS, WIDE DIMENSIONS & MATERIAL REQUIREMENTS	371
PRODUCT LISTING	372
BANQS FULL ALCOVE SOLO FOCUS, STANDARD OVERVIEW	384
BANQS FULL ALCOVE SOLO FOCUS, STANDARD DIMENSIONS & MATERIAL REQUIREMENTS	385
BANQS FULL ALCOVE SOLO FOCUS, WIDE OVERVIEW	386
BANQS FULL ALCOVE SOLO FOCUS, WIDE DIMENSIONS & MATERIAL REQUIREMENTS	387
PRODUCT LISTING	388
BANQS RECTANGULAR BENCH, NO BACK OVERVIEW	394
BANQS RECTANGULAR BENCH, NO BACK DIMENSIONS & MATERIAL REQUIREMENTS	395
PRODUCT LISTING	396
BANQS SINGLE-SIDED SOFA OVERVIEW	398
BANQS SINGLE-SIDED SOFA DIMENSIONS & MATERIAL REQUIREMENTS	399
PRODUCT LISTING	400
BANQS BACK-TO-BACK SOFA OVERVIEW	404
BANQS BACK-TO-BACK SOFA DIMENSIONS & MATERIAL REQUIREMENTS	405
PRODUCT LISTING	406

CONTINUED ON THE FOLLOWING PAGE

soft seating (continued)

BANQS CORNER ALCOVE SOFA OVERVIEW	410
BANQS CORNER ALCOVE SOFA DIMENSIONS & MATERIAL REQUIREMENTS . .	411
PRODUCT LISTING	412
BANQS FULL ALCOVE SOFA OVERVIEW	416
BANQS FULL ALCOVE SOFA DIMENSIONS & MATERIAL REQUIREMENTS . .	417
PRODUCT LISTING	418
BANQS FABRIC PATTERN AND SEAM GUIDELINES	422
BANQS HIGH SPANNING SCREEN OVERVIEW	424
PLANNING WITH BANQS HIGH SPANNING SCREEN	425
BANQS HIGH SPANNING SCREEN DIMENSIONS & MATERIAL REQUIREMENTS	426
PRODUCT LISTING	427
BANQS DIGITAL SHARE WALL MOUNT INTEGRATION KIT OVERVIEW	428
BANQS DIGITAL SHARE WALL MOUNT INTEGRATION KIT DIMENSIONS & MATERIAL REQUIREMENTS	429
PRODUCT LISTING	430
BANQS TABLE WITH FLAT BASE OVERVIEW	432
PLANNING WITH BANQS TABLES	433
BANQS TABLES EDGE TRIM STYLE OVERVIEW	436
GRAIN DIRECTIONS	437
BANQS TABLE WITH FLAT BASE DIMENSIONS & MATERIAL REQUIREMENTS	438
PRODUCT LISTING	440
BANQS TABLE WITH 4-PRONG BASE OVERVIEW	442
PRODUCT LISTING	443
UNDERSTANDING BANQS FREESTANDING TABLES	444
BANQS FREESTANDING OCCASIONAL TABLE OVERVIEW	445
BANQS FREESTANDING OCCASIONAL TABLE DIMENSIONS & MATERIAL REQUIREMENTS	446
PRODUCT LISTING	447
BANQS FREESTANDING OCCASIONAL TABLE WITH SCREENS OVERVIEW	448
BANQS FREESTANDING OCCASIONAL TABLE WITH SCREENS DIMENSIONS & MATERIAL REQUIREMENTS	449
BANQS ACCESSORIES OVERVIEW	453
PRODUCT LISTING	450

CONTINUED ON THE FOLLOWING PAGE

soft seating (continued)

BELIZE OVERVIEW	460
BELIZE DIMENSIONS & MATERIAL REQUIREMENTS	461
BELIZE PRODUCT LISTING	462
WHAT IS BONDS	464
PLANNING WITH BONDS	467
BONDS PRODUCT OFFERING	465
BONDS FREESTANDING SEATING OVERVIEW	480
BONDS FREESTANDING SEATING DIMENSIONS & MATERIAL REQUIREMENTS	482
PLANNING WITH BONDS FREESTANDING SEATING	483
PRODUCT LISTING	484
BONDS BUILDING BLOCK SEATING OVERVIEW	486
BONDS BUILDING BLOCK SEATING DIMENSIONS & MATERIAL REQUIREMENTS	488
PRODUCT LISTING	490
BONDS BUILDING BLOCK SQUARE TABLE OVERVIEW	494
BONDS BUILDING BLOCK SQUARE TABLE DIMENSIONS & MATERIAL REQUIREMENTS	495
BONDS BUILDING BLOCK RECTANGULAR TABLE OVERVIEW	496
BONDS BUILDING BLOCK RECTANGULAR TABLE DIMENSIONS & MATERIAL REQUIREMENTS	497
BONDS BUILDING BLOCK TRIANGULAR TABLE OVERVIEW	498
BONDS BUILDING BLOCK TRIANGULAR TABLE DIMENSIONS & MATERIAL REQUIREMENTS	499
PLANNING WITH BONDS BUILDING BLOCK TABLES	500
BONDS AUXILIARY TABLE OVERVIEW	505
BONDS AUXILIARY TABLE DIMENSIONS & MATERIAL REQUIREMENTS	506
PLANNING WITH BONDS AUXILIARY TABLE	507
PRODUCT LISTING	502

CONTINUED ON THE FOLLOWING PAGE

soft seating (continued)

COLLABORATIVE OTTOMAN OVERVIEW, DIMENSIONS & MATERIAL REQUIREMENTS	510
COLLABORATIVE OTTOMAN PRODUCT LISTING	511
DNA OVERVIEW	514
IDEA STARTERS OVERVIEW	515
TEKNION DNA PLANNING POSSIBILITIES	516
TEKNION DNA SEATING BASICS	517
TEKNION DNA TABLE BASICS	518
PLANNING WITH DNA BENCHES & TABLES	519
UNDERSTANDING POWER & COMMUNICATIONS	522
TEKNION DNA RECESSED DATA/ELECTRICAL MODULE DETAILS	523
TEKNION DNA FINISHES	524
TEKNION DNA DIMENSIONS & MATERIAL REQUIREMENTS	525
COMPONENT OVERVIEW	528
TEKNION DNA COFFEE TABLE BASICS	529
DNA PRODUCT LISTING	530
FERRARRA DIMENSIONS & MATERIAL REQUIREMENTS	538
FERRARRA PRODUCT LISTING	539
TUX DIMENSIONS & MATERIAL REQUIREMENTS	540
TUX PRODUCT LISTING	541
VASARI DIMENSIONS & MATERIAL REQUIREMENTS	542
VASARI PRODUCT LISTING	543
VIGNETTE DIMENSIONS & MATERIAL REQUIREMENTS	546
VIGNETTE PRODUCT LISTING	547

product map

Aegis

Pages 340

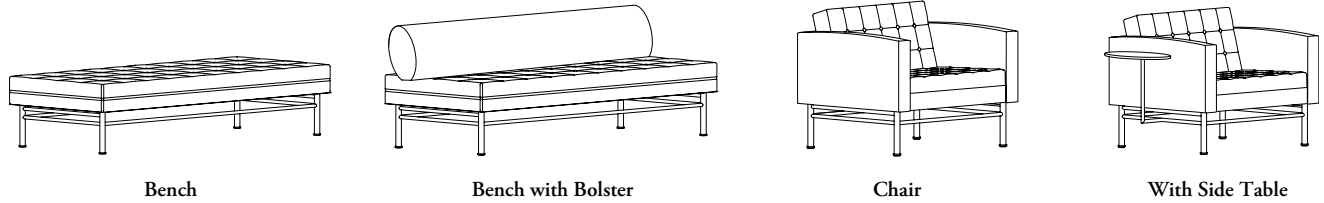

Banqs

Pages 362

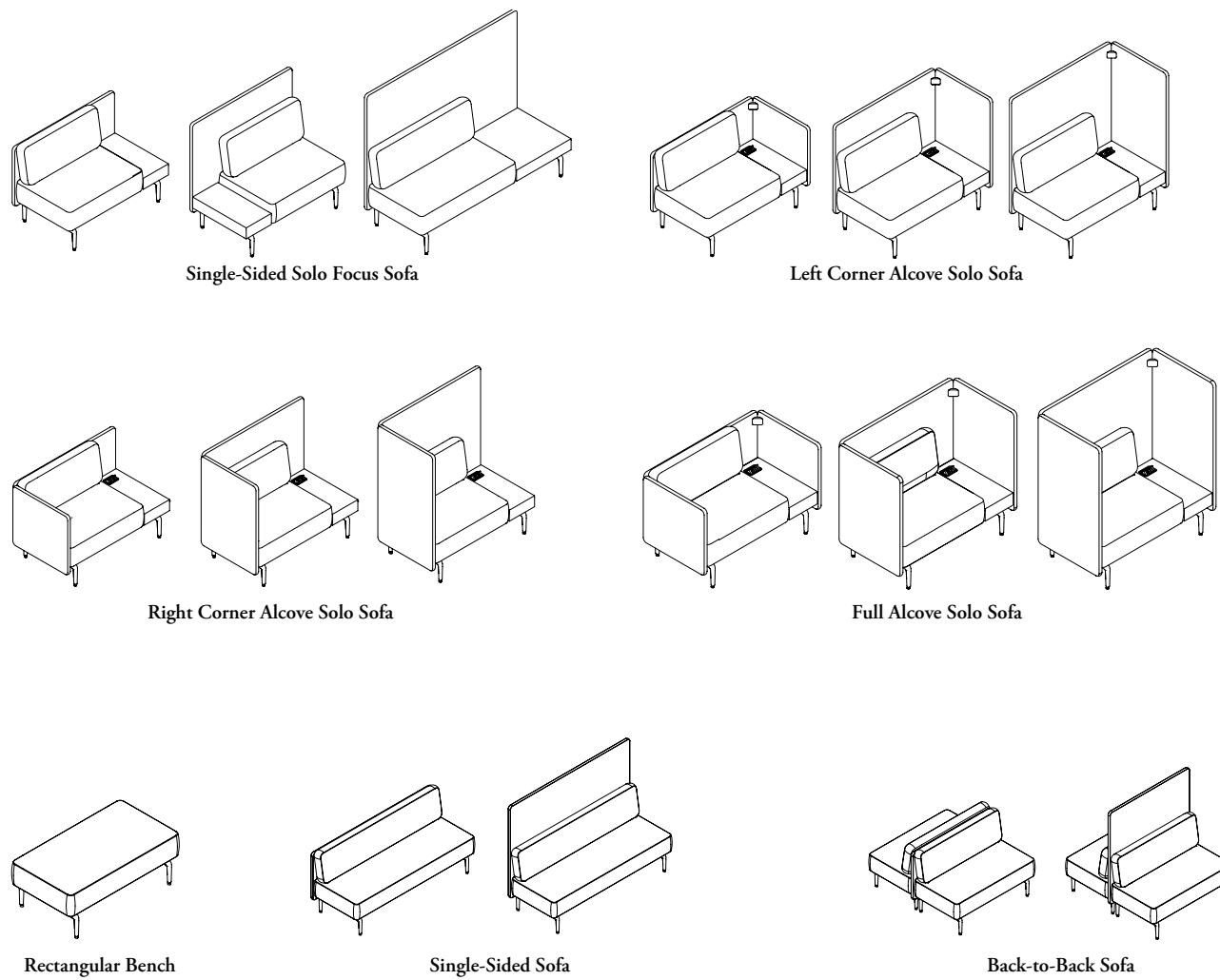

product map (continued)

Banqs (Continued)

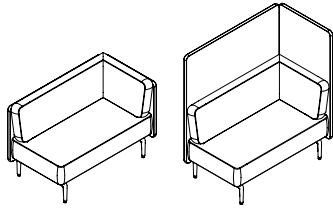

Corner Alcove Solo Sofa

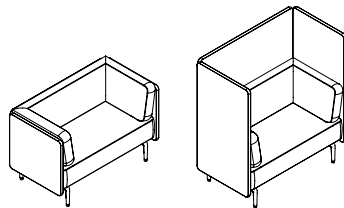

Full Alcove Sofa

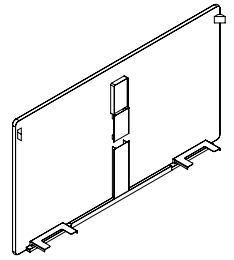

High Spanninh Screen

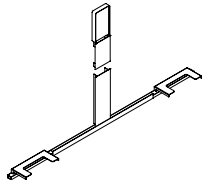

Digital Share Wall Mount Integration Kit

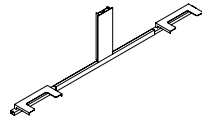

Wire Management Kit for Table with Power Pill at Architectural Wall

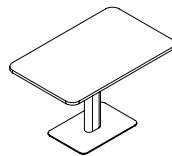

Table with Flat Base

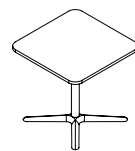
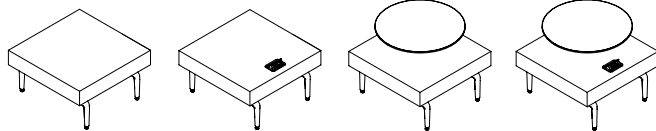
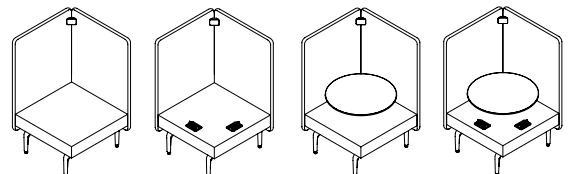

Table with Four-Prong Base



Freestanding Occasional Table



Freestanding Occasional Table with Screen



Untethered Cushion



Repositionable Coat Hook

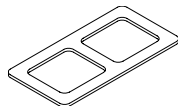

Ganging Plate



Ganging Kit

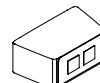

Sofa Undermount Power

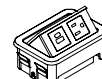

Small Power Flip

product map (continued)

Belize

Pages 462

side panel options



No Accessories

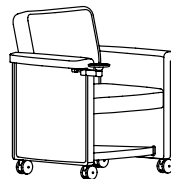

With Cup Holder



With Tablet



With Tablet and Cup Holder



Upholstered



Foundation Laminate

Bonds

Pages 484

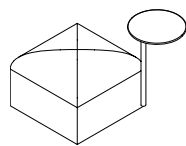

Freestanding Single Block

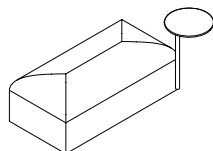

Freestanding Double Block

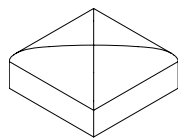

Building Block Seat Not Strap Compatible

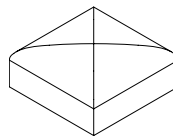

Building Block Seat Strap Compatible

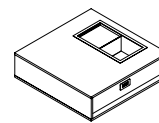

Building Block Table - Square

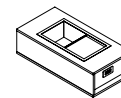

Building Block Table - Rectangular

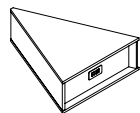

Building Block Table - Triangular

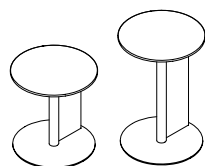

Auxiliary Table

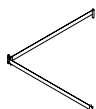

Strap Kit



Ganging Kit

Collaborative Ottoman

Pages 511

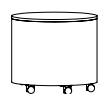

Small Round Teknion dna Height Ottoman



Medium Round Teknion dna Height Ottoman



Small Round Lounge Height Ottoman

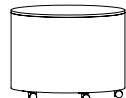

Medium Round Lounge Height Ottoman

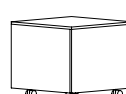

Small Square Teknion dna Height Ottoman

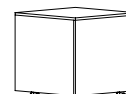

Small Square Lounge Height Ottoman

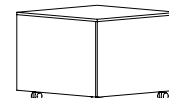

Medium Square Lounge Height Ottoman

product map (continued)

Teknion dna

Pages 530

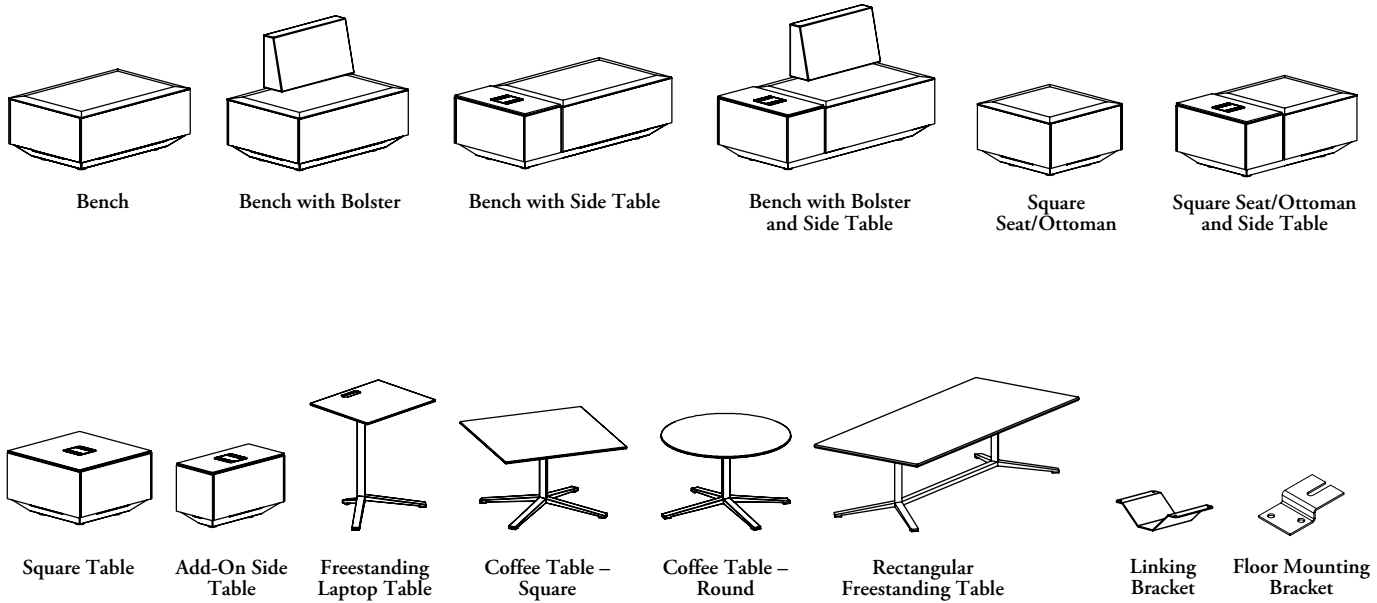

Ferrarra

Pages 539

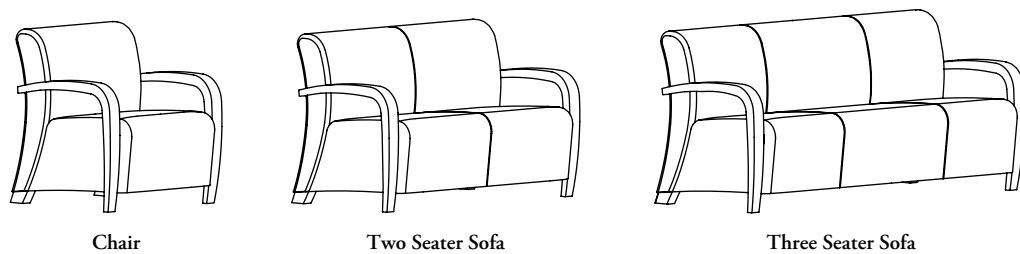

Tux

Pages 541

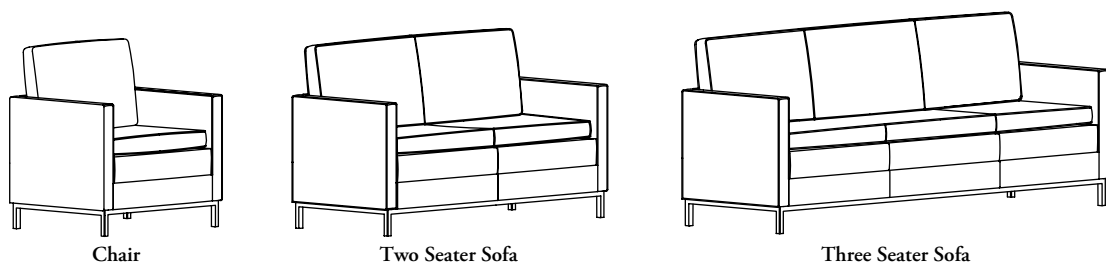

product map (continued)

Vasari

Pages 543

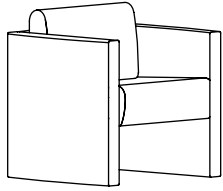

Chair

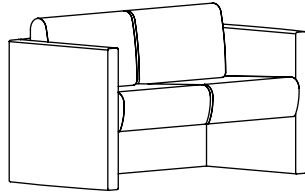

Two Seater Sofa

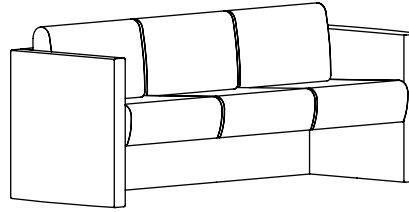

Three Seater Sofa



Tray

Vignette

Pages 547

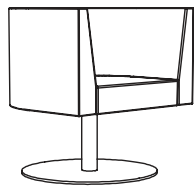

Swivel Lounge Chair

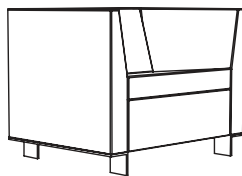

Cube Lounge Chair

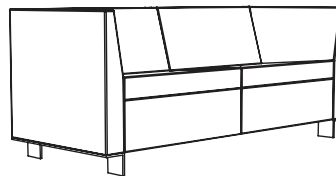

Two Seater Sofa

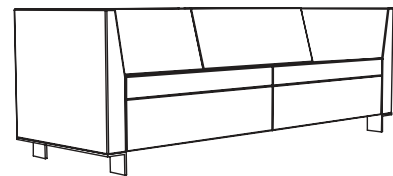

Three Seater Sofa

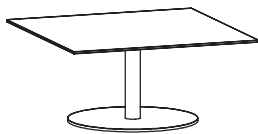

Coffee Table – Square

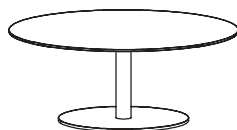

Coffee Table – Round

aegis dimensions & material requirements

statement of line

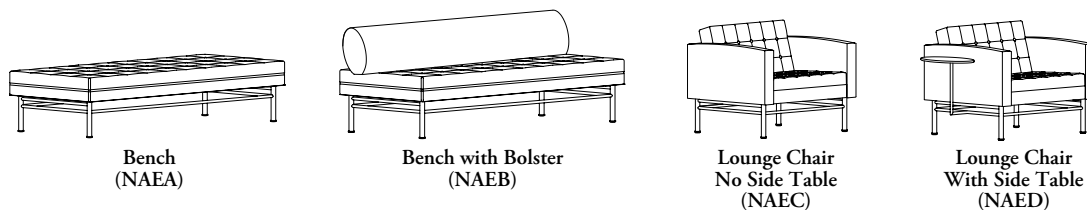

features

- Designed and tested for users up to 250 lbs

weight

Lounge Chair	107 lbs
Lounge Chair with Side Table	120 lbs
Bench	126 lbs
Bench with Bolster	148 lbs

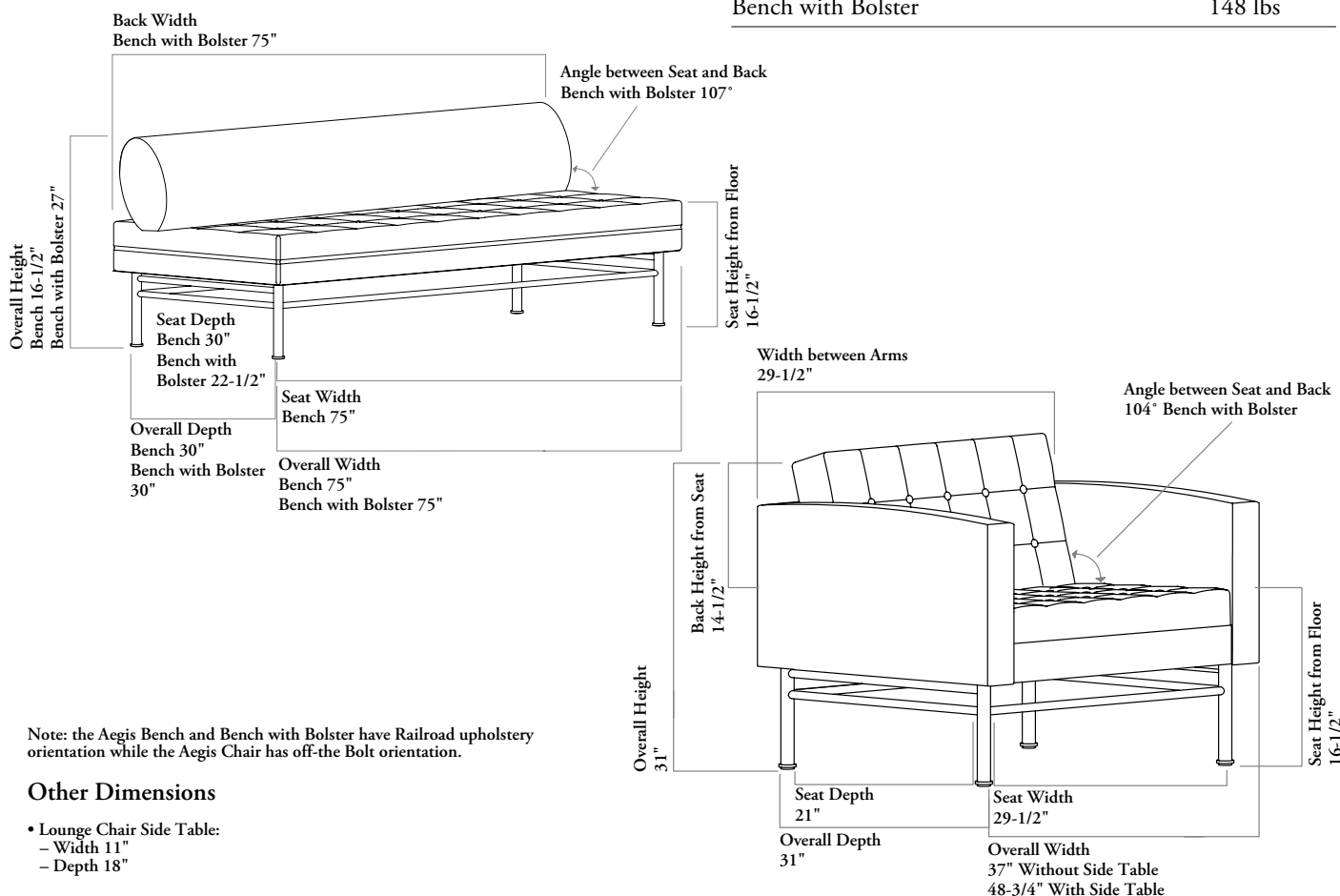

Note: the Aegis Bench and Bench with Bolster have Railroad upholstery orientation while the Aegis Chair has off-the Bolt orientation.

Other Dimensions

- Lounge Chair Side Table:
 - Width 11"
 - Depth 18"

COM/COL material requirement

The pattern, repeat and directionality of fabric may increase the amount of yardage required.

Leather quantities should always be rounded up to the next hide size, as yields vary from 60-80% and are affected by the quality, size and shape of the hide, and by the location and quantity of blemishes.

	COM [yards]	COL [sq. ft]
Bench	4.75	85
Bench with Bolster	5	90
Chair	5	90

soft seating

NAE

Aegis – Lounge Bench

FEATURES

Multi-surface glides.

NOTES

Standard Upholstery orientation is Railroaded. If Off-the-Bolt orientation is desired, a Special order that includes seams may be specified.

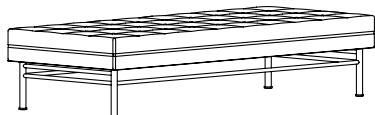

PRODUCT OPTIONS

Style	Upholstery Finish	Frame Finish
A Bench (Shown)	Fabric	E Ebony
B Bench with Bolster	Leather	C Chrome

SAMPLE ORDER CODE

NAE B	L204	C
--------------	-------------	----------

STYLE

Bench
Bench with Bolster
Bench
Bench with Bolster

PRICE

Grade 1	COM/ Grade 2	COL/ Grade 3	Grade 4	Grade 5	Grade 6	Grade 7	Grade 8	Grade 9	Grade 10
3453	3662	3878	4083	4292	4502	4711	4921	5130	5859
4603	4826	5044	5266	5486	5708	5928	6150	6370	7136
Leather LA	Leather LB	Leather LC	Leather LD						
5859	6211	7380	7770						
7136	7520	8757	9169						

If Chrome Frame (C) is specified add 542

FEATURES

Multi-surface glides

NOTES

Side table configuration is determined from a seated position.

Side table is oval shaped with 18" by 11" dimensions.

Leather LD is **not** available on the Side Table.

Standard Upholstery orientation is Off-the-Bolt.

NAE

Aegis – Lounge Chair

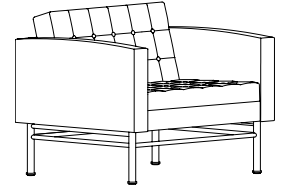

PRODUCT OPTIONS

Style	Side Table Configuration (Optional)	Upholstery Finish	Frame Finish	Side Table Finish (If applicable)
C No Side Table (Shown)	L Left side of chair	Fabric	E Ebony	Leather
D With Side Table	R Right side of chair	Leather	C Chrome	COL

SAMPLE ORDER CODE

NAE C		L104	C	
--------------	--	-------------	----------	--

STYLE

PRICE

	Grade 1	COM/ Grade 2	COL/ Grade 3	Grade 4	Grade 5	Grade 6	Grade 7	Grade 8	Grade 9	Grade 10
Chair	3069	3293	3509	3731	3950	4174	4393	4616	4834	5603
Chair with Side Table	3453	3676	3894	4117	4336	4558	4778	4998	5218	5987
		Leather LA	Leather LB	Leather LC	Leather LD					
Chair	5603	5986	7222	7633						
Chair with Side Table	5987	6370	7606	8017						

If Chrome Frame (C) is specified		add	542
If Side Table is specified in	Leather LA	add	169
	Leather LB	add	202
	Leather LC	add	302

what is banqs

Banqs is a destination for collaboration, focus work, and socialization.

As mindsets shift around what constitutes a positive work experience, Banqs has taken a holistic approach to help workplaces adapt to new patterns.

Work, and where it is being performed, has become increasingly agile. The Banqs portfolio provides the flexibility you need to meet the moment.

Whether that means connecting one-on-one offline, doing heads-down work that requires a certain level of privacy, or making the most out of in-between moments to catch up with your colleagues, Banqs' comprehensive system of screens, tables, and modular sofas transform under-utilized real estate into effective places to collaborate, socialize, and focus.



meeting space

Banqs can be configured into well equipped, functional meeting spaces with an A/V integrated High Spanning Screen, complete with monitor mount and cable management feature in combination with power integrated tables and modular Banqs sofas.



collaborative/socialization space

Create inviting collaborative spaces with Banqs Two-Seater and Three-Seater sofas and their wide range of screen configurations.

Sofas can be configured into linear or L-shape layouts along perimeter walls to create informal meeting spaces in under-utilized areas.

They can also be configured into X-shape or T-Shaped settings in more centralized areas to encourage spontaneous gathering and social interactions.

Banqs offers a selection of freestanding occasional tables and task height tables to help complete these multi-purpose settings.



focus space

Provide access to touchdown spaces with Banqs' Solo Focus Sofas.









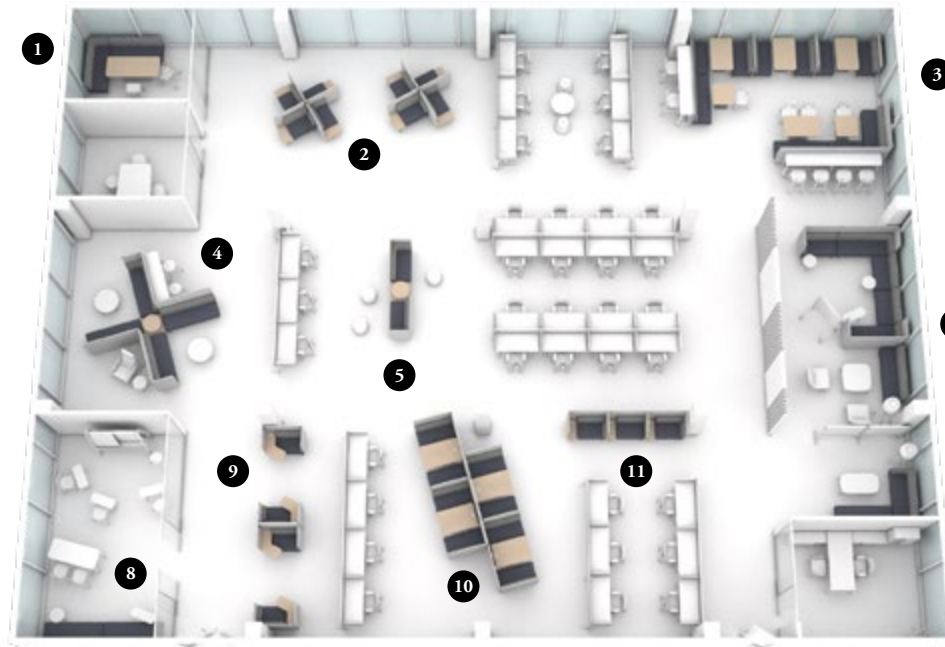

The Solo Focus is a generous One-Seater sofa that comes complete with work surface, optional power, and USB integration.

A choice of three worksurface styles offers a wide range of focus modes; from heads-down work to a private place to take a call, to a place to gather your thoughts in between meetings.

planning with banqs

Banqs addresses the need for meeting, collaborative/socialization and focus spaces throughout a floorplan.



- | | | | |
|--|--|---|---|
|  <p>1 Meeting Space
• L-Shaped Planning</p> |  <p>2 Focus Space
• Pinwheel Planning</p> |  <p>3 Socialization Space
• L-Shaped and Linear Planning</p> |  <p>4 Socialization Space
• Pinwheel Planning</p> |
|  <p>5 Collaborative Space
• Reverse Planning</p> |  <p>6 Collaborative/Socialization Space
• L-Shaped and U-Shaped Planning</p> |  <p>7 Focus Space
• L-Shaped Planning</p> |  <p>8 Meeting Space
• Linear Planning</p> |
|  <p>9 Focus Space
• Linear Planning</p> |  <p>10 Meeting Space
• Linear Planning</p> |  <p>11 Focus Space
• Linear Planning</p> | |

See the Teknion Planning Tool for further thought starters.

planning with banqs (continued)

Banqs seating components are designed on a 24" wide planning module and allow for a generous and comfortable seat for the individual. Unlimited configurations can be created with Banqs seating that address the needs of today's workplace and end users.

Linear Planning



L-Shaped Planning



U-Shaped Planning



X-shaped Planning



T-shaped Planning



Pinwheel Planning



Reverse Planning

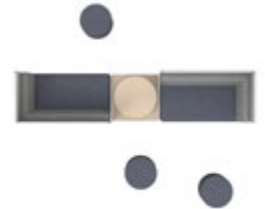

Banqs screens are available in three heights which provides different levels of privacy to a setting.

No back



Low Screen (33" high)



Medium Screen (44" high)



High Screen (55" high)



Combining various components and heights allows for multiple functions within a layout.



banqs fabrics and finishes

Banqs is available in a large variety of fabrics and finishes, allowing users to create unique looks.

Banqs sofas can be specified in single or triple upholstery.

- Single upholstery: Entire sofa is one fabric
- Triple upholstery: Each component (screen/bolster/seat) in a different fabric

Banqs legs are available in metal or wood options.

- Metal Leg finish: Foundation, Mica or Accent paints
- Wood Leg finish: N56 stains

All Teknion fabrics and leathers can be used on Banqs seating.

See the Teknion Fabrics and Finish guide for all available finishes.

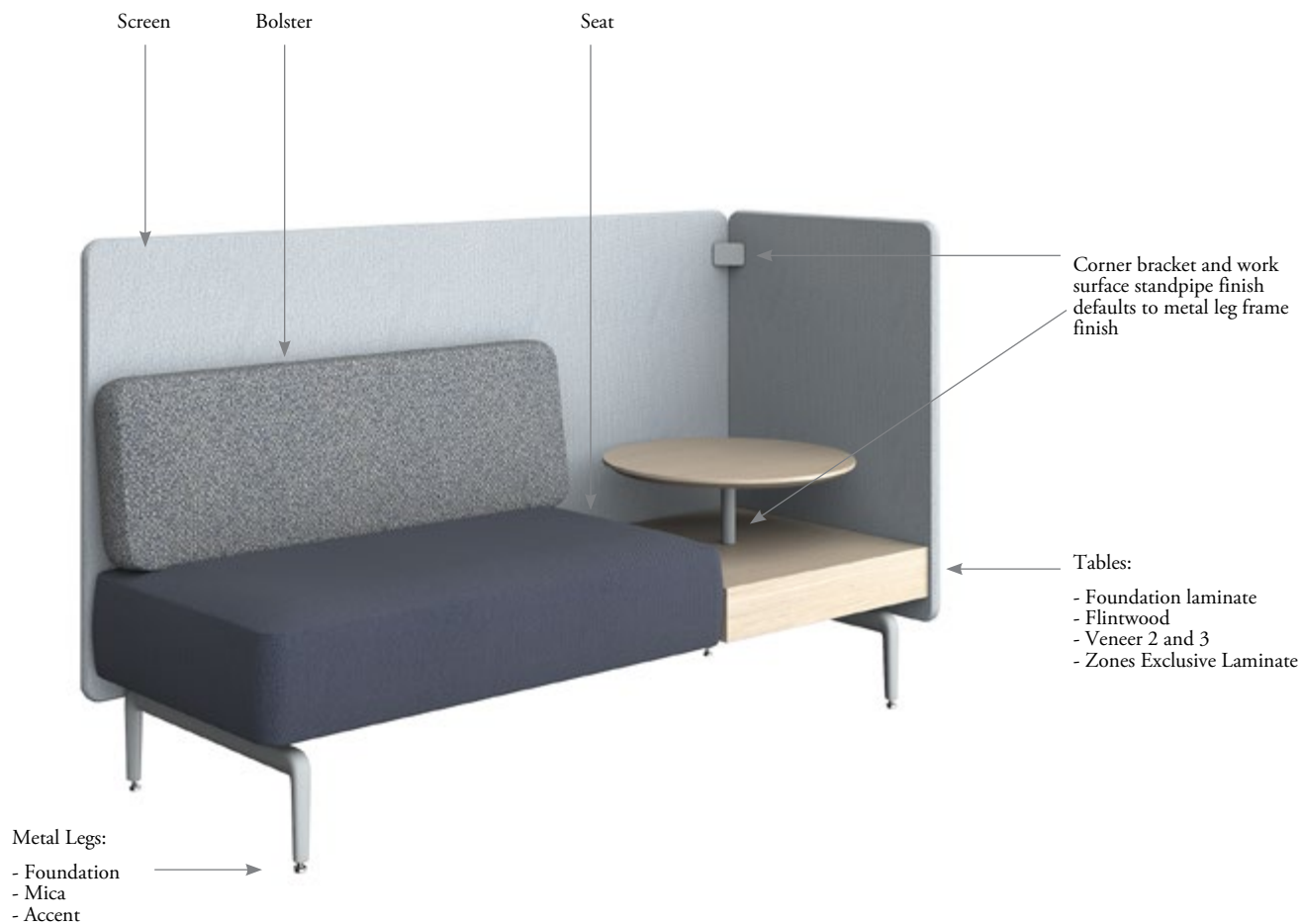

banqs fabrics and finishes (continued)

banqs wood leg finishes

Wood Leg Finish	Sierra (DV)	Natural White Oak (LZ)	Natural Pecan (LV)	Poppy Seed (5P)	Silverwash (5S)	Drift Oak (5W)	Anthracite (1U)	Atrium White (1S)	Midnight (1L)	Herbal (1F)	TK Hunter (1E)	Brickstone (1D)
Default Finish*	Burnished Bronze (71/2)	Foundry Onyx (Z/23)	Gilded Ash (73/1)	Anthracite (68/X)	Titanium Grey (72/F)	Sand (27/3)	Anthracite (68/X)	Atrium White (T/20)	Ink Blue (17)	Herbal (CP)	TK Hunter (1V)	Brickstone (18)

*Corner bracket and work surface standpipe finish will co-ordinate to Wood Leg Finish selected.

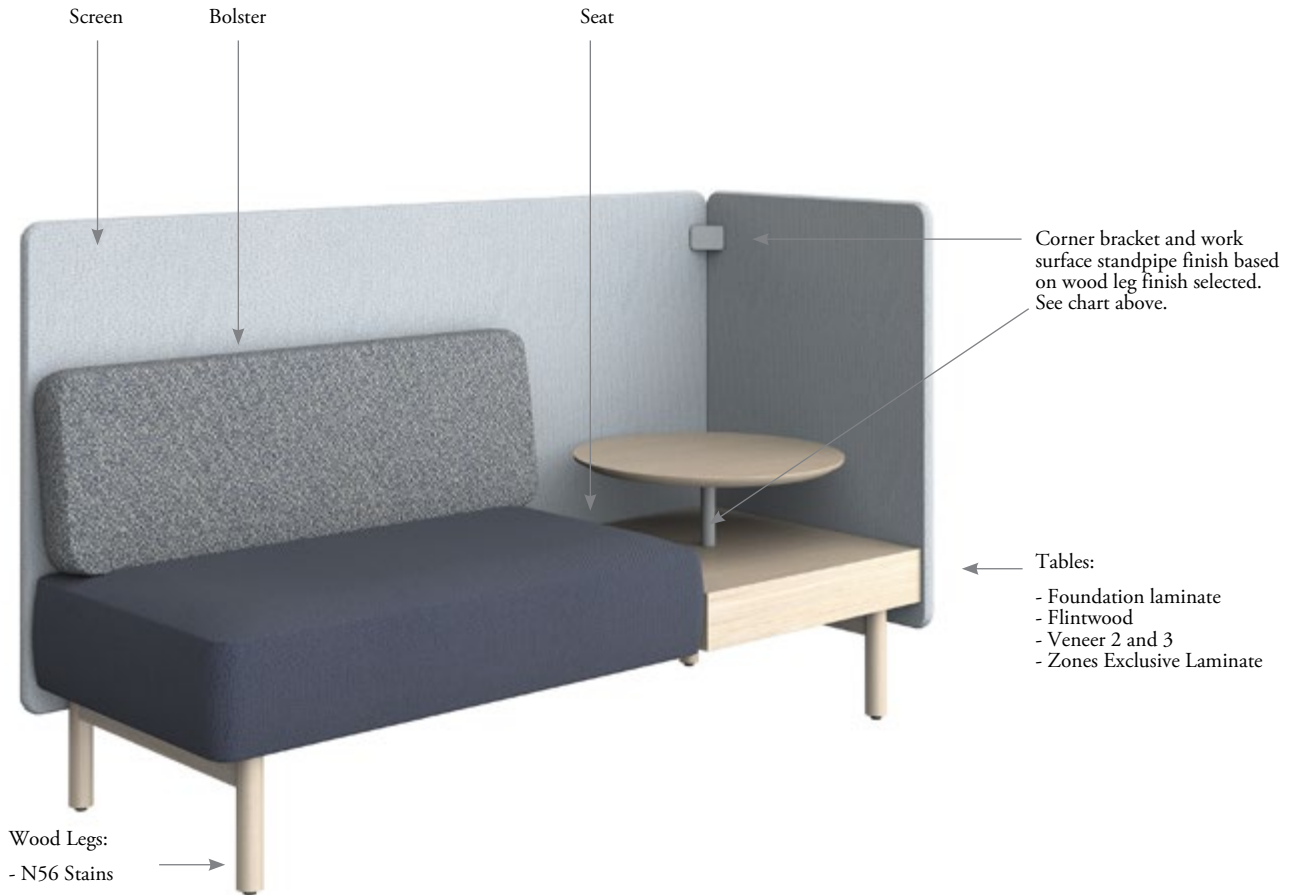

banqs fabrics and finishes (continued)

Banqs legs are available in metal or wood options:

- Metal Leg finish: Foundation, Mica or Accent paints
- Wood Leg finish: N56 stains

banqs metal and wood leg code overview

	With Metal Legs	With Wood Legs
Banqs Single Sided Solo Focus	NBS	NBM
Banqs Left Corner Alcove Solo Focus Sofa	NBL	NBN
Banqs Right Corner Alcove Solo Focus Sofa	NBR	NBO
Banqs Full Alcove Solo Focus Sofa	NBF	NBP
Banqs Rectangular Bench, No Back	NBAR	NBWR
Banqs Single-Sided Sofa	NBAS	NBWS
Banqs Back-To-Back Sofa	NBAB	NBWB
Banqs Corner Alcove Sofa	NBAC	NBWC
Banqs Full Alcove Sofa	NBAF	NBWF
Banqs Freestanding Occasional Table	NBAH	NBWH
Banqs Freestanding Occasional Table with Screens	NBAL	NBWL



Metal Leg



Wood Leg

banqs fabrics and finishes (continued)

achievable looks

The ability for Banqs to use one, two or three fabrics provides the opportunity to create many different looks from soft and neutral to bold and contrasting.



Single upholstery
(same fabric on seats, bolsters and screens)

Paint: Soft Gris
Laminate: Soft Gris, Coastal Elm
Chair Veneer: Drift Oak
Fabric: Bitstream Grey Code (Banqs)
Haptic Flood Plain (pillows)

Legs: Wood, Brickstone
Laminate: Sand
Chairs Veneer: Brickstone
Fabric: Photogram Haliograph (seats and bolsters) Flex Wool Blur (screens)
Wavefield Red Tide (pillows)



Triple upholstery:
(same fabric on seats and bolsters, contrasting fabric on screens)

Paint: Blush
Laminate: Sand
Chair Veneer: Brickstone
Fabric: Photogram Haliograph (seats and bolsters)
Flex Wool Blur (screens)
Wavefield Red Tide (pillows)

Legs: Wood, Brickstone
Laminate: Sand
Chairs Veneer: Brickstone
Fabric: Photogram Haliograph (seats and bolsters) Flex Wool Blur (screens)
Wavefield Red Tide (pillows)



Triple upholstery:
(different fabric on seats, bolsters and screens)

Paint: Ink Blue
Laminate: Ivory Birch
Chair Veneer: Midnight
Fabric: Bitstream Blue Team (seats)
Crossgrain Underbrush (bolsters)
Mitered Black Walnut (screens)
Victor Parallax (pillows)

Legs: Wood, Brickstone
Laminate: Sand
Chairs Veneer: Brickstone
Fabric: Photogram Haliograph (seats and bolsters) Flex Wool Blur (screens)
Wavefield Red Tide (pillows)

banqs product offering

Banqs consists of the following components.



Left Justified
with Standard Table
(NBSLSLC) (shown)
Right Justified with
Standard Table
(NBSL SRC)



Left Justified
with Box Storage
(NBSLSLD) (shown)
Right Justified with
Box Storage
(NBSLSRD)



Left Justified
with Boomerang Table
(NBSLSLE) (shown)
Right Justified with
Boomerang Table
(NBSLSRE)



Left Justified
with Standard Table
(NBSMSLC) (shown)
Right Justified with
Standard Table
(NBSMSRC)



Left Justified
with Box Storage
(NBSMSLD) (shown)
Right Justified with
Box Storage
(NBSMSRD)



Left Justified
with Boomerang Table
(NBSMSLE) (shown)
Right Justified with
Boomerang Table
(NBSMSRE)



Left Justified
with Standard Table
(NBSHSLE) (shown)
Right Justified with
Standard Table
(NBSHSRC)



Left Justified
with Box Storage
(NBSHSLD) (shown)
Right Justified with
Box Storage
(NBSHSRD)



Left Justified
with Boomerang Table
(NBSHSLE) (shown)
Right Justified with
Boomerang Table
(NBSHSRE)



Left Justified
with Standard Table
(NBSLWLF) (shown)
Right Justified with
Standard Table
(NBSLWRF)



Left Justified
with Dual Table
(NBSLWLG) (shown)
Right Justified with
Dual Table
(NBSLWRG)



Left Justified
with Standard Table
(NBSMWLF) (shown)
Right Justified with
Standard Table
(NBSMWRF)



Left Justified
with Dual Table
(NBSMWLG) (shown)
Right Justified with
Dual Table
(NBSMWRG)



Left Justified
with Standard Table
(NBSHWLF) (shown)
Right Justified with
Standard Table
(NBSHWRF)



Left Justified
with Dual Table
(NBSHWLG) (shown)
Right Justified with
Dual Table
(NBSHWRG)

banqs product offering (continued)



Left Justified
with Standard Table
(NBLLSLC) (shown)
Right Justified with
Standard Table
(NBRLSLC)



Left Justified
with Box Storage
(NBLLSLD) (shown)
Right Justified with
Box Storage
(NBRLSLD)



Left Justified
with Boomerang Table
(NBLLSLE) (shown)
Right Justified with
Boomerang Table
(NBRLSLE)



Left Justified
with Standard Table
(NBLMSLC) (shown)
Right Justified with
Standard Table
(NBRMSLC)



Left Justified
with Box Storage
(NBLMSLD) (shown)
Right Justified with
Box Storage
(NBRMSLD)



Left Justified
with Boomerang Table
(NBLMSLE) (shown)
Right Justified with
Boomerang Table
(NBRMSLE)



Left Justified
with Standard Table
(NBLHSLC) (shown)
Right Justified with
Standard Table
(NBRHSLC)



Left Justified
with Box Storage
(NBLHSLD) (shown)
Right Justified with
Box Storage
(NBRHSLD)



Left Justified
with Boomerang Table
(NBLHSLE) (shown)
Right Justified with
Boomerang Table
(NBRHSLE)



Left Justified
with Standard Table
(NBLWLF) (shown)
Right Justified with
Standard Table
(NBRLWLF)



Left Justified
with Dual Table
(NBLWLWG) (shown)
Right Justified with
Dual Table
(NBRLWLWG)



Left Justified
with Standard Table
(NBLMWLF) (shown)
Right Justified with
Standard Table
(NBRMWLF)



Left Justified
with Dual Table
(NBLMWLG) (shown)
Right Justified with
Dual Table
(NBRMWLG)



Left Justified
with Standard Table
(NBLHWLF) (shown)
Right Justified with
Standard Table
(NBRHWLF)



Left Justified
with Dual Table
(NBLHWLG) (shown)
Right Justified with
Dual Table
(NBRHWLG)

banqs product offering (continued)



Left Justified
with Standard Table
(NBFLSLC) (shown)
Right Justified with
Standard Table
(NBFLSRC)



Left Justified
with Box Storage
(NBFLSLD) (shown)
Right Justified with
Box Storage
(NBFLSRD)



Left Justified
with Boomerang Table
(NBFLSLE) (shown)
Right Justified with
Boomerang Table
(NBFLSRE)



Left Justified
with Standard Table
(NBFMSLC) (shown)
Right Justified with
Standard Table
(NBFMSRC)



Left Justified
with Box Storage
(NBFMSLD) (shown)
Right Justified with
Box Storage
(NBFM SRD)



Left Justified
with Boomerang Table
(NBFM SLE) (shown)
Right Justified with
Boomerang Table
(NBFM SRE)



Left Justified
with Standard Table
(NBFHSLC) (shown)
Right Justified with
Standard Table
(NBFH SRC)



Left Justified
with Box Storage
(NBFHSLD) (shown)
Right Justified with
Box Storage
(NBFH SRD)



Left Justified
with Boomerang Table
(NBFH SLE) (shown)
Right Justified with
Boomerang Table
(NBFH SRE)



Left Justified
with Standard Table
(NBFLWLF) (shown)
Right Justified with
Standard Table
(NBFLWRF)



Left Justified
with Dual Table
(NBFLWLG) (shown)
Right Justified with
Dual Table
(NBFLWRG)



Left Justified
with Standard Table
(NBFMWLF) (shown)
Right Justified with
Standard Table
(NBFMWRF)



Left Justified
with Dual Table
(NBFMWLG) (shown)
Right Justified with
Dual Table
(NBFMWRG)



Left Justified
with Standard Table
(NBFWLF) (shown)
Right Justified with
Standard Table
(NBFWRF)



Left Justified
with Standard Table
(NBFWLF) (shown)
Right Justified with
Standard Table
(NBFWRF)

banqs product offering (continued)



2-Seat
(NBAR2)



3-Seat
(NBAR3)



Low Screen, 2-Seat
(NBASL2)



Low Screen, 3-Seat
(NBASL3)



Medium Screen,
2-Seater (NBASM2)



Medium Screen,
3-Seater (NBASM3)



High Screen, 2-Seat
(NBASH2)



High Screen, 3-Seat
(NBASH3)



Low Screen 2-Seater
(NBABL2)



Low Screen 3-Seater
(NBABL3)



Medium Screen, 2-Seater
(NBABM2)



Medium Screen, 3-Seater
(NBABM3)



High Screen 2-Seater
(NBABH2)



High Screen 3-Seater
(NBABH3)



Low Screen 2-Seater
(NBACL2)



Low Screen 3-Seater
(NBACL3)



Medium Screen, 2-Seater
(NBACM2)



Medium Screen, 3-Seater
(NBACM3)



High Screen 2-Seater
(NBACH2)



High Screen 3-Seater
(NBACH3)

banqs product offering (continued)



Low Screen, Small
(NBAFLS)



Low Screen, Medium
(NBAFLM)



Medium Screen, Small
(NBAFMS)



Medium Screen, Medium
(NBAFMM)



High Screen, Small
(NBAFHS)



High Screen, Medium
(NBAFHM)

banqs screens



Banqs High Spanning
Screen, Digital Share
& Worksurface
Electrics
(NBAZD)



Banqs High Spanning
Screen, Worksurface
Electrics only
(NBAZW)



Banqs High Spanning
Screen, No Electrical
Module
(NBAZN)

banqs wall mount kits



Banqs Digital
Share Wall Mount
Integration Kit
(NBAY)



Banqs Wire
Management Kit for
Table with Power Pill
at Architectural Wall
(NBAX)

banqs tables



Banqs Table with
Flat Base
(NBAT)



Banqs Table with
Flat Base
(NBAT)



Banqs Table with
4-Prong Base
(NBAU)



Banqs Freestanding
Occasional Table,
Single Tabletop
(NBAHS)



Banqs Freestanding
Occasional Table,
Dual Tabletop
(NBAHD)

banqs product offering (continued)



Banqs Freestanding Occasional Table with Screens, Single Tabletop, Low Screen (NBALSBL)



Banqs Freestanding Occasional Table with Screens, Dual Tabletop, Low Screen (NBALDBL)



Banqs Freestanding Occasional Table with Screens, Single Tabletop, Medium Screen (NBALSBM)



Banqs Freestanding Occasional Table with Screens, Dual Tabletop, Medium Screen (NBALDBM)



Banqs Freestanding Occasional Table with Screens, Single Tabletop, High Screen (NBALSBLH)



Banqs Freestanding Occasional Table with Screens, Dual Tabletop, High Screen (NBALDBLH)

banqs accessories



Banqs Untethered Cushion (NBAP)



Banqs Repositionable Coat Hook (NBAM)



Banqs Ganging Plate (NBAG)



Banqs Ganging Kit (NBAEP)

banqs power modules



Banqs Sofa Undermount Power (NBAA)



Banqs Small Power Flip (NBAJ)

understanding banqs seating

The following outlines the maximum recommended seating capacity for each bench or sofa.

Banqs Single-Sided Solo Focus Sofa

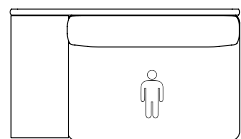

Standard

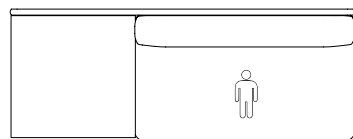

Wide

Banqs Corner Alcove Solo Focus Sofa (right corner shown)

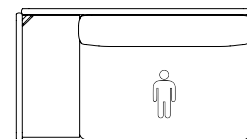

Standard

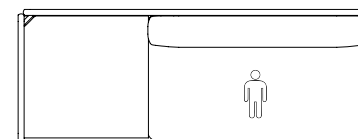

Wide

Banqs Full Alcove Solo Focus Sofa

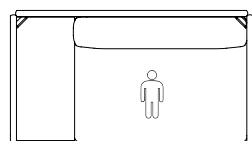

Standard

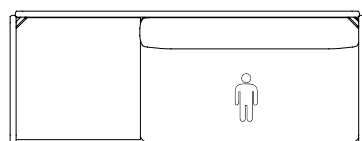

Wide

Banqs Rectangular Bench, No Back

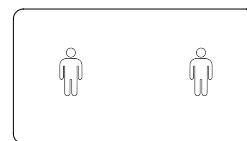

Two-Seater

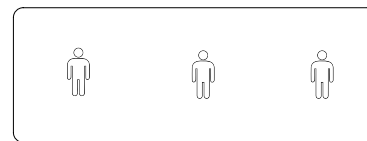

Three-Seater

Banqs Single-Sided Sofa

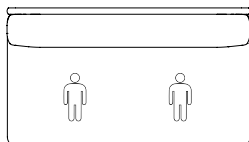

Two-Seater

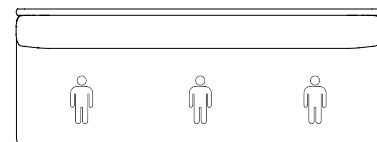

Three-Seater

Banqs Back-To-Back Sofas

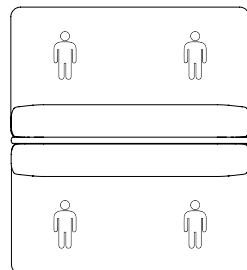

Two-Seater

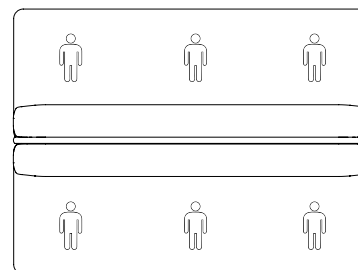

Three-Seater

Banqs Corner Alcove Sofa (right corner shown)

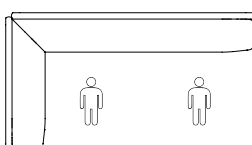

Two-Seater

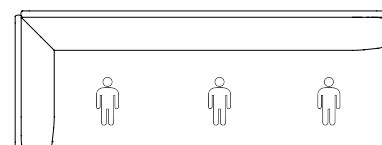

Three-Seater

Banqs Full Alcove Sofa

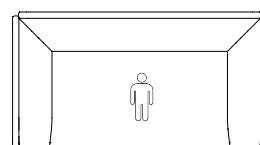

Small

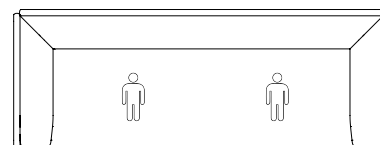

Medium

Single-Sided Sofas combined with Corner Alcove Sofas.

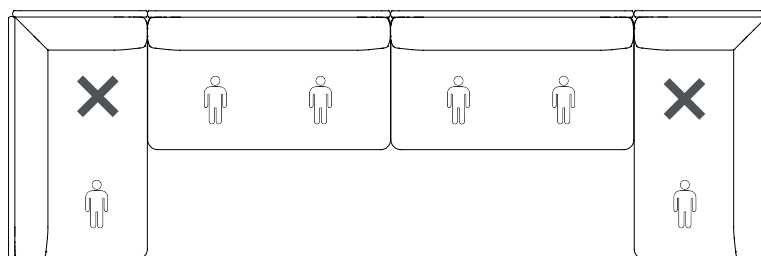
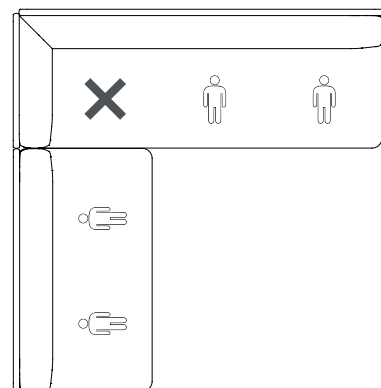

understanding banqs seating (continued)

The following should be considered when planning with Banqs electrical modules.

benches and sofas

Banqs benches and sofas are available with an optional electrical module below the seat.

The electrical module includes:

- 1 Simplex power
- 1 USB-A
- 1 USB-C
- 1 Power cord (Undermount Power 13' cord, Power Flip 10 cord')
- 1 Cable manager

Electrical modules mount 9" from the leg on either the left or right side.

Single Sided

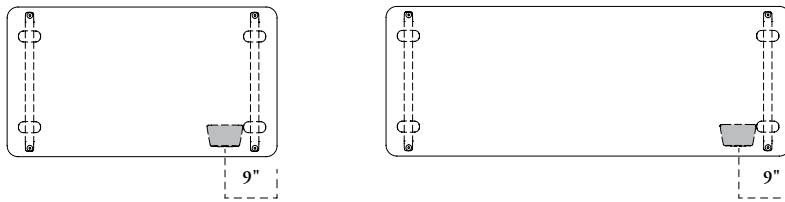

for all back-to-back sofas

- (2) electrical modules can be specified adjacent to leg, on either left or right side (from seated position) or
- (2) electrical modules can be specified adjacent to leg, mixed left and right side

Note: Factory installed undermount electrical modules are 9" from edge of sofa to centerline of module.

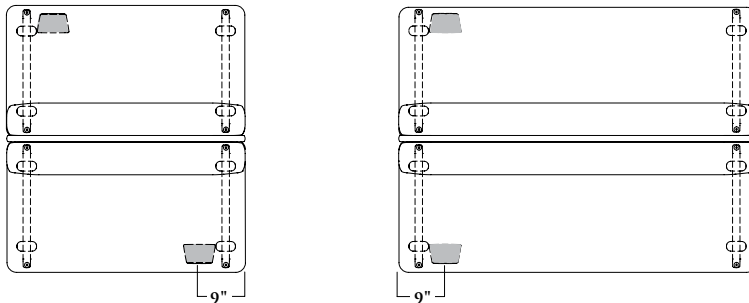

48" wide back-to-back sofa and electric module (left from seated position shown)

72" wide single-sided sofa and electric module (mixed right and left from seated position shown)

sofas focus sofas

Sofa Focus Sofas have an optional small power flip module on the table of the unit.

- If a power module is required under the sofa it must be specified separately

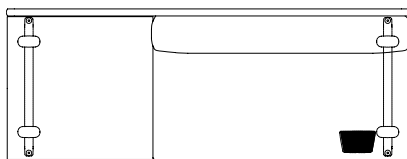

banqs single-sided solo focus, standard overview

Banqs Single-Sided Solo Focus Sofas address various visual, acoustic, and spatial privacy needs with three screen heights.

Can be used in stand alone applications or combined with other Banqs components to create linear, perpendicular, and pinwheel layouts for any environment.

Banqs Single-Sided Solo Focus, Standard (NBS)

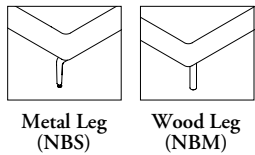

statement of line



banqs single-sided solo focus, standard dimensions & material requirements

construction notes

- Weight capacity of 300 lbs. per seat (ie. 2-Seater capacity is 600 lbs.)
- Conforms to BIFMA X5.4-2020 lounge seating standards

weight metal legs (add 7 lbs. for wood legs)

Single-Sided Solo Focus, Low Screen, Standard Table	108 lbs
Single-Sided Solo Focus, Low Screen, Box Storage	127 lbs
Single-Sided Solo Focus, Low Screen, Boomerang Table	132 lbs
Single-Sided Solo Focus, Medium Screen, Standard Table	123 lbs
Single-Sided Solo Focus, Medium Screen, Box Storage	142 lbs
Single-Sided Solo Focus, Medium Screen, Boomerang Table	147 lbs
Single-Sided Solo Focus, High Screen, Standard Table	133 lbs
Single-Sided Solo Focus, High Screen, Box Storage	152 lbs
Single-Sided Solo Focus, High Screen, Boomerang Table	157 lbs

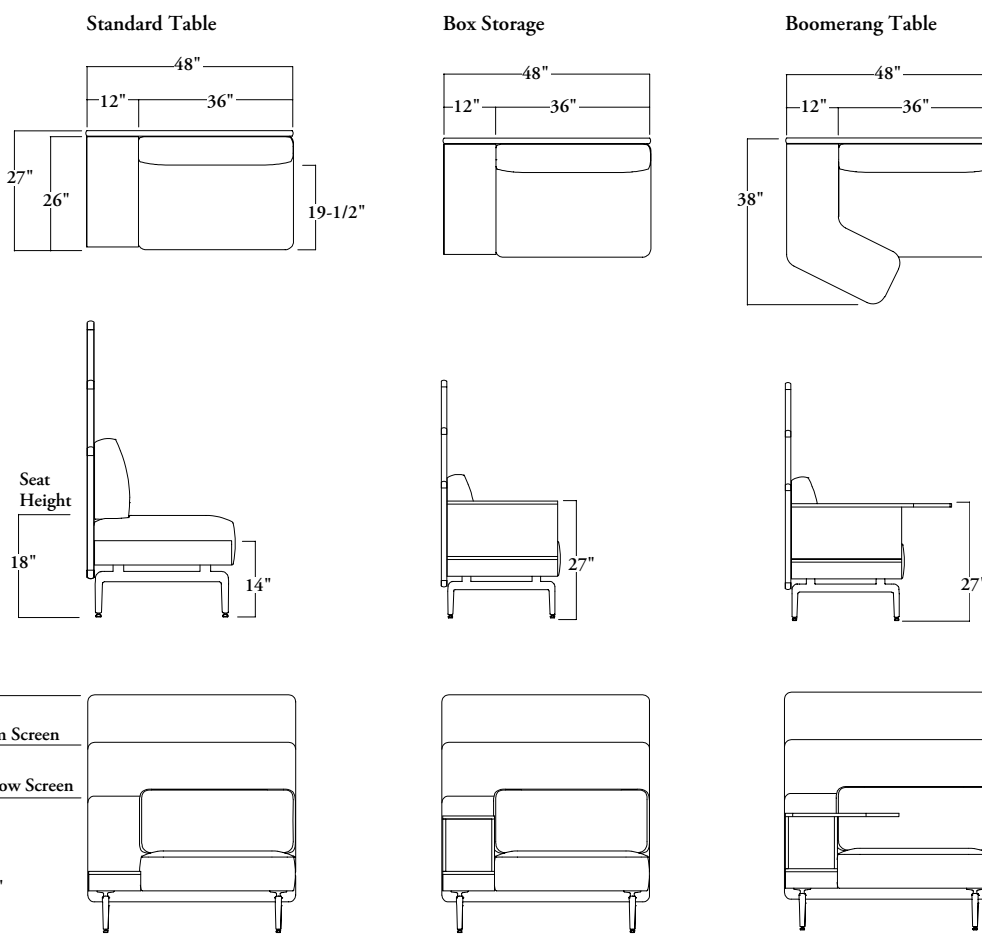

COM/COL material requirement

The pattern, repeat and directionality of fabric may increase the amount of yardage required.

Leather quantities should always be rounded up to the next hide size, as yields vary from 60-80% and are affected by the quality, size and shape of the hide, and by the location and quantity of blemishes.

	SEAT		BOLSTER		SCREEN	
	COM [yards]	COL [sq. ft]	COM [yards]	COL [sq. ft]	COM [yards]	COL [sq. ft]
Low Screen	2.25	38	1.75	30	1.75	30
Medium Screen	2.25	38	1.75	30	2.5	43
High Screen	2.25	38	1.75	30	3	51

banqs single-sided solo focus, wide overview

Banqs Single-Sided Solo Focus Sofas address various visual, acoustic, and spatial privacy needs with three screen heights.

Can be used in stand alone applications or combined with other Banqs components to create wider linear, perpendicular, and pinwheel layouts for any environment.

Banqs Single-Sided Solo Focus, Wide (NBS)

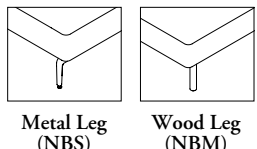

statement of line



banqs single-sided solo focus, wide dimensions & material requirements

construction notes

- Weight capacity of 300 lbs. per seat (ie. 2-Seater capacity is 600 lbs.)
- Conforms to BIFMA X5.4-2020 lounge seating standards

weight metal legs (add 7 lbs. for wood legs)

Single-Sided Solo Focus, Low Screen, Standard Table	156 lbs
Single-Sided Solo Focus, Low Screen, Dual Table	176 lbs
Single-Sided Solo Focus, Medium Screen, Standard Table	181 lbs
Single-Sided Solo Focus, Medium Screen, Dual Table	201 lbs
Single-Sided Solo Focus, High Screen, Standard Table	194 lbs
Single-Sided Solo Focus, High Screen, Dual Table	214 lbs

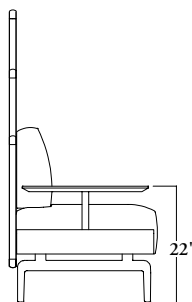
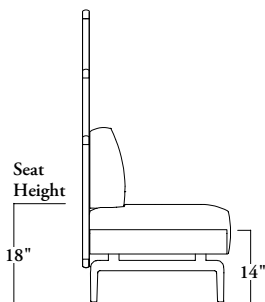
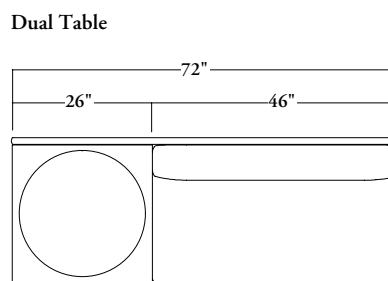
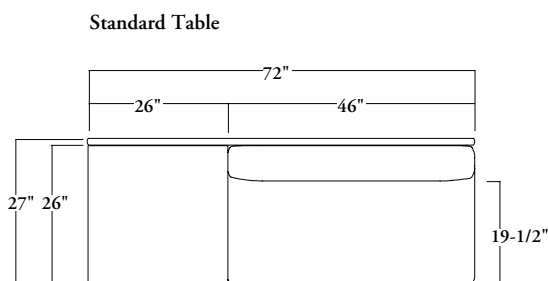

High Screen

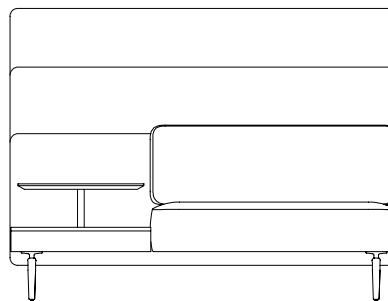
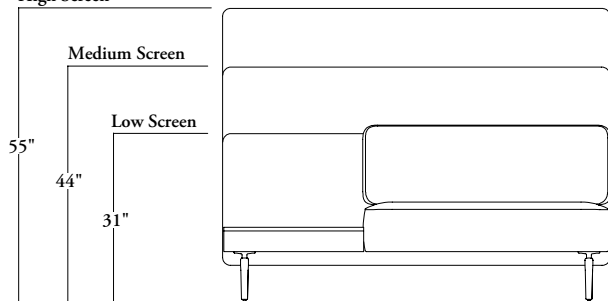

COM/COL material requirement

The pattern, repeat and directionality of fabric may increase the amount of yardage required.

Leather quantities should always be rounded up to the next hide size, as yields vary from 60-80% and are affected by the quality, size and shape of the hide, and by the location and quantity of blemishes.

	SEAT		BOLSTER		SCREEN	
	COM [yards]	COL [sq. ft]	COM [yards]	COL [sq. ft]	COM [yards]	COL [sq. ft]
Low Screen, wide	2.25	38	1.75	30	3.25	55
Medium Screen, wide	2.25	38	1.75	30	4.625	78
High Screen, wide	2.25	38	1.75	30	6	100

NBS / NBM

Banqs Single-Sided Solo Focus

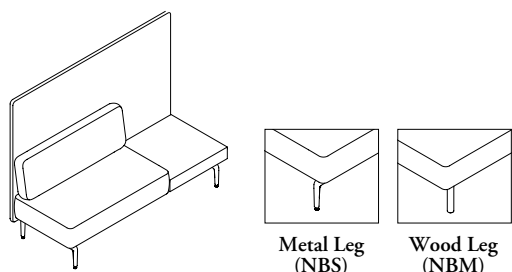

FEATURES

- Standard and wide options
- Legs available in Metal (NBS) or Wood (NBM)
- Available in single and triple upholstery
- Standard, box storage, and boomerang (standard width) and standard and dual (wide width) table options
- Optional small power flip available in black or white finish
- Ships fully assembled

NOTES

- Laminate/veneer finish applies to entire table
- Ganging plates and kits must be ordered separately for linear, perpendicular, or pinwheel applications
- Undermount electrical module must be specified as separate item (includes cable management)

PRODUCT OPTIONS

Screen Height	Sofa Size	Table Orientation	Table	Electrics
L Low Screen Height	S Standard	L Left (Shown)	C Standard (Standard Size Only)	N None
M Medium Screen Height	W Wide (shown)	R Right	D Box Storage (Standard Size Only)	B Small Power Flip Black
H High Screen Height (Shown)			E Boomerang (Standard Size Only)	W Small Power Flip White
			F Standard (Wide Size Only)	X Two Small Power Flip Black (Wide Side Only)
			G Dual (Wide Size Only)	Y Two Small Power Flip White (Wide Side Only)

SAMPLE ORDER CODE

NBS H	S	R	C	W
--------------	----------	----------	----------	----------

PRODUCT OPTIONS (CONTINUED)

Table Surface Finish	Seat Upholstery Finish	Bolster Upholstery Finish	Screen Upholstery Finish	Metal Leg Finish (if metal leg is specified)
Foundation Laminate	Fabric	Fabric	Fabric	Foundation
Flintwood	Leather	Leather	Leather	Mica
Natural Veneer				Accent
Zones Exclusive Laminate				Wood Leg Finish (if wood leg is specified)
				N56 Stain Finishes

SAMPLE ORDER CODE (CONTINUED)

LW	E515	E515	E515	24
-----------	-------------	-------------	-------------	-----------

See pricing on the following page.

NBS / NBM
Banqs Single-Sided Solo Focus
 (Continued)

DESCRIPTION

PRICE

LOW SCREEN (L)										
STANDARD SOFA (S)										
	COM/ Grade 1	COL/ Grade 2	Grade 3	Grade 4	Grade 5	Grade 6	Grade 7	Grade 8	Grade 9	Grade 10
Standard Table (C), None Electric (N)	5431	5562	5685	5773	5845	5916	6004	6091	6179	6273
Standard Table (C), Small Power Flip Black (B) / White (W)	6359	6490	6614	6701	6772	6844	6931	7018	7105	7202
Box Storage (D), None Electric (N)	5887	6017	6140	6228	6301	6371	6459	6546	6634	6728
Box Storage (D), Small Power Flip Black (B) / White (W)	6814	6946	7069	7156	7227	7300	7387	7474	7561	7657
Boomerang (E), None Electric (N)	5993	6124	6247	6335	6408	6477	6566	6653	6741	6835
Boomerang (E), Small Power Flip Black (B) / White (W)	6921	7052	7176	7263	7334	7405	7492	7579	7666	7764
	Grade 11	Grade 12	Grade 13	Grade 14	Grade 15	Grade 16	Grade 17	Grade 18	Grade 19	Grade 20
Standard Table (C), None Electric (N)	6379	6483	6589	6693	6799	6903	7009	7114	7219	7324
Standard Table (C), Small Power Flip Black (B) / White (W)	7307	7412	7517	7622	7727	7832	7937	8042	8148	8252
Box Storage (D), None Electric (N)	6834	6939	7044	7149	7253	7359	7463	7569	7675	7779
Box Storage (D), Small Power Flip Black (B) / White (W)	7763	7867	7973	8077	8183	8287	8393	8498	8603	8708
Boomerang (E), None Electric (N)	6940	7045	7150	7255	7360	7465	7570	7676	7780	7886
Boomerang (E), Small Power Flip Black (B) / White (W)	7868	7974	8078	8184	8288	8394	8499	8604	8709	8814
	Leather LA	Leather LB	Leather LC	Leather LD						
Standard Table (C), None Electric (N)	6760	6974	7456	7727						
Standard Table (C), Small Power Flip Black (B) / White (W)	7686	7901	8386	8654						
Box Storage (D), None Electric (N)	7215	7429	7912	8183						
Box Storage (D), Small Power Flip Black (B) / White (W)	8141	8357	8840	9108						
Boomerang (E), None Electric (N)	7322	7535	8018	8288						
Boomerang (E), Small Power Flip Black (B) / White (W)	8248	8462	8947	9215						
WIDE SOFA (W)										
	COM/ Grade 1	COL/ Grade 2	Grade 3	Grade 4	Grade 5	Grade 6	Grade 7	Grade 8	Grade 9	Grade 10
Standard Table (F), None Electric (N)	7236	7433	7619	7750	7858	7965	8096	8227	8358	8502
Standard Table (F), Small Power Flip Black (B) / White (W)	8164	8361	8547	8678	8785	8891	9024	9155	9286	9430
Dual Table (G), None Electric (N)	7591	7788	7974	8105	8213	8320	8451	8582	8713	8857
Dual Table (G), Small Power Flip Black (B) / White (W)	8519	8716	8902	9033	9140	9246	9379	9510	9641	9785
Standard Table (F), Two Small Power Flip Black (X) / White (Y)	9093	9289	9476	9606	9714	9819	9953	10083	10215	10359
Dual Table (G), Two Small Power Flip Black (X) / White (Y)	9448	9644	9831	9961	10069	10174	10308	10438	10570	10714
	Grade 11	Grade 12	Grade 13	Grade 14	Grade 15	Grade 16	Grade 17	Grade 18	Grade 19	Grade 20
Standard Table (F), None Electric (N)	8606	8712	8816	8922	9026	9132	9237	9341	9447	9551
Standard Table (F), Small Power Flip Black (B) / White (W)	9535	9640	9745	9850	9955	10061	10165	10271	10375	10481
Dual Table (G), None Electric (N)	8961	9067	9171	9277	9382	9486	9592	9696	9802	9906
Dual Table (G), Small Power Flip Black (B) / White (W)	9890	9995	10100	10205	10310	10416	10520	10626	10730	10836
Standard Table (F), Two Small Power Flip Black (X) / White (Y)	10463	10569	10673	10779	10884	10989	11094	11199	11304	11409
Dual Table (G), Two Small Power Flip Black (X) / White (Y)	10818	10924	11028	11134	11239	11344	11449	11554	11659	11764
	Leather LA	Leather LB	Leather LC	Leather LD						
Standard Table (F), None Electric (N)	9229	9550	10275	10679						
Standard Table (F), Small Power Flip Black (B) / White (W)	10156	10478	11203	11605						
Dual Table (G), None Electric (N)	9584	9905	10630	11034						
Dual Table (G), Small Power Flip Black (B) / White (W)	10511	10833	11558	11960						
Standard Table (F), Two Small Power Flip Black (X) / White (Y)	11084	11406	12132	12534						
Dual Table (G), Two Small Power Flip Black (X) / White (Y)	11439	11761	12487	12889						

Pricing and options are continued on the following pages.

NBS / NBM

Banqs Single-Sided Solo Focus
(Continued)

DESCRIPTION

PRICE

	MEDIUM SCREEN (L)									
	STANDARD SOFA (S)									
	Grade 1	COM/ Grade 2	COL/ Grade 3	Grade 4	Grade 5	Grade 6	Grade 7	Grade 8	Grade 9	Grade 10
Standard Table (C), None Electric (N)	5590	5721	5844	5932	6003	6075	6163	6250	6338	6432
Standard Table (C), Small Power Flip Black (B) / White (W)	6518	6649	6772	6859	6931	7003	7090	7178	7265	7360
Box Storage (D), None Electric (N)	6045	6177	6300	6388	6458	6531	6619	6706	6794	6888
Box Storage (D), Small Power Flip Black (B) / White (W)	6974	7104	7227	7314	7387	7458	7545	7633	7720	7815
Boomerang (E), None Electric (N)	6151	6283	6407	6494	6564	6636	6725	6812	6900	6994
Boomerang (E), Small Power Flip Black (B) / White (W)	7079	7211	7334	7421	7492	7564	7651	7740	7827	7922
	Grade 11	Grade 12	Grade 13	Grade 14	Grade 15	Grade 16	Grade 17	Grade 18	Grade 19	Grade 20
Standard Table (C), None Electric (N)	6538	6643	6748	6853	6958	7063	7168	7273	7379	7483
Standard Table (C), Small Power Flip Black (B) / White (W)	7465	7570	7676	7780	7886	7990	8096	8200	8306	8411
Box Storage (D), None Electric (N)	6992	7098	7204	7308	7414	7518	7624	7728	7833	7939
Box Storage (D), Small Power Flip Black (B) / White (W)	7920	8025	8130	8236	8340	8446	8550	8656	8760	8866
Boomerang (E), None Electric (N)	7099	7205	7309	7415	7519	7625	7729	7835	7940	8045
Boomerang (E), Small Power Flip Black (B) / White (W)	8027	8132	8237	8342	8447	8552	8657	8761	8867	8973
	Leather LA	Leather LB	Leather LC	Leather LD						
Standard Table (C), None Electric (N)	6917	7133	7617	7886						
Standard Table (C), Small Power Flip Black (B) / White (W)	7845	8060	8545	8813						
Box Storage (D), None Electric (N)	7372	7589	8071	8340						
Box Storage (D), Small Power Flip Black (B) / White (W)	8301	8514	9000	9268						
Boomerang (E), None Electric (N)	7479	7694	8178	8447						
Boomerang (E), Small Power Flip Black (B) / White (W)	8407	8621	9106	9374						
	WIDE SOFA (W)									
	Grade 1	COM/ Grade 2	COL/ Grade 3	Grade 4	Grade 5	Grade 6	Grade 7	Grade 8	Grade 9	Grade 10
Standard Table (F), None Electric (N)	7448	7646	7831	7962	8069	8177	8308	8440	8570	8714
Standard Table (F), Small Power Flip Black (B) / White (W)	8375	8572	8758	8889	8997	9104	9236	9366	9497	9641
Dual Table (G), None Electric (N)	7803	8001	8186	8317	8424	8532	8663	8795	8925	9069
Dual Table (G), Small Power Flip Black (B) / White (W)	8730	8927	9113	9244	9353	9459	9591	9721	9853	9996
Standard Table (F), Two Small Power Flip Black (X) / White (Y)	9304	9502	9687	9817	9926	10033	10164	10295	10426	10570
Dual Table (G), Two Small Power Flip Black (X) / White (Y)	9659	9857	10042	10172	10281	10388	10519	10650	10781	10925
	Grade 11	Grade 12	Grade 13	Grade 14	Grade 15	Grade 16	Grade 17	Grade 18	Grade 19	Grade 20
Standard Table (F), None Electric (N)	8818	8924	9029	9134	9239	9344	9449	9554	9659	9765
Standard Table (F), Small Power Flip Black (B) / White (W)	9746	9851	9956	10062	10166	10272	10376	10482	10586	10692
Dual Table (G), None Electric (N)	9173	9279	9384	9489	9594	9699	9804	9909	10014	10120
Dual Table (G), Small Power Flip Black (B) / White (W)	10101	10207	10311	10417	10521	10627	10731	10837	10942	11047
Standard Table (F), Two Small Power Flip Black (X) / White (Y)	10674	10780	10885	10990	11095	11200	11305	11410	11515	11621
Dual Table (G), Two Small Power Flip Black (X) / White (Y)	11029	11135	11240	11345	11450	11555	11660	11765	11870	11975
	Leather LA	Leather LB	Leather LC	Leather LD						
Standard Table (F), None Electric (N)	9441	9763	10486	10890						
Standard Table (F), Small Power Flip Black (B) / White (W)	10368	10689	11416	11817						
Dual Table (G), None Electric (N)	9796	10119	10841	11245						
Dual Table (G), Small Power Flip Black (B) / White (W)	10723	11044	11771	12172						
Standard Table (F), Two Small Power Flip Black (X) / White (Y)	11297	11617	12344	12746						
Dual Table (G), Two Small Power Flip Black (X) / White (Y)	11652	11974	12699	13101						

Pricing and options are continued on the following pages.

NBS / NBM
**Banqs Single-Sided Solo Focus
 (Continued)**

DESCRIPTION

PRICE

	HIGH SCREEN (L)									
	STANDARD SOFA (S)									
	COM/ Grade 1	COL/ Grade 2	Grade 3	Grade 4	Grade 5	Grade 6	Grade 7	Grade 8	Grade 9	Grade 10
Standard Table (C), None Electric (N)	5629	5762	5885	5973	6042	6116	6204	6291	6379	6473
Standard Table (C), Small Power Flip Black (B) / White (W)	6559	6689	6812	6899	6972	7042	7129	7218	7305	7400
Box Storage (D), None Electric (N)	6085	6216	6339	6428	6498	6570	6658	6745	6834	6928
Box Storage (D), Small Power Flip Black (B) / White (W)	7013	7144	7267	7354	7426	7498	7585	7673	7759	7856
Boomerang (E), None Electric (N)	6191	6323	6446	6534	6604	6677	6765	6852	6940	7034
Boomerang (E), Small Power Flip Black (B) / White (W)	7120	7250	7373	7460	7533	7604	7691	7779	7866	7961
	Grade 11	Grade 12	Grade 13	Grade 14	Grade 15	Grade 16	Grade 17	Grade 18	Grade 19	Grade 20
Standard Table (C), None Electric (N)	6577	6683	6787	6893	6998	7103	7208	7313	7418	7523
Standard Table (C), Small Power Flip Black (B) / White (W)	7505	7610	7715	7821	7925	8031	8135	8241	8345	8451
Box Storage (D), None Electric (N)	7033	7137	7243	7347	7453	7559	7663	7769	7873	7978
Box Storage (D), Small Power Flip Black (B) / White (W)	7960	8065	8170	8275	8381	8485	8591	8695	8801	8905
Boomerang (E), None Electric (N)	7139	7244	7350	7454	7560	7664	7770	7874	7980	8084
Boomerang (E), Small Power Flip Black (B) / White (W)	8067	8171	8277	8382	8487	8592	8697	8802	8906	9012
	Leather LA	Leather LB	Leather LC	Leather LD						
Standard Table (C), None Electric (N)	6957	7173	7656	7925						
Standard Table (C), Small Power Flip Black (B) / White (W)	7886	8099	8584	8853						
Box Storage (D), None Electric (N)	7412	7628	8111	8381						
Box Storage (D), Small Power Flip Black (B) / White (W)	8340	8554	9040	9308						
Boomerang (E), None Electric (N)	7518	7735	8217	8487						
Boomerang (E), Small Power Flip Black (B) / White (W)	8447	8661	9147	9415						
	WIDE SOFA (W)									
	COM/ Grade 1	COL/ Grade 2	Grade 3	Grade 4	Grade 5	Grade 6	Grade 7	Grade 8	Grade 9	Grade 10
Standard Table (F), None Electric (N)	7502	7698	7885	8016	8122	8229	8361	8492	8623	8767
Standard Table (F), Small Power Flip Black (B) / White (W)	8429	8626	8811	8942	9050	9157	9288	9419	9550	9694
Dual Table (G), None Electric (N)	7857	8053	8239	8371	8477	8584	8716	8847	8978	9122
Dual Table (G), Small Power Flip Black (B) / White (W)	8784	8981	9166	9297	9405	9512	9643	9774	9905	10049
Standard Table (F), Two Small Power Flip Black (X) / White (Y)	9358	9554	9741	9870	9979	10085	10217	10347	10479	10623
Dual Table (G), Two Small Power Flip Black (X) / White (Y)	9713	9909	10095	10225	10334	10440	10572	10702	10834	10978
	Grade 11	Grade 12	Grade 13	Grade 14	Grade 15	Grade 16	Grade 17	Grade 18	Grade 19	Grade 20
Standard Table (F), None Electric (N)	8872	8977	9082	9187	9292	9397	9503	9607	9713	9817
Standard Table (F), Small Power Flip Black (B) / White (W)	9800	9904	10010	10114	10220	10325	10430	10535	10640	10745
Dual Table (G), None Electric (N)	9227	9332	9437	9542	9648	9752	9858	9962	10068	10172
Dual Table (G), Small Power Flip Black (B) / White (W)	10155	10259	10365	10469	10575	10680	10785	10890	10994	11100
Standard Table (F), Two Small Power Flip Black (X) / White (Y)	10728	10833	10938	11043	11149	11253	11359	11463	11569	11673
Dual Table (G), Two Small Power Flip Black (X) / White (Y)	11083	11188	11293	11398	11504	11608	11714	11818	11924	12028
	Leather LA	Leather LB	Leather LC	Leather LD						
Standard Table (F), None Electric (N)	9493	9816	10540	10943						
Standard Table (F), Small Power Flip Black (B) / White (W)	10421	10743	11468	11870						
Dual Table (G), None Electric (N)	9848	10171	10895	11298						
Dual Table (G), Small Power Flip Black (B) / White (W)	10776	11098	11823	12225						
Standard Table (F), Two Small Power Flip Black (X) / White (Y)	11349	11671	12397	12799						
Dual Table (G), Two Small Power Flip Black (X) / White (Y)	11704	12026	12752	13154						

Pricing and options are continued on the following pages

NBS / NBM

Banqs Single-Sided Solo Focus (Continued)

DESCRIPTION

PRICE

BOLSTER UPHOLSTERY										
	COM/ Grade 1	COL/ Grade 2	Grade 3	Grade 4	Grade 5	Grade 6	Grade 7	Grade 8	Grade 9	Grade 10
Standard Sofa: Low (L), Medium (M), High Screen (H)	84	172	254	312	358	407	465	524	582	645
Wide Sofa: Low (L), Medium (M), High Screen (H)	123	259	422	538	636	731	847	964	1081	1208
	Grade 11	Grade 12	Grade 13	Grade 14	Grade 15	Grade 16	Grade 17	Grade 18	Grade 19	Grade 20
Standard Sofa: Low (L), Medium (M), High Screen (H)	730	814	899	983	1067	1152	1237	1321	1406	1491
Wide Sofa: Low (L), Medium (M), High Screen (H)	1292	1377	1462	1545	1630	1714	1799	1884	1969	2053
	Leather LA	Leather LB	Leather LC	Leather LD						
Standard Sofa: Low (L), Medium (M), High Screen (H)	969	1112	1435	1614						
Wide Sofa: Low (L), Medium (M), High Screen (H)	1854	2140	2785	3142						
SCREEN UPHOLSTERY										
	COM/ Grade 1	COL/ Grade 2	Grade 3	Grade 4	Grade 5	Grade 6	Grade 7	Grade 8	Grade 9	Grade 10
Standard Sofa: Low Screen (L)	84	195	297	371	430	490	561	636	708	788
Standard Sofa: Medium Screen (M)	84	229	364	461	538	618	715	812	907	1012
Standard Sofa: High Screen (H)	84	237	382	483	566	651	754	855	956	1067
Wide Sofa: Low Screen (L)	123	325	552	711	843	973	1136	1295	1453	1629
Wide Sofa: Medium Screen (M)	123	412	719	938	1117	1296	1515	1734	1952	2190
Wide Sofa: High Screen (H)	123	434	762	995	1186	1377	1611	1844	2078	2330
	Grade 11	Grade 12	Grade 13	Grade 14	Grade 15	Grade 16	Grade 17	Grade 18	Grade 19	Grade 20
Standard Sofa: Low Screen (L)	923	1060	1197	1333	1470	1607	1742	1879	2015	2152
Standard Sofa: Medium Screen (M)	1148	1285	1421	1558	1695	1830	1967	2103	2240	2377
Standard Sofa: High Screen (H)	1204	1341	1477	1614	1749	1886	2023	2159	2296	2433
Wide Sofa: Low Screen (L)	1766	1902	2038	2175	2311	2448	2584	2720	2857	2994
Wide Sofa: Medium Screen (M)	2327	2464	2600	2736	2873	3009	3146	3282	3419	3555
Wide Sofa: High Screen (H)	2467	2603	2740	2877	3013	3149	3286	3422	3559	3695
	Leather LA	Leather LB	Leather LC	Leather LD						
Standard Sofa: Low Screen (L)	1190	1371	1772	1998						
Standard Sofa: Medium Screen (M)	1544	1781	2313	2609						
Standard Sofa: High Screen (H)	1632	1884	2448	2761						
Wide Sofa: Low Screen (L)	2520	2913	3798	4290						
Wide Sofa: Medium Screen (M)	3403	3941	5147	5819						
Wide Sofa: High Screen (H)	3624	4198	5483	6201						

If Mica/Accent Paint Finish is specified add 51

If Flintwood Finish is specified add 150

If Veneer Finish is specified add 173

banqs corner alcove solo focus, standard overview

Banqs Corner Alcove Solo Focus Sofas address various visual, acoustic, and spatial privacy needs with (3) screen heights.

Can be used in stand alone applications or combined with other Banqs components to create linear, perpendicular, and pinwheel layouts for any environment.

Banqs Corner Alcove Solo Focus, Standard (NBL)

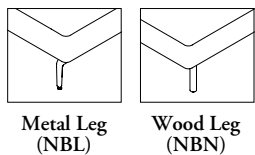
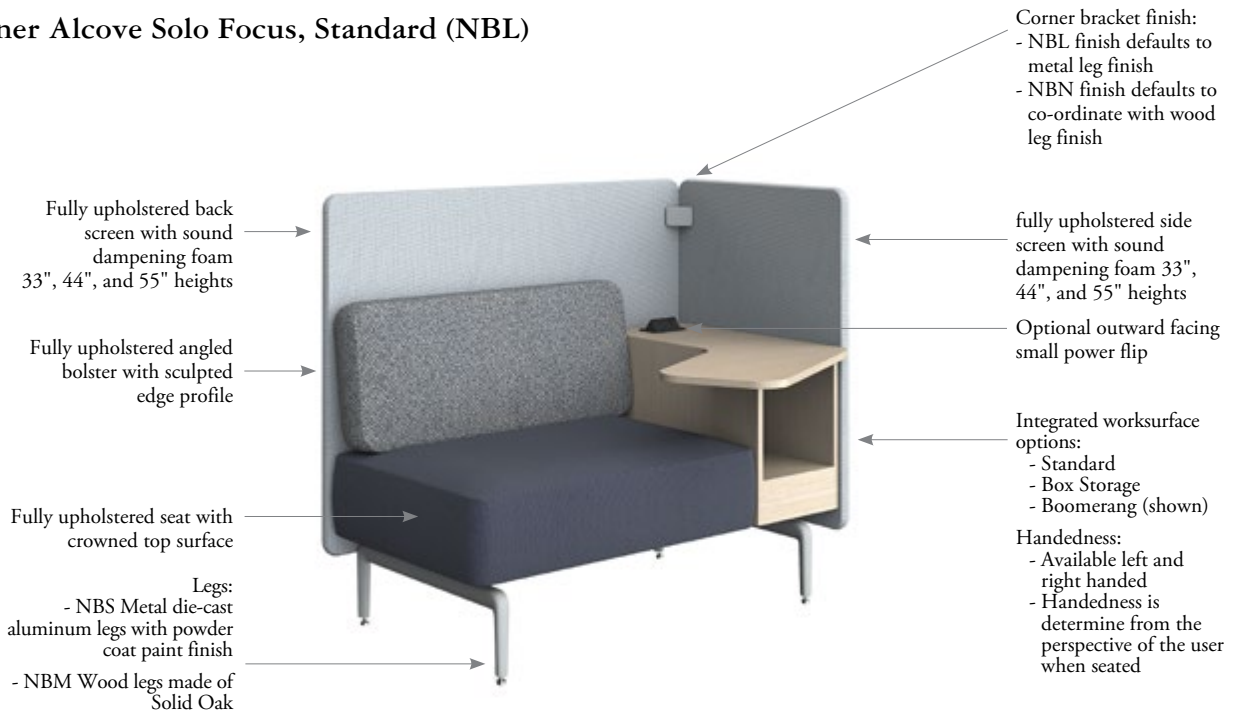

statement of line

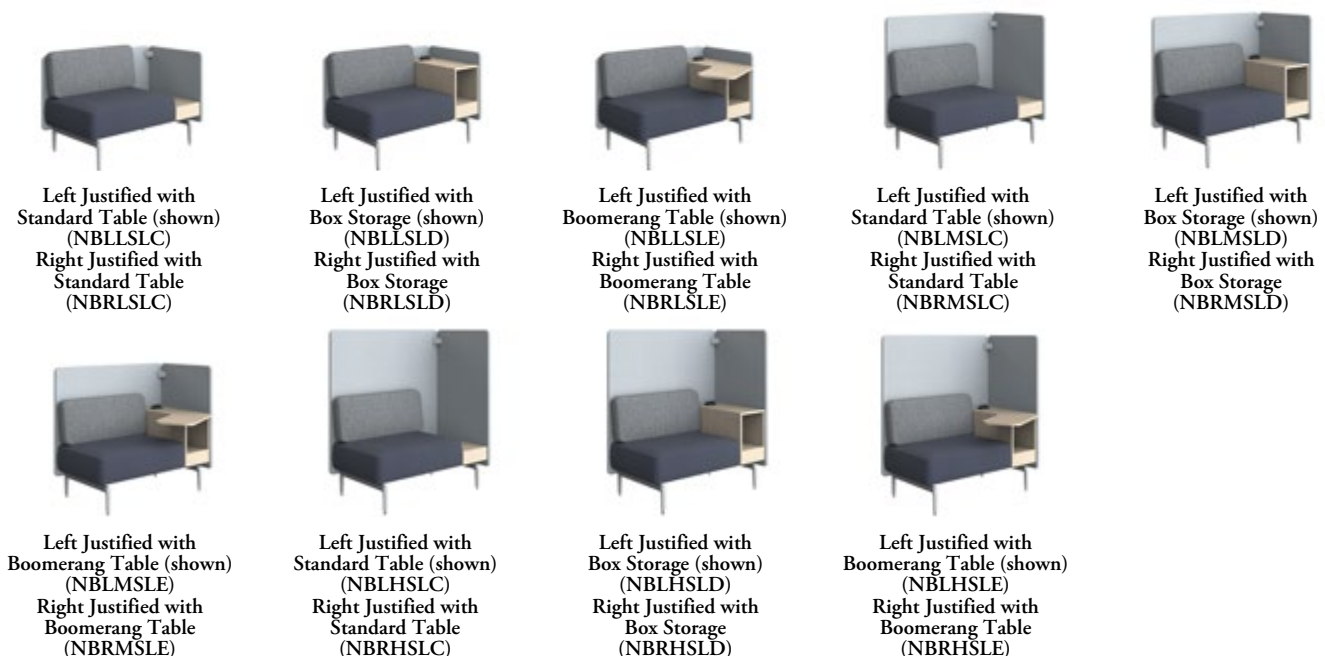

banqs corner alcove solo focus, standard dimensions & material requirements

construction notes

- Weight capacity of 300 lbs. per seat (ie. 2-Seater capacity is 600 lbs.)
- Conforms to BIFMA X5.4-2020 lounge seating standards

weight metal legs (add 7 lbs. for wood legs)

Corner Alcove Solo Focus, Low Screen, Standard Table	123 lbs
Corner Alcove Solo Focus, Low Screen, Box Storage	142 lbs
Corner Alcove Solo Focus, Low Screen, Boomerang Table	147 lbs
Corner Alcove Solo Focus, Medium Screen, Standard Table	146 lbs
Corner Alcove Solo Focus, Medium Screen, Box Storage	165 lbs
Corner Alcove Solo Focus, Medium Screen, Boomerang Table	170 lbs
Corner Alcove Solo Focus, High Screen, Standard Table	162 lbs
Corner Alcove Solo Focus, High Screen, Box Storage	181 lbs
Corner Alcove Solo Focus, High Screen, Boomerang Table	186 lbs

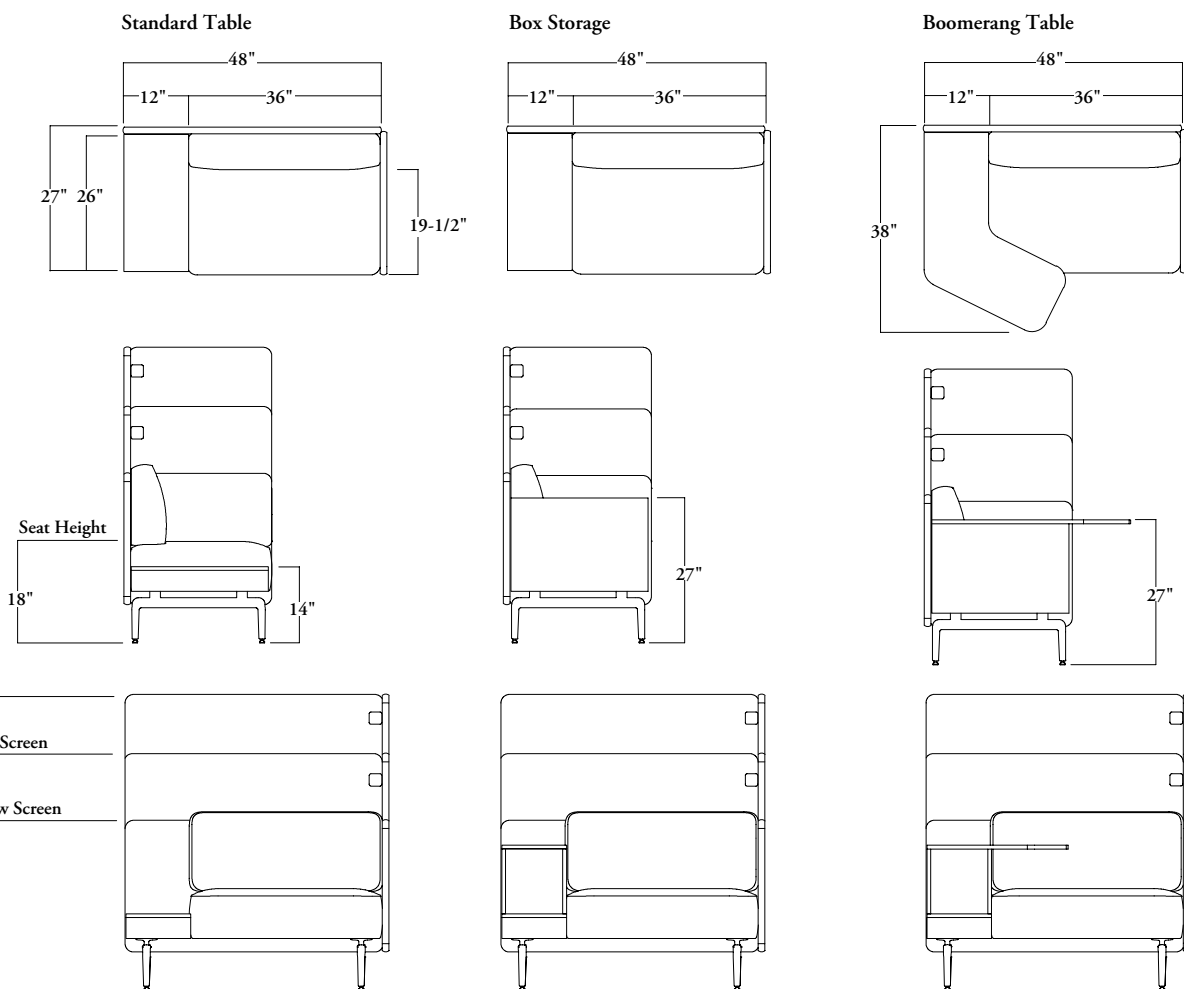

COM/COL material requirement

The pattern, repeat and directionality of fabric may increase the amount of yardage required.

Leather quantities should always be rounded up to the next hide size, as yields vary from 60-80% and are affected by the quality, size and shape of the hide, and by the location and quantity of blemishes.

	SEAT		BOLSTER		SCREEN	
	COM [yards]	COL [sq. ft]	COM [yards]	COL [sq. ft]	COM [yards]	COL [sq. ft]
Low Screen	2.25	38	1.75	30	3.5	60
Medium Screen	2.25	38	1.75	30	5	85
High Screen	2.25	38	1.75	30	6	102

banqs corner alcove solo focus, wide overview

Banqs Corner Alcove Solo Focus Sofas address various visual, acoustic, and spatial privacy needs with three screen heights.

Can be used in stand alone applications or combined with other Banqs components to create wider linear, perpendicular, and pinwheel layouts for any environment.

Banqs Corner Alcove Solo Focus, Wide (NBL)

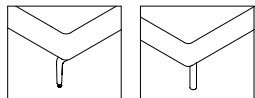

Metal Leg (NBL)

Wood Leg (NBN)

statement of line



Left Justified with Standard Table (shown) (NBLLWLF)
Right Justified with Standard Table (NBRLWLF)



Left Justified with Dual Table (shown) (NBLLWLG)
Right Justified with Dual Table (NBRLWLG)



Left Justified with Standard Table (shown) (NBLMWLF)
Right Justified with Standard Table (NBRMWLF)



Left Justified with Dual Table (shown) (NBLMWLG)
Right Justified with Dual Table (NBRMWLG)



Left Justified with Standard Table (shown) (NBLHWLF)
Right Justified with Standard Table (NBRHWLF)



Left Justified with Dual Table (shown) (NBLHWLG)
Right Justified with Dual Table (NBRHWLG)

banqs corner alcove solo focus, wide dimensions & material requirements

construction notes

- Weight capacity of 300 lbs. per seat (ie. 2-Seater capacity is 600 lbs.)
- Conforms to BIFMA X5.4-2020 lounge seating standards

weight metal legs (add 7 lbs. for wood legs)

Corner Alcove Solo Focus, Low Screen, Standard Table	171 lbs
Corner Alcove Solo Focus, Low Screen, Dual Table	191 lbs
Corner Alcove Solo Focus, Medium Screen, Standard Table	204 lbs
Corner Alcove Solo Focus, Medium Screen, Dual Table	224 lbs
Corner Alcove Solo Focus, High Screen, Standard Table	223 lbs
Corner Alcove Solo Focus, High Screen, Dual Table	243 lbs

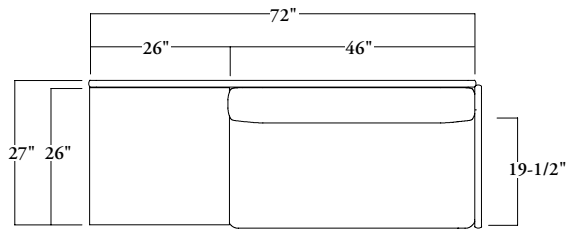

Standard Table

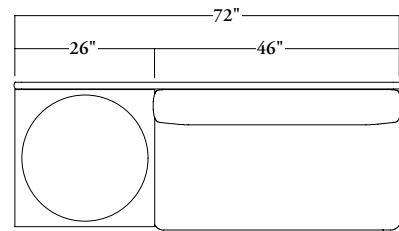

Dual Table

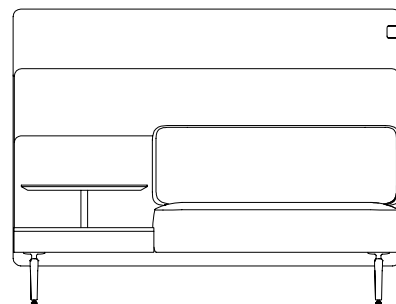
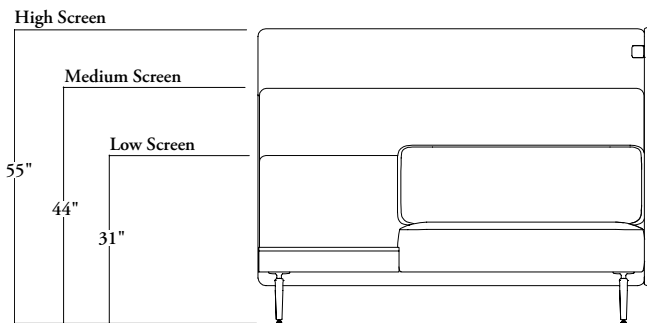
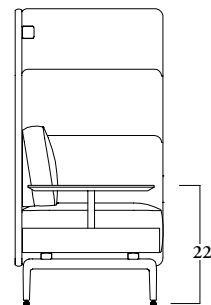
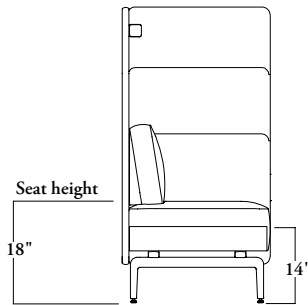

COM/COL material requirement

The pattern, repeat and directionality of fabric may increase the amount of yardage required.

Leather quantities should always be rounded up to the next hide size, as yields vary from 60-80% and are affected by the quality, size and shape of the hide, and by the location and quantity of blemishes.

	SEAT		BOLSTER		SCREEN	
	COM [yards]	COL [sq. ft]	COM [yards]	COL [sq. ft]	COM [yards]	COL [sq. ft]
Low Screen	2.25	38	2	34	5	85
Medium Screen	2.25	38	2	34	7	117
High Screen	2.25	38	2	34	9	148

NBL / NBN

Banqs Left Corner Alcove Solo Focus

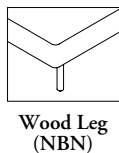
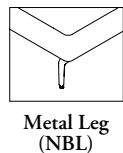
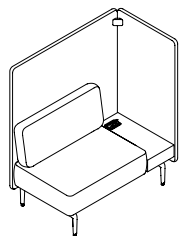

FEATURES

- Standard and wide options
- Legs available in Metal (NBL) or Wood (NBN)
- Available in single and triple upholstery
- Standard, box storage, and boomerang (standard width) and standard and dual (wide width) table options
- Optional small power flip available in black or white finish
- Ships fully assembled.

NOTES

- Laminate/veneer finish applies to entire table
- Ganging plates and kits must be ordered separately for linear, perpendicular, or pinwheel applications
- Undermount electrical module must be specified as separate item (includes cable management)
- When low screen is selected, corner bracket will not appear when Box Storage or Boomerang Table is adjacent to screen
- Low screen sofas (33"H) that have either Box Storage or Boomerang tables specified next to a side screen do not require the screen connector bracket at top

PRODUCT OPTIONS

Screen Height	Sofa Size	Table Orientation	Table	Electrics
L Low Screen Height	S Standard (Shown)	L Left (shown)	C Standard (Standard Size Only)	N None
M Medium Screen Height	W Wide	R Right	D Box Storage (Standard Size Only)	B Small Power Flip Black
H High Screen Height (Shown)			E Boomerang (Standard Size Only)	W Small Power Flip White
			F Standard (Wide Size Only)	X Two Small Power Flip Black
			G Dual (Wide Size Only)	Y Two Small Power Flip White

SAMPLE ORDER CODE

NBL H	S	R	C	W
--------------	----------	----------	----------	----------

PRODUCT OPTIONS (CONTINUED)

Table Surface Finish	Seat Upholstery Finish	Bolster Upholstery Finish	Screen Upholstery Finish	Metal Leg Finish (if metal leg is specified)
Foundation Laminate	Fabric	Fabric	Fabric	Foundation
Flintwood	Leather	Leather	Leather	Mica
Natural Veneer				Accent
Zones Exclusive Laminate				Wood Leg Finish (if wood leg is specified)
				N56 Stain Finishes

SAMPLE ORDER CODE (CONTINUED)

LW	E515	E515	E515	24
-----------	-------------	-------------	-------------	-----------

See pricing on the following page.

N B L / N B N

Banqs Left Corner Alcove Solo Focus
(Continued)

DESCRIPTION

PRICE

LOW SCREEN (L)										
STANDARD SOFA (S)										
	COM/ Grade 1	COL/ Grade 2	Grade 3	Grade 4	Grade 5	Grade 6	Grade 7	Grade 8	Grade 9	Grade 10
Standard Table (C), None Electric (N)	6458	6590	6713	6800	6872	6944	7031	7119	7206	7301
Standard Table (C), Small Power Flip Black (B) / White (W)	7386	7516	7640	7728	7800	7869	7958	8045	8133	8229
Box Storage (D), None Electric (N)	6914	7045	7168	7255	7328	7398	7485	7574	7661	7756
Box Storage (D), Small Power Flip Black (B) / White (W)	7840	7972	8096	8184	8255	8325	8413	8500	8589	8685
Boomerang (E), None Electric (N)	7019	7151	7274	7361	7433	7505	7592	7680	7767	7862
Boomerang (E), Small Power Flip Black (B) / White (W)	7947	8077	8201	8289	8361	8431	8519	8606	8694	8790
	Grade 11	Grade 12	Grade 13	Grade 14	Grade 15	Grade 16	Grade 17	Grade 18	Grade 19	Grade 20
Standard Table (C), None Electric (N)	7405	7511	7617	7721	7827	7931	8036	8141	8246	8352
Standard Table (C), Small Power Flip Black (B) / White (W)	8335	8440	8545	8650	8755	8860	8964	9070	9176	9280
Box Storage (D), None Electric (N)	7861	7966	8071	8177	8281	8387	8491	8597	8701	8807
Box Storage (D), Small Power Flip Black (B) / White (W)	8789	8895	9000	9105	9210	9315	9420	9525	9630	9736
Boomerang (E), None Electric (N)	7968	8072	8178	8282	8388	8492	8598	8702	8808	8913
Boomerang (E), Small Power Flip Black (B) / White (W)	8896	9002	9106	9212	9316	9422	9526	9631	9737	9841
	Leather LA	Leather LB	Leather LC	Leather LD						
Standard Table (C), None Electric (N)	7786	8002	8484	8752						
Standard Table (C), Small Power Flip Black (B) / White (W)	8714	8927	9412	9681						
Box Storage (D), None Electric (N)	8242	8456	8940	9208						
Box Storage (D), Small Power Flip Black (B) / White (W)	9169	9383	9867	10136						
Boomerang (E), None Electric (N)	8347	8563	9046	9314						
Boomerang (E), Small Power Flip Black (B) / White (W)	9275	9489	9974	10243						
WIDE SOFA (W)										
	COM/ Grade 1	COL/ Grade 2	Grade 3	Grade 4	Grade 5	Grade 6	Grade 7	Grade 8	Grade 9	Grade 10
Standard Table (F), None Electric (N)	8264	8460	8647	8777	8884	8991	9123	9254	9386	9529
Standard Table (F), Small Power Flip Black (B) / White (W)	9190	9388	9572	9706	9812	9919	10050	10181	10314	10455
Dual Table (G), None Electric (N)	8619	8815	9002	9132	9239	9346	9478	9609	9741	9884
Dual Table (G), Small Power Flip Black (B) / White (W)	9190	9388	9572	9706	9812	9919	10050	10181	10314	10455
Standard Table (F), Two Small Power Flip Black (X) / White (Y)	10119	10316	10501	10634	10742	10847	10979	11109	11243	11384
Dual Table (G), Two Small Power Flip Black (X) / White (Y)	10474	10671	10856	10989	11097	11202	11334	11464	11598	11739
	Grade 11	Grade 12	Grade 13	Grade 14	Grade 15	Grade 16	Grade 17	Grade 18	Grade 19	Grade 20
Standard Table (F), None Electric (N)	9634	9739	9844	9949	10054	10159	10265	10369	10475	10579
Standard Table (F), Small Power Flip Black (B) / White (W)	10561	10665	10771	10875	10981	11085	11191	11296	11400	11506
Dual Table (G), None Electric (N)	9989	10094	10199	10304	10409	10514	10620	10724	10830	10934
Dual Table (G), Small Power Flip Black (B) / White (W)	10561	10665	10771	10875	10981	11085	11191	11296	11400	11506
Standard Table (F), Two Small Power Flip Black (X) / White (Y)	11489	11594	11699	11804	11909	12014	12119	12224	12330	12434
Dual Table (G), Two Small Power Flip Black (X) / White (Y)	11844	11949	12054	12159	12264	12369	12475	12579	12685	12789
	Leather LA	Leather LB	Leather LC	Leather LD						
Standard Table (F), None Electric (N)	10256	10578	11303	11704						
Standard Table (F), Small Power Flip Black (B) / White (W)	11184	11506	12230	12632						
Dual Table (G), None Electric (N)	10611	10933	11658	12059						
Dual Table (G), Small Power Flip Black (B) / White (W)	11184	11506	12230	12632						
Standard Table (F), Two Small Power Flip Black (X) / White (Y)	12112	12434	13159	13560						
Dual Table (G), Two Small Power Flip Black (X) / White (Y)	12467	12789	13514	13915						

Pricing and options are continued on the following pages.

NBL / NBN

Banqs Left Corner Alcove Solo Focus

(Continued)

DESCRIPTION

PRICE

MEDIUM SCREEN (L)										
STANDARD SOFA (S)										
	COM/ Grade 1	COL/ Grade 2	Grade 3	Grade 4	Grade 5	Grade 6	Grade 7	Grade 8	Grade 9	Grade 10
Standard Table (C), None Electric (N)	6644	6776	6899	6986	7057	7129	7216	7305	7392	7487
Standard Table (C), Small Power Flip Black (B) / White (W)	7571	7701	7825	7914	7985	8056	8144	8230	8318	8415
Box Storage (D), None Electric (N)	7099	7231	7354	7441	7512	7585	7671	7759	7846	7943
Box Storage (D), Small Power Flip Black (B) / White (W)	8027	8157	8280	8368	8441	8511	8599	8686	8774	8869
Boomerang (E), None Electric (N)	7206	7337	7460	7547	7619	7691	7778	7866	7953	8048
Boomerang (E), Small Power Flip Black (B) / White (W)	8133	8264	8387	8475	8547	8618	8706	8793	8881	8976
	Grade 11	Grade 12	Grade 13	Grade 14	Grade 15	Grade 16	Grade 17	Grade 18	Grade 19	Grade 20
Standard Table (C), None Electric (N)	7592	7697	7802	7907	8012	8118	8222	8328	8432	8538
Standard Table (C), Small Power Flip Black (B) / White (W)	8519	8625	8729	8835	8940	9045	9150	9254	9360	9464
Box Storage (D), None Electric (N)	8047	8152	8257	8362	8467	8572	8678	8782	8888	8992
Box Storage (D), Small Power Flip Black (B) / White (W)	8975	9079	9185	9289	9395	9500	9605	9710	9815	9920
Boomerang (E), None Electric (N)	8154	8258	8364	8469	8574	8679	8784	8889	8993	9099
Boomerang (E), Small Power Flip Black (B) / White (W)	9080	9186	9290	9396	9502	9606	9712	9816	9921	10026
	Leather LA	Leather LB	Leather LC	Leather LD						
Standard Table (C), None Electric (N)	7972	8187	8670	8938						
Standard Table (C), Small Power Flip Black (B) / White (W)	8900	9113	9598	9867						
Box Storage (D), None Electric (N)	8426	8642	9126	9394						
Box Storage (D), Small Power Flip Black (B) / White (W)	9355	9569	10053	10322						
Boomerang (E), None Electric (N)	8533	8749	9231	9500						
Boomerang (E), Small Power Flip Black (B) / White (W)	9461	9674	10159	10428						
WIDE SOFA (W)										
	COM/ Grade 1	COL/ Grade 2	Grade 3	Grade 4	Grade 5	Grade 6	Grade 7	Grade 8	Grade 9	Grade 10
Standard Table (F), None Electric (N)	8502	8699	8886	9016	9123	9230	9361	9493	9625	9767
Standard Table (F), Small Power Flip Black (B) / White (W)	9428	9627	9811	9944	10051	10158	10289	10420	10551	10694
Dual Table (G), None Electric (N)	8857	9054	9241	9370	9478	9585	9716	9848	9979	10122
Dual Table (G), Small Power Flip Black (B) / White (W)	9783	9982	10166	10298	10406	10513	10644	10775	10906	11049
Standard Table (F), Two Small Power Flip Black (X) / White (Y)	10358	10555	10740	10872	10981	11086	11218	11348	11481	11623
Dual Table (G), Two Small Power Flip Black (X) / White (Y)	10713	10910	11095	11226	11336	11441	11573	11703	11835	11978
	Grade 11	Grade 12	Grade 13	Grade 14	Grade 15	Grade 16	Grade 17	Grade 18	Grade 19	Grade 20
Standard Table (F), None Electric (N)	9872	9977	10082	10187	10292	10397	10503	10607	10713	10817
Standard Table (F), Small Power Flip Black (B) / White (W)	10800	10904	11010	11114	11220	11324	11429	11535	11639	11745
Dual Table (G), None Electric (N)	10227	10332	10437	10542	10646	10752	10858	10962	11068	11172
Dual Table (G), Small Power Flip Black (B) / White (W)	11155	11259	11365	11469	11574	11680	11784	11890	11994	12100
Standard Table (F), Two Small Power Flip Black (X) / White (Y)	11728	11833	11938	12043	12148	12253	12359	12463	12569	12673
Dual Table (G), Two Small Power Flip Black (X) / White (Y)	12083	12188	12293	12398	12504	12608	12714	12818	12924	13028
	Leather LA	Leather LB	Leather LC	Leather LD						
Standard Table (F), None Electric (N)	10495	10817	11541	11945						
Standard Table (F), Small Power Flip Black (B) / White (W)	11423	11744	12469	12871						
Dual Table (G), None Electric (N)	10849	11172	11896	12299						
Dual Table (G), Small Power Flip Black (B) / White (W)	11777	12099	12824	13226						
Standard Table (F), Two Small Power Flip Black (X) / White (Y)	12351	12672	13398	13801						
Dual Table (G), Two Small Power Flip Black (X) / White (Y)	12705	13027	13753	14155						

N B L / N B N

**Banqs Left Corner Alcove Solo Focus
(Continued)**

DESCRIPTION

PRICE

HIGH SCREEN (L)										
STANDARD SOFA (S)										
	COM/ Grade 1	COL/ Grade 2	Grade 3	Grade 4	Grade 5	Grade 6	Grade 7	Grade 8	Grade 9	Grade 10
Standard Table (C), None Electric (N)	6690	6822	6945	7032	7103	7176	7263	7351	7438	7533
Standard Table (C), Small Power Flip Black (B) / White (W)	7618	7749	7871	7959	8032	8103	8190	8277	8365	8460
Box Storage (D), None Electric (N)	7146	7277	7400	7487	7559	7630	7717	7806	7893	7988
Box Storage (D), Small Power Flip Black (B) / White (W)	8072	8205	8326	8415	8487	8558	8645	8731	8819	8916
Boomerang (E), None Electric (N)	7251	7383	7506	7593	7664	7737	7824	7912	7999	8094
Boomerang (E), Small Power Flip Black (B) / White (W)	8179	8310	8432	8520	8593	8664	8751	8838	8926	9021
	Grade 11	Grade 12	Grade 13	Grade 14	Grade 15	Grade 16	Grade 17	Grade 18	Grade 19	Grade 20
Standard Table (C), None Electric (N)	7637	7743	7847	7953	8059	8163	8268	8373	8478	8583
Standard Table (C), Small Power Flip Black (B) / White (W)	8565	8670	8775	8881	8985	9091	9195	9301	9405	9511
Box Storage (D), None Electric (N)	8093	8198	8303	8408	8513	8619	8723	8829	8933	9039
Box Storage (D), Small Power Flip Black (B) / White (W)	9020	9126	9230	9336	9441	9546	9651	9756	9861	9966
Boomerang (E), None Electric (N)	8199	8304	8410	8514	8620	8724	8830	8934	9040	9144
Boomerang (E), Small Power Flip Black (B) / White (W)	9127	9231	9337	9442	9547	9652	9757	9862	9967	10072
	Leather LA	Leather LB	Leather LC	Leather LD						
Standard Table (C), None Electric (N)	8017	8234	8716	8984						
Standard Table (C), Small Power Flip Black (B) / White (W)	8946	9159	9643	9913						
Box Storage (D), None Electric (N)	8473	8688	9171	9439						
Box Storage (D), Small Power Flip Black (B) / White (W)	9401	9614	10099	10368						
Boomerang (E), None Electric (N)	8578	8795	9278	9546						
Boomerang (E), Small Power Flip Black (B) / White (W)	9507	9721	10205	10475						
WIDE SOFA (W)										
	COM/ Grade 1	COL/ Grade 2	Grade 3	Grade 4	Grade 5	Grade 6	Grade 7	Grade 8	Grade 9	Grade 10
Standard Table (F), None Electric (N)	8561	8758	8945	9076	9183	9289	9420	9553	9684	9826
Standard Table (F), Small Power Flip Black (B) / White (W)	9489	9686	9872	10003	10111	10217	10348	10479	10611	10754
Dual Table (G), None Electric (N)	8916	9113	9300	9431	9538	9644	9775	9908	10039	10181
Dual Table (G), Small Power Flip Black (B) / White (W)	9844	10041	10227	10358	10466	10572	10703	10834	10965	11109
Standard Table (F), Two Small Power Flip Black (X) / White (Y)	10418	10614	10801	10931	11040	11145	11278	11407	11540	11684
Dual Table (G), Two Small Power Flip Black (X) / White (Y)	10773	10969	11156	11286	11395	11500	11632	11762	11895	12038
	Grade 11	Grade 12	Grade 13	Grade 14	Grade 15	Grade 16	Grade 17	Grade 18	Grade 19	Grade 20
Standard Table (F), None Electric (N)	9931	10036	10141	10246	10351	10456	10562	10666	10772	10876
Standard Table (F), Small Power Flip Black (B) / White (W)	10860	10964	11070	11174	11280	11385	11490	11595	11700	11805
Dual Table (G), None Electric (N)	10286	10391	10496	10601	10707	10811	10917	11021	11127	11231
Dual Table (G), Small Power Flip Black (B) / White (W)	11215	11319	11425	11529	11635	11740	11845	11950	12055	12160
Standard Table (F), Two Small Power Flip Black (X) / White (Y)	11788	11893	11998	12103	12209	12313	12419	12523	12629	12733
Dual Table (G), Two Small Power Flip Black (X) / White (Y)	12143	12248	12353	12458	12564	12668	12774	12878	12984	13088
	Leather LA	Leather LB	Leather LC	Leather LD						
Standard Table (F), None Electric (N)	10554	10876	11600	12004						
Standard Table (F), Small Power Flip Black (B) / White (W)	11482	11803	12528	12931						
Dual Table (G), None Electric (N)	10909	11231	11955	12359						
Dual Table (G), Small Power Flip Black (B) / White (W)	11837	12158	12883	13285						
Standard Table (F), Two Small Power Flip Black (X) / White (Y)	12410	12731	13457	13860						
Dual Table (G), Two Small Power Flip Black (X) / White (Y)	12765	13086	13812	14215						

Pricing and options are continued on the following pages.

NBL / NBN

Banqs Left Corner Alcove Solo Focus

(Continued)

DESCRIPTION	PRICE									
BOLSTER UPHOLSTERY										
	Grade 1	COM/ Grade 2	COL/ Grade 3	Grade 4	Grade 5	Grade 6	Grade 7	Grade 8	Grade 9	Grade 10
Standard Sofa: Low (L), Medium (M), High Screen (H)	84	237	382	483	566	651	754	855	956	1067
Wide Sofa: Low (L), Medium (M), High Screen (H)	123	325	552	711	843	973	1136	1295	1453	1629
	Grade 11	Grade 12	Grade 13	Grade 14	Grade 15	Grade 16	Grade 17	Grade 18	Grade 19	Grade 20
Standard Sofa: Low (L), Medium (M), High Screen (H)	1194	1319	1444	1569	1696	1821	1946	2072	2198	2323
Wide Sofa: Low (L), Medium (M), High Screen (H)	1755	1880	2006	2131	2257	2383	2508	2633	2760	2885
	Leather LA	Leather LB	Leather LC	Leather LD						
Standard Sofa: Low (L), Medium (M), High Screen (H)	1632	1884	2448	2761						
Wide Sofa: Low (L), Medium (M), High Screen (H)	2520	2913	3798	4290						
SCREEN UPHOLSTERY										
	Grade 1	COM/ Grade 2	COL/ Grade 3	Grade 4	Grade 5	Grade 6	Grade 7	Grade 8	Grade 9	Grade 10
Standard Sofa: Low Screen (L)	84	302	507	653	771	891	1037	1183	1328	1489
Standard Sofa: Medium Screen (M)	84	372	644	835	993	1150	1343	1535	1727	1938
Standard Sofa: High Screen (H)	84	389	677	882	1049	1215	1419	1623	1827	2051
Wide Sofa: Low Screen (L)	123	434	762	995	1186	1377	1611	1844	2078	2330
Wide Sofa: Medium Screen (M)	123	557	1001	1315	1573	1830	2145	2460	2775	3119
Wide Sofa: High Screen	123	587	1060	1394	1670	1944	2278	2615	2949	3316
	Grade 11	Grade 12	Grade 13	Grade 14	Grade 15	Grade 16	Grade 17	Grade 18	Grade 19	Grade 20
Standard Sofa: Low Screen (L)	1710	1931	2152	2373	2594	2815	3036	3257	3478	3699
Standard Sofa: Medium Screen (M)	2159	2380	2601	2822	3043	3264	3485	3706	3927	4148
Standard Sofa: High Screen (H)	2271	2493	2713	2935	3155	3377	3597	3819	4039	4261
Wide Sofa: Low Screen (L)	2552	2772	2994	3214	3436	3656	3878	4098	4320	4540
Wide Sofa: Medium Screen (M)	3340	3561	3782	4003	4224	4445	4666	4887	5107	5329
Wide Sofa: High Screen (H)	3537	3758	3979	4200	4421	4642	4863	5084	5305	5526
	Leather LA	Leather LB	Leather LC	Leather LD						
Standard Sofa: Low Screen (L)	2297	2654	3458	3908						
Standard Sofa: Medium Screen (M)	3004	3477	4539	5131						
Standard Sofa: High Screen (H)	3181	3682	4809	5437						
Wide Sofa: Low Screen (L)	3624	4198	5483	6201						
Wide Sofa: Medium Screen (M)	4864	5638	7375	8340						
Wide Sofa: High Screen (H)	5175	5998	7850	8875						

If Mica/Accent Paint Finish is specified	add	51
If Flintwood Finish is specified	add	150
If Veneer Finish is specified	add	173

NBR / NBO

Banqs Right Corner Alcove Solo Focus

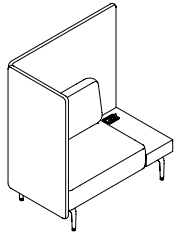

FEATURES

- Standard and wide options
- Legs available in Metal (NBR) or Wood (NBO)
- Available in single and triple upholstery
- Standard, box storage, and boomerang (standard width) and standard and dual (wide width) table options
- Optional small power flip available in black or white finish
- Ships fully assembled

NOTES

- Laminate/veneer finish applies to entire table
- Ganging plates and kits must be ordered separately for linear, perpendicular, or pinwheel applications
- Undermount electrical module must be specified as separate item (includes cable management)
- When low screen is selected, corner bracket will not appear when Box Storage or Boomerang Table is adjacent to screen
- Low screen sofas (33"H) that have either Box Storage or Boomerang tables specified next to a side screen do not require the screen connector bracket at top

PRODUCT OPTIONS

Screen Height	Sofa Size	Table Orientation	Table	Electrics
L Low Screen Height	S Standard (Shown)	L Left (shown)	C Standard (Standard Size Only)	N None
M Medium Screen Height	W Wide	R Right	D Box Storage (Standard Size Only)	B Small Power Flip Black
H High Screen Height (Shown)			E Boomerang (Standard Size Only)	W Small Power Flip White
			F Standard (Wide Size Only)	X Two Small Power Flip Black
			G Dual (Wide Size Only)	Y Two Small Power Flip White

SAMPLE ORDER CODE

NBR H	S	R	C	W
--------------	----------	----------	----------	----------

PRODUCT OPTIONS (CONTINUED)

Table Surface Finish	Seat Upholstery Finish	Bolster Upholstery Finish	Screen Upholstery Finish	Metal Leg Finish (if metal leg is specified)
Foundation Laminate	Fabric	Fabric	Fabric	Foundation
Flintwood	Leather	Leather	Leather	Mica
Natural Veneer				Accent
Zones Exclusive Laminate				Wood Leg Finish (if wood leg is specified)
				N56 Stain Finishes

SAMPLE ORDER CODE (CONTINUED)

LW	E515	E515	E515	24
-----------	-------------	-------------	-------------	-----------

See pricing on the following page.

NBR / NBO

Banqs Right Corner Alcove Solo Focus
(Continued)

DESCRIPTION

PRICE

LOW SCREEN (L)										
STANDARD SOFA (S)										
	COM/ Grade 1	COL/ Grade 2	Grade 3	Grade 4	Grade 5	Grade 6	Grade 7	Grade 8	Grade 9	Grade 10
Standard Table (C), None Electric (N)	6458	6590	6713	6800	6872	6944	7031	7119	7206	7301
Standard Table (C), Small Power Flip Black (B) / White (W)	7386	7516	7640	7728	7800	7869	7958	8045	8133	8229
Box Storage (D), None Electric (N)	6914	7045	7168	7255	7328	7398	7485	7574	7661	7756
Box Storage (D), Small Power Flip Black (B) / White (W)	7840	7972	8096	8184	8255	8325	8413	8500	8589	8685
Boomerang (E), None Electric (N)	7019	7151	7274	7361	7433	7505	7592	7680	7767	7862
Boomerang (E), Small Power Flip Black (B) / White (W)	7947	8077	8201	8289	8361	8431	8519	8606	8694	8790
	Grade 11	Grade 12	Grade 13	Grade 14	Grade 15	Grade 16	Grade 17	Grade 18	Grade 19	Grade 20
Standard Table (C), None Electric (N)	7405	7511	7617	7721	7827	7931	8036	8141	8246	8352
Standard Table (C), Small Power Flip Black (B) / White (W)	8335	8440	8545	8650	8755	8860	8964	9070	9176	9280
Box Storage (D), None Electric (N)	7861	7966	8071	8177	8281	8387	8491	8597	8701	8807
Box Storage (D), Small Power Flip Black (B) / White (W)	8789	8895	9000	9105	9210	9315	9420	9525	9630	9736
Boomerang (E), None Electric (N)	7968	8072	8178	8282	8388	8492	8598	8702	8808	8913
Boomerang (E), Small Power Flip Black (B) / White (W)	8896	9002	9106	9212	9316	9422	9526	9631	9737	9841
	Leather LA	Leather LB	Leather LC	Leather LD						
Standard Table (C), None Electric (N)	7786	8002	8484	8752						
Standard Table (C), Small Power Flip Black (B) / White (W)	8714	8927	9412	9681						
Box Storage (D), None Electric (N)	8242	8456	8940	9208						
Box Storage (D), Small Power Flip Black (B) / White (W)	9169	9383	9867	10136						
Boomerang (E), None Electric (N)	8347	8563	9046	9314						
Boomerang (E), Small Power Flip Black (B) / White (W)	9275	9489	9974	10243						
WIDE SOFA (W)										
	COM/ Grade 1	COL/ Grade 2	Grade 3	Grade 4	Grade 5	Grade 6	Grade 7	Grade 8	Grade 9	Grade 10
Standard Table (F), None Electric (N)	8264	8460	8647	8777	8884	8991	9123	9254	9386	9529
Standard Table (F), Small Power Flip Black (B) / White (W)	9190	9388	9572	9706	9812	9919	10050	10181	10314	10455
Dual Table (G), None Electric (N)	8619	8815	9002	9132	9239	9346	9478	9609	9741	9884
Dual Table (G), Small Power Flip Black (B) / White (W)	9544	9743	9927	10061	10167	10274	10405	10536	10669	10810
Standard Table (F), Two Small Power Flip Black (X) / White (Y)	10119	10316	10501	10634	10742	10847	10979	11109	11243	11384
Dual Table (G), Two Small Power Flip Black (X) / White (Y)	10474	10671	10856	10989	11097	11202	11334	11464	11598	11739
	Grade 11	Grade 12	Grade 13	Grade 14	Grade 15	Grade 16	Grade 17	Grade 18	Grade 19	Grade 20
Standard Table (F), None Electric (N)	9634	9739	9844	9949	10054	10159	10265	10369	10475	10579
Standard Table (F), Small Power Flip Black (B) / White (W)	10561	10665	10771	10875	10981	11085	11191	11296	11400	11506
Dual Table (G), None Electric (N)	9989	10094	10199	10304	10409	10514	10620	10724	10830	10934
Dual Table (G), Small Power Flip Black (B) / White (W)	10916	11020	11126	11230	11336	11440	11545	11651	11755	11861
Standard Table (F), Two Small Power Flip Black (X) / White (Y)	11489	11594	11699	11804	11909	12014	12119	12224	12330	12434
Dual Table (G), Two Small Power Flip Black (X) / White (Y)	11844	11949	12054	12159	12264	12369	12475	12579	12685	1278
	Leather LA	Leather LB	Leather LC	Leather LD						
Standard Table (F), None Electric (N)	10256	10578	11303	11704						
Standard Table (F), Small Power Flip Black (B) / White (W)	11184	11506	12230	12632						
Dual Table (G), None Electric (N)	10611	10933	11658	12059						
Dual Table (G), Small Power Flip Black (B) / White (W)	11539	11861	12585	12987						
Standard Table (F), Two Small Power Flip Black (X) / White (Y)	12112	12434	13159	13560						
Dual Table (G), Two Small Power Flip Black (X) / White (Y)	12467	12789	13514	13915						

Pricing and options are continued on the following pages.

NBR / NBO

Banqs Right Corner Alcove Solo Focus

(Continued)

DESCRIPTION

PRICE

MEDIUM SCREEN (M)										
STANDARD SOFA (S)										
	COM/ Grade 1	COL/ Grade 2	Grade 3	Grade 4	Grade 5	Grade 6	Grade 7	Grade 8	Grade 9	Grade 10
Standard Table (C), None Electric (N)	6644	6776	6899	6986	7057	7129	7216	7305	7392	7487
Standard Table (C), Small Power Flip Black (B) / White (W)	7571	7701	7825	7914	7985	8056	8144	8230	8318	8415
Box Storage (D), None Electric (N)	7099	7231	7354	7441	7512	7585	7671	7759	7846	7943
Box Storage (D), Small Power Flip Black (B) / White (W)	8027	8157	8280	8368	8441	8511	8599	8686	8774	8869
Boomerang (E), None Electric (N)	7206	7337	7460	7547	7619	7691	7778	7866	7953	8048
Boomerang (E), Small Power Flip Black (B) / White (W)	8133	8264	8387	8475	8547	8618	8706	8793	8881	8976
	Grade 11	Grade 12	Grade 13	Grade 14	Grade 15	Grade 16	Grade 17	Grade 18	Grade 19	Grade 20
Standard Table (C), None Electric (N)	7592	7697	7802	7907	8012	8118	8222	8328	8432	8538
Standard Table (C), Small Power Flip Black (B) / White (W)	8519	8625	8729	8835	8940	9045	9150	9254	9360	9464
Box Storage (D), None Electric (N)	8047	8152	8257	8362	8467	8572	8678	8782	8888	8992
Box Storage (D), Small Power Flip Black (B) / White (W)	8975	9079	9185	9289	9395	9500	9605	9710	9815	9920
Boomerang (E), None Electric (N)	8154	8258	8364	8469	8574	8679	8784	8889	8993	9099
Boomerang (E), Small Power Flip Black (B) / White (W)	9080	9186	9290	9396	9502	9606	9712	9816	9921	10026
	Leather LA	Leather LB	Leather LC	Leather LD						
Standard Table (C), None Electric (N)	7972	8187	8670	8938						
Standard Table (C), Small Power Flip Black (B) / White (W)	8900	9113	9598	9867						
Box Storage (D), None Electric (N)	8426	8642	9126	9394						
Box Storage (D), Small Power Flip Black (B) / White (W)	9355	9569	10053	10322						
Boomerang (E), None Electric (N)	8533	8749	9231	9500						
Boomerang (E), Small Power Flip Black (B) / White (W)	9461	9674	10159	10428						
WIDE SOFA (W)										
	COM/ Grade 1	COL/ Grade 2	Grade 3	Grade 4	Grade 5	Grade 6	Grade 7	Grade 8	Grade 9	Grade 10
Standard Table (F), None Electric (N)	8502	8699	8886	9016	9123	9230	9361	9493	9625	9767
Standard Table (F), Small Power Flip Black (B) / White (W)	9428	9627	9811	9944	10051	10158	10289	10420	10551	10694
Dual Table (G), None Electric (N)	8857	9054	9241	9370	9478	9585	9716	9848	9979	10122
Dual Table (G), Small Power Flip Black (B) / White (W)	9783	9982	10166	10298	10406	10513	10644	10775	10906	11049
Standard Table (F), Two Small Power Flip Black (X) / White (Y)	10358	10555	10740	10872	10981	11086	11218	11348	11481	11623
Dual Table (G), Two Small Power Flip Black (X) / White (Y)	10713	10910	11095	11226	11336	11441	11573	11703	11835	11978
	Grade 11	Grade 12	Grade 13	Grade 14	Grade 15	Grade 16	Grade 17	Grade 18	Grade 19	Grade 20
Standard Table (F), None Electric (N)	9872	9977	10082	10187	10292	10397	10503	10607	10713	10817
Standard Table (F), Small Power Flip Black (B) / White (W)	10800	10904	11010	11114	11220	11324	11429	11535	11639	11745
Dual Table (G), None Electric (N)	10227	10332	10437	10542	10646	10752	10858	10962	11068	11172
Dual Table (G), Small Power Flip Black (B) / White (W)	11155	11259	11365	11469	11574	11680	11784	11890	11994	12100
Standard Table (F), Two Small Power Flip Black (X) / White (Y)	11728	11833	11938	12043	12148	12253	12359	12463	12569	12673
Dual Table (G), Two Small Power Flip Black (X) / White (Y)	12083	12188	12293	12398	12504	12608	12714	12818	12924	13028
	Leather LA	Leather LB	Leather LC	Leather LD						
Standard Table (F), None Electric (N)	10495	10817	11541	11945						
Standard Table (F), Small Power Flip Black (B) / White (W)	11423	11744	12469	12871						
Dual Table (G), None Electric (N)	10849	11172	11896	12299						
Dual Table (G), Small Power Flip Black (B) / White (W)	11777	12099	12824	13226						
Standard Table (F), Two Small Power Flip Black (X) / White (Y)	12351	12672	13398	13801						
Dual Table (G), Two Small Power Flip Black (X) / White (Y)	12705	13027	13753	14155						

NBR / NBO

Banqs Right Corner Alcove Solo Focus
(Continued)

DESCRIPTION

PRICE

HIGH SCREEN (H)										
STANDARD SOFA (S)										
	COM/ Grade 1	COL/ Grade 2	Grade 3	Grade 4	Grade 5	Grade 6	Grade 7	Grade 8	Grade 9	Grade 10
Standard Table (C), None Electric (N)	6690	6822	6945	7032	7103	7176	7263	7351	7438	7533
Standard Table (C), Small Power Flip Black (B) / White (W)	7618	7749	7871	7959	8032	8103	8190	8277	8365	8460
Box Storage (D), None Electric (N)	7146	7277	7400	7487	7559	7630	7717	7806	7893	7988
Box Storage (D), Small Power Flip Black (B) / White (W)	8072	8205	8326	8415	8487	8558	8645	8731	8819	8916
Boomerang (E), None Electric (N)	7251	7383	7506	7593	7664	7737	7824	7912	7999	8094
Boomerang (E), Small Power Flip Black (B) / White (W)	8179	8310	8432	8520	8593	8664	8751	8838	8926	9021
	Grade 11	Grade 12	Grade 13	Grade 14	Grade 15	Grade 16	Grade 17	Grade 18	Grade 19	Grade 20
Standard Table (C), None Electric (N)	7637	7743	7847	7953	8059	8163	8268	8373	8478	8583
Standard Table (C), Small Power Flip Black (B) / White (W)	8565	8670	8775	8881	8985	9091	9195	9301	9405	9511
Box Storage (D), None Electric (N)	8093	8198	8303	8408	8513	8619	8723	8829	8933	9039
Box Storage (D), Small Power Flip Black (B) / White (W)	9020	9126	9230	9336	9441	9546	9651	9756	9861	9966
Boomerang (E), None Electric (N)	8199	8304	8410	8514	8620	8724	8830	8934	9040	9144
Boomerang (E), Small Power Flip Black (B) / White (W)	9127	9231	9337	9442	9547	9652	9757	9862	9967	10072
	Leather LA	Leather LB	Leather LC	Leather LD						
Standard Table (C), None Electric (N)	8017	8234	8716	8984						
Standard Table (C), Small Power Flip Black (B) / White (W)	8946	9159	9643	9913						
Box Storage (D), None Electric (N)	8473	8688	9171	9439						
Box Storage (D), Small Power Flip Black (B) / White (W)	9401	9614	10099	10368						
Boomerang (E), None Electric (N)	8578	8795	9278	9546						
Boomerang (E), Small Power Flip Black (B) / White (W)	9507	9721	10205	10475						
WIDE SOFA (W)										
	COM/ Grade 1	COL/ Grade 2	Grade 3	Grade 4	Grade 5	Grade 6	Grade 7	Grade 8	Grade 9	Grade 10
Standard Table (F), None Electric (N)	8561	8758	8945	9076	9183	9289	9420	9553	9684	9826
Standard Table (F), Small Power Flip Black (B) / White (W)	9489	9686	9872	10003	10111	10217	10348	10479	10611	10754
Dual Table (G), None Electric (N)	8916	9113	9300	9431	9538	9644	9775	9908	10039	10181
Dual Table (G), Small Power Flip Black (B) / White (W)	9844	10041	10227	10358	10466	10572	10703	10834	10965	11109
Standard Table (F), Two Small Power Flip Black (X) / White (Y)	10418	10614	10801	10931	11040	11145	11278	11407	11540	11684
Dual Table (G), Two Small Power Flip Black (X) / White (Y)	10773	10969	11156	11286	11395	11500	11632	11762	11895	12038
	Grade 11	Grade 12	Grade 13	Grade 14	Grade 15	Grade 16	Grade 17	Grade 18	Grade 19	Grade 20
Standard Table (F), None Electric (N)	9931	10036	10141	10246	10351	10456	10562	10666	10772	10876
Standard Table (F), Small Power Flip Black (B) / White (W)	10860	10964	11070	11174	11280	11385	11490	11595	11700	11805
Dual Table (G), None Electric (N)	10286	10391	10496	10601	10707	10811	10917	11021	11127	11231
Dual Table (G), Small Power Flip Black (B) / White (W)	11215	11319	11425	11529	11635	11740	11845	11950	12055	12160
Standard Table (F), Two Small Power Flip Black (X) / White (Y)	11788	11893	11998	12103	12209	12313	12419	12523	12629	12733
Dual Table (G), Two Small Power Flip Black (X) / White (Y)	12143	12248	12353	12458	12564	12668	12774	12878	12984	13088
	Leather LA	Leather LB	Leather LC	Leather LD						
Standard Table (F), None Electric (N)	10554	10876	11600	12004						
Standard Table (F), Small Power Flip Black (B) / White (W)	11482	11803	12528	12931						
Dual Table (G), None Electric (N)	10909	11231	11955	12359						
Dual Table (G), Small Power Flip Black (B) / White (W)	11837	12158	12883	13285						
Standard Table (F), Two Small Power Flip Black (X) / White (Y)	12410	12731	13457	13860						
Dual Table (G), Two Small Power Flip Black (X) / White (Y)	12765	13086	13812	14215						

Pricing and options are continued on the following pages.

NBR / NBO

Banqs Right Corner Alcove Solo Focus

(Continued)

DESCRIPTION	PRICE									
	BOLSTER UPHOLSTERY									
	Grade 1	COM/ Grade 2	COL/ Grade 3	Grade 4	Grade 5	Grade 6	Grade 7	Grade 8	Grade 9	Grade 10
Standard Sofa: Low (L), Medium (M), High Screen (H)	84	237	382	483	566	651	754	855	956	1067
Wide Sofa: Low (L), Medium (M), High Screen (H)	123	325	552	711	843	973	1136	1295	1453	1629
	Grade 11	Grade 12	Grade 13	Grade 14	Grade 15	Grade 16	Grade 17	Grade 18	Grade 19	Grade 20
Standard Sofa: Low (L), Medium (M), High Screen (H)	1194	1319	1444	1569	1696	1821	1946	2072	2198	2323
Wide Sofa: Low (L), Medium (M), High Screen (H)	1755	1880	2006	2131	2257	2383	2508	2633	2760	2885
	Leather LA	Leather LB	Leather LC	Leather LD						
Standard Sofa: Low (L), Medium (M), High Screen (H)	1632	1884	2448	2761						
Wide Sofa: Low (L), Medium (M), High Screen (H)	2520	2913	3798	4290						
	SCREEN UPHOLSTERY									
	Grade 1	COM/ Grade 2	COL/ Grade 3	Grade 4	Grade 5	Grade 6	Grade 7	Grade 8	Grade 9	Grade 10
Standard Sofa: Low Screen (L)	84	302	507	653	771	891	1037	1183	1328	1489
Standard Sofa: Medium Screen (M)	84	372	644	835	993	1150	1343	1535	1727	1938
Standard Sofa: High Screen (H)	84	389	677	882	1049	1215	1419	1623	1827	2051
Wide Sofa: Low Screen (L)	123	434	762	995	1186	1377	1611	1844	2078	2330
Wide Sofa: Medium Screen (M)	123	557	1001	1315	1573	1830	2145	2460	2775	3119
Wide Sofa: High Screen (H)	123	587	1060	1394	1670	1944	2278	2615	2949	3316
	Grade 11	Grade 12	Grade 13	Grade 14	Grade 15	Grade 16	Grade 17	Grade 18	Grade 19	Grade 20
Standard Sofa: Low Screen (L)	1710	1931	2152	2373	2594	2815	3036	3257	3478	3699
Standard Sofa: Medium Screen (M)	2159	2380	2601	2822	3043	3264	3485	3706	3927	4148
Standard Sofa: High Screen (H)	2271	2493	2713	2935	3155	3377	3597	3819	4039	4261
Wide Sofa: Low Screen (L)	2552	2772	2994	3214	3436	3656	3878	4098	4320	4540
Wide Sofa: Medium Screen (M)	3340	3561	3782	4003	4224	4445	4666	4887	5107	5329
Wide Sofa: High Screen (H)	3537	3758	3979	4200	4421	4642	4863	5084	5305	5526
	Leather LA	Leather LB	Leather LC	Leather LD						
Standard Sofa: Low Screen (L)	2297	2654	3458	3908						
Standard Sofa: Medium Screen (M)	3004	3477	4539	5131						
Standard Sofa: High Screen (H)	3181	3682	4809	5437						
Wide Sofa: Low Screen (L)	3624	4198	5483	6201						
Wide Sofa: Medium Screen (M)	4864	5638	7375	8340						
Wide Sofa: High Screen (H)	5175	5998	7850	8875						

If Mica/Accent Paint Finish is specified	add	51
If Flintwood Finish is specified	add	150
If Veneer Finish is specified	add	173

banqs full alcove solo focus, standard overview

Banqs Full Alcove Solo Focus Sofas address various visual, acoustic, and spatial privacy needs with three screen heights.

Can be used in stand alone applications or combined with other Banqs components to create linear, perpendicular, and pinwheel layouts for any environment.

Banqs Full Alcove Solo Focus, Standard (NBF)

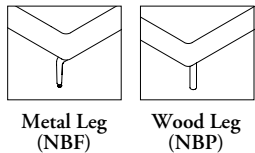
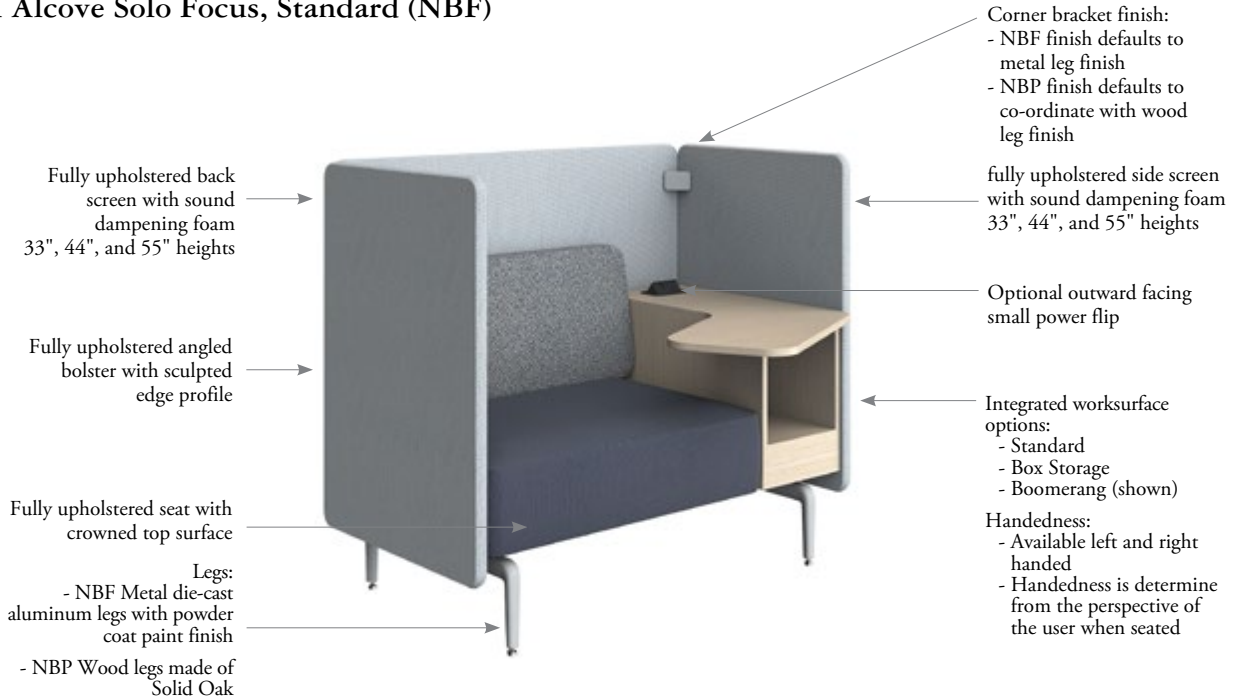

statement of line

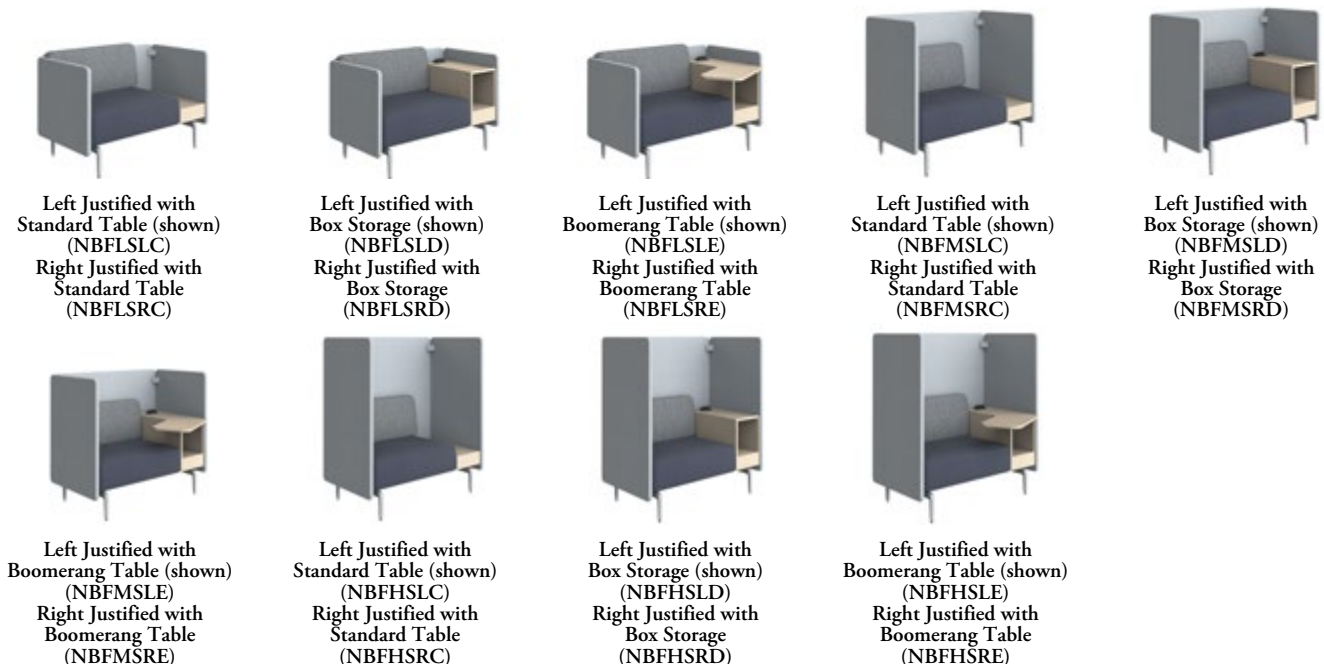

banqs full alcove solo focus, standard dimensions & material requirements

construction notes

- Weight capacity of 300 lbs. per seat (ie. 2-Seater capacity is 600 lbs.)
- Conforms to BIFMA X5.4-2020 lounge seating standards

weight metal legs (add 7 lbs. for wood legs)

Full Alcove Solo Focus, Low Screen, Standard Table	138 lbs
Full Alcove Solo Focus, Low Screen, Box Storage	157 lbs
Full Alcove Solo Focus, Low Screen, Boomerang Table	162 lbs
Full Alcove Solo Focus, Medium Screen, Standard Table	169 lbs
Full Alcove Solo Focus, Medium Screen, Box Storage	188 lbs
Full Alcove Solo Focus, Medium Screen, Boomerang Table	193 lbs
Full Alcove Solo Focus, High Screen, Standard Table	190 lbs
Full Alcove Solo Focus, High Screen, Box Storage	209 lbs
Full Alcove Solo Focus, High Screen, Boomerang Table	214 lbs

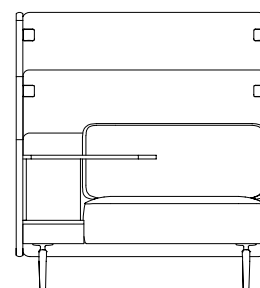
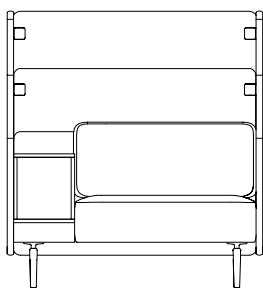
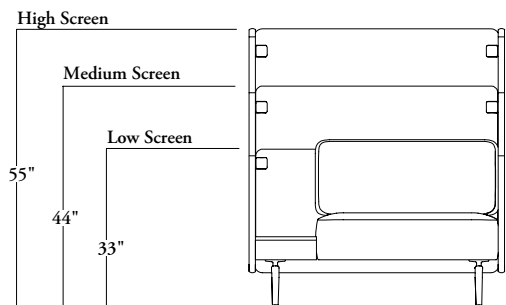
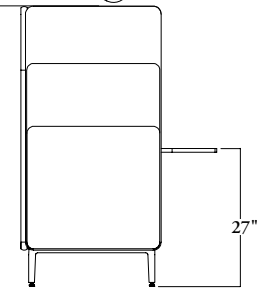
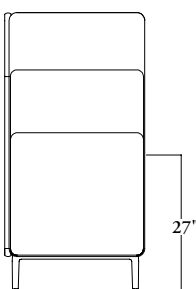
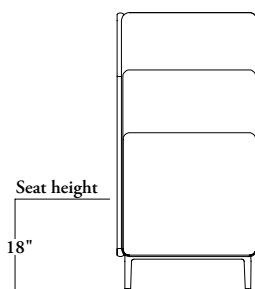
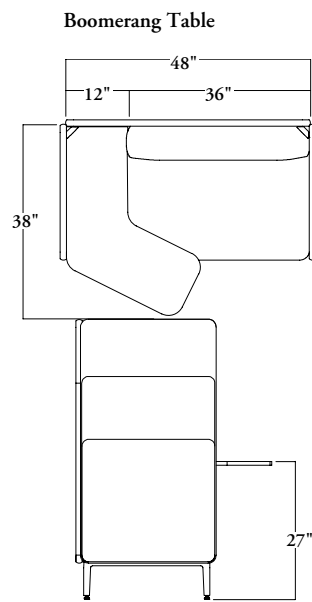
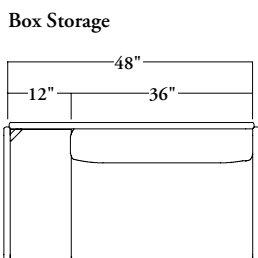
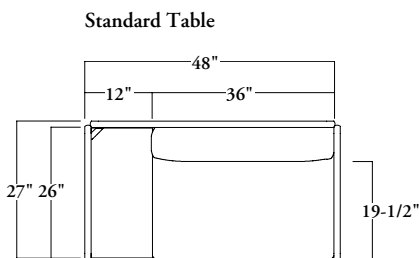

COM/COL material requirement

The pattern, repeat and directionality of fabric may increase the amount of yardage required.

Leather quantities should always be rounded up to the next hide size, as yields vary from 60-80% and are affected by the quality, size and shape of the hide, and by the location and quantity of blemishes.

	SEAT		BOLSTER		SCREEN	
	COM [yards]	COL [sq. ft]	COM [yards]	COL [sq. ft]	COM [yards]	COL [sq. ft]
Low Screen	2.25	38	1.75	30	5.25	90
Medium Screen	2.25	38	1.75	30	7	120
High Screen	2.25	38	1.75	30	9	152

banqs full alcove solo focus, wide overview

Banqs Full Alcove Solo Focus Sofas address various visual, acoustic, and spatial privacy needs with three screen heights.

Can be used in stand alone applications or combined with other Banqs components to create wider linear, perpendicular, and pinwheel layouts for any environment.

Banqs Full Alcove Solo Focus, Wide (NBF)

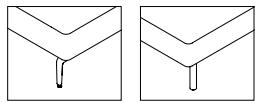

Metal Leg (NBF)

Wood Leg (NBP)

statement of line

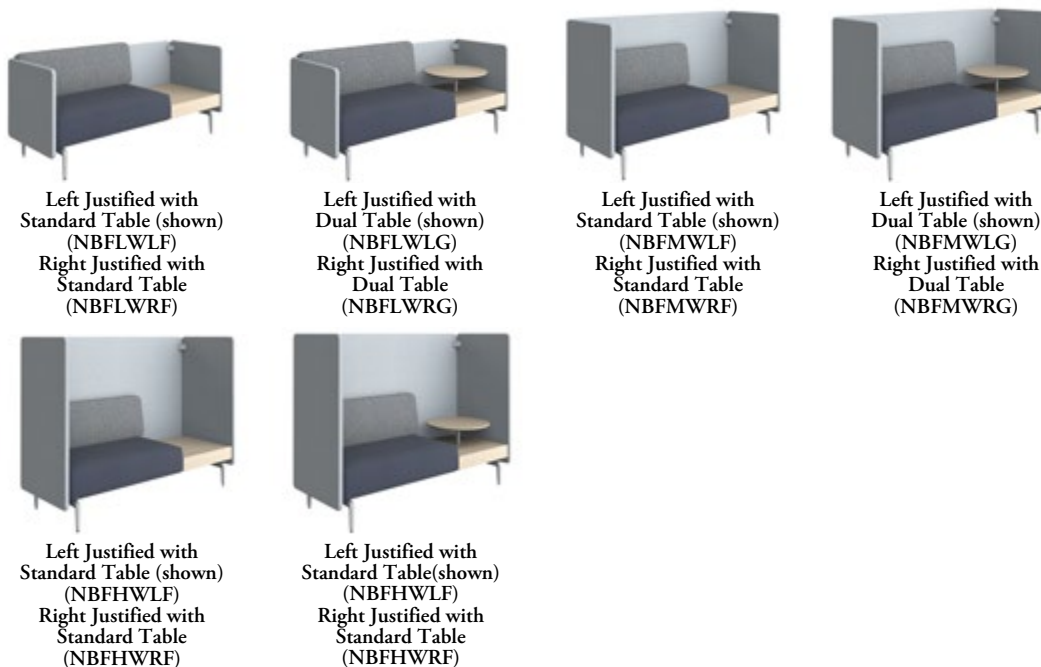

banqs full alcove solo focus, wide dimensions & material requirements

construction notes

- Weight capacity of 300 lbs. per seat (ie. 2-Seater capacity is 600 lbs.)
- Conforms to BIFMA X5.4-2020 lounge seating standards

weight metal legs (add 7 lbs. for wood legs)

Full Alcove Solo Focus, Low Screen, Standard Table	186 lbs
Full Alcove Solo Focus, Low Screen, Dual Table	206 lbs
Full Alcove Solo Focus, Medium Screen, Standard Table	227 lbs
Full Alcove Solo Focus, Medium Screen, Dual Table	247 lbs
Full Alcove Solo Focus, High Screen, Standard Table	251 lbs
Full Alcove Solo Focus, High Screen, Dual Table	271 lbs

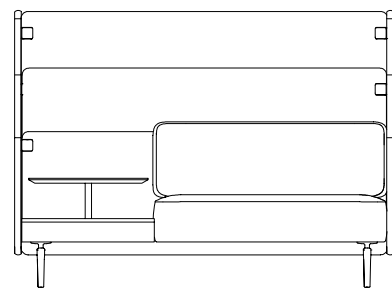
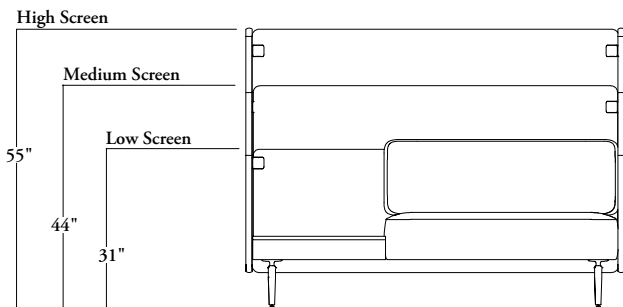
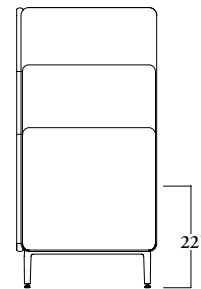
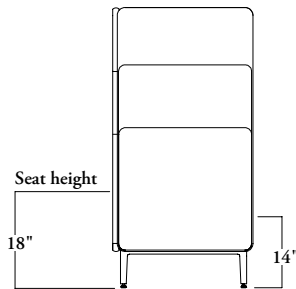
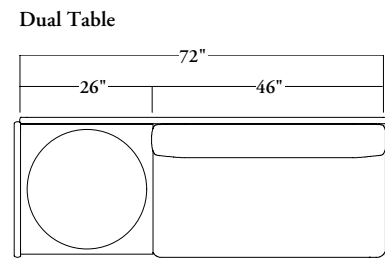
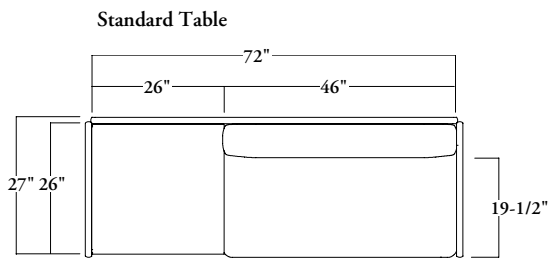

COM/COL material requirement

The pattern, repeat and directionality of fabric may increase the amount of yardage required.

Leather quantities should always be rounded up to the next hide size, as yields vary from 60-80% and are affected by the quality, size and shape of the hide, and by the location and quantity of blemishes.

	SEAT		BOLSTER		SCREEN	
	COM [yards]	COL [sq. ft]	COM [yards]	COL [sq. ft]	COM [yards]	COL [sq. ft]
Low Screen	2.25	38	2	34	6.75	114
Medium Screen	2.25	38	2	34	9.5	158
High Screen	2.25	38	2	34	11.75	199

NBF / NBP

Banqs Full Alcove Solo Focus

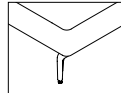
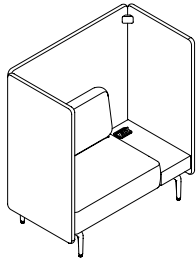

Metal Leg (NBF)

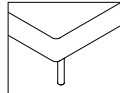

Wood Leg (NBP)

FEATURES

- Standard and wide options
- Legs available in Metal (NBF) or Wood (NBP)
- Available in single and triple upholstery
- Standard, box storage, and boomerang (standard width) and standard and dual (wide width) table options
- Optional small power flip available in black or white finish
- Ships fully assembled

NOTES

- Laminate/veneer finish applies to entire table
- Ganging plates and kits must be ordered separately for linear, perpendicular, or pinwheel applications
- Undermount electrical module must be specified as separate item (includes cable management)
- Low screen sofas (33"H) that have either Box Storage or Boomerang tables specified next to a side screen do not require the screen connector bracket at top

PRODUCT OPTIONS

Screen Height	Sofa Size	Table Orientation	Table	Electrics
L Low Screen Height	S Standard (Shown)	L Left (shown)	C Standard (Standard Size Only)	N None
M Medium Screen Height	W Wide	R Right	D Box Storage (Standard Size Only)	B Small Power Flip Black
H High Screen Height (Shown)			E Boomerang (Standard Size Only)	W Small Power Flip White
			F Standard (Wide Size Only)	
			G Dual (Wide Size Only)	

SAMPLE ORDER CODE

NBF H	S	R	C	W
--------------	----------	----------	----------	----------

PRODUCT OPTIONS (CONTINUED)

Table Surface Finish	Seat Upholstery Finish	Bolster Upholstery Finish	Screen Upholstery Finish	Metal Leg Finish (if metal leg is specified)
Foundation Laminate	Fabric	Fabric	Fabric	Foundation
Flintwood	Leather	Leather	Leather	Mica
Natural Veneer				Accent
Zones Exclusive Laminate				Wood Leg Finish (if wood leg is specified)
				N56 Stain Finishes

SAMPLE ORDER CODE (CONTINUED)

LW	E515	E515	E515	24
-----------	-------------	-------------	-------------	-----------

See pricing on the following page.

N B F / N B P
Banqs Full Alcove Solo Focus
(Continued)

DESCRIPTION

PRICE

	LOW SCREEN (L)									
	STANDARD SOFA (S)									
	COM/ Grade 1	COL/ Grade 2	Grade 3	Grade 4	Grade 5	Grade 6	Grade 7	Grade 8	Grade 9	Grade 10
Standard Table (C), None Electric (N)	7484	7617	7740	7828	7898	7970	8059	8146	8234	8328
Standard Table (C), Small Power Flip Black (B) / White (W)	8413	8543	8666	8753	8826	8897	8984	9072	9159	9254
Box Storage (D), None Electric (N)	7940	8071	8194	8282	8354	8425	8513	8600	8688	8782
Box Storage (D), Small Power Flip Black (B) / White (W)	8868	8999	9122	9209	9281	9353	9439	9527	9614	9710
Boomerang (E), None Electric (N)	8046	8178	8301	8389	8460	8532	8620	8707	8795	8889
Boomerang (E), Small Power Flip Black (B) / White (W)	8975	9105	9228	9315	9388	9459	9546	9634	9721	9816
	Grade 11	Grade 12	Grade 13	Grade 14	Grade 15	Grade 16	Grade 17	Grade 18	Grade 19	Grade 20
Standard Table (C), None Electric (N)	8432	8538	8642	8748	8853	8958	9063	9167	9273	9377
Standard Table (C), Small Power Flip Black (B) / White (W)	9360	9464	9570	9674	9780	9886	9990	10095	10200	10305
Box Storage (D), None Electric (N)	8888	8992	9098	9202	9308	9413	9518	9623	9728	9833
Box Storage (D), Small Power Flip Black (B) / White (W)	9815	9920	10025	10130	10236	10340	10446	10550	10656	10760
Boomerang (E), None Electric (N)	8993	9099	9205	9309	9415	9519	9625	9729	9834	9939
Boomerang (E), Small Power Flip Black (B) / White (W)	9921	10026	10131	10237	10341	10447	10551	10657	10761	10867
	Leather LA	Leather LB	Leather LC	Leather LD						
Standard Table (C), None Electric (N)	8813	9028	9511	9780						
Standard Table (C), Small Power Flip Black (B) / White (W)	9741	9955	10439	10708						
Box Storage (D), None Electric (N)	9268	9483	9966	10236						
Box Storage (D), Small Power Flip Black (B) / White (W)	10195	10410	10895	11163						
Boomerang (E), None Electric (N)	9374	9590	10072	10341						
Boomerang (E), Small Power Flip Black (B) / White (W)	10302	10517	11001	11269						
	WIDE SOFA (W)									
	COM/ Grade 1	COL/ Grade 2	Grade 3	Grade 4	Grade 5	Grade 6	Grade 7	Grade 8	Grade 9	Grade 10
Standard Table (F), None Electric (N)	9621	9818	10004	10136	10243	10350	10481	10612	10743	10887
Standard Table (F), Small Power Flip Black (B) / White (W)	10549	10746	10932	11063	11170	11278	11409	11540	11671	11815
Dual Table (G), None Electric (N)	9976	10173	10359	10491	10598	10704	10836	10967	11098	11242
Dual Table (G), Small Power Flip Black (B) / White (W)	10904	11101	11287	11418	11525	11632	11764	11895	12026	12170
	Grade 11	Grade 12	Grade 13	Grade 14	Grade 15	Grade 16	Grade 17	Grade 18	Grade 19	Grade 20
Standard Table (F), None Electric (N)	10991	11097	11201	11307	11411	11516	11622	11726	11832	11936
Standard Table (F), Small Power Flip Black (B) / White (W)	11920	12025	12130	12235	12340	12446	12550	12656	12760	12866
Dual Table (G), None Electric (N)	11346	11452	11556	11661	11767	11871	11977	12081	12187	12291
Dual Table (G), Small Power Flip Black (B) / White (W)	12275	12380	12485	12589	12695	12801	12905	13011	13115	13221
	Leather LA	Leather LB	Leather LC	Leather LD						
Standard Table (F), None Electric (N)	11614	11936	12660	12732						
Standard Table (F), Small Power Flip Black (B) / White (W)	12541	12863	13588	13659						
Dual Table (G), None Electric (N)	11969	12291	13015	13087						
Dual Table (G), Small Power Flip Black (B) / White (W)	12896	13218	13943	14014						

Pricing and options are continued on the following pages.

N B F / N B P

Banqs Full Alcove Solo Focus (Continued)

DESCRIPTION

PRICE

	MEDIUM SCREEN (L)									
	STANDARD SOFA (S)									
	Grade 1	COM/ Grade 2	COL/ Grade 3	Grade 4	Grade 5	Grade 6	Grade 7	Grade 8	Grade 9	Grade 10
Standard Table (C), None Electric (N)	7697	7829	7952	8039	8110	8183	8270	8358	8445	8540
Standard Table (C), Small Power Flip Black (B) / White (W)	8625	8755	8877	8966	9039	9108	9196	9283	9372	9466
Box Storage (D), None Electric (N)	8152	8284	8407	8494	8565	8637	8724	8813	8900	8995
Box Storage (D), Small Power Flip Black (B) / White (W)	9079	9210	9333	9422	9493	9564	9652	9739	9828	9921
Boomerang (E), None Electric (N)	8258	8390	8513	8600	8671	8744	8831	8919	9006	9101
Boomerang (E), Small Power Flip Black (B) / White (W)	9186	9316	9439	9527	9600	9670	9758	9845	9933	10027
	Grade 11	Grade 12	Grade 13	Grade 14	Grade 15	Grade 16	Grade 17	Grade 18	Grade 19	Grade 20
Standard Table (C), None Electric (N)	8645	8750	8855	8960	9065	9170	9275	9380	9485	9591
Standard Table (C), Small Power Flip Black (B) / White (W)	9571	9677	9781	9887	9991	10097	10201	10307	10412	10517
Box Storage (D), None Electric (N)	9100	9206	9310	9416	9520	9626	9730	9836	9941	10046
Box Storage (D), Small Power Flip Black (B) / White (W)	10026	10131	10237	10341	10447	10551	10657	10761	10867	10972
Boomerang (E), None Electric (N)	9207	9311	9417	9521	9627	9731	9837	9942	10047	10152
Boomerang (E), Small Power Flip Black (B) / White (W)	10133	10238	10343	10448	10553	10658	10762	10868	10974	11078
	Leather LA	Leather LB	Leather LC	Leather LD						
Standard Table (C), None Electric (N)	9024	9241	9723	9991						
Standard Table (C), Small Power Flip Black (B) / White (W)	9953	10166	10651	10920						
Box Storage (D), None Electric (N)	9480	9695	10179	10447						
Box Storage (D), Small Power Flip Black (B) / White (W)	10408	10622	11106	11375						
Boomerang (E), None Electric (N)	9585	9802	10285	10553						
Boomerang (E), Small Power Flip Black (B) / White (W)	10514	10728	11213	11482						
	WIDE SOFA (W)									
	Grade 1	COM/ Grade 2	COL/ Grade 3	Grade 4	Grade 5	Grade 6	Grade 7	Grade 8	Grade 9	Grade 10
Standard Table (F), None Electric (N)	9554	9752	9937	10070	10177	10283	10414	10546	10675	10819
Standard Table (F), Small Power Flip Black (B) / White (W)	10483	10680	10866	10996	11104	11211	11342	11474	11605	11748
Dual Table (G), None Electric (N)	9909	10107	10292	10425	10532	10638	10769	10901	11032	11174
Dual Table (G), Small Power Flip Black (B) / White (W)	10838	11035	11221	11351	11458	11566	11697	11829	11960	12103
	Grade 11	Grade 12	Grade 13	Grade 14	Grade 15	Grade 16	Grade 17	Grade 18	Grade 19	Grade 20
Standard Table (F), None Electric (N)	10925	11029	11135	11240	11345	11450	11555	11660	11765	11870
Standard Table (F), Small Power Flip Black (B) / White (W)	11853	11958	12064	12168	12274	12378	12484	12588	12694	12799
Dual Table (G), None Electric (N)	11280	11385	11490	11595	11700	11805	11910	12015	12121	12225
Dual Table (G), Small Power Flip Black (B) / White (W)	12209	12313	12419	12523	12629	12733	12839	12943	13049	13154
	Leather LA	Leather LB	Leather LC	Leather LD						
Standard Table (F), None Electric (N)	11548	11870	12594	12997						
Standard Table (F), Small Power Flip Black (B) / White (W)	12475	12796	13522	13925						
Dual Table (G), None Electric (N)	11903	12225	12949	13352						
Dual Table (G), Small Power Flip Black (B) / White (W)	12830	13152	13877	14280						

Pricing and options are continued on the following pages.

N B F / N B P
Banqs Full Alcove Solo Focus
(Continued)

DESCRIPTION

PRICE

	HIGH SCREEN (L)									
	STANDARD SOFA (S)									
	COM/ Grade 1	COL/ Grade 2	Grade 3	Grade 4	Grade 5	Grade 6	Grade 7	Grade 8	Grade 9	Grade 10
Standard Table (C), None Electric (N)	7750	7882	8005	8092	8163	8236	8323	8411	8498	8593
Standard Table (C), Small Power Flip Black (B) / White (W)	8678	8808	8931	9019	9092	9162	9250	9337	9425	9519
Box Storage (D), None Electric (N)	8206	8337	8460	8547	8619	8691	8778	8866	8953	9048
Box Storage (D), Small Power Flip Black (B) / White (W)	9133	9264	9387	9475	9547	9618	9706	9792	9880	9975
Boomerang (E), None Electric (N)	8311	8444	8567	8654	8724	8797	8884	8973	9060	9155
Boomerang (E), Small Power Flip Black (B) / White (W)	9239	9369	9492	9580	9654	9723	9811	9898	9986	10080
	Grade 11	Grade 12	Grade 13	Grade 14	Grade 15	Grade 16	Grade 17	Grade 18	Grade 19	Grade 20
Standard Table (C), None Electric (N)	8698	8803	8908	9013	9119	9223	9329	9433	9539	9643
Standard Table (C), Small Power Flip Black (B) / White (W)	9625	9729	9834	9939	10044	10150	10254	10360	10464	10570
Box Storage (D), None Electric (N)	9154	9258	9364	9468	9573	9679	9783	9889	9993	10099
Box Storage (D), Small Power Flip Black (B) / White (W)	10079	10185	10289	10395	10499	10605	10710	10815	10920	11025
Boomerang (E), None Electric (N)	9259	9365	9470	9575	9680	9785	9890	9995	10100	10205
Boomerang (E), Small Power Flip Black (B) / White (W)	10186	10290	10396	10501	10606	10711	10816	10921	11026	11131
	Leather LA	Leather LB	Leather LC	Leather LD						
Standard Table (C), None Electric (N)	9077	9294	9776	10044						
Standard Table (C), Small Power Flip Black (B) / White (W)	10006	10220	10703	10974						
Box Storage (D), None Electric (N)	9533	9749	10231	10499						
Box Storage (D), Small Power Flip Black (B) / White (W)	10461	10674	11159	11428						
Boomerang (E), None Electric (N)	9638	9855	10338	10606						
Boomerang (E), Small Power Flip Black (B) / White (W)	10568	10781	11265	11535						
	WIDE SOFA (W)									
	COM/ Grade 1	COL/ Grade 2	Grade 3	Grade 4	Grade 5	Grade 6	Grade 7	Grade 8	Grade 9	Grade 10
Standard Table (F), None Electric (N)	9621	9818	10004	10136	10243	10350	10481	10612	10743	10887
Standard Table (F), Small Power Flip Black (B) / White (W)	10549	10746	10932	11063	11170	11278	11409	11540	11671	11815
Dual Table (G), None Electric (N)	9539	9737	9921	10054	10160	10268	10398	10530	10660	10804
Dual Table (G), Small Power Flip Black (B) / White (W)	10467	10664	10849	10981	11087	11195	11327	11457	11588	11732
	Grade 11	Grade 12	Grade 13	Grade 14	Grade 15	Grade 16	Grade 17	Grade 18	Grade 19	Grade 20
Standard Table (F), None Electric (N)	10991	11097	11201	11307	11411	11516	11622	11726	11832	11936
Standard Table (F), Small Power Flip Black (B) / White (W)	11920	12025	12130	12235	12340	12446	12550	12656	12760	12866
Dual Table (G), None Electric (N)	10909	11014	11120	11224	11330	11434	11540	11644	11750	11854
Dual Table (G), Small Power Flip Black (B) / White (W)	11838	11942	12048	12153	12258	12363	12468	12573	12678	12783
	Leather LA	Leather LB	Leather LC	Leather LD						
Standard Table (F), None Electric (N)	11614	11936	12660	13064						
Standard Table (F), Small Power Flip Black (B) / White (W)	12541	12863	13588	13991						
Dual Table (G), None Electric (N)	11533	11854	12578	12982						
Dual Table (G), Small Power Flip Black (B) / White (W)	12458	12781	13507	13908						

Pricing and options are continued on the following pages.

NBF / NBP

Banqs Full Alcove Solo Focus (Continued)

DESCRIPTION

PRICE

BOLSTER UPHOLSTERY										
	COM/ Grade 1	COL/ Grade 2	Grade 3	Grade 4	Grade 5	Grade 6	Grade 7	Grade 8	Grade 9	Grade 10
Standard Sofa: Low (L), Medium (M), High Screen (H)	84	302	507	653	771	891	1037	1183	1328	1489
Wide Sofa: Low (L), Medium (M), High Screen (H)	123	389	677	882	1049	1215	1419	1623	1827	2051
	Grade 11	Grade 12	Grade 13	Grade 14	Grade 15	Grade 16	Grade 17	Grade 18	Grade 19	Grade 20
Standard Sofa: Low (L), Medium (M), High Screen (H)	1656	1825	1993	2160	2328	2496	2663	2832	3000	3168
Wide Sofa: Low (L), Medium (M), High Screen (H)	2218	2386	2554	2721	2890	3058	3226	3393	3561	3729
	Leather LA	Leather LB	Leather LC	Leather LD						
Standard Sofa: Low (L), Medium (M), High Screen (H)	2297	2654	3458	3908						
Wide Sofa: Low (L), Medium (M), High Screen (H)	3181	3682	4809	5437						
SCREEN UPHOLSTERY										
	COM/ Grade 1	COL/ Grade 2	Grade 3	Grade 4	Grade 5	Grade 6	Grade 7	Grade 8	Grade 9	Grade 10
Standard Sofa: Low Screen (L)	84	412	719	940	1118	1297	1515	1734	1952	2190
Standard Sofa: Medium Screen (M)	84	516	923	1213	1449	1685	1973	2262	2552	2865
Standard Sofa: High Screen (H)	84	542	974	1283	1531	1783	2088	2393	2702	3035
Wide Sofa: Low Screen (L)	123	542	974	1283	1531	1783	2088	2393	2702	3035
Wide Sofa: Medium Screen (M)	123	699	1278	1690	2027	2363	2774	3184	3597	4044
Wide Sofa: High Screen (H)	123	739	1355	1793	2151	2508	2945	3383	3821	4297
	Grade 11	Grade 12	Grade 13	Grade 14	Grade 15	Grade 16	Grade 17	Grade 18	Grade 19	Grade 20
Standard Sofa: Low Screen (L)	2495	2799	3103	3408	3712	4016	4321	4625	4929	5234
Standard Sofa: Medium Screen (M)	3170	3474	3778	4083	4387	4691	4996	5300	5604	5909
Standard Sofa: High Screen (H)	3338	3644	3947	4251	4556	4860	5164	5469	5773	6077
Wide Sofa: Low Screen (L)	3338	3644	3947	4251	4556	4860	5164	5469	5773	6077
Wide Sofa: Medium Screen (M)	4349	4653	4957	5262	5566	5870	6175	6479	6783	7088
Wide Sofa: High Screen (H)	4601	4906	5210	5513	5819	6122	6426	6731	7035	7339
	Leather LA	Leather LB	Leather LC	Leather LD						
Standard Sofa: Low Screen (L)	3405	3941	5148	5819						
Standard Sofa: Medium Screen (M)	4467	5175	6769	7655						
Standard Sofa: High Screen (H)	4733	5482	7175	8113						
Wide Sofa: Low Screen (L)	4733	5482	7175	8113						
Wide Sofa: Medium Screen (M)	6324	7332	9604	10865						
Wide Sofa: High Screen (H)	6721	7795	10211	11552						

If Mica/Accent Paint Finish is specified add 51

If Flintwood Finish is specified add 150

If Veneer Finish is specified add 173

banqs rectangular bench, no back overview

The Banqs Rectangular Bench, No Back is available as a 2-Seater or 3-Seater and is ideal for providing multi-directional seating with open sight lines.

Can be used in stand alone applications or combined with other Banqs components to create linear, perpendicular, and pinwheel layouts for any environment.

Banqs Rectangular Bench, No Back (NBAR)

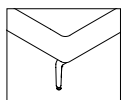

Metal Leg (NBAR)

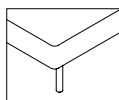

Wood Leg (NBWR)

statement of line



Two-Seater (NBAR2)



Three-Seater (NBAR3)

banqs rectangular bench, no back dimensions & material requirements

construction notes

- Weight capacity of 300 lbs. per seat (ie. 2-Seater capacity is 600 lbs.)
- Conforms to BIFMA X5.4-2020 lounge seating standards

weight metal legs (add 7 lbs. for wood legs)

Bench, No Back, Two Seater	61 lbs
Bench, No Back, Three Seater	84 lbs

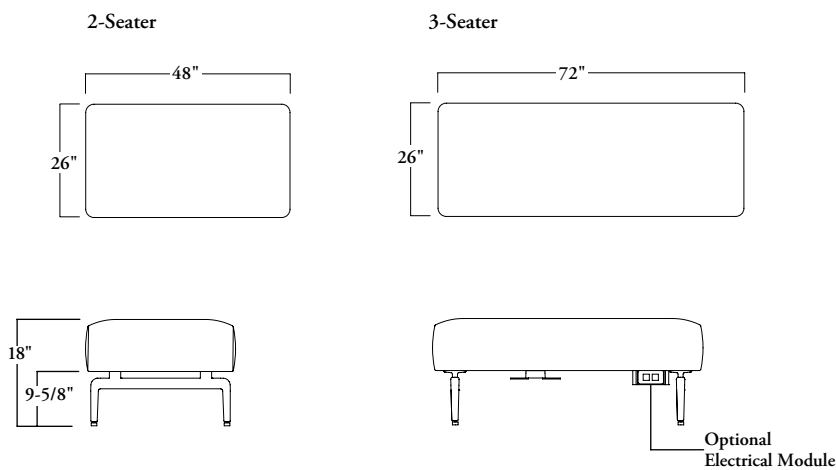

COM/COL material requirement

The pattern, repeat and directionality of fabric may increase the amount of yardage required.

Leather quantities should always be rounded up to the next hide size, as yields vary from 60-80% and are affected by the quality, size and shape of the hide, and by the location and quantity of blemishes.

	COM [yards]	COL [sq. ft]
Bench, No Back, Two Seater	2.25	38
Bench, No Back, Three Seater	3.5	60

NBAR / NBWR

Banqs Rectangular Bench, No Back

FEATURES

- 2-seater and 3-seater options
- Legs available in Metal (NBAR) or Wood (NBWR)
- Optional undermount electrical available with black or white faceplate
- Ships fully assembled

NOTES

- Ganging plates must be ordered separately for linear and perpendicular applications

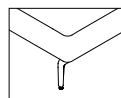
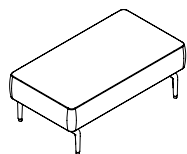

Metal Leg
(NBAR)

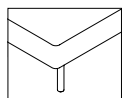

Wood Leg
(NBWR)

PRODUCT OPTIONS

Size	Electrical Option	Electrical Position	Upholstery Style	Seat Upholstery Finish	Paint Finish	Country of Installation	Metal Leg Finish (if metal leg is specified)
2 Two-Seater (Shown)	N No Electrical Module	R Right-Handed L Left Handed	S Single Upholstery	Fabric Leather	Foundation Mica Accent	A U.S. and Canada	Foundation Mica Accent
3 Three-Seater	W One Power, One USB A, One USB-C - White X One Power, One USB A, One USB-C - Black						Wood Leg Finish (if wood leg is specified) N56 Stain Finishes

SAMPLE ORDER CODE

NBAR 2	W	R	S	E515	24	A	24
---------------	----------	----------	----------	-------------	-----------	----------	-----------

DESCRIPTION

2-Seat Sofa
3-Seat Sofa
2-Seat Sofa
3-Seat Sofa
2-Seat Sofa
3-Seat Sofa

PRICE

Grade 1	COM/ Grade 2	COL/ Grade 3	Grade 4	Grade 5	Grade 6	Grade 7	Grade 8	Grade 9	Grade 10
3314	3444	3567	3654	3727	3798	3885	3973	4060	4155
4108	4305	4490	4621	4730	4836	4968	5098	5230	5372
Grade 11	Grade 12	Grade 13	Grade 14	Grade 15	Grade 16	Grade 17	Grade 18	Grade 19	Grade 20
4257	4358	4459	4561	4662	4764	4865	4967	5068	5170
5474	5575	5677	5778	5880	5981	6083	6184	6285	6387
Leather LA	Leather LB	Leather LC	Leather LD						
4641	4855	5338	5606						
6100	6422	7148	7549						

If Mica/Accent Paint Finish is specified add 51

If One Power, One USB A, One USB-C - White (W) option is specified add 926

If One Power, One USB A, One USB-C - Black (X) option is specified add 926

banqs single-sided sofa overview

Banqs Single-Sided Sofas address various visual, acoustic, and spatial privacy needs with three screen heights.

Can be used in stand alone applications or combined with other Banqs components to create linear, perpendicular, and pinwheel layouts for any environment.

Banqs Single-Sided Sofa (NBAS)



statement of line



banqs single-sided sofa dimensions & material requirements

construction notes

- Weight capacity of 300 lbs. per seat (ie. 2-Seater capacity is 600 lbs.)
- Conforms to BIFMA X5.4-2020 lounge seating standards

weight metal legs (add 7 lbs. for wood legs)

Single-Sided Sofa, Low Screen, Two Seater	106 lbs
Single-Sided Sofa, Low Screen, Three Seater	152 lbs
Single-Sided Sofa, Medium Screen, Two Seater	121 lbs
Single-Sided Sofa, Medium Screen, Two Seater	177lbs
Single-Sided Sofa, High Screen, Two Seater	131 lbs
Single-Sided Sofa, High Screen, Three Seater	189 lbs

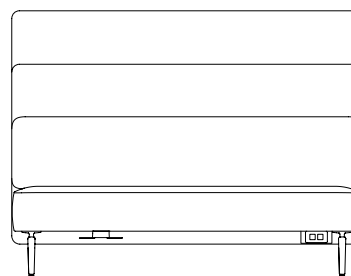
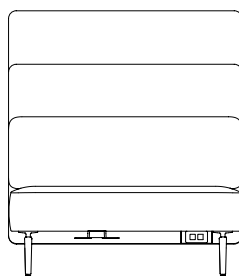
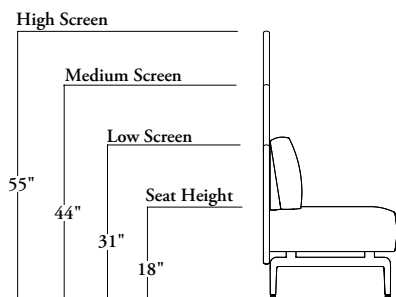
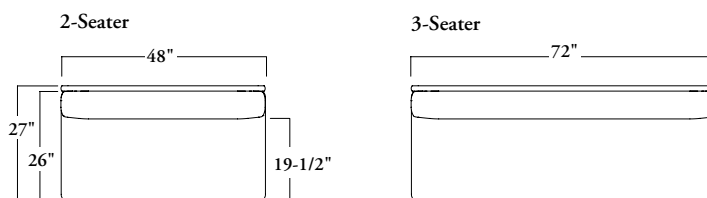

COM/COL material requirement

The pattern, repeat and directionality of fabric may increase the amount of yardage required.

Leather quantities should always be rounded up to the next hide size, as yields vary from 60-80% and are affected by the quality, size and shape of the hide, and by the location and quantity of blemishes.

	SINGLE UPHOLSTERY		TRIPLE UPHOLSTERY - SEAT		TRIPLE UPHOLSTERY - BOLSTER		TRIPLE UPHOLSTERY - SCREEN	
	COM [yards]	COL [sq. ft]	COM [yards]	COL [sq. ft]	COM [yards]	COL [sq. ft]	COM [yards]	COL [sq. ft]
Low Screen, 2-Seat	5.5	93	2.25	38	1.5	26	1.75	30
Low Screen, 3-Seat	8.75	148	3.2	60	2	34	3.25	55
Medium Screen, 2-Seat	6.25	105	2.25	38	1.5	26	2.5	42.5
Medium Screen, 3-Seat	10.25	172.75	3.5	60	2	34	4.75	78.75
High Screen, 2-Seat	6.75	114	2.25	38	1.5	26	3	51
High Screen, 3-Seat	11.25	190	3.5	60	2	34	5.75	98

NBAS / NBWS

Banqs Single-Sided Sofa

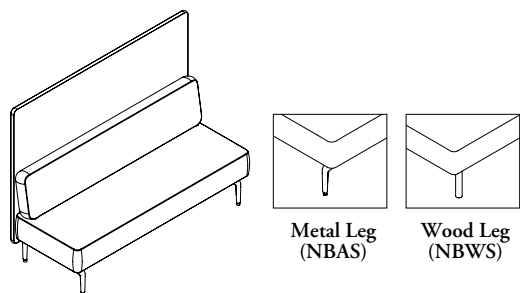

FEATURES

- 2-seater and 3-seater options
- Legs available in Metal (NBAS) or Wood (NBWS)
- Available in single and triple upholstery
- Optional undermount electrical available with black or white faceplate
- Includes threaded inserts for connecting Spanning Screen Kits
- Ships fully assembled

NOTES

- Ganging plates and kits must be ordered separately for linear, perpendicular, and pinwheel applications

PRODUCT OPTIONS

Screen Height	Size	Electrical Option	Electrical Position	Upholstery Style	Seat Upholstery Finish
L Low	2 Two-Seater	N No Electrical Module	R Right-Handed	S Single Upholstery	Fabric
M Medium	3 Three-Seater (Shown)	W One Power, One USB A, One USB-C - White	L Left Handed	T Triple Upholstery	Leather
H High (Shown)		X One Power, One USB A, One USB-C - Black			

SAMPLE ORDER CODE

NBAS H	2	W	R	T	E515
---------------	----------	----------	----------	----------	-------------

PRODUCT OPTIONS (CONTINUED)

Bolster Upholstery Finish	Screen Upholstery Finish	Paint Finish	Country of Installation	Metal Leg Finish (if metal leg is specified)
Fabric	Fabric	Foundation	A U.S. and Canada	Foundation
Leather	Leather	Mica Accent		Mica Accent
				Wood Leg Finish (if wood leg is specified)
				N56 Stain Finishes

SAMPLE ORDER CODE (CONTINUED)

E515	E515	24	A	24
-------------	-------------	-----------	----------	-----------

See pricing on the following page.

N B A S / N B W S
Banqs Single-Sided Sofa
(Continued)

DESCRIPTION

PRICE

SINGLE UPHOLSTERY (S)

	Grade 1	COM/ Grade 2	COL/ Grade 3	Grade 4	Grade 5	Grade 6	Grade 7	Grade 8	Grade 9	Grade 10
Low Screen, 2-Seat Sofa	4969	5298	5605	5826	6004	6183	6400	6620	6838	7076
Low Screen, 3-Seat Sofa	6691	7303	7880	8286	8621	8954	9362	9771	10179	10624
Medium Screen, 2-Seat Sofa	5128	5490	5832	6074	6272	6470	6713	6955	7195	7460
Medium Screen, 2-Seat Sofa	6902	7604	8263	8728	9109	9491	9957	10425	10890	11399
High Screen, 2-Seat Sofa	5168	5539	5889	6136	6339	6542	6792	7039	7285	7557
High Screen, 3-Seat Sofa	6955	7679	8358	8838	9231	9626	10106	10587	11068	11593

	Grade 11	Grade 12	Grade 13	Grade 14	Grade 15	Grade 16	Grade 17	Grade 18	Grade 19	Grade 20
Low Screen, 2-Seat Sofa	7402	7728	8054	8381	8707	9033	9359	9685	10011	10337
Low Screen, 3-Seat Sofa	10950	11276	11602	11928	12254	12580	12906	13232	13558	13884
Medium Screen, 2-Seat Sofa	7786	8112	8439	8765	9091	9417	9743	10069	10395	10721
Medium Screen, 3-Seat Sofa	11725	12051	12377	12703	13029	13355	13682	14008	14334	14660
High Screen, 2-Seat Sofa	7883	8209	8535	8861	9187	9513	9839	10165	10491	10817
High Screen, 3-Seat Sofa	11919	12245	12571	12897	13223	13549	13875	14201	14527	14853

	Leather LA	Leather LB	Leather LC	Leather LD
Low Screen, 2-Seat Sofa	8289	8826	10034	10703
Low Screen, 3-Seat Sofa	12888	13890	16143	17395
Medium Screen, 2-Seat Sofa	8802	9396	10731	11475
Medium Screen, 3-Seat Sofa	13985	15130	17706	19138
High Screen, 2-Seat Sofa	8930	9539	10906	11667
High Screen, 3-Seat Sofa	14259	15440	18097	19574

TRIPLE UPHOLSTERY (T)

BASE PRICE - SEAT UPHOLSTERY (The seat, bolster and screen prices must be added together for a complete price)

	Grade 1	COM/ Grade 2	COL/ Grade 3	Grade 4	Grade 5	Grade 6	Grade 7	Grade 8	Grade 9	Grade 10
Low Screen, 2-Seat Sofa	5053	5183	5306	5394	5467	5537	5625	5712	5800	5894
Low Screen, 3-Seat Sofa	6774	6973	7157	7288	7396	7504	7634	7766	7896	8040
Medium Screen, 2-Seat Sofa	5211	5342	5466	5554	5624	5696	5784	5871	5959	6054
Medium Screen, 3-Seat Sofa	6987	7184	7369	7502	7607	7715	7846	7978	8108	8252
High Screen, 2-Seat Sofa	5250	5382	5505	5594	5663	5736	5824	5911	6000	6093
High Screen, 3-Seat Sofa	7040	7237	7423	7554	7661	7769	7900	8032	8162	8306

	Grade 11	Grade 12	Grade 13	Grade 14	Grade 15	Grade 16	Grade 17	Grade 18	Grade 19	Grade 20
Low Screen, 2-Seat Sofa	6000	6104	6209	6314	6419	6525	6629	6735	6839	6945
Low Screen, 3-Seat Sofa	8146	8250	8355	8460	8565	8670	8775	8881	8985	9091
Medium Screen, 2-Seat Sofa	6158	6264	6368	6474	6578	6684	6789	6894	6999	7104
Medium Screen, 3-Seat Sofa	8358	8462	8568	8672	8778	8883	8988	9093	9198	9303
High Screen, 2-Seat Sofa	6198	6303	6409	6513	6619	6723	6829	6933	7039	7144
High Screen, 3-Seat Sofa	8411	8516	8621	8726	8831	8935	9041	9147	9251	9357

	Leather LA	Leather LB	Leather LC	Leather LD
Low Screen, 2-Seat Sofa	6381	6595	7077	7347
Low Screen, 3-Seat Sofa	8768	9090	9814	10217
Medium Screen, 2-Seat Sofa	6538	6754	7237	7506
Medium Screen, 3-Seat Sofa	8980	9302	10025	10428
High Screen, 2-Seat Sofa	6577	6794	7277	7546
High Screen, 3-Seat Sofa	9033	9355	10078	10482

Pricing and options are continued on the following pages.

N B A S / N B W S

Banqs Single-Sided Sofa (Continued)

DESCRIPTION

PRICE

TRIPLE UPHOLSTERY (T) (CONTINUED)

BOLSTER UPHOLSTERY (The seat, bolster and screen prices must be added together for a complete price)

	Grade 1	COM/ Grade 2	COL/ Grade 3	Grade 4	Grade 5	Grade 6	Grade 7	Grade 8	Grade 9	Grade 10
2-Seat Sofa Bolster	84	172	254	312	358	407	465	524	582	645
3-Seat Sofa Bolster	123	259	422	538	636	731	847	964	1081	1208
	Grade 11	Grade 12	Grade 13	Grade 14	Grade 15	Grade 16	Grade 17	Grade 18	Grade 19	Grade 20
2-Seat Sofa Bolster	730	814	899	983	1067	1152	1237	1321	1406	1491
3-Seat Sofa Bolster	1292	1377	1462	1545	1630	1714	1799	1884	1969	2053
	Leather LA	Leather LB	Leather LC	Leather LD						
2-Seat Sofa Bolster	969	1112	1435	1614						
3-Seat Sofa Bolster	1854	2140	2785	3142						

SCREEN UPHOLSTERY

(The seat, bolster and screen prices must be added together for a complete price)

	Grade 1	COM/ Grade 2	COL/ Grade 3	Grade 4	Grade 5	Grade 6	Grade 7	Grade 8	Grade 9	Grade 10
Low Screen, 2-Seat Sofa	84	195	297	371	430	490	561	636	708	788
Low Screen, 3-Seat Sofa	123	325	552	711	843	973	1136	1295	1453	1629
Medium Screen, 2-Seat Sofa	84	229	364	461	538	618	715	812	907	1012
Medium Screen, 3-Seat Sofa	123	412	719	938	1117	1296	1515	1734	1952	2190
High Screen, 2-Seat Sofa	84	237	382	483	566	651	754	855	956	1067
High Screen, 3-Seat Sofa	123	434	762	995	1186	1377	1611	1844	2078	2330
	Grade 11	Grade 12	Grade 13	Grade 14	Grade 15	Grade 16	Grade 17	Grade 18	Grade 19	Grade 20
Low Screen, 2-Seat Sofa	923	1060	1197	1333	1470	1607	1742	1879	2015	2152
Low Screen, 3-Seat Sofa	1766	1902	2038	2175	2311	2448	2584	2720	2857	2994
Medium Screen, 2-Seat Sofa	1148	1285	1421	1558	1695	1830	1967	2103	2240	2377
Medium Screen, 3-Seat Sofa	2327	2464	2600	2736	2873	3009	3146	3282	3419	3555
High Screen, 2-Seat Sofa	1204	1341	1477	1614	1749	1886	2023	2159	2296	2433
High Screen, 3-Seat Sofa	2467	2603	2740	2877	3013	3149	3286	3422	3559	3695
	Leather LA	Leather LB	Leather LC	Leather LD						
Low Screen, 2-Seat Sofa	1190	1371	1772	1998						
Low Screen, 3-Seat Sofa	2520	2913	3798	4290						
Medium Screen, 2-Seat Sofa	1544	1781	2313	2609						
Medium Screen, 3-Seat Sofa	3403	3941	5147	5819						
High Screen, 2-Seat Sofa	1632	1884	2448	2761						
High Screen, 3-Seat Sofa	3624	4198	5483	6201						

If Mica/Accent Paint Finish is specified

add 51

If One Power, One USB A, One USB-C option is specified

add 929

banqs back-to-back sofa overview

Banqs Back-to-Back Sofas address various visual, acoustic, and spatial privacy needs with three screen heights.

Can be used in stand alone applications or combined with other Banqs sofas to create linear and perpendicular layouts for any environment.

Banqs Back-to-Back Sofa (NBAB)



statement of line



banqs back-to-back sofa dimensions & material requirements

construction notes

- Weight capacity of 300 lbs. per seat (ie. 2-Seater capacity is 600 lbs.)
- Conforms to BIFMA X5.4-2020 lounge seating standards

weight metal legs (add 14 lbs. for wood legs)

Back-to-Back Sofa, Low Screen, Two Seater	184 lbs
Back-to-Back Sofa, Low Screen, Three Seater	262 lbs
Back-to-Back Sofa, Medium Screen, Two Seater	199 lbs
Back-to-Back Sofa, Medium Screen, Three Seater	287 lbs
Back-to-Back Sofa, High Screen, Two Seater	209 lbs
Back-to-Back Sofa, High Screen, Three Seater	300 lbs

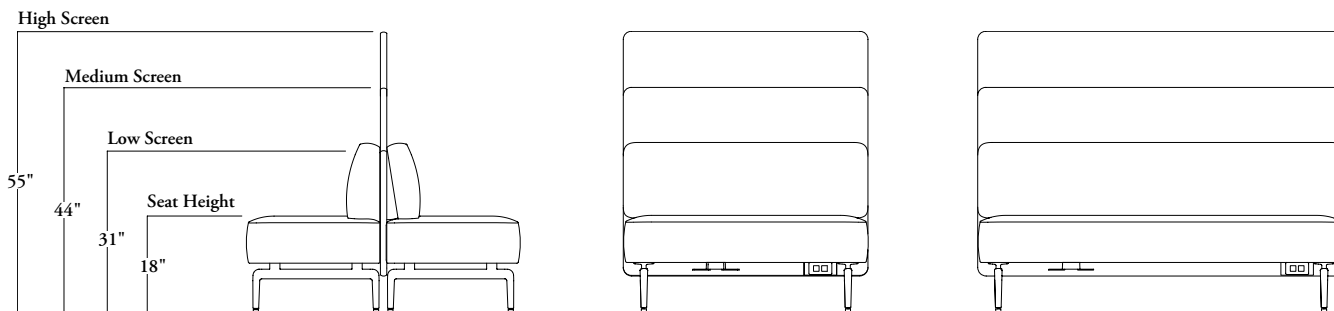
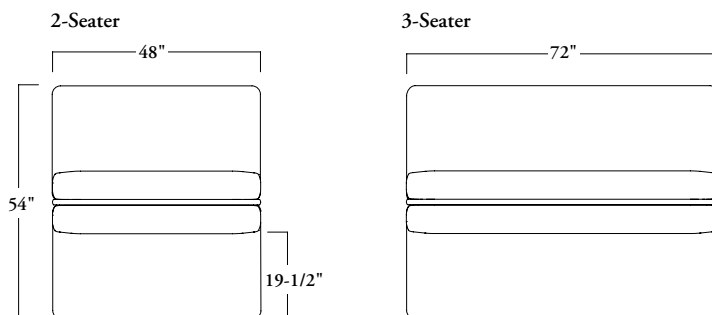

COM/COL material requirement

The pattern, repeat and directionality of fabric may increase the amount of yardage required.

Leather quantities should always be rounded up to the next hide size, as yields vary from 60-80% and are affected by the quality, size and shape of the hide, and by the location and quantity of blemishes.

	SINGLE UPHOLSTERY		TRIPLE UPHOLSTERY - SEAT		TRIPLE UPHOLSTERY - BOLSTER		TRIPLE UPHOLSTERY - SCREEN	
	COM [yards]	COL [sq. ft]	COM [yards]	COL [sq. ft]	COM [yards]	COL [sq. ft]	COM [yards]	COL [sq. ft]
Low Screen, 2-Seater	9.25	157	4.5	76	3	51	1.75	30
Low Screen, 3-Seater	14.25	241	7	119	4	68	3.25	55
Medium Screen, 2-Seater	10	169.13	4.5	76	3	50.63	2.5	42.5
Medium Screen, 3-Seater	15.63	264.34	7	118.13	4	67.5	4.63	78.71
High Screen, 2-Seater	10.5	178	4.5	76	3	51	3	51
High Screen, 3-Seater	16.75	283	7	119	4	68	5.75	98

N B A B / N B W B

Banqs Back-to-Back Sofas

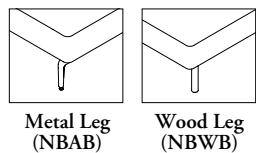
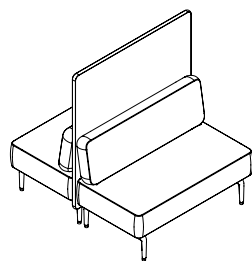

FEATURES

- 2-seater and 3-seater options
- Legs available in Metal (NBAB) or Wood (NBWB)
- Available in single and triple upholstery
- Optional undermount electrical available with black or white faceplate
- Includes threaded inserts for connecting Spanning Screen Kits

NOTES

- Ships as (2) sub-assemblies and requires some assembly on site
- Ganging plates must be ordered separately for linear, perpendicular, and pinwheel applications

PRODUCT OPTIONS

Screen Height	Size	Electrical Option	Electrical Position	Upholstery Style	Seat Upholstery Finish
L Low	2 Two-Seater (Shown)	N No Electrical Module	R Right-Handed	S Single Upholstery	Fabric
M Medium	3 Three-Seater	W One Power, One USB A, One USB-C - White	L Left Handed	T Triple Upholstery	Leather
H High (Shown)		X One Power, One USB A, One USB-C - Black	M Mixed Right and Left		

SAMPLE ORDER CODE

NBAB H	2	W	R	S	E515
---------------	----------	----------	----------	----------	-------------

PRODUCT OPTIONS (CONTINUED)

Bolster Upholstery Finish	Screen Upholstery Finish	Paint Finish	Country of Installation	Metal Leg Finish (if metal leg is specified)
Fabric	Fabric	Foundation	A U.S. and Canada	Foundation
Leather	Leather	Mica Accent		Mica Accent
				Wood Leg Finish (if wood leg is specified)
				N56 Stain Finishes

SAMPLE ORDER CODE (CONTINUED)

E515	E515	24	A	24
-------------	-------------	-----------	----------	-----------

See pricing on the following page.

N B A B / N B W B
Banqs Back-to-Back Sofas
(Continued)

DESCRIPTION

PRICE

SINGLE UPHOLSTERY (S)

	Grade 1	COM/ Grade 2	COL/ Grade 3	Grade 4	Grade 5	Grade 6	Grade 7	Grade 8	Grade 9	Grade 10
Low Screen, 2-Seat Sofa	9143	9799	10416	10814	11136	11458	11852	12246	12638	13069
Low Screen, 3-Seat Sofa	11793	13016	14045	14775	15370	15966	16695	17424	18153	18947
Medium Screen, 2-Seat Sofa	9249	9853	10420	10845	11195	11545	11975	12403	12831	13299
Medium Screen, 3-Seat Sofa	11898	13018	14143	14941	15594	16249	17047	17847	18644	19516
High Screen, 2-Seat Sofa	9275	9866	10421	10852	11210	11568	12005	12442	12878	13357
High Screen, 3-Seat Sofa	11925	13018	14167	14984	15651	16319	17136	17952	18766	19657

	Grade 11	Grade 12	Grade 13	Grade 14	Grade 15	Grade 16	Grade 17	Grade 18	Grade 19	Grade 20
Low Screen, 2-Seat Sofa	13639	14210	14782	15353	15924	16495	17066	17638	18209	18780
Low Screen, 3-Seat Sofa	19519	20090	20662	21233	21803	22375	22946	23517	24089	24659
Medium Screen, 2-Seat Sofa	13870	14442	15013	15583	16154	16726	17297	17869	18439	19010
Medium Screen, 3-Seat Sofa	20087	20658	21229	21800	22372	22942	23513	24085	24656	25228
High Screen, 2-Seat Sofa	13928	14499	15071	15641	16212	16784	17355	17927	18497	19068
High Screen, 3-Seat Sofa	20229	20800	21372	21943	22513	23085	23656	24228	24798	25369

	Leather LA	Leather LB	Leather LC	Leather LD
Low Screen, 2-Seat Sofa	15251	16218	18389	19597
Low Screen, 3-Seat Sofa	22990	24778	28803	31039
Medium Screen, 2-Seat Sofa	15674	16727	19092	20409
Medium Screen, 3-Seat Sofa	23945	25906	30315	32768
High Screen, 2-Seat Sofa	15781	16854	19269	20612
High Screen, 3-Seat Sofa	24184	26187	30694	33199

TRIPLE UPHOLSTERY (T)

BASE PRICE - SEAT UPHOLSTERY (The seat, bolster and screen prices must be added together for a complete price)

	Grade 1	COM/ Grade 2	COL/ Grade 3	Grade 4	Grade 5	Grade 6	Grade 7	Grade 8	Grade 9	Grade 10
Low Screen, 2-Seat Sofa	9225	9488	9736	9910	10051	10195	10370	10546	10721	10870
Low Screen, 3-Seat Sofa	11875	12270	12638	12902	13115	13332	13594	13855	14117	14267
Medium Screen, 2-Seat Sofa	9332	9594	9840	10015	10159	10302	10477	10652	10827	10977
Medium Screen, 3-Seat Sofa	11983	12375	12746	13008	13222	13436	13698	13962	14224	14374
High Screen, 2-Seat Sofa	9359	9621	9867	10042	10186	10329	10504	10679	10854	11004
High Screen, 3-Seat Sofa	12009	12402	12773	13035	13248	13463	13725	13988	14251	14400

	Grade 11	Grade 12	Grade 13	Grade 14	Grade 15	Grade 16	Grade 17	Grade 18	Grade 19	Grade 20
Low Screen, 2-Seat Sofa	11068	11264	11461	11658	11854	12051	12248	12446	12642	12839
Low Screen, 3-Seat Sofa	14464	14661	14857	15054	15252	15449	15645	15842	16039	16235
Medium Screen, 2-Seat Sofa	11173	11370	11568	11764	11961	12158	12354	12551	12748	12946
Medium Screen, 3-Seat Sofa	14571	14767	14964	15161	15357	15554	15752	15949	16146	16343
High Screen, 2-Seat Sofa	11200	11397	11594	11790	11987	12185	12381	12578	12775	12972
High Screen, 3-Seat Sofa	14597	14793	14991	15188	15384	15581	15778	15976	16173	16370

	Leather LA	Leather LB	Leather LC	Leather LD
Low Screen, 2-Seat Sofa	11882	12310	13277	13813
Low Screen, 3-Seat Sofa	15858	16502	17953	18758
Medium Screen, 2-Seat Sofa	11987	12417	13383	13920
Medium Screen, 3-Seat Sofa	15965	16609	18058	18865
High Screen, 2-Seat Sofa	12014	12444	13408	13947
High Screen, 3-Seat Sofa	15992	16636	18084	18891

If Mica/Accent Paint Finish is specified add 100
 If One Power, One USB A, One USB-C option is specified add 1858

Pricing and options are continued on the following pages

N B A B / N B W B Banqs Back-to-Back Sofas (Continued)

DESCRIPTION	PRICE									
TRIPLE UPHOLSTERY (T) (CONTINUED)										
BOLSTER UPHOLSTERY (The seat, bolster and screen prices must be added together for a complete price)										
	COM/ Grade 1	COL/ Grade 2	Grade 3	Grade 4	Grade 5	Grade 6	Grade 7	Grade 8	Grade 9	Grade 10
2-Seat Sofa Bolster	168	259	422	538	636	731	847	964	1081	1208
3-Seat Sofa Bolster	246	434	762	995	1186	1377	1611	1844	2078	2330
	Grade 11	Grade 12	Grade 13	Grade 14	Grade 15	Grade 16	Grade 17	Grade 18	Grade 19	Grade 20
2-Seat Sofa Bolster	1376	1543	1711	1879	2046	2214	2383	2551	2718	2886
3-Seat Sofa Bolster	2499	2667	2834	3002	3170	3337	3506	3674	3841	4009
	Leather LA	Leather LB	Leather LC	Leather LD						
2-Seat Sofa Bolster	1854	2140	2785	3142						
3-Seat Sofa Bolster	3624	4198	5483	6201						
SCREEN UPHOLSTERY (The seat, bolster and screen prices must be added together for a complete price)										
	COM/ Grade 1	COL/ Grade 2	Grade 3	Grade 4	Grade 5	Grade 6	Grade 7	Grade 8	Grade 9	Grade 10
Low Screen, 2-Seat Sofa	168	237	382	483	566	651	754	855	956	1067
Low Screen, 3-Seat Sofa	246	434	762	995	1186	1377	1611	1844	2078	2330
Medium Screen, 2-Seat Sofa	168	289	481	619	731	843	980	1118	1254	1405
Medium Screen, 3-Seat Sofa	246	537	966	1268	1516	1764	2067	2372	2674	3004
High Screen, 2-Seat Sofa	168	302	507	653	771	891	1037	1183	1328	1489
High Screen, 3-Seat Sofa	246	564	1017	1336	1598	1861	2182	2503	2823	3174
	Grade 11	Grade 12	Grade 13	Grade 14	Grade 15	Grade 16	Grade 17	Grade 18	Grade 19	Grade 20
Low Screen, 2-Seat Sofa	1418	1768	2118	2468	2819	3169	3518	3869	4219	4569
Low Screen, 3-Seat Sofa	2681	3031	3381	3732	4082	4431	4782	5132	5482	5832
Medium Screen, 2-Seat Sofa	1755	2104	2455	2805	3155	3506	3856	4206	4556	4907
Medium Screen, 3-Seat Sofa	3355	3705	4055	4406	3547	5105	5455	5806	6156	6506
High Screen, 2-Seat Sofa	1839	2189	2539	2890	3240	3590	3941	4291	4641	4990
High Screen, 3-Seat Sofa	3524	3874	4224	4574	4924	5275	5625	5975	6325	6676
	Leather LA	Leather LB	Leather LC	Leather LD						
Low Screen, 2-Seat Sofa	1632	1884	2448	2761						
Low Screen, 3-Seat Sofa	3624	4198	5483	6201						
Medium Screen, 2-Seat Sofa	2163	2500	3257	3678						
Medium Screen, 3-Seat Sofa	4685	5430	7104	8035						
High Screen, 2-Seat Sofa	2297	2654	3458	3908						
High Screen, 3-Seat Sofa	4951	5739	7510	8494						
If Mica/Accent Paint Finish is specified					add	100				
If One Power, One USB A, One USB-C option is specified					add	1858				

banqs corner alcove sofa overview

Banqs Corner Alcove Sofas address various visual, acoustic, and spatial privacy needs with three screen heights.

Can be used in stand alone applications or combined with other Banqs components to create linear, perpendicular, and pinwheel layouts for any environment.

Banqs Corner Alcove Sofa (NBAC)



Handedness:
 - Available left and right handed
 - Handedness is determine from the perspective of the user when seated

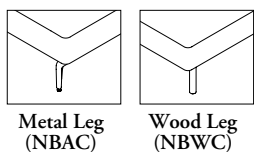

statement of line



banqs corner alcove sofa dimensions & material requirements

construction notes

- Weight capacity of 300 lbs. per seat (ie. 2-Seater capacity is 600 lbs.)
- Conforms to BIFMA X5.4-2020 lounge seating standards

weight metal legs (add 7 lbs. for wood legs)

Corner Alcove Sofa Low Screen, 2-Seat	131 lbs
Corner Alcove Sofa Low Screen, 3-Seat	178 lbs
Corner Alcove Sofa Medium Screen, 2-Seat	154 lbs
Corner Alcove Sofa Medium Screen, 3-Seat	211 lbs
Corner Alcove Sofa High Screen, 2-Seat	170 lbs
Corner Alcove Sofa High Screen, 3-Seat	229 lbs

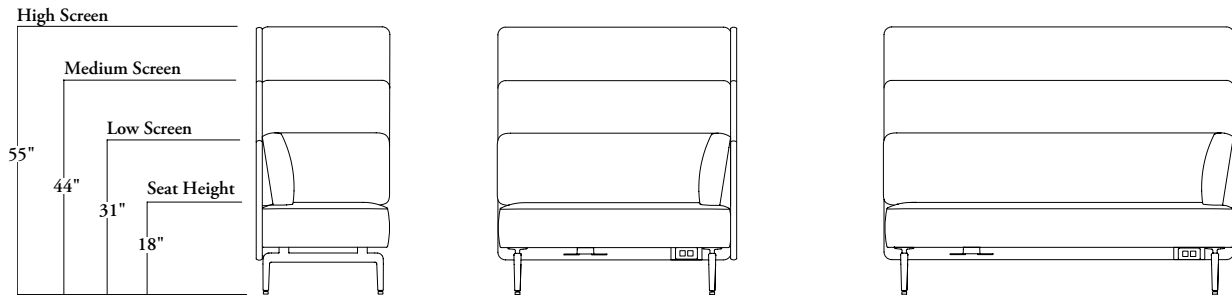
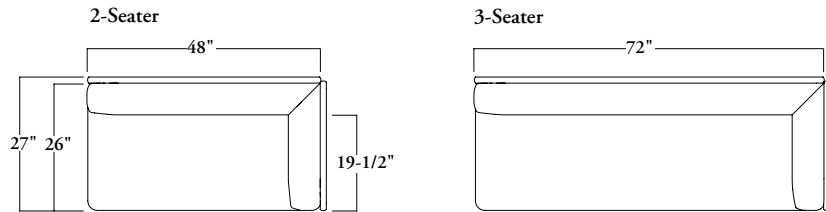

COM/COL material requirement

The pattern, repeat and directionality of fabric may increase the amount of yardage required.

Leather quantities should always be rounded up to the next hide size, as yields vary from 60-80% and are affected by the quality, size and shape of the hide, and by the location and quantity of blemishes.

	SINGLE UPHOLSTERY		TRIPLE UPHOLSTERY - SEAT		TRIPLE UPHOLSTERY - BOLSTER		TRIPLE UPHOLSTERY - SCREEN	
	COM [yards]	COL [sq. ft]	COM [yards]	COL [sq. ft]	COM [yards]	COL [sq. ft]	COM [yards]	COL [sq. ft]
Low Screen, 2-Seat	7.5	127	2.25	38	1.75	30	3.5	60
Low Screen, 3-Seat	10.75	182	3.5	60	2.25	38	5	85
Medium Screen, 2-Seat	9	152.5	2.25	38	1.75	30	5	85
Medium Screen, 3-Seat	12.75	216	3.5	60	2.25	38	7	119
High Screen, 2-Seat	10	169	2.25	38	1.75	30	6	102
High Screen, 3-Seat	14.5	245	3.5	60	2-1/4	38	8.75	148

NBAC / NBWC

Banqs Corner Alcove Sofa

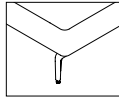
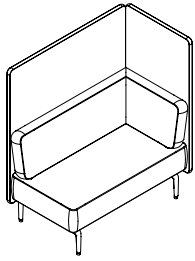

Metal Leg
(NBAC)

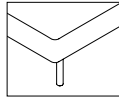

Wood Leg
(NBWC)

FEATURES

- 2-seater and 3-seater options
- Legs available in Metal (NBAC) or Wood (NBWC)
- Available in single and triple upholstery
- Optional undermount electrical available with black or white faceplate
- Includes threaded inserts for connecting Spanning Screen Kits
- Ships fully assembled

NOTES

- Ganging plates must be ordered separately for linear, perpendicular, and pinwheel applications

PRODUCT OPTIONS

Screen Height	Size	Corner Orientation	Electrical Option	Electrical Position	Upholstery Style
L Low	2 Two-Seater (Shown)	L Left (Shown)	N No Electrical Module	R Right Handed	S Single Upholstery
M Medium	3 Three-Seater	R Right	W One Power, One USB A, One USB-C - White	L Left Handed	T Triple Upholstery
H High (Shown)			X One Power, One USB A, One USB-C - Black		

SAMPLE ORDER CODE

NBAC L	2	L	W	R	T
---------------	----------	----------	----------	----------	----------

PRODUCT OPTIONS (CONTINUED)

Seat Upholstery Finish	Bolster Upholstery Finish	Screen Upholstery Finish	Paint Finish	Metal Leg Finish (if metal leg is specified)
Fabric	Fabric	Fabric	Foundation	Foundation
Leather	Leather	Leather	Mica	Mica
			Accent	Accent
				Wood Leg Finish (if wood leg is specified)
				N56 Stain Finishes

SAMPLE ORDER CODE (CONTINUED)

E515	E515	E515	24	24
-------------	-------------	-------------	-----------	-----------

See pricing on the following page.

N B A C / N B W C
Banqs Corner Alcove Sofa
 (Continued)

DESCRIPTION	PRICE									
SINGLE UPHOLSTERY (S)										
	Grade 1	COM/ Grade 2	COL/ Grade 3	Grade 4	Grade 5	Grade 6	Grade 7	Grade 8	Grade 9	Grade 10
Low Screen, 2-Seat Sofa	5996	6499	6973	7307	7581	7857	8191	8527	8861	9227
Low Screen, 3-Seat Sofa	7717	8505	9245	9770	10198	10628	11153	11679	12201	12775
Medium Screen, 2-Seat Sofa	6182	6755	7294	7676	7988	8301	8681	9064	9446	9862
Medium Screen, 3-Seat Sofa	7956	8866	9721	10329	10823	11319	11927	12534	13138	13801
High Screen, 2-Seat Sofa	6228	6820	7373	7767	8090	8412	8804	9198	9592	10020
High Screen, 3-Seat Sofa	8016	8956	9840	10468	10981	11492	12121	12747	13372	14056
	Grade 11	Grade 12	Grade 13	Grade 14	Grade 15	Grade 16	Grade 17	Grade 18	Grade 19	Grade 20
Low Screen, 2-Seat Sofa	9679	10130	10582	11034	11485	11936	12389	12840	13291	13744
Low Screen, 3-Seat Sofa	13226	13678	14130	14581	15032	15485	15936	16387	16840	17291
Medium Screen, 2-Seat Sofa	10314	10766	11217	11668	12121	12572	13023	13476	13927	14378
Medium Screen, 3-Seat Sofa	14252	14703	15155	15607	16058	16510	16962	17413	17865	18316
High Screen, 2-Seat Sofa	10472	10924	11375	11827	12279	12730	13182	13633	14085	14537
High Screen, 3-Seat Sofa	14508	14959	15411	15863	16314	16765	17218	17669	18120	18573
	Leather LA	Leather LB	Leather LC	Leather LD						
Low Screen, 2-Seat Sofa	11086	11909	13760	14788						
Low Screen, 3-Seat Sofa	15686	16971	19871	21479						
Medium Screen, 2-Seat Sofa	12470	12917	15025	16197						
Medium Screen, 3-Seat Sofa	17866	18650	21999	23859						
High Screen, 2-Seat Sofa	12202	13168	15342	16550						
High Screen, 3-Seat Sofa	17531	19072	22532	24454						
TRIPLE UPHOLSTERY (T)										
BASE PRICE - SEAT UPHOLSTERY (The seat, bolster and screen prices must be added together for a complete price)										
	Grade 1	COM/ Grade 2	COL/ Grade 3	Grade 4	Grade 5	Grade 6	Grade 7	Grade 8	Grade 9	Grade 10
Low Screen, 2-Seat Sofa	6078	6211	6334	6421	6493	6564	6651	6740	6827	6922
Low Screen, 3-Seat Sofa	7802	7999	8185	8315	8423	8531	8662	8794	8924	9068
Medium Screen, 2-Seat Sofa	6078	6211	6334	6421	6493	6564	6651	6740	6827	6922
Medium Screen, 3-Seat Sofa	7802	7999	8185	8315	8423	8531	8662	8794	8924	9068
High Screen, 2-Seat Sofa	6310	6443	6566	6653	6723	6796	6883	6972	7059	7154
High Screen, 3-Seat Sofa	8099	8297	8483	8614	8721	8829	8959	9092	9222	9365
	Grade 11	Grade 12	Grade 13	Grade 14	Grade 15	Grade 16	Grade 17	Grade 18	Grade 19	Grade 20
Low Screen, 2-Seat Sofa	7027	7132	7237	7342	7447	7552	7657	7763	7867	7973
Low Screen, 3-Seat Sofa	9172	9278	9383	9488	9593	9698	9803	9908	10013	10119
Medium Screen, 2-Seat Sofa	7027	7132	7237	7342	7447	7552	7657	7763	7867	7973
Medium Screen, 3-Seat Sofa	9172	9278	9383	9488	9593	9698	9803	9908	10013	10119
High Screen, 2-Seat Sofa	7258	7364	7469	7574	7679	7784	7889	7994	8099	8205
High Screen, 3-Seat Sofa	9470	9575	9680	9785	9890	9995	10100	10205	10310	10416
	Leather LA	Leather LB	Leather LC	Leather LD						
Low Screen, 2-Seat Sofa	7407	7622	8105	8373						
Low Screen, 3-Seat Sofa	9795	10116	10841	11244						
Medium Screen, 2-Seat Sofa	7407	7622	8105	8373						
Medium Screen, 3-Seat Sofa	9795	10116	10841	11244						
High Screen, 2-Seat Sofa	7637	7854	8337	8605						
High Screen, 3-Seat Sofa	10093	10416	11138	11542						

Pricing and options are continued on the following pages.

N B A C / N B W C

Banqs Corner Alcove Sofa (Continued)

DESCRIPTION	PRICE									
TRIPLE UPHOLSTERY (T) (CONTINUED)										
BOLSTER UPHOLSTERY (The seat, bolster and screen prices must be added together for a complete price)										
	Grade 1	COM/ Grade 2	COL/ Grade 3	Grade 4	Grade 5	Grade 6	Grade 7	Grade 8	Grade 9	Grade 10
2-Seat Sofa Bolster	84	237	382	483	566	651	754	855	956	1067
3-Seat Sofa Bolster	123	325	552	711	843	973	1136	1295	1453	1629
	Grade 11	Grade 12	Grade 13	Grade 14	Grade 15	Grade 16	Grade 17	Grade 18	Grade 19	Grade 20
2-Seat Sofa Bolster	1194	1319	1444	1569	1696	1821	1946	2072	2198	2323
3-Seat Sofa Bolster	1755	1880	2006	2131	2257	2383	2508	2633	2760	2885
	Leather LA	Leather LB	Leather LC	Leather LD						
2-Seat Sofa Bolster	1632	1884	2448	2761						
3-Seat Sofa Bolster	2520	2913	3798	4290						
SCREEN UPHOLSTERY (The seat, bolster and screen prices must be added together for a complete price)										
	Grade 1	COM/ Grade 2	COL/ Grade 3	Grade 4	Grade 5	Grade 6	Grade 7	Grade 8	Grade 9	Grade 10
Low Screen, 2-Seat Sofa Screen	84	302	507	653	771	891	1037	1183	1328	1489
Low Screen, 3-Seat Sofa Screen	123	434	762	995	1186	1377	1611	1844	2078	2330
Medium Screen, 2-Seat Sofa	84	372	382	483	566	651	754	855	956	1067
Medium Screen, 3-Seat Sofa	123	557	552	711	843	973	1136	1295	1453	1629
High Screen, 2-Seat Sofa	84	389	677	882	1049	1215	1419	1623	1827	2051
High Screen, 3-Seat Sofa	123	587	1060	1394	1670	1944	2278	2615	2949	3316
	Grade 11	Grade 12	Grade 13	Grade 14	Grade 15	Grade 16	Grade 17	Grade 18	Grade 19	Grade 20
Low Screen, 2-Seat Sofa Screen	1710	1931	2152	2373	2594	2815	3036	3257	3478	3699
Low Screen, 3-Seat Sofa Screen	2552	2772	2994	3214	3436	3656	3878	4098	4320	4540
Medium Screen, 2-Seat Sofa	2159	2380	2601	2822	3043	3264	3485	3706	3927	4148
Medium Screen, 3-Seat Sofa	3340	3561	3782	4003	4224	4445	4666	4887	5107	5329
High Screen, 2-Seat Sofa	2271	2493	2713	2935	3155	3377	3597	3819	4039	4261
High Screen, 3-Seat Sofa	3537	3758	3979	4200	4421	4642	4863	5084	5305	5526
	Leather LA	Leather LB	Leather LC	Leather LD						
Low Screen, 2-Seat Sofa Screen	2297	2654	3458	3908						
Low Screen, 3-Seat Sofa Screen	3624	4198	5483	6201						
Medium Screen, 2-Seat Sofa	3004	3477	4539	5131						
Medium Screen, 3-Seat Sofa	4864	5638	7375	8340						
High Screen, 2-Seat Sofa	3181	3682	4809	5437						
High Screen, 3-Seat Sofa	5175	5998	7850	8875						
If Mica/Accent Paint Finish is specified				add	51					
If One Power, One USB A, One USB-C option is specified				add	929					

banqs full alcove sofa overview

Banqs Full Alcove Sofas address various visual, acoustic, and spatial privacy needs with three screen heights.

Intended for stand alone use, the medium sofa can be combined with other Banqs components, like benches and single-sided sofas, to create linear and perpendicular layouts for a variety of applications.

Banqs Full Alcove Sofa (NBAF)



statement of line



banqs full alcove sofa dimensions & material requirements

construction notes

- Weight capacity of 300 lbs. per seat (ie. 2-Seater capacity is 600 lbs.)
- Conforms to BIFMA X5.4-2020 lounge seating standards

weight metal legs (add 7 lbs. for wood legs)

Full Alcove Sofa Low Screen, Small	157 lbs
Full Alcove Sofa Low Screen, Medium	203 lbs
Full Alcove Sofa Medium Screen, Small	188 lbs
Full Alcove Sofa Medium Screen, Medium	244 lbs
Full Alcove Sofa High Screen, Small	210 lbs
Full Alcove Sofa High Screen, Medium	268 lbs

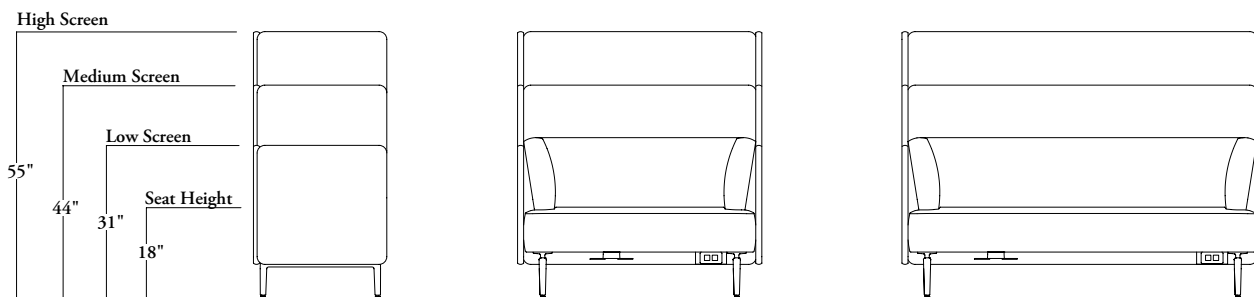
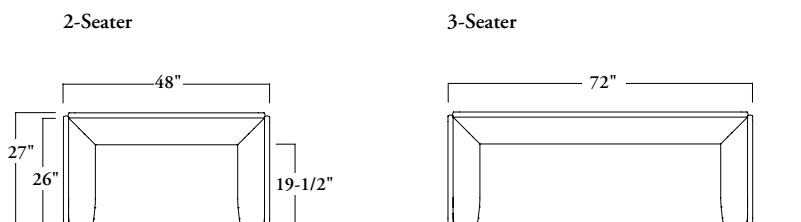

COM/COL material requirement

The pattern, repeat and directionality of fabric may increase the amount of yardage required.

Leather quantities should always be rounded up to the next hide size, as yields vary from 60-80% and are affected by the quality, size and shape of the hide, and by the location and quantity of blemishes.

	SINGLE UPHOLSTERY		TRIPLE UPHOLSTERY - SEAT		TRIPLE UPHOLSTERY - BOLSTER		TRIPLE UPHOLSTERY - SCREEN	
	COM [yards]	COL [sq. ft]	COM [yards]	COL [sq. ft]	COM [yards]	COL [sq. ft]	COM [yards]	COL [sq. ft]
Low Screen, Small	9.75	165	2.25	38	2.25	38	5.25	89
Low Screen, Medium	13	220	3.5	60	2.75	47	6.75	114
Medium Screen, Small	11.5	194.5	2.25	38	2.25	38	7	119
Medium Screen, Medium	15.25	258.5	3.5	60	2.75	47	9.5	161.5
High Screen, Small	13.5	228	2.25	38	2.25	38	9	152
High Screen, Medium	18	304	3.5	60	2.75	47	11.75	199

NBAF / NBWF

Banqs Full Alcove Sofa

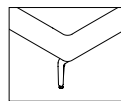
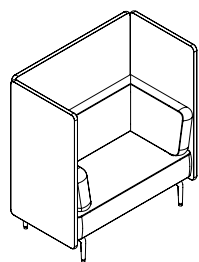

Metal Leg
(NBAF)

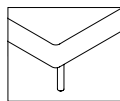

Wood Leg
(NBWF)

FEATURES

- 2-seater and 3-seater options
- Legs available in Metal (NBAF) or Wood (NBWF)
- Available in single and triple upholstery
- Optional undermount electrical available with black or white faceplate
- Includes threaded inserts for connecting Spanning Screen Kits
- Ships fully assembled

NOTES

- Ganging plates must be ordered separately for linear, perpendicular, and pinwheel applications

PRODUCT OPTIONS

Screen Height	Size	Electrical Option	Electrical Position	Upholstery Style	Seat Upholstery Finish
L Low	S Small (Shown)	N No Electrical Module	R Right-Handed	S Single Upholstery	Fabric
M Medium	M Medium	W One Power, One USB A, One USB-C - White	L Left Handed	T Triple Upholstery	Leather
H High (Shown)		X One Power, One USB A, One USB-C - Black			

SAMPLE ORDER CODE

NBAF L	M	U	R	T	E515
---------------	----------	----------	----------	----------	-------------

PRODUCT OPTIONS (CONTINUED)

Bolster Upholstery Finish	Screen Upholstery Finish	Paint Finish	Country of Installation	Metal Leg Finish (if metal leg is specified)
Fabric	Fabric	Foundation	A U.S. and Canada	Foundation
Leather	Leather	Mica		Mica
		Accent		Accent
				Wood Leg Finish (if wood leg is specified)
				N56 Stain Finishes

SAMPLE ORDER CODE (CONTINUED)

E515	E515	24	A	24
-------------	-------------	-----------	----------	-----------

See pricing on the following page.

N B A F / N B W F
Banqs Full Alcove Sofa
(Continued)

DESCRIPTION	PRICE									
SINGLE UPHOLSTERY (S)										
	Grade 1	COM/ Grade 2	COL/ Grade 3	Grade 4	Grade 5	Grade 6	Grade 7	Grade 8	Grade 9	Grade 10
Low Screen, Small Sofa	7023	7701	8338	8790	9159	9531	9982	10432	10885	11377
Low Screen, Medium Sofa	8745	9708	10609	11252	11776	12302	12942	13584	14225	14926
Medium Screen, Small Sofa	7235	8018	8753	9277	9702	10129	10651	11173	11694	12264
Medium Screen, Medium Sofa	9010	10130	11182	11928	12538	13149	13896	14642	15386	16203
High Screen, Small Sofa	7287	8097	8858	9397	9838	10279	10818	11359	11897	12485
High Screen, Medium Sofa	9076	10237	11326	12098	12729	13362	14133	14906	15677	16522
	Grade 11	Grade 12	Grade 13	Grade 14	Grade 15	Grade 16	Grade 17	Grade 18	Grade 19	Grade 20
Low Screen, Small Sofa	11956	12535	13113	13691	14269	14848	15427	16005	16583	17162
Low Screen, Medium Sofa	15503	16082	16661	17239	17818	18396	18974	19553	20132	20709
Medium Screen, Small Sofa	12842	13421	13999	14578	15157	15734	16313	16892	17470	18048
Medium Screen, Medium Sofa	16782	17359	17938	18517	19095	19674	20252	20830	21409	21988
High Screen, Small Sofa	13064	13642	14220	14798	15377	15956	16533	17112	17691	18269
High Screen, Medium Sofa	17101	17678	18257	18836	19414	19993	20570	21149	21728	22306
	LA	LB	LC	LD						
Low Screen, Small Sofa	13884	14992	17488	18873						
Low Screen, Medium Sofa	18482	20055	23597	25564						
Medium Screen, Small Sofa	15779	17112	19321	20921						
Medium Screen, Medium Sofa	21175	23082	26294	28582						
High Screen, Small Sofa	15476	16800	19779	21433						
High Screen, Medium Sofa	20805	22701	26968	29338						
TRIPLE UPHOLSTERY (T)										
BASE PRICE - SEAT UPHOLSTERY (The seat, bolster and screen prices must be added together for a complete price)										
	Grade 1	COM/ Grade 2	COL/ Grade 3	Grade 4	Grade 5	Grade 6	Grade 7	Grade 8	Grade 9	Grade 10
Low Screen, Small Sofa	7105	7237	7360	7448	7519	7591	7679	7766	7854	7948
Low Screen, Medium Sofa	8829	9026	9212	9341	9451	9558	9688	9818	9950	10094
Medium Screen, Small Sofa	7317	7450	7572	7659	7730	7803	7890	7978	8065	8161
Medium Screen, Medium Sofa	9093	9290	9476	9608	9715	9822	9953	10084	10215	10359
High Screen, Small Sofa	7371	7503	7626	7713	7784	7857	7944	8032	8119	8214
High Screen, Medium Sofa	9159	9358	9542	9674	9781	9889	10019	10151	10281	10425
	Grade 11	Grade 12	Grade 13	Grade 14	Grade 15	Grade 16	Grade 17	Grade 18	Grade 19	Grade 20
Low Screen, Small Sofa	8053	8158	8264	8368	8474	8578	8684	8788	8894	8999
Low Screen, Medium Sofa	10199	10304	10409	10514	10620	10724	10830	10934	11040	11144
Medium Screen, Small Sofa	8266	8371	8476	8581	8686	8790	8896	9002	9106	9212
Medium Screen, Medium Sofa	10463	10569	10673	10779	10884	10989	11094	11199	11304	11409
High Screen, Small Sofa	8318	8424	8529	8634	8739	8844	8949	9054	9159	9265
High Screen, Medium Sofa	10530	10635	10740	10845	10950	11055	11160	11265	11370	11476
	Leather LA	Leather LB	Leather LC	Leather LD						
Low Screen, Small Sofa	8433	8649	9132	9401						
Low Screen, Medium Sofa	10822	11142	11868	12272						
Medium Screen, Small Sofa	8645	8861	9344	9612						
Medium Screen, Medium Sofa	11086	11409	12132	12536						
High Screen, Small Sofa	8698	8915	9397	9665						
High Screen, Medium Sofa	11153	11476	12199	12602						

Pricing and options are continued on the following pages.

NBAF / NBWF

Banqs Full Alcove Sofa (Continued)

DESCRIPTION

PRICE

TRIPLE UPHOLSTERY (T) (CONTINUED)

BOLSTER UPHOLSTERY (The seat, bolster and screen prices must be added together for a complete price)

	Grade 1	COM/ Grade 2	COL/ Grade 3	Grade 4	Grade 5	Grade 6	Grade 7	Grade 8	Grade 9	Grade 10
Small Sofa Bolster	84	302	507	653	771	891	1037	1183	1328	1489
Medium Sofa Bolster	123	389	677	882	1049	1215	1419	1623	1827	2051
	Grade 11	Grade 12	Grade 13	Grade 14	Grade 15	Grade 16	Grade 17	Grade 18	Grade 19	Grade 20
Small Sofa Bolster	1656	1825	1993	2160	2328	2496	2663	2832	3000	3168
Medium Sofa Bolster	2218	2386	2554	2721	2890	3058	3226	3393	3561	3729
	Leather LA	Leather LB	Leather LC	Leather LD						
Small Sofa Bolster	2297	2654	3458	3908						
Medium Sofa Bolster	3181	3682	4809	5437						

SCREEN UPHOLSTERY (The seat, bolster and screen prices must be added together for a complete price)

	Grade 1	COM/ Grade 2	COL/ Grade 3	Grade 4	Grade 5	Grade 6	Grade 7	Grade 8	Grade 9	Grade 10
Low Screen, Small Sofa	84	412	719	940	1118	1297	1515	1734	1952	2190
Low Screen, Medium Sofa Screen	123	542	974	1283	1531	1783	2088	2393	2702	3035
Medium Screen, Small Sofa	84	516	923	1213	1449	1685	1973	2262	2552	2865
Medium Screen, Medium Sofa	123	699	1278	1690	2027	2363	2774	3184	3597	4044
High Screen, Small Sofa	84	542	974	1283	1531	1783	2088	2393	2702	3035
High Screen, Medium Sofa Screen	123	739	1355	1793	2151	2508	2945	3383	3821	4297
	Grade 11	Grade 12	Grade 13	Grade 14	Grade 15	Grade 16	Grade 17	Grade 18	Grade 19	Grade 20
Low Screen, Small Sofa	2495	2799	3103	3408	3712	4016	4321	4625	4929	5234
Low Screen, Medium Sofa	3338	3644	3947	4251	4556	4860	5164	5469	5773	6077
Medium Screen, Small Sofa	3170	3474	3778	4083	4387	4691	4996	5300	5604	5909
Medium Screen, Medium Sofa	4349	4653	4957	5262	5566	5870	6175	6479	6783	7088
High Screen, Small Sofa Screen	3338	3644	3947	4251	4556	4860	5164	5469	5773	6077
High Screen, Medium Sofa Screen	4601	4906	5210	5513	5819	6122	6426	6731	7035	7339
	Leather LA	Leather LB	Leather LC	Leather LD						
Low Screen, Small Sofa	3405	3941	5148	5819						
Low Screen, Medium Sofa	4733	5482	7175	8113						
Medium Screen, Small Sofa	4467	5175	6769	7655						
Medium Screen, Medium Sofa	6324	7332	9604	10865						
High Screen, Small Sofa Screen	4733	5482	7175	8113						
High Screen, Medium Sofa Screen	6721	7795	10211	11552						

If Mica/Accent Paint Finish is specified

add 51

If One Power, One USB A, One USB-C option is specified

add 929

banqs fabric pattern and seam guidelines

Fabric

- Fabric is applied "Off-the-Bolt" on Banqs seating (Off-the-Bolt is a term that describes the orientation that fabric is applied to seating).
- Seams are required at the center-line of 3-seater straight upholstered benches and sofas (as indicated below).
- Patterned upholstery can be used.
- COMs follow the same fabric orientation and pattern seaming.
- See Fabrics and Finishes Guide

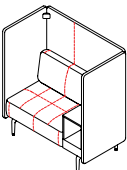
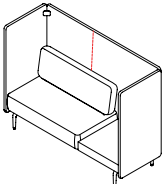
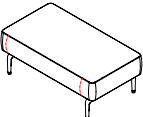
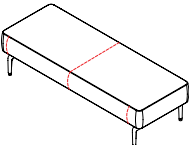
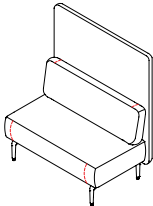
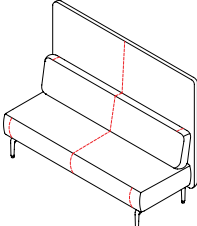
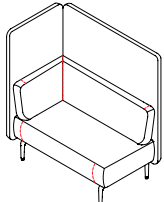
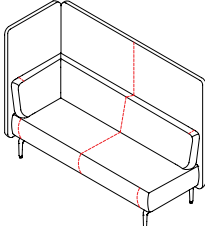
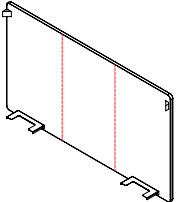
Product	Fabric Pattern Seams	Product	Fabric Pattern Seams
Banqs Single-Sided/Corner Alcove/Full Alcove Solo Focus Sofas, Standard (Full Alcove, High Screen shown)		Banqs Single-Sided/Corner Alcove/Full Alcove Solo Focus Sofas, Wide (Full Alcove, High Screen shown)	
Banqs Rectangular Bench - No Back, 2-Seater		Banqs Rectangular Bench - No Back 3-Seater	
Banqs Single-Sided Sofas, 2-Seater (High Screen shown)		Banqs Single Sided Sofas, 3-Seater (High Screen shown)	
Banqs Corner/Full Alcove Sofas, 2-Seater (Corner Alcove, High Screen shown)		Banqs Corner/Full Alcove Sofas, 3-Seater (Corner Alcove, High Screen shown)	
High Spanning Screen			

banqs fabric pattern and seam guidelines (continued)

Leather

- Leather hides have variations in shape and limited dimensions.
- Leather hides are divided into smaller panel sizes (approx. 24" x 24") and require additional seams.
- Seams are required at the center-line of 2-seater and 3-seater straight upholstered benches and sofas (as indicated below).
- COLs follow the same fabric orientation and pattern seaming.

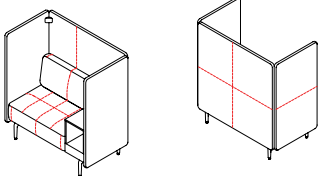
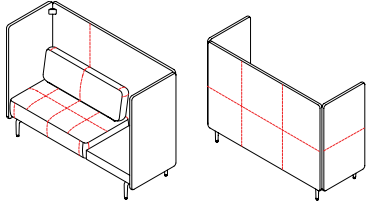
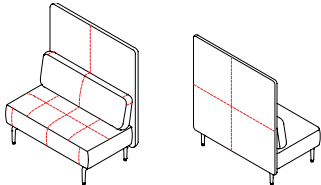
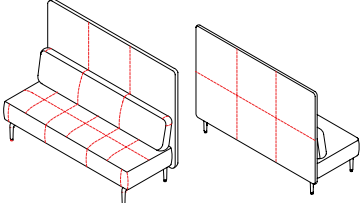
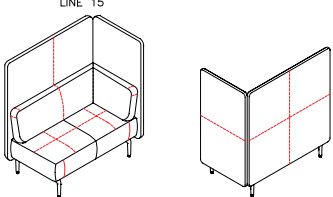
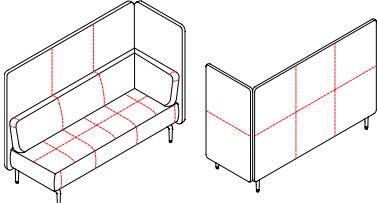
Product	Leather Pattern Seams	Model	Leather Pattern Seams
Banqs Single-Sided/Corner Alcove/Full Alcove Solo Focus Sofas, Standard (Full Alcove, High Screen shown)		Banqs Single-Sided/Corner Alcove/Full Alcove Solo Focus Sofas, Wide (Full Alcove, High Screen shown)	
Banqs Single-Sided Sofas, 2-Seater (High Screen shown)		Banqs Single-Sided Sofas, 3-Seater (High Screen shown)	
Banqs Corner/Full Alcove Sofas, 2-Seater (Corner Alcove, High Screen shown)	LINE 15 	Banqs Corner/Full Alcove Sofas, 3-Seater (Corner Alcove, High Screen shown)	

banqs high spanning screen overview

Banqs High Spanning Screens mount perpendicular to the ends of Single-Sided or Back-to-Back Sofas to provide privacy as well as access to power and A/V for meeting settings.

Banqs High Spanning Screen (NBAZ)



statement of line



planning with banqs high spanning screen

Banqs High Spanning Screens are designed for booth applications, and must be used perpendicular to high screen sofas. High spanning screens are not freestanding.

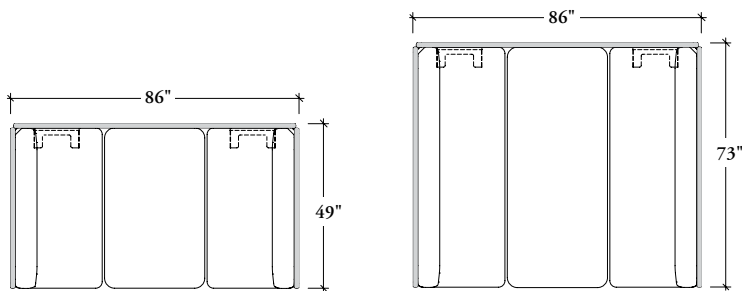

Single-Sided Sofa, High Screen, 2-Seat with 30" deep x 48" wide Table

Single-Sided Sofa, High Screen, 3-Seat with 30" deep x 72" wide Table

Note: High Spanning Screen adds 1" to overall sofa dimension

Banqs High Spanning Screens can only be planned with High Screen sofas.

Maximum of (2) High Spanning Screens can be planned together

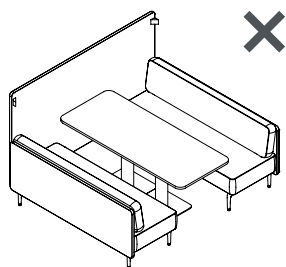

Single-Sided Sofa, Low Screen, 3-Seat with 30" deep x 72" wide Table

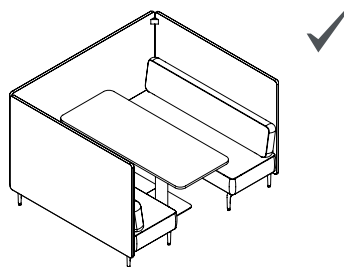

Single-Sided Sofa, High Screen, 3-Seat with 30" deep x 72" wide Table

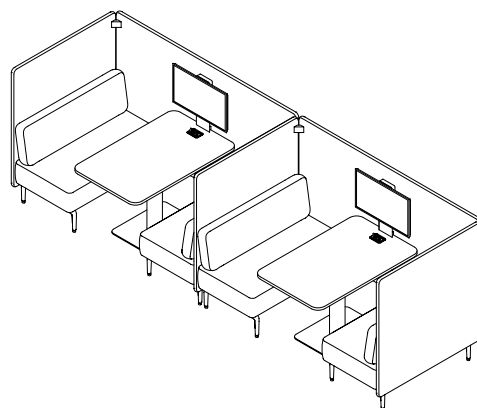

The following recommendations for TV/monitor size and weight should be taken into consideration when specifying a High Spanning Screen with Digital Share & Worksurface Electrics.

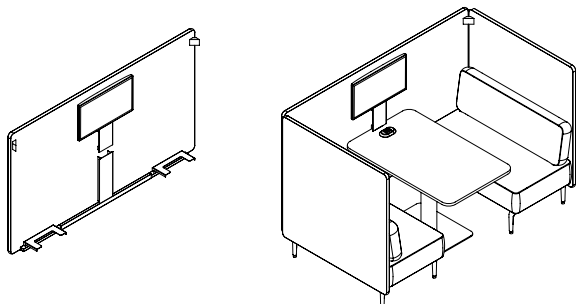

- Maximum TV/Monitor size is 28" (measured on the diagonal)
- Maximum recommended width is 30"
- Maximum TV/Monitor weight 20lbs
- TV/Monitor **cannot** be mounted on both sides of a High Spanning Screen
- No tilt, pan or rotation is provided in the monitor mount
- VESA 75mm x 75mm and 100mm x 100mm hold patterns are accommodated

banqs high spanning screen dimensions & material requirements

weight

High Spanning Screen, Digital Share & Worksurface Electrics	80 lbs
High Spanning Screen, Worksurface Electrics only	74 lbs
High Spanning Screen, 84", No Electrical Module	70lbs

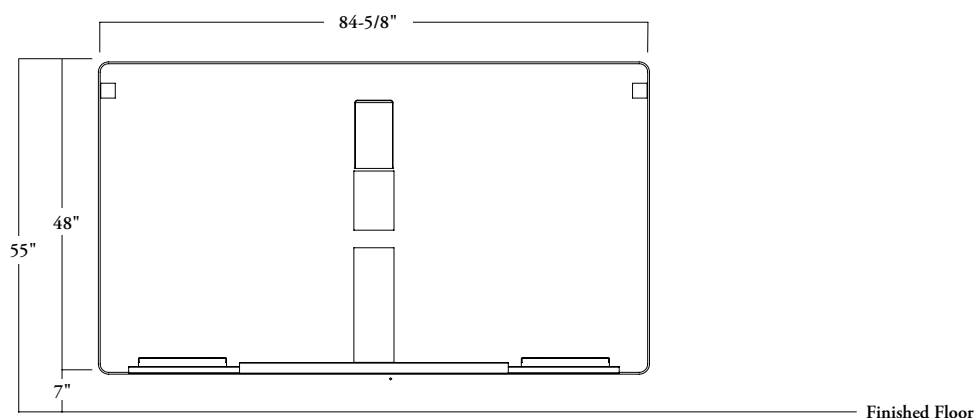

COM/COL material requirement

The pattern, repeat and directionality of fabric may increase the amount of yardage required.

Leather quantities should always be rounded up to the next hide size, as yields vary from 60-80% and are affected by the quality, size and shape of the hide, and by the location and quantity of blemishes.

SINGLE UPHOLSTERY

	Upholstery [yards]	Leather [sq. ft]
Banqs High Spanning Screen	8.5	144

NBAZ

Banqs High Spanning Screen

FEATURES

- Sized specifically to provide ergonomic access to 30" deep Banqs Table with Flat Base
- Supports TV/monitor up to 28" (diagonal measure)
- Coordinating painted finish on metal channels and brackets
- Includes corner brackets and all hardware to connect to perpendicular sofas
- Ships assembled

NOTES

- Perpendicular sofas must be 55" high
- TV/monitor mounting bracket is VESA compliant (with 75 x 75mm/100 x 100mm hole pattern)
- TV/monitor not included

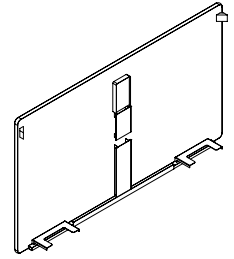

PRODUCT OPTIONS

Size	Electrical Option	Screen Upholstery Finish	Paint Finish	Country of Installation
84"	N No Electrical Module	Fabric	Foundation	A U.S. and Canada
	W Worksurface Electrics Only	Leather	Mica	
	D Digital Share and Worksurface Electrics (Shown)		Accent	

SAMPLE ORDER CODE

NBAZ 84	N	E515	24	A
----------------	----------	-------------	-----------	----------

DESCRIPTION

PRICE

	Grade 1	COM/ Grade 2	COL/ Grade 3	Grade 4	Grade 5	Grade 6	Grade 7	Grade 8	Grade 9	Grade 10
No Worksurface Module	3844	4279	4690	4981	5220	5458	5750	6041	6334	6651
	Grade 11	Grade 12	Grade 13	Grade 14	Grade 15	Grade 16	Grade 17	Grade 18	Grade 19	Grade 20
No Worksurface Module	6931	7212	7491	7772	8052	8332	8612	8893	9172	9453
	Leather LA	Leather LB	Leather LC	Leather LD						
No Worksurface Module	8268	8983	10594	11487						

If Mica/Accent Paint Finish is specified	add	51
If Worksurface Electrics Only option is specified	add	661
If Digital Share and Worksurface Electrics option is specified	add	1324

banqs digital share wall mount integration kit overview

Banqs Digital Share Wall Mount Integration Kit is used to create a booth setting up against a building partition that requires full wire management with a TV/monitor mount.

Banqs Wire Management Kit for Table with Power Pill at Architectural Wall provides a solution for wire management below the table.

Banqs Digital Share Wall Mount Integration Kit (NBAY)

Banqs Wire Management Kit for Table with Power Pill at Architectural Wall (NBAX)

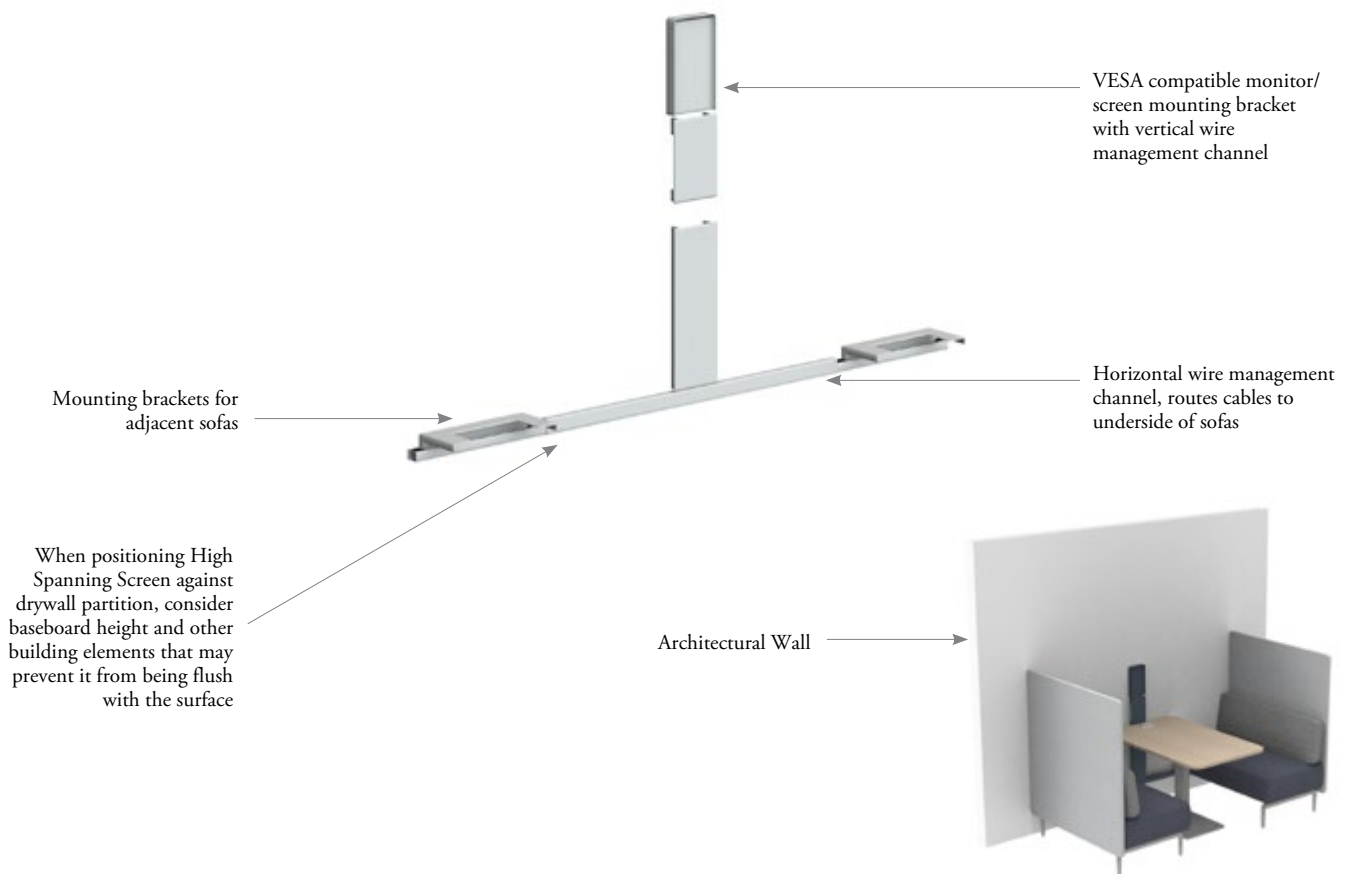

statement of line



Banqs Digital
Share Wall Mount
Integration Kit
(NBAY)



Banqs Wire Management
Kit for Table with Power
Pill at Architectural Wall
(NBAX)

banqs digital share wall mount integration kit dimensions & material requirements

weight

Banqs Digital Share Wall Mount Integration Kit	25 lbs
Banqs Wire Management Kit for Table with Power Pill at Architectural Wall	20 lbs

Banqs Digital Share Wall Mount Integration Kit (NBAY)

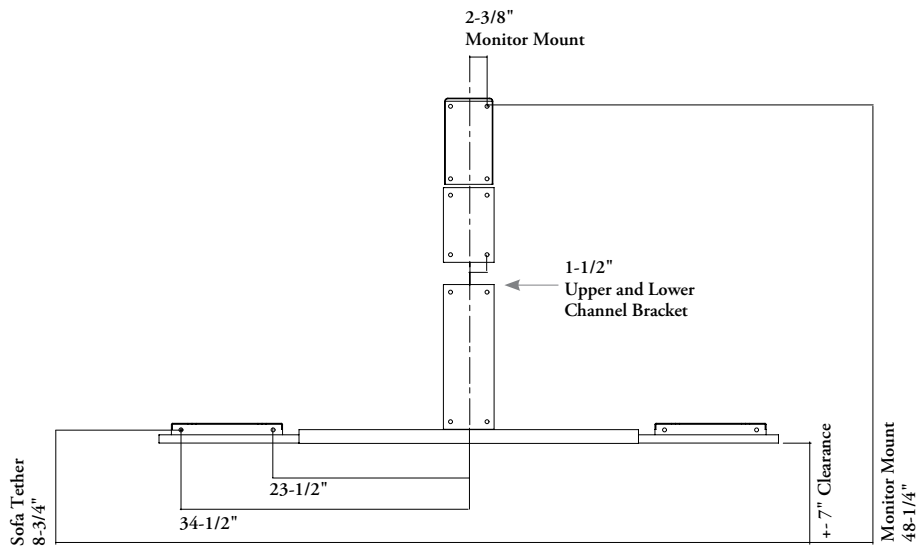

Banqs Wire Management Kit for Table with Power Pill at Architectural Wall (NBAX)

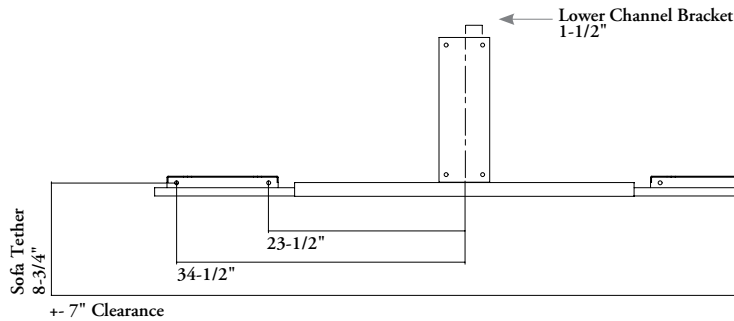

N B A Y Banqs Digital Share Wall Mount Integration Kit

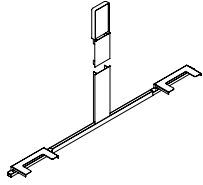

FEATURES

- Sized specifically to provide ergonomic access to 30" deep Banqs Table with Flat Base
- Supports TV/monitor up to 28" (diagonal measure)
- Coordinating painted finish on metal channels and brackets
- Includes all hardware to connect to perpendicular sofas

NOTES

- Wall fasteners to be supplied by others
- TV/monitor mounting bracket is VESA complaint (with 75 x 75mm/100 x 100mm hole pattern)
- TV/monitor not included

PRODUCT OPTIONS

Paint Finish

Foundation

Mica

Accent

SAMPLE ORDER CODE

NBAY 24

PRICING

1325

If Mica/Accent Paint Finish is specified add 34

FEATURES

- Sized specifically to provide ergonomic access to 30" deep Banqs Table with Flat Base
- Coordinating painted finish on metal channels and brackets
- Includes all hardware to connect to perpendicular sofas

NOTES

- Wall fasteners to be supplied by others
- Does not include TV/monitor mounting bracket

**N B A X
Banqs Wire Management Kit for
Table with Power Pill at
Architectural Wall**

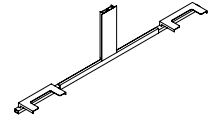

PRODUCT OPTIONS

Paint Finish
Foundation
Mica
Accent

SAMPLE ORDER CODE

NBAX 24

PRICING

1060

banqs table with flat base overview

The Banqs Table with Flat Base can be used with Banqs benches and sofas or planned independently.

The flat base is ideal in booth or diner applications where less obstructed foot room helps people slide in and out of the space.

Banqs Table with Flat Base (NBAT)

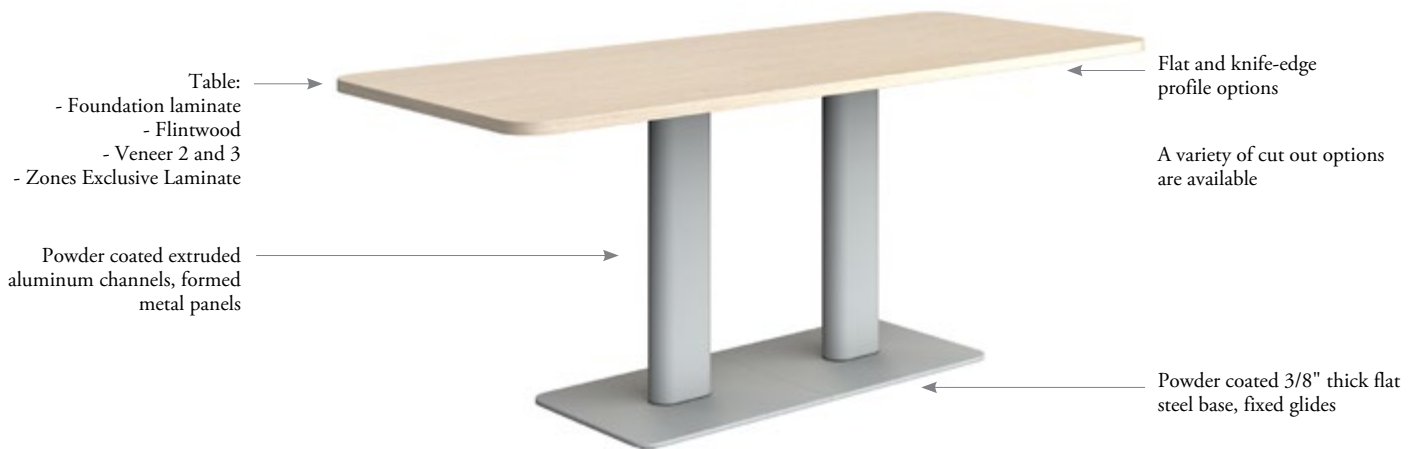

statement of line



Banqs Table with Flat Base (NBAT)



Banqs Table with Flat Base (NBAT)

planning with banqs tables

The following should be considered when planning with Banqs tables.

For linear planning, a minimum distance of 18" between tables is suggested for comfortable access and egress to and from Banqs benches and sofas.

Banqs Tables with Flat Base or 4-Prong Base can be specified, however; Banqs Tables with Flat Base are suggested for improved end user comfort.

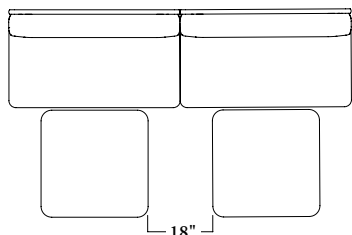

(2) Single-Sided Sofas, 2-Seater with
(2) 30" x 30" Banqs Tables

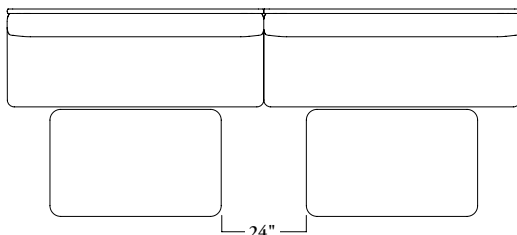

(2) Single-Sided Sofas, 3-Seater with
(2) 30" x 48" Banqs Tables

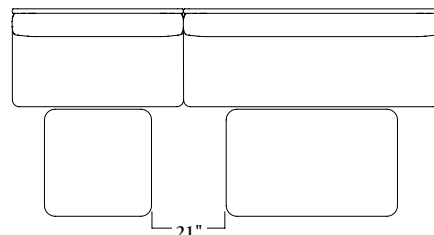

(1) Single-Sided Sofa,
2-Seater + (1) Single-Sided Sofa,
3-Seater with (1) 30" x 30" Banqs
Table + (1) 30" x 48" Banqs Table

For banquette and booth applications, it is suggested that table sizes match the sofa sizes.

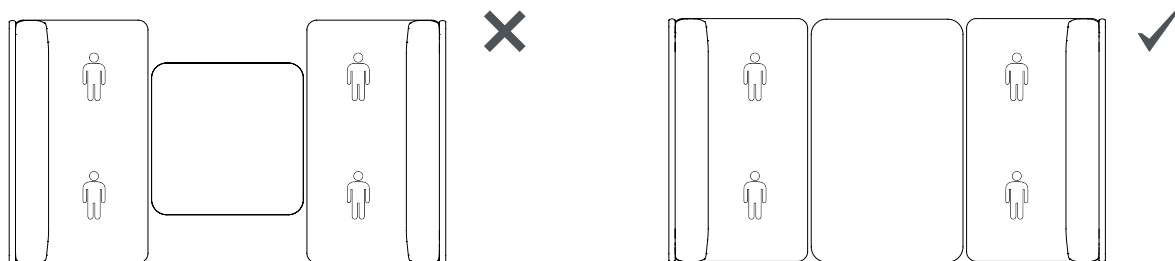

When planning with Full Alcove Sofas and tables consider leg room and leave sufficient space for access and egress.

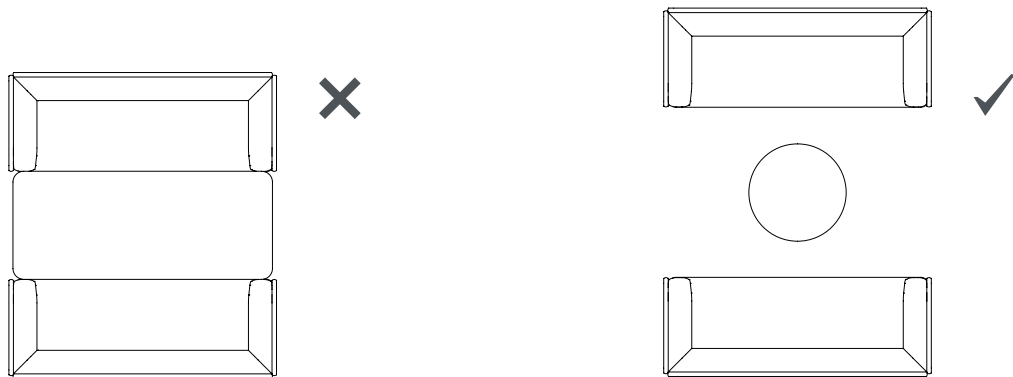

planning with banquet tables (continued)

For booth applications using High Spanning Screens, it is suggested that table sizes also match the sofa sizes.

The seating occupancy of 2-seater and 3-seater sofas should be reduced to allow for all users to clearly view the TV/monitor.

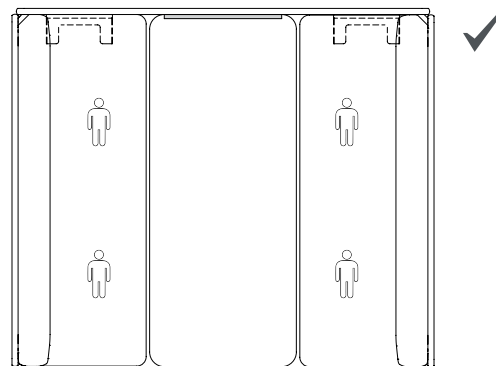
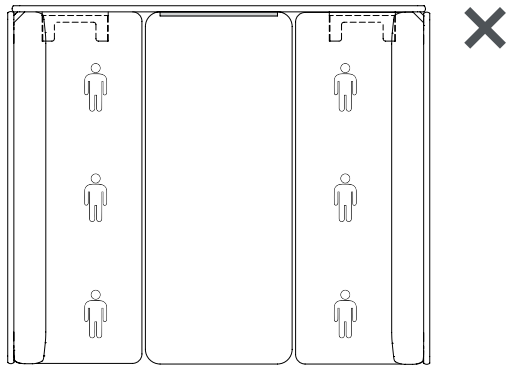
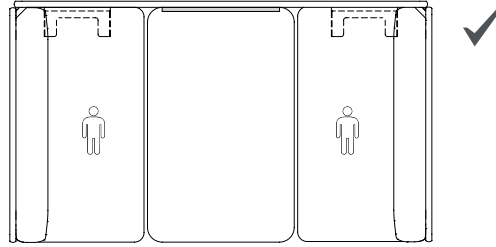
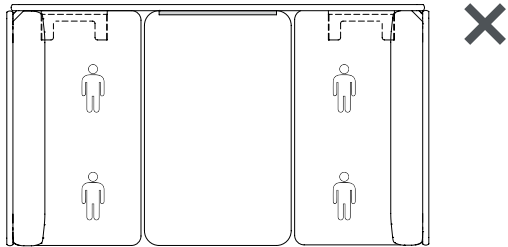

planning with banqs tables (continued)

Banqs tables can accommodate the following power and lighting options.



No electrics (High Spanning Screen not required)



Zones Table Lamp (ZNET)



Zones Small Power Pill (ZNEP)



Zones Small Power Pill (ZNEP) with Digital Share & Worksurface Electrics (NBAZ)



Zones CALA Power Module (ZNEB)



Zones CALA Power Module (ZNEB) with Digital Share & Worksurface Electrics



Small Power Flip (NBAJ)





Small Power Flip (NBAJ) with Digital Share & Worksurface Electrics (NBAZ)

Notes:

When specifying a High Spanning Screen with Digital Share & Worksurface Electrics (NBAZ84D), remember to specify the table with the corresponding power/lighting cut out.

Power/lighting accessories must be purchased separately.

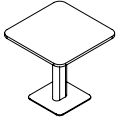
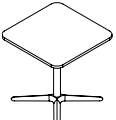
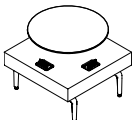
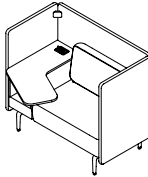
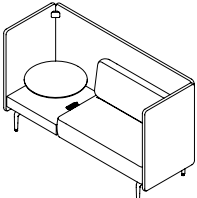
banqs tables edge trim style overview

		Banqs Table with Flat Base (NBAT)	Banqs Table with 4-Prong Base (NBAU)	Upper Surface on Banqs Freestanding Table with Dual Table (NBF, NBL, NBS)	Banqs Solo Focus with Boomerang (NBF, NBL, NBS)	Upper Surface on Banqs Solo Focus with Dual Table (NBF, NBL, NBS)
						
Flat Edge		✓	✓	✗	✓	✗
Knife Edge		✓	✓	✓	✗	✓

grain directions

The following outlines all Banqs tables grain directions.

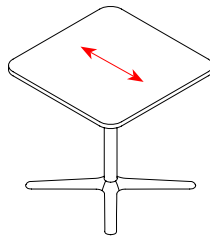
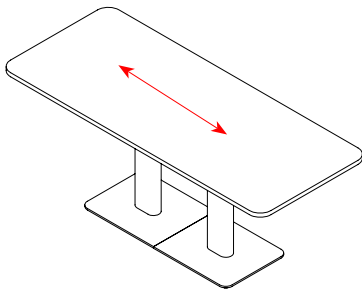
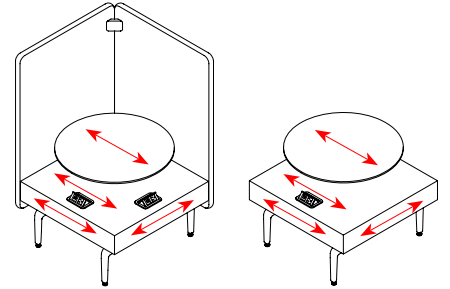
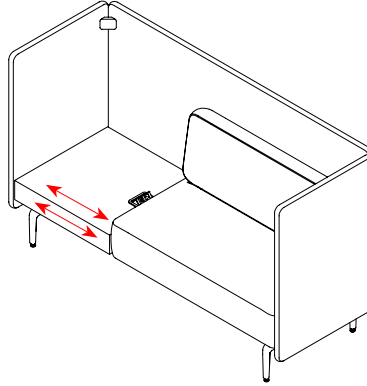
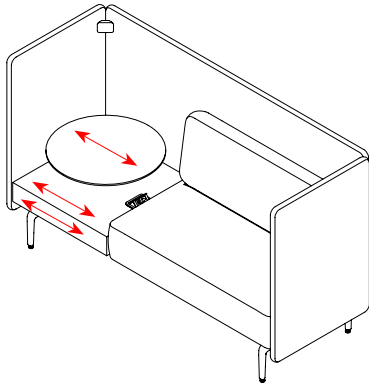
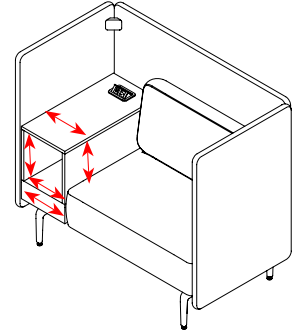
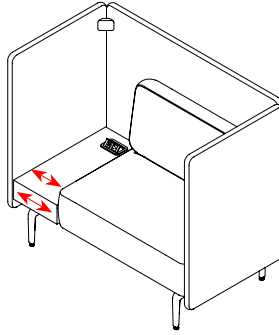
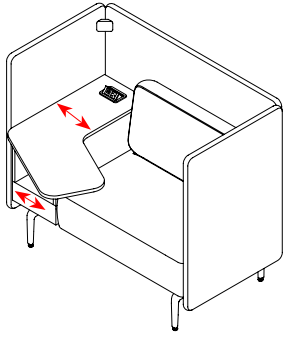

banqs table with flat base dimensions & material requirements

weight

30 x 30, No Cut Out, No Wall Tether Kit	75 lbs
30 x 48, No Cut Out, No Wall Tether Kit	99 lbs
30 x 72, Banqs Table with Flat Base, No Cut Out, No Wall Tether Kit	220 lbs
30 x 72, Banqs Table with Flat Base, No Cut Out, With Wall Tether Kit	220 lbs
30 x 48 Banqs Table with Flat Base, Zones Power Pill Cut Out, With Wall Tether Kit	100 lbs
30 x 48 Banqs Table with Flat Base, Table Lamp Cut Out, With Wall Tether Kit	100 lbs
30 x 48 Banqs Table with Flat Base, Zones Power Pill + Digital Shroud Cut Out, With Wall Tether Kit	100 lbs
30 x 72 Banqs Table with Flat Base, Small Power Flip Cut Out, With Wall Tether Kit	225 lbs
30 x 72 Banqs Table with Flat Base, Small Power Flip + Digital Shroud Cut Out, With Wall Tether Kit	225 lbs

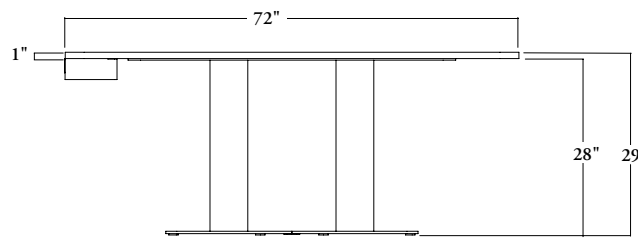
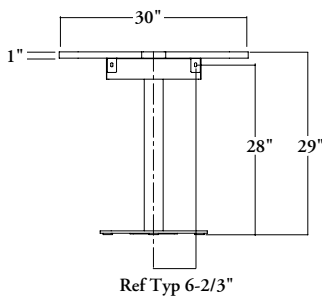
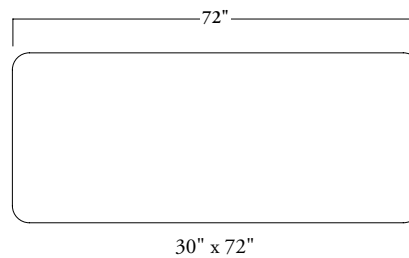
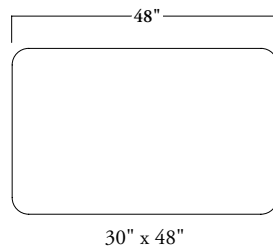
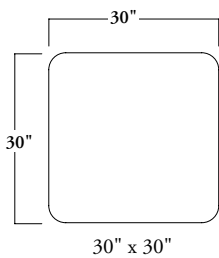

Note: Mounting locations shown for planning reference only.

N B A T Banqs Table with Flat Base

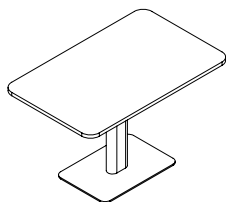

FEATURES

- Surface includes threaded inserts for metal-to-metal fastening
- Includes (4) micro-leveling shims, for a total of 1/4" leveling range
- Screen/wall tether kit includes shroud

NOTES

- Screen/wall tether kit defaults to Greystone paint finish
- All supported power modules and lamp must be specified separately (only cut out is provided when specified)
- Power, table lamp, and screen options are not available for 30"x30" tables
- 72" wide tables include two column supports
- Fasteners supplied by others when tethering tables to drywall

PRODUCT OPTIONS

Depth	Width	Cut Out	Surface Finish
30	30, 48, 72	N No Cut Out E Zones Small Power Pill F Zones Small Power Pill and Digital Mount Shroud C Zones CALA Power Module D Zones CALA Power Module and Digital Mount Shroud L Zones Table Lamp P Small Power Flip Q Small Power Flip & Digital Mount Shroud	Foundation Laminate Flintwood Natural Veneer 2S Greystone

SAMPLE ORDER CODE

NBAT 30	72	E	LW
----------------	-----------	----------	-----------

PRODUCT OPTIONS (CONTINUED)

Edge Trim Style	Edge Trim Finish	Base Finish	Screen/Wall Tether Kit
8 Flat (with Foundation and Zones Exclusive) H Full Knife (with Foundation, Flintwood, Natural Veneer and Zones Exclusive)	Zones Edge trim Colors	Foundation Mica Accent	N No Kit Y With Kit

SAMPLE ORDER CODE (CONTINUED)

8	ST	24	Y
----------	-----------	-----------	----------

See pricing on the following page.

N B A T
Banqs Table with Flat Base
(Continued)

DIMENSIONS
INCHES / MM

D	W
30 / 762	30 / 762
30 / 762	48 / 1219
30 / 762	72 / 1829

PRICING

NO CUT OUT

FOUNDATION LAMINATE		FLINTWOOD		NATURAL VENEER		ZONES EXCLUSIVE LAMINATE	
Flat Edge	Full Knife Edge	Flat Edge	Full Knife Edge	Flat Edge	Full Knife Edge	Flat Edge	Full Knife Edge
1259	1259	1696	1953	1720	1980	1259	1259
1654	1654	2286	2637	2313	2661	1654	1654
2481	2481	3437	3938	3464	3965	2481	2481

ZONES POWER PILL / ZONES CALA POWER MODULE / ZONES TABLE LAMP / SMALL POWER CLIP / CUT OUT

FOUNDATION LAMINATE		FLINTWOOD		NATURAL VENEER		ZONES EXCLUSIVE LAMINATE	
Flat Edge	Full Knife Edge	Flat Edge	Full Knife Edge	Flat Edge	Full Knife Edge	Flat Edge	Full Knife Edge
1728	1728	2358	2709	2385	2735	1728	1728
2555	2555	3508	4010	3535	4037	2555	2555

ZONES POWER PILL / ZONES CALA POWER MODULE AND DIGITAL MOUNT SHROUD / SMALL POWER FLIP & DIGITAL MOUNT SHROUD / CUT OUT

FOUNDATION LAMINATE		FLINTWOOD		NATURAL VENEER		ZONES EXCLUSIVE LAMINATE	
Flat Edge	Full Knife Edge	Flat Edge	Full Knife Edge	Flat Edge	Full Knife Edge	Flat Edge	Full Knife Edge
1768	1768	2398	2747	2424	2774	1768	1768
2594	2594	3548	4052	3574	4076	2594	2594

If Mica/Accent Paint Finish is specified

add 51

banqs table with 4-prong base overview

Banqs Table with 4-Prong Base can be used with Banqs benches and sofas or independently.

Banqs Table with Four-Prong Base (NBAU)



statement of line



Banqs Table with
4-Prong Base
(NBAU)

FEATURES

- Surface includes threaded inserts for metal-to-metal fastening

NOTES

- Cut outs are not available

NBAU

Banqs Table with Four-Prong Base

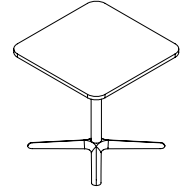

PRODUCT OPTIONS

Depth	Width	Surface Finish	Edge Trim Style	Edge Trim Finish	Base Finish
30	30	Foundation Laminate Flintwood Natural Veneer Zones Exclusive Laminate	8 Flat (with Foundation and Zones Exclusive) H Full Knife (with Foundation, Flintwood, Natural Veneer and Zones Exclusive)	Zones Edge Trim Colors	Foundation Mica Accent

SAMPLE ORDER CODE

NBAU 30	30	LW	8	ST	24
----------------	-----------	-----------	----------	-----------	-----------

**DIMENSIONS
INCHES / MM**

D	W
30 / 762	30 / 762

PRICING

FOUNDATION LAMINATE		FLINTWOOD		NATURAL VENEER		ZONES EXCLUSIVE LAMINATE	
Flat Edge	Full Knife Edge	Flat Edge	Full Knife Edge	Flat Edge	Full Knife Edge	Flat Edge	Full Knife Edge
929	929	1364	1624	1391	1651	929	929

If Mica/Accent Paint Finish is specified

add 51

understanding banqs freestanding tables

Banqs Freestanding Tables are available in two styles: with and without screens.

Both table styles are designed to be used in conjunction with other sofas, and attached with ganging plate(s) or ganging kit(s) (specify separately).

Both table styles not meant to be used as a stand alone table.

Banqs Freestanding Occasional Tables are designed to be used in the following applications:

- Outside Corner
- Reverse Planning
- T-planning
- X-planning

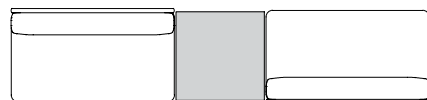
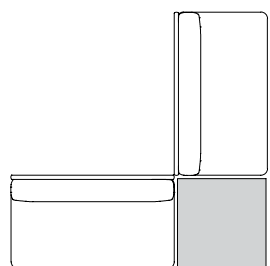

Banqs Freestanding Occasional Tables with Screens are designed to be used for inside corner planning applications.

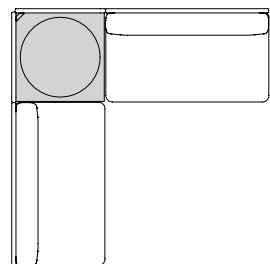

banqs freestanding occasional table overview

Banqs Freestanding Occasional Tables are designed to be ganged with Banqs benches and sofas, and are available with up to (4) power modules to provide maximum connectivity.

Banqs Freestanding Occasional Table (NBAH)

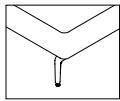

Metal Leg (NBAH)

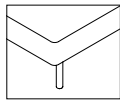

Wood Leg (NBWH)

statement of line



Banqs Freestanding Occasional Table, Single Tabletop (NBAHS)



Banqs Freestanding Occasional Table, Dual Tabletop (NBAHD)

banqs freestanding occasional table dimensions & material requirements

weight metal legs (add 7 lbs. for wood legs)

26" x 26" Single Tabletop, No Electrics	49 lbs
26" x 26" Dual Tabletop, No Electrics	68 lbs

Standard

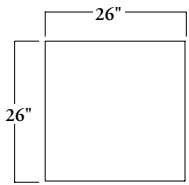

Dual

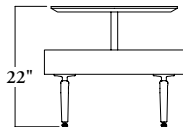
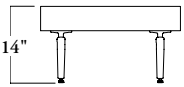
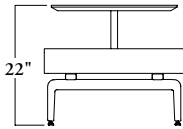
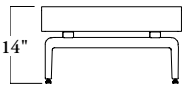
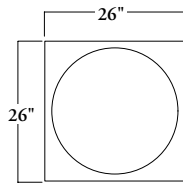

FEATURES

- Tables are recommended to be ganged to Banqs benches and sofas with ganging plates and kits (specified separately)
- Legs available in Metal (NBAH) or Wood (NBWH)
- Optional small power flip includes (1) simplex power, (1) USB-A, and (1) USB-C port
- Optional small power flip available in black or white finish
- Ships fully assembled range

NOTES

- Small power flip(s) are only available on lower tier of table
- Small power flip(s) are pre-installed in factory
- Tables are designed to be ganged together with Banqs benches and sofas with ganging plates and kits (specified separately)
- Tables are not meant to be used as a stand alone table

NBAH / NBWH

Banqs Freestanding Occasional Table

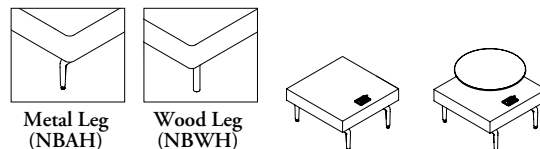

PRODUCT OPTIONS

Table Option	Table Electrical Option	Table Electrical Position	Surface Finish	Metal Leg Finish (if metal leg is specified)
S Standard Tabletop	B Small Power Flip Black	1 Single Electric, Right from Seated Position	Foundation Laminate	Foundation
D Dual Tabletops	W Small Power Flip White	2 Two Electrics, Right and Left from Seated Position	Flintwood	Mica
	N None	3 Two Electrics, Right and Front from Seated Position	Natural Veneer	Accent
		4 Two Electrics, Left and Front from Seated Position	Zones Exclusive Laminate	Wood Leg Finish (if wood leg is specified)
		5 Three Electrics, Right, Left and Front from Seated Position		N56 Stain Finishes
		6 Three Electrics, Right, Front and Back from Seated Position		
		7 Four Electrics, All Sides		

SAMPLE ORDER CODE

NBAH S	W	7	LW	24
---------------	----------	----------	-----------	-----------

DESCRIPTION

None Electric (N)
Single Electric, Right from Seated Position (1)
Two Electrics, Right and Left from Seated Position (2)
Two Electrics, Right and Front from Seated Position (3)
Two Electrics, Left and Front from Seated Position (4)
Three Electrics, Right, Left and Front from Seated Position (5)
Three Electrics, Right, Front and Back from Seated Position (6)
Four Electrics, All Sides (7)

None Electric (N)
Single Electric, Right from Seated Position (1)
Two Electrics, Right and Left from Seated Position (2)
Two Electrics, Right and Front from Seated Position (3)
Two Electrics, Left and Front from Seated Position (4)
Three Electrics, Right, Left and Front from Seated Position (5)
Three Electrics, Right, Front and Back from Seated Position (6)
Four Electrics, All Sides (7)

If Mica/Accent Paint Finish is specified	add	24
Single Tabletops		
If Flintwood Finish is specified	add	81
If Veneer Finish is specified	add	126

PRICE

STANDARD TABLETOPS (S)				
SMALL POWER FLIP BLACK (B) / SMALL POWER FLIP WHITE (W)				
Foundation Laminate	Flintwood	Natural Veneer	Zones Exclusive Laminate	
1356	1434	1478	1356	
1900	1978	2022	1900	
2443	2521	2565	2443	
2443	2521	2565	2443	
2443	2521	2565	2443	
2986	3064	3108	2986	
2986	3064	3108	2986	
3530	3608	3652	3530	

DUAL TABLETOPS (D)				
SMALL POWER FLIP BLACK (B) / SMALL POWER FLIP WHITE (W)				
Foundation Laminate	Flintwood	Natural Veneer	Zones Exclusive Laminate	
1720	2054	2122	1720	
2265	2600	2667	2265	
2808	3142	3210	2808	
2808	3142	3210	2808	
2808	3142	3210	2808	
3352	3686	3754	3352	
3352	3686	3754	3352	
3895	4229	4297	3895	

Dual Tabletops		
If Flintwood Finish is specified	add	348
If Veneer Finish is specified	add	418

banqs freestanding occasional table with screens overview

Banqs Freestanding Occasional Tables with Screens are designed to be ganged with Banqs benches and sofas, and are available with power modules to provide maximum connectivity.

Banqs Freestanding Occasional Table with Screens (NBAL)

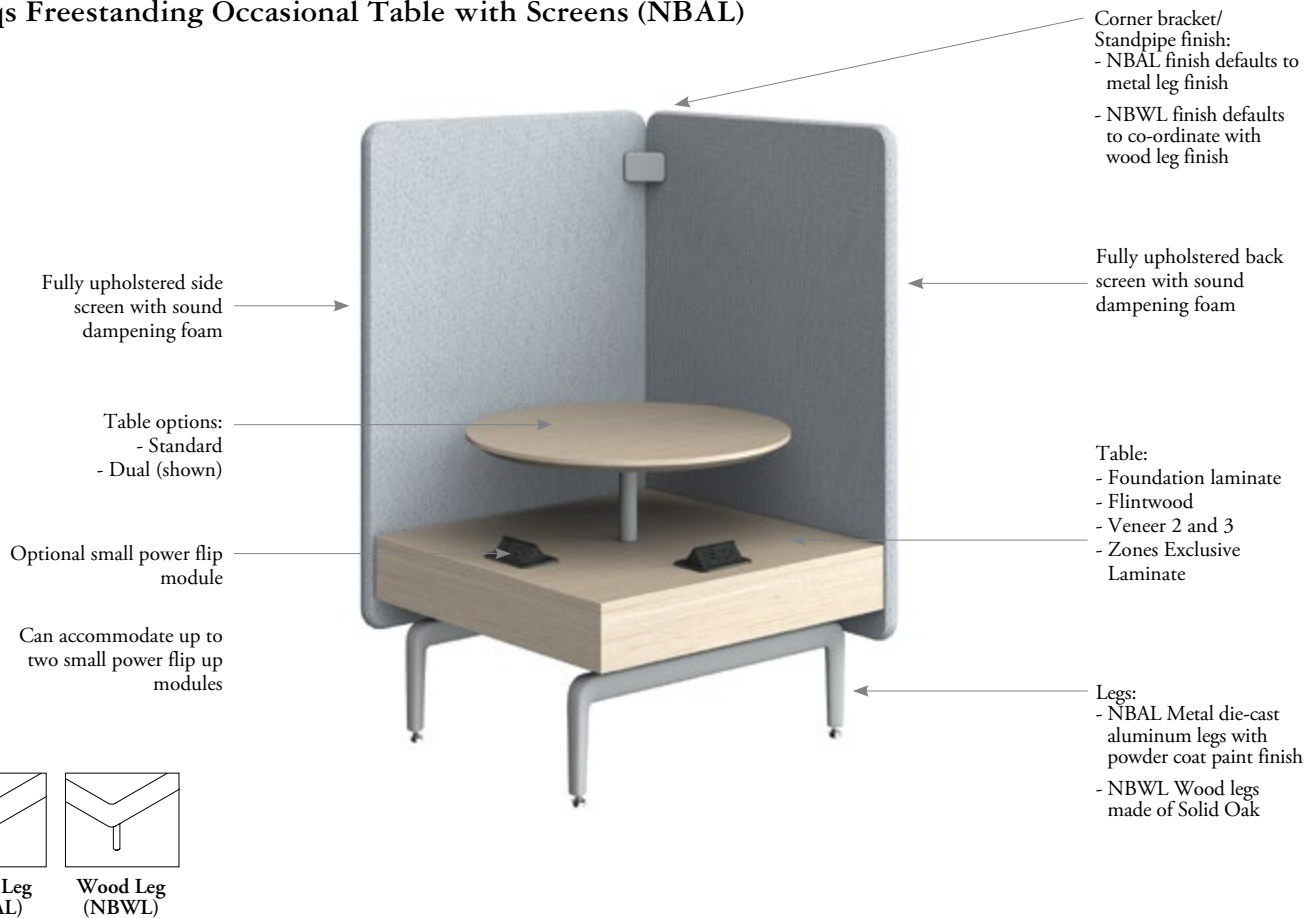

statement of line

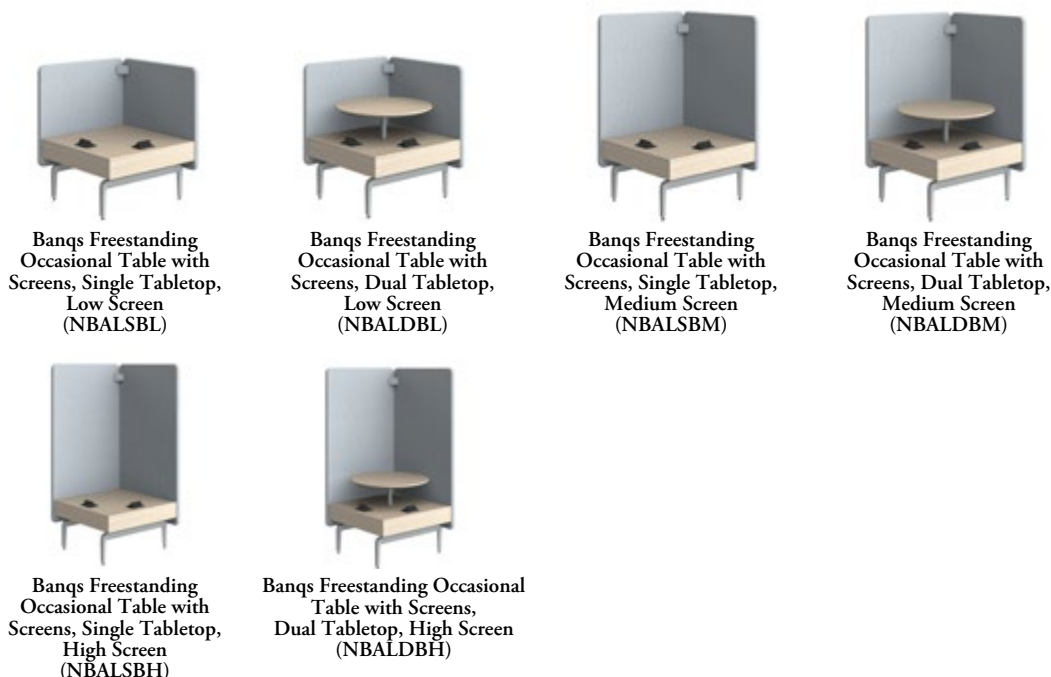

banqs freestanding occasional table with screens dimensions & material requirements

weight metal legs (add 7 lbs. for wood legs)

26" x 26", Single Tabletop, Low Screen	82 lbs
26" x 26", Single Tabletop, Medium Screen	98 lbs
26" x 26", Single Tabletop, High Screen	110 lbs
26" x 26", Dual Tabletop, Low Screen	102 lbs
26" x 26", Dual Tabletop, Medium Screen	118 lbs
26" x 26", Dual Tabletop, High Screen	130 lbs

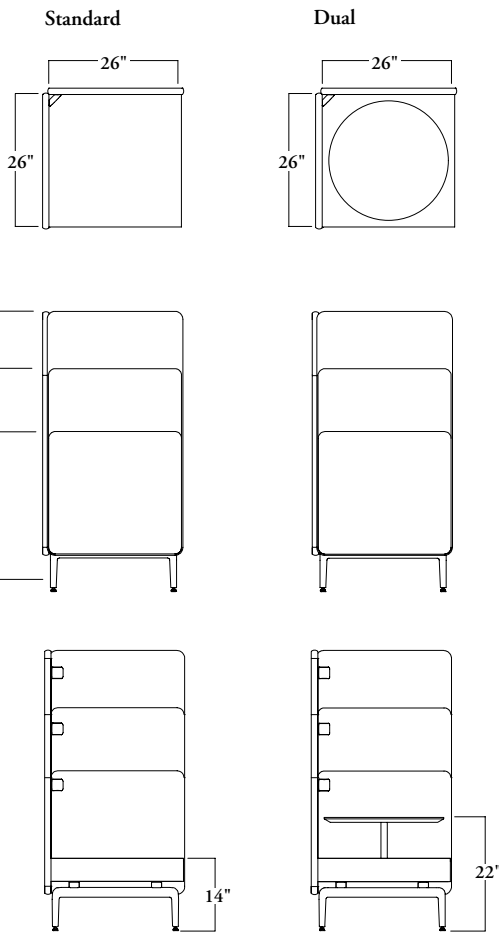

COM/COL material requirement

The pattern, repeat and directionality of fabric may increase the amount of yardage required.

Leather quantities should always be rounded up to the next hide size, as yields vary from 60-80% and are affected by the quality, size and shape of the hide, and by the location and quantity of blemishes.

	SCREEN	
	COM [yards]	COL [sq. ft]
Low Screen	3.25	55
Medium Screen	4.5	75
High Screen	6	100

NBAL / NBWL Banqs Freestanding Occasional Table with Screens

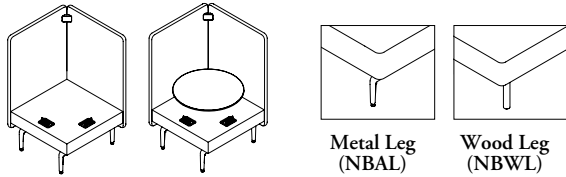

Metal Leg
(NBAL)

Wood Leg
(NBWL)

FEATURES

- Tables are recommended to be ganged to Banqs benches and sofas with ganging plates and kits (specified separately)
- Legs available in Metal (NBAL) or Wood (NBWL)
- Optional small power flips include (1) simplex power, (1) USB-A, and (1) USB-C port each
- Optional small power flips available in black or white finish

NOTES

- Screens are fixed and can not be rotated independently
- Small power flips are only available on lower tier of table
- Small power flips are pre-installed in factory
- Tables are designed to be ganged together with Banqs benches and sofas with with ganging plates and kits (specified separately)
- Tables are not meant to be used as a stand alone table

PRODUCT OPTIONS

Table Option	Table Electrical Option	Screen Height	Surface Finish	Upholstery Finish	Metal Leg Finish (if metal leg is specified)
S Standard Tabletop	B Small Power Flip Black	L Low Screen Fabric	Foundation Laminate	Fabric	Foundation
D Dual Tabletops	W Small Power Flip White	M Medium Screen Fabric	Flintwood	Leather	Mica
	N None	H High Screen Fabric	Natural Veneer		Accent
			Zones Exclusive Laminate		Wood Leg Finish (if wood leg is specified)
					N56 Stain Finishes

SAMPLE ORDER CODE

NBAL S	W	H	LW	E515	24
---------------	----------	----------	-----------	-------------	-----------

DESCRIPTION

Low Screen Fabric (L), None Electric (N)
Medium Screen Fabric (L), None Electric (N)
High Screen Fabric (L), None Electric (N)
Low Screen Fabric (L)
Medium Screen Fabric (M)
High Screen Fabric (H)
Low Screen Fabric (L), None Electric (N)
Medium Screen Fabric (L), None Electric (N)
High Screen Fabric (L), None Electric (N)
Low Screen Fabric (L)
Medium Screen Fabric (M)
High Screen Fabric (H)
Low Screen Fabric (L), None Electric (N)
Medium Screen Fabric (L), None Electric (N)
High Screen Fabric (L), None Electric (N)
Low Screen Fabric (L)
Medium Screen Fabric (M)
High Screen Fabric (H)

PRICE

STANDARD TABLETOPS (S)										
SMALL POWER FLIP BLACK (B) / SMALL POWER FLIP WHITE (W)										
COM/ Grade 1	COL/ Grade 2	Grade 3	Grade 4	Grade 5	Grade 6	Grade 7	Grade 8	Grade 9	Grade 10	
2390	2452	2516	2580	2644	2706	2770	2833	2897	2959	
2576	2721	2866	3010	3155	3300	3444	3589	3734	3879	
2641	2793	2945	3097	3249	3401	3554	3706	3858	4010	
3477	3539	3603	3666	3731	3793	3857	3920	3983	4046	
3663	3808	3953	4097	4242	4387	4531	4676	4821	4966	
3728	3880	4032	4184	4336	4488	4641	4793	4945	5097	
Grade 11	Grade 12	Grade 13	Grade 14	Grade 15	Grade 16	Grade 17	Grade 18	Grade 19	Grade 20	
3024	3087	3151	3213	3277	3340	3405	3467	3531	3594	
4023	4167	4312	4456	4601	4746	4889	5034	5179	5324	
4162	4314	4467	4619	4771	4923	5075	5227	5380	5532	
4111	4174	4237	4300	4364	4427	4490	4554	4618	4681	
5109	5254	5399	5542	5687	5832	5976	6121	6266	6411	
5249	5401	5554	5706	5858	6010	6162	6314	6467	6619	
Leather LA	Leather LB	Leather LC	Leather LD							
3213	3277	3340	3405							
4456	4601	4746	4889							
4619	4771	4923	5075							
4300	4364	4427	4490							
5542	5687	5832	5976							
5706	5858	6010	6162							

Pricing and options are continued on the following pages

N B A L
Banqs Freestanding Occasional
Table with Screens

DESCRIPTION	PRICE									
	DUAL TABLETOPS (S)									
	SMALL POWER FLIP BLACK (B) / SMALL POWER FLIP WHITE (W)									
	COM/ Grade 1	COL/ Grade 2	Grade 3	Grade 4	Grade 5	Grade 6	Grade 7	Grade 8	Grade 9	Grade 10
Low Screen Fabric (L), None Electric (N)	2756	2819	2883	2945	3009	3072	3135	3199	3263	3326
Medium Screen Fabric (L), None Electric (N)	2943	3088	3233	3377	3522	3666	3809	3954	4099	4244
High Screen Fabric (L), None Electric (N)	3007	3159	3311	3464	3616	3768	3920	4072	4224	4377
Low Screen Fabric (L)	3842	3906	3970	4032	4096	4159	4222	4286	4350	4413
Medium Screen Fabric (M)	4030	4175	4320	4464	4608	4753	4753	5041	5186	5331
High Screen Fabric (H)	4094	4246	4398	4550	4703	4855	5007	5159	5310	5462
	Grade 11	Grade 12	Grade 13	Grade 14	Grade 15	Grade 16	Grade 17	Grade 18	Grade 19	Grade 20
Low Screen Fabric (L), None Electric (N)	3390	3452	3516	3580	3644	3706	3770	3833	3896	3959
Medium Screen Fabric (L), None Electric (N)	4388	4533	4678	4822	4967	5112	5257	5402	5547	5692
High Screen Fabric (L), None Electric (N)	4529	4681	4833	4985	5136	5290	5442	5594	5745	5897
Low Screen Fabric (L)	4476	4539	4603	4666	4730	4793	4857	4920	4983	5046
Medium Screen Fabric (M)	5475	5620	5765	5909	6054	6198	6342	6487	6632	6777
High Screen Fabric (H)	5616	5768	5919	6071	6223	6375	6528	6680	6832	6984
	Leather LA	Leather LB	Leather LC	Leather LD						
Low Screen Fabric (L), None Electric (N)	3580	3644	3706	3770						
Medium Screen Fabric (L), None Electric (N)	4822	4967	5112	5255						
High Screen Fabric (L), None Electric (N)	4985	5136	5290	5442						
Low Screen Fabric (L)	4666	4730	4793	4857						
Medium Screen Fabric (M)	5909	6054	6198	6342						
High Screen Fabric (H)	6071	6223	6375	6528						
If Mica/Accent Paint Finish is specified	add	24								
Single Tabletops										
If Flintwood Finish is specified	add	81								
If Veneer Finish is specified	add	126								
Dual Tabletops										
If Flintwood Finish is specified	add	348								
If Veneer Finish is specified	add	418								

banqs accessories overview

The following accessories are available in Banqs.



Banqs Untethered Cushion (NBAP)



Banqs Repositionable Coat Hook (NBAM)



Banqs Ganging Plate (NBAG)

- Connects adjacent benches or sofas without an intermediate screen



Banqs Ganging Kit (NBAEP)

- Connects adjacent benches or sofas with an intermediate screen



Banqs Sofa Undermount Power (NBAA)

- Provides additional power/data under bench or sofa seat



Banqs Small Power Flip (NBAJ)

- Provides additional power/data to Banqs tables

N B A P Banqs Untethered Cushion

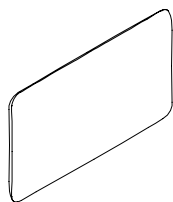

FEATURES

- Fully upholstered cushion
- 20" wide x 12" high x 4-1/2" thick
- Includes slipcover and cushion insert

NOTES

- Single upholstery (one fabric, one colourway)
- Cushions are randomly upholstered (no pattern matching from cushion to cushion)

PRODUCT OPTIONS

Size	Upholstery Finish
R Single Rectangular	Fabric Leather

SAMPLE ORDER CODE

NBAP R	E515
--------	------

DESCRIPTION

Single Rectangular (R)

Single Rectangular (R)

Single Rectangular (R)

PRICE

Grade 1	COM/ Grade 2	COL/ Grade 3	Grade 4	Grade 5	Grade 6	Grade 7	Grade 8	Grade 9	Grade 10
273	284	299	309	327	336	347	355	370	420
Grade 11	Grade 12	Grade 13	Grade 14	Grade 15	Grade 16	Grade 17	Grade 18	Grade 19	Grade 20
437	454	471	488	505	522	538	556	572	589
Leather LA	Leather LB	Leather LC	Leather LD						
607	623	640	657						

FEATURES

- Designed to be used on Banqs sofa screens
- Ships in package of (4)

NOTES

- Maximum weight capacity of 20 lbs. per hook

**N B A M
Repositionable Coat Hook**

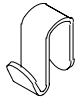

PRODUCT OPTIONS

Application	Paint Finish
01 Fabric Screen	Foundation Mica Accent

SAMPLE ORDER CODE

NBAM 01	24
---------	----

PRICE

Foundation	Mica/Accent
101	113

N B A G

Banqs Ganging Plate

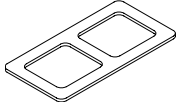

FEATURES

- Connects two adjacent benches or open-ended sofas (no screens in between connection) for linear and perpendicular planning
- Includes fastening hardware
- Ebony finish only

NOTES

- (1) Kit required per seam in linear and perpendicular planning
- Maximum of (4) consecutive units can be ganged together
- When ganging sofas with end screens, Banqs Ganging Kit (NBAEP) must be specified
- Includes:
 - 1 x Ganging Plate
 - 6 x 5/16 - 18 x 1.25 Screws
 - 6 x 5/16 Washers

PRICING

FEATURES

- Connects two adjacent sofas with screen in between, for linear and perpendicular planning
- Connects back screens of two sofas for pinwheel planning
- Includes all hardware and connectors

NOTES

- (1) Kit required per seam in linear and perpendicular planning
- Maximum of (4) consecutive units can be ganged together
- (1) Kit per sofa required for pinwheel planning
- Maximum of (4) sofas can be gained together in pinwheel configuration
- Kit includes:
 - 1 x Corner Bracket Cover
 - 1 x Corner Bracket
 - 2 x Underscreen Ganging Bracket
 - 2 x 1/4-20 x 1 Screws
 - 4 x 5/16 - 18 x 1.25 Screws
 - 4 x 5/16 Washers

**NBAEP
Banqs Ganging Kit**

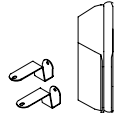

PRODUCT OPTIONS

Ganging Kit Configuration	Paint Finish
P Pinwheel and Linear	Foundation Mica Accent

SAMPLE ORDER CODE

NBAE P	24
---------------	-----------

PRICE

Foundation	Mica/Accent
119	131

N B A A **Banqs Sofa Undermount Power**

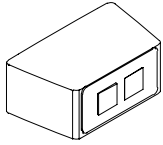

FEATURES

- Includes mounting shroud and (1) simplex power, (1) USB-A, and (1) USB-C port
- Includes wire manager
- Available with black or white faceplate

NOTES

- Does not come factory installed
- Must be installed on site, into pre-drilled locations on underside of benches and sofas
- USB ports are for charging handheld devices only
- 20 watts maximum output

PRODUCT OPTIONS

Paint Finish

W 1 Power + 1 USB-A and 1 USB-C White

B 1 Power + 1 USB-A and 1 USB-C Black

SAMPLE ORDER CODE

NBAA W

PRICING

967

FEATURES

- Designed to fit onto flat surfaces, like Banqs Table with Flat Base (NBAT)
- Includes (1) simplex power, (1) USB-A, and (1) USB-C port
- Available in black or white finish

NOTES

- Must be installed on site (does not come factory installed)
- USB ports are for charging handheld devices only
- 20 watts maximum output

N B A J
Banqs Small Power Flip

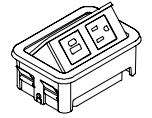

PRODUCT OPTIONS

Configuration	Finish	Cord Length (Inches)	Country of Installation
D1110 1 Power, 1 USB-A, 1 USB-C and No Data Opening	B Gloss Black W Gloss White	120	A U.S. and Canada

SAMPLE ORDER CODE

NBAJ D1110	B	120	A
-------------------	----------	------------	----------

PRICING

543

belize overview

Belize is a mobile collaborative, friendly and casual chair that provides storage and comfort.

Belize Chairs are equipped with casters intended for use on carpeted surfaces. Use of these casters on hard surfaces could result in unexpected rolling and tipping.

Casters designed for use on hard surfaces are available. If in doubt, see your dealer for appropriate selection.

Belize – Lounge (NBEC)

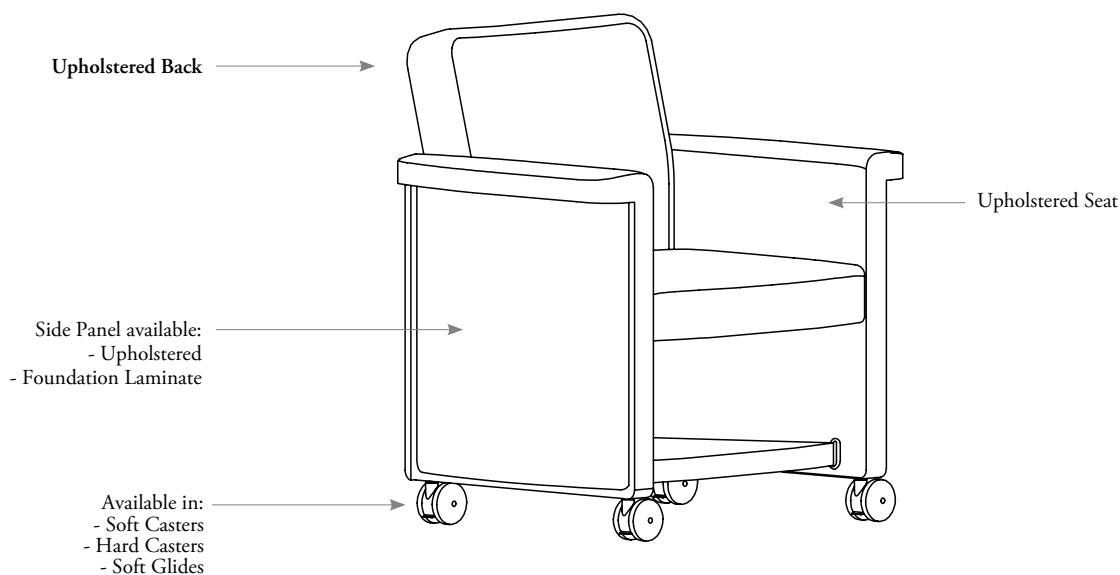

statement of line



No Accessories
(NBEC)



With Cup Holder
(NBECR)



With Tablet
(NBECR)



With Tablet and Cup Holder
(NBECRR)

belize dimensions & material requirements

features

- Designed and tested for users up to 300 lbs

weight

Soft Seating	65 lbs
--------------	--------

side panel options



Upholstered



Foundation Laminate

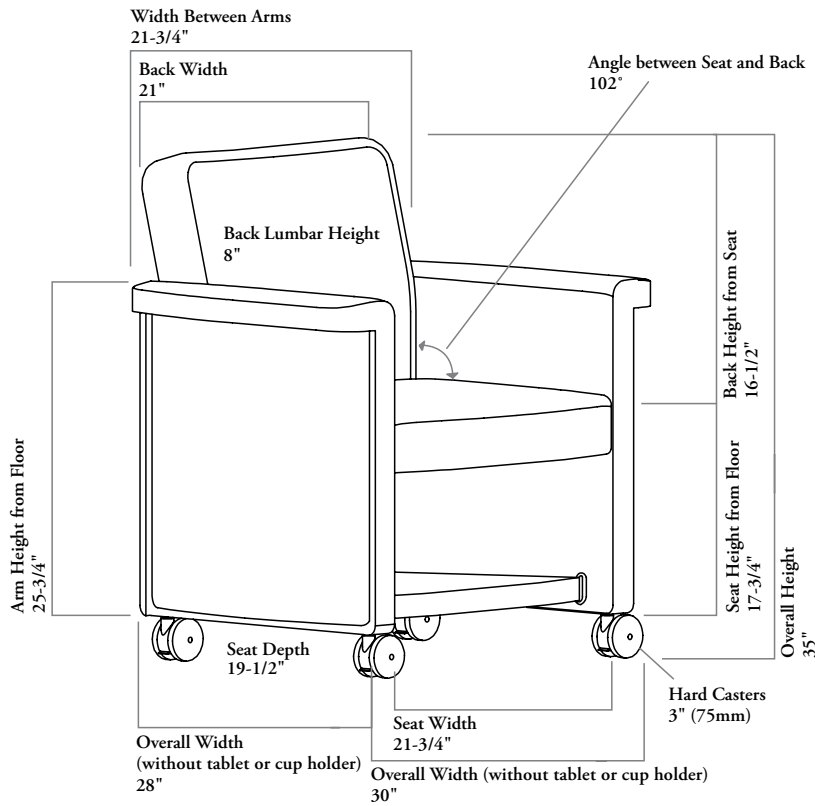

Other Dimensions

- Round Cup Holder:
 - Inside Diameter - 4"
 - Outside Diameter - 4-1/2"
- Rectangular Tablet:
 - Width - 19-3/16"
 - Depth - 11"

COM/COL material requirement

The pattern, repeat and directionality of fabric may increase the amount of yardage required.

Leather quantities should always be rounded up to the next hide size, as yields vary from 60-80% and are affected by the quality, size and shape of the hide, and by the location and quantity of blemishes.

	COM [yards]	COL [sq. ft]
Chair excluding Side Panel	3.5	54
Side Panels only	0.75	14

N B E C

Belize – Lounge



NOTES

A tablet and cup holder cannot be specified for the same side of the chair.

The handle, cup holder and tablet arm frame are finished in Polished Aluminum. The surface of the cup holder is finished with a Black, non-slip surface.

If a tablet is specified, a tablet surface finish must also be specified. Pricing shown opposite includes a Foundation, Laminate or metal tablet surface. If a Wood Veneer tablet surface is specified, the applicable upcharge must be added.

Pricing does not include the Side Panel Style. The applicable upcharge must be added based on the Side Panel Style specified.

If Upholstered Side Panel is specified, fabric for the side panel must also be specified.

Hard casters are standard on all Belize Lounge Chairs. Casters at the rear are lockable.

Leather LD is **not** available on the Belize Collection.

PRODUCT OPTIONS

Tablet	Cup Holder	Upholstery Finish	Side Panel Style	Side Panel Finish	Tablet Finish	Casters/Glides (Optional)
N No Tablet	N No Cup Holder	Fabric	U Upholstered	Fabric	Foundation Laminate	A Casters, Soft
L Tablet on Left	L Cup Holder on Left	Leather	W Foundation Laminate	Leather	Metal	B Glides, Hard
R Tablet on Right	R Cup Holder on Right (Shown)			Foundation/Mica (see Matrices for finish applicability)	Foundation/Mica (see Matrices for finish applicability)	C Glides, Soft

SAMPLE ORDER CODE

NBEC R	L	C136	U	C136	7	
---------------	----------	-------------	----------	-------------	----------	--

DESCRIPTION

PRICE

	Grade 1	COM/Grade 2	COL/Grade 3	Grade 4	Grade 5	Grade 6	Grade 7	Grade 8	Grade 9	Grade 10
No Tablet, No Cup Holder	2977	3098	3220	3338	3464	3583	3706	3822	3944	4366
No Tablet, With Cup Holder	3118	3239	3361	3479	3601	3721	3845	3967	4084	4505
With Tablet, No Cup Holder	3503	3626	3747	3863	3985	4110	4231	4350	4472	4889
With Tablet, With Cup Holder	3642	3764	3886	4005	4126	4248	4369	4490	4612	5032
	Leather LA	Leather LB	Leather LC	Leather LD						
No Tablet, No Cup Holder	4366	4707	5447	n/a						
No Tablet, With Cup Holder	4505	4846	5588	n/a						
With Tablet, No Cup Holder	4889	5232	5973	n/a						
With Tablet, With Cup Holder	5032	5370	6112	n/a						

If Upholstered Side Panel (U) is specified in	Grade 1	add 72	If Foundation Laminate Side Panel (W) is specified	add 350
	Grade 2/COM	add 101	If Soft Casters (A) is specified	add 28
	Grade 3/COL	add 138	If Hard Glides (B) is specified	add 28
	Grade 4	add 175	If Soft Glides (C) is specified	add 43
	Grade 5	add 210		
	Grade 6	add 246		
	Grade 7	add 278		
	Grade 8	add 314		
	Grade 9	add 350		
	Grade 10	add 527		
	Leather LA	add 461		
	Leather LB	add 525		
	Leather LC	add 716		

what is bonds

Bonds is designed by collaborative partners Iratzoki-Lizaso and inspired by the concept of a Jacob's Ladder, a toy made up of loosely bonded segments.

features

- An open topographical system that articulates around the central ideas of adaptability flexibility and agility for today's work and public spaces
- A concise collection of connected and freestanding seating modules, connected side table modules and auxiliary tables
- A rich and considered ecosystem of functional modules where a mix of wood, fabric and color can be configured in limitless combinations that focuses on resonating with today's emotion and aesthetic values

The design concept behind Bonds is an articulation and translation system that provides:

- An element of differentiation
- Movement in a controlled way
- An easily understandable way of adapting space
- A level of casualness that is still professional
- A degree of flexibility when specifying
- The possibility of easily rearranging existing furniture to refresh the functionality of a space



The following demonstrates the movement that can be achieved with Bonds Building Block Seats while connected.

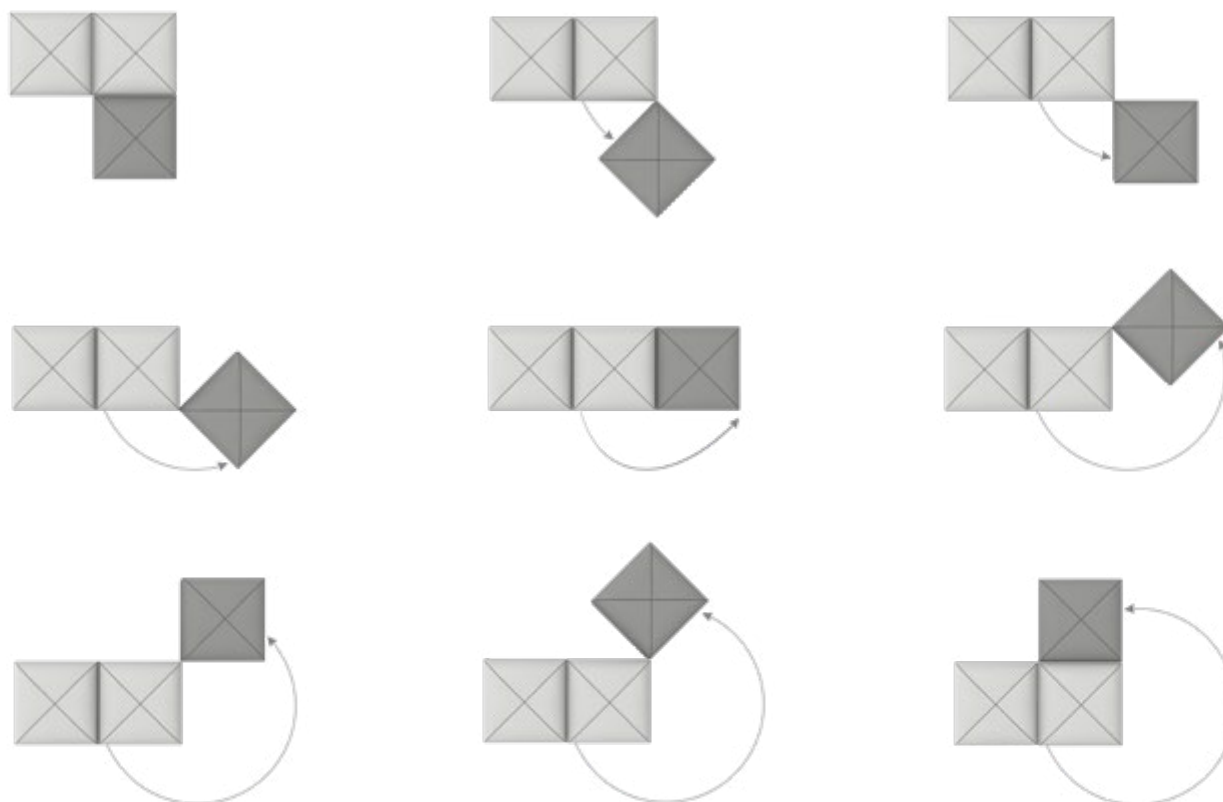

bonds product offering

Bonds consists of the following components:

freestanding blocks



Freestanding Single Block
(NBOSF_N)



Freestanding Single Block, with Tablet
(NBOSF_Y)



Freestanding Double Block
(NBOSD_1)



Freestanding Double Block, Left Tablet
(NBOSD_2)



Freestanding Double Block, Right Tablet
(NBOSD_3)



Freestanding Single Block, Double Tablet
(NBOSD_4)

building block seats



Building Block Seat - Not Strap Compatible
(NBOSN)



Building Block Seat - Strap Compatible
(NBOSS)

strap and ganging kits



Ganging Kit
(NBOSG)



Strap Kit
(NBOSK)

bonds product offering (continued)

building block tables



Building Block Table – Square (NBOTSL11)



Building Block Table – Square, Single Electrical Back (NBOTSL12)



Building Block Table – Square, Single Electrical Front (NBOTSL13 / NBOTSL14)



Building Block Table – Square, with Magazine Holder (NBOTSL21)



Building Block Table – Square, with Magazine Holder, Single Electrical Back (NBOTSL22)



Building Block Table – Square, with Magazine Holder, Single Electrical Front (NBOTSL23 / NBOTSL24)



Building Block Table – Rectangular (NBOTRL21)



Building Block Table – Rectangular, Single Electrical (NBOTRL22)



Building Block Table – Rectangular, Dual Electrical (NBOTRL24)



Building Block Table – Rectangular, with Magazine Holder (NBOTRL11)



Building Block Table – Rectangular, with Magazine Holder, Single Electrical (NBOTRL12)



Building Block Table – Rectangular, with Magazine Holder, Dual Electrical (NBOTRL14)



Building Block Table – Triangular (NBOTTL1)



Building Block Table – Triangular, Single Electrical, Back (NBOTTL2)



Auxiliary Table, Lounge Height (NBOAL)



Auxiliary Table, Work Height (NBOAW)

planning with bonds

Bonds is ideal in spaces where people gather to work, converse, relax or rest.

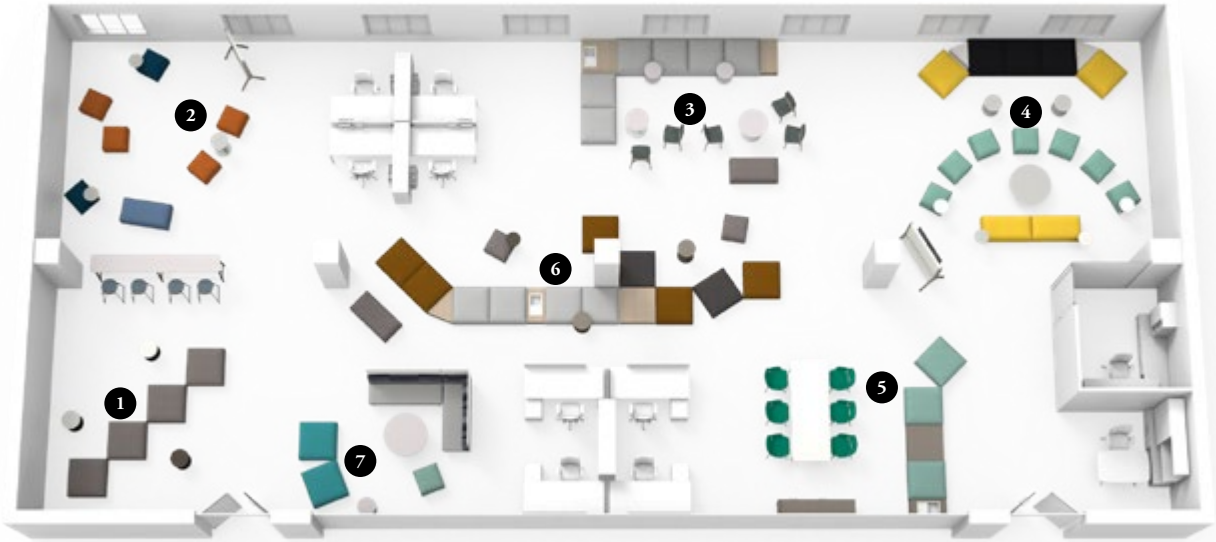

1



Reception

2



Multipurpose Spaces

3



Cafe Areas

4



Training

5



Meeting Spaces

6



Lounges

7



Casual Meetings

planning with bonds (continued)

The following layouts can be found on the Teknion Planning Tool.

planning with bonds (continued)

soft seating

planning with bonds (continued)

planning with bonds (continued)

The following should be considered when planning with Bonds.

Bonds has a unique seam stitch detail which provides an aesthetic craft detail.

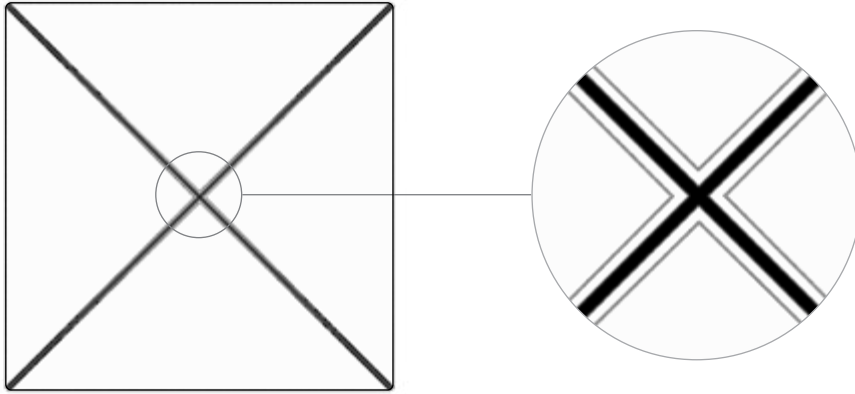

- Has a functional purpose that allows the specifier to plan layouts and color schemes for their client
- Allows for the universal use of all fabrics and is especially designed for expressive fabric patterns without the need for pattern matching
- Optimizes the use of fabrics, lowering the impact on the environment by maximizing yield and reducing waste

Building Block Tables are 1/2" smaller than Building Block Seats to allow for proper fit when seats are articulated.

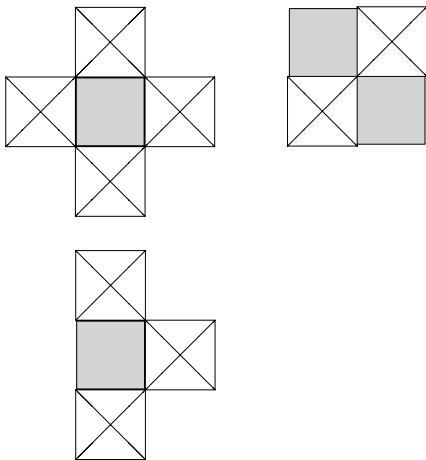

Depending on the layout, the ends of the tables and seats may not align

planning with bonds (continued)

Bonds seating and tables are available in a variety of heights to provide various seating postures.

Seat Heights:
 - 16" Lounge
 - 18" Work

Table Heights:
 - 10-1/4" and 19" Lounge
 - 27" Work

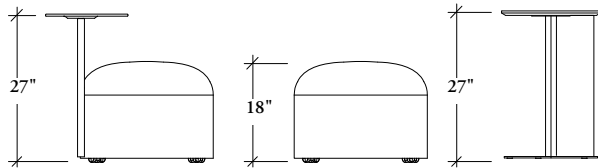

Work Height Seats with Tablets or Auxiliary Tables

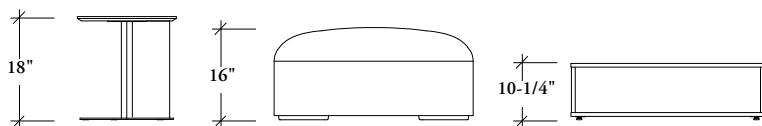

Lounge Height Seats with Lounge Height Tables

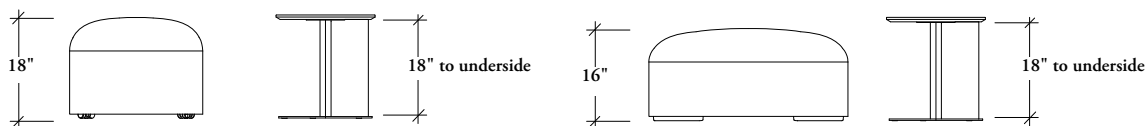

Work Height Seat and Lounge Table
 - Seat nests flush to the underside of the table

Lounge Height Seats and Tables
 - Seat is offset 2" from the bottom of the table

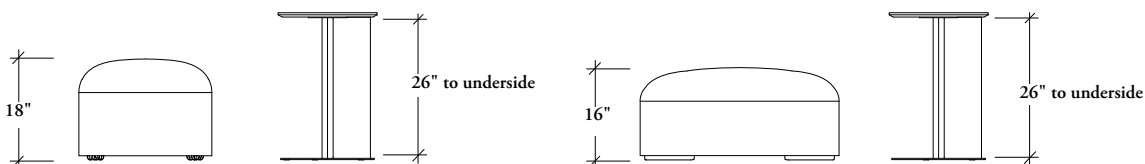

Work Height Seat with Work Height Table
 - Seat nests flush to the underside of the table

Lounge Height Seat with Work Height Table
 - Seat is offset 2" from the bottom of the table

planning with bonds (continued)

Bonds planning is based on three planning styles.

dynamic

- Building Block Seats are unattached and can be easily moved
- A minimum of two units and a maximum of six units is recommended

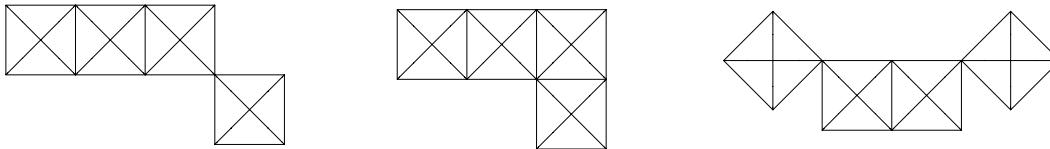

stationary

- Building Block Seats are fixed
- Attached with straps or ganging kits

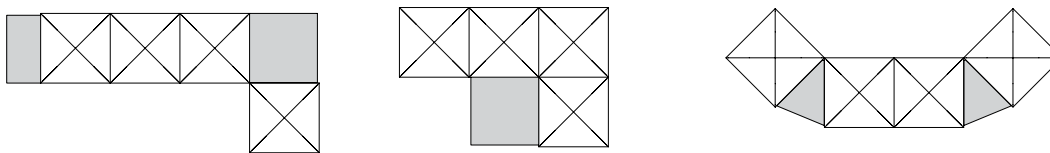

modifying elements

- Freestanding seats and tables are used with dynamic and stationary elements to add function and visual depth to a setting

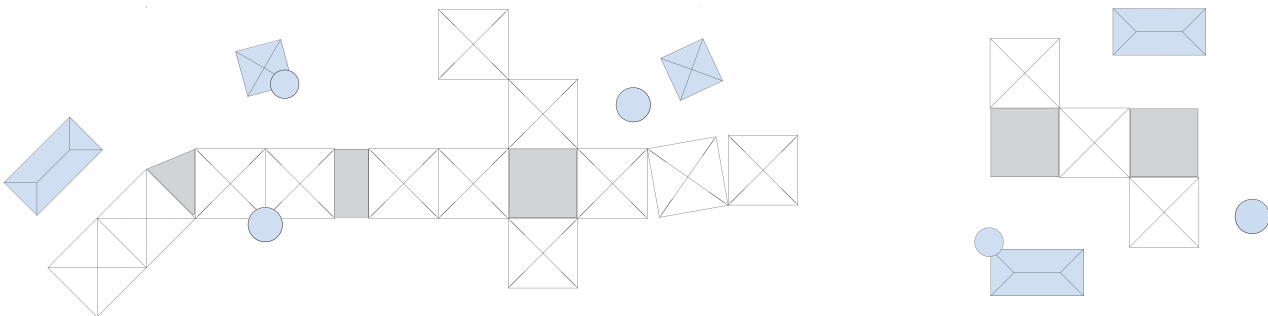

planning with bonds (continued)

Configurations can be planned to allow for various levels of movement.

dynamic with strap kit

The strap kit allows Building Block Seats to be dynamic where every unit can be moved.

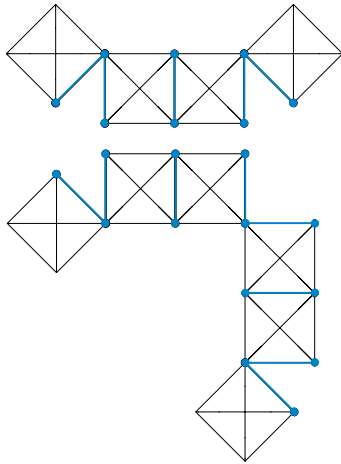

dynamic with strap kit or fixed with ganging mechanism

The same configuration can be achieved using either straps or ganging kits depending on how dynamic the configuration should be.

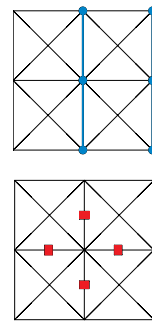

fixed with ganging kits

All units are fixed and **cannot** be moved.

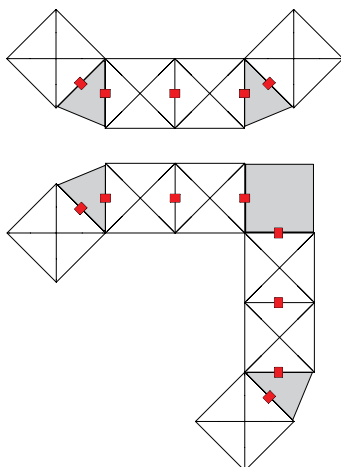

planning with bonds (continued)

Bonds unique ability to connect with either straps or linking brackets makes it ideal for planning around walls and columns.

walls

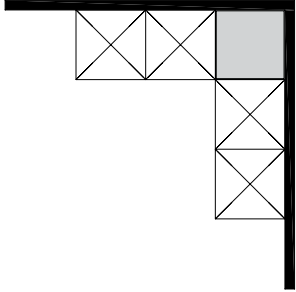

Inside corner, either dynamic or fixed

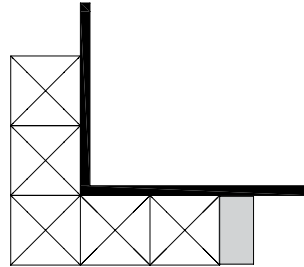

Outside corner, either dynamic or fixed

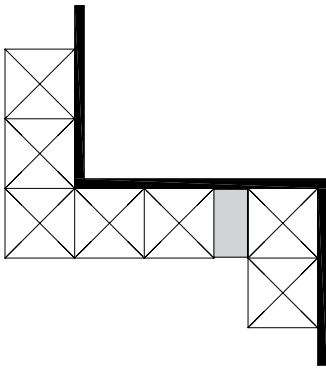

Wrapping around inside and outside corners, either dynamic or fixed

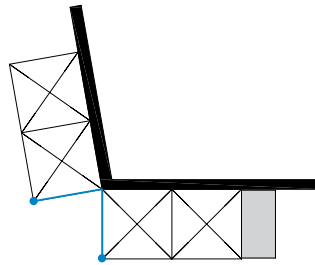

Outside corner where walls are not straight

columns

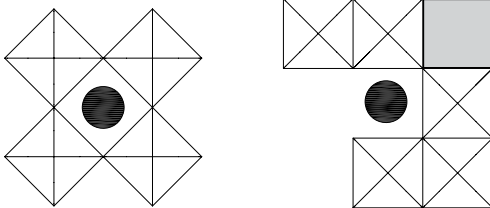

Seats can wrap completely or partially around columns

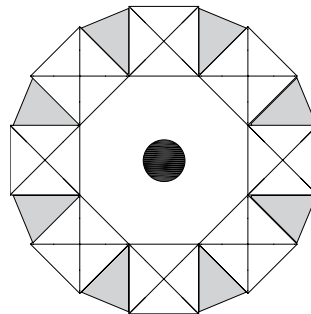

Triangular tables can be used to create circular or curved configurations that can wrap completely or partially around columns

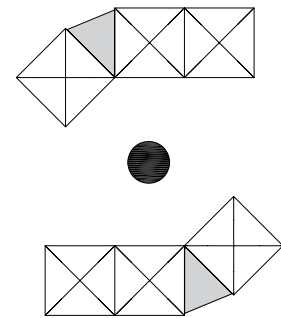

planning with bonds (continued)

An unlimited amount of configurations can be created with Bonds depending on the number of Building Block Seats and Building Block Tables are used.

two building blocks

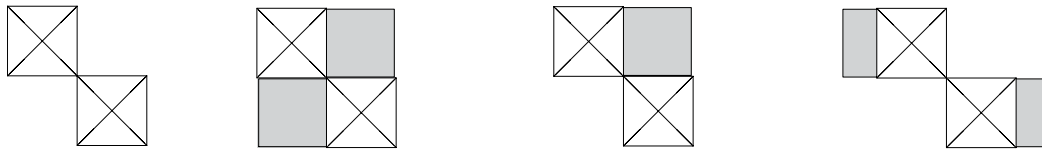
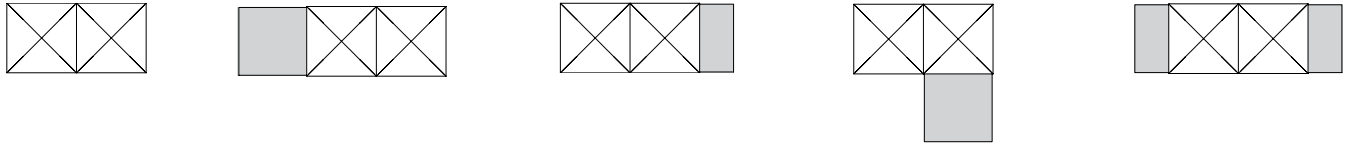

three building blocks

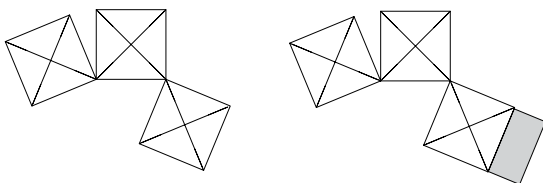
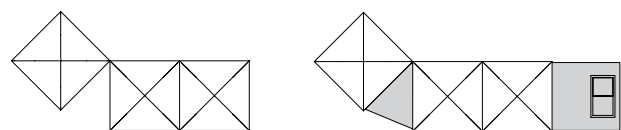
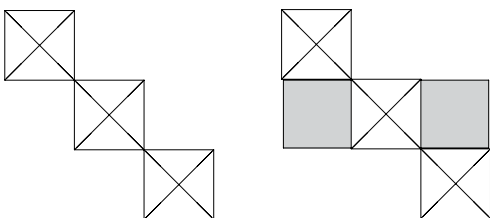
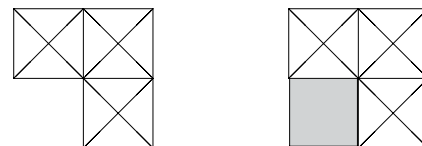
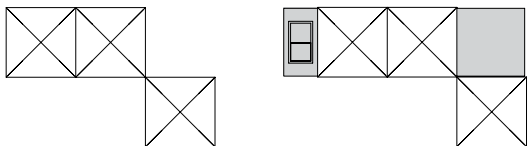
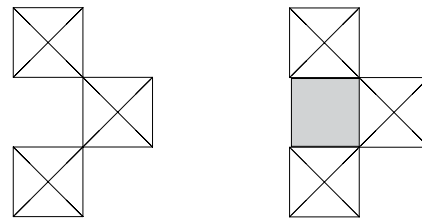
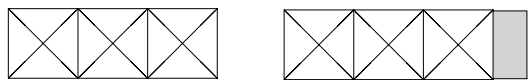

planning with bonds (continued)

four building blocks

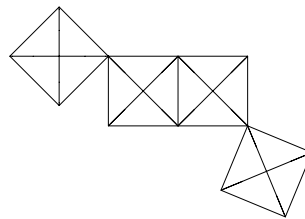
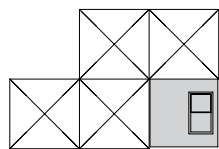
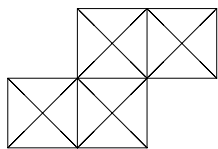
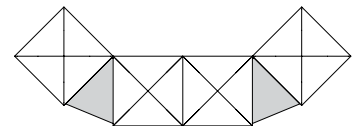
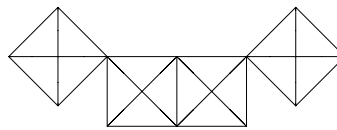
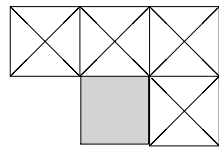
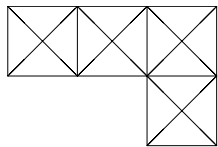
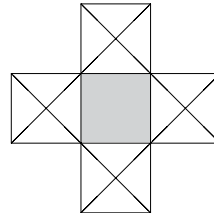
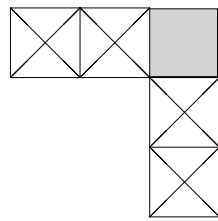
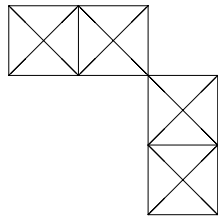
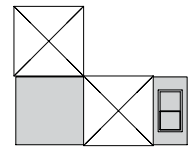
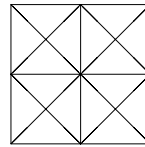
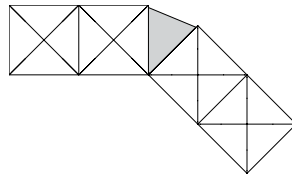
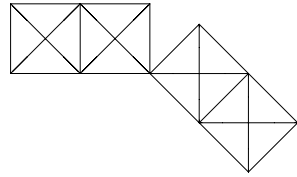
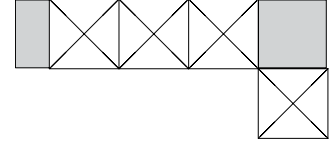
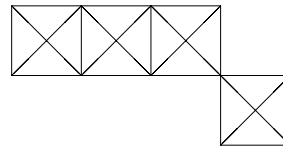
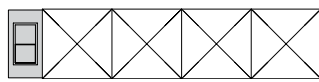
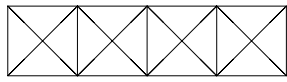

planning with bonds (continued)

five building blocks

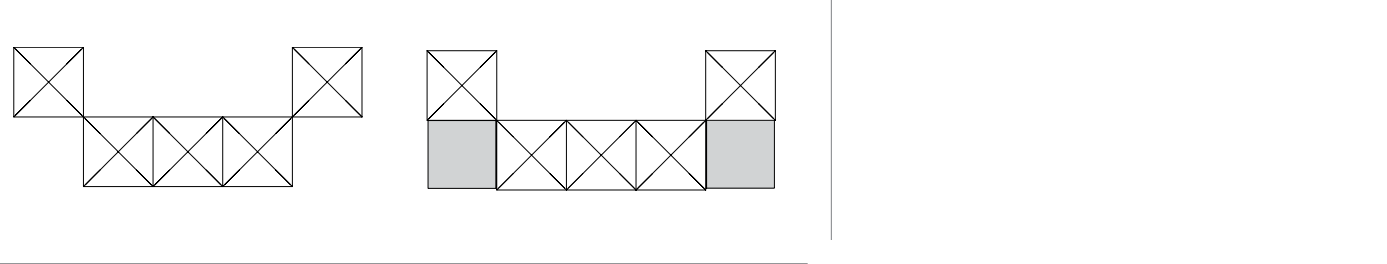
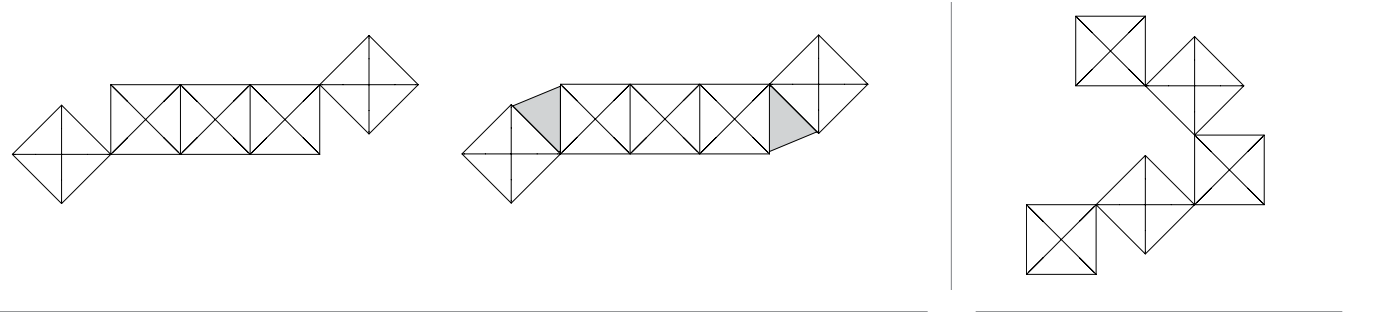
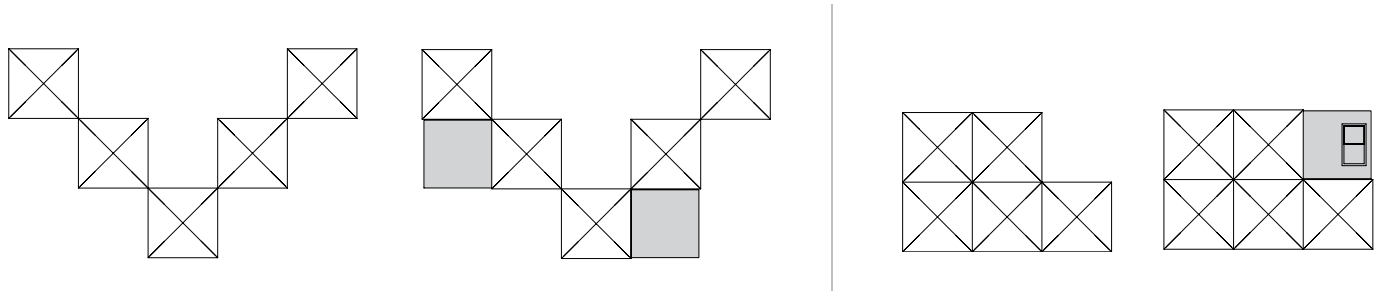
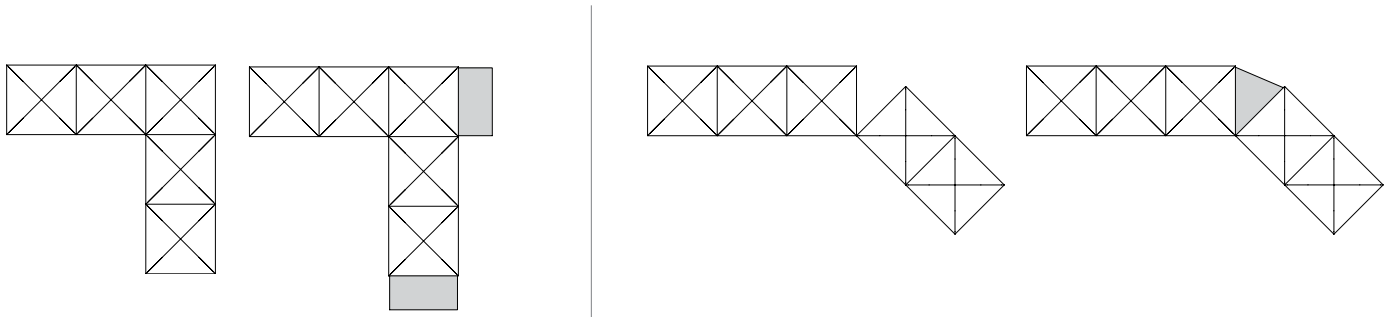
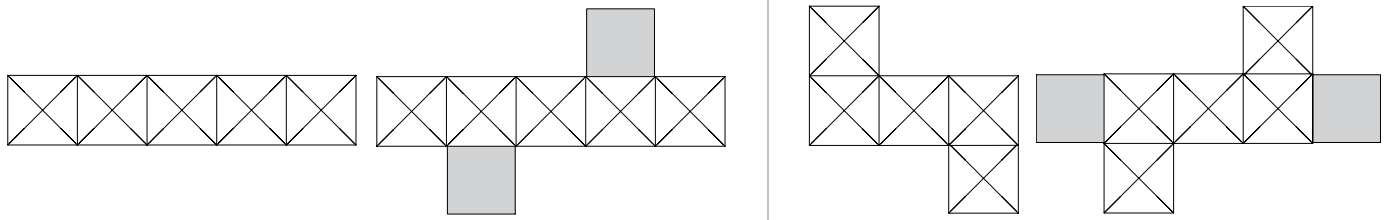

planning with bonds (continued)

six building blocks

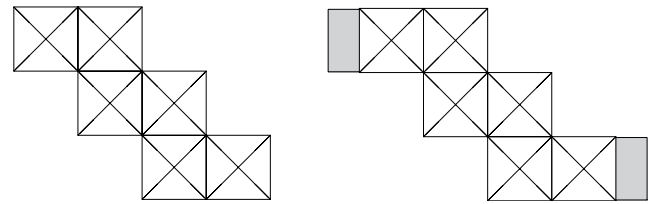
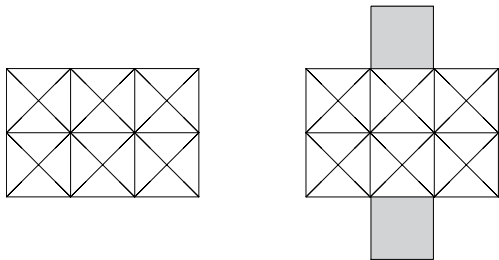
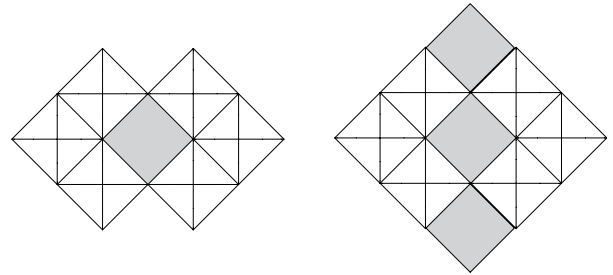
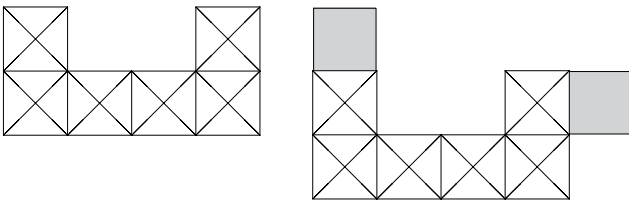
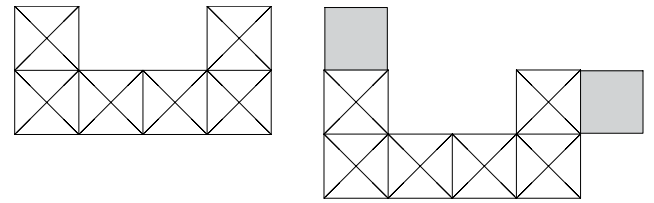
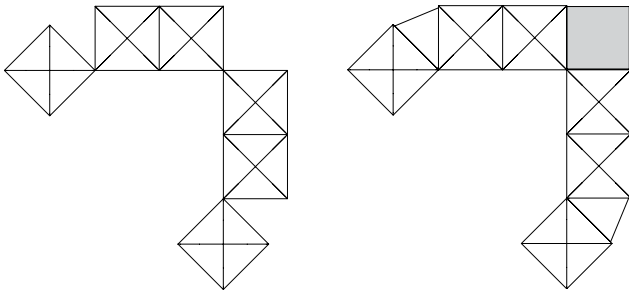
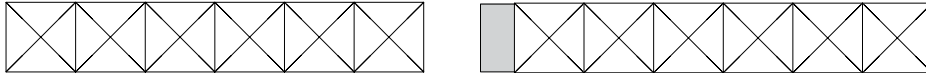

bonds freestanding seating overview

Bonds Freestanding Single Blocks have optional tablets and provide a freestanding seat for one user.

Freestanding Single Block (NBOSF)



finishes

Upholstery:
- Available in all Teknion grade-in fabrics (excluding leather)

Table Top Metal:
- Foundation
- Mica
- Accent

statement of line



Freestanding Single Block (NBOSF_N)

Freestanding Single Block, with Tablet (NBOSF_Y)

bonds freestanding seating overview (continued)

Bonds Freestanding Double Blocks have optional tablets and provide a freestanding seat for two users.

Freestanding Double Block (NBOSD)



finishes

- Upholstery:
- Available in all Teknion grade-in fabrics (excluding leather)
- Table Top Metal:
- Foundation
 - Mica
 - Accent

statement of line

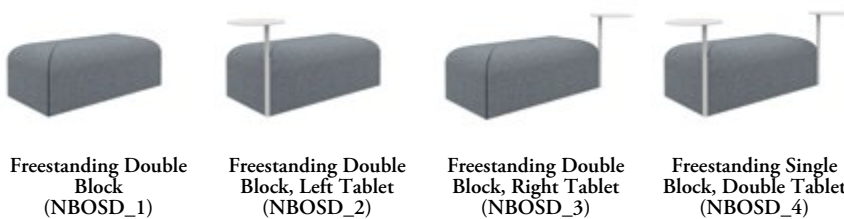

bonds freestanding seating dimensions & material requirements

features

- Bonds Freestanding Seating is proportioned to accommodate the growing needs of the North American market and tested to ANSI/BIFMA standards

weight

Freestanding Single Block	31 lbs
Freestanding Double Block	55 lbs

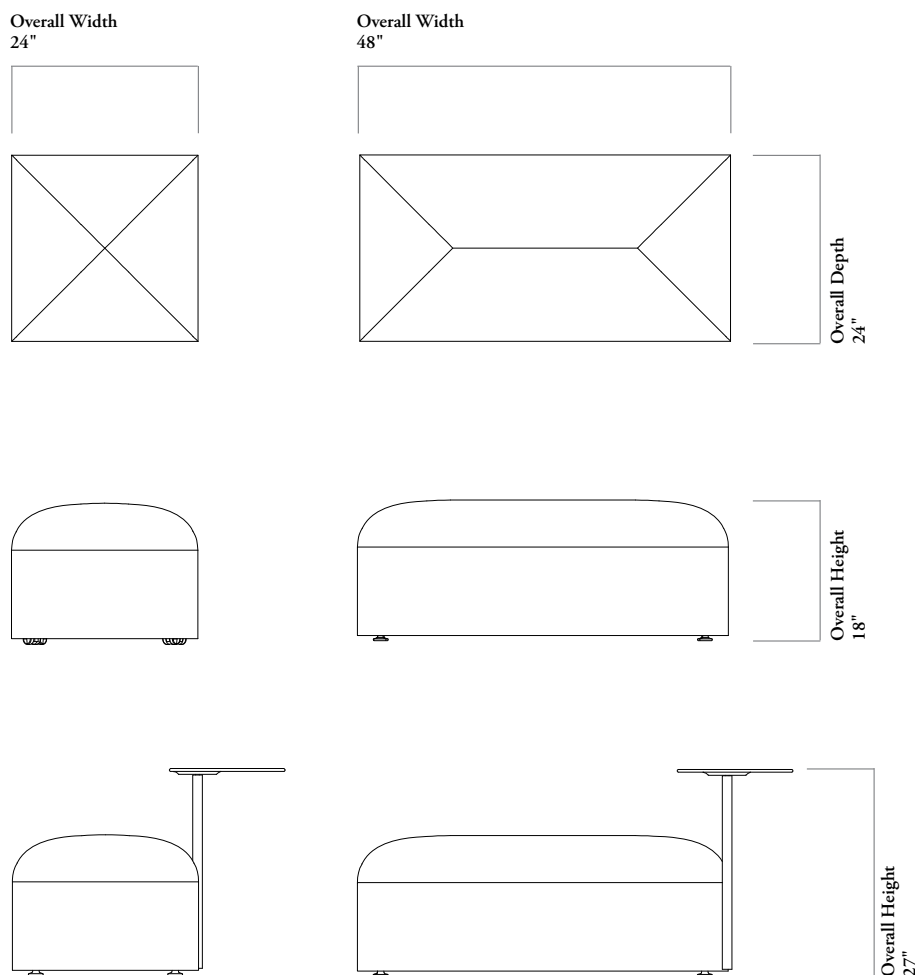

COM/COL material requirement

The pattern, repeat and directionality of fabric may increase the amount of yardage required.

	UPHOLSTERED
	COM [yards]
Freestanding Single Block	2
Freestanding Double Block	3.25

planning with bonds freestanding seating

The following should be considered when planning with Freestanding Seating

- ✓ Freestanding Single and Double Blocks are available with optional pivoting tablets.

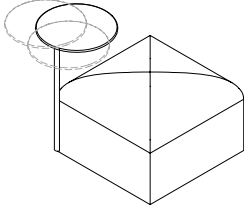

- ✗ Freestanding Blocks cannot be connected, so cannot articulate with a strap kit.

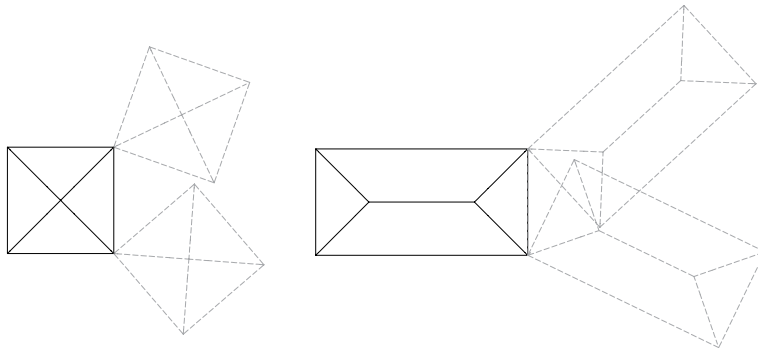

- ✗ Freestanding blocks are not intended to be placed in grouped formations.

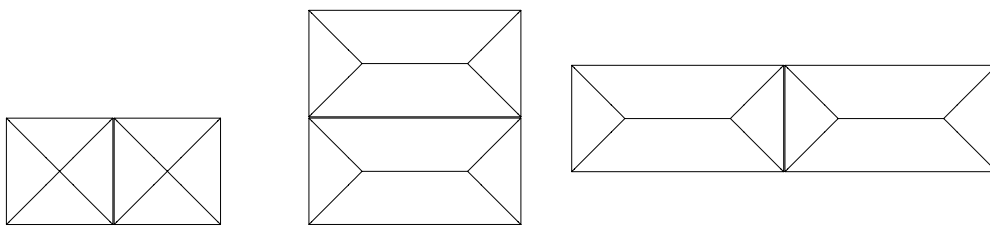

N B O S F

Freestanding Single Block

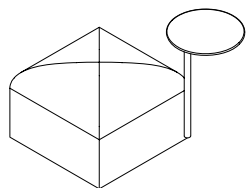

FEATURES

- Fully upholstered, fixed height (18"), casual seating solutions
- Optional metal pivoting tablet provides a worksurface
- Universal seam stitch detail designed for use with all fabrics, especially expressive fabric patterns without the need for pattern matching
- Standard with hard casters, options for soft casters, and hard and soft glides

NOTES

Strap Kit and Ganging Kit (Linking Brackets) **cannot** be used on this unit.

PRODUCT OPTIONS

Seat Height	Width	Depth	Tablet Option	Seat Upholstery Finish	Tablet Finish	Casters/Glides
W Work Height	24	24	N No Y Yes	Fabric	Foundation Mica Accent	Casters, Hard A Casters, Soft B Glides, Hard C Glides, Soft

SAMPLE ORDER CODE

NBOSF W	24	24	Y	E515	20	A
----------------	-----------	-----------	----------	-------------	-----------	----------

DESCRIPTION

No Tablet
With Tablet

PRICE

	COM/									
	Grade 1	Grade 2	Grade 3	Grade 4	Grade 5	Grade 6	Grade 7	Grade 8	Grade 9	Grade 10
No Tablet	1592	1643	1695	1745	1797	1849	1901	1951	2003	2056
With Tablet	1856	1907	1959	2009	2061	2114	2166	2216	2268	2321
	Grade 11	Grade 12	Grade 13	Grade 14	Grade 15	Grade 16	Grade 17	Grade 18	Grade 19	Grade 20
No Tablet	2108	2159	2211	2263	2315	2366	2419	2471	2523	2574
With Tablet	2373	2424	2477	2529	2581	2632	2692	2736	2789	2840

If Mica/Accent is specified, add 17
If Soft Casters (A) is specified, add 159

FEATURES

- Fully upholstered, fixed height (18"), casual seating solutions
- Optional metal pivoting tablet provides a worksurface
- Universal seam stitch detail designed for use with all fabrics, especially expressive fabric patterns without the need for pattern matching
- Standard with multi-surface glides, options for soft and hard casters
- Handedness is determined by the location of the tablet from the seated position

NOTES

Strap Kit and Ganging Kit (Linking Brackets) **cannot** be used on this unit.

N B O S D
Freestanding Double Block

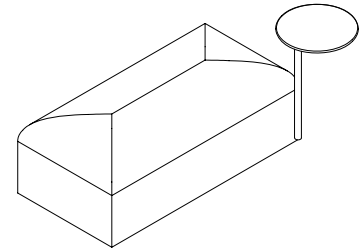

PRODUCT OPTIONS

Seat Height	Width	Depth	Tablet Option	Seat Upholstery Finish	Tablet Finish	Casters/Glides
W Work Height	48	24	1 No Tablet 2 Single Tablet (Left) 3 Single Tablet (Right) 4 Double Tablet	Fabric Leather	Foundation Mica Accent	Glides, Multi-surface A Casters, Soft D Casters, Hard

SAMPLE ORDER CODE

NBOSD W	24	24	2	E515	20	A
----------------	-----------	-----------	----------	-------------	-----------	----------

DESCRIPTION

PRICE

	COM/									
	Grade 1	Grade 2	Grade 3	Grade 4	Grade 5	Grade 6	Grade 7	Grade 8	Grade 9	Grade 10
No Tablet	1993	2044	2127	2211	2297	2380	2465	2550	2631	2716
Single Tablet, Left/Right	2257	2308	2392	2477	2561	2645	2731	2814	2895	2981
Double Tablet	2455	2508	2591	2676	2761	2844	2927	3011	3095	3180
	Grade 11	Grade 12	Grade 13	Grade 14	Grade 15	Grade 16	Grade 17	Grade 18	Grade 19	Grade 20
No Tablet	2800	2885	2970	3054	3139	3222	3307	3392	3477	3561
Single Tablet, Left/Right	3066	3151	3235	3320	3405	3488	3573	3657	3742	3827
Double Tablet	3264	3349	3434	3517	3602	3686	3771	3856	3941	4025

If Mica/Accent is specified, add	17
If Hard Casters (D) is specified, add	133
If Soft Casters (A) is specified, add	159

bonds building block seat - not strap compatible overview

Bonds Building Block Seats - Not Strap Compatible can be planned freestanding or fixed.

Building Block Seat - Not Strap Compatible (NBOSN)



Ganging Kit (NBOSG)

- Used to connect two Building Block Seats
- Prevents Building Blocks Seats from moving or rotating
- Includes two metal brackets and connection hardware (one Ganging Kit is required for each connection)

finishes

Upholstery:
- Available in all Teknion grade-in fabrics (excluding leather)

statement of line



Building Block Seat -
Not Strap Compatible
(NBOSN)

bonds building block seat - strap compatible overview

Bonds Building Block Seats - Strap Compatible can be planned freestanding or connected with strap kits.

Building Block Seat - Strap Compatible (NBOSS)



Strap Kit (NBOSK)

- Connects to two Building Block Seats at the zippered corner to allow them to articulate
- Can be turned clockwise or counterclockwise a full 180° and remain attached

finishes

Upholstery:
- Available in all Teknion grade-in fabrics (excluding leather)

statement of line



Building Block Seat -
Strap Compatible
(NBOSS)

bonds building blocks seating dimensions & material requirements

features

- Bonds Freestanding Seating is proportioned to accommodate the growing needs of the North American market and tested to ANSI/BIFMA standards

weight

Building Block Seat, No Strap Compatible	47 lbs
Building Block Seat, Strap Compatible	48 lbs

Overall Width
36"

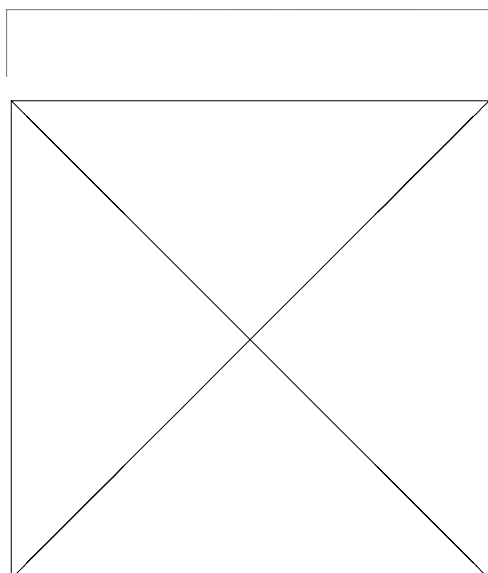

Overall Depth
36"

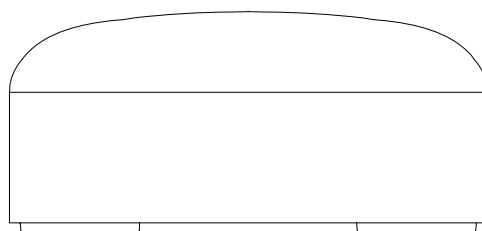

Overall Height
16"

COM/COL material requirement

The pattern, repeat and directionality of fabric may increase the amount of yardage required.

	UPHOLSTERED
	COM
	[yards]
Building Block Seat, No Strap Compatible	4
Building Block Seat, Strap Compatible	4

N B O S N

Building Block Seat - Not Strap Compatible

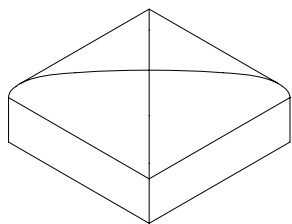

FEATURES

- Fully upholstered, fix height (16") modular seating solution
- Universal seam stitch detail designed for use with all fabrics, especially expressive fabric patterns without the need for pattern matching
- Multiple building block seats can be ganged together with linking kits

NOTES

Closed corner detail cannot accept a Strap Kit (NBOSK).
Ganging Kit (NBOSG) can be used with this unit.

PRODUCT OPTIONS

Seat Height	Width	Depth	Seat Upholstery Finish
L Lounge Height	36	36	Fabric

SAMPLE ORDER CODE

NBOSN L	36	36	E515
----------------	-----------	-----------	-------------

PRICE

COM/															
Grade 1	Grade 2	Grade 3	Grade 4	Grade 5	Grade 6	Grade 7	Grade 8	Grade 9	Grade 10	Grade 11	Grade 12	Grade 13	Grade 14	Grade 15	Grade 16
1923	2025	2127	2232	2330	2435	2537	2641	2745	2849	2951	3054	3156	3260	3362	3465
Grade 17	Grade 18	Grade 19	Grade 20												
3567	3670	3772	3876												

FEATURES

- Fully upholstered, fixed height (16") modular seating solution that is user adaptable
- Universal seam stitch detail designed for use with all fabrics, especially expressive fabric patterns without the need for pattern matching
- Strap kit is required to connect Building Block Seats

NOTES

Zippered corner detail can accept a Strap Kit (NBOSK).
Ganging Kit (NBOSG) can be used with this unit.

N B O S S
Building Block Seat -
Strap Compatible

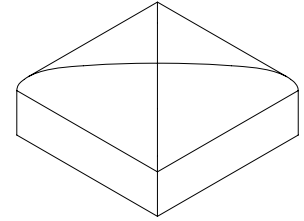

PRODUCT OPTIONS

Seat Height	Width	Depth	Seat Upholstery Finish
L Lounge Height	36	36	Fabric

SAMPLE ORDER CODE

NBOSS L	36	36	E515
----------------	-----------	-----------	-------------

PRICE

COM/															
Grade 1	Grade 2	Grade 3	Grade 4	Grade 5	Grade 6	Grade 7	Grade 8	Grade 9	Grade 10	Grade 11	Grade 12	Grade 13	Grade 14	Grade 15	Grade 16
2123	2212	2315	2417	2524	2626	2731	2833	2937	3039	3144	3247	3351	3454	3559	3662
Grade 17	Grade 18	Grade 19	Grade 20												
3767	3870	3974	4077												

N B O S G **Ganging Kit**

FEATURES

- Connects two Building Block Seats or a Building Block Seat to a Building Block table
- Prevent Building Blocks from moving or rotating
- Ebony finish
- Each linking bracket has a built-in dampener to prevent floor damage

NOTES

Includes two metal brackets and connection hardware.

One linking bracket is required for each connection.

Cannot be used to connect two Building Block Tables to each other.



PRICE

122

FEATURES

- Connects to two Building Block Seats at the zippered corner to allow them to articulate
- Can be turned clockwise or counterclockwise a full 180° and remain attached

NOTES

Includes two woven straps matched to Foundry Oxyx with Foundry Oxyx metal painted brackets.

**N B O S K
Strap Kit**

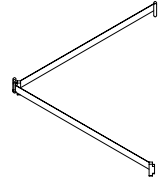

PRICE

200

bonds building block square table overview

The Bonds Building Block Square Table is used with Building Block Seats to create a variety of fixed configurations.

Building Block Table – Square (NBOTS)



finishes

Table Finishes:

- Source Laminate
- Flintwood
- Veneer 2 and 3

Metal Magazine Holder Finishes:

- Foundation
- Mica
- Accent

Electrical Module Finishes:

- Ebony
- Atrium White

bonds building block table square dimensions & material requirements

features

- Meets ANSI/BIFMA Requirement

weight

Building Block Table – Square	106 lbs
-------------------------------	---------

Overall Width
35-1/2"



Overall Depth
35-1/2"

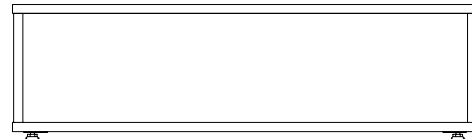

Overall Height
10-1/4"

grain direction

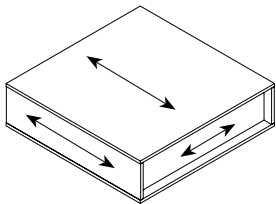

bonds building block rectangular table overview

The Bonds Building Block Rectangular Table is used with Building Block Seats to create a variety of fixed configurations.

Building Block Table – Rectangular (NBOTR)



finishes

- Wood Case Finishes:
 - Source Laminate
 - Flinrwood
 - Veneer 2 and 3
- Metal Magazine Holder Finishes:
 - Foundation
 - Mica
 - Accent

statement of line



Building Block Table – Rectangular (NBOTRL21)

Building Block Table – Rectangular, Single Electrical (NBOTRL22)

Building Block Table – Rectangular, Dual Electrical (NBOTRL24)

Building Block Table – Rectangular, with Magazine Holder (NBOTRL11)

Building Block Table – Rectangular, with Magazine Holder, Single Electrical (NBOTRL12)

Building Block Table – Rectangular, with Magazine Holder, Dual Electrical (NBOTRL14)

bonds building block table rectangular dimensions & material requirements

features

- Meets ANSI/BIFMA Requirement

weight

Building Block Table – Rectangular	106 lbs
------------------------------------	---------

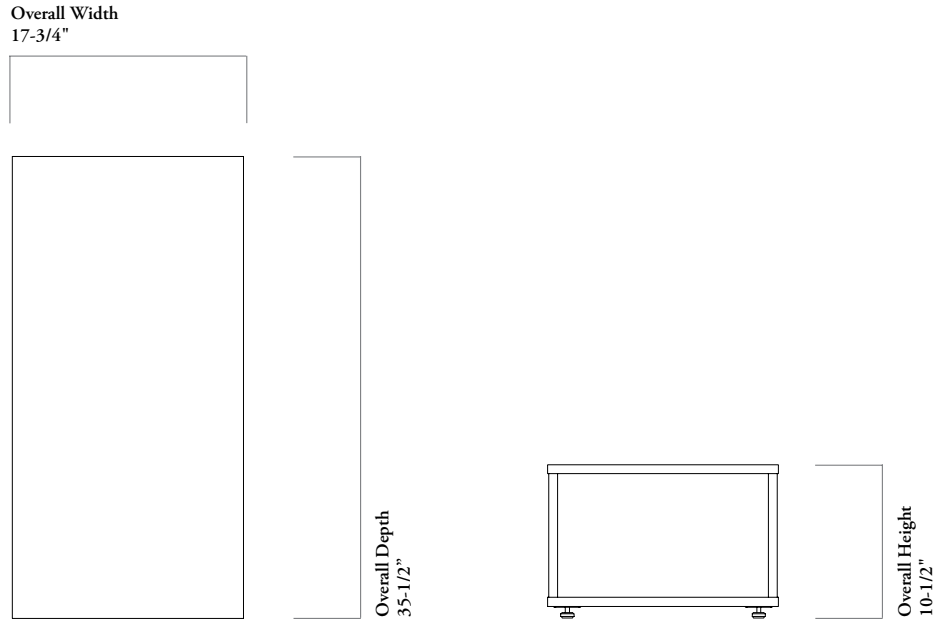

grain direction

The following outlines the grain direction on Bonds tables.

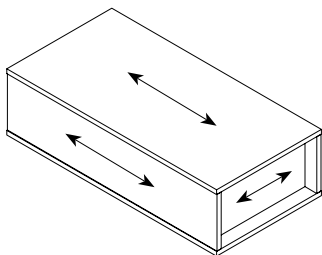

bonds building block triangular table overview

The Bonds Building Block Triangular Table is used with Building Block Seats to create a variety of fixed configurations.

Building Block Table – Triangular (NBOTT)



finishes

- Wood Case Finishes:
- Source Laminate
 - Flintwood
 - Veneer 2 and 3

statement of line



Building Block Table –
Triangular
(NBOTT1)

Building Block Table
– Triangular, Single
Electrical, Back
(NBOTT2)

bonds building block table triangular dimensions & material requirements

features

- Meets ANSI/BIFMA Requirement
- Bonds Freestanding Seating is proportioned to accommodate the growing needs of the North American market and tested to ANSI/BIFMA standards

weight

Building Block Table – Triangular	106 lbs
-----------------------------------	---------

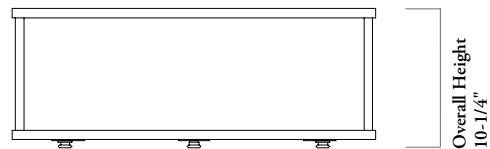
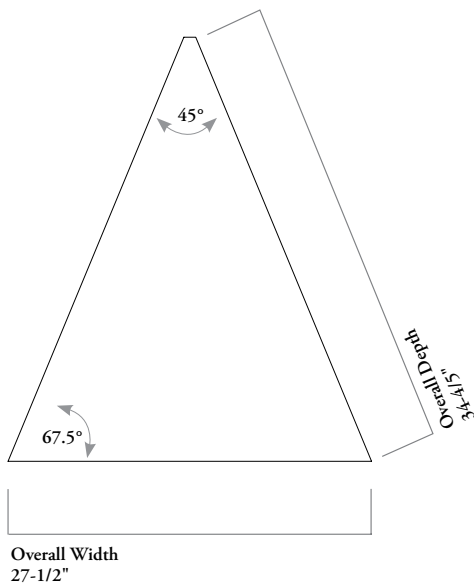

grain direction

The following outlines the grain direction on Bonds tables.

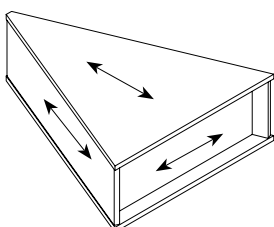

planning with bonds building block tables

✓ Building Block Tables can be placed beside or between two Building Block Seats.

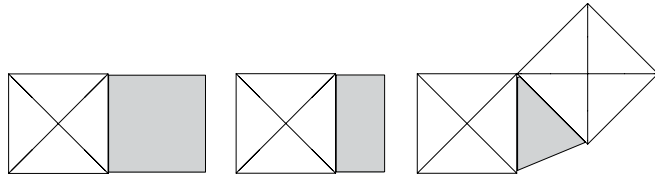

✓ Articulation only happens between Building Block Seats

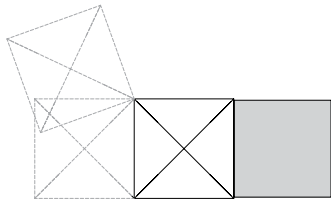

✗ Building Block Seat placed beside a Building Block Table cannot articulate.

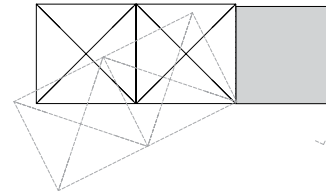

✗ Two Building Block Tables should not be attached to each other.

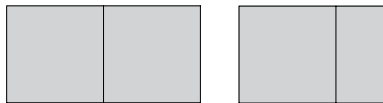

✗ Building Block Seats must align with Building Block Tables, they cannot be offset, or rotated.

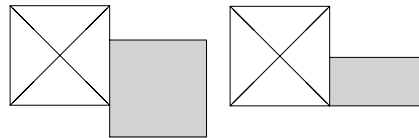

✓ The triangular Building Block Table must be planned between two Building Block Seats.

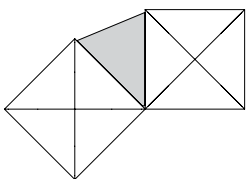

✗ Building Blocks are not intended to be used as stand-alone tables.

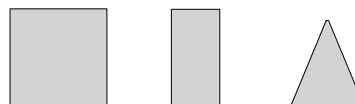

planning with bonds building block tables (continue)

The following should be considered when planning with Building Block Tables.

Building Block Tables are available with options for electrical outlets.

- Tables are open at the bottom to allow the table to sit over a floor monument
- Electrical Options:
 - one USB-A
 - one USB-C
- Dimensions:
 - Width: 3-1/4"
 - Height: 2"
- Includes a 10' cable
- Location of the module is always in the center, available:
 - single sided for all tables
 - double sided for th Square Block and Rectangular Block tables

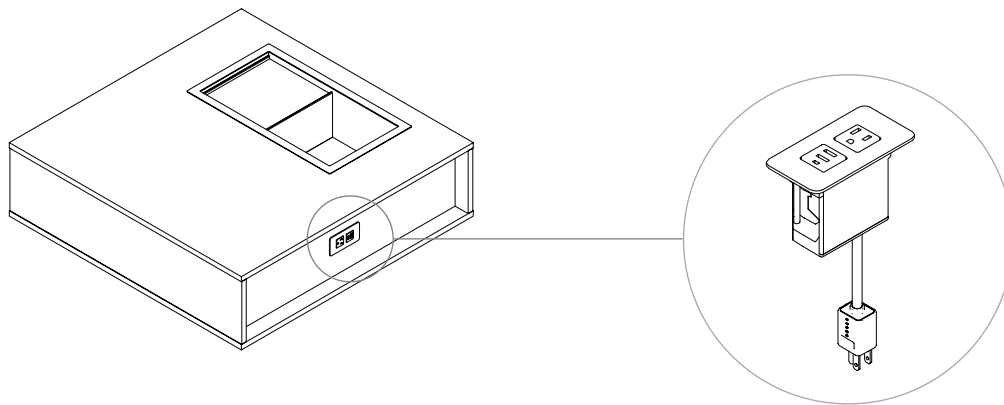

N B O T S

Building Block Table – Square

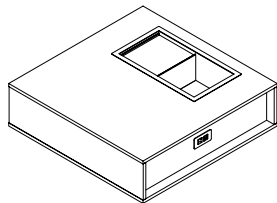

FEATURES

- Modular lounge height table (10-1/4" h) that is used with Building Block Seats
- Seats can be linked from all sides
- Optional electrical modules available for single and dual sided applications
- Optional sliding literature holder is available which includes an integrated surface to place work tools

NOTES

Includes one Ebony linking bracket.

Top surface is only available with a flat edge.

Electrical configuration always includes 1 Power + 1 USB-A + 1 USB-C in an Ebony or Atrium White finish.

Electrical option includes 10ft (120") cable length and self contained certified housing.

PRODUCT OPTIONS

Table Height	Magazine Holder	Electrical Option	Wood Case Finish	Magazine Holder Finish	Electrical Faceplate Finish
L Lounge Height Compatible	1 No Magazine Holder	1 No Electrical Access	Source laminate	Foundation	52 Ebony
	2 Magazine Holder - Back	2 Single Electrical Access - Back	Flintwood	Mica	20 Atrium White
		3 Single Electrical Access - Front	Natural Veneer 2 and 3	Accent	
		4 Dual Electrical Access - Front and Back			

SAMPLE ORDER CODE

NBOTS L	2	2	3G	20	52
----------------	----------	----------	-----------	-----------	-----------

DESCRIPTION

No Magazine Holder, No Electrical Access
No Magazine Holder, Single Electrical Access-Front or Back
No Magazine Holder, Dual Electrical Access-Front & Back
With Magazine Holder, With Electrical Access
With Magazine Holder, Single Electrical Access-Front or Back
With Magazine Holder, Dual Electrical Access-Front & Back

PRICE

	Source Laminate Case	Flintwood Case	Veneer Case
No Magazine Holder, No Electrical Access	677	1042	1090
No Magazine Holder, Single Electrical Access-Front or Back	712	1080	1125
No Magazine Holder, Dual Electrical Access-Front & Back	748	1115	1161
With Magazine Holder, With Electrical Access	993	1358	1406
With Magazine Holder, Single Electrical Access-Front or Back	1029	1393	1442
With Magazine Holder, Dual Electrical Access-Front & Back	1064	1430	1477

N B O T R

Building Block Table – Rectangular

FEATURES

- Modular lounge height table (10-1/4"h) that is used with Building Block Seats
- Seats can be linked from all sides
- Optional electrical modules available for single and dual sided applications
- Optional sliding literature holder is available which includes an integrated surface to place work tools

NOTES

Includes one Ebony linking bracket.

Top surface is only available with a flat edge.

Electrical configuration always includes 1 Power + 1 USB-A + 1 USB-C in an Ebony or Atrium White finish.

Electrical option includes 10ft (120") cable length and self contained certified housing.

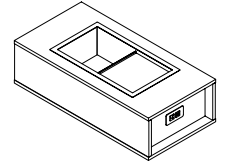

PRODUCT OPTIONS

Table Height	Magazine Holder	Electrical Option	Wood Case Finish	Magazine Holder Finish	Electrical Faceplate Finish
L Lounge Height Compatible	2 Yes	1 No Electrical Access	Source laminate	Foundation	52 Ebony
	1 No	2 Single Electrical Access 4 Dual Electrical Access	Flintwood Natural Veneer 2 and 3	Mica Accent	20 Atrium White

SAMPLE ORDER CODE

NBOTR L	2	2	3G	20	52
----------------	----------	----------	-----------	-----------	-----------

DESCRIPTION

PRICE

	Source Laminate Case	Flintwood Case	Veneer Case
No Magazine Holder, No Electrical Option	534	769	803
No Magazine Holder, Single Electrical Access	568	805	838
No Magazine Holder, Dual Electrical Access	607	842	876
With Magazine Holder, With Electrical Option	850	1086	1118
With Magazine Holder, Single Electrical Access	885	1121	1154
With Magazine Holder, Dual Electrical Access	920	1157	1189

N B O T T

Building Block Table – Triangular

FEATURES

- Modular lounge height table (10-1/4"h) that is used with Building Block Seats
- Seats can be linked from all sides
- Optional electrical modules available for single and dual sided applications
- Electrical options are available with 1 power, 1 USB-A and 1 USB-C outlet

NOTES

Includes one Ebony linking bracket.

Top surface is only available with a flat edge.

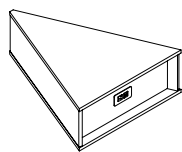

PRODUCT OPTIONS

Table Height	Electrical Option	Wood Case Finish	Electrical Faceplate Finish
L Lounge	1 No Electrical Access 2 Single Electrical Access - Back	Source laminate Flintwood Natural Veneer Finishes 2 and 3	52 Ebony 20 Atrium White

SAMPLE ORDER CODE

NBOTT L	2	3G	20
----------------	----------	-----------	-----------

DESCRIPTION

No Magazine Holder, No Electrical Access

No Magazine Holder, Single Electrical Access-Front or Back

PRICE

Source Laminate Case	Flintwood Case	Veneer Case
1042	1274	1334
1080	1312	1371

bonds auxiliary table overview

Bonds Auxiliary Tables have a unique fin design on the base that allow them to nest between Bonds Building Blocks or be used freestanding.

Auxiliary Table (NBOA)

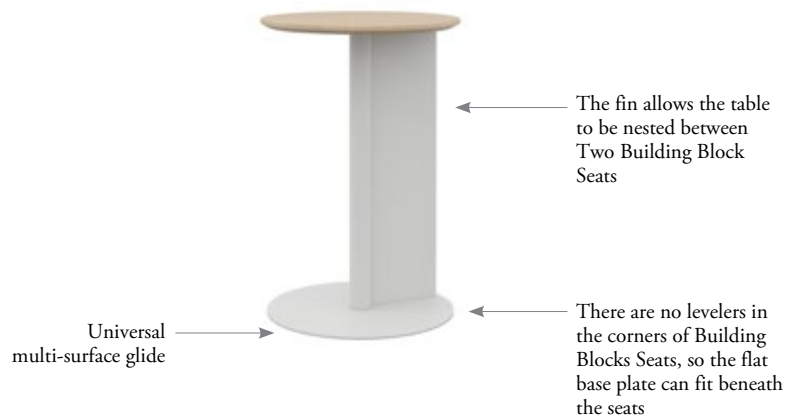

finishes

Table Top Finishes:

- Source Laminate
- Flintwood
- Veneer 2 and 3

Metal Finishes:

- Foundation
- Mica
- Accent

statement of line



Auxiliary Table, Lounge Height (NBOAL)

Auxiliary Table, Work Height (NBOAW)

bonds auxiliary table dimensions & material requirements

features

- Meets ANSI/BIFMA Requirement

weight

Auxiliary Table	106 lbs
-----------------	---------

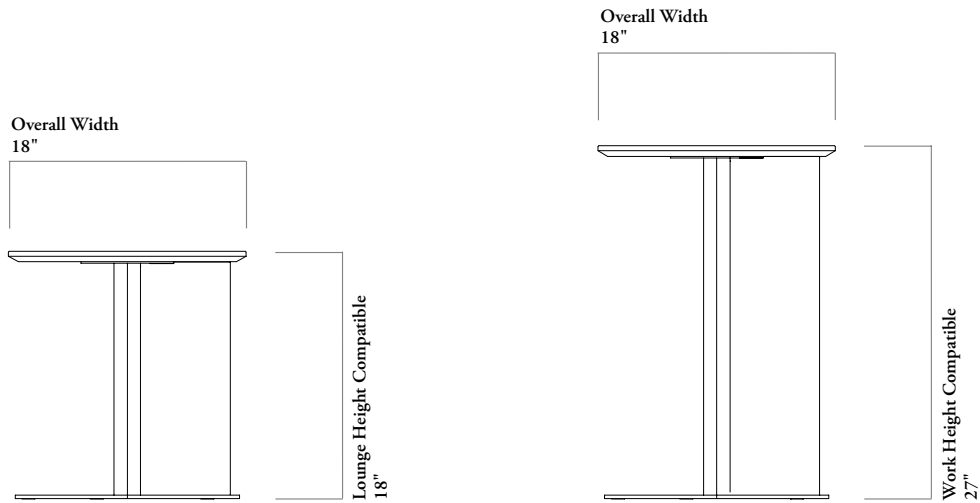

grain direction

The grain direction on the Auxiliary Table runs the same direction as the table fin.

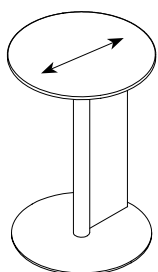

planning with bonds auxiliary table

The following should be considered when planning with Auxiliary Tables.

- ✓ Auxiliary Tables can be used as stand-alone tables.

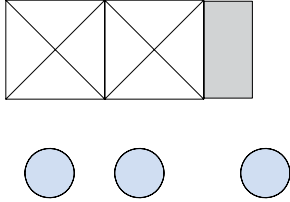

- ✓ Lounge and work height Auxiliary Tables can be nested between Building Block Seats.

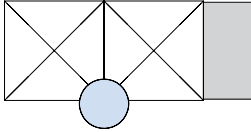

- ✗ The Auxiliary Table cannot rest in front of a Building Block table, the base cannot extend beneath.

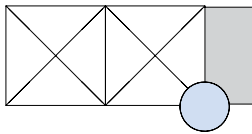

N B O A Auxiliary Table

FEATURES

- Freestanding table that is available in lounge height (18") and work height (27")
- Can nest between two Building Block Seats or be used freestanding

NOTES

Table to only available with a knife edge.

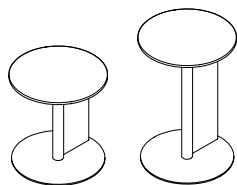

Lounge

Work

PRODUCT OPTIONS

Seat height	Wood Case Finish	Base Frame Finish
L Lounge Height Compatible	Foundation Laminate	Foundation
W Work Height	Flintwood	Mica
	Natural Veneer Finishes 2 and 3	Accent

SAMPLE ORDER CODE

NBOA L	LW	20
---------------	-----------	-----------

DESCRIPTION

PRICE

	Foundation Laminate	Flintwood	Veneer
Lounge Height Compatible	923	978	1020
Work Height	930	998	1012

collaborative ottoman overview

The Collaborative Ottoman provides casual seating for guests in a workstation or lounge environment. In a lounge, the Ottoman can be used in their own grouping or intermingled with other lounge seating, such as Teknion dna.

Collaborative Ottomans are equipped with casters intended for use on carpeted surfaces. Use of these casters on hard surfaces could result in unexpected rolling and tipping. Casters designed for use on hard surfaces are available. If in doubt, see your dealer for appropriate selection.

statement of line

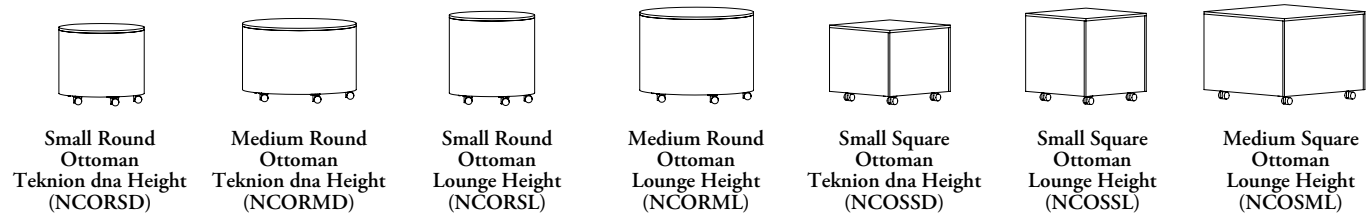

features

- Designed and tested for users up to 300 lbs

weight

Small	11 - 16 lbs
Medium	18 - 24 lbs

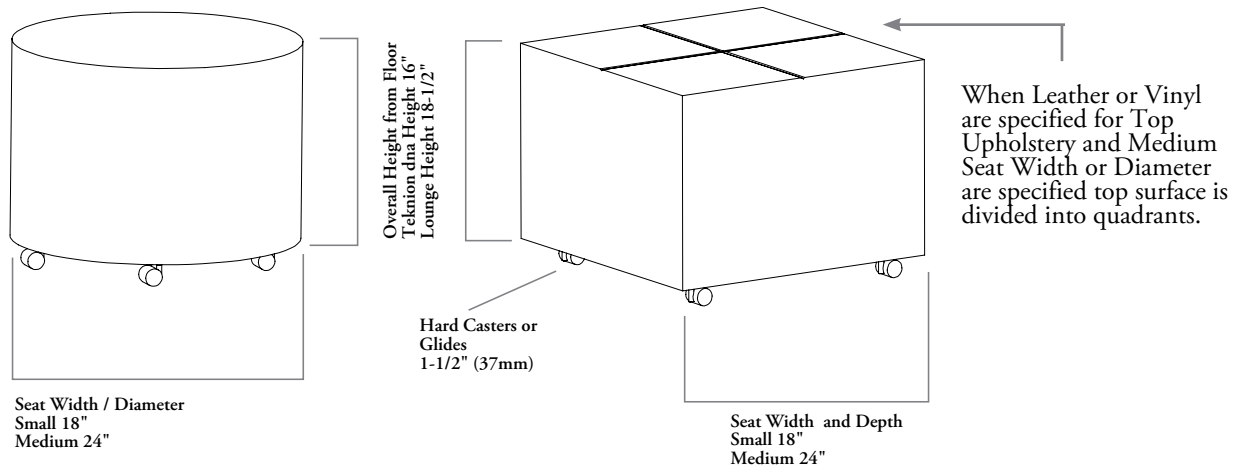

COM/COL material requirement

The pattern, repeat and directionality of fabric may increase the amount of yardage required.

Leather quantities should always be rounded up to the next hide size, as yields vary from 60-80% and are affected by the quality, size and shape of the hide, and by the location and quantity of blemishes.

	SINGLE UPHOLSTERED		DUAL UPHOLSTERED			
	COM [yards]	COL [sq. ft]	Base COM [yards]	Top COM [yards]	Base COL [sq. ft]	Top COL [sq. ft]
Round Ottoman, Small, Teknion dna Height	1	12.25	1	0.7	9.25	3.25
Round Ottoman, Medium, Teknion dna Height	1.75	16	1.0	0.75	11	5.25
Round Ottoman, Small, Lounge Height	1.25	14	1.13	0.7	11	3.25
Round Ottoman, Medium, Lounge Height	1.75	18.5	1.13	0.75	13.5	5.25
Square Ottoman, Small, Teknion dna Height	1.5	14	1	0.7	11	3.25
Square Ottoman, Small, Lounge Height	1.75	15.5	1.13	0.7	12.75	3.25
Square Ottoman, Medium, Lounge Height	2	19	1.13	0.75	14	5.25

Xpress

NCOR

Collaborative Ottoman – Round

FEATURES

- Fully upholstered, fixed height, casual seating solution to be used alone or in groups
- Optional Small (18") and Medium (24") diameter seat size
- Optional Teknion dna appropriate seat height (16") as well as a typical Lounge height (18 1/2")
- Hard casters are standard and finished in Ebony. Soft casters and glides also available

NOTES

Dual Upholstered option allows an upholstery finish on the top surface to differ from the body (sides).

When Top Upholstery style is specified in Leather or Vinyl and Medium seat diameter is specified, top surface is divided into quadrants and top stitched.

Not all configurations are available on the Xpress program.

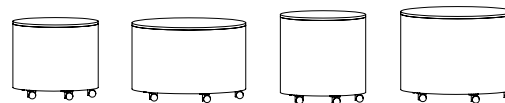

PRODUCT OPTIONS

Seat Diameter	Seat Height	Upholstery Style	Base Upholstery Style	Top Upholstery Style	Casters/Glides
S Small 18"	D Teknion dna Height 16" L Lounge Height 18.5"	S Single	Fabric	Fabric	A Casters, Soft B Glides, Hard C Glides, Soft
M Medium 24"		D Dual	Leather	Leather	

SAMPLE ORDER CODE

NCOR S	D	D	E523	E524	B
---------------	----------	----------	-------------	-------------	----------

DESCRIPTION

SINGLE UPHOLSTERED (S)

Small Round Ottoman Teknion dna Height
Small Round Ottoman Lounge Height
Medium Round Ottoman Teknion dna Height
Medium Round Ottoman Lounge Height

PRICE

Grade 1	COM/ Grade 2	COL/ Grade 3	Grade 4	Grade 5	Grade 6	Grade 7	Grade 8	Grade 9	Grade 10
784	815	846	880	912	943	974	1008	1038	1103
815	846	880	912	943	974	1008	1038	1070	1139
1008	1038	1070	1103	1139	1167	1199	1234	1267	1327
1038	1070	1103	1139	1167	1199	1234	1267	1295	1362

	Leather LA	Leather LB	Leather LC	Leather LD
Small Round Ottoman Teknion dna Height	1103	1186	1354	1409
Small Round Ottoman Lounge Height	1139	1267	1455	1522
Medium Round Ottoman Teknion dna Height	1327	1510	1731	1804
Medium Round Ottoman Lounge Height	1362	1612	1866	1952

If Dual Upholstery (D) is specified, for top style	add 160
If Soft Casters are specified	add 28
If Hard Glides are specified	add 28
If Soft Glides are specified	add 43

soft seating

Xpress

NCOS

Collaborative Ottoman – Square

FEATURES

- Fully upholstered, fixed height, casual seating solution to be used alone or in groups
- Optional Small (18") and Medium (24") seat widths and depths are available
- Optional Teknion dna appropriate seat height (16") as well as a typical Lounge height (18 1/2"). Medium (24") Square seat size is not available at dna height
- Hard casters are standard and finished in Ebony. Soft casters and glides also available

NOTES

Dual Upholstered option allows an upholstery finish on the top surface to differ from the body (sides).

Option Teknion dna Height 16" (D) is not available with Seat Width Medium 24" (M).

When Top Upholstery style is specified in Leather or Vinyl and Medium seat width is specified, top surface is divided into quadrants and top stitched.

Not all configurations are available on the Xpress program.

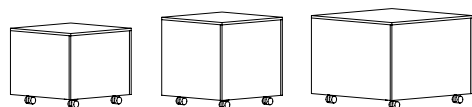

PRODUCT OPTIONS

Seat Width	Seat Height	Upholstery Style	Base Upholstery Style	Top Upholstery Style	Casters/Glides
S Small 18"	D Teknion dna Height 16" L Lounge Height 18 1/2"	S Single	Fabric	Fabric	A Casters, Soft B Glides, Hard C Glides, Soft
M Medium 24"		D Dual	Leather	Leather	

SAMPLE ORDER CODE

NCOS M	L	D	E523	E524	C
---------------	----------	----------	-------------	-------------	----------

DESCRIPTION

SINGLE UPHOLSTERED (S)

Small Square Ottoman Teknion dna Height
Small Square Ottoman Lounge Height
Medium Square Ottoman Lounge Height

PRICE

	COM/ Grade 1	COM/ Grade 2	COL/ Grade 3	Grade 4	Grade 5	Grade 6	Grade 7	Grade 8	Grade 9	Grade 10
Small Square Ottoman Teknion dna Height	846	880	912	943	974	1008	1038	1070	1103	1167
Small Square Ottoman Lounge Height	880	912	943	974	1008	1038	1070	1103	1139	1199
Medium Square Ottoman Lounge Height	1103	1139	1167	1199	1234	1267	1295	1327	1362	1422
	Leather LA	Leather LB	Leather LC	Leather LD						
Small Square Ottoman Teknion dna Height	1167	1295	1491	1553						
Small Square Ottoman Lounge Height	1199	1371	1583	1653						
Medium Square Ottoman Lounge Height	1422	1691	1951	2037						

If Dual Upholstery (D) is specified, for top style add 160

If Soft Casters are specified add 28

If Hard Glides are specified add 28

If Soft Glides are specified add 43

Seat Height (D) is not available with Seat Width (M).

teknion dna overview

dna is a line of modular lounge seating and tables designed to go beyond the traditional requirements of lounge seating. dna meets today's workplace needs of collaborative work settings for increased flexibility, reconfigurability and access to power and communications. The following typicals demonstrate the planning capabilities of dna.

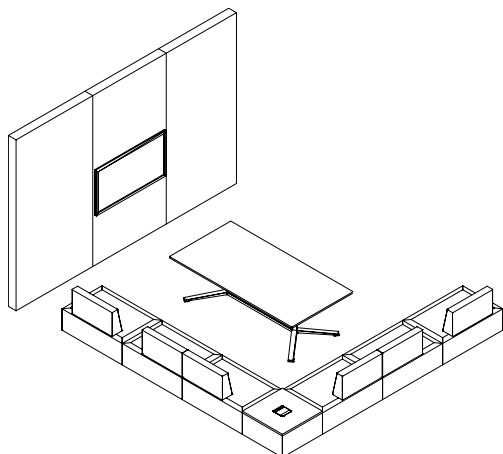
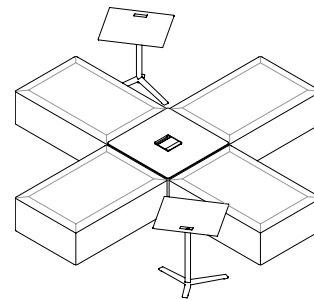
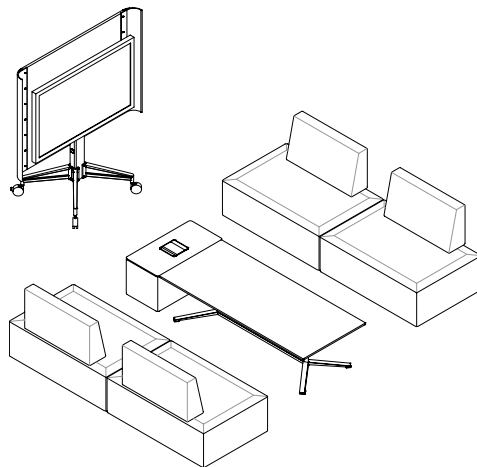
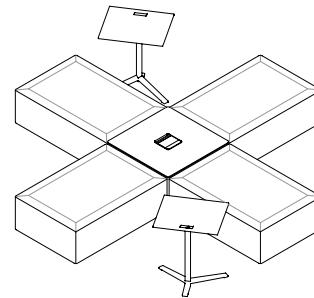
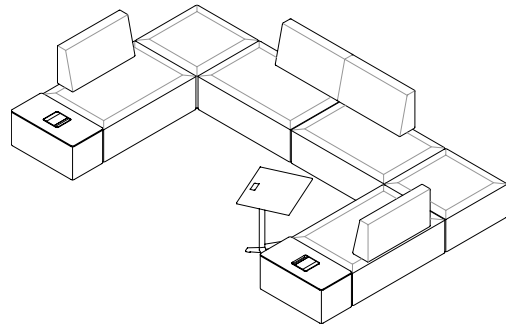
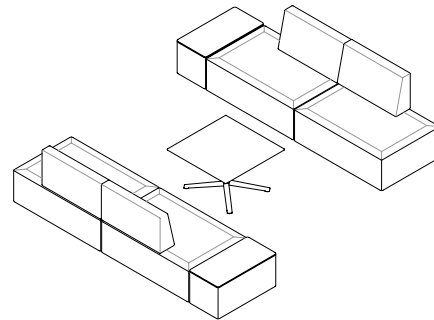
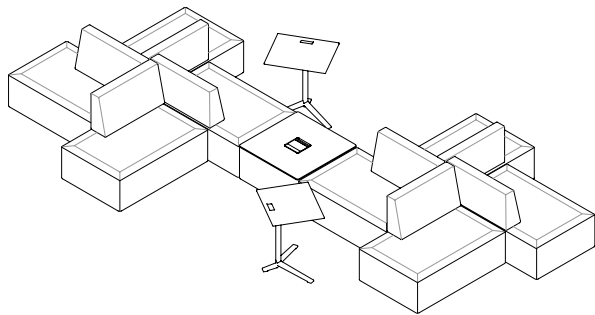

idea starters

The following layouts are available on the Teknion Planning Tool.

teknion dna planning possibilities

All dna units are based on-module of 13" to allow for unlimited planning possibilities.

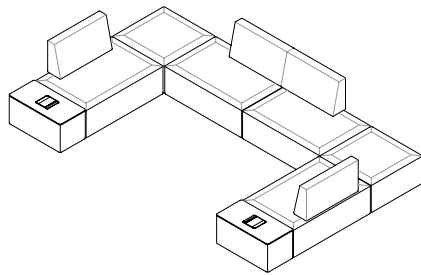
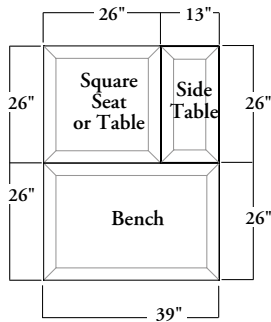

This configuration consists of:

- Two Benches with Bolsters and Side Tables
- Two Benches with Bolsters
- Two Square Seats/Ottomans

The same components can be used to create the following configurations:

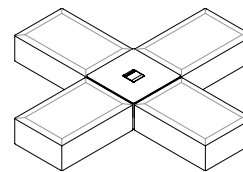
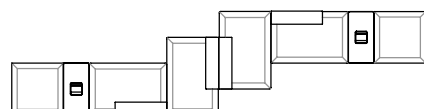
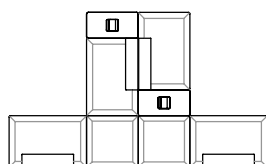
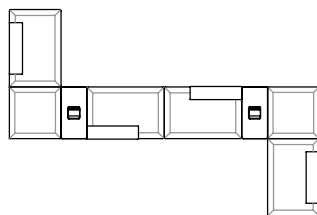
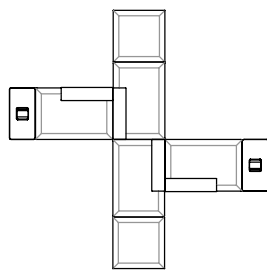
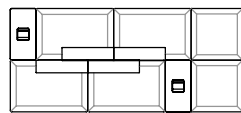
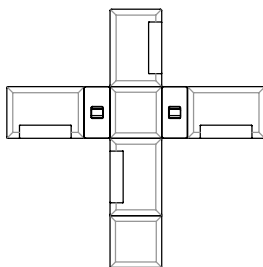

This configuration consists of:

- Four Benches
- One Square Table

The same components can be used to create the following configurations:

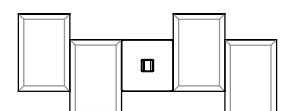
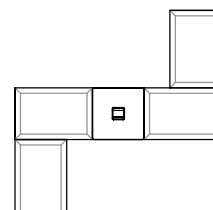
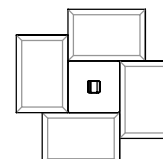
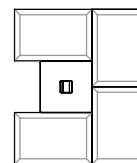
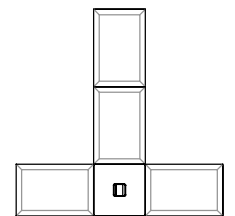

teknion dna seating basics

DNA Seating Components include Benches, Benches with Bolsters and Square Tables.

Bench with Bolster (NDNB) and Bench with Bolster and Side Table (NDNBT)

- The Bench back includes a track for mounting a bolster, which can be mounted in three positions, left, right and center
- Bolster can be ordered in a center locked position however lock position can be changed in the field
- Optional side table can be specified on the left or right side of the Bench with Bolster and provides one continuous base for wiring
- Side table can be specified with a solid top or with a data/electrical Module

Square Seat/Ottoman (NDNC) and Square Seat/Ottoman with Side Table (NDNCT)

- Optional side table can be specified on the left or right side of the Bench with Bolster and provides one continuous base
- Side table can be specified with a solid top, or with a data/electrical module

Floor Mounting Bracket (NDNF)

- Allows units to be securely linked to flooring
- Hardware is dependent on the types of floor and therefore not included
- To ensure proper spacing at least one Linking Bracket Kit (NDNJ) is required when securing to the floor
- Top of units can be separated from the base for wire access or for securing to the floor, if required

Linking Bracket (NDNJ)

- Allows units to be securely linked together
- When electrical is routed through the units, it is required that they be either linked or secured to the floor

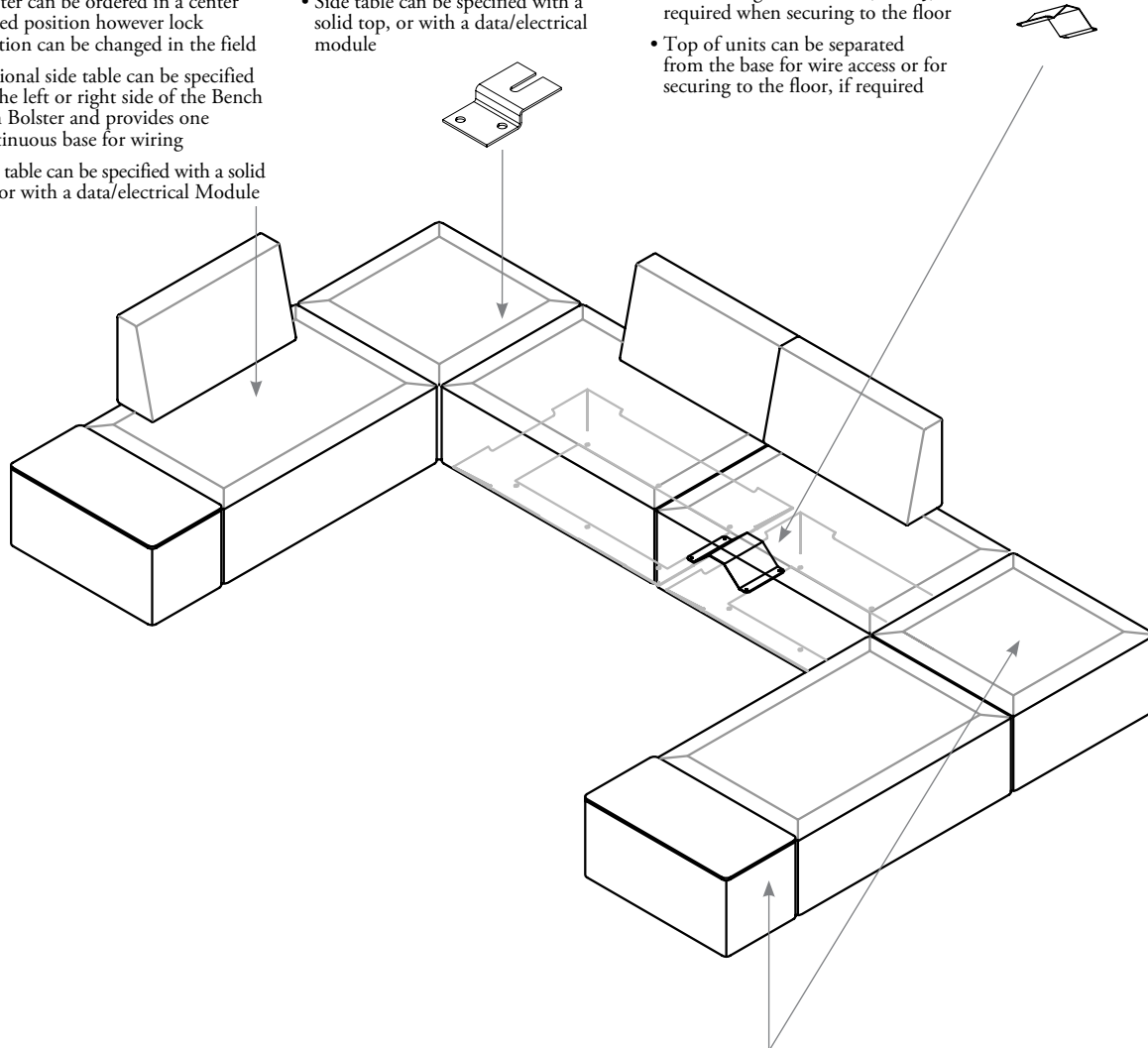

Bench (NDNA) and Bench with Side Table (NDNAT)

- Optional side table can be specified on the left or right side of the Bench and provides one continuous base for wiring
- Side table can be specified with a solid top, or with a data/electrical module

teknion dna table basics

DNA Table Components include casual laptop and lounge tables and add-on or square tables that accommodate electrical data.

Add-On Side Table (NDNM)

- Available as a separate unit to add to an existing layout, or when reconfiguration requires additional tables
- Must be attached to a Bench with Bolster, Bench, or Square Seat/Ottoman, but certain linking restrictions may apply (see Application pages)
- Can be specified with a solid top, or with a data/electrical module

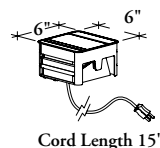

Data/Electrical Module

- Can be specified as an option on the Square Table and Side Table
- Mounts directly to the table surface and provides standard capacity power, and includes one duplex outlet inside of a flip-up door

Square Table (NDNS)

- Provides a table top surface with the same footprint as the Square Seat/Ottoman
- Can be specified with a solid top, or with a data/electrical module

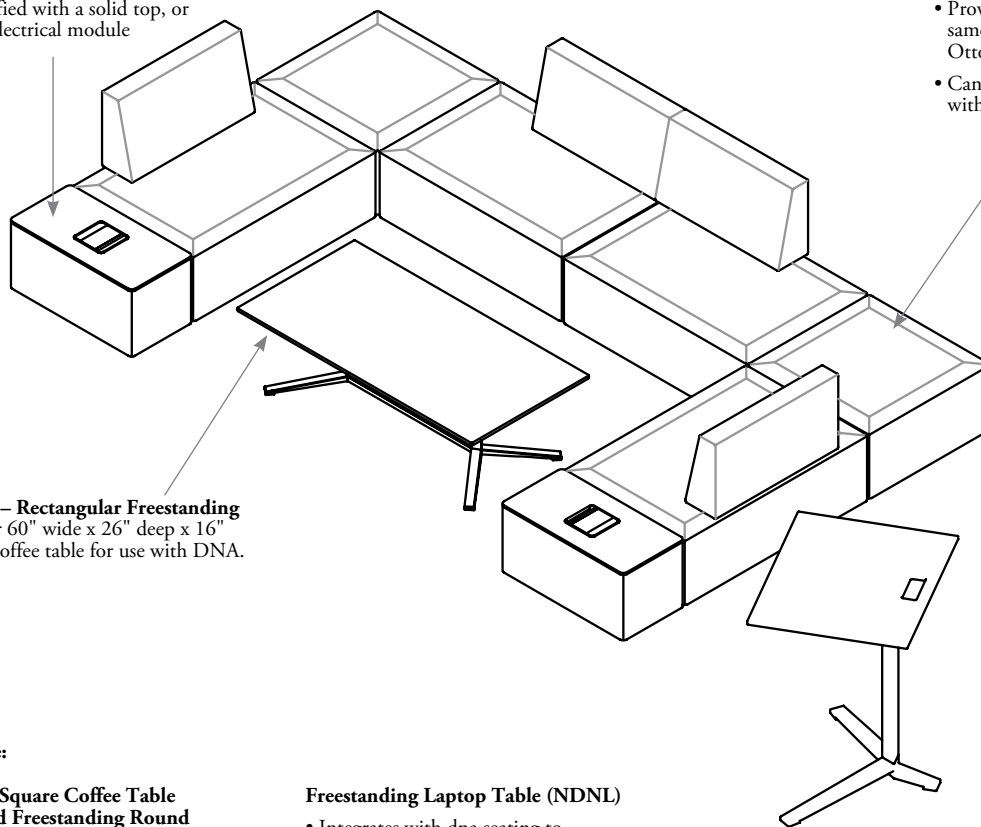

DNA – Rectangular Freestanding 52" or 60" wide x 26" deep x 16" high coffee table for use with DNA.

Also Available:

Freestanding Square Coffee Table (NDNTS) and Freestanding Round Coffee Table (NDNTR)

Provides table surfaces at coffee table height.

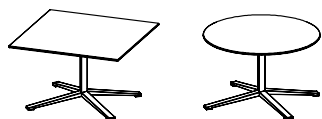

Freestanding Laptop Table (NDNL)

- Integrates with dna seating to provide a casual workspace for use with laptops
- Worksurface is large enough for a laptop and a mouse
- Is lightweight and foldable with a handle for mobility
- Tables can be nested

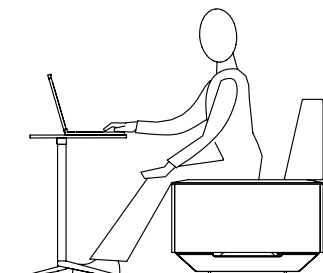

Laptop Tables integrate with dna seating to provide a casual workspace

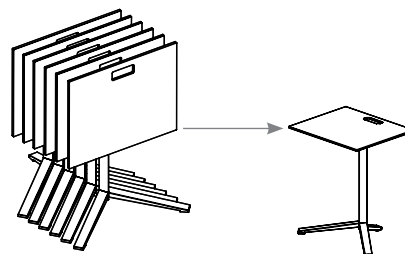

The table tops flip up, allowing the tables to be nested.

planning with dna benches & tables

DNA Table Components include casual laptop and lounge tables and add-on or square tables that accommodate electrical data.

bolsters

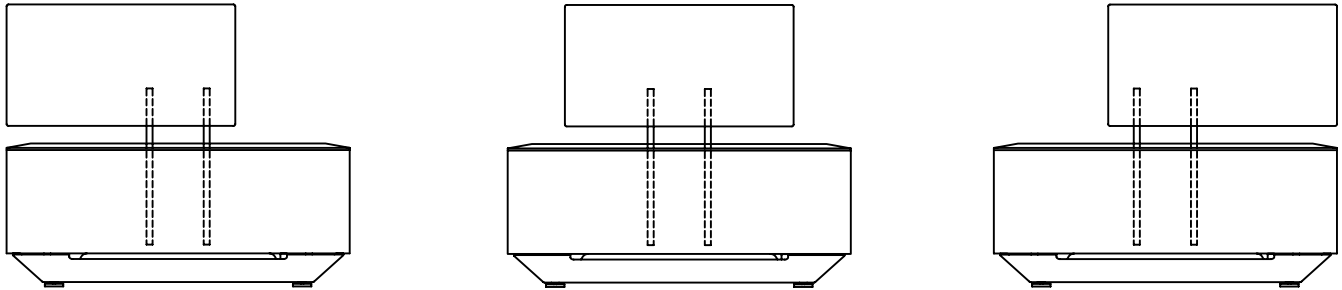

add-on tables

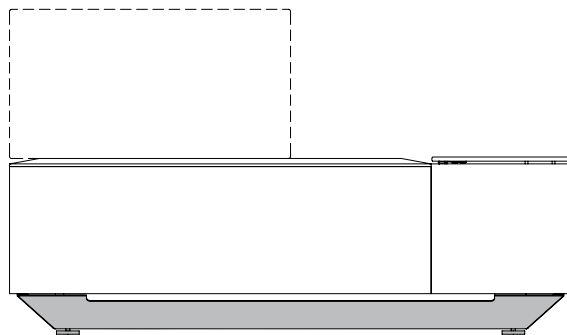

Specified with Bolster

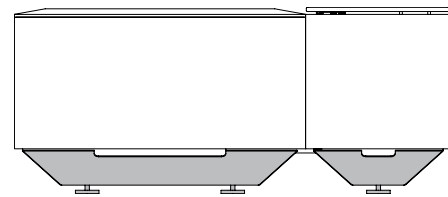

Specified Separately

Add-on tables can be specified as part of the bench, or be ordered separately as required. When the table is ordered with the bench it has one continuous base, when it is ordered separately, the bench and table will have two separate bases.

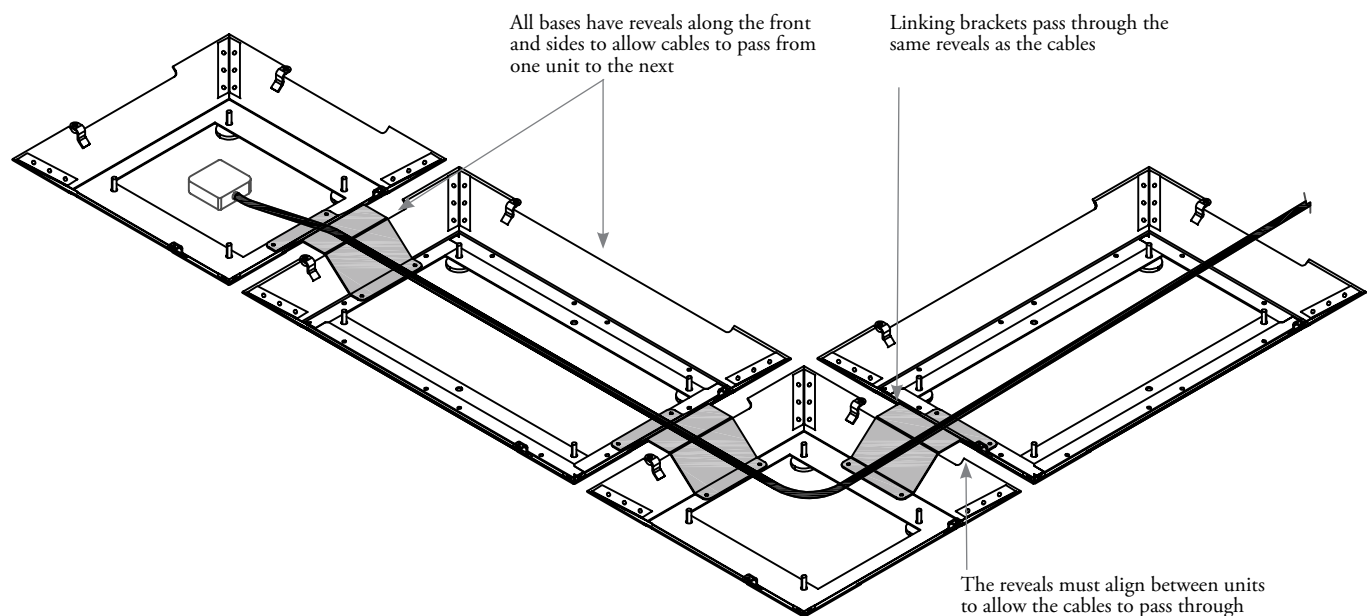

When planning with electrical, dna units must be linked together. Reveals along the fronts and sides alone. Cables to pass from one another to the next and accommodate linking brackets.

planning with dna benches & tables (continued)

- ✓ Reveals are placed in specific locations which affect the configurations that can be achieved. The reveals must overlap in order to be connected.

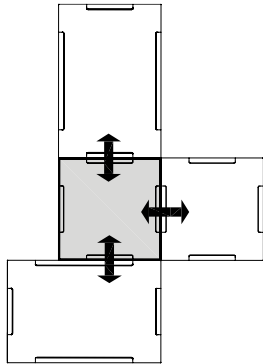

- ✓ Square Seat/Ottoman or Table Connected to of Other Elements.

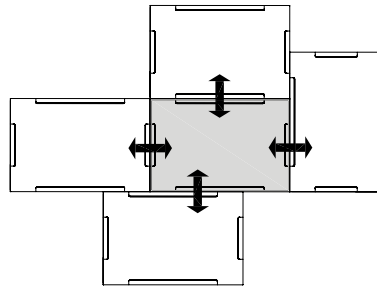

- ✓ Bench to Bench Connections.

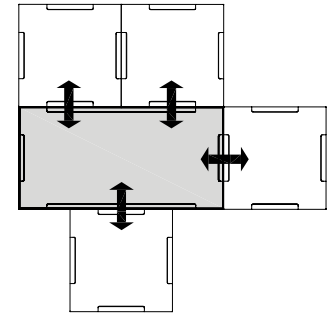

- ✓ Bench with Side Table Connected (one connected base) with Square Seat/Ottoman or Table.

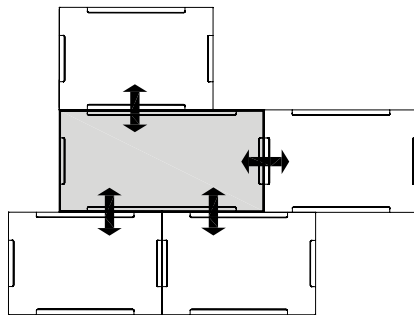

- ✓ Bench with Side Table Connected (one connected base) to Other Benches.

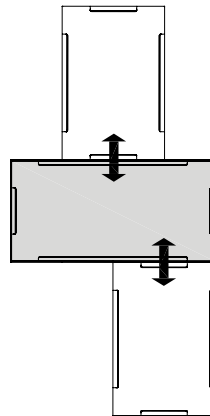

- ✓ Bench with Side Table Connected (one connected base) to Other Benches.

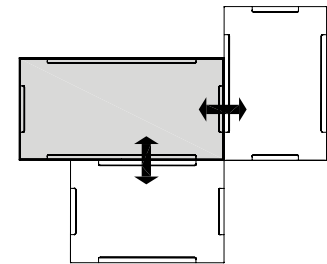

- ✓ Bench with Side Table Connected (one connected base) to Other Benches.

planning with dna benches & tables (continued)

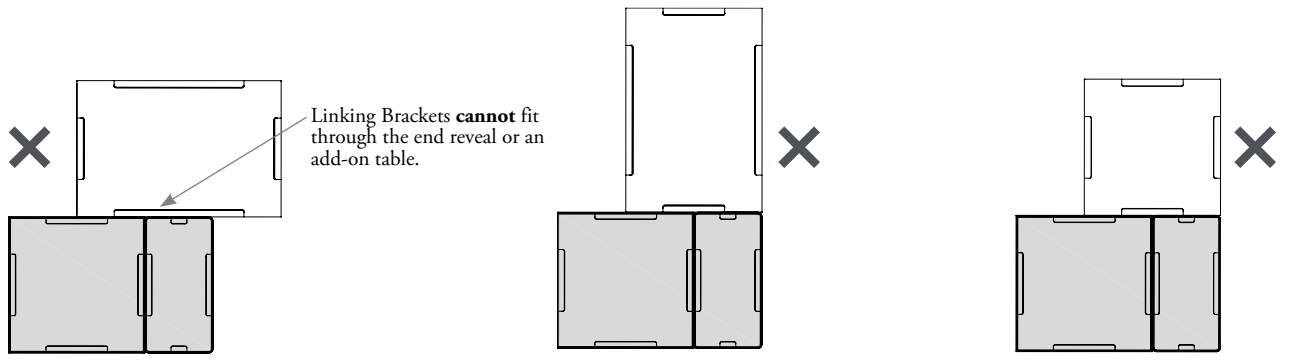

Square Seat/Ottoman with Add-On Side Table connecting to either Square Table/Ottoman or Benches.

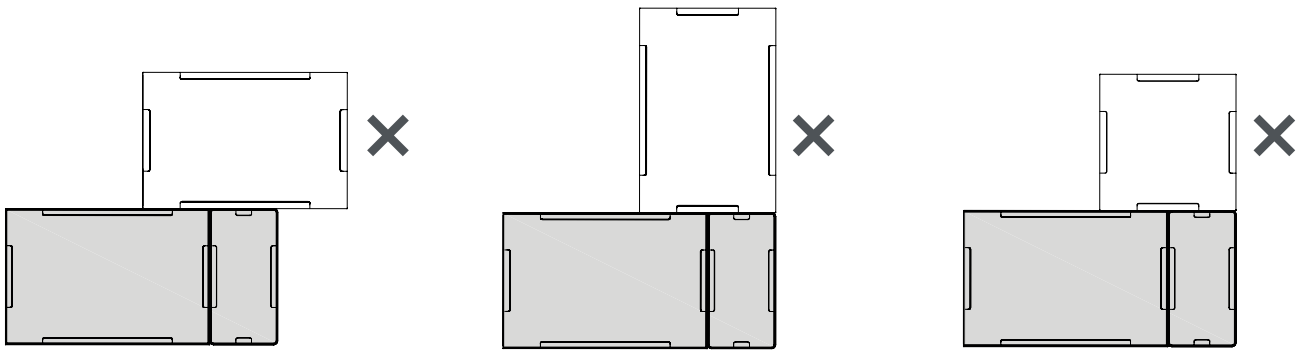

Bench with Add-On Side Table Connected to another Bench or Square Seat/Ottoman.

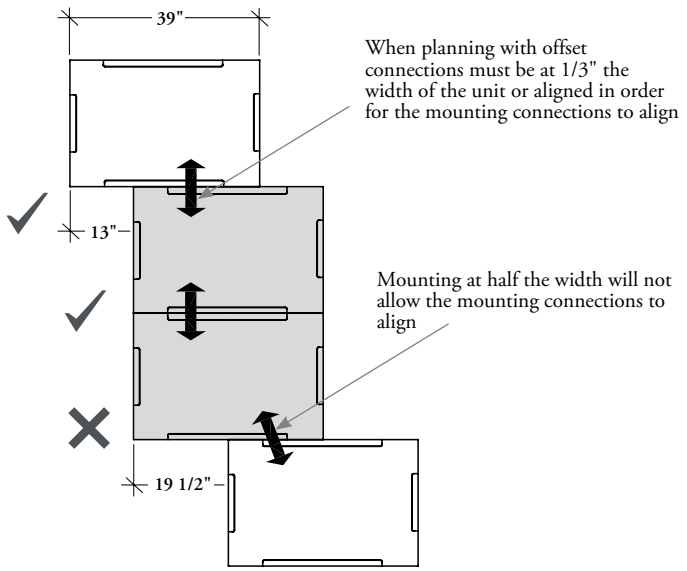

understanding teknion dna power & communications

The following demonstrates how power and communications are routed through dna.

All power connections in dna are casual plug-in connections and can span a maximum of 15'. There is no hard-wire capability.

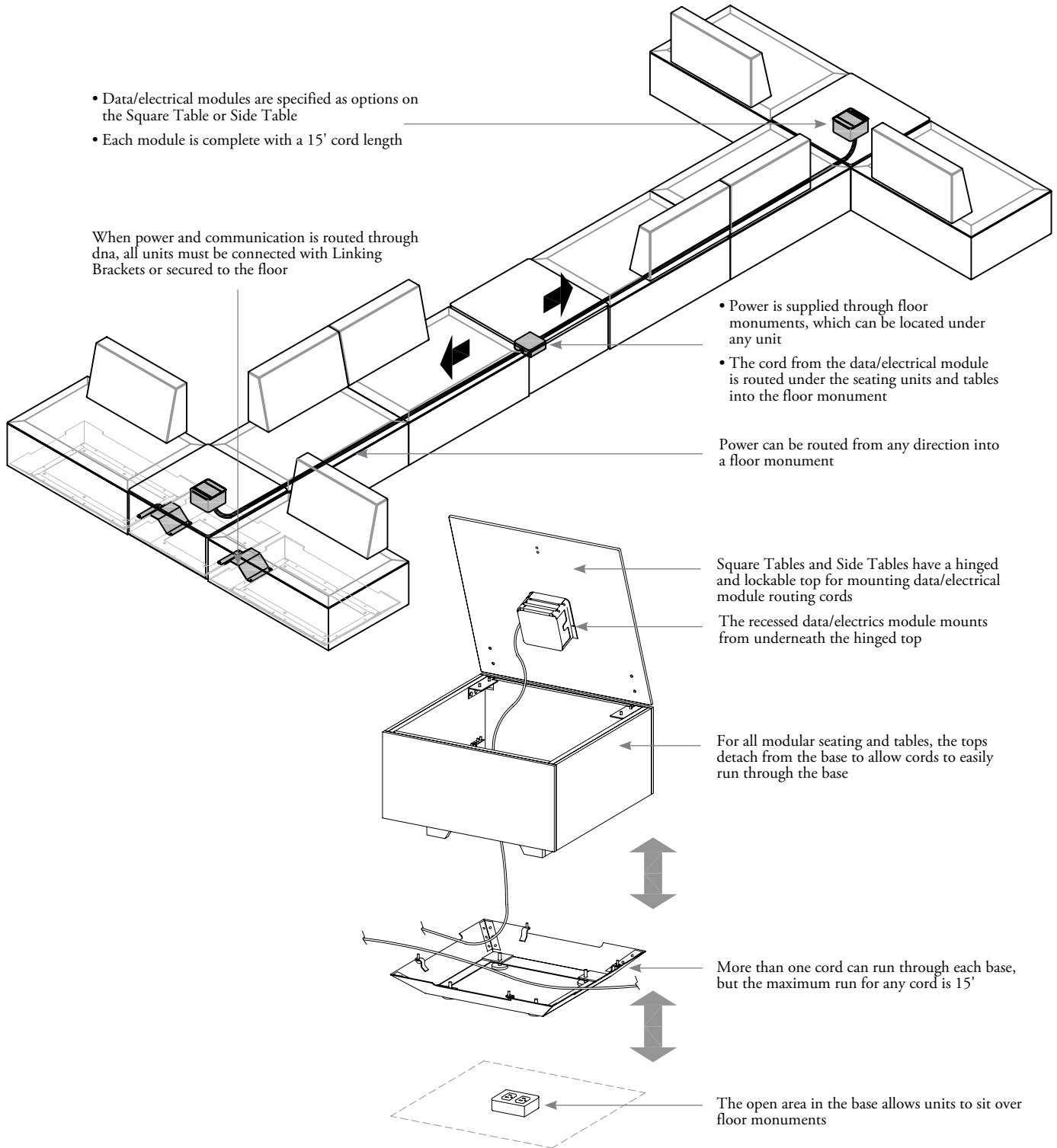

teknion dna recessed data/electrical module details

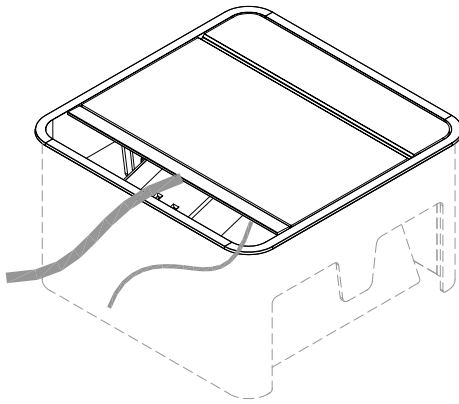

- Standard offering has three power outlets and a covered communication opening that can accommodate a variety of data connectors (not included)
- The communication opening is 1.38" x 2.72" for single gang mounting plates which will accommodate kits from AMP, Panduit, Hubbell, Leviton, Northern Telecom, AT&T, Lucent and others
- Module is 6.125" wide x 6.125" deep x 3.5" high

Pivoting Retractable door is finished in clear Anodized Aluminum

One top-accessed Duplex Power Outlet is finished in Grey.
One additional simplex power outlet can be accessed from the bottom.

Depth Adjustable Screw

Depth Adjustable Bracket is finished in Platinum

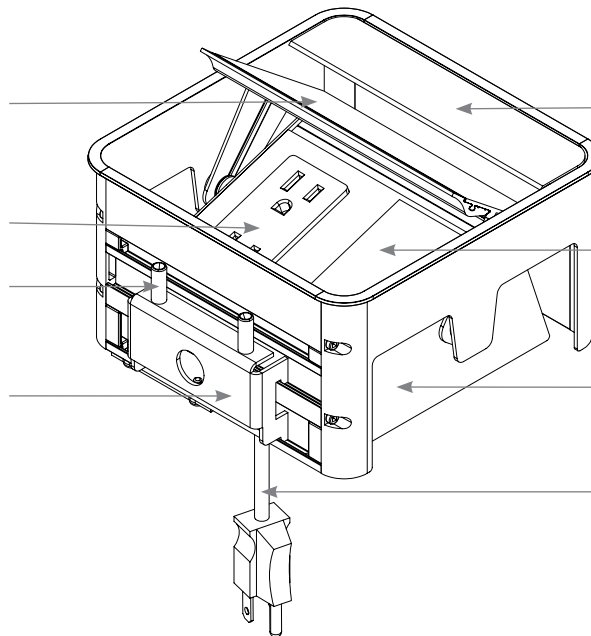

Top Plate and Data/Electrical Box are finished in clear Anodized Aluminum

Blank cover for Communication Opening is finished in Platinum Grey

Frame is finished in powder coat Platinum

Power Cord is 15' long and Black color with 3-prong straight plug

teknion dna finishes

The following outlines the finishes available on all dna units.

Bench with Bolster (NDNB), Bench (NDNA), Square Seat (NDNC)

Seat and Bolster:

- Available in Teknion standard fabrics, graded-in fabrics, COM, leather and COL
- Seat and the bolster can be specified in two different fabrics

Base Frame:

Painted finish

Square Table (NDNS), Side Table (NDNM)

Top:

Available in 3/8" Compact Laminate (with black straight edge), 1/2" Flintwood or Natural Veneer on Baltic Birch substrate (with exposed Baltic Birch straight edge)

Sides:

Available in Teknion standard fabrics, graded-in fabrics, COM, leather and COL

Base Frame:

Painted finish

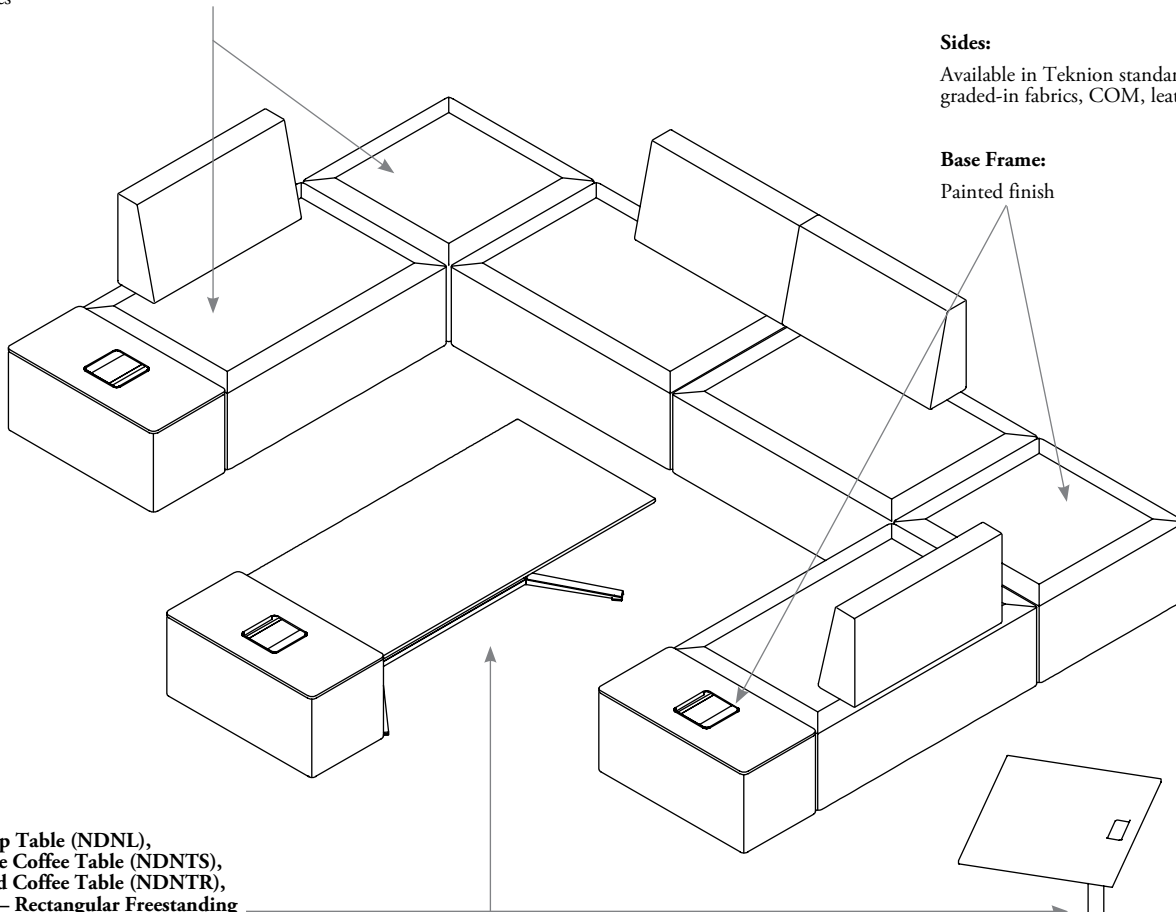

Laptop Table (NDNL), Square Coffee Table (NDNTS), Round Coffee Table (NDNTR), DNA – Rectangular Freestanding Coffee Table (NDNU)

Top:

Available in 3/8" Compact Laminate (with black straight edge), 1/2" Flintwood or Natural Veneer on Baltic Birch substrate (with exposed Baltic Birch straight edge)

Base:

- Aluminum, with polished or painted finish
- When the polished aluminum post is specified, the base will also have a polished finish

Post:

Aluminum, with polished or painted finish

Due to the unique shape and size of dna and the inherent properties of some fabrics, mild creasing or puckering may result and is not considered a quality issue by Teknion. In most cases, the fabric can be smoothed-over by hand to improve the appearance. Seams will be applied to the top surface of seating units when leather is specified.

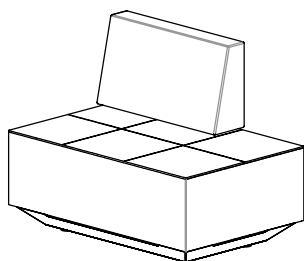

Leather Bench with Bolster

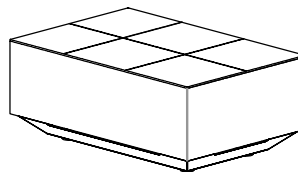

Leather Bench

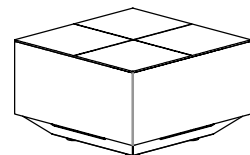

Leather Square Seat/Ottoman

teknion dna dimensions & material requirements

statement of line

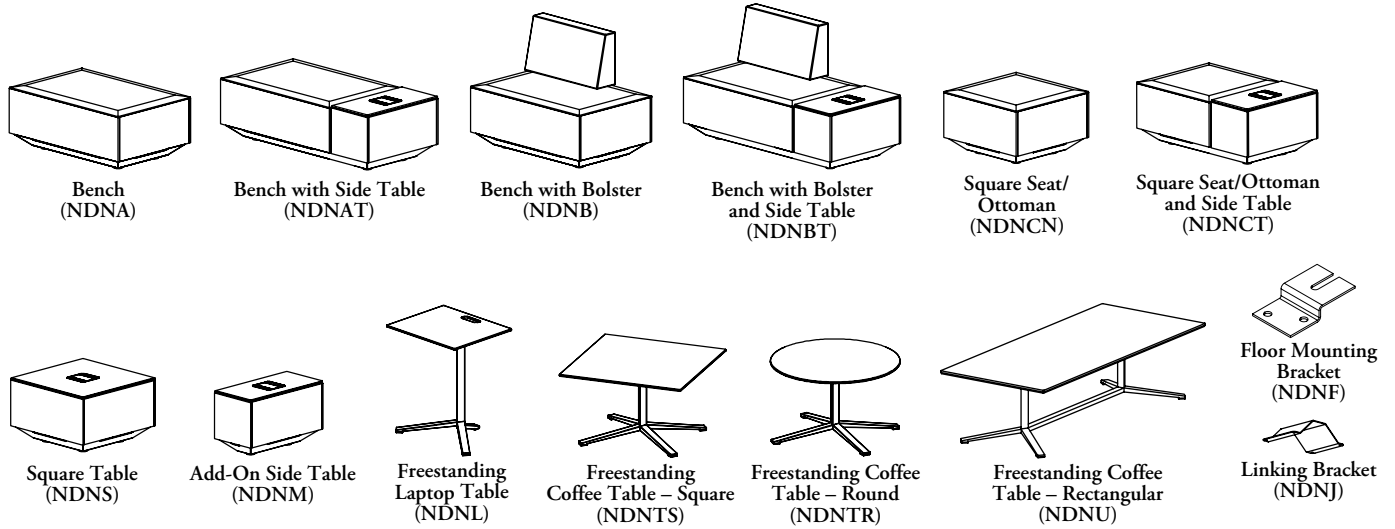

features

- For bench with side table option, add side table dimensions from next page to those shown here

weight

Bench	56 lbs
Bench with Bolster	82 lbs
Bench with Side Table	94 lbs
Bench with Bolster and Side Table	120 lbs

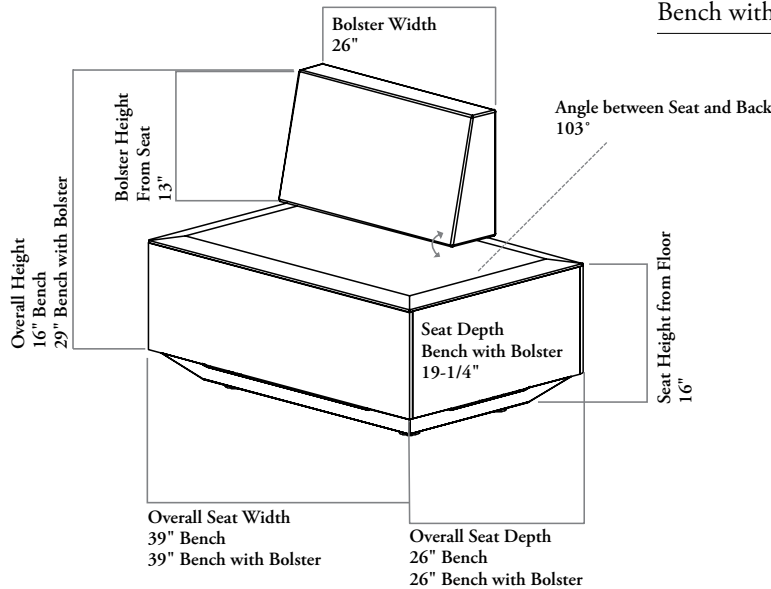

COM/COL material requirement

The pattern, repeat and directionality of fabric may increase the amount of yardage required.

Leather quantities should always be rounded up to the next hide size, as yields vary from 60-80% and are affected by the quality, size and shape of the hide, and by the location and quantity of blemishes.

	COM [yards]	COL [sq. ft]
Bench	2.5	30
Bolster	1.25	12.5
Bench with Bolster	3.75	40.75
Side Table Option	1	8

teknion dna dimensions & material requirements (continued)

features

- Designed and tested for users up to 300 lbs
- For Square Seat/Ottoman with side table option dimensions, add the add-on side table dimensions

weight

Square Seat/Ottoman	38 lbs
Square Seat/Ottoman and Side Table	76 lbs
Square Table	52 lbs
Add-On Side Table	38 lbs

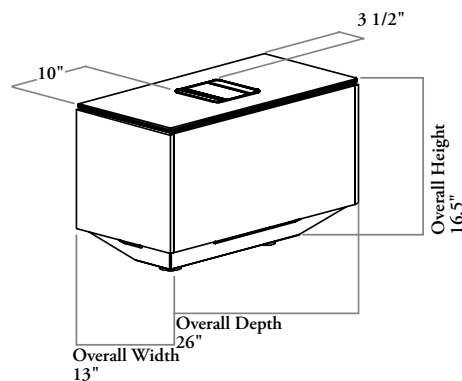
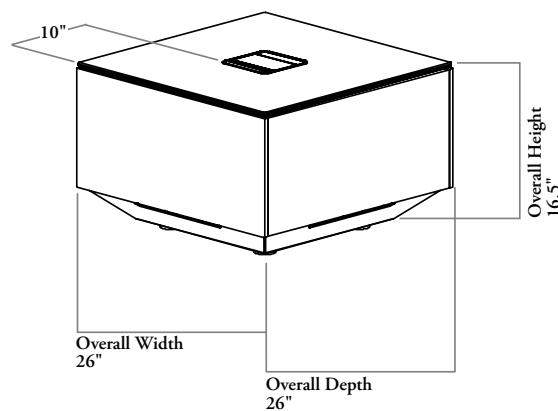
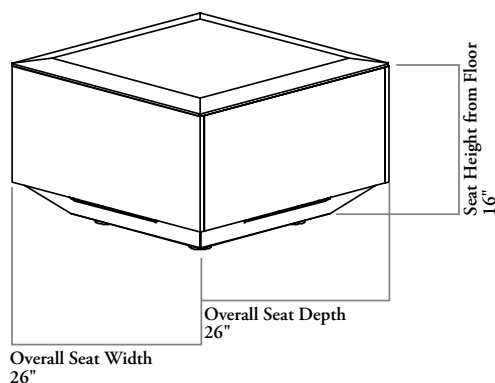

COM/COL material requirement

The pattern, repeat and directionality of fabric may increase the amount of yardage required.

Leather quantities should always be rounded up to the next hide size, as yields vary from 60-80% and are affected by the quality, size and shape of the hide, and by the location and quantity of blemishes.

	COM [yards]	COL [sq. ft]
Square Seat/Ottoman	2.5	21.75
Square Table	1.75	14.75
Add-On and Side Table Option	1	8

teknion dna dimensions & material requirements (continued)

weight

Laptop Table	13 lbs
Round Table	22 lbs
Square Table	22 lbs
Rectangular Table	54 lbs

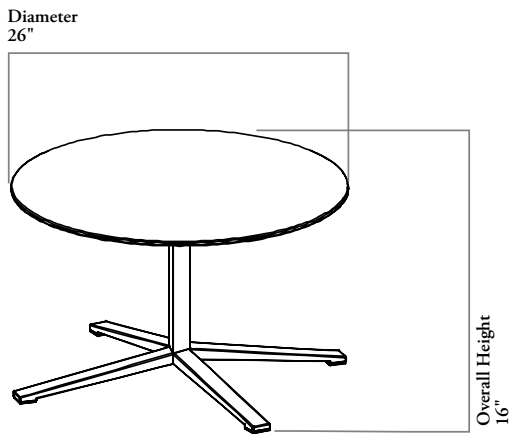
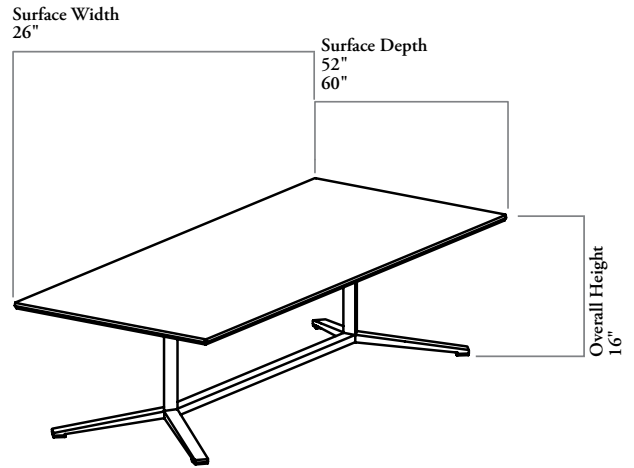
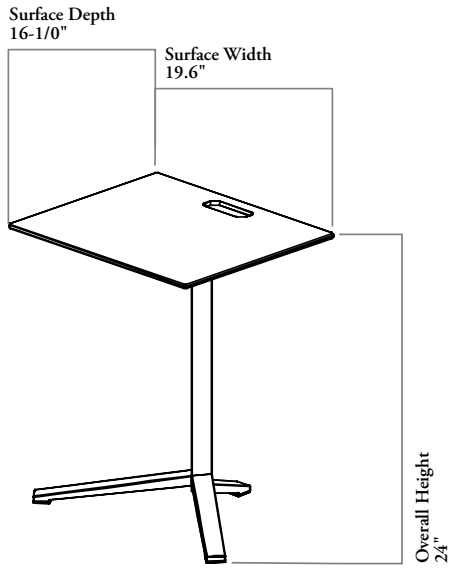

teknion dna component overview

The following outlines the complements and features of the DNA Coffee Table.

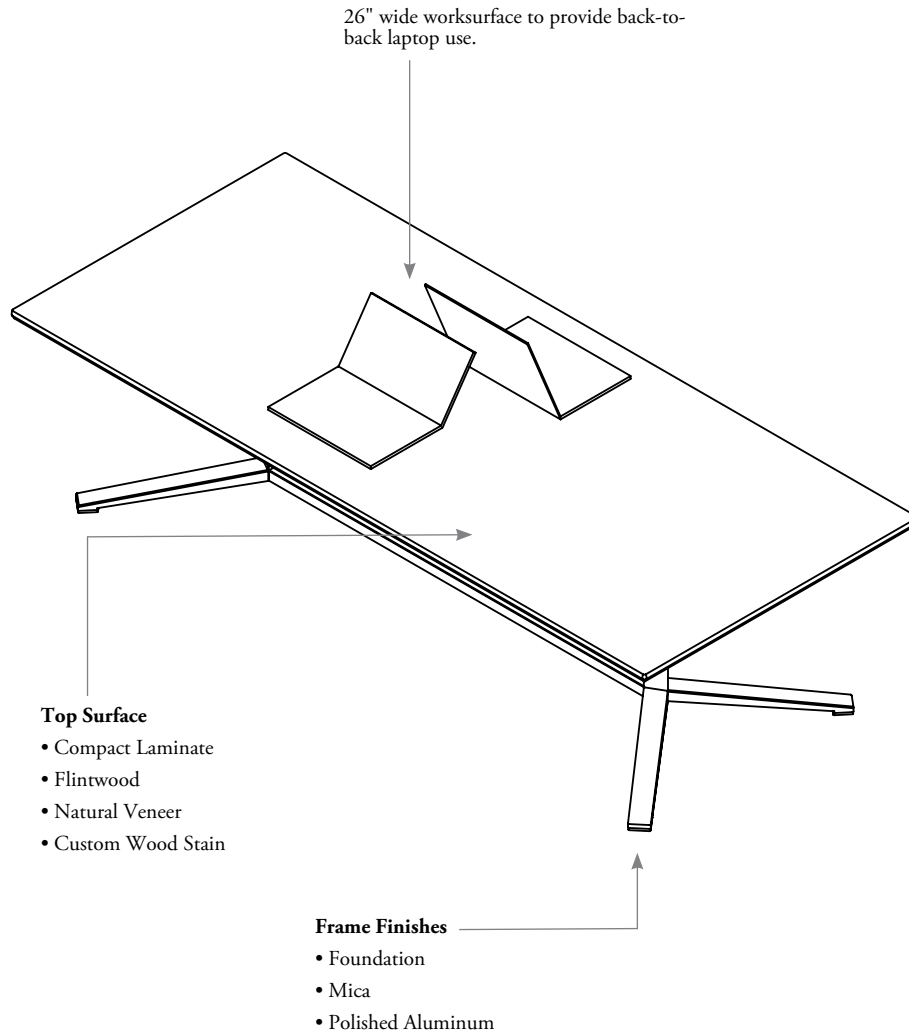

teknion dna coffee table basics

The following outlines the basic of the DNA Coffee Table.

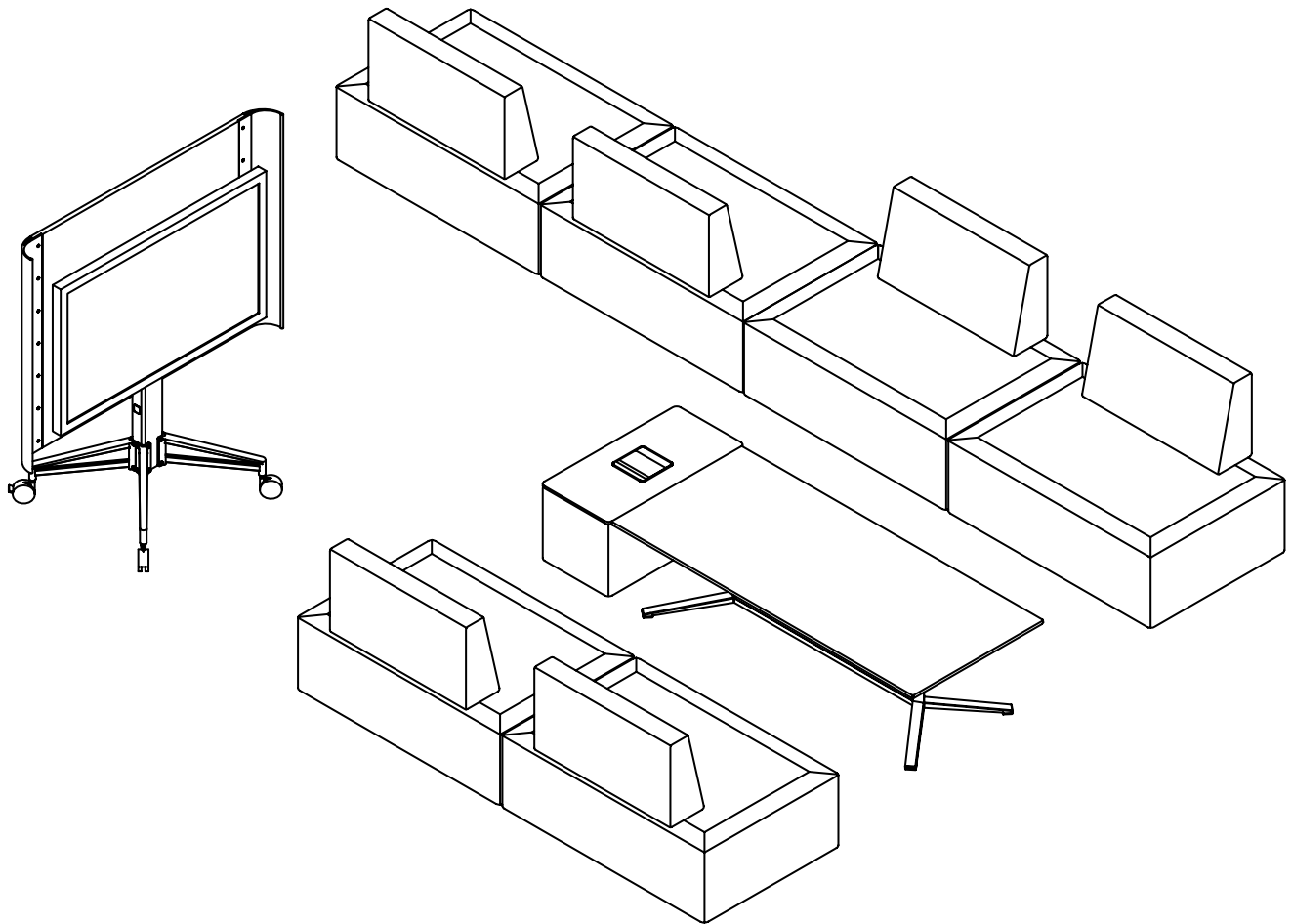

DNA – Rectangular Freestanding Coffee Table (NDNU)

- Sizes available:
52" long x 26" wide x 16" high
60" long x 26" wide x 16" high
- Surface finishes include Compact Laminate, Flintwood and Natural Veneer and Custom Wood Stain
- Post finishes include Platinum, Storm White, Ebony and Polished Aluminum
- Provides large lounge height worksurface in collaborative applications
- 26" wide to provide space for back-to-back laptop use

NDN

dna – Modular Seating Bench

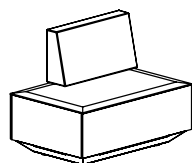

FEATURES

- Base provides access for routing wires from unit to unit
- Optional Bolster can be positioned in three locations or locked in place with the bolster lock option
- Modular design allows other dna components to connect from all sides
- Optional side table provides a worksurface and access to power and data
- Optional data/electrical module
- Multi-surface glides

NOTES

Side Table is specified left or right from the seated position but can be reconfigured on site.

Side Table pricing includes a Compact Laminate surface. If a Flintwood or Natural Veneer is specified, an additional upcharge applies.

If Compact Laminate surface finish is specified, the edge will be Black. If a Flintwood or Natural Veneer surface is specified, the edge will be Baltic Birch.

Optional Data/Electrical Module is Anodized Aluminum.

If Bolster with Lock is specified, the lock will be in the center position but can be reconfigured on site.

Single Upholstered: The same upholstery is applied to the bench and bolster.

Dual Upholstered: Two different upholstery options are applied to the chair, one to the bench and the other to the bolster. The first fabric listed will apply to the bench and is the grade used to price the chair. A dual upholstery upcharge applies.

PRODUCT OPTIONS

Style	Configuration	Side Table Orientation (If Applicable)	Upholstery Style (If Applicable)	Bolster Lock (If Applicable)	Bench Upholstery Finish	Side Table Base Finish (If Applicable)	Side Table Surface Finish (If Applicable)	Data / Electrical	Frame Finish
A Bench	N No Side Table (Shown)	L Left	S Single Upholstered	N No Lock	Fabric	Fabric	Compact Laminate	N No Data / Electrical Module	60 Platinum
	T With Side Table				Bolster Upholstery Finish		Natural Veneer	D Data / Electrical Module with Power Cord	52 Ebony
					Fabric		Custom Wood Stain		
					Leather				

SAMPLE ORDER CODE

NDN B	T	L	D	N	E515	E523	E523	N8	N	60
--------------	----------	----------	----------	----------	-------------	-------------	-------------	-----------	----------	-----------

DESCRIPTION

PRICE

	Grade 1	COM/ Grade 2	COL/ Grade 3	Grade 4	Grade 5	Grade 6	Grade 7	Grade 8	Grade 9	Grade 10
Bench	2301	2398	2529	2660	2804	2958	3111	3265	3421	3819
Bench with Bolster	3220	3364	3552	3744	3950	4175	4395	4621	4844	5426
	Leather LA	Leather LB	Leather LC	Leather LD						
Bench	3218	3354	3767	3905						
Bench with Bolster	4485	4671	5233	5418						

If Side Table (T) is specified in

Grade 1	add 1565
Grade 2/COM	add 1600
Grade 3/COL	add 1637
Grade 4	add 1670
Grade 5	add 1705
Grade 6	add 1740
Grade 7	add 1776
Grade 8	add 1807
Grade 9	add 1847
Grade 10	add 1967
Leather LA	add 1819
Leather LB	add 1854
Leather LC	add 1966
Leather LD	add 2002

If Dual Upholstery (D) is specified

add 256	
If Lock (W) is specified	add 28
If Flintwood or Natural Veneer is specified	add 209
If Data/Electrical Module (D) is specified	add 702

To order a Custom Wood Color (dna tables) please use the code NOCWS. A one time 1141 list charge per color applies.

NDNC

**dna – Modular Seating
Square Seat/Ottoman**

FEATURES

- Modular design allows other dna components to connect from all sides
- Base provides access for routing wires from unit to unit
- Optional side table provides a worksurface and access to power and data
- Optional data/electrical module
- Multi-surface glides

NOTES

Side Table is specified left or right but can be reconfigured on site.
 Side Table pricing includes a Compact Laminate surface. If a Flintwood or Natural Veneer is specified, an additional upcharge applies.
 If Compact Laminate surface finish is specified, the edge will be Black. If a Flintwood or Natural Veneer surface is specified, the edge will be Baltic Birch.
 Optional Data/Electrical Module is Anodized Aluminum.
 Mild creasing or puckering of leather or vinyl is not considered a quality issue by Teknion. See Teknion dna finishes for details on leather applications.

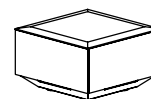

PRODUCT OPTIONS

Configuration	Seat Upholstery Finish	Side Table Base Finish (If Applicable)	Side Table Surface Finish (If Applicable)	Data/Electrical	Frame Finish
N No Side Table (Shown)	Fabric	Fabric	Compact Laminate	N No Data/Electrical Module	60 Platinum
T With Side Table	Leather	Leather	Flintwood Natural Veneer Custom Wood Stains	D Data/Electrical Module with Power Cord	74 Storm White 52 Ebony

SAMPLE ORDER CODE

NDNC N	E523				52
---------------	-------------	--	--	--	-----------

DESCRIPTION

PRICE

	Grade 1	COM/ Grade 2	COL/ Grade 3	Grade 4	Grade 5	Grade 6	Grade 7	Grade 8	Grade 9	Grade 10
Square Seat	1933	2030	2160	2292	2437	2588	2742	2895	3053	3453
	Leather LA	Leather LB	Leather LC	Leather LD						
Square Seat	2507	2571	2779	2849						

If Side Table (T) is specified in	Grade 1	add 1565
	Grade 2/COM	add 1600
	Grade 3/COL	add 1637
	Grade 4	add 1670
	Grade 5	add 1705
	Grade 6	add 1740
	Grade 7	add 1776
	Grade 8	add 1807
	Grade 9	add 1847
	Grade 10	add 1967
	Leather LA	add 1819
	Leather LB	add 1854
	Leather LC	add 1966
Leather LD	add 2002	
If Flintwood or Natural Veneer is specified	add 209	
If Data/Electrical Module (D) is specified	add 702	

To order a Custom Color (dna tables) please use the code NOCWS. A one time 1141 list charge per color applies.

NDNS

dna – Modular Square Table

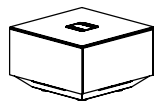

FEATURES

- Modular design allows other dna components to connect from all sides
- Base provides access for routing wires from unit to unit
- Optional data/electrical module
- Multi-surface glides

NOTES

Optional Data/Electrical Module is Anodized Aluminum.

If a Compact Laminate surface finish is specified, the edge will be Black. If a Flintwood or Natural Veneer surface is specified, the edge will be Baltic Birch.

Pricing includes a Compact Laminate Surface. If a Flintwood or Natural Veneer is specified, an additional upcharge applies.

PRODUCT OPTIONS

Data/Electrical	Upholstery Base Finish	Surface Finish	Frame Finish
N No Data/Electrical Module	Fabric	Compact Laminate	60 Platinum
D Data/Electrical Module with Power Cord (Shown)	Leather	Flintwood Natural Veneer Custom Wood Stains	74 Storm White 52 Ebony

SAMPLE ORDER CODE

NDNS D	E515	FC	52
---------------	-------------	-----------	-----------

DESCRIPTION

PRICE

	Grade 1	COM/ Grade 2	COL/ Grade 3	Grade 4	Grade 5	Grade 6	Grade 7	Grade 8	Grade 9	Grade 10
No Data/Electrical Module	2115	2184	2274	2362	2464	2566	2671	2777	2884	3158
Data/Electrical Module with Power Cord	2818	2886	2975	3065	3160	3268	3374	3478	3586	3858
	Leather LA	Leather LB	Leather LC	Leather LD						
No Data/Electrical Module	2613	2681	2883	2949						
Data/Electrical Module with Power Cord	3314	3380	3584	3649						

If Flintwood or Natural Veneer is specified add 219

To order a Custom Color (dna tables) please use the code NOCWS. A one time 1141 list charge per color applies.

FEATURES

- Base provides access for routing wires from unit to unit
- Optional data/electrical module
- Multi-surface glides

NOTES

Must be connected to a dna Bench or Square Seat/Ottoman for stability. Connection bracket and hardware included.

This side table is an add-on component to an existing bench or square seat/ottoman. It can also be used as a half-width table between two modular seats.

Optional Data/Electrical Module is Anodized Aluminum.

If Compact Laminate surface finish is specified, the edge will be Black. If a Flintwood or Natural Veneer surface is specified, the edge will be Baltic Birch.

Pricing includes a Compact Laminate surface. If a Flintwood or Natural Veneer is specified, an additional upcharge applies.

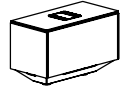

NDNM
dna – Add-On Side Table

PRODUCT OPTIONS

Upholstery Base Finish	Surface Finish	Data/Electrical	Frame Finish
Fabric	Compact Laminate	N No Data/Electrical Module	60 Platinum
Leather	Flintwood	D Data/Electrical Module with Power Cord (Shown)	74 Storm White
	Natural Veneer		52 Ebony
	Custom Wood Stains		

SAMPLE ORDER CODE

NDNM E515	N9	D	60
------------------	-----------	----------	-----------

PRICE

Grade 1	COM/ Grade 2	COL/ Grade 3	Grade 4	Grade 5	Grade 6	Grade 7	Grade 8	Grade 9	Grade 10
1747	1784	1828	1876	1924	1979	2031	2088	2141	2281
Leather LA	Leather LB	Leather LC	Leather LD						
2010	2051	2158	2197						

If Data/Electrical Module (D) is specified add 702

If Flintwood or Natural Veneer is specified add 209

To order a Custom Color (dna tables) please use the code NOCWS. A one time 1141 list charge per color applies.

NDNJ

dna – Linking Bracket



FEATURES

- Linking bracket connects dna units to prevent them from moving

NOTES

Two metal brackets and connection hardware are included.

One linking bracket required for each connection.

PRICE

81 (2 per package)

NDNF

dna – Floor Mounting Bracket

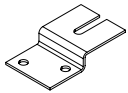

FEATURES

- Floor Mounting Bracket connects dna units to flooring

NOTES

Hardware is dependent on the type of floor and therefore not included.

Two brackets are included in each kit and one kit is required per unit to be secured to the floor.

To ensure proper spacing at least one Linking Bracket Kit (NDNJ) is also required when securing to the floor.

PRICE

81 (2 per package)

NDNL

dna – Freestanding Laptop Table



FEATURES

- Folding surface and integrated handle allow tables to be easily moved
- Tables can nest together for compact storage

NOTES

If a Compact Laminate surface finish is specified, the edge will be Black. If a Flintwood or Natural Veneer surface is specified, the edge will be Baltic Birch.

If a Polished Aluminum post is specified, base finish will also be Polished Aluminum. All other post finishes can be specified with a different base finish.

Pricing includes a painted post and base. If Polished Aluminum is specified, an additional upcharge applies.

Shipped knocked down.

PRODUCT OPTIONS

Surface Finish	Post Finish	Base Finish
Compact Laminate	60 Platinum	60 Platinum
Flintwood	74 Storm White	74 Storm White
Natural Veneer	52 Ebony	52 Ebony
Custom Wood Stains	C9 Polished Aluminum	C9 Polished Aluminum

SAMPLE ORDER CODE

NDNL MP	74	C9
----------------	-----------	-----------

PRICE

Compact Laminate	Flintwood/ Natural Veneer
1013	1447

If Polished Aluminum Post (C9), and Base is specified add 734

Polished Aluminum Base (C9) is specified add 303

To order a Custom Color (dna tables) please use the code NOCWS. A one time 1141 list charge per color applies.

NDNT

dna – Freestanding Coffee Table

NOTES

If a Compact Laminate surface finish is specified, the edge will be Black. If a Flintwood or Natural Veneer surface is specified, the edge will be Baltic Birch.

If a Polished Aluminum post is specified, base finish will also be Polished Aluminum. All other post finishes can be specified with a different base finish.

Pricing includes a painted post and base. If Polished Aluminum is specified, an upcharge applies.

Shipped knocked down.

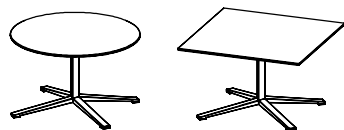

PRODUCT OPTIONS

Style	Surface Finish	Post Finish	Base Finish
R Round	Compact Laminate	60 Platinum	60 Platinum
S Square	Flintwood	74 Storm White	74 Storm White
	Natural Veneer	52 Ebony	52 Ebony
	Custom Wood Stains	C9 Polished Aluminum	C9 Polished Aluminum

SAMPLE ORDER CODE

NDNT R	MP	60	C9
---------------	-----------	-----------	-----------

PRICE

Compact Laminate	Flintwood/ Natural Veneer
1379	1602

If Polished Aluminum Post (C9), and Base is specified add 934

Polished Aluminum Base (C9) is specified add 353

To order a Custom Color (dna tables) please use the code NOCWS. A one time 1141 list charge per color applies.

NOTES

If a Compact Laminate surface finish is specified, the edge will be Black. If a Flintwood or Natural Veneer surface is specified, the edge will be Baltic Birch.

If a Polished Aluminum post is specified, base finish will also be Polished Aluminum. All other post finishes can be specified with a different base finish.

Pricing includes a painted post and base. If Polished Aluminum is specified, an upcharge applies.

N D N U

dna – Rectangular Freestanding Coffee Table



PRODUCT OPTIONS

Width	Depth	Height	Surface Finish	Post Finish	Base Finish
52, 60	26	16	Compact Laminate	60 Platinum	C9 Polished Aluminum
			Flintwood	74 Storm White	60 Platinum
			Natural Veneer	52 Ebony	74 Storm White
				C9 Polished Aluminum	52 Ebony

SAMPLE ORDER CODE

NDNU 52	26	16	N6	C9	C9
----------------	-----------	-----------	-----------	-----------	-----------

DIMENSIONS

PRICE

	Compact Laminate	Flintwood	Veneer
52	2362	3061	3217
60	2520	3217	3373

- If Platinum Post Finish (60), and Polished Aluminum Base (C9) is specified add 196
- If Storm White Post Finish (74), and Polished Aluminum Base (C9) is specified add 196
- If Ebony Post Finish (52), and Polished Aluminum Base (C9) is specified add 196
- If Polished Aluminum Post Finish (52), and Polished Aluminum Base (C9) is specified add 573

ferrarra dimensions & material requirements

statement of line

Ferrarra is a family of plush, fully-upholstered lounge furniture with dramatic, sweeping wooden arms and feet.

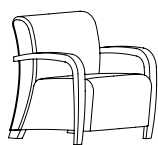

Lounge Chair
(LFER1)

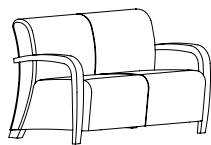

Lounge 2-Seater Sofa
(LFER2)

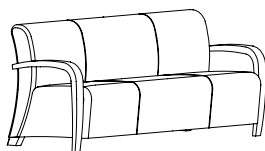

Lounge 3-Seater Sofa
(LFER3)

features

- Designed and tested for users up to 250 lbs

weight

Lounge Chair	32 lbs
Two Seater Sofa	58 lbs
Three Seater Sofa	84 lbs

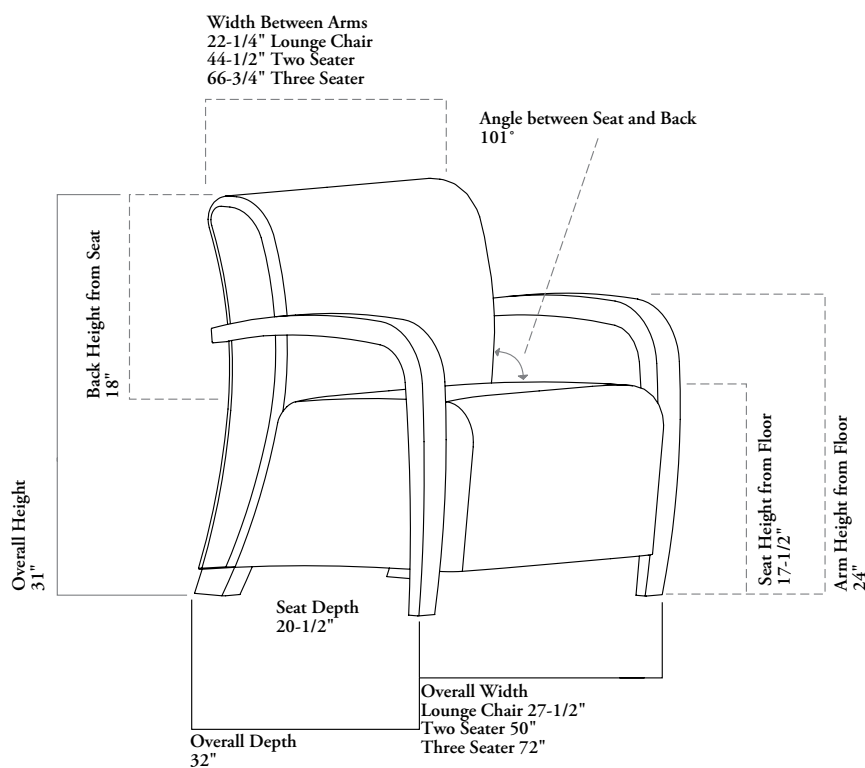

COM/COL material requirement

The pattern, repeat and directionality of fabric may increase the amount of yardage required.

Leather quantities should always be rounded up to the next hide size, as yields vary from 60-80% and are affected by the quality, size and shape of the hide, and by the location and quantity of blemishes.

	COM [yards]	COL [sq. ft]
Lounge Chair	3.5	60
Two Seater Sofa	7	119
Three Seater Sofa	10.5	179

NOTES

A TekniStain form is required if a Teknion Wood product is needed in colors outside our standard offering. To order a Custom Wood Stain please use the seating code NOCWS. A one time upcharge per color applies. Please forward a purchase order and TekniStain form to your Customer Service Representative. Allow two (2) weeks for the TekniStain approval process. The Custom Wood Stain sample must be signed off prior to placing product order. Allow (3) extra weeks to the total lead time of the chair when using a custom wood stain. The total lead time will begin once final approved samples have been received from customer to Teknion. The custom wood stain sample must be signed off prior to placing product order.

LFER
Ferrarra – Lounge

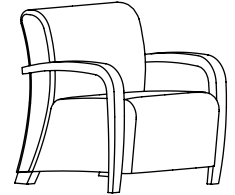

PRODUCT OPTIONS

Size	Upholstery Finish	Frame Finish
1 Chair (Shown)	Fabric	Wood Stain Coordinates
2 2-Seater Sofa	Leather	Custom Wood Stains
3 3-Seater Sofa		

SAMPLE ORDER CODE

LFER 3	S102	NM
---------------	-------------	-----------

SIZE

PRICE

	Grade 1	COM/ Grade 2	COL/ Grade 3	Grade 4	Grade 5	Grade 6	Grade 7	Grade 8	Grade 9	Grade 10
Chair	2626	2769	2908	3053	3192	3333	3473	3618	3758	4246
Two Seater Sofa	4030	4309	4592	4875	5157	5440	5721	6003	6285	7269
Three Seater Sofa	5429	5856	6277	6701	7121	7546	7970	8393	8814	10285
	Leather LA	Leather LB	Leather LC	Leather LD						
Chair	4246	4558	5384	5657						
Two Seater Sofa	7269	7865	9502	10046						
Three Seater Sofa	10285	11197	13657	14479						

To order a Custom Color for Seating please use the code NOCWS. A one time 1141 list charge per color applies.

tux dimensions & material requirements

statement of line

The Tux family has crisp, well tailored lines, is fully upholstered and modernly accented by its Chrome legs and base.

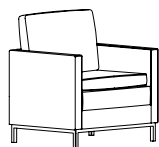

Lounge Chair
(LTUX1)

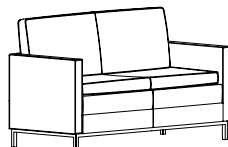

Lounge 2-Seater Sofa
(LTUX2)

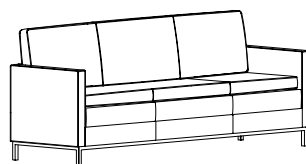

Lounge 3-Seater Sofa
(LTUX3)

features

- Designed and tested for users up to 250 lbs

weight

Guest Chair	85 lbs
Two Seater Sofa	150 lbs
Three Seater Sofa	245 lbs

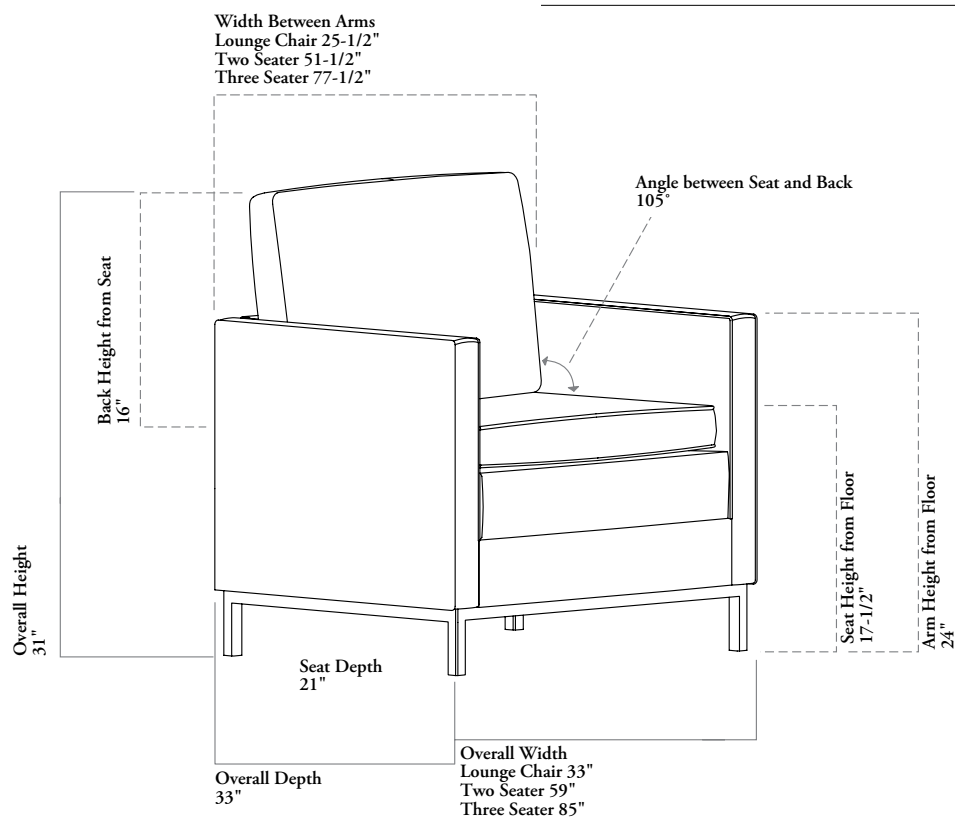

COM/COL material requirement

The pattern, repeat and directionality of fabric may increase the amount of yardage required.

Leather quantities should always be rounded up to the next hide size, as yields vary from 60-80% and are affected by the quality, size and shape of the hide, and by the location and quantity of blemishes.

	COM [yards]	COL [sq. ft]
Lounge Chair	6.75	120
Two Seater Sofa	10.5	189
Three Seater Sofa	13.5	243

FEATURES

Seat and back cushions are loose and reversible.

LTUX
Tux – Lounge

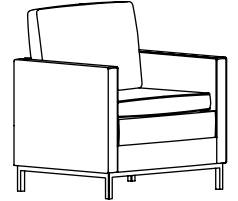

PRODUCT OPTIONS

Size	Upholstery Finish	Frame Finish
1 Chair (Shown)	Fabric	C Chrome
2 Two Seater Sofa	Leather	
3 Three Seater Sofa		

SAMPLE ORDER CODE

LTUX 3	L203	C
---------------	-------------	----------

DESCRIPTION

PRICE

	Grade 1	COM/ Grade 2	COL/ Grade 3	Grade 4	Grade 5	Grade 6	Grade 7	Grade 8	Grade 9	Grade 10
Chair	3569	3848	4124	4405	4679	4954	5233	5509	5788	6749
Two Seater Sofa	4822	5252	5682	6114	6545	6975	7405	7838	8267	9767
Three Seater Sofa	6069	6625	7179	7734	8286	8843	9396	9952	10501	12432
	Leather LA	Leather LB	Leather LC	Leather LD						
Chair	6749	7425	9072	9625						
Two Seater Sofa	9767	10876	13476	14343						
Three Seater Sofa	12432	13860	17199	18316						

vasari dimensions & material requirements

statement of line

The Vasari family has graceful lines, comfortable curves and is completely upholstered.

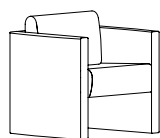

Lounge Chair
(NVAC)

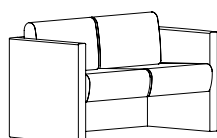

Lounge Sofa 2-Seater
(NVAE)

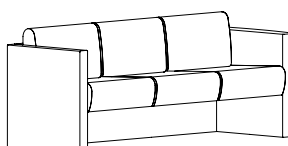

Lounge Sofa 3-Seater
(NVAS)



Tray

features

- Designed and tested for users up to 250 lbs

weight

Guest Chair	39 lbs
Two Seater Sofa	62 lbs
Three Seater Sofa	130 lbs
Tray	22 lbs

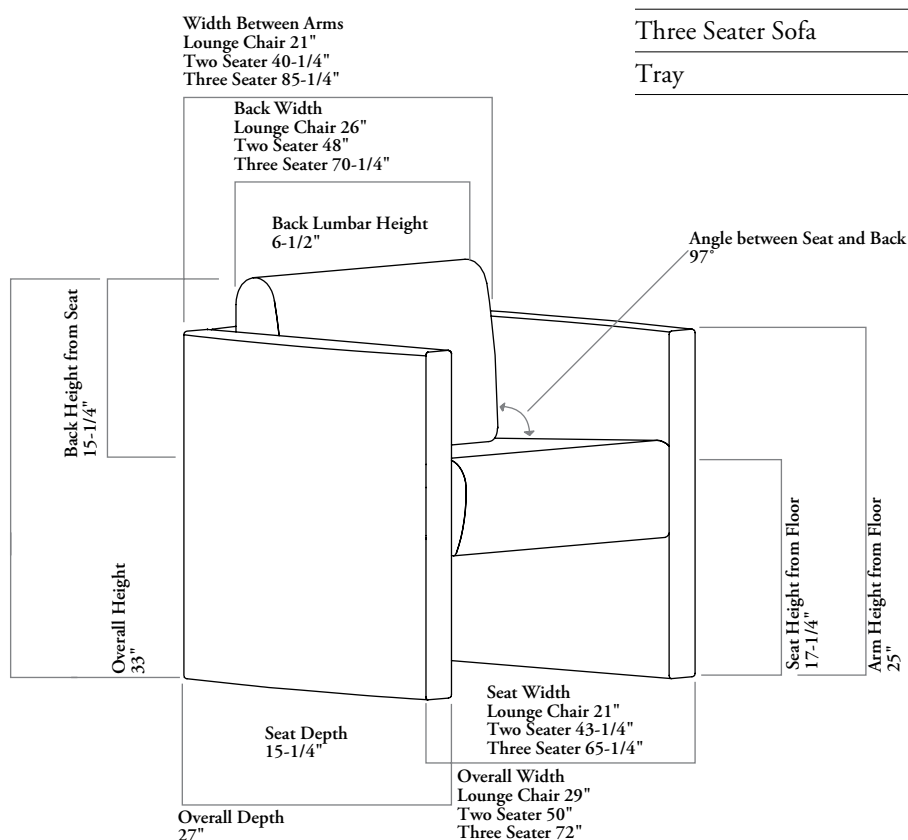

COM/COL material requirement

The pattern, repeat and directionality of fabric may increase the amount of yardage required.

Leather quantities should always be rounded up to the next hide size, as yields vary from 60-80% and are affected by the quality, size and shape of the hide, and by the location and quantity of blemishes.

	COM off the bolt [yards]	COM railroaded [yards]	COL [sq. ft]
Lounge Chair	4.5	6	81
Two Seater Sofa	6.75	8.5	122
Three Seater Sofa	9.25	11.75	225
Tray	n/a	n/a	4

FEATURES

Hard casters at the rear and hard glides in front are standard.

N V A C

Vasari – Lounge Chair

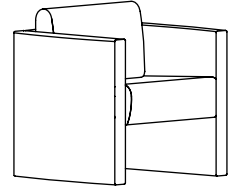

PRODUCT OPTIONS

Upholstery Finish		Casters/Glides (Optional)
Fabric		A Soft Casters Rear, Soft Glides Front
Leather		B Hard Glides Rear and Front

SAMPLE ORDER CODE

NVAC L210	B
------------------	----------

PRICE

COM/ Grade 1	COL/ Grade 2	Grade 3	Grade 4	Grade 5	Grade 6	Grade 7	Grade 8	Grade 9	Grade 10
2626	2807	2992	3173	3354	3536	3715	3896	4076	4710
Leather LA	Leather LB	Leather LC	Leather LD						
4710	5217	6331	6702						

If Soft Casters and Soft Glides (A) are specified add 43

If Hard Glides Rear and Front (B) are specified add 28

soft seating

NVA

Vasari – Lounge Sofa

FEATURES

Hard glides at the rear are standard on 2 and 3 seaters.

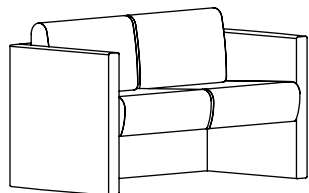

PRODUCT OPTIONS

Size	Upholstery Finish	Caster/Glides (Optional)
E 2-Seater Sofa (Shown)	Fabric	B Soft Glides at Rear
S 3-Seater Sofa	Leather	

SAMPLE ORDER CODE

NVA E	L104	B
--------------	-------------	----------

DESCRIPTION

2-Seater

3-Seater

2-Seater

3-Seater

PRICE

Grade 1	COM/ Grade 2	COL/ Grade 3	Grade 4	Grade 5	Grade 6	Grade 7	Grade 8	Grade 9	Grade 10	
3678	3949	4220	4496	4768	5039	5309	5583	5856	6801	
4730	5102	5475	5851	6219	6595	6968	7339	7711	9007	
Leather LA	Leather LB	Leather LC	Leather LD							
7017	7575	9253	9812							
10633	11663	14756	15788							

If Soft Glides at Rear (B) are specified add 43

NOTES

Tray surface is upholstered in Leather and has a concave profile on two sides to integrate with the arm profile of the Vasari Lounge series.

Metal Leg and Base are both finished in Ebony.

Leather LD is **not** available on the Lounge Tray.

N V A T
Vasari – Lounge Tray

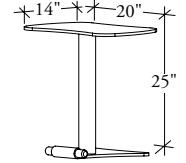

PRODUCT OPTIONS

Frame Finish	Tray Finish
E Ebony	Leather COL

SAMPLE ORDER CODE

NVAT E	L104
---------------	-------------

PRICE

COL	Leather LA	Leather LB	Leather LC	Leather LD
474	561	586	639	n/a

vignette dimensions & material requirements

statement of line

Vignette is a classic seating and tables collection with a strong architectural presence. Fully Upholstered with Chromed cylindrical or angled Steel legs.



Swivel Lounge Chair (NVBSA)

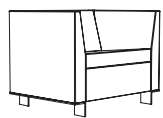

Cube Lounge Chair (NVBSB)

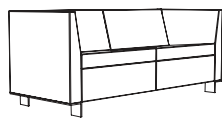

2-Seater Sofa (NVBSC)

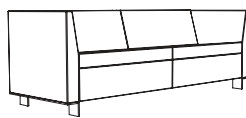

3-Seater Sofa (NVBSD)

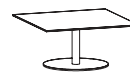

Coffee Table – Square (NVBTS)

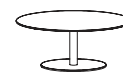

Coffee Table – Round (NVBTR)

features

- Designed and tested for users up to 250 lbs

weight

Swivel Lounge Chair	98 lbs
Cube Lounge Chair	108 lbs
Two Seater Sofa	138 lbs
Three Seater Sofa	168 lbs
Square Coffee Table	Can Vary
Round Coffee Table	Can Vary

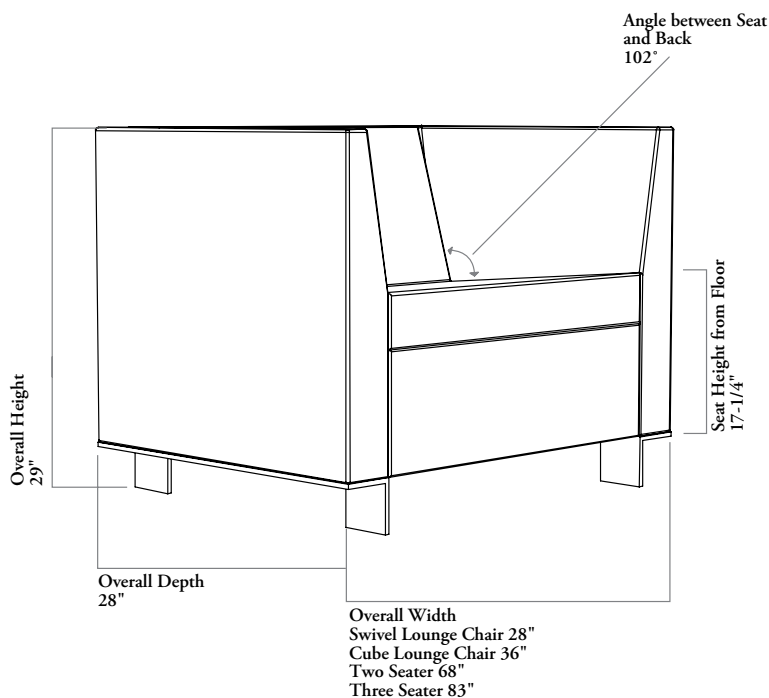
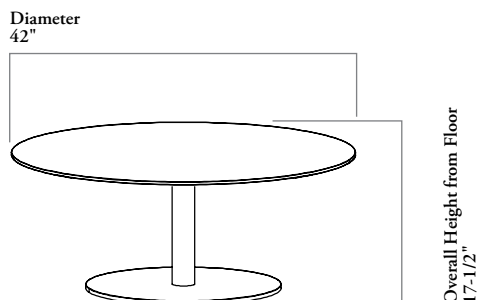
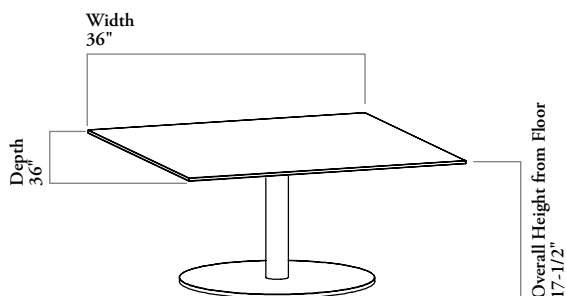

COM/COL material requirement

The pattern, repeat and directionality of fabric may increase the amount of yardage required.

Leather quantities should always be rounded up to the next hide size, as yields vary from 60-80% and are affected by the quality, size and shape of the hide, and by the location and quantity of blemishes.

	COM [yards]	COL [sq. ft]
Swivel Lounge Chair	3.5	75
Cube Lounge Chair	7.0	120
Two Seater Sofa	11.75	189
Three Seater Sofa	13.5	243

FEATURES

Swivel Lounge Chair rotates -45° to 45° and includes a swivel return to 0°.

Multi-surface glides.

N V B S

Vignette – Seating

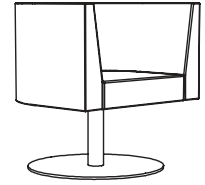

PRODUCT OPTIONS

Size	Upholstery Finish	Frame Finish
A Swivel Lounge Chair (Shown)	Fabric Leather	C Chrome
B Cube Lounge Chair		
C 2-Seater Sofa		
D Three Seater Sofa		

SAMPLE ORDER CODE

NVBS B	E523	C
---------------	-------------	----------

DESCRIPTION

PRICE

	Grade 1	COM/ Grade 2	COL/ Grade 3	Grade 4	Grade 5	Grade 6	Grade 7	Grade 8	Grade 9	Grade 10
Swivel Lounge Chair	4554	4656	4756	4859	4956	5058	5161	5261	5359	6129
Cube Lounge Chair	4380	4660	4946	5223	5508	5790	6070	6357	6636	7707
2-Seater Sofa	6129	6603	7076	7553	8024	8498	8974	9445	9917	11562
3-Seater Sofa	7883	8404	8930	9455	9977	10501	11026	11548	12072	15413
	Leather LA	Leather LB	Leather LC	Leather LD						
Swivel Lounge Chair	5675	5857	6408	6590						
Cube Lounge Chair	6777	7144	8243	8610						
2-Seater Sofa	10173	10790	12649	13266						
3-Seater Sofa	12598	13330	15529	16261						

N V B T

Vignette – Coffee Table

FEATURES

Tables are designed with a chrome cylindrical base.

NOTES

Round Table 42" diameter and Square Table 36" Square.

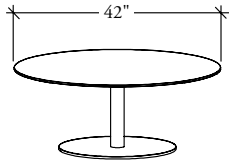

PRODUCT OPTIONS

Style	Surface Finish	Base Finish
R Round (Shown)	Flintwood	C Chrome
S Square	Natural Veneer	
	MR Solid Surface – White	
	MQ Marble Carrara	

SAMPLE ORDER CODE

NVBT R	VZ	C
---------------	-----------	----------

DESCRIPTION

PRICE

	Flintwood	Natural Veneer	Marble Carrara	Solid Surface White
Round	3306	3599	13397	11185
Square	3090	3320	11921	8567

teknion

www.teknion.com

IN CANADA:

1150 Flint Road
Toronto, Ontario
M3J 2J5 Canada
Tel 866.teknion
866.835.6466

IN THE USA:

350 Fellowship Road
Mt Laurel, New Jersey
08054 USA
Tel 877.teknion
877.835.6466

OTHER OFFICES LOCATED IN:

Europe, South and Central America
Middle East, Asia and Russia
For regional contact information
go to www.teknion.com

CAN/US/INT 09-25

©Teknion 2023

®, ™ trade marks of Teknion
Corporation and/or its subsidiaries or
licensed to it. Patents may be pending.

Some products may not be available
in all markets. Contact your
local Teknion Representative for
availability.

SEP23-SEAT