

SOCCO

ancillary

extended

catalog

seating framework

seating				
collections	product	soft	lounge	multi-use
Artifort	070	✓	✓	
True Design	Arca		✓	✓
Teknion	Banqs	✓	✓	
Artifort	Beso		✓	✓
Teknion	Bonds	✓		
Artifort	F500		✓	
Teknion	Fractals	✓	✓	
Artifort	Gap			✓
True Design	Hive		✓	✓
Segis	Hotel	✓	✓	
Artifort	Jima			✓
Artifort	Kalm		✓	
Artifort	Mare	✓	✓	
True Design	Millepiedi	✓		
Segis	Nami			✓
Artifort	Nina			✓
Teknion	North 56			✓
True Design	Not		✓	✓
True Design	Oracle	✓	✓	
Artifort	Pala		✓	
Teknion	Routes	✓	✓	✓
Artifort	Shark		✓	✓
Teknion	Zones	✓	✓	✓

tables framework

tables				
collections	product	occasional	casual	work
Teknion	Banqs	✓	✓	✓
Artifort	Beso		✓	
Teknion	Bevy Occasional	✓		
Teknion	Bevy Pedestal		✓	✓
Teknion	Bonds	✓		
Segis	Boom		✓	
Artifort	Clarion	✓	✓	
Wilkhahn	Confair			✓
Lande	Dock		✓	✓
Segis	Easy Boy	✓		
Teknion	Fractal Nook			✓
Segis	Hotel	✓		
Artifort	Mare	✓		
Teknion	North 56		✓	✓
Teknion	Routes	✓	✓	✓
Segis	Samu	✓	✓	
Wilkhahn	Timetable			✓
True Design	Wing			✓
Teknion	Zones	✓	✓	✓

seating

070

soft



teknion

070

product description

Simply slim, clean lines, an elegant base and the single row of buttons as a finishing touch. There is such a thing as timeless design. With its pleasant, slightly raised and not too deep seat, the 070 provides a graceful contrast to all the excessive, soft and low lounge sofas of today.

Artifort

fabrics & finishes

Upholstery

Seat can be finished in different fabrics available from LUUM; COM/COL; Selecte; Main Line Flax (Camira); Ox

Table Finish

Solid Oak Wood

Base Finish

Chrome

collection



dimensions

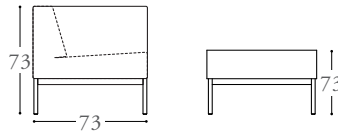

Side view dimension

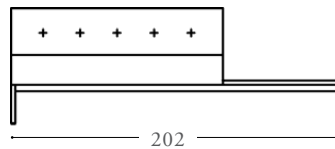

EARC070T
070 Sofa 2 And 2.5 Seater with table

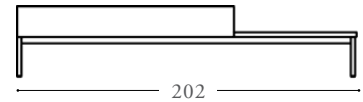

EAR070T
070 Daybed 2.5 Seater with table

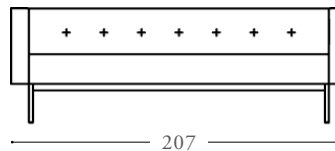

EARC070S
070 sofa 2 and 2.5 seater

www.teknion.com

MY 10-24

© Teknion 2024

®, ™ trade marks of Teknion Corporation and/or its subsidiaries or licensed to it. Patents may be pending.

teknion

hotel

soft



teknion

hotel

product description

Hotel is a modular seating system characterized by a strong expressive versatility conceived for fluid, linear, and angular combinations. Comfortable pieces designed for enjoyable relaxation and conviviality. The collection includes two and three seater sofas plus an armchair; armrest options include an upholstered armrest in two sizes and a tablet arm for computer or other support. Joining tables between the seats or multifunctional tables complete the collection.

segis

fabrics & finishes

Upholstery

Seat can be finished in different fabrics available from LUUM; COM/COL

Leg Finish

Powder Coated Finishes

collection



dimensions

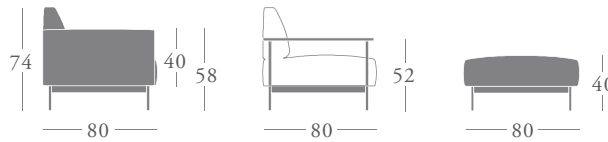

Side view dimension

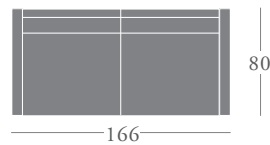

EIM02
Hotel Sofa 2 Seats with Small
Armrests

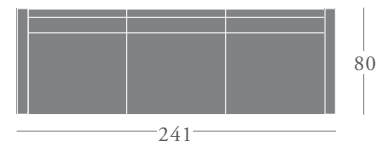

EIM03
Hotel Sofa 3 Seats with Small
Armrests

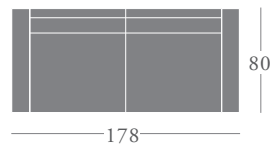

EIM05
Hotel Sofa 2 Seats with Large
Armrests

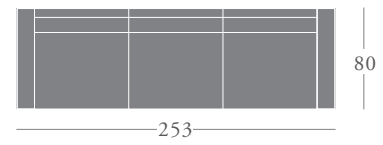

EIM06
Hotel Sofa 3 Seats with Large
Armrests

www.teknion.com

MY 10-24

© Teknion 2024

®, ™ trade marks of Teknion Corporation and/or its subsidiaries or licensed to it. Patents may be pending.

teknion

mare

soft



teknion

mare

product description

With its clean lines and subtle details, the Mare fixed cushion programme is timeless. Typical of René Holten's design is the slit in the centre of the seat and the slender base, which runs from back to front. This gives the sofa a spacious and elegant appearance, particularly in an open space.

collection



Artifort

fabrics & finishes

Upholstery

Seat can be finished in different fabrics available from LUUM; COM/COL; Selecte; Main Line Flax (Camira); Ox

Base Finish

Powder Coated and Polished Stainless Steel



dimensions

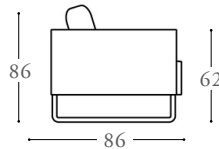

Side view dimension

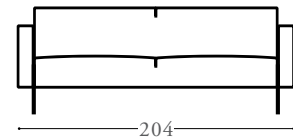

EARFC306
Mare Fix Cushion Sofa 2.5-seater

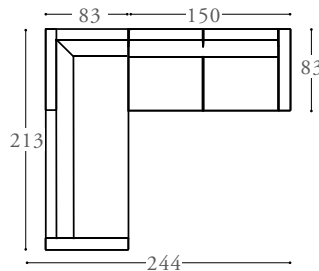

EARFC374
Mare Fix Cushion

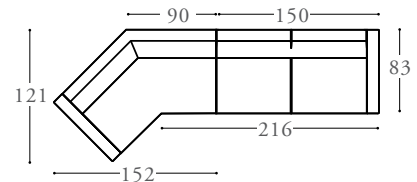

EARFC380
Mare Fix Cushion

www.teknion.com

MY 10-24

© Teknion 2024

®, ™ trade marks of Teknion Corporation and/or its subsidiaries or licensed to it. Patents may be pending.

teknion

millepiedi

soft



teknion

millepiedi

product description

Millepiedi is characterized by a modern and minimal design and develops a concept of functionality and flexibility in a wide range of configurations and dimensions. The contemporary design develops in a wide range of configurations and dimensions a conceptual idea based on functionality and flexibility, combined with high end details. The importance of the quality is translated into a vibrant union of design and craftsmanship experience, enhanced by a constant research in details and finishings.

true

fabrics & finishes

Upholstery

Seat can be finished in different fabrics available from Luum; COM/COL; Gravity (Camira); Focus/Focus Melange (Gabriel)

Wooden Base Finishes

Oak Wood

collection



dimensions

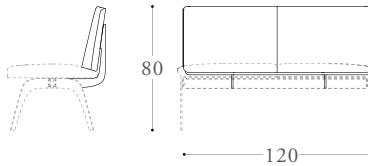

EMP220W
Millepiedi 2 Seater Backrest Module

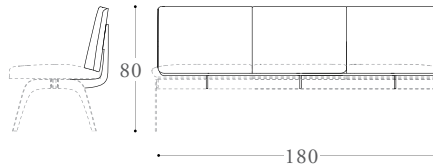

EMP330W
Millepiedi 3 Seater Backrest Module

www.teknion.com

MY 10-24

© Teknion 2024

®, ™ trade marks of Teknion Corporation and/or its subsidiaries or licensed to it. Patents may be pending.

teknion

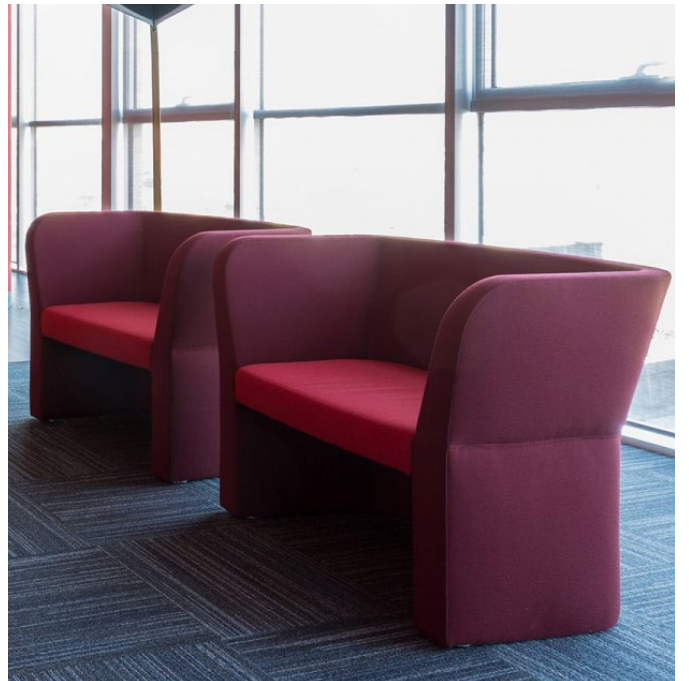

oracle

product description

Oracle is a tactile modular meeting solution for open-plan spaces. The 'room within a room' booth provides an informal semi-private comfortable meeting space for activity based workers. With its versatile configurations it can be used as a quiet harbor to get away from your desk, or as a meeting/collaboration space for 2-6 occupants. The high back design creates the sense of a mini-environment acting as a divider from the outside world, we have also added a porthole vision feature that enables you to discreetly see if the booth/pod is occupied. Also included within the range are a number of work surfaces/desk tops (along with provision for power) that can be substituted for sofa elements to provide hot desking or touchdown spaces for transient workers.

true

fabrics & finishes

Upholstery

Seat can be finished in different fabrics available from Luum; COM/COL; Gravity (Camira); Focus/Focus Melange (Gabriel)

collection



dimensions

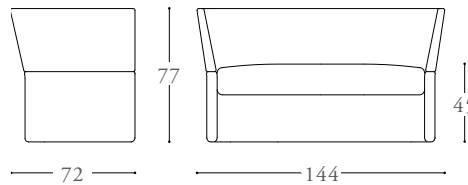

EOR2000
Oracle 2 Seater Sofa

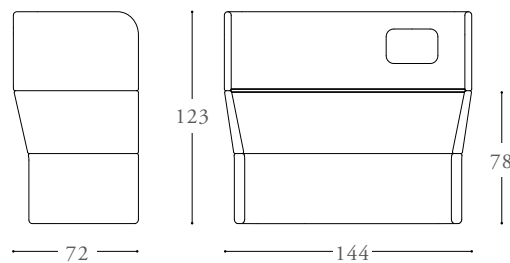

EOR200H
Oracle 2 Seater High Back Sofa

www.teknion.com

MY 10-24

© Teknion 2024

®, ™ trade marks of Teknion Corporation and/or its subsidiaries or licensed to it. Patents may be pending.

teknion



070

product description

Simply slim, clean lines, an elegant base and the single row of buttons as a finishing touch. There is such a thing as timeless design. With its pleasant, slightly raised and not too deep seat, the 070 provides a graceful contrast to all the excessive, soft and low lounge sofas of today.

collection



Artifort

fabrics & finishes

Upholstery

Seat can be finished in different fabrics available from LUUM; COM/COL; Selecte; Main Line Flax (Camira); Ox

Base Finish

Chrome

dimensions

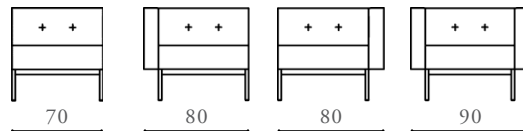

EARF070
070 Chair

www.teknion.com

MY 10-24

© Teknion 2024

®, ™ trade marks of Teknion Corporation and/or its subsidiaries or licensed to it. Patents may be pending.

teknion

arca

lounge

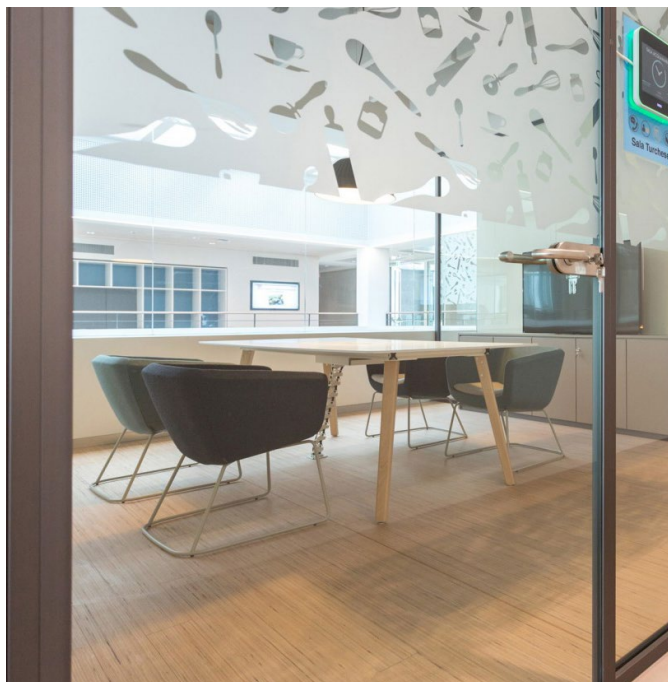

teknion

product description

Coming from Studio Orlandini's inspiration, Arca defines a new concept of armchair for lounges and waiting areas, available in 3 backrest heights, which can be combined to many base typologies. The standard option, with low backrest, is ideal for quick waiting areas, large meeting rooms, while the medium back option, with backrest cushion, gives more prestige and comfort to the armchair. The High version gives the unique touch of design to this collection, with its embracing backrest for a break of full relax. Arca perfectly traces the new concept of "Smart Lounge", where waiting moments become great occasions for reflection, working or relaxing on the web; all versions of Arca can indeed be equipped with a large writing tablet, swivel around the arm.

collection



true

fabrics & finishes

Upholstery

Seat can be finished in different fabrics available from Luum; COM/COL; Gravity (Camira); Focus/Focus Melange (Gabriel)

Steel Base Finish

Metal Finishes and Chrome Finish

Wood Base Finishes

Natural Ashwood

dimensions

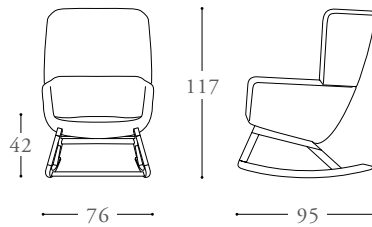

EAA909R
Arca Lounge High Backrest,
Wooden Rocking Base

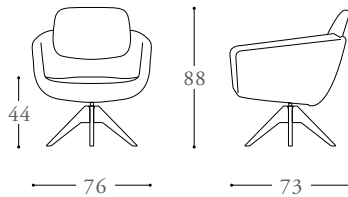

EAA8099
Arca Lounge Mid-Backrest, Swivel
Wooden Base

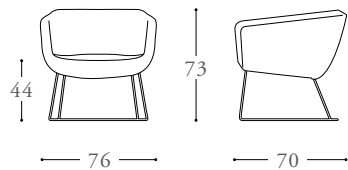

EAA7095
Arca Lounge Low Backrest Armchair,
Steel Sled Base

www.teknion.com

MY 10-24

© Teknion 2024

®, ™ trade marks of Teknion Corporation and/or its subsidiaries or licensed to it. Patents may be pending.

beso

lounge



teknion

beso

product description

Beso, Spanish for 'kiss', is a highly versatile and stylish chair program created by designer Khodi Feiz. The notion of lightness, flexibility and comfort is what striking in this design. The Beso collection includes a Beso chair, a Beso Lounge armchair, a Beso barstool and Beso Table.

collection



Artifort

fabrics & finishes

Upholstery

Seat can be finished in different fabrics available from LUUM; COM/COL; Selecte; Main Line Flax (Camira); Ox

Base Finishes

Chrome and Paint

Five-Star Base Finishes

Polished Aluminum

Wood Base Finishes

Basque White Oak, Natural Oak, Cocoa Brown, Sierra and Truffle

Four-Star Lounge Base Finishes

Stainless Steel

dimensions

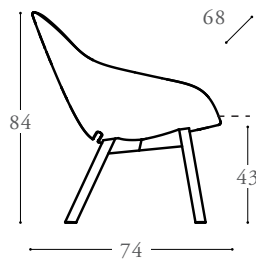

EARBV
Beso Chair - Lounge Chair,
Wood Leg

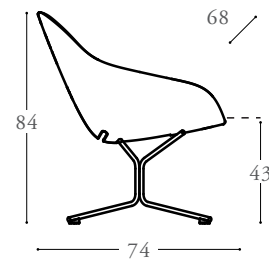

EARBU
Beso Chair - Lounge Base, Wire
Star Base

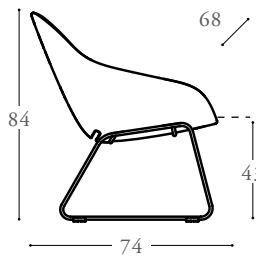

EARBV
Beso Chair - Lounge Base,
Sled Base

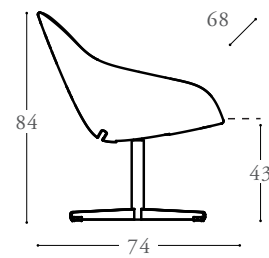

EARBT
Beso Chair - Lounge Chair,
4-Star Swivel

www.teknion.com

MY 10-24

© Teknion 2024

®, ™ trade marks of Teknion Corporation and/or its subsidiaries or licensed to it. Patents may be pending.

teknion

f500

lounge



teknion

f500

product description

Designer Geoffrey D. Harcourt RDI distinguished himself with this series swivel chairs by the comfort form and striking upholstery. The idea of the F500 armchair originate because the girlfriend of Harcourt RDI like to curl up in cross-leggs. He was fascinated by this very female attitude. The result is the F500 series: an armchair with all comfort of an easy chair, and wide enough to suit an unusual seating position.

Artifort

fabrics & finishes

Upholstery

Seat can be finished in different fabrics available from LUUM; COM/COL; Selecte; Main Line Flax (Camira); Ox

Paint Finish

Paint Powder and Stainless Steel

collection



dimensions

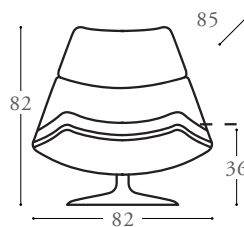

EARF511
500 Series Lounge Chair Low Swiveling

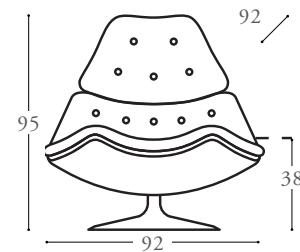

EARF588
500 Series Lounge Chair, Disc Base High Swiveling

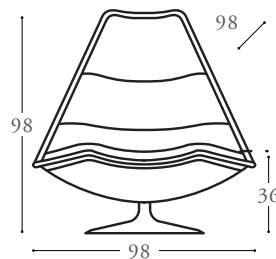

EARF585
500 Series Lounge Chair High Swiveling

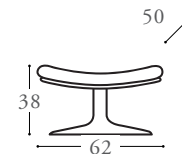

EARF510
500 Series Lounge Chair, Disc Base, Footstool Non-Swiveling

www.teknion.com

MY 10-24

© Teknion 2024

®, ™ trade marks of Teknion Corporation and/or its subsidiaries or licensed to it. Patents may be pending.

teknion

hive

lounge

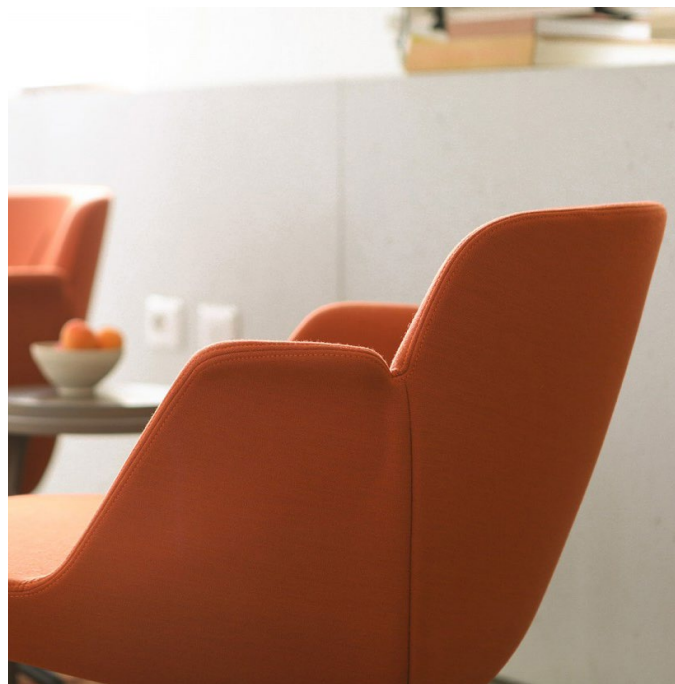

teknion

hive

product description

10 years after its debut in the market as an executive office chair and waiting armchair, Hive has been revisited and redesigned to adapt to the new needs of the lounge, waiting and hospitality segment. The new polyurethane shell is available in chair and armchair version with double backrest height. The design is characterized by the pronounced lines of the compact armrest and the stitching that shapes the backrest in a vertical direction. It is available with a solid wood 4 legs base or with a 4-spoke steel swivel base.

true

fabrics & finishes

Upholstery

Seat can be finished in different fabrics available from Luum; COM/COL; Gravity (Camira); Focus/Focus Melange (Gabriel)

Aluminium Finishes

Black and White

Wood Base Finishes

Natural Ashwood

collection



dimensions

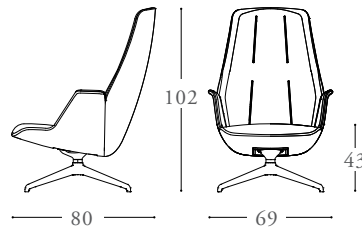

EHV9098
High Back Lounge Armchair, 4-Spoke
Aluminum Swivel Base

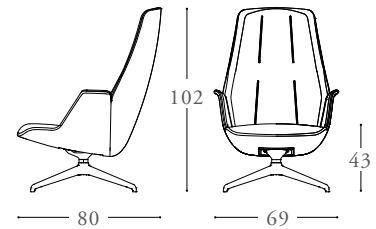

EHS9098
High Back Lounge Armchair,
4-Spoke Aluminum Swivel Base

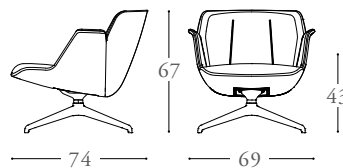

EHV7098
Hive Low Back Lounge Armchair,
4 Spoke Aluminium Swivel Base

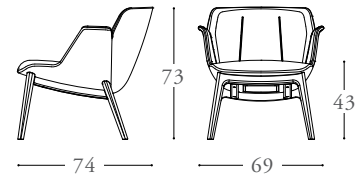

EHV7094
Hive Lounge Low Backrest,
4-Wooden Legs

www.teknion.com

MY 10-24

© Teknion 2024

®, ™ trade marks of Teknion Corporation and/or its subsidiaries or licensed to it. Patents may be pending.

teknion

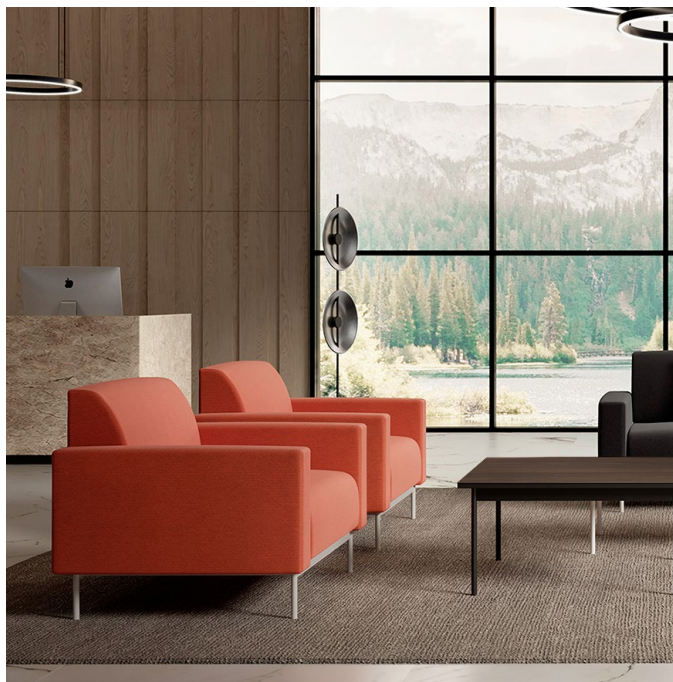

hotel

product description

Hotel is a modular seating system characterized by a strong expressive versatility conceived for fluid, linear, and angular combinations. Comfortable pieces designed for enjoyable relaxation and conviviality. The collection includes two and three seater sofas plus an armchair; armrest options include an upholstered armrest in two sizes and a tablet arm for computer or other support. Joining tables between the seats or multifunctional tables complete the collection.

segis

fabrics & finishes

Upholstery

Seat can be finished in different fabrics available from LUUM; COM/COL

Leg Finish

Powder Coated Finishes

collection



dimensions

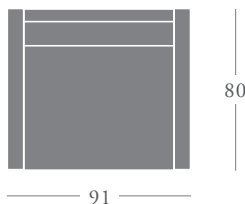

EIM01
Hotel Armchair with Small Armrests

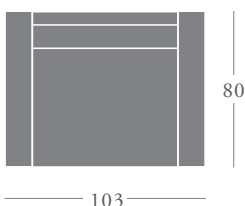

EIM04
Hotel Armchair with Large Armrests

www.teknion.com

MY 10-24

© Teknion 2024

®, ™ trade marks of Teknion Corporation and/or its subsidiaries or licensed to it. Patents may be pending.

teknion

kalm

lounge

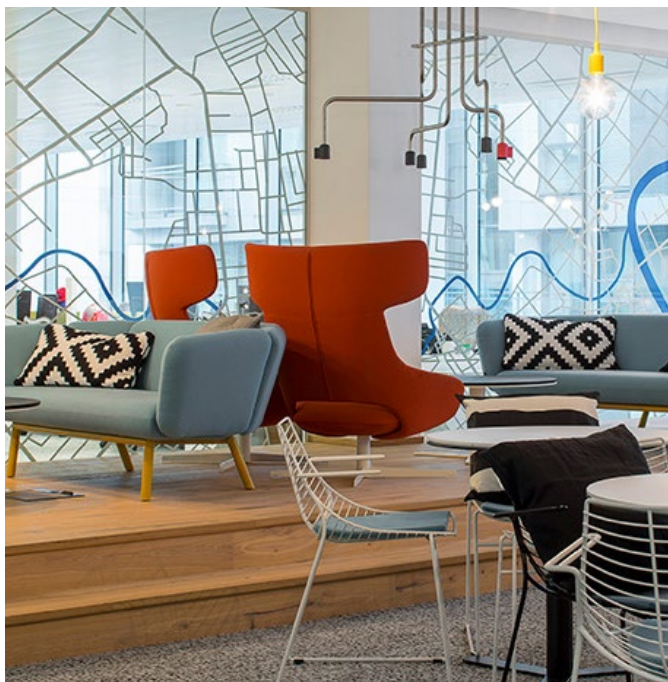

teknion

kalm

product description

Kalm is Artifort's large, new cosy armchair by our French designer Patrick Norguet. It is a sanctuary in its own right, a place to unwind and get comfortable. With Kalm, Patrick Norguet has created an iconic, luxurious and comfortable highback armchair for your living room or study.

Kalm is not only a beautiful chair that will earn a special place for itself in your home. According to Norguet, it is also 'an expressive armchair that is suitable in any project environment. Several Kalm armchairs grouped together will definitely define a hotel lobby or meeting room and create a distinguished and iconic image.'

Artifort

fabrics & finishes

Upholstery

Seat can be finished in different fabrics available from LUUM; COM/COL; Selecte; Main Line Flax (Camira); Ox

Wood Base Finishes

Basque White Oak, Natural Oak, Sierra, Cocoa Brown, Truffle

Base Finishes

Stainless Steel

collection



dimensions

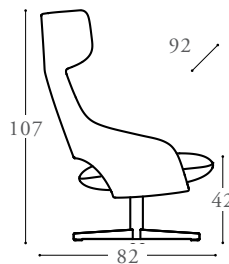

EARKA
Kalm Lounge Chair, 4-Star Swivel

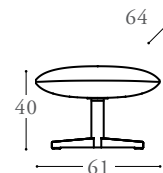

EARKB
Kalm Footstool, 4-Star

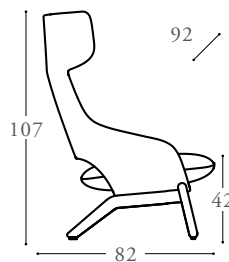

EARKD
Kalm Lounge Chair, Wood Leg

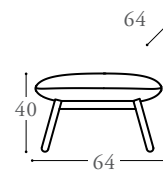

EARKE
Kalm Footstool, Wood Leg

www.teknion.com

MY 10-24

© Teknion 2024

®, ™ trade marks of Teknion Corporation and/or its subsidiaries or licensed to it. Patents may be pending.

teknion

mare

lounge



teknion

mare

product description

With its clean lines and subtle details, the Mare fixed cushion programme is timeless. Typical of René Holten's design is the slit in the centre of the seat and the slender base, which runs from back to front. This gives the sofa a spacious and elegant appearance, particularly in an open space.

collection



Artifort

fabrics & finishes

Upholstery

Seat can be finished in different fabrics available from LUUM; COM/COL; Selecte; Main Line Flax (Camira); Ox

Base Finish

Powder Coated and Polished Stainless Steel

dimensions

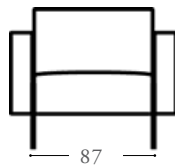

EARFC302
Mare Fix Cushion Armchair
87cm wide

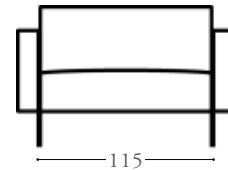

EARFC303
Mare Fix Cushion Armchair
115cm wide

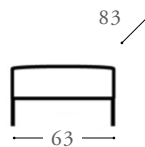

EARFC300
Mare Fix Cushion Footstool
63 X 83cm

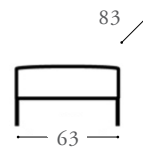

EARFC301
Mare Fix Cushion Footstool
83 X 83cm

www.teknion.com

MY 10-24

© Teknion 2024

°, ™ trade marks of Teknion Corporation and/or its subsidiaries or licensed to it. Patents may be pending.

teknion

not

lounge



teknion

not

product description

A wide shell embraces the seat in a warm embrace. The seams define the soft lines, giving it an elegant and versatile look. Suitable for conference hall and relax spaces of hotel and domestic environment. The NOT family, characterized by a wide seat shell and an elegant shape, introduces 2 new versions: the Lounge, wider and more comfortable, and the Mini, providing a more compact shell and new bases to open the use of this products to new environments.

collection



true

fabrics & finishes

Upholstery

Seat can be finished in different fabrics available from Luum; COM/COL; Gravity (Camira); Focus/Focus Melange (Gabriel)

Steel Base Finishes

Metal Finishes

Wooden Base Finishes

Natural Ashwood

Aluminium Finishes

Black and White

dimensions

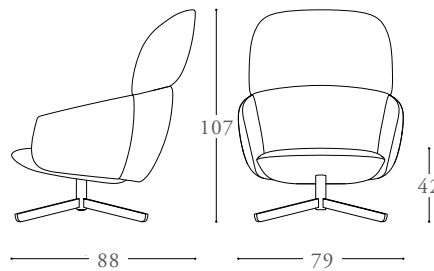

ENT8090
Not High Back Lounge Armchair, Steel Base

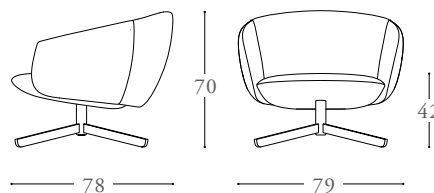

ENT7090
Not Low Back Lounge Armchair, Steel Base

www.teknion.com

MY 10-24

© Teknion 2024

®, ™ trade marks of Teknion Corporation and/or its subsidiaries or licensed to it. Patents may be pending.

teknion



oracle

product description

Oracle is a tactile modular meeting solution for open-plan spaces. The 'room within a room' booth provides an informal semi-private comfortable meeting space for activity based workers. With its versatile configurations it can be used as a quiet harbor to get away from your desk, or as a meeting/collaboration space for 2-6 occupants. The high back design creates the sense of a mini-environment acting as a divider from the outside world, we have also added a porthole vision feature that enables you to discreetly see if the booth/pod is occupied. Also included within the range are a number of work surfaces/desk tops (along with provision for power) that can be substituted for sofa elements to provide hot desking or touchdown spaces for transient workers.

true

fabrics & finishes

Upholstery

Seat can be finished in different fabrics available from Luum; COM/COL; Gravity (Camira); Focus/Focus Melange (Gabriel)

collection



dimensions

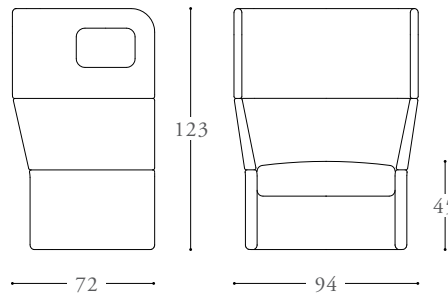

EOR100H
Oracle High Back Armchair

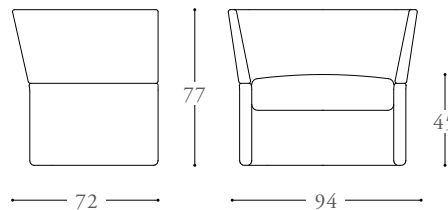

EOR1000
Oracle Armchair

www.teknion.com

MY 10-24

© Teknion 2024

®, ™ trade marks of Teknion Corporation and/or its subsidiaries or licensed to it. Patents may be pending.

pala

lounge

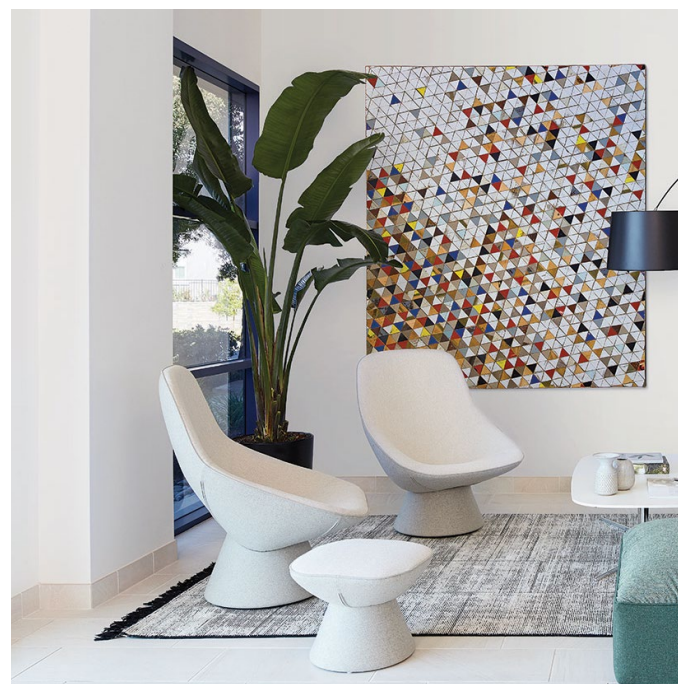

teknion

pala

product description

Pala is a fully upholstered armchair on a pedestal designed by Italian designer Luca Nichetto. The design follows the shape of a human body and combines Artifort's heritage with a contemporary approach. The striking Pala works well in homes, hotels, waiting areas and lounges.

collection



Artifort

fabrics & finishes

Upholstery

Seat can be finished in different fabrics available from LUUM; COM/COL; Selecte; Main Line Flax (Camira); Ox

dimensions

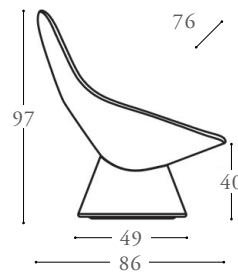

EARPA
Pala Lounge Chair

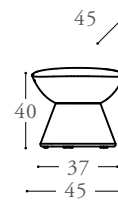

EARPB
Pala Ottoman

www.teknion.com

MY 10-24

© Teknion 2024

°, ™ trade marks of Teknion Corporation and/or its subsidiaries or licensed to it. Patents may be pending.

teknion

arca

multi-use

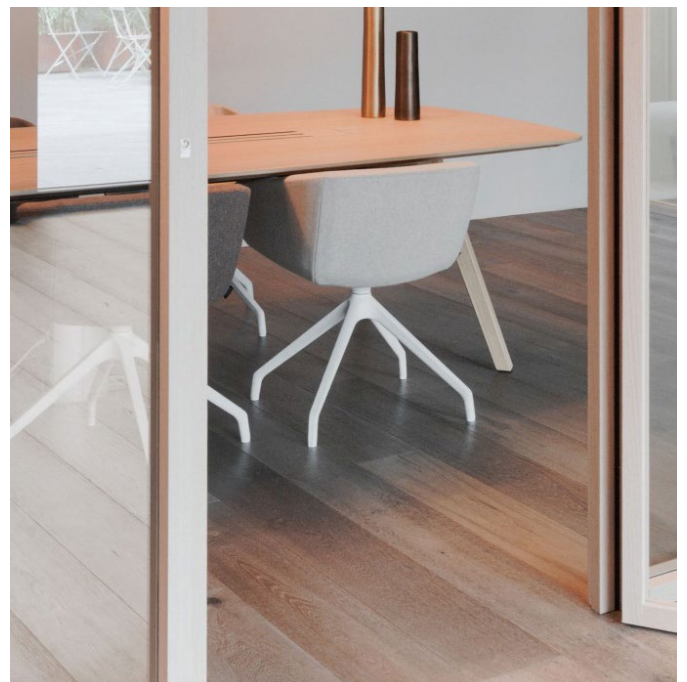

teknion

arca

product description

Coming from Studio Orlandini's inspiration, Arca defines a new concept of armchair for lounges and waiting areas, available in 3 backrest heights, which can be combined to many base typologies. The standard option, with low backrest, is ideal for quick waiting areas, large meeting rooms, while the medium back option, with backrest cushion, gives more prestige and comfort to the armchair. The High version gives the unique touch of design to this collection, with its embracing backrest for a break of full relax. Arca perfectly traces the new concept of "Smart Lounge", where waiting moments become great occasions for reflection, working or relaxing on the web; all versions of Arca can indeed be equipped with a large writing tablet, swivel around the arm.

collection



true

fabrics & finishes

Upholstery

Seat can be finished in different fabrics available from Luum; COM/COL; Gravity (Camira); Focus/Focus Melange (Gabriel)

Steel Base Finish

Metal Finishes and Chrome Finish

Aluminium Base

Black and White

dimensions

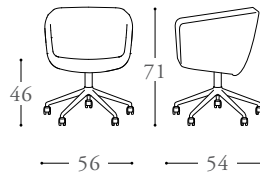

EAA409C

Arca 5 Spoke Aluminium Swivel Base On Casters Mini

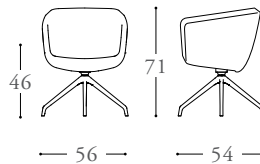

EAA4098

Arca 4 Spoke Aluminium Swivel Base Mini

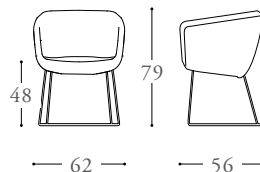

EAA5095

Arca Steel Sled Base Small

www.teknion.com

MY 10-24

© Teknion 2024

®, ™ trade marks of Teknion Corporation and/or its subsidiaries or licensed to it. Patents may be pending.

teknion

beso

multi-use

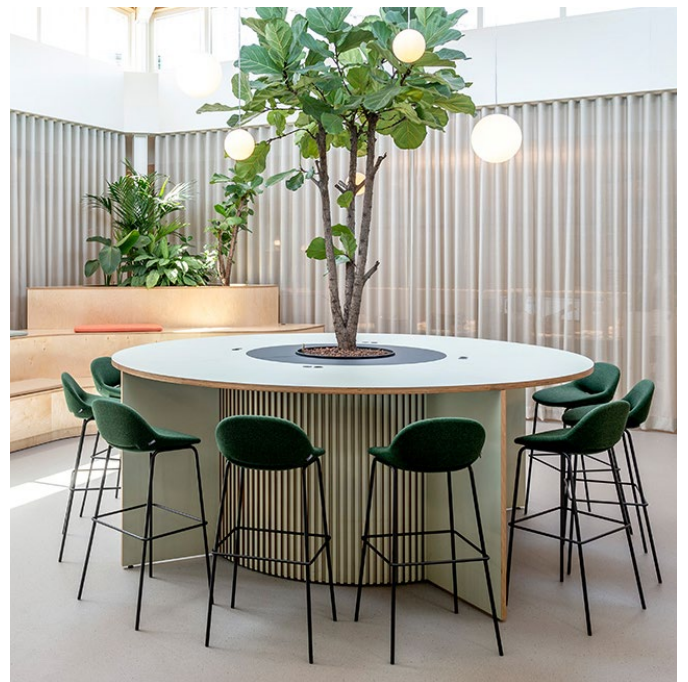

teknion

beso

product description

Beso, Spanish for 'kiss', is a highly versatile and stylish chair program created by designer Khodi Feiz. The notion of lightness, flexibility and comfort is what striking in this design. The Beso collection includes a Beso chair, a Beso Lounge armchair, a Beso barstool and Beso Table.

collection



Artifort

fabrics & finishes

Upholstery

Seat can be finished in different fabrics available from LUUM; COM/COL; Selecte; Main Line Flax (Camira); Ox

Base Finishes

Chrome, Polished Aluminum, Fashion Paint Finishes and Stainless Steel

Wood Base Finishes

Wood, Basque White Oak, Natural Oak, Cocoa Brown, Sierra and Truffle

dimensions

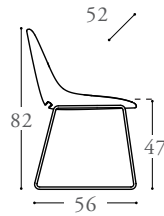

EARBA
Beso Chair, Sled Base

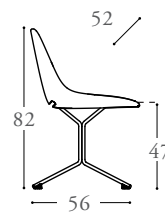

EARBB
Beso Chair, Wire Star Base

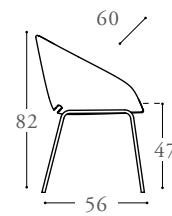

EARBG
Armchair, 4 Leg

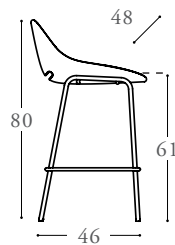

EARBQ
Beso Counter Stool, Sled

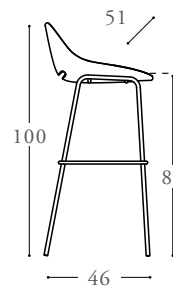

EARBM
Beso Chair, Barstool, 4 Leg

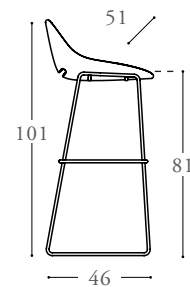

EARBN
Beso Barstool, Sled Base

www.teknion.com

MY 10-24

© Teknion 2024

®, ™ trade marks of Teknion Corporation and/or its subsidiaries or licensed to it. Patents may be pending.

teknion

gap

multi-use



teknion

gap

product description

Meeting and dining chair Gap is a design by Khodi Feiz. The distinctive gap in the fully upholstered shell appears where the seat ends and the back begins. It's this smile-shaped gap that gives the design just that little bit extra, providing more room for the back and guaranteeing comfortable sitting. Gap is available in various types of bases and can be upholstered in both fabric and leather. Gap adapts effortlessly in various settings such as conference rooms, meeting rooms and restaurants.

Artifort

fabrics & finishes

Upholstery

Seat can be finished in different fabrics available from LUUM; COM/COL; Selecte; Main Line Flax (Camira); Ox

Base Finishes

Chrome, Powder Coated and Polished Aluminum finishes

collection



dimensions

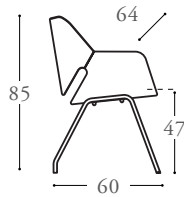

EARGAP1
Gap 4 Legged Single/Double Upholstery

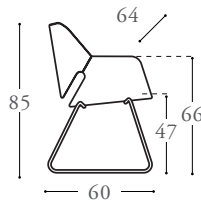

EARGAP2
Gap 4 Sled Single/Double Upholstery

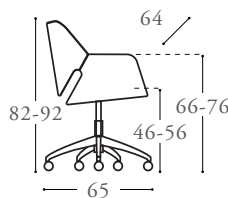

EARGAP3
Gap 5 Legged Height-Adjustable
Single/Double Upholstery

www.teknion.com

MY 10-24

© Teknion 2024

®, ™ trade marks of Teknion Corporation and/or its subsidiaries or licensed to it. Patents may be pending.

teknion

hive

multi-use



teknion

hive

product description

10 years after its debut in the market as an executive office chair and waiting armchair, Hive has been revisited and edesigned to adapt to the new needs of the lounge, waiting and hospitality segment. The new polyurethane shell is available in chair and armchair version with double backrest height. The design is characterized by the pronounced lines of the compact armrest and the stitching that shapes the backrest in a vertical direction. It is available with a solid wood 4 legs base or with a 4-spoke steel swivel base.

collection



true

fabrics & finishes

Upholstery

Seat can be finished in different fabrics available from Luum; COM/COL; Gravity (Camira); Focus/Focus Melange (Gabriel)

Aluminium Finishes

Black and White

dimensions

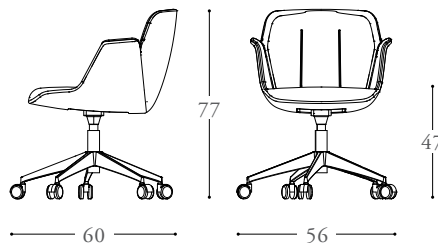

EHV409C
Hive 5-Spoke Aluminium Swivel Base On
Casters Mini

www.teknion.com

MY 10-24

© Teknion 2024

®, ™ trade marks of Teknion Corporation and/or its subsidiaries or licensed to it. Patents may be pending.

teknion

jima

multi-use



teknion

jima

product description

Form, function, comfort and detail: the Jima chair by designer Patrick Norguet ticks all the boxes. This sleek, expressive chair will fit seamlessly into different worlds – an office for instance, and a home for sure.

Particularly noteworthy is the single, flowing line running from the top of the back, via the arms to the bottom of the seat. This makes it appear as if the seat cushion is locked in an embrace, providing flexibility and maximum comfort. Jima comes in high back and low back versions, and is available in four different bases. The chair comes in an extensive range of fabrics and colours, inviting you to experiment with any interior style.

Artifort

fabrics & finishes

Upholstery

Seat can be finished in different fabrics available from LUUM; COM/COL; Selecte; Main Line Flax (Camira); Ox

Base Finishes

Chrome, Paint Powder and Polished Aluminum finishes

collection



dimensions

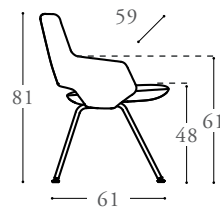

EARJAL
Jima Chair, 4-Leg Base, Low Back

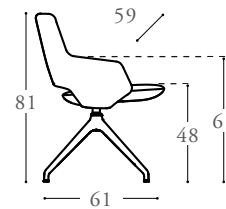

EARJBL
Jima Chair, 4-Star Swivel Base Low Back

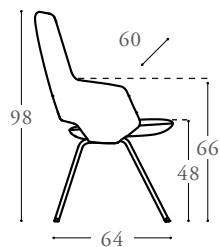

EARJAH
Jima Chair, 4-Leg Base, High Back

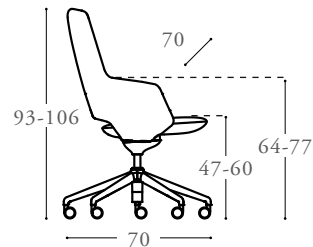

EARJCH
Jima Chair, 5-Star Task Base, High Back

www.teknion.com

MY 10-24

© Teknion 2024

®, ™ trade marks of Teknion Corporation and/or its subsidiaries or licensed to it. Patents may be pending.

teknion

nami

multi-use



teknion

nami

product description

Stacking chair with or without armrests, polypropylene shell, with possibility of ganging device and writing tablet. Nami is ideal in training and conference areas, auditoriums, classrooms and healthcare facilities but it is also attractive in a retail setting, cafeteria and recreational space.

segis

fabrics & finishes

Upholstery

Seat can be finished in different fabrics available from Luum; COM/COL

Seat & Back Finishes

Black, Grey and Off-White

Seat Frame

Black, Dark Grey, White and Aluminium

Arm Finish

Black, Dark Grey, White and Aluminium

collection



dimensions

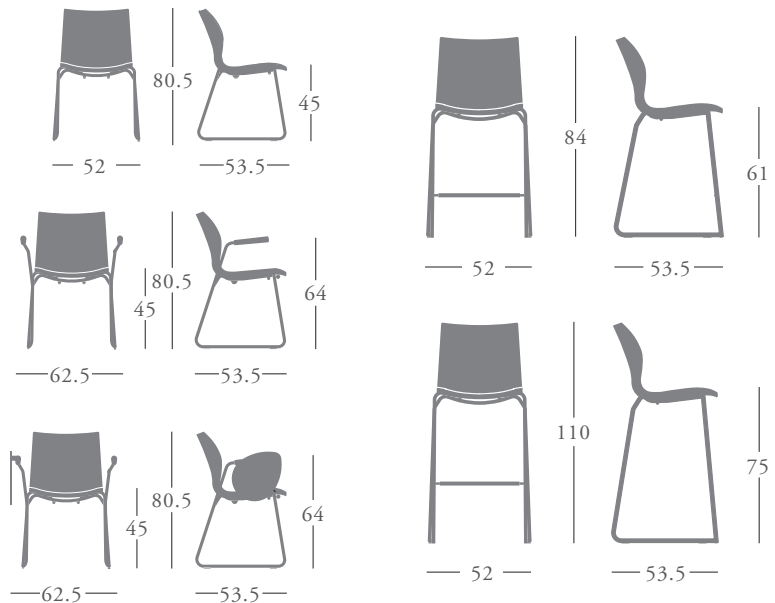

ES010
Nami Polypropylene Chair

EG010
Nami Polypropylene Stool

www.teknion.com

MY 10-24

© Teknion 2024

®, ™ trade marks of Teknion Corporation and/or its subsidiaries or licensed to it. Patents may be pending.

teknion

nina

multi-use

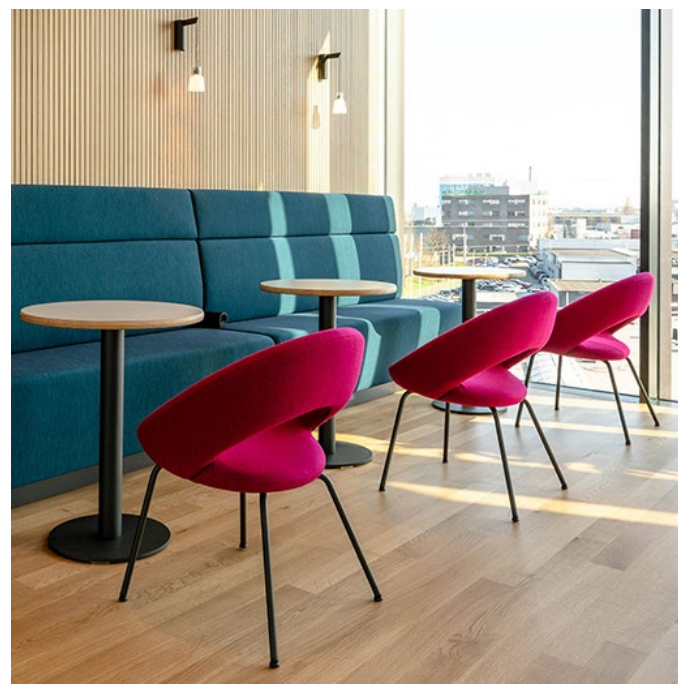

teknion

nina

product description

A contemporary, luxurious design. Elegant and comfortable. For meeting rooms and dining rooms. The rounded, wellfitted back makes the chair comfortable as active seating or in a more relaxed position.

The round chair fits the contour of the human body. As a result, both an active and relaxed sitting position can be adopted. Available in four versions.

collection



Artifort

fabrics & finishes

Upholstery

Seat can be finished in different fabrics available from LUUM; COM/COL; Selecte; Main Line Flax (Camira); Ox

Base Finishes

Chrome, Powder Coated and Aluminum Polished (tube in chrome) finishes

dimensions

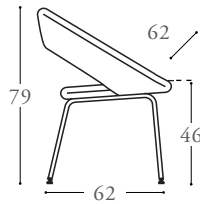

EARN A
Nina Chair 4 Legged

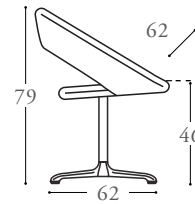

EARN B
Nina C Chair Cross Base Non-Swiveling

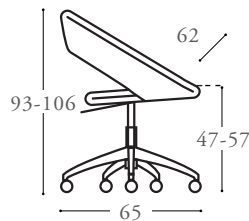

EARN C
Nina D Chair 5-Legged Height-Adjustable

www.teknion.com

MY 10-24

© Teknion 2024

®, ™ trade marks of Teknion Corporation and/or its subsidiaries or licensed to it. Patents may be pending.

teknion

not

multi-use

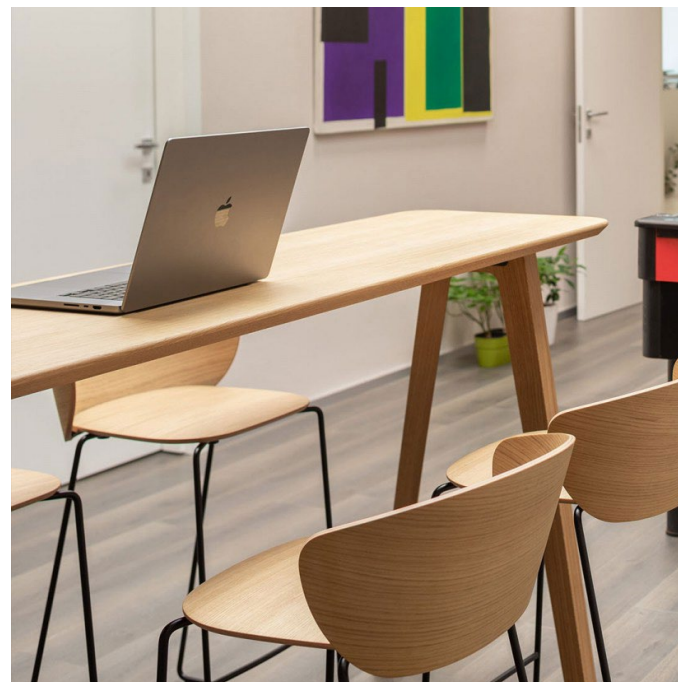

teknion

not

product description

A wide shell embraces the seat in a warm embrace. The seams define the soft lines, giving it an elegant and versatile look. Suitable for conference hall and relax spaces of hotel and domestic environment. The NOT family, characterized by a wide seat shell and an elegant shape, introduces 2 new versions: the Lounge, wider and more comfortable, and the Mini, providing a more compact shell and new bases to open the use of this products to new environments.

true

fabrics & finishes

Upholstery

Seat can be finished in different fabrics available from Luum; COM/COL; Gravity (Camira); Focus/Focus Melange (Gabriel)

Steel Base Finishes

Metal Finishes

Wood Base Finishes

Natural Ashwood

Aluminium Finishes

Black and White

collection



dimensions

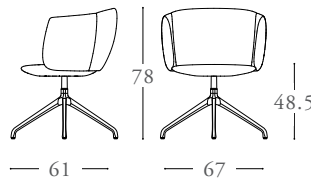

ENT5098
Not 4 Spoke Aluminium
Swivel Base Small

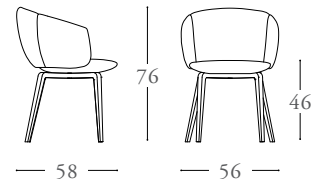

ENT4094
Not 4 Legs Wooden Base Mini

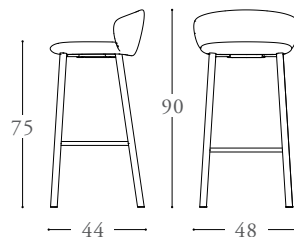

ENT75U09
Not Stool with 4 Wooden Legs

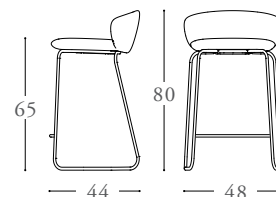

ENT65U05
Not Stackable Stool with Steel Sled
Base Stool

www.teknion.com

MY 10-24

© Teknion 2024

®, ™ trade marks of Teknion Corporation and/or its subsidiaries or licensed to it. Patents may be pending.

teknion

shark

multi-use

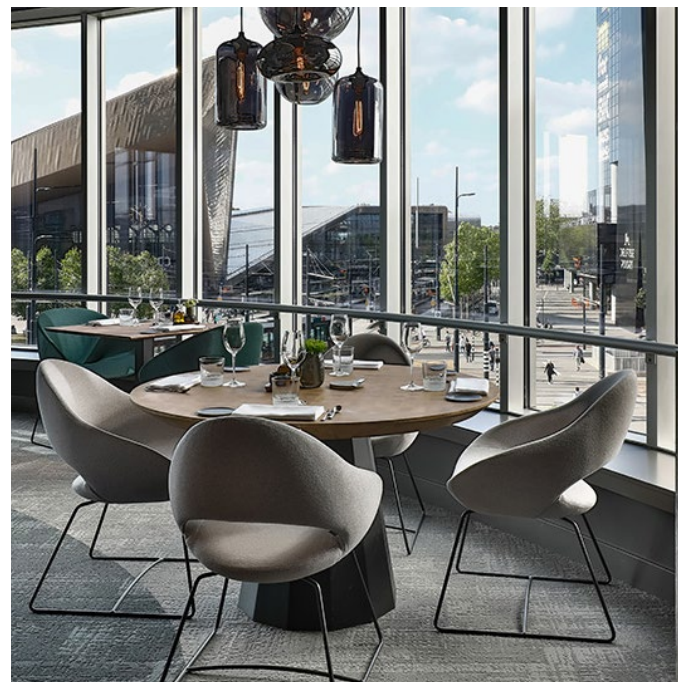

teknion

shark

product description

Shark is a model that acquired its name because its profile resembled that of the feared predator. However, you have nothing to fear from this shark. On the contrary. It's an extremely comfortable chair to sit on. Sturdy with extra back support. A delightful chair for a long evening around the table, or for a productive meeting.

collection



Artifort

fabrics & finishes

Upholstery

Seat can be finished in different fabrics available from LUUM; COM/COL; Selecte; Main Line Flax (Camira); Ox

Wire Base Finishes

Chrome, Powder Coated and Aluminum Polished (tube in Chrome) finishes

dimensions

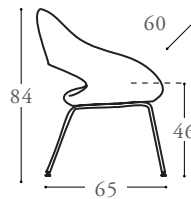

EARSHRK1
Shark Chair 4 Legged

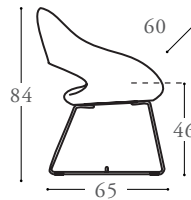

EARSHRK2
Shark Steel Wire Sled

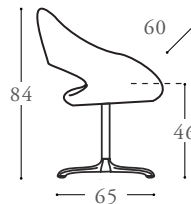

EARSHRK3
Shark Chair Cross Base Non-Swiveling

www.teknion.com

MY 10-24

© Teknion 2024

®, ™ trade marks of Teknion Corporation and/or its subsidiaries or licensed to it. Patents may be pending.

teknion

tables

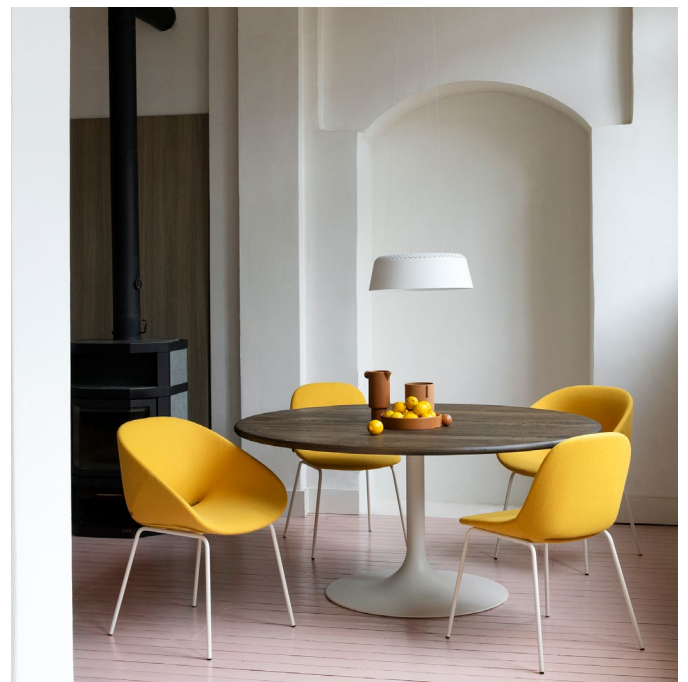

clarion

product description

The Clarion dining table is composed as a medley that creatively combines two archetypal trumpet bases and a steel tube, together capable of supporting a table top. The central position of the round base gives your maximum freedom of movement. The milled edge table top of Clarion is available in various shapes: round, oval or boat-shaped. The Clarion program is comprised of conference tables, dining tables, bistro tables, counter and bar tables and a series of lower tables. Clarion offers multiple options in size, colour, materials and finishes. Combine Clarion with an elegant chair, an inviting barstool or even with luxurious conference armchairs.

Artifort

fabrics & finishes

Table Top Finishes

Material A: 2.4cm plywood
Top Coat: Laminate Arpa Fenix
Finishing Edge: Belly Milled

Material B: 2.4cm plywood
Top Coat: Oak Veneer with standard oil finish
Finishing Edge: Belly Milled

Material C: 2.5cm solid oak
Top Coat: Transparent lacquered (B20) or black stained (B11) or in a standard oil finish
Finishing Edge: Belly Milled

Material D: 1.2cm compact
Top Coat: Arpa Fenix
Finishing Edge: Belly Milled

collection



dimensions

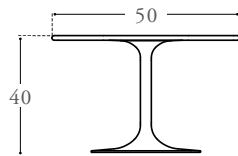

EARCLLC
Clarion Low Coffee Table, Round
Height 40cm

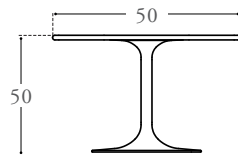

EARCLLS
Clarion Low Side Table, Round,
Height 50cm

www.teknion.com

MY 10-24

© Teknion 2024

®, ™ trade marks of Teknion Corporation and/or its subsidiaries or licensed to it. Patents may be pending.

teknion

easy boy

occasional



teknion

easy boy

product description

Easy Boy is the table for every environment where it is useful to have a stable support. Solid steel frame with a soft shape and dimensions designed specifically to be combined with armchairs and sofas. Available in three heights and in various colours, from the most sedate to the most lively.

collection



segis

fabrics & finishes

Frame and Top Finish

Powder Coated Finishes

dimensions



ET0042
Easy Boy Table by Segis
Height 40cm



ET0041
Easy Boy Table by Segis
Height 53cm



ET0040
Easy Boy Table by Segis
Height 62cm

www.teknion.com

MY 10-24

© Teknion 2024

®, ™ trade marks of Teknion Corporation and/or its subsidiaries or licensed to it. Patents may be pending.

teknion

hotel

occasional

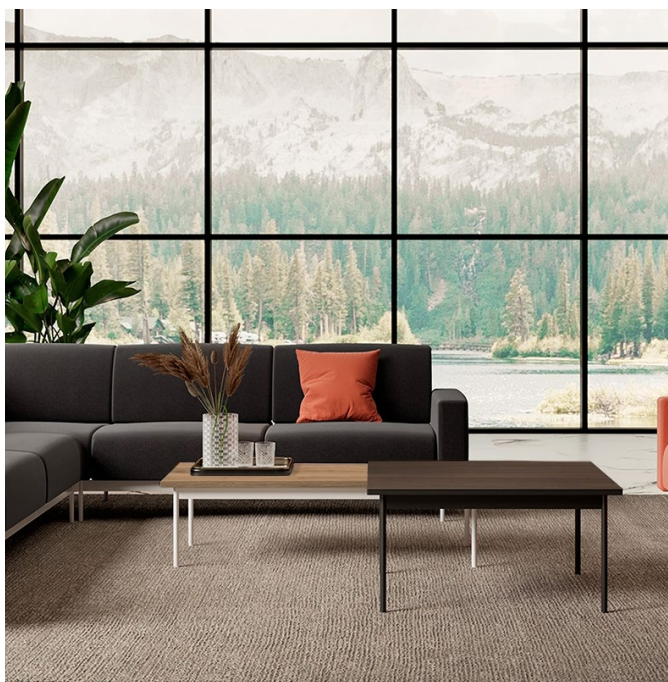

teknion

hotel

product description

Hotel is a modular seating system characterized by a strong expressive versatility conceived for fluid, linear, and angular combinations. Comfortable pieces designed for enjoyable relaxation and conviviality. The collection includes two and three seater sofas plus an armchair; armrest options include an upholstered armrest in two sizes and a tablet arm for computer or other support. Joining tables between the seats or multifunctional tables complete the collection.

segis

fabrics & finishes

Frame Finish

Powder Coated Finishes

collection



dimensions

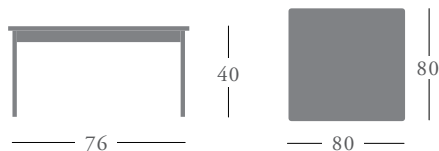

EIMT5
Hotel Small Table 80x80cm H.40cm
(HPL Laminate)

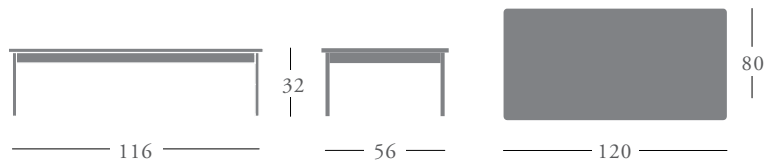

EIMT6
Hotel Small Table 120x60cm H.32cm
(HPL Laminate)

www.teknion.com

MY 10-24

© Teknion 2024

®, ™ trade marks of Teknion Corporation and/or its subsidiaries or licensed to it. Patents may be pending.

teknion

mare

occasional



teknion

mare

product description

A sleek coffee table for a sleek sofa. The Mare T is developed especially as table to match sofas of the Mare sofa program (Mare loose cushion and Mare fixed cushion). Typical of this design is the slender base, which runs from back to front. Mare T is available with a square or rectangular table top. The top is veneered or solid oak and the base is made of polished stainless steel or powder coated.

collection



Artifort

fabrics & finishes

Surface Finish

Veneer and Solid Oak in Oil Finish

Base Finish

Stainless Steel

dimensions

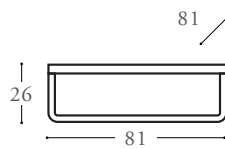

EARMARET1
Mare Table (81 x 81cm)

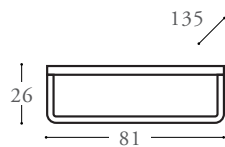

EARMARET3
Mare Table (135 x 81 cm)

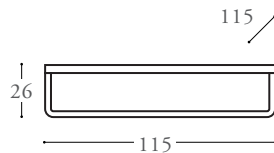

EARMARET2
Mare Table (115 x 115 cm)

www.teknion.com

MY 10-24

© Teknion 2024

®, ™ trade marks of Teknion Corporation and/or its subsidiaries or licensed to it. Patents may be pending.

teknion

samu

occasional



teknion

samu

product description

System of tables and low tables to meet all needs in the contract environment. Different models with either four-spoke or two-spoke bases can be combined with various tabletops. The linear design of the bases, available in three heights, are made in steel profile powder coated in the new black nickel and bronze finishes as well as in a range of various colours. Decorative ceramic tops in different finishes, laminate on plywood, or HPL provide endless style possibilities.



fabrics & finishes

Frame Finish

Powder Coated Finishes

collection



dimensions

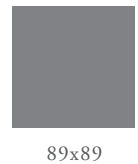

ET0106

Samu Table Base 4 Spokes with Die Cast Alum Fixing Plate

Table Top

Round: Diameter 59 – 119cm

Square: 69x69cm – 99x99cm

Rectangular: 120x79cm, 140x79cm, 180x79cm

www.teknion.com

MY 10-24

© Teknion 2024

®, ™ trade marks of Teknion Corporation and/or its subsidiaries or licensed to it. Patents may be pending.

teknion

beso

casual



teknion

beso

product description

The Beso Table collection matches the Beso chair programme, consisting of a series of tables with rectangular or round tops with an elegant and sculptural base. Clever positioning of the four table legs mean users have considerable freedom of movement, creating extra chair space along the long side or at the head of the table. The construction beam matches the table top or the colour of the base and provides the accent and character of the design. The metal legs swing open to the left and right of the beam, so the construction supports the table well.

Artifort

fabrics & finishes

Table Top Finishes

Material A: 2.4cm plywood
Top Coat: Laminate Arpa Fenix
Finishing Edge: Chamfered Edge

Material B: 2.4cm plywood
Top Coat: Oak Veneer with standard oil finish
Finishing Edge: Chamfered Edge

Material C: 2.5cm solid oak
Top Coat: Transparent lacquered (B20) or black stained (B11) or in a standard oil finish
Finishing Edge: Chamfered milled, finished as top coat

Material D: 1.2cm compact
Top Coat: Arpa Fenix
Finishing Edge: Double Chamfered

collection



dimensions

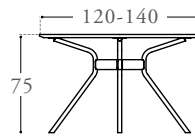

EARBSTC
Beso Round Table Height 75cm

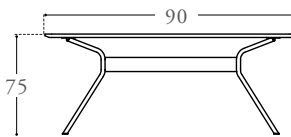

EARBSTRD
Beso Rectangle Table, Height 75cm, Depth 90cm

www.teknion.com

MY 10-24

© Teknion 2024

®, ™ trade marks of Teknion Corporation and/or its subsidiaries or licensed to it. Patents may be pending.

teknion

boom

casual



teknion

boom

product description

Boom Collection brings together in a single series the iconic tables in their round, square and rectangular versions. Base, column and top can be round or square and combine with each other without constraints. Tops are available in various materials and sizes; bases and columns in high-strength steel may be in powder coat, chrome, or brushed stainless. The height can be fixed or adjustable with gas lift. Essential and extremely functional, Boom is perfect for both performing and comfortable spaces.

segis

fabrics & finishes

Leg Finish

Powder Coated, Chrome Finish, Brushed Stainless Steel, Grey Galvanic, Flax Galvanic and Cider Galvanic

collection



dimensions

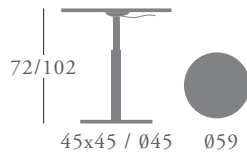

ET0645R
45cm Round Base, with Gas Adjustable-Height 72/102cm, Column 60mm, Metal Fixing Plate

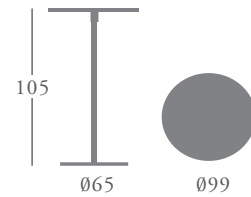

ET0647
65 cm Round Base, h.105cm, Column 80 mm, Die-cast Fixing Plate

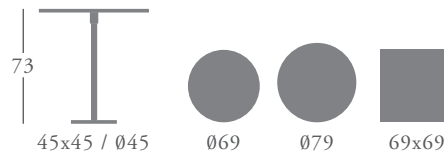

ET0645P
45cm Round Base, h.73cm, Column 60mm, Tecnpolymer Fixing Plate

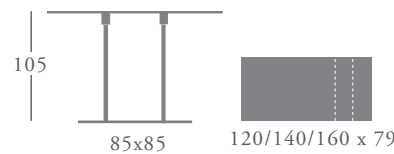

ET0646B
85x45cm Base, h.105 cm, Column 60mm, Tecnpolymer Fixing Plates

Table Top

Round: Diameter 59 – 119cm
Square: 69x69cm – 99x99cm
Rectangular: 120x79cm, 140x79cm, 180x79cm

www.teknion.com

MY 10-24

© Teknion 2024

®, ™ trade marks of Teknion Corporation and/or its subsidiaries or licensed to it. Patents may be pending.

teknion

clarion

casual

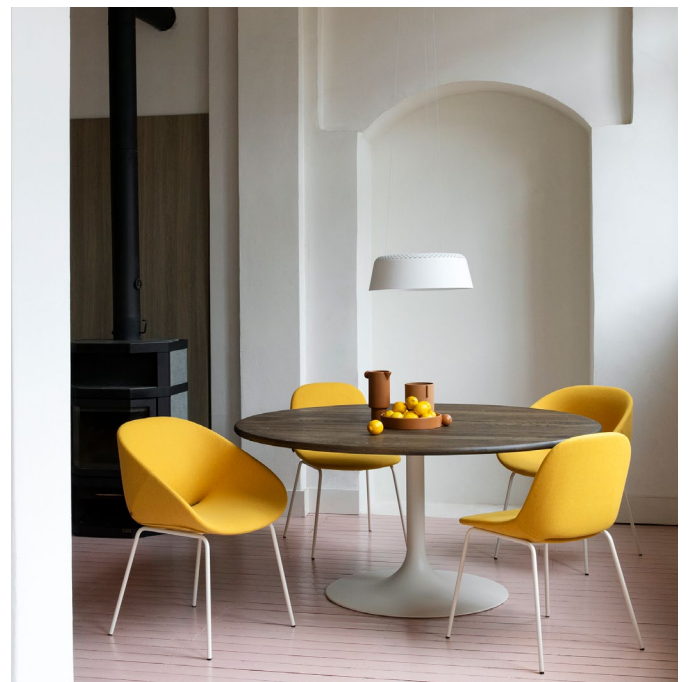

teknion

clarion

product description

The Clarion dining table is composed as a medley that creatively combines two archetypal trumpet bases and a steel tube, together capable of supporting a table top. The central position of the round base gives your maximum freedom of movement. The milled edge table top of Clarion is available in various shapes: round, oval or boat-shaped. The Clarion program is comprised of conference tables, dining tables, bistro tables, counter and bar tables and a series of lower tables. Clarion offers multiple options in size, colour, materials and finishes. Combine Clarion with an elegant chair, an inviting barstool or even with luxurious conference armchairs.

Artifort

fabrics & finishes

Table Top Finishes

Material A: 2.4cm plywood
Top Coat: Laminate Arpa Fenix
Finishing Edge: Belly Milled

Material B: 2.4cm plywood
Top Coat: Oak Veneer with standard oil finish
Finishing Edge: Belly Milled

Material C: 2.5cm solid oak
Top Coat: Transparent lacquered (B20) or black stained (B11) or in a standard oil finish
Finishing Edge: Belly Milled

Material D: 1.2cm compact
Top Coat: Arpa Fenix
Finishing Edge: Belly Milled

www.teknion.com

MY 10-24

© Teknion 2024

®, ™ trade marks of Teknion Corporation and/or its subsidiaries or licensed to it. Patents may be pending.

collection



dimensions

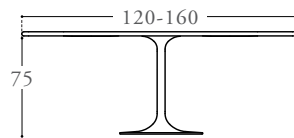

EARCLMR
Clarion Medium Round, Height 75cm

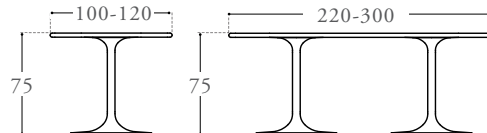

EARCLBSA
Clarion Medium Boat Shaped, Height 75cm, 2x Disc Diameter

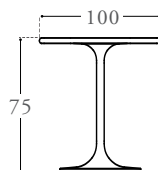

EARCLHCA
Clarion High Counter Table, Round Height 90cm

dock

casual

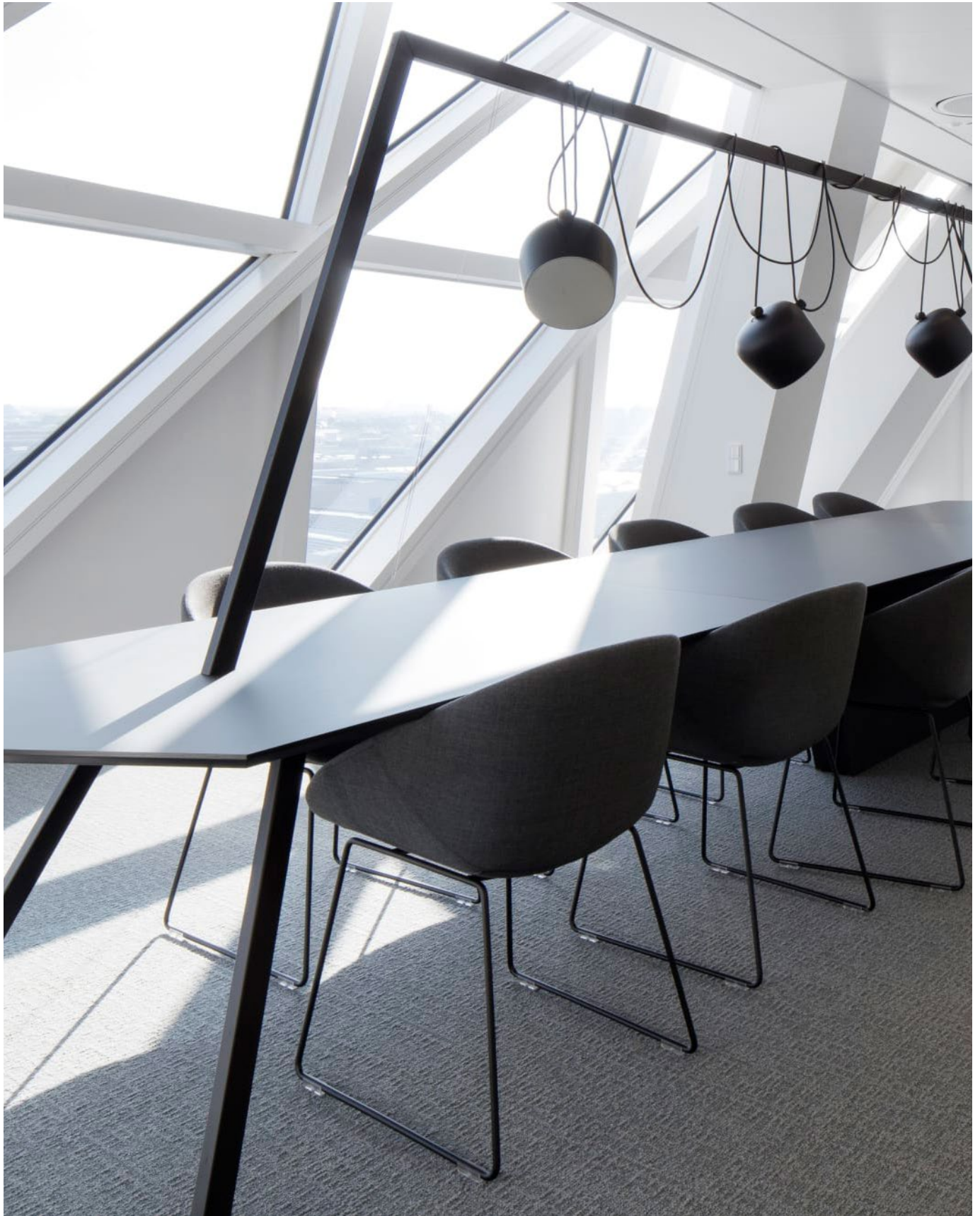

teknion

dock

product description

Table with frame and lamps

Dock is a stylish long wooden table with a steel frame that runs above the table. Several lamps can be attached to the frame. The combination of the frame and the lamps above the table creates an intimate atmosphere.

Table with lights

Dock is ideal as a table in a library or landing table in an office. For example in a building where no lamps can be attached to the ceiling. Or high industrial areas where the lighting is not sufficient. The first stylish black Dock tables already shine in the offices of the Port House in Antwerp. "As the name suggests, the table is inspired by a jetty", explains designer Kurt van Overbeke. "Dock is designed for the Antwerp Port House. The company is responsible for mooring boats from all over the world. Mooring is also the function that Dock has within the office. A place where people come to start their workday. The first start-up meeting.

collection



fabrics & finishes

Tabletops Finishes

Material A: 24mm plywood,
Laminate B, Chamfered Edge

Material B: 24mm plywood,
Laminate C, Chamfered Edge

Material C: 24mm plywood,
Veneer, Chamfered Edge

Material D: 24mm plywood,
Veneer F06, Chamfered Edge

Base Finishes

Powder Coated Finishes

www.teknion.com

MY 10-24

© Teknion 2024

®, ™ trade marks of Teknion Corporation and/or its subsidiaries or licensed to it. Patents may be pending.

dimensions

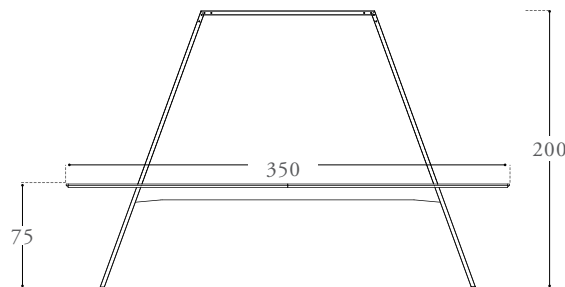

ELDDK1
Rectangle Table, Height 75cm

samu

casual



teknion

samu

product description

System of tables and low tables to meet all needs in the contract environment. Different models with either four-spoke or two-spoke bases can be combined with various tabletops. The linear design of the bases, available in three heights, are made in steel profile powder coated in the new black nickel and bronze finishes as well as in a range of various colours. Decorative ceramic tops in different finishes, laminate on plywood, or HPL provide endless style possibilities.

segis

fabrics & finishes

Frame Finish

Powder Coated Finishes

collection



dimensions

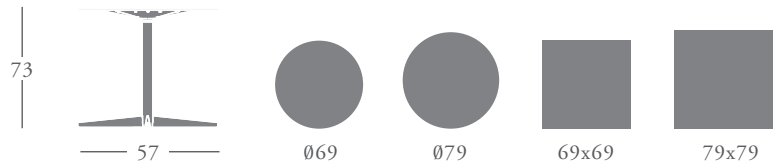

ET0105P

Samu Table Base 4 Spokes, Height 73cm

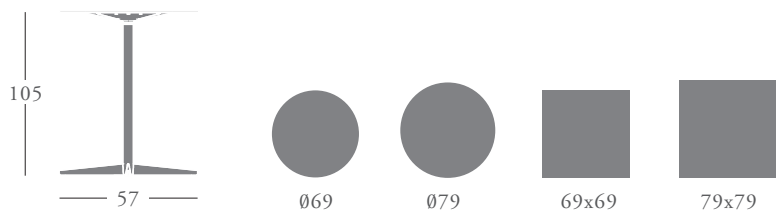

ET0105B

Samu Table Base 4 Spokes, Height 105cm

Table Top

Round: Diameter 59 – 119cm

Square: 69x69cm – 99x99cm

Rectangular: 120x79cm, 140x79cm, 180x79cm

www.teknion.com

MY 10-24

© Teknion 2024

®, ™ trade marks of Teknion Corporation and/or its subsidiaries or licensed to it. Patents may be pending.

teknion

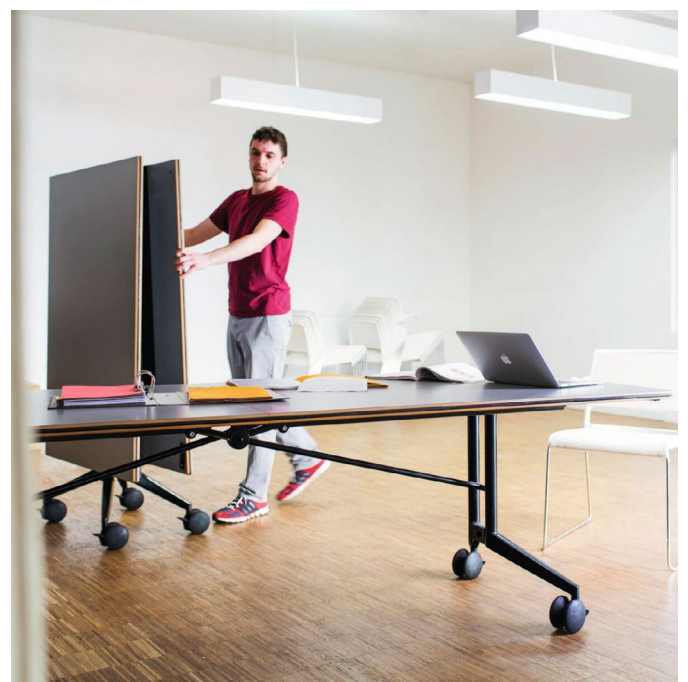

confair

product description

Confair folding tables make versatile usage of cleverly designed conference and meeting areas child's play. Only one single person is required to set up and rearrange the movable folding tables – without any tools, releasing or unlocking procedures or special skills involved. Snap connectors allow the tables to be linked in any direction. If partitions are used to divide up rooms, conference or project work tables can be transformed into a large conference layout in no time.

collection



Wilkhahn

fabrics & finishes

Top Surface (basic)

Laminex, Solid Colour

Top Surface (standard)

Laminex, Woodgrain

Under frame

Steel, Black Coated

Frame Upright

Tubular Steel, Black Coated

Foot Sections (basic)

Aluminium, Black Coated

Foot Sections (standard)

Aluminium, Polished

dimensions

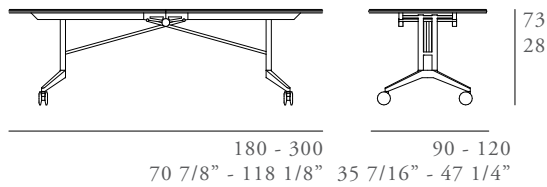

E440-00B
Confair Table Basic

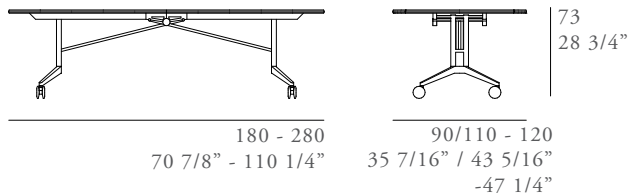

E440-00S
Confair Table Standard

www.teknion.com

MY 10-24

© Teknion 2024

°, ™ trade marks of Teknion Corporation and/or its subsidiaries or licensed to it. Patents may be pending.

teknion

dock

work

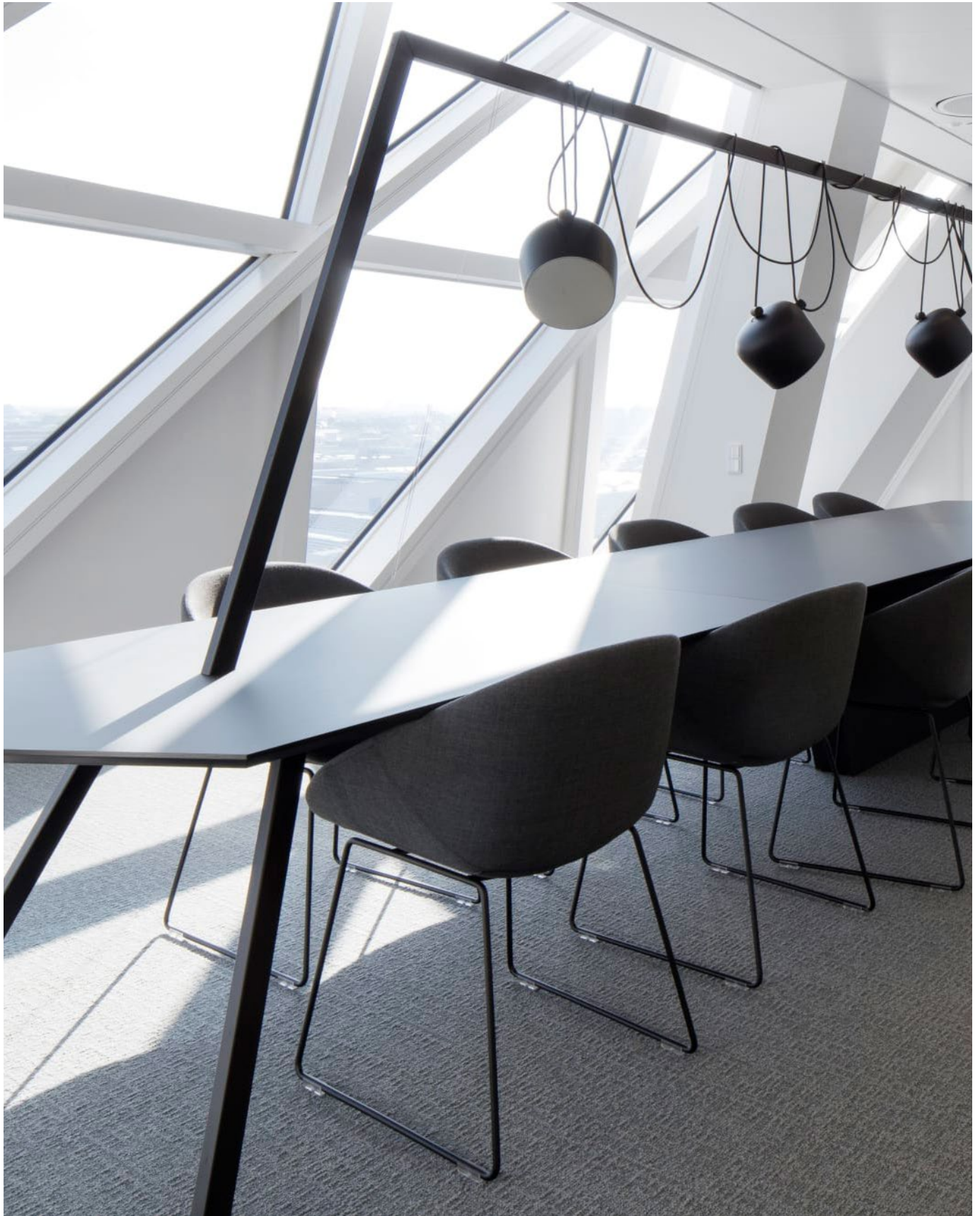

teknion

dock

product description

Table with frame and lamps

Dock is a stylish long wooden table with a steel frame that runs above the table. Several lamps can be attached to the frame. The combination of the frame and the lamps above the table creates an intimate atmosphere.

Table with lights

Dock is ideal as a table in a library or landing table in an office. For example in a building where no lamps can be attached to the ceiling. Or high industrial areas where the lighting is not sufficient. The first stylish black Dock tables already shine in the offices of the Port House in Antwerp. "As the name suggests, the table is inspired by a jetty", explains designer Kurt van Overbeke. "Dock is designed for the Antwerp Port House. The company is responsible for mooring boats from all over the world. Mooring is also the function that Dock has within the office. A place where people come to start their workday. The first start-up meeting.

collection



dimensions

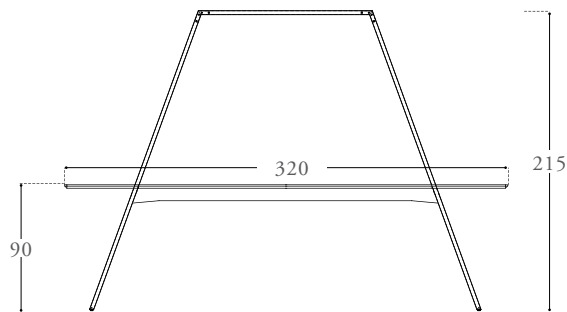

ELDDK2
Dock Rectangle Table, Height 90cm

fabrics & finishes

Tabletops Finishes

Material A: 24mm plywood,
Laminate B, Chamfered Edge

Material B: 24mm plywood,
Laminate C, Chamfered Edge

Material C: 24mm plywood,
Veneer, Chamfered Edge

Material D: 24mm plywood,
Veneer F06, Chamfered Edge

Base Finishes

Powder Coated Finishes

www.teknion.com

MY 10-24

© Teknion 2024

®, ™ trade marks of Teknion Corporation and/or its subsidiaries or licensed to it. Patents may be pending.



timetable

product description

Timetable's table tops flip up in one easy step and the foot sections turn inward in the process. As a result, they're easy to move from room to room and nest very compactly into one another. Intuitive handling, exceptional quality and a strong aesthetic inspire a change of methods and save resources, time and space. The exceptionally hard-wearing Timetable Smart with its power solutions has uncovered further usage potential and found its way into hot desking, training and project spaces. The frame design of its big brother (Timetable Shift) means it can be combined perfectly with Confair folding tables and Logon tables. The U-shaped aluminum profile to help connect the legs also provides a spacious cable channel at the same time. Timetable comes in lots of different formats, shapes, edges and surfaces.

collection



Wilkhahn

fabrics & finishes

Top Surface (Basic)

Pre-laminated Board

Top Surface (Standard)

Laminex Commercial Range

Under frame

Steel, Black Coated

Frame Upright

Tubular Steel, Black Coated

Foot Sections (Basic)

Aluminium, Black Coated

Foot Sections (Standard)

Aluminium, Polished

dimensions

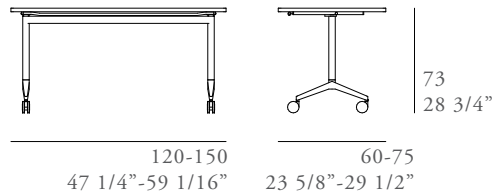

E612-00B
Timetable Smart Basic

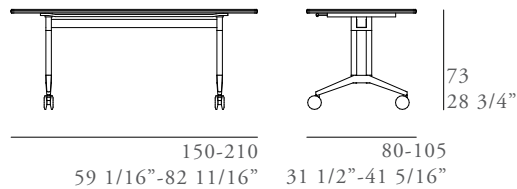

E614-00B
Timetable Shift Basic

www.teknion.com

MY 10-24

© Teknion 2024

®, ™ trade marks of Teknion Corporation and/or its subsidiaries or licensed to it. Patents may be pending.

teknion

wing

work

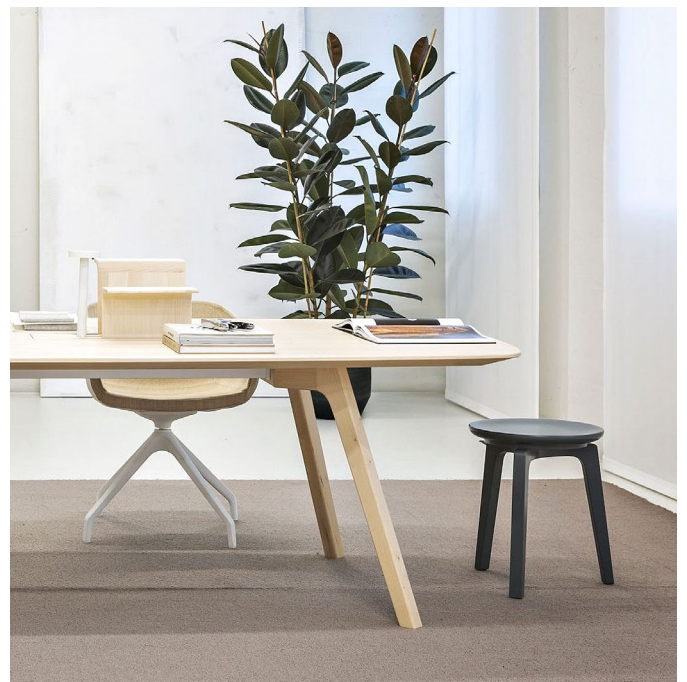

teknion

wing

product description

WING is a table created for working areas, but it can also fit inside a home-office or domestic environment. It is characterized by a wooden frame inspired by the sawhorse of the working tables, and the rounded shape of the top with its contemporary lines. Defined by great flexibility, WING can be completed with acoustic panels, a brass reading lamp and wooden or metal trays that are installed on the large central channel through a magnetic fixing system. Power supply and cable management are allocated on the same central channel.

true

fabrics & finishes

Surface & Leg Finishes (Working Table)

Laminate Plywood + Beechwood Legs
Laminate Plywood + Solid Oakwood Legs
Laminate Plywood + Steel Legs

Surface & Leg Finishes (Meeting Table)

Black/HPL Top + Solid Oakwood Legs
Full Core HPL/White + Solid Oakwood Legs
Oakwood Top + Solid Oakwood Legs
Walnut Top + Solid Walnut Legs

collection

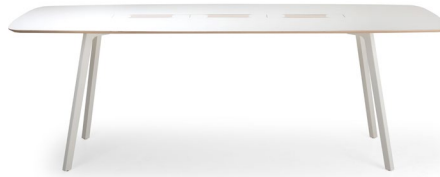

dimensions

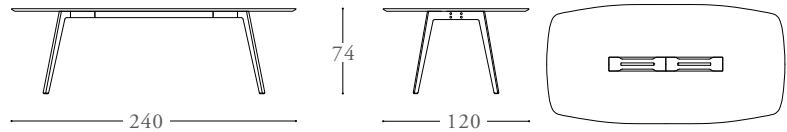

EWI240
Wing Working Table 240 x 120cm

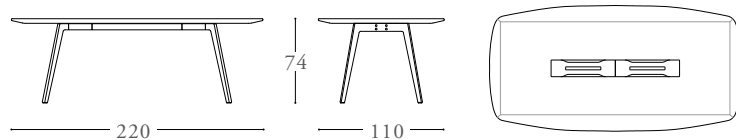

EWI220
Wing Meeting Table 220 x 110 x 74cm

www.teknion.com

MY 10-24

© Teknion 2024

®, ™ trade marks of Teknion Corporation and/or its subsidiaries or licensed to it. Patents may be pending.

teknion

