

district

price & application guide

05.23.2022



teknion

update summary

Please be advised that information has been updated within the District Price & Application Guide. To highlight these updates, a summary has been created for your reference.

revised

- All Seamless finishes have been removed from all relevant pages.

Please note, first orders for new products will be accepted on May 23, 2022. All software will also be updated by May 23, 2022. If you have any questions regarding the information enclosed, please contact your Teknion Customer Service Representative.





WHAT IS DISTRICT 6

INDEX 12

APPLICATION GUIDE 19

PRICE & PRODUCT GUIDE. 361

what is district

what is district

District responds to a new generation of architecture and employees, combining elements of classic furniture with the functionality of systems furniture. Two key features define District.

more out of small spaces

- As workstations become smaller, there is a need to maximize the use of every volume

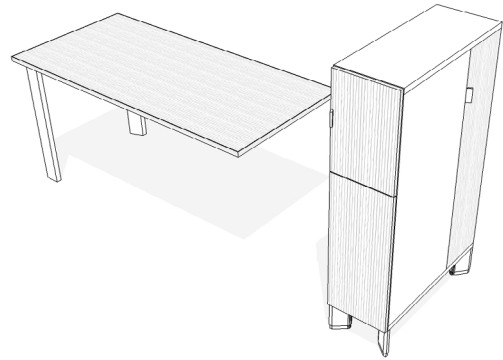
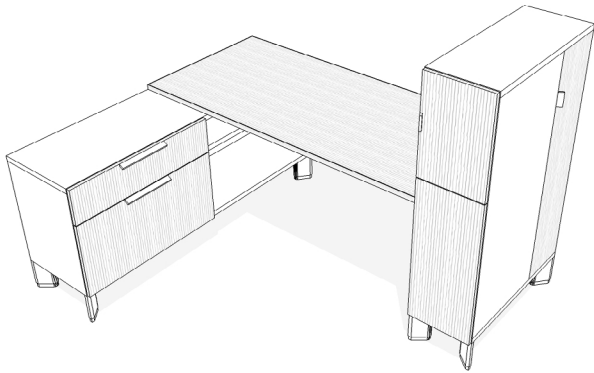

layering

- Worksurfaces and credenzas overlap
- Shelves and lower cubbies allow for storage in otherwise unusable areas

furniture pieces with multiple functions

- Towers and lockers are used for support of worksurface, binder storage, waste sorting, coat storage, and space division

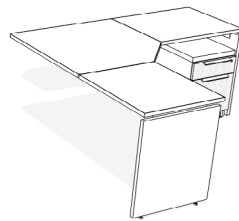
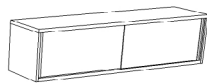
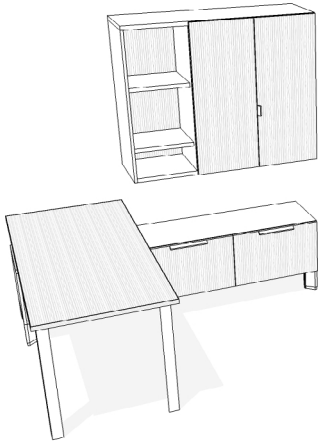

District

Conventional System Layout

re-appropriation of surfaces and volumes

- Equal or greater capacity and performance can be achieved with less conventional layouts
- Emphasis on increasing the primary worksurfaces and decreasing the secondary worksurface depth
- Flat screen monitors and laptops reduce the need for corner worksurface

what is district (continued)

furniture look & feel

- Users are moving to workspaces that have a more furniture like feel, but still require adequate storage and power capacity

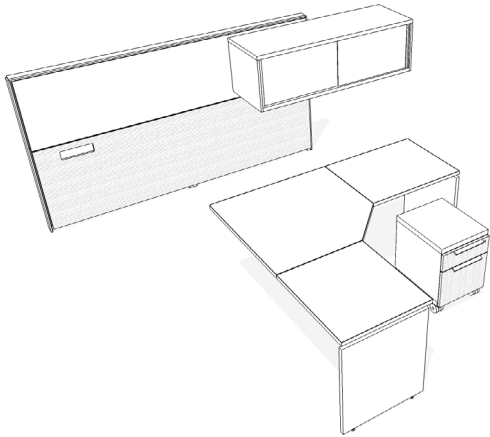

conventional system components

- Individual freestanding or semi-supported pieces of furniture rather than components add to this look

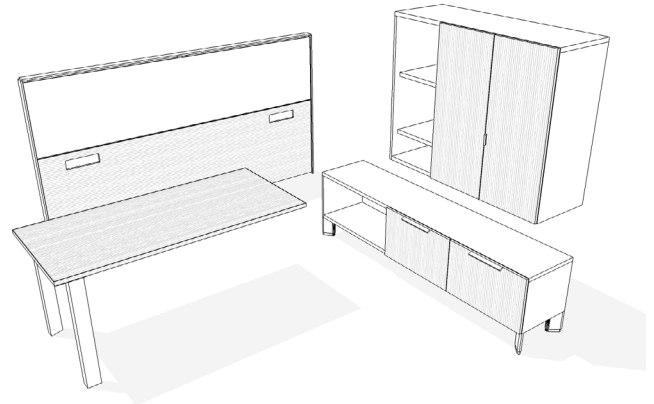

district furniture pieces

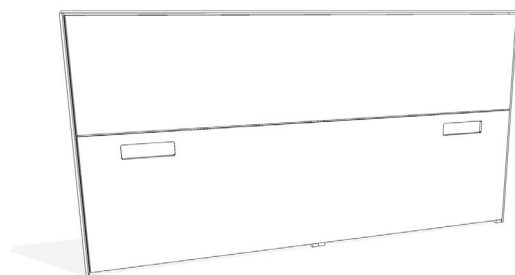

district focuses less on panels for space division

- Panel walls are typically not used to enclose entire stations, but are used as a conduit for technology

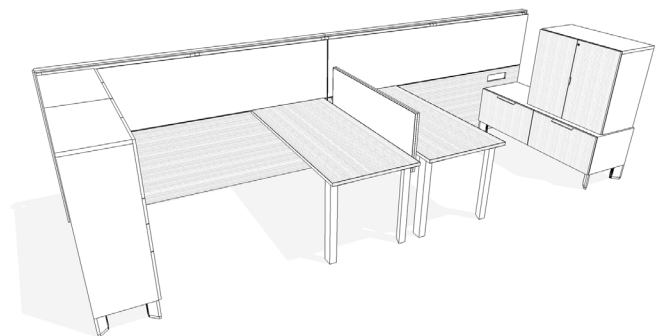

- Storage is utilized in place of panel walls optimizing planning possibilities and price competitiveness

district workstation typicals

The following examples demonstrate the versatility of District to create various workstation types, from storage based spine planning, bench planning, traditional systems planning and freestanding offices.

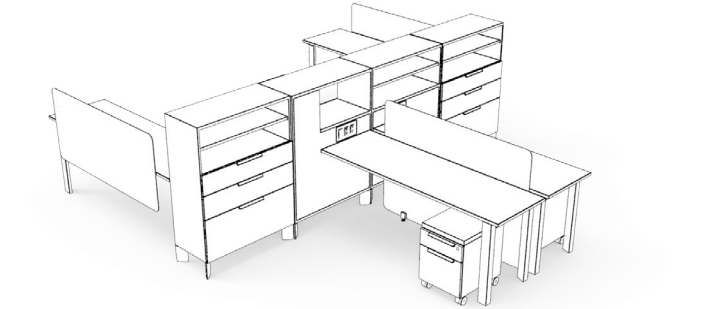

storage spine

- combo towers can provide space division and power/communications distribution without the use of panels
- cabinets can be placed in either direction, and have the option to be the full desired height or made up of stacked components for maximum flexibility
- cabinets are available with coat storage, filing and open cabinets for variable privacy
- power is available above or below desk level on some products
- accessories such as tackboards can be mounted to the backside of storage components
- District worksurfaces mount directly to the storage without the need for legs, to create a clean aesthetic

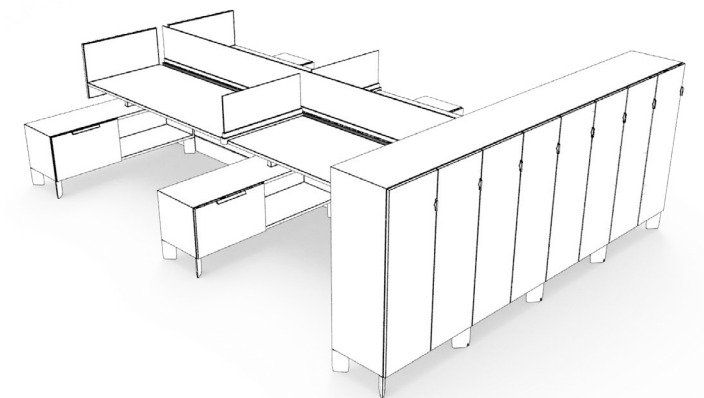

shared address benching

- desk height panels provide power/communication distribution below desk height level to provide a clean aesthetic
- glass screens between worksurfaces and desk edge screens provide territorial privacy
- workstations can be shared by a number of users, so lockers can provide individual storage
- seat cushions can provide temporary seating for guests

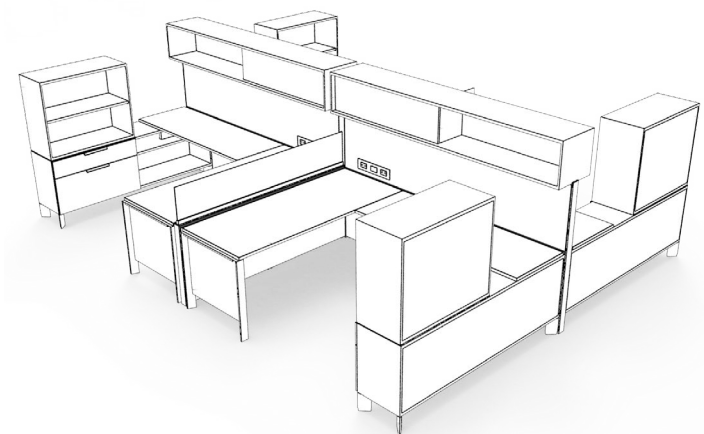

collaborative open plan

- space division is provided by a combination of 42" high panels and storage
- 42" high panels enhance the functionality of the workstation by providing above worksurface power and accessory rails
- narrow depth return worksurfaces and storage add to the spaciousness of small workstations
- storage formats are available for closed and open storage combinations, and are available with wood, laminate and glass options

district workstation typicals (continued)

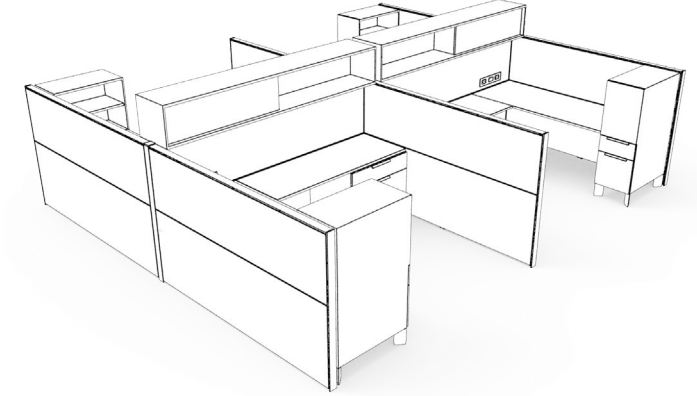

conventional workstation

- District can be planned in a more traditional way where panels provide the space division
- fascias are available in solid, wood, metal and fabric finishes to provide varying aesthetics
- storage is available with various foot details, or to the floor for a more traditional appearance
- panels range from 29" high to 66" high depending on the amount of privacy required

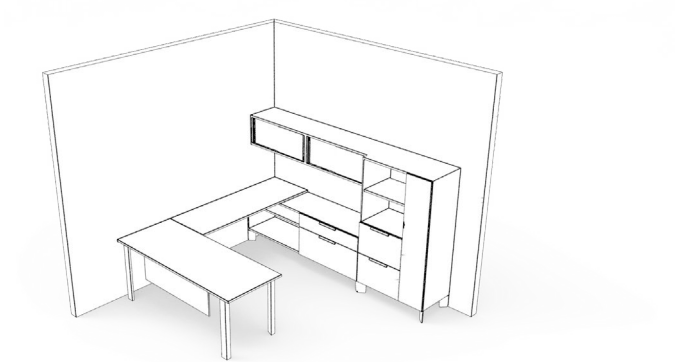

freestanding private office

- private offices can be created using combinations of District worksurfaces and storage
- overhead storage can mount to drywall and Altos
- additional seating requirements can be accommodated with the District seat cushion on credenzas
- the aesthetic of District is maintained with the use of layered worksurfaces and storage, and the use of the semi-suspended end gable, Desk Shelf and the distinct District handle on storage return worksurfaces and storage add to the spaciousness of small workstations
- storage formats are available for closed and open storage combinations, and are available with wood, laminate and glass options

introduction

where to find the information you need

Teknion provides an array of tools and information resources to help you get things done simply and easily. From product pricing to application guidelines to online planning suggestions, you will find what you need when you need it.

guide contents

This guide contains all the information you need to order this product through your specification software. The Introduction section provides everything you need to get started, including an index for product reference. The Application Guide section contains detailed specification guidelines, application and planning information to help you plan your project correctly. The Price Guide sections provide detailed pricing and specification information by product type. Available online at www.teknion.com.

where to find the information you need

All Teknion marketing materials are available online at www.teknion.com, including:

price & product guide

application guide

planning tool

installation guides

fabrics & finishes

product photography & drawings

weights & volumes

order forms

warranty/terms & conditions of sale

xpress program guide

teknion forms

The following forms are available online at www.teknion.com, to help you specify and place your order if required:

teknipaint

If you require a custom paint color match, you must submit a TekniPaint form.

using your own material (COM)

If you wish to use your own material on fabric-covered products, you must submit a completed COM form including a sample upholstery and safety testing. A COM Order Information Sheet must also be submitted. This form captures all relevant ordering and tracking information. A COM Request for Yardage Calculation form may be sent to Teknion for preliminary yardage requirements.

placing a manual order

Complete an Order Cover Sheet with the information we need to fill your order. This is the most important step. If the Order Cover Sheet is not complete and correct, the order may be delayed.

key requirements

If you require that certain pieces share the same locks you will need to specify Set of Keys Alike (SOKL) located in the Price and Product Guide.

user feedback

How is our marketing material working for you?

Feedback from the user is very important to the quality of Teknion's marketing material. We ask that if you have suggestions on how you think we could improve content OR if you have found an error, that you contact your Teknion Technical Services department.

index

Section Contents	Product Code	Page No.
WHAT IS DISTRICT		
What is District		6
District workstation typicals		8
INTRODUCTION		
Where to find the information you need		11
APPLICATION GUIDES		
Understanding panel walls		
Flush panel wall basics		
Elevated panel wall basics		
Convertible panel wall basics		
Panel wall base basics		
Planning with the panel wall rail & light block rail		
Support foot basics		
Planning with panel wall base & foot		
Support foot for freestanding district basics		
Planning with freestanding panels		812
Add-on window basics		813
Planning with add-on windows		814
Full-height window basics		815
Planning with full-height glass panels		816
Understanding fascias		820
Understanding fascias for freestanding district		819
Understanding fascia types		
Fascia basics		822
Planning with fascias		823
Planning with window fascias		824
Planning with power communications fascias on non-freestanding panels		825
Planning with power communications fascias on freestanding panels		825
Understanding power spine		
Power spine basics		
Planning with power spine & panel spine support kit frames		
Planning with power spine electrics		
Power spine lateral floor screens basics		
Planning with power spine lateral floor screens		
Power spine worksurface understanding		
Power spine worksurface and worksurface support basics		
Planning with power spine worksurface		
Planning with power spine rectangle worksurface		
Planning with power spine zig zag panel and worksurface		
Planning with power spine 120 hub and worksurface		
Planning with power spine hiSpace quick connect table		
Understanding screens		826
Desk edge screen basics		
Planning with desk edge screens		
Desktop lateral screen basics		
Desktop screen basics		834

Section Contents	Product Code	Page No.
Modesty screen basics		836
Planning with modesty screens		835
Floor screen basics		832
Planning with floor screens		
Storage screen basics		
Planning with storage screens		
Storage screen typicals		837
Solid lateral screen basics		
End mount lateral screen basics		
Planning with end mount lateral screens		
Panel wall add-on screen basics		
Planning with wall panel add-on screens		828
Glass Blades for panels with inset glass basics		830
Planning with glass blades for panels with inset glass		829
Understanding trims & connectors		
Top trim basics		
End trim basics		
Connector basics		
Connector & trim configurations		
Planning with connectors & trims		
Understanding worksurfaces		
Worksurface basics		
Planning with worksurfaces		
Planning with worksurface gaps		
Planning with small footprint worksurfaces		
Planning with grommets		
Worksurface grain/pattern direction		
Edge trim style overview		
Understanding height-adjustability		
Navigate height-adjustable build-in perpendicular table basics		
Navigate height-adjustable build-in parallel table basics		
Navigate height-adjustable freestanding table basics		
hiSpace height-adjustable build-in perpendicular table basics		
hiSpace height-adjustable built-in parallel table basics		
Planning with height-adjustable tables		
Credenzas for height-adjustable tables overview		
Credenzas for height-adjustable table basics		
Height-adjustable credenza drawer widths		
Planning with credenzas for height-adjustable tables		
Height-adjustable tables with screen overview		
Planning with height-adjustable tables and screens		
Height-adjustable credenza lock chart		
Understanding storage		
Understanding district storage		
Pedestal basics		
Planning with pedestals		

Section Contents	Product Code	Page No.
Stretch pedestal & lateral file storage basics		
Planning with stretch pedestals		
Planning with lateral files		
Bookcase basics		
Credenza basics		
Credenza drawer widths		
Planning with credenzas		
Stacker basics		
Planning with stackers		
Single locker basics		
Planning with single lockers		
Dual, triple & quad locker basics		
Planning with lockers		
Cubby locker basics		
Tower basics		
Planning with towers		
Pedestal tower basics		
Planning with pedestal towers		
Storage-to-storage support basics		
Overhead basics		
Planning with overhead cabinets		
Centermount overhead basics		
Planning with centermount overhead cabinets		
Side Filer & Mini Side Filer Basics		
Planning with Side Filers		
Planning with Mini Side Filers		
Planning with Side Filers & Mini Side Filers		
Planning with Side Filer, Mini Side Filer & USB Power		
Accessory Bundle Basics		
Grain direction		
Lock chart		
Understanding district support		
Worksurface support basics – horizontal		
Planning with worksurface supports – horizontal		
Worksurface support basics – vertical		
Planning with panel-mounted cantilevered supports		
Worksurface support, freestanding basics		
Planning with worksurface supports, freestanding		
Planning with semi-suspended supports		
Worksurface-to-storage support basics		
Planning with worksurface to storage supports		
Storage-to-panel support basics		
Selecting the correct storage-to-panel bracket		
Planning with keyboard trays		
Understanding accessories		

Section Contents	Product Code	Page No.
Storage mounted fascia basics		
Planning with storage mounted fascias		
Screen & panel mounted fascias basics		
Planning with screen-mounted & panel-mounted fascias		
Tower & locker infill basics		
Planning with tower & locker infills		
Seat cushion basics		
Complements accessory basics		
Electrics & communications overview		
Power entry basics – panel-mounted workstations		
Planning with power poles		
Power & communications basics – panel-mounted workstations		
Planning with power boxes & outlets		
Wiring systems		
Power distribution basics – panel-mounted workstations		
Planning with harnesses		
Determining harnesses lengths		
Casual electrics basics – panel-mounted workstations		
Storage electrics basics		
Planning with storage		
Power conservation system basics		
Planning with power conservation system		
International electrics basics		
Planning with international electrics		
PANEL WALLS		
Flush Panel Wall	UNPFR	364
Flush Panel with Inset Glass	UYPFR	365
Elevated Panel Wall	UNPER	366
Elevated Panel Wall with Inset Glass	UYPER	367
Convertible Panel Wall	UNPC	368
Convertible Panel Wall with Inset Glass	UYPCR	369
Add-On Window (D-Style) – Single Glass	UNPWSR	370
Add-On Window (D-Style) – Double Glass	UNPWDR	372
Flush Full-Height Window (D-Style) – Single Glass	UNPFWSR	374
Flush Full-Height Window (D-Style) – Double Glass	UNPFWDR	375
Elevated Full-Height Window (D-Style) – Single Glass	UNPEWSR	376
Elevated Full-Height Window (D-Style) – Double Glass	UNPEWDR	377
Convertible Panel Wall Base and Foot Trim	UNPCF	378
Elevated Panel Wall Foot	UNPEFR	379
Support Foot for Freestanding District	UAFFN	380
Panel Wall Rail	UNPHN	381
Light Block Rail	UNEX	382

index

Section Contents	Product Code	Page No.
FASCIAS		
Solid Fascia	UNESD	388
Solid Fascia For Freestanding District (Clip Mount)	UAESD	390
Stretch Solid Fascia	UNYSD	392
Stretch Solid Fascia for Freestanding District	UAYSD	394
Solid Fascia – Full-Height	UNESF	396
Metal Fascia	UNELM	398
Metal Fascia For Freestanding District (Slot Mount)	UAELM	400
Tackable Fabric Fascia	UNELF	402
Tackable Fabric Fascia For Freestanding District (Slot Mount)	UAELF	406
Whiteboard Fascia	UNEMB	408
Accessory Fascia	UNELA	409
Solid Power/Communications Fascia	UNECL	410
Solid Power/Communications Fascia For Freestanding District (Clip Mount)	UAECL	414
Solid International Power/Communications Fascia	UNEIL	416
Solid International Power/Communications Fascia For Freestanding District (Clip Mount)	UAEIL	426
Metal Power/Communications Fascia	UNELCM	430
Metal Power/Communications Fascia For Freestanding District (Slot Mount)	UAELCM	434
Metal International Power/Communications Fascia	UNELIM	436
Metal International Power/Communications Fascia For Freestanding District (Slot Mount)	UAELIM	444
Tackable Fabric Power/Communications Fascia	UNELCF	448
Tackable Fabric Power/Communications Fascia For Freestanding District (Slot Mount)	UAELCF	454
Tackable Fabric International Power/Communications Fascia	UNELIF	456
Tackable Fabric International Power/Communications Fascia For Freestanding District (Slot Mount)	UAELIF	474
Metal Base Feed Fascia	UNELMB	480
Metal Base Feed Fascia For Freestanding District (Slot Mount)	UAELMB	481
Fabric Base Feed Fascia	UNELFB	482
Fabric Base Feed Fascia For Freestanding District (Slot Mount)	UAELFB	483
Fascia Clip Kit	UNELK	484
POWER SPINE		
Power Spine Panel	UNPZ	490
Power Spine Inset Panel	UYPZ	492
Power Spine Support Kit	UZPK	494
Zig Zag Power Spine Panel	UNZZ	496
Zig Zag Power Spine Inset Panel	UYZZ	497
Zig Zag Support Kit	UZZK	498

Section Contents	Product Code	Page No.
Zig Zag Power Spine Panel	UNYH	500
Power Spine 120 Hub Inset Panel	UZYH	501
Power Spine 120 Hub Support Kit	UZYK	502
Power Spine Lateral Floor Screen Solid	UZSS	504
Power Spine Lateral Floor Screen with Glass	UZSG	508
hiSpace Quick Connect Height-Adjustable Freestanding Table Mechanism for District Power Spine	YSZ	515
Rectangular Height-Adjustable Worksurface with Connection Kit for hiSpace Quick Connect with District Power Spine	WBZ	516
hiSpace Quick Connect Parallelogram Height-Adjustable Freestanding Table Mechanism for District Power Spine	YSB	518
Parallelogram Height-Adjustable Worksurface with Connection Kit for District Power Spine	WBP	519
hiSpace Quick Connect 120 Hub Height-Adjustable Freestanding Table Mechanism for District Power Spine	YST	520
hiSpace Quick Connect 120 Hub Height-Adjustable Freestanding Table Mechanism for District Power Spine	WBT	522
Power Spine Rectangle Worksurface	UZWE	524
Power Spine Rectangle Worksurface Support Bundle	UZWC	526
Power Spine Parallelogram Worksurface	UZWP	528
Power Spine Parallelogram Worksurface Support Bundle	UZWK	530
Power Spine Angled Worksurface	UZWA	532
Power Spine Angled Worksurface Support Bundle	UZWB	534
Power Spine Dual 120 Angled Worksurface	UZWD	535
Power Spine Dual Angled Worksurface Support Bundle	UZDK	536
Power Spine 120 Hub Worksurface	UZWT	537
Power Spine 120 HUB Worksurface Support Bundle	UZWW	538
SCREENS		
Desk Top Casual Screen	UNSDT	546
Desk Edge Screen	UNSD E	547
Desk Edge Screen – Glass	UNSD EG	548
Desk Edge Screen – Full-Height	UNSF DE	550
Desk Edge Screen – Full-Height Glass	UNSF DG	552
Infinity Curved Desk Edge Screen	GXCD	554
Infinity Desk Edge Screen	GXDD	558
Quilted Infinity Desk Edge Screen	GQDD	564
Infinity Side Desk Edge Screen	GXSD	568
Infinity Desk Edge Floor Screen	GXFD	570
Infinity Side Desk Edge Floor Screen	GXED	572
Infinity Screen Alignment Clip	GXCC	573
Framed Desk Edge Screen	GYDD	574
Framed Side Desk Edge Screen	GYSD	578
Framed Desk Edge Floor Screen	GYFD	582
Framed Side Desk Edge Floor Screen	GYED	584
Desk Edge Screen with Glass	GVGD	586
Glass 6mm Lateral Screen	GNGD	588

Section Contents	Product Code	Page No.
Glass 10mm Lateral Screen	GNTD	589
Writable Glass Lateral Screen	GNWD	590
Solid Lateral Screen	GNSD	591
Writable Laminate Lateral Screen	GNLD	592
Infinity Lateral Screen	GNXD	593
Smooth Felt Lateral Screen	GNZD	594
Fabric Lateral Screen	GNVD	595
Metal Lateral Screen	GNMD	596
Modesty Screen	UNSM	597
Floor Screen	UNSF	598
Floor Screen Extended Leveling Kit	UNSF XL	600
Storage Screen	UNSSS	602
Solid Lateral Screen with Glass	UALSG	604
Solid Lateral Floor Screen	UALSS	610
End Mount Lateral Screen Solid with Glass	UNLTG	614
End Mount Lateral Screen Solid	UNLTS	618
Panel Wall Add-On Screen – Solid	UNSPS	620
Panel Wall 10mm Add-On Screen – Glass	UNSPG	621
Panel Wall Add-On Screen – 6mm Glass	UNSPF	622
Panel Glass Blade for Panels with 10mm Inset Glass	UYSPG	623
Panel Glass Blade for Panels with 6mm Inset Glass	UYSPF	624
Bridged Glass Blade for Panels with 10mm Inset Glass	UYSCG	625
Bridged Glass Blade for Panels with 6mm Inset Glass	UYSCF	626
Smooth Felt Add-On	UNSPZ	627
Smooth Felt Blade for Panels with Inset	UYSPZ	628
CONNECTIONS & TRIMS		
Top Trim	UNTT	
Panel Top Trim for Panels with Inset Glass for 6mm or 10mm	UYTT	
Panel Top Trim for Panels with Inset Smooth Felt	UZTT	829
Top Trim – Power Pole Access	UNTTP	
Bridged Top Trim for Panels with Inset Glass for 6mm or 10mm	UYCT	
End Trim	UNTE	
End Trim For Freestanding District	UATE	812
Intermediate End Trim	UNTM	813
Two-Way 90°	UNPCR2	814
Three-Way 90°	UNPCR3	815
Four-Way 90°	UNPCR4	816
Two-Way 180° Spacer	UNPCCR	817
Two-Way Intermediate 90°	UNIC2	818
Three-Way Intermediate 90°	UNIC3	819
Four-Way Intermediate 90°	UNIC4	820
Two-Way Intermediate 180°	UNICC	821
Two-Way 90° Corner Cap for Panels with Inset Glass for 6mm or 10mm	UYPC2	822
Transition Cover	UNTC	823

Section Contents	Product Code	Page No.
Top Trim Cover for Panels with Inset Glass for 6mm or 10mm	UYTC	824
Wall Start	UNPCW	825
WORKSURFACES		
Rectangle Worksurface	UNWR	656
Rectangle with Radius Corners Worksurface	UNWC	660
HEIGHT-ADJUSTABILITY		
Navigate Freestanding Table, Base Only	YAD <small>One Table One Plug</small>	666
Navigate Height-Adjustable Built-in Base - Parallel Planning	YHD <small>One Table One Plug</small>	670
Navigate Height-Adjustable Built-in Base - Perpendicular Planning	YGD <small>One Table One Plug</small>	672
Navigate Height-Adjustable Built-in Gable Base - Parallel Planning	YWD <small>One Table One Plug</small>	674
Navigate Height-Adjustable Built-in Gable Base - Perpendicular Planning	YVD <small>One Table One Plug</small>	676
hiSpaceQuick Connect Height-Adjustable Built-in Base - Perpendicular Planning	YSG	678
hiSpaceQuick Connect Height-Adjustable Built-in Base - Perpendicular Planning	YSP	680
Parallel Rectangular Height-Adjustable Built-in Worksurface, T-Legs	WHD	682
Parallel Rectangular Height-Adjustable Built-in Worksurface, Gable	WHD_	683
Perpendicular Rectangular Height-Adjustable Built-in Worksurface, T-Legs	WLD	684
Perpendicular Rectangular Height-Adjustable Built-in Worksurface, Gable	WLD_	685
Freestanding Table Rectangular Height-Adjustable Worksurface	WBD	686
Perpendicular Rectangular Height-Adjustable Built-in Worksurface with Radius Corners	WMD	690
hiSpace Parallel Rectangular Height-Adjustable Built-in Worksurface	WBF	691
hiSpace Perpendicular Rectangular Height-Adjustable Built-in Worksurface with connection kit for Quick Connect	WBG	692
hiSpace Rectangular Height-Adjustable Built-in Perpendicular Worksurface with Radius Corners	WJE	693
Perpendicular Credenza for Height-Adjustable Table	UPPC	694
Shared Perpendicular Credenza for Height-Adjustable Table	UPCS	696
Parallel Spine Credenza for Height-Adjustable Table	UPSC	698
Parallel Corridor Credenza for Height-Adjustable Table	UPCC	700

index

Section Contents	Product Code	Page No.
STORAGE		
Rolling Pedestal	UPR	714
Rolling Pedestal with Box Drawer & Hinged Door	UPRB	715
Rolling Pedestal with Hinged Door	UPRH	716
Pedestal with Solid Back	UPFD	717
Stretch Pedestal – Elevated	UPSE	718
Stretch Pedestal – Standard	UPSS	720
Lateral File – Standard	UFLS	722
Bookcase – Elevated	UBKE	724
Bookcase – Standard	UBKS	725
Low Full Drawer Credenza – Elevated	ULDE	726
Low Full Drawer Credenza – Standard	ULDS	727
High Full Drawer Credenza – Elevated	UHDE	728
High Full Drawer Credenza – Standard	UHDS	730
Low Open Credenza – Elevated	ULOE	732
Low Open Credenza – Standard	ULOS	733
High Open Credenza – Elevated	UHOE	734
High Open Credenza – Standard	UHOS	736
Low Open with Drawer Credenza – Elevated	ULHE	738
Low Open with Drawer Credenza – Standard	ULHS	740
High Open with Drawer Credenza – Elevated	UHHE	742
High Open with Drawer Credenza – Standard	UHHS	744
Low Double Sliding Door Credenza – Elevated	ULSE	746
Low Double Sliding Door Credenza – Standard	ULSS	747
High Double Sliding Door Credenza – Elevated	UHSE	748
High Double Sliding Door Credenza – Standard	UHSS	744
Open Stacker	UCO	750
Closed Stacker	UCC	754
Closed Stacker with Cubbies	UCB	755
Single Locker with Solid Back	UKSD	756
Single Locker with Side Closet	UKC	758
Cubby Locker	UKN	760
Dual Locker	UKD	762
Triple Locker	UKT	764
Quad Locker	UKQ	766
Lateral Tower – Elevated	UTLE	768
Lateral Tower – Standard	UTLS	772
Combo Tower – Elevated	UTCE	776
Combo Tower – Standard	UTCS	780
Pedestal Tower with Cubby Back	UTDC	784
Pedestal Tower with Solid Back	UTDD	786
Pedestal Tower with Side Closet	UTDK	787

Section Contents	Product Code	Page No.
Side Open Tower	UTW	788
Wide Side Open Tower	UTWW	790
Sliding Door Overhead	UOH	792
Sliding Door Centermount Overhead	UOHC	794
Open Overhead	UOO	796
Open Centermount Overhead	UOOC	798
Side Filer	UTS	800
Mini Side Filer	UTM	802
Linking Bracket	UNSLB	803
Storage Extended Leveling Kit	UNSXL	804
Locker Accessories	UWKA	805
Set of Keys Alike	SOKL	806
SUPPORTS		
End Gable	UNGEN	812
End Gable – Height-Adjustable	UNGEAN	813
Flush End Gable	UNGEF	814
Flush End Gable – Height-Adjustable	UNGEFA	815
Mid Gable	UNGMF	816
Mid Gable – Height-Adjustable	UNGMFA	817
Cantilever	UNLVR	818
Off-Module Cantilever	UNLVFN	819
Off-Module Cantilever for Panels with Accessory Beam	UALVFN	820
Semi-Suspended Gable	UNGSN	821
Semi-Suspended Gable – Height-Adjustable	UNGSAN	822
Leg – Single	UNLGN	823
Leg – Height-Adjustable Single	UNLGA	824
Leg – Pair	UNLGPN	825
Leg – Height-Adjustable Pair	UNLGPA	825
Worksurface Panel Wall Bracket – Pair	UNBP	826
Worksurface Panel Wall Bracket – Height-Adjustable	UNBPA	826
Storage-to-Panel Bracket	UWSPB	827
Worksurface-to-Tower Bracket Kit	UWBT	828
Height-Adjustable Worksurface-to-Tower Bracket Kit	UWBTH	829
Low Credenza-to-Worksurface Support	UNCPWN	830
Reconfigurable Low Credenza-to-Worksurface Support	UWCPWN	831
Flush Plate	UNRF	832
Structural Flush Plate	UNRFS	832
Worksurface Reinforcement Channel	UNRC	833
Mini Leg	UNCLN	834
Centermount Cabinet Support Posts & Trim	UNOPT	835
Centermount Cabinet Support Brackets & Top Trim	UNOBT	836
Side Filer Panel Support Kit	UWSPK	837

Section Contents	Product Code	Page No.
ACCESSORIES		
Standing Storage Fascia	UNPSF	842
Stacking Storage Fascia	UNPSS	846
Tackboard – Screen Mount	UNTBS	850
Whiteboard – Screen Mount	UNTBW	852
Tackboard – Panel Wall Mount	UNTBP	854
Single Locker with Cubby Infill	UKSCIS	856
Lateral Tower Infill	UTLXIS	858
Combo Tower Infill	UTCXIS	860
Source Laminate Combo Tower Infill	UTCXIX	864
Pedestal Tower with Cubby Infill	UTDCIS	867
Seat Cushion	UWLC	868
Fitted Seat Cushion	UWLF	869
Tool Kit	UNTK	870
Accessory Bundle	UNAB	871
Side Filer Boot Tray	UNBW	872
ELECTRICS		
Power Box	UNQPR	878
Receptacle Outlet	UNQRO	879
Power Harness	UNQBHR	880
Base Feed	UNQBFR	881
Split Base Feed	UNQBFSR	882
Ceiling Feed	UNQCFR	883
Power Pole	UNQEP	884
End of Run Power Pole	UNQEPR	885
Cable Trough	UNQCT	886
Vertical Cable Manager	UNVC	887
Casual Wire Manager Kit	ZOEWM	888
Data Extender Plate	UNQDE	889
Chicago Power Box	UNQPRCH	890
Chicago Base Feed	UNQBFRCH	891
Chicago Ceiling Feed	UNQCFRCH	892
Under Cabinet Wire Tray	EWWT	893
Storage Base Feed	EWBF	894
Storage Chicago Base Feed	EWBFCH	895
Storage Split Base Feed	EWBFS	896
Storage Ceiling Feed	EWCF	897
Storage Chicago Ceiling Feed	EWCFCH	898
Storage Power Harness	EWBH	899
4-Way Splitter	EWDB	900
I-Connector	EWIC	900
Flush Mount Power & Data	EWQP	901
Chicago Flush-Mounted Power Box	EWQPCH	902

Section Contents	Product Code	Page No.
Storage Receptacle Outlet	EWRO	903
Cubby Power Monument	EWQPM	904
Chicago Cubby Power Monument	EWQPMCH	905
Storage Power Pole	EWEP	906
Power Conservation System	UNQPC	907
Diecast Grommet	UNDG	908
INTERNATIONAL ELECTRICS		
Outlet Box	VED	914
Interconnecting Power Cable	VCC	915
Input Power Cable	VEP	916
Voice & Data Box	VVD	917
Voice & Data Outlets	VDO	918
Electric Accessories	VAC	919
Screen Mount Outlet Box Bracket	UNXSE	920
Base Feed Mounting Kit	UNXPFR	920
Panel Mount Outlet Box Bracket	UNXBR	921
CALA Power Module	VBCD	922
CALA Power In Feed	VBPD	923
CALA Jumper Power Harness	VBPH	924
CALA Power Station	VBWB	925

application guide

application guide

PANEL WALLS	23
FASCIAS	41
POWER SPINE	65
SCREENS	105
CONNECTIONS & TRIMS	155
WORKSURFACES	167
HEIGHT-ADJUSTABILITY	179
STORAGE	215
SUPPORTS	295
ACCESSORIES	319
ELECTRICS	331
INTERNATIONAL ELECTRICS	353

understanding application guide pages

This application guide will include the following types of pages.

application guides
understanding panel walls

District Panels are available in three Panel Styles: Standard Panel Wall, Panel Wall with Inset Glass and Panel Wall with Accessory Beam. Each Panel Style is available in three Panel Profiles: Flush, Elevated and Convertible.

panel profiles

- Flush, which provides privacy to the floor
- Elevated, which provides a 6" high open space at the bottom of the panel to allow air flow and a lighted aesthetic
- Convertible, which provides a economical alternative to the Flush and Elevated Panel and allows the flexibility to convert from a Flush Panel Profile to an Elevated Panel Profile using the same frame.

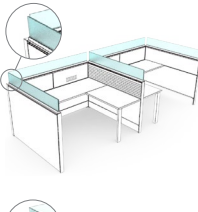

Standard Panel Wall (UNPFR, UNPFR and UNPC)
All panel profiles accept the Panel Wall Add-On Screen - Glass (UNSPG) and Panel Wall Add-On Screen - Solid (UNSPS).
Flush and Convertible panel profiles can accept the Support Feet for Forwarding District (SDFPS) for forwarding applications. Elevated Panels cannot accept a forwarding foot.

understanding pages

Used to describe the intent and common features of a group of products.

application guides
flush panel wall basics

Flush Panel Walls consist of a frame to the floor, and are typically used with hard surface facias which have mounting clips.

- Consists of one or two sections depending on width and final rails at 6" and 29" (or 28" for panels with accessory beams) to allow for horizontal mounting of average and wide facias
- Complete with fascia attachment clips and does and accepts all fascia types (see Facias Section for complete product offering)
- Complete with light block strip on vertical and horizontal does
- Finished in Black

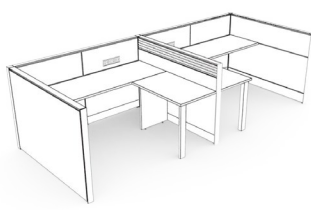

Flush Panel Wall (UNPFR)
• Available in heights of 29", 42", 51" and 66"
• The 29", 42" and 51" high frame can be used in front-of-face application

basics pages

Used to describe the details of each individual product including:

- Product codes
- Dimensions
- Options
- Features
- Links to the price page

application guides
planning with the panel wall rail & light block rail

The following should be considered when planning with Panel Wall Rails and Light Block Rails.

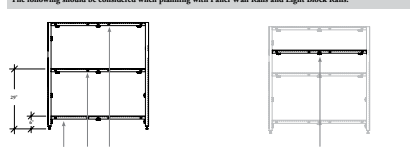

- Panel walls have fixed horizontal segmentation at 6" and 29" heights and top rail height only
- If additional segmentation is required above 29" high, Panel Wall Rails or Light Block Rails must be added at the desired height
- Panel Wall Rails and Light Block Rails are only available up to 66" wide
- They cannot span across the one panel to panel widths 66" and above sections
- One rail must be ordered for each half of the panel
- One rail is required at all fascia breaks above 29" high
- Choice of rail will depend on whether the fascia has clips (Panel Wall Rail) or recesses (see also Light Block Rail)

planning pages

Used to outline the rules and restrictions that should be considered when planning with products.

panel walls

panel walls

UNDERSTANDING PANEL WALLS	25
FLUSH PANEL WALL BASICS	27
ELEVATED PANEL WALL BASICS	28
CONVERTIBLE PANEL WALL BASICS	29
PANEL WALL BASE BASICS	30
PLANNING WITH THE PANEL WALL RAIL & LIGHT BLOCK RAIL	31
SUPPORT FOOT BASICS	32
PLANNING WITH PANEL WALL BASE & FOOT	33
SUPPORT FOOT FOR FREESTANDING DISTRICT BASICS	34
PLANNING WITH FREESTANDING PANELS	35
ADD-ON WINDOW BASICS	36
PLANNING WITH ADD-ON WINDOWS	37
FULL-HEIGHT WINDOW BASICS	38
PLANNING WITH FULL-HEIGHT GLASS PANELS	39

understanding panel walls

District Panels are available in three Panel Styles: Standard Panel Wall, Panel Wall with Inset Glass and Panel Wall with Accessory Beam. Each Panel Style is available in three Panel Profiles: Flush, Elevated and Convertible.

panel profiles

- Flush, which provides privacy to the floor
- Elevated, which provides a 6" high open space at the bottom of the panel to allow air flow and a lighted aesthetic
- Convertible, which provides a economical alternative to the Flush and Elevated Panel and allows the flexibility to convert from a Flush Panel Profile to an Elevated Panel Profile using the same frame

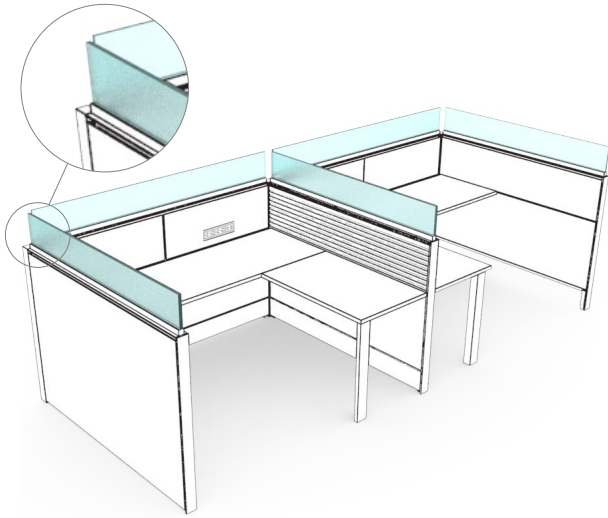

Standard Panel Wall (UNPFR, UNPER and UNPC)

All panel profiles accept the Panel Wall Add-On Screen – Glass (UNSPG) and Panel Wall Add-On Screen – Solid (UNSPS).

Flush and Conventional panel profiles can accept the Support Foot for Freestanding District (UAFN) for freestanding applications. Elevated Panels **cannot** accept a freestanding foot.

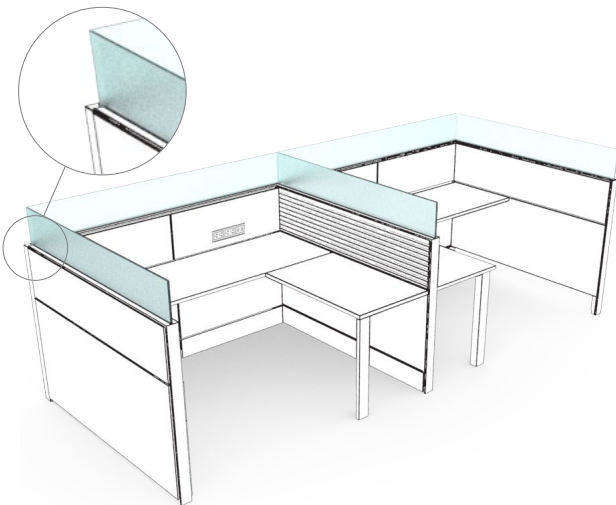

Panel Wall with Inset Glass (UYPFR, UYPER and UYPCR)

All panel profiles accept the Panel Glass Blade for Panel with Inset Glass (UYSPG) and Bridged Glass Blade for Panels with Inset Glass (UYSCG).

The glass blade is inset into the frame, so there is less exposed trim offering a more seamless appearance.

Flush and Conventional panel profiles can accept the Support Foot for Freestanding District (UAFN) for freestanding applications. Elevated Panels **cannot** accept a freestanding foot.

understanding panel walls (continued)

panel creep

District Panels have no creep factor, the nominal dimension and the actual dimension are the same.

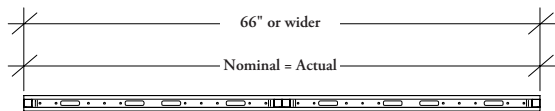

- Panels 66" or wider consist of two equally sized segments

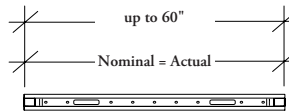

- Frame up to 60" consist of one segment only

panel runs

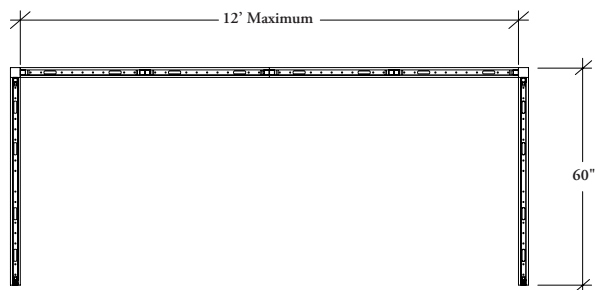

- On panel wall heights of 66" that do **not** support loads, the maximum run allowed is 12' - 0"
- 60" wide x 66" high wing panels must be used at both ends to provide adequate support

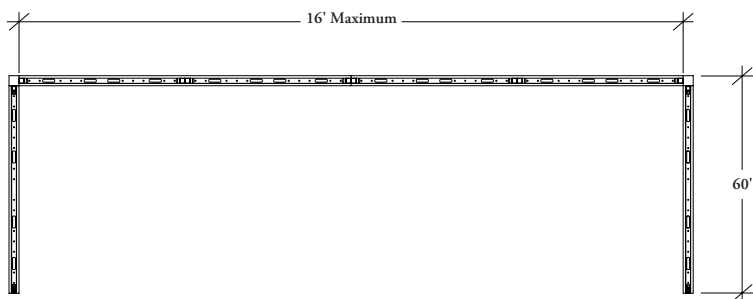

- On panel wall heights of 29", 42" and 51" that do **not** support loads, the maximum unsupported run allowed is 16' - 0"
- 60" wide wing panels the same height as the panel run, must be used at both ends to provide support

fascia spans

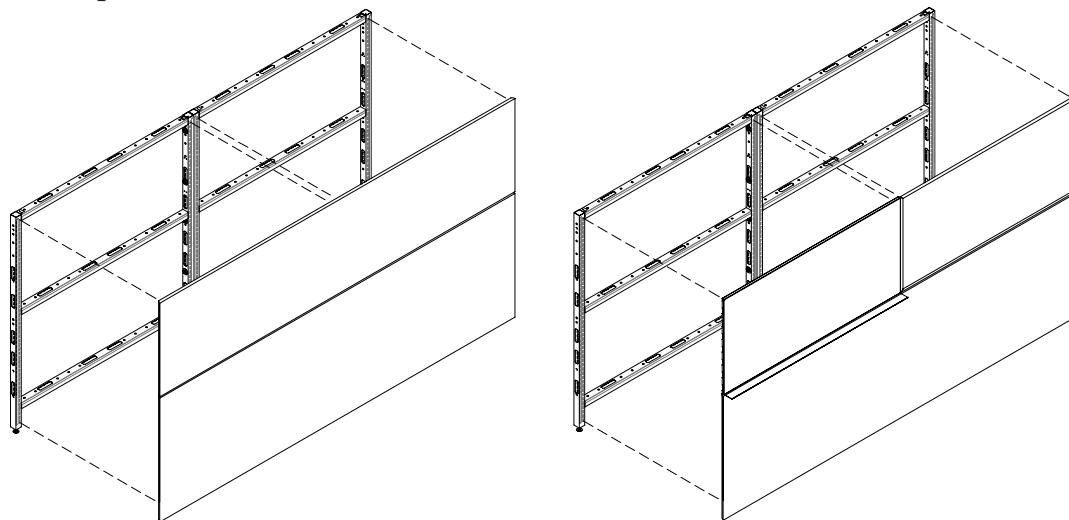

- Fascias can span across both sections of a frame 66" wide and wider to cover the entire width, or can be split so that each section can have a different fascia

flush panel wall basics

Flush Panel Walls consist of a frame to the floor, and are typically used with hard surface fascias which have mounting clips.

- Consists of one or two sections depending on width and fixed rails at 6" and 29" (or 28" for panels with accessory beam) to allow for horizontal mounting of storage and worksurfaces
- Complete with fascia attachment clips and slots and accepts all fascia types (see Fascia Section for complete product offering)
- Complete with light block strip on vertical and horizontal slots
- Finished in Black

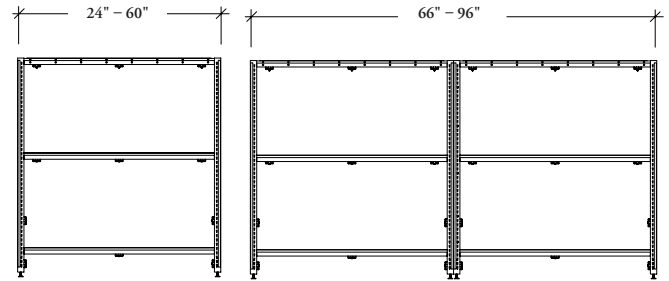
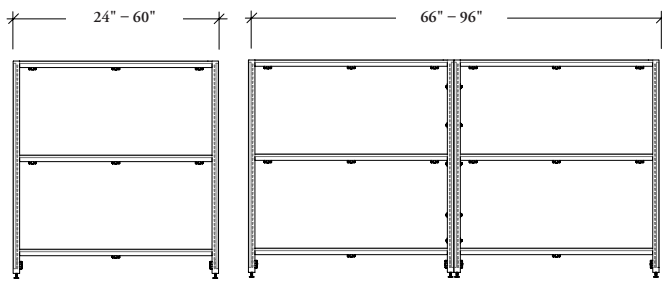
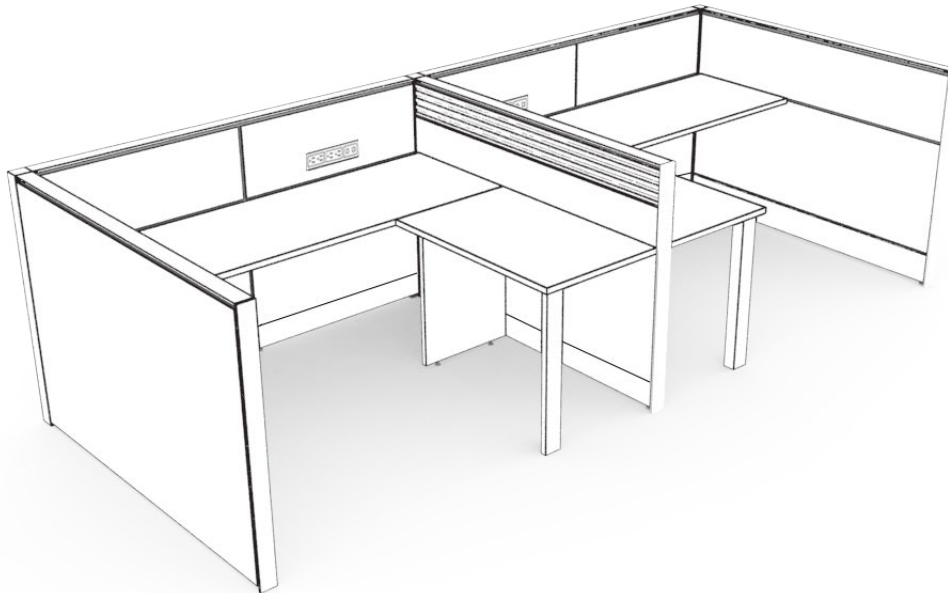

Flush Panel Wall (UNPFR)

- Available in heights of 29", 42", 51" and 66"
- The 29", 42" and 51" high frame can be used in freestanding application
- Can accept Panel Wall Add-On Screen – Solid (UNSPS) and Panel Wall Add-On Screen – Glass (UNSPG)

Flush Panel Wall with Inset Glass (UYPFR)

- Available 29", 42" and 51" high
- Can be used with or without Panel Glass Blade for Panels with Inset Glass (UYSPG) or Bridged Glass Blade for Panels with Inset Glass Blade (UYSCG)
- If Inset Glass, (UYSPG/UYSCG) is being specified, the Panel Top Trim for Panels with Inset Glass (UNTT) or Bridged Top Trim for Panels with Inset Glass (UYCT) must be specified
- Can be used in freestanding applications
- Panel Walls with Inset Glass do not allow access to the top horizontal rail of the panel, so careful attention must be paid when planning with horizontal mounting brackets. Please see the Worksurface and Support Sections for details on mounting worksurfaces to 29" high Panel Walls with Inset Glass
- When planning with District with Inset Glass Panel, a return panel must be specified on both sides of a panel run when using center mounted overhead storage

elevated panel wall basics

Elevated Panel Walls consist of a frame that allows for 6" of open space at the bottom. It is typically used with hard surface fascias which have mounting clips and for applications where the aesthetic and finish of the foot are considerations.

- Consists of one or two sections depending on width and fixed rails at 6" and 29" (or 28" for panels with accessory beam) to allow for horizontal mounting of storage and worksurfaces, but does **not** extend to the floor – the Elevated Panel Wall Foot (UNPEFR) (must be ordered separately) is attached below the panel frame to reach the desired datum height
- Complete with fascia attachment clips and slots and accepts all fascia types (see Fascia Section for complete product offering)
- Complete with light block strip on vertical and horizontal slots
- Base of the 6" rail is finished in Clear Anodized, Foundation or Mica paint finishes

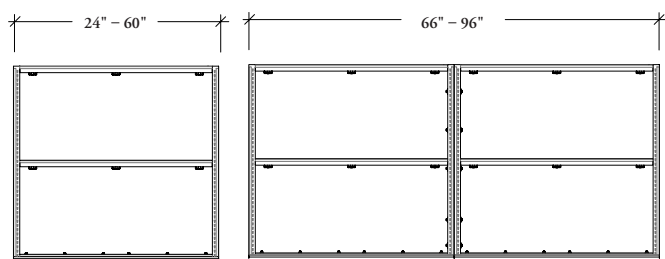
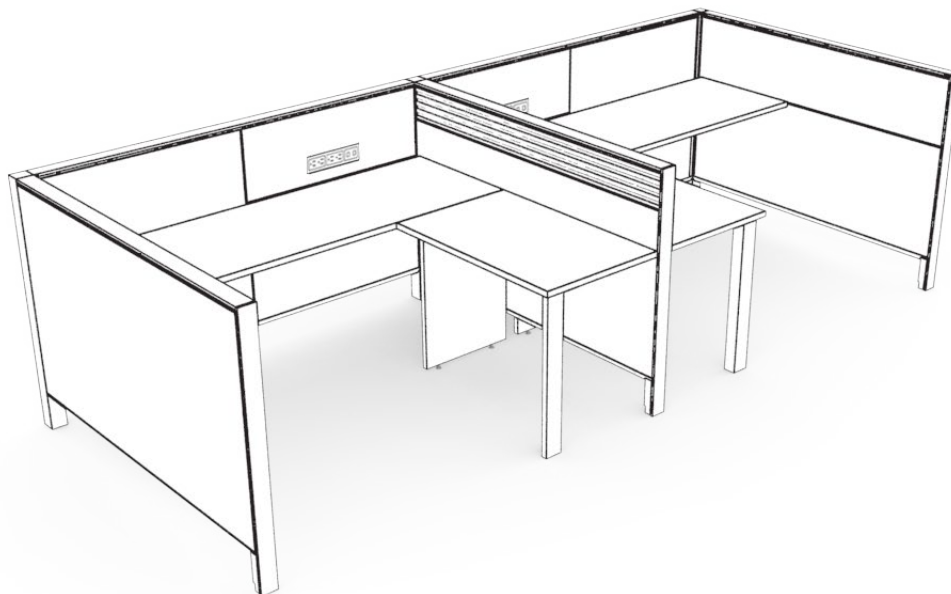

Elevated Panel Wall (UNPER)

- Available in heights of 29", 42", 51" and 66"
- **Cannot** be used in freestanding applications
- Can accept Panel Wall Add-On Screen – Solid (UNSPS) and Panel Wall Add-On Screen – Glass (UNSPG)

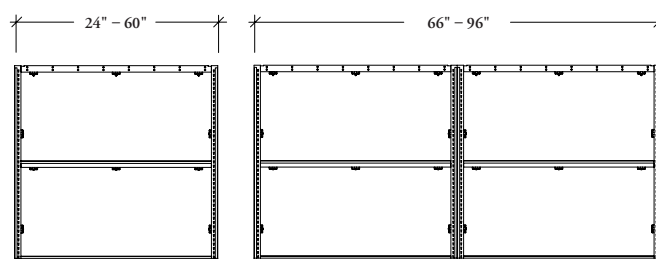

Elevated Panel Wall with Inset Glass (UYPER)

- Available 29", 42" and 51" high
- Can be used with or without Panel Glass Blade for Panels with Inset Glass (UYSPG) or Bridged Glass Blade for Panels with Inset Glass Blade (UYSCG)
- If Inset Glass, (UYSPG/UYSCG) is being specified, the Panel Top Trim for Panels with Inset Glass (UNTT) or Bridged Top Trim for Panels with Inset Glass (UYCT) must be specified
- **Cannot** be used on freestanding applications
- Panel Walls with Inset Glass do not allow access to the top horizontal rail of the panel, so careful attention must be paid when planning with horizontal mounting brackets. Please see the Worksurface and Support Sections for details on mounting worksurfaces to 29" high Panel Walls with Inset Glass
- When planning with District with Inset Glass Panel, a return panel must be specified on both sides of a panel run when using center mounted overhead storage

convertible panel wall basics

Convertible Panel Walls consist of a frame to the floor and provides an economical and flexible alternative to the Flush and Elevated panel frame. It can be used in a flush or elevated profile and is typically used for applications where the majority of the fascias do not have clips and are slot-mounted.

- Consists of one or two sections depending on width and fixed rails at 6" and 29" (or 28" for panels with accessory beam) to allow for horizontal mounting of storage and worksurfaces
- Does **not** have fascia attachment clips, is complete with slots only
- There are two rows of slots side-by-side will accept both fascias and storage or supports in the same location
- Accepts all fascia types but for Fascias that are complete with fascia clips, a separate mounting clip kit is required for mounting the fascias to the frame
- When used in a Flush application fascias are mounted onto the frame to the floor, and when used in an Elevated application the fascia mounts onto the frame to the 6" rail and an additional Convertible Panel Wall Base and Foot Trims (UNPCF) are added to provide a base trim and foot cover on the frame below the 6" level
- Finished in Black

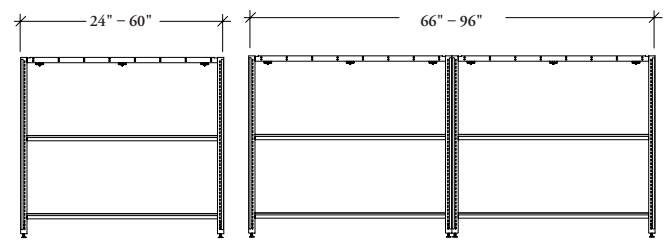
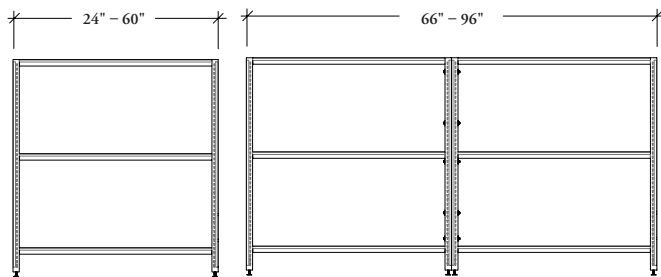
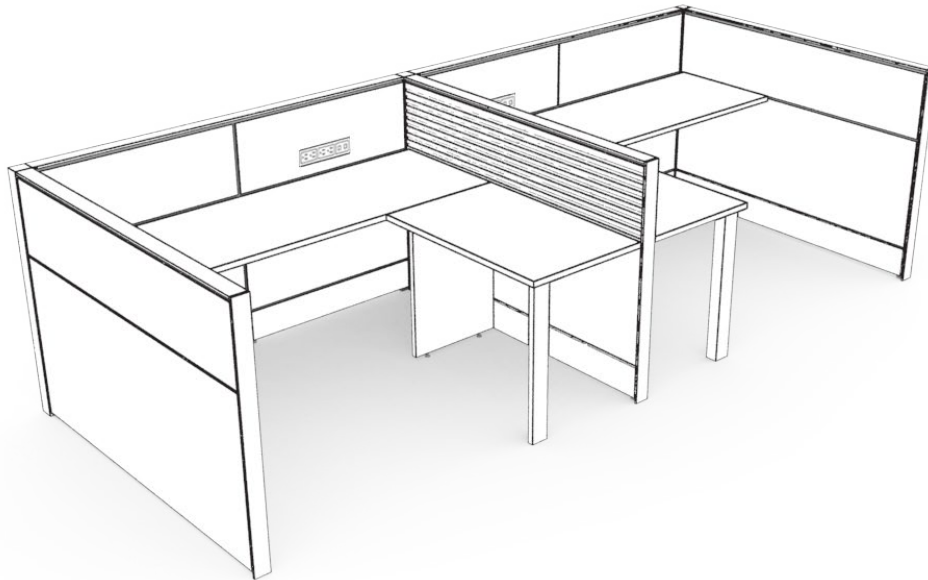

Convertible Panel Wall (UNPC)

- Available in heights of 29", 42", 51" and 66"
- The 29", 42" and 51" high can be used in freestanding applications
- Can accept Panel Wall Add-On Screen – Solid (UNSPS) and Panel Wall Add-On Screen – Glass (UNSPG)

Convertible Panel Wall with Inset Glass (UYPCR)

- Available 29", 42" and 51" high
- Can be used with or without Panel Glass Blade for Panels with Inset Glass (UYSPG) or Bridged Glass Blade for Panels with Inset Glass Blade (UYSCG)
- If Inset Glass, (UYSPG/UYSCG) is being specified, the Panel Top Trim for Panels with Inset Glass (UNTT) or Bridged Top Trim for Panels with Inset Glass (UYCT) must be specified
- Can be used in freestanding applications
- Panel Walls with Inset Glass do not allow access to the top horizontal rail of the panel, so careful attention must be paid when planning with horizontal mounting brackets. Please see the Worksurface and Support Sections for details on mounting worksurfaces to 29" high Panel Walls with Inset Glass
- When planning with District with Inset Glass Panel, a return panel must be specified on both sides of a panel run when using center mounted overhead storage

panel wall base basics

Panel Wall Rails and Light Block Rails are used to create additional segmentation on panels above the 29" high rail.

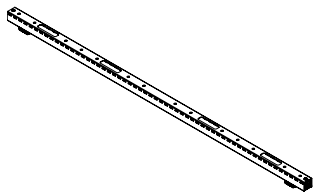
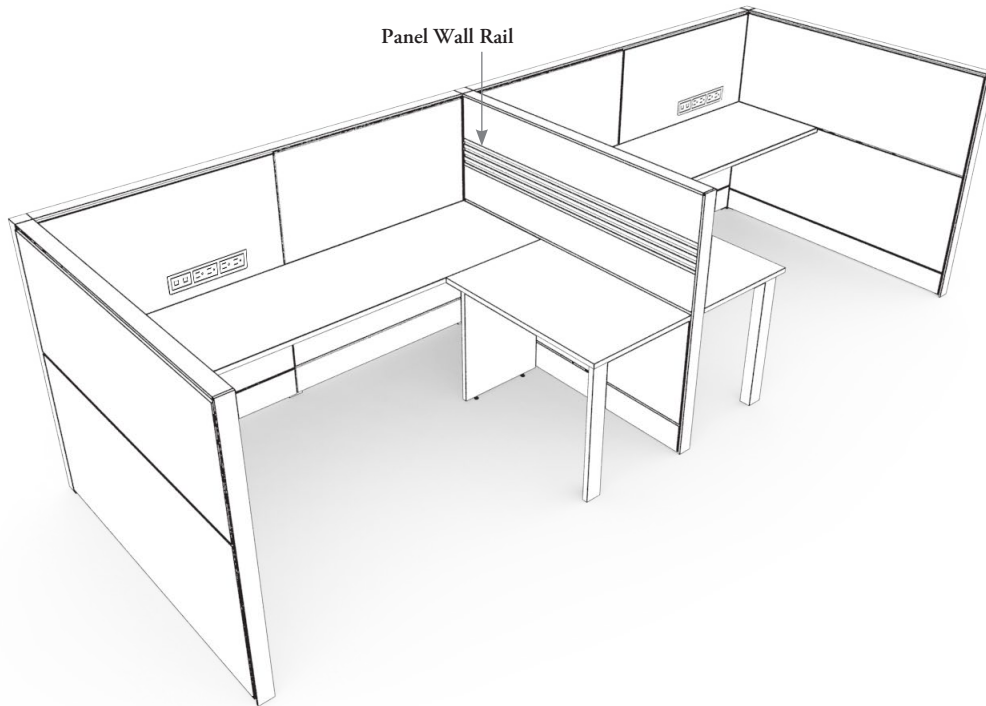

Panel Wall Rail (UNPHN)

- Complete with clips so can be used on all panels when Fascias with clips are specified

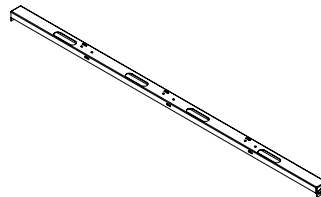

Light Block Rail (UNEX)

- Does not include clips so can be used on all panel types when fascias with no clips are specified

planning with the panel wall rail & light block rail

The following should be considered when planning with Panel Wall Rails and Light Block Rails.

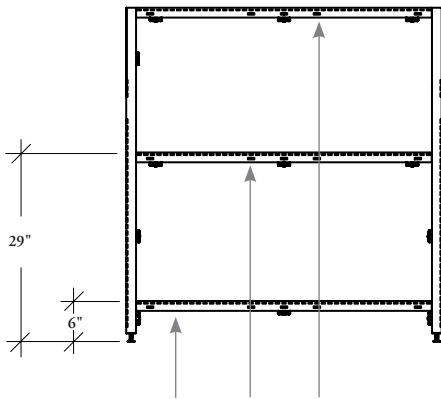

- Panel walls have fixed horizontal segmentation at 6" and 29" heights and top rail height only

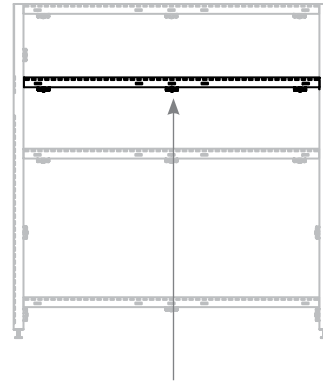

- If additional segmentation is required above 29" high, Panel Wall Rails or Light Block Rails must be added at the desired heights

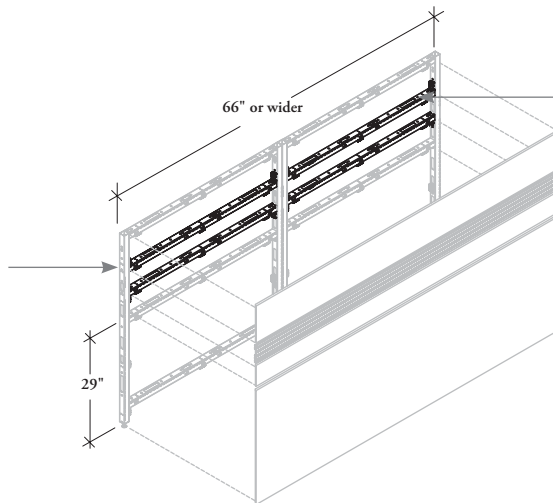

- One rail is required at all fascia breaks above 29" high
- Choice of rail will depend on whether the fascia has clips (Panel Wall Rail) or mounts into slots (Light Block Rail)

- Panel Wall Rails and Light Block Rails are only available up to 60" wide
- They **cannot** span across the two panel in panel widths 66" and above sections
- One rail must be ordered for each half of the panel

In this example, the 6" and 29" high rail and top of panel are fixed, so four additional rails are required.

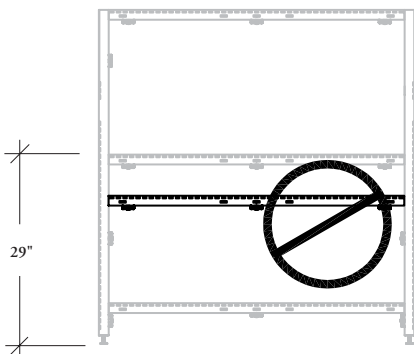

- Panel Walls **cannot** be segmented between the 6" high rail and 29" high rail
- There are no mounting locations in the frame Panel Wall Rails or Light Block Rails

application guides

support foot basics

Panel Wall Bases and Panel Wall Feet are used for elevated panel wall applications.

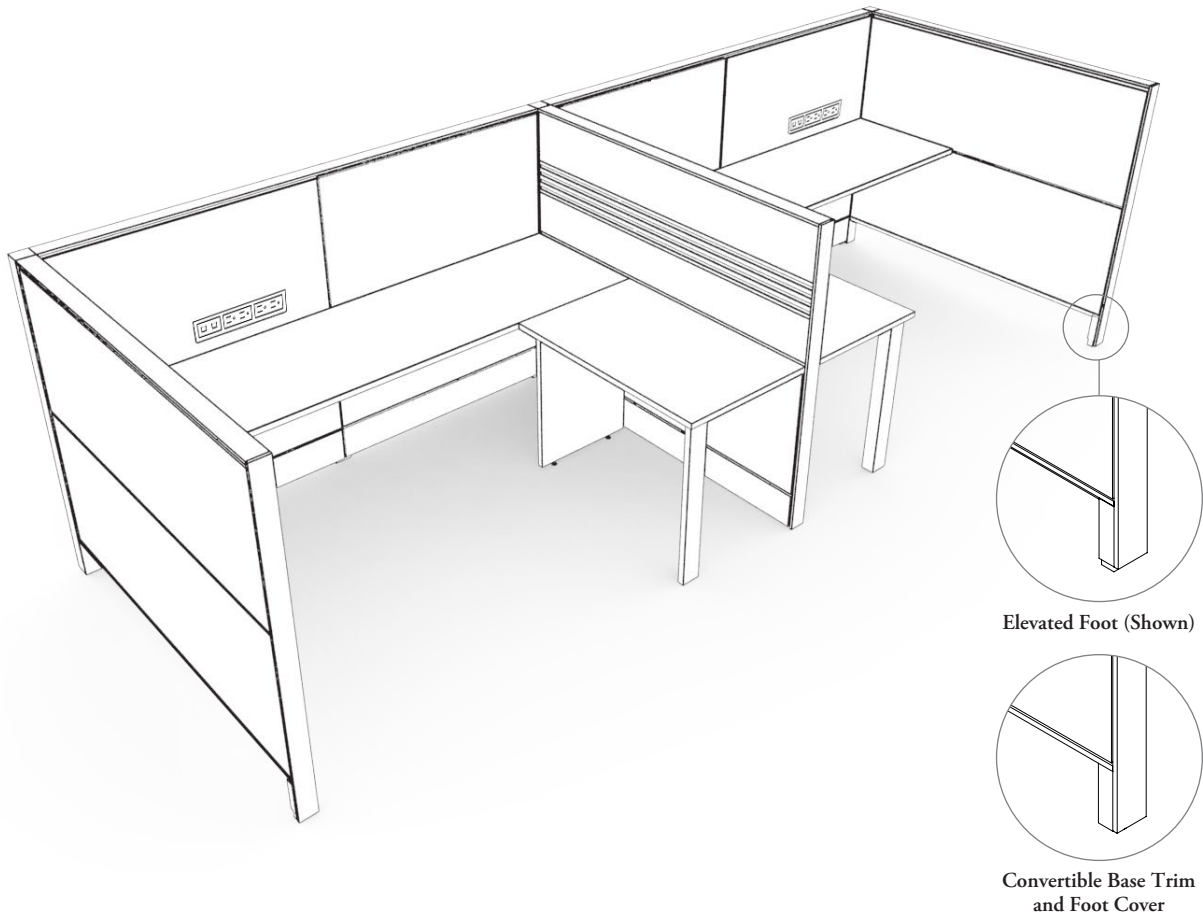

Elevated Foot (Shown)

Convertible Base Trim and Foot Cover



Elevated Panel Wall Foot (UNPEFR)

- Used with the Elevated Panel Wall (UNPER) and Elevated Panel Wall with Inset Glass (UYPER)
- Mounted to the base of the panel frame to elevate the frame 6" above the floor
- Used at all ends and shared between two panels at 180° angles, but are **not** required at corners or 180° spacers because the connector provides the necessary panel support
- Available in Clear Anodized, Foundation and Mica paint finishes

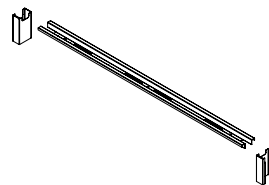

Convertible Panel Wall Base and Foot Trim (UNPCF)

- Used with the Convertible Panel Wall (UNPC) only in an elevated application
- Consists of a metal trim that is attached to the bottom rail of the panel and elevated feet that snap onto the frame post
- One Convertible Panel Wall Base and Foot Trim is required for all elevated panels 60" and less. Two are required for elevated panels 66" and wider as they are made up of two frames (specified as one unit at the overall length)
- Available in Foundation and Mica paint finishes

planning with panel wall base & foot

The following should be considered when planning with Panel Wall Bases and Feet.

elevated panel wall foot

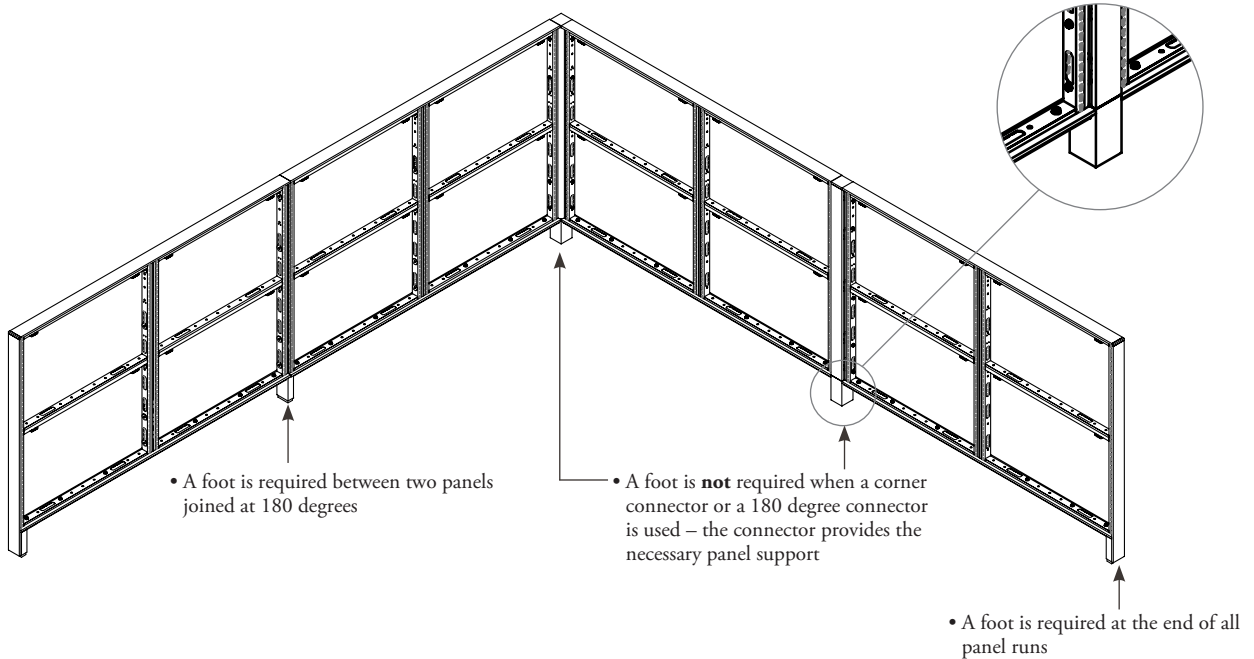

- The Panel Wall Foot is used only on the Elevated Panel Wall
- Provides a clean aesthetic at the base of the panel because it is required only at the ends of panel runs and shared between two panels in a straight run
- Offers a Clear Anodized finish option

convertible panel wall base and foot trim

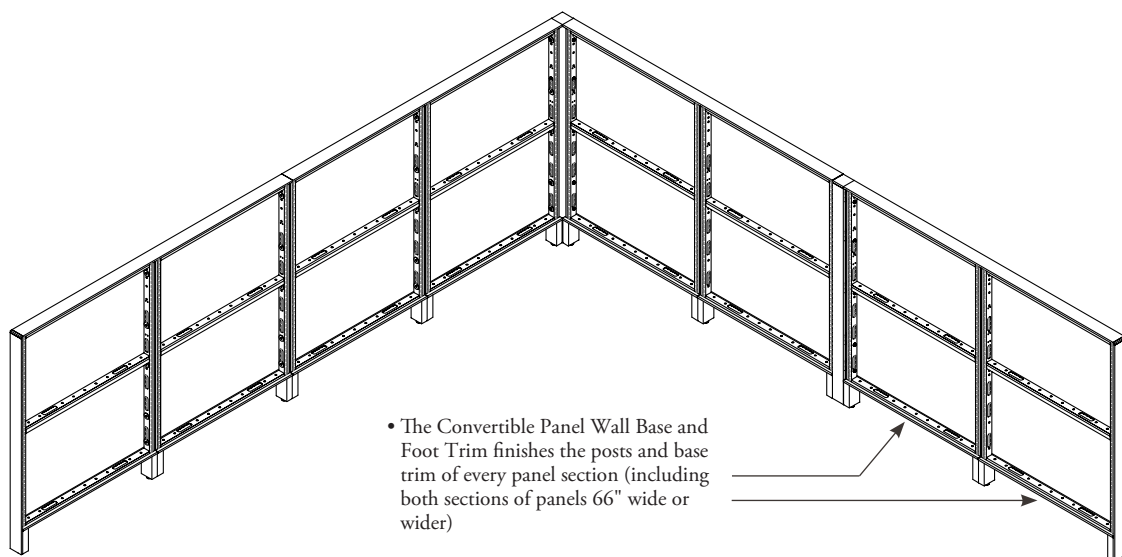

- The Convertible Panel Wall Base and Trim is used only on the Convertible Panel Wall in Elevated applications
- Available only in painted finishes
- Lengths 60" wider and under include two feet covers and one base trim
- Lengths 66" wide and wider include four feet covers and two base trims

support foot for freestanding district basics

The Support Foot is used to create Freestanding District Panel runs.

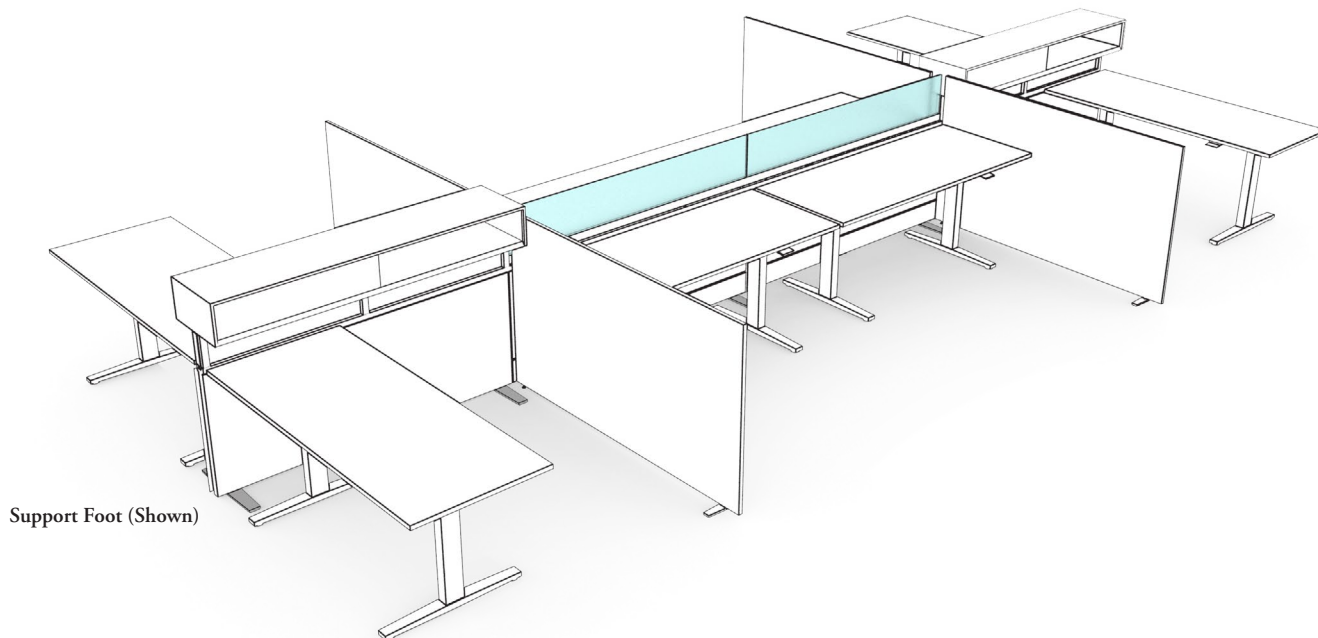

Support Foot (Shown)

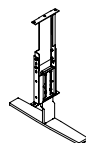

Support Foot for Freestanding District (UAFN)

- Installed at the bottom of panels to create freestanding applications
- **Cannot** be used with an Elevated panel
- The Support Foot can be used in any of the four existing hole locations on the bottom of Flush or Convertible panels
- On Panel widths from 24" - 42" there are two cut out locations, 48" - 78" have four cut out locations
- There must be a foot at both start and ends of a panel run
- The Support Foot takes up approximately 1/2" in height therefore a specific fascia is required below 29" high (the height is nominal, therefore 28" fascia will actually be approximately 27-1/2" to allow for the foot)
- The distance between panel support feet **cannot** exceed 96"
- A unique end trim is required, End Trim for Freestanding District (UATE) to accommodate the height change created by the foot
- Freestanding District can be specified up to 51" total in height (this can be either a 51" high panel or a 29" or 42" high panel with storage or screens to 51" high)
- The top area of the foot offers cable pass through capability available with levelers
- Available with levelers
- Recommend additional support feet if panel mounted storage usage is high

planning with freestanding panels

The following outlines the steps for planning with Freestanding District Panels.

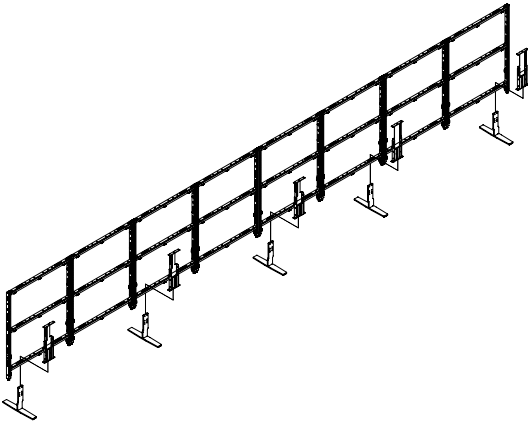

Specify the Support Foot as needed. Support foot must be specified at the beginning and at the end of each run as well as every 8' in between. Support feet **cannot** be placed in the same location that power is used, so careful attention to the planning of power is required. See fascia section for available power cut out locations.

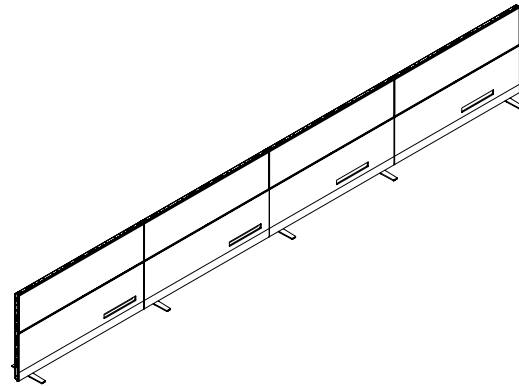

Specify the fascias required. In this example the power is in the right location, but at the end of the run, the power is located center right to avoid interference with support foot.

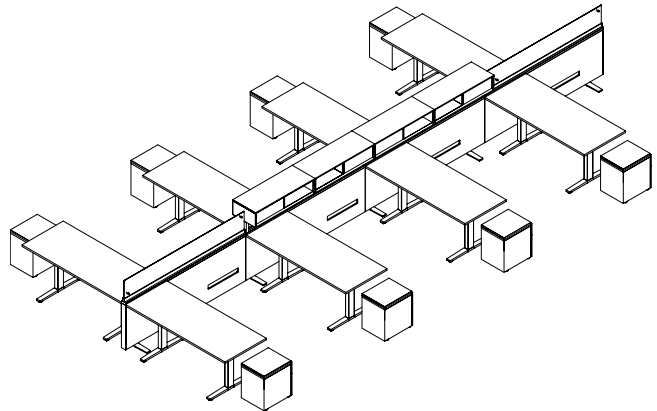
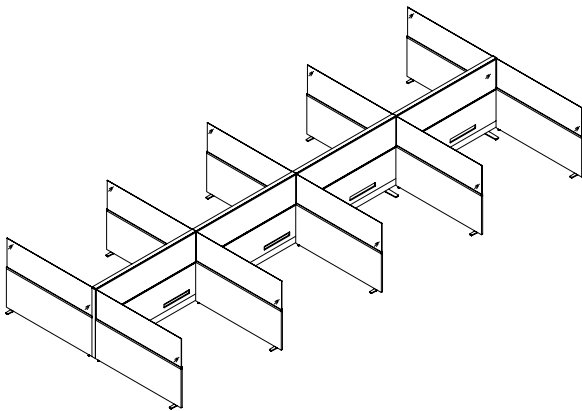

When planned at 29" high with accessory rail, a variety of storage options can be added either freestanding and mobile or mounted onto the accessory beam.

Recommend additional support feet if panel mounted storage usage is high.

add-on window basics

Add-On Windows mount to the top of a panel wall frame to provide an uninterrupted glass finish.

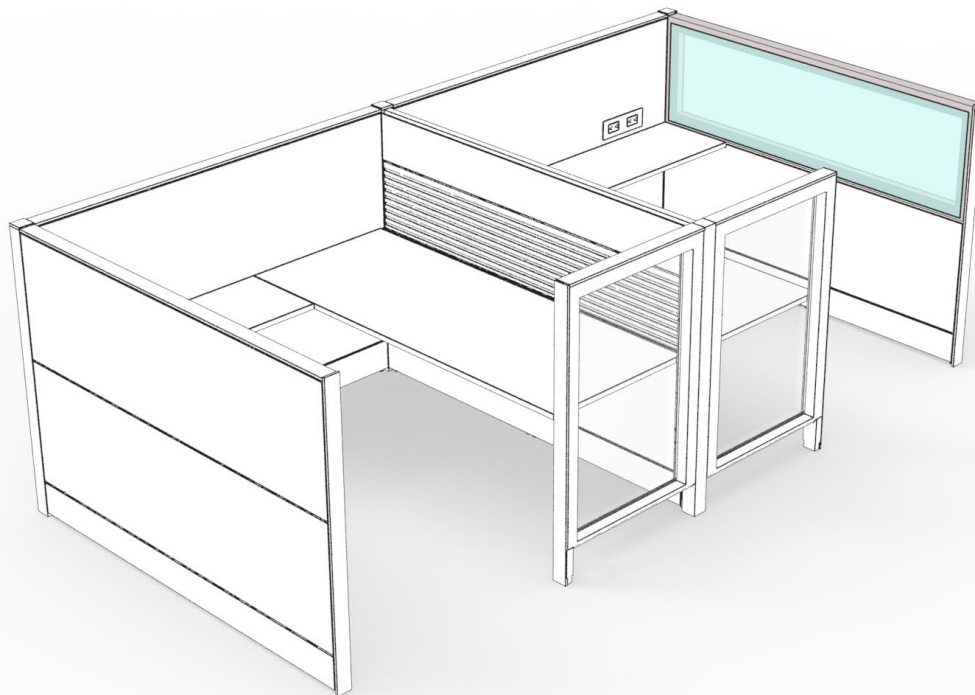

Add-On (D-Style)
Window (Shown)

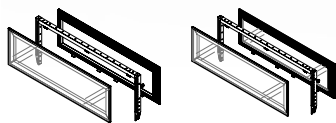

Add-On (D-Style) – Single Glass (UNPWSR) and Double Glass (UNPWDR) Windows

- Mount on-module or semi off-module to the top of a panel wall frame up to a height of 66"
- Frame is continuous on all sides to provide a refined aesthetic
- Are **not** load bearing, and **cannot** be mounted above another add-on window
- Do **not** affect existing cable routing within the panel wall frame
- Available in Standard Glass Clear and Frost, and Specialty Glass Vanceva
- Standard Glass, Clear is a tempered glass; Standard Glass, Frost is a sandblasted tempered glass; Specialty Glass Vanceva is a laminated glass – Clear tempered glass will be applied to the opposite side of the double glass window when Frost or Vanceva glass have been specified
- Frames are available in Clear Anodized, Espresso and Storm White paint finishes
- Top trims must be specified separately
- Not available on UY_ Panels

planning with add-on windows

The following should be taken into consideration when planning with Add-On Windows.

stackability

- Only one window can be stacked onto a Panel Wall to a maximum height of 66"
- The Add-On is non-load bearing

- When the panel frame is wider than 60" and made up of two sections, the Add-On spans across both frame sections

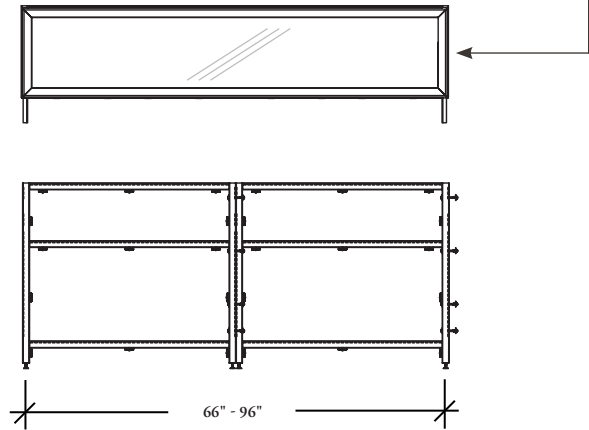
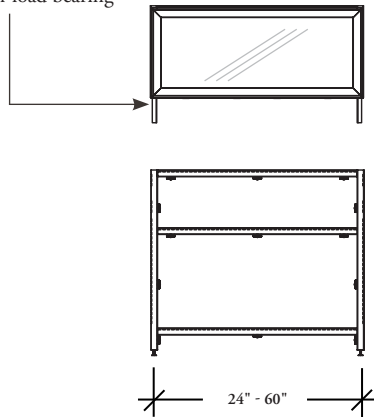

off-modularity

- The Add-On Window can be mounted fully on-module or semi off-module

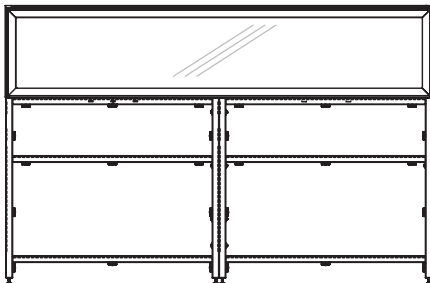

Fully On-Module

- The add-on window spans the entire panel wall regardless of whether the panel is a single frame section or made up of two frame sections

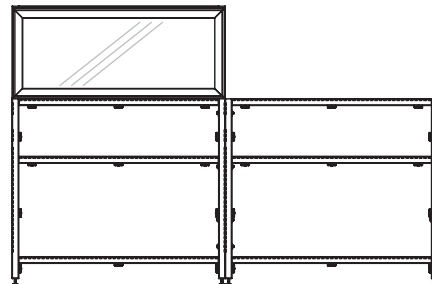

Semi Off-Module

- The Add-On Window is mounted on a panel wall that is over 60" wide therefore, made up of two sections
- The Add-On must be half the width of the overall panel to meet the connection of the two sections

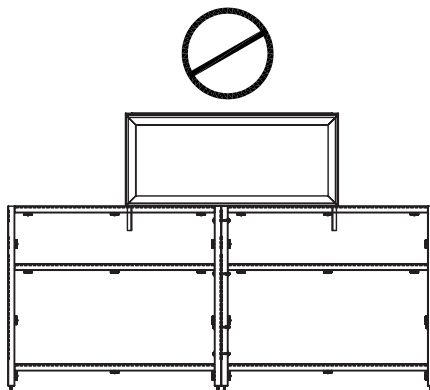

Fully Off-Module

The add-on window **cannot** be specified fully off-module.

full-height window basics

Full-Height Windows are used in place of a panel wall to provide a full-height glass alternative.

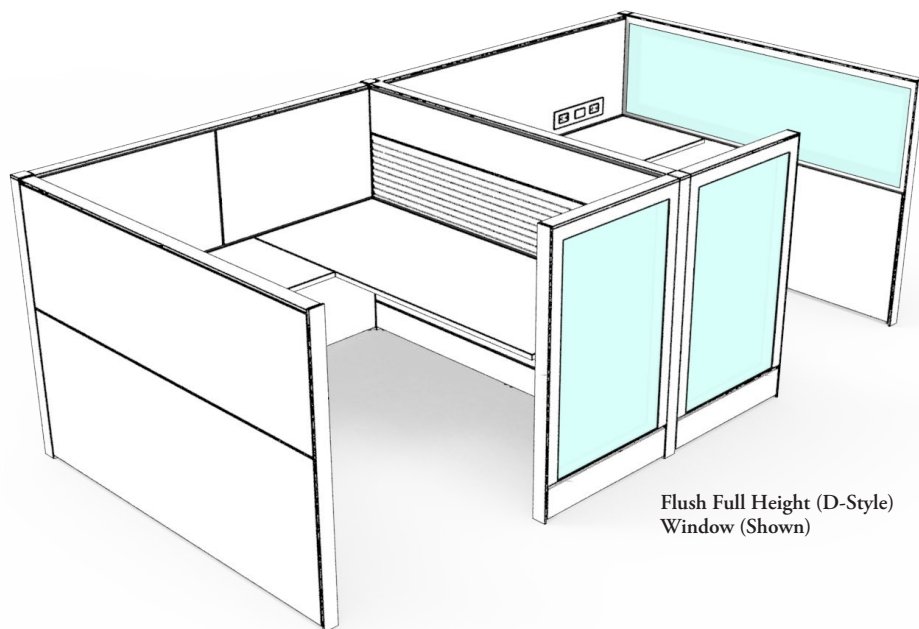

Flush Full Height (D-Style) Window (Shown)

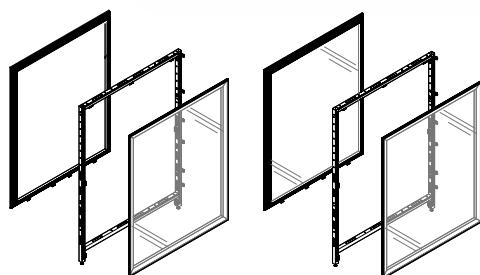

Flush Full-Height (D-Style) – Single Glass (UNPFWSR) and Double Glass (UNPFWDR) Windows

- Used in place of a Flush Panel Wall (UNPFR) and Flush Panel with Inset Glass (UYPFR)
- Available in widths up to 60" for panel heights up to 51" and widths up to 48" for panel heights up to 66"
- Available in Standard Glass Clear and Frost, and Specialty Glass Vanceva
- Standard Glass, Clear is a tempered glass; Standard Glass, Frost is a sandblasted tempered glass; Specialty Glass Vanceva is a laminated glass – Clear tempered glass will be applied to the opposite side of the double glass window when Frost or Vanceva glass have been specified
- Frames are available in Clear Anodized, Espresso and Storm White paint finishes
- Top trims and 6" Base Fascia must be specified separately

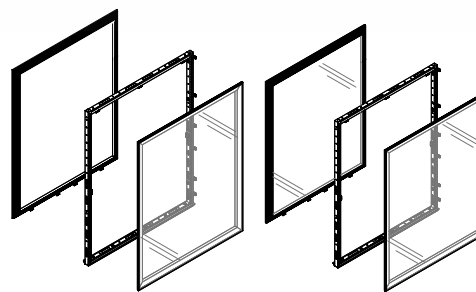

Elevated Full-Height (D-Style) – Single Glass (UNPEWSR) and Double Glass (UNPEWDR) Windows

- Used in place of an Elevated Panel Wall (UNPER) and Elevated Panel Wall with Inset Glass (UYPER)
- Available in widths up to 60" for panel heights up to 51" and widths up to 48" for panel heights up to 66"
- Available in Standard Glass Clear and Frost, and Specialty Glass Vanceva
- Standard Glass, Clear is a tempered glass; Standard Glass, Frost is a sandblasted tempered glass; Specialty Glass Vanceva is a laminated glass – Clear tempered glass will be applied to the opposite side of the double glass window when Frost or Vanceva glass have been specified
- Frames are available in Clear Anodized, Espresso and Storm White paint finishes
- Top trims must be specified separately

planning with full-height glass panels

The following should be considered when planning with full-height glass panels.

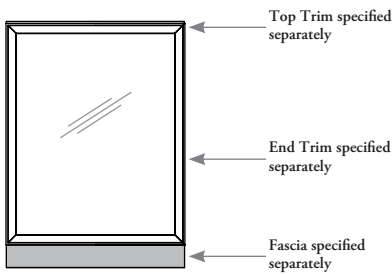

- Consists of the glass and frame only; top trims and end trims must be specified separately
- When the Flush Full Height Window is specified, a fascia must be specified to finish the base below the 6" rail

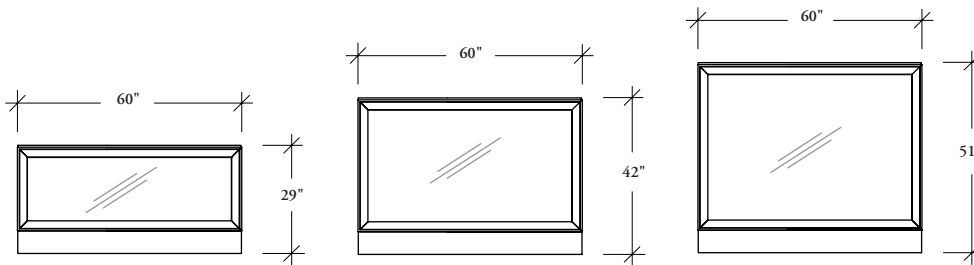

29", 42" and 51" heights are available in widths from 24" - 60"

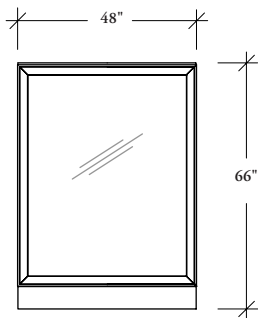

66" height is only available in widths from 24" - 48"

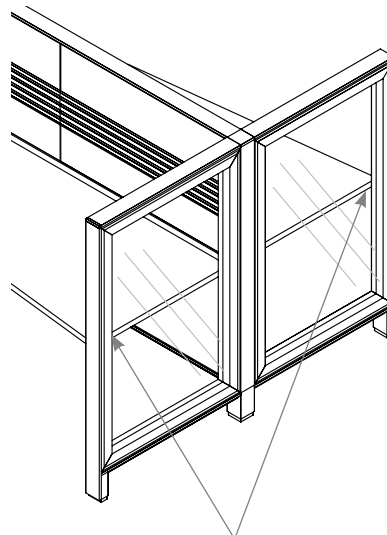

- Full-height glass panels can support worksurfaces when the depth of the work surface and the width of the panels are the same – see the *Supports* section for proper supports

fascias

fascias

UNDERSTANDING FASCIAS	42
UNDERSTANDING FASCIAS FOR FREESTANDING DISTRICT	43
UNDERSTANDING FASCIA TYPES	44
FASCIA BASICS	45
PLANNING WITH FASCIAS	53
PLANNING WITH WINDOW FASCIAS	56
PLANNING WITH POWER COMMUNICATIONS FASCIAS ON NON FREESTANDING PANELS	57
PLANNING WITH POWER COMMUNICATIONS FASCIAS ON FREESTANDING PANELS	60

understanding fascias

District Fascias mount to a panel wall frame to provide functionality and aesthetic options to the panel and are available for standard and freestanding applications.

Fascias are available for two applications

- UN_applications - used on
 - Standard panel walls
 - Standard panel walls with accessory rails
 - UA_applications - used on
 - Panel walls with freestanding feet (at the bottom level)
 - Panel walls with freestanding feet and accessory rails (at the top level)
- When specifying fascias on panels wall frames the total height of the fascias will be 1" less than the actual panel frame height, to allow for leveling (ex. a 29"h. panel wall frame uses a 28"h. fascia, or a 6" and 22"h. fascia combination)

UN_applications

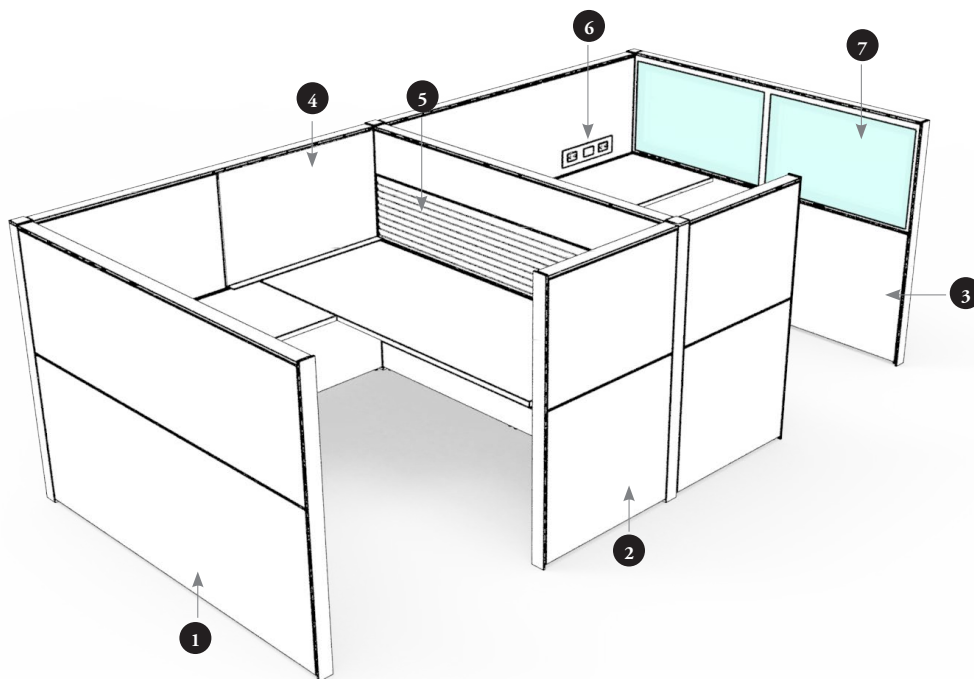

The following outlines the types of UN__ fascias available

- 1 Solid Fascias
 - Provide a high aesthetic and a furniture look and feel to a workstation
 - Fascias can be segmented or monolithic
- 2 Stretch Solid Fascias
 - Span across connectors to provide an uninterrupted aesthetic
- 3 Fabric and Metal Fascias
 - Provide a cost effective alternative to solid fascias
- 4 Tackable and Whiteboard Fascias, available
 - Framed to provide an enhanced aesthetic
 - Unframed to provide a cost effective alternative
- 5 Accessory Fascias
 - Provide a rail to store personal items above the worksurface
- 6 Power and Communication Fascias
 - Provides access to power either above or below worksurface level
- 7 Window Fascias
 - Add lightness to a panel wall

understanding fascias for freestanding district

UA_ applications

UA_ Fascias can be used in two locations:

- On the bottom level of a panel with freestanding feet
- Only the 6", 27" and 28"h. can be used at the bottom of a panel
- Fascia- heights are nominal, the actual size is 1/2" less to accommodate the freestanding foot
- At a level where electrical is required on a panel with freestanding feet, as the electrical locations are designed to avoid interference with the freestanding feet
- When specifying fascias on panels wall frames with accessory rails, the total height of the fascias will be 2" less than the actual panel frame, to allow for the thickness of the accessory rail and for leveling (ex. a 29"h. panel wall frame uses a 27"h. fascia, or a 6" and 21"h. fascia combination)

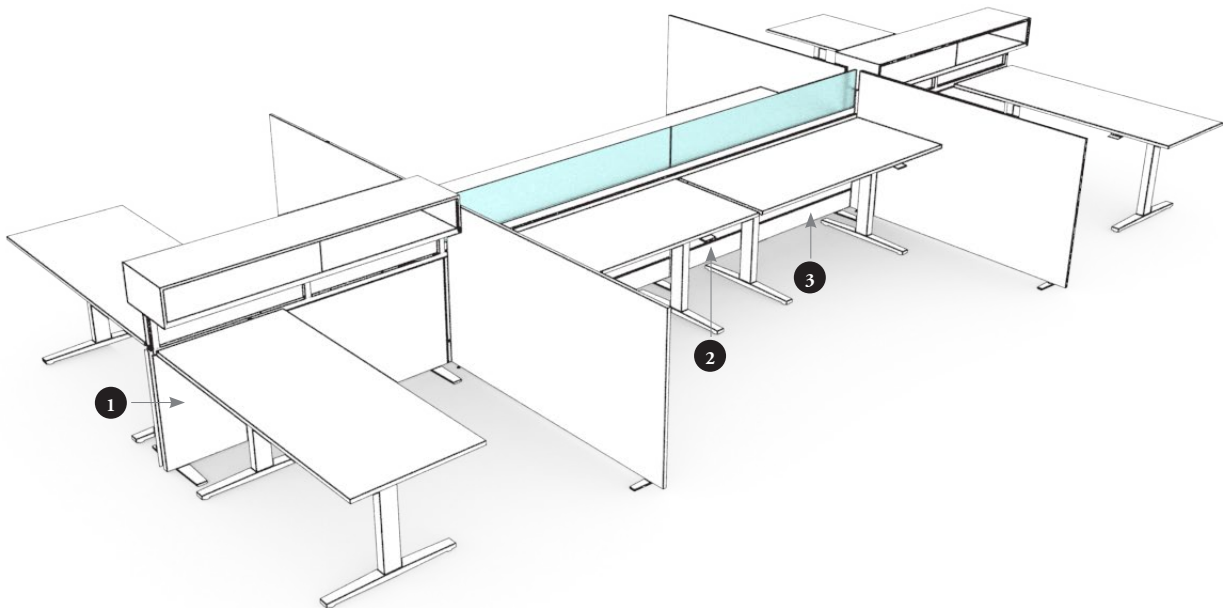

The following outlines the types of UA_ fascias available

- 1 Solid Fascias
 - Accommodates the freestanding foot
- 2 Fabric and Metal Fascias
 - Accommodates the freestanding foot
- 3 Power and Communication Fascias
 - Provides access to power below worksurface level
 - The cut out locations are different than the cut out locations on UN_ fascia to avoid interference with freestanding feet

understanding fascia types

The following examples outline the fascia heights required for non freestanding and freestanding panel configurations.

standard

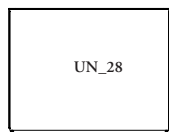

District Flush or Convertible Panel

- No Freestanding Feet, 29"h
- UN_28 fascia required

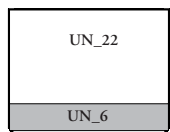

District Flush or Convertible Panel, No Freestanding Foot, 29"h.

- 1 UN_6 fascia required
- 1 UN_22 fascia required

standard with accessory rail

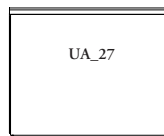

District Flush, No Freestanding Feet, 29"h

- UA_27 fascia required
- This allows for the 1" accessory rail at the top

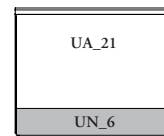

District Flush, No Freestanding Foot, 29"h.

- 1 UN_6 fascia required
- 1 UA_21 fascia required

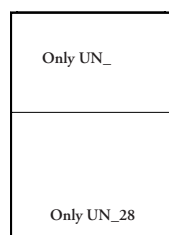

District Flush or Convertible Panel, No Freestanding Foot

- UN_28 fascia required
- UN_ fascia required to top of panel

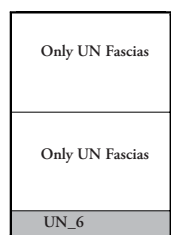

District Flush or Convertible Panel, No Freestanding Foot

- UN_06 fascia required
- UN_22 fascia required
- UN_ Fascia required to top of panel

panel with freestanding feet

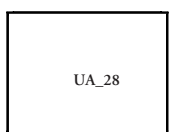

District Flush or Convertible Panel, with Freestanding Foot, 29"h

- UA_28 fascia required the panel

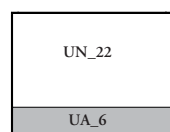

District Flush or Convertible Panel with Freestanding Foot, 29"h.

- 1 UA_6 fascia required
- 1 UN_22 fascia required

panel with freestanding feet and accessory rail

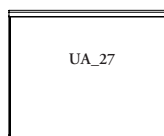

District Flush and Freestanding Foot, 29"h

- UA_27 fascia required
- This allows for the 1" accessory rail at the top

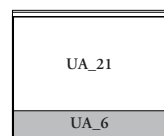

District Flush and Freestanding Foot, 29"h

- UA_6 fascia required
- UA_21 fascia required
- This allows for the 1" accessory rail at the top

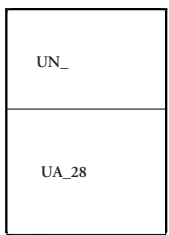

District Flush or Convertible Panel with Freestanding Foot

- UA_28 fascia required
- UN_ fascia required to top of panel

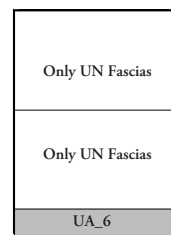

District Flush or Convertible Panel, With Freestanding Foot

- UA_6 fascia required
- UN_22 fascia required
- UN_ Fascia required to top of panel

District fascias mount onto panel wall frames by either clip mounting or slot mounting. The following outlines the available options.

clip-mounted

- The following fascias types mount into Flush and Elevated Panel Wall Frames
- They are hard surface fascias that provide a District aesthetic and are considered “D-style” fascias
- All “D-style” fascias mount to the panel frames with clips
- If a “D-style” fascia is required on a Convertible Panel Wall, a Fascia Clip Kit (additional clips) must be ordered and installed on the panel

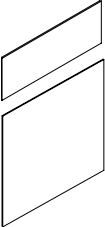
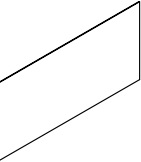
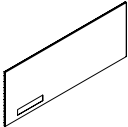
Product Name and Code	Illustration	Description	
<p>Solid Fascia (UNESD), Solid Full-Height Fascia (UNESF) and Stretch Solid Fascia (UNYSD)</p>		<p>A solid fascia that mounts into a panel wall frame.</p> <p>Heights: Solid Fascias 6", 7", 9", 13", 15", 22", 24", 28", 30" and 37"h. Solid Full Height Fascias 35" and 41"h. -For monolithic applications on 42"h panel wall frames Stretch Solid Fascia 6", 22", 28", 35" and 41"h.</p>	<p>Widths: 24" - 96" in 6" increments -Solid and Full Height Solid Fascia widths are actual dimensions -Stretch Solid Fascia widths are nominal dimensions, the actual width is 1 1/2" or 3" wider as they stretch either half way over a three-way connector on one or both sides Finishes: Laminate Flintwood Natural Veneer</p>
<p>Solid Fascia for Freestanding District (Clip Mounted) (UAESD) and Stretch Fascia for Freestanding District (UAYSD)</p>		<p>A solid fascia that mounts into a panel wall frame with: Freestanding feet Accessory rail</p> <p>Heights: Solid Fascias and Stretch Fascias 6", 22", 28", 35" and 41"h. -Used in two locations 1) The base level of a panel wall frame with freestanding feet -Sizes are nominal, actual sizes are 1/2" less to accommodate a freestanding support foot 2) When a panel wall frame has an accessory rail</p>	<p>Widths: 24" - 96" in 6" increments -Solid Fascia widths are actual dimensions -Stretch Solid Fascia widths are nominal dimensions, the actual width is 1 1/2" or 3" wider as they stretch either half way over a three-way connector on one or both sides Finishes: Laminate Flintwood Natural Veneer</p>
<p>Solid Power/ Communications Fascia (UNECL) (shown) and Solid International Power/ Communications Fascia (UNEIL)</p>		<p>A solid fascia with electrical and communication cut outs that mounts into a panel wall frame. -The cut out configurations and orientations available depend on size</p> <p>Heights: 7", 13", 22", 28", 37" h. -Available for above and below worksurface mounting</p> <p>Widths: 24" - 96" in 6" increments</p> <p>Outlet Configurations: UNECL 2 =one duplex outlet plus VDM 4 =two duplex outlets plus VDM UNEIL 2 =cut out for two outlets 3 =cut out for two outlets and one data/ communications 4 =cut out for four outlets 5 =CALA sized cut out for two outlets 6 =CALA sized cut out for four outlets</p>	<p>Cut Out Orientations: Horizontal L =left R =right C =centered B =both left and right Vertical T =top or upper section of fascia B =bottom or lower section of fascia F =flush (28"h. fascias flush to the floor) Finishes: Laminate Flintwood Natural Veneer</p>

fascia basics (continued)

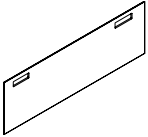
Product Name and Code	Illustration	Description	
<p style="text-align: center;">Solid Power/ Communications Fascia for Freestanding District (Clip Mounted) (UAECL) and Solid International Power/ Communications Fascia for Freestanding District (Clip Mounted) (UAEIL)</p>		<p>A solid fascia with electrical and communication cut outs that mounts into a panel wall frame with:</p> <ul style="list-style-type: none"> -Freestanding feet -Accessory rail -The cut out locations are different than a UN__fascia to allow for the placement of freestanding feet below the panel frame -The cut out configurations and orientations available depend on size, see chart see power communications fascias chart <p>Heights: 22" and 28"h.</p> <p>-Sizes are nominal, actual sizes are 1/2" less to accommodate a freestanding support foot</p> <p>Widths: 24" - 96" in 6" increments</p> <p>Outlet Configurations: UAECL 2 =one duplex outlet plus VDM 4 =two duplex outlets plus VDM UAEIL 2 =cut out for two outlets 3 =cut out for two outlets and one data/ communications</p>	<p>4 =cut out for four outlets 5 =CALA sized cut out for two outlets 6 =CALA sized cut out for four outlets</p> <p>Cut out Locations: One cut out LL =left RR =right LC =left center RC =right center 2 cut outs LR =left and right CR =left center and right CL =right center and left</p> <p>--See chart see power communications fascias chart</p> <p>Finishes: Laminate Flintwood Natural Veneer</p>

fascia basics (continued)

slot-mounted

- The following fascias types mount to the Convertible Panel Wall Frame or Power Spine frame (depending on size). They provide a cost effective alternative to “D-Style” fascias and are unframed. They are also referred to as “L-Style” fascias
- All “L-Style” fascias mount into the panel wall slots
- An “L-Style” fascia can mount into a Flush or Elevated Panel Wall as these frames also contain slots, the clips on the panel walls will remain unused

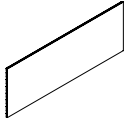
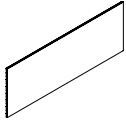
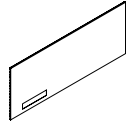
Product Name and Code	Illustration	Description	
<p>Metal Fascia (UNELM)</p>		<p>A metal fascia that mounts into a panel wall frame</p> <p>Heights: 6", 7", 9", 13", 15", 22", 24", 26", 28", 30" and 37"h.</p> <p>Widths: 6"h. - 28"h. 24" - 96"w. in 6" increments 30" and 37"h. 24" - 60"h. in 6" increments</p> <p>Finishes: Foundation Mica</p>	
<p>Metal Fascia for Freestanding District (UAELM)</p>		<p>A metal fascia that mounts into a panel wall frame with: Freestanding feet Accessory rail</p> <p>Heights: 6", 22", 28", and 35" h.</p> <p>-Mounted in the lowest level of the panel -Are used on panel wall frames with an accessory rail -1" less to allow for the thickness of the accessory rail</p>	<p>Widths: 6"h. - 28"h. 24" - 96"w. in 6" increments 35"h. 24" - 60"h. in 6" increments</p> <p>Finishes: Foundation Mica</p>
<p>Communications Fascia (UNELCM) (shown) and Metal International Power/ Communications Fascia (UNELIM)</p>		<p>A metal fascia with electrical and communication cut outs that mounts into a panel wall frame</p> <p>Heights: 7", 13", 22", 26", 28" and 37" h. Available for above and below worksurface mounting</p> <p>Widths: 7" to 27"h 24" - 96" in 6" increments 37"h. 24" - 60"w. in 6" increments</p> <p>Outlet Configurations: UNECLM 2 =one duplex outlet plus VDM 4 =two duplex outlets plus VDM -See chart see power communications fascias chart for size restrictions UNEILM 2 =cut out for two outlets 3 =cut out for two outlets and one data/ communications 4 =cut out for four outlets</p>	<p>5 =CALA sized cut out for two outlets 6 =CALA sized cut out for four outlets -See power communications fascias chart for size restrictions</p> <p>Cut Out Orientations: Horizontal L =left R =right C =centered B = both left and right -See power communications fascias chart</p> <p>Vertical T = top or upper section of fascia B =bottom or lower section of fascia F =flush (28"h. fascias flush to the floor) -See power communications fascias chart for size restrictions</p> <p>Finishes: Foundation Mica</p>

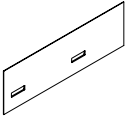
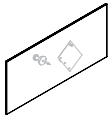
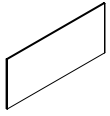

fascia basics (continued)

Product Name and Code	Illustration	Description	
<p>Metal Power/Communications Fascia for Freestanding District (Slot Mount) (UAELCM) and Metal International Power/Communications Fascia for Freestanding District (UAELIM)</p>		<p>A metal fascia with electrical and communication cut outs that mounts into panel wall frame with: Freestanding feet Accessory rail</p> <p>-The cut out locations are different than a UN__fascia to allow for the placement of freestanding feet below the panel</p> <p>Heights: 22", 28" and 35" h.</p> <p>-Sizes are nominal, actual sizes are 1/2" less to accommodate a support foot</p> <p>Widths: 36" - 96" in 6" increments</p> <p>Outlet Configurations: UAELCM 2 =one duplex outlet plus VDM 4 =two duplex outlets plus VDM</p> <p>-See power communications fascias chart for size restrictions</p> <p>UAELIM 2 =cut out for two outlets 3 =cut out for two outlets and one data/communications</p>	<p>4 =cut out for four outlets 5 =CALA sized cut out for two outlets 6 =CALA sized cut out for four outlets -See power communications fascias chart for size restrictions</p> <p>Cut out Locations: One cut out LL =left RR =right LC =left center RC =right center</p> <p>-See power communications fascias chart for size restrictions</p> <p>2 cut outs LR =left and right CR =left center and right CL =right center and left</p> <p>-See power communications fascias chart for size restrictions</p> <p>Finishes: Foundation Mica</p>
<p>Tackable Fabric Fascia (UNELF)</p>		<p>A tackable fascia that mounts into a panel wall frame</p> <p>Heights: 6", 7", 9", 13", 15", 21" 24", 26" 28", 30" and 37"h.</p> <p>Fascias are tackable in all heights except 6" and 7"</p>	<p>Widths: 24" - 96" in 6" increments</p> <p>Finishes: Fabric All standard Teknion panel fabrics</p>
<p>Tackable Fabric Fascia for Freestanding District (Slot Mount) (UAELF)</p>		<p>A tackable fascia that mounts into a panel wall frame with: Freestanding feet Accessory rail</p> <p>Heights: 6", 22", and 35"</p> <p>-Can only be mounted in the lowest level of the panel</p> <p>-Sizes are nominal, actual sizes are 1/2" less to accommodate a support foot</p>	<p>Widths: 24" - 96" in 6" increments</p> <p>Finishes: Fabric All standard Teknion panel fabrics</p>

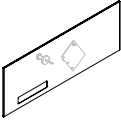
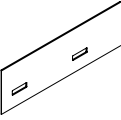
fascia basics (continued)

Product Name and Code	Illustration	Description	
<p>Tackable Fabric Power/ Communications Fascia (UNELCF) and Tackable Fabric International Power/ Communications Fascia (UNELIF)</p>		<p>A tackable fascia with electrical and communication cut outs that mounts into a panel wall frame</p> <p>Heights: 7", 13", 22", 26", 27" and 37"</p> <p>-Available for above and below worksurface mounting -Tackable in all heights except 7"h.</p> <p>Widths: 24" - 96" in 6" increments</p> <p>Outlet Configurations: UNELCF 2 =one duplex outlet plus VDM 4 =two duplex outlets plus VDM</p> <p>-See power communications fascias chart for size restrictions</p> <p>UNELIF 2 =cut out for two outlets 3 =cut out for two outlets and one data/ communications 4 =cut out for four outlets 5 =CALA sized cut out for two outlets 6 =CALA sized cut out for four outlets</p> <p>-See power communications fascias chart for size restrictions</p>	<p>Cut Out Orientations: Horizontal L =left R =right C =centered B = both left and right</p> <p>-See power communications fascias chart for size restrictions</p> <p>Vertical T =top or upper section of fascia B =bottom or lower section of fascia F =flush (28"h. fascias flush to the floor)</p> <p>-See power communications fascias chart for size restrictions</p> <p>Finishes: Fabric All standard Teknion panel fabrics</p>
<p>Tackable Fabric Power/ Communications Fascia for Freestanding District (UAELCF) and Tackable Fabric International Power/ Communications (UAELIF)</p>		<p>A tackable fascia with electrical and communication cut outs that mounts into panel wall frame with: Freestanding feet Accessory rail</p> <p>-The cut out locations are different than a UN__ fascia to allow for the placement of freestanding feet below the panel</p> <p>Heights: 22" and 35"h.</p> <p>-Sizes are nominal, actual sizes are 1/2" less to accommodate a support foot</p> <p>Widths: 36" - 96" in 6" increments</p> <p>Outlet Configurations: UAELCM 2 =one duplex outlet plus VDM 4 =two duplex outlets plus VDM</p> <p>-See power communications fascias chart for size restrictions</p> <p>UAELIM 2 =cut out for two outlets 3 =cut out for two outlets and one data/ communications</p>	<p>4 =cut out for four outlets 5 =CALA sized cut out for two outlets 6 =CALA sized cut out for four outlets</p> <p>-See power communications fascias chart for size restrictions</p> <p>Cut Out Locations: One cut out LL =left RR =right LC =left center RC =right center</p> <p>-See power communications fascias chart for size restrictions</p> <p>Two cut outs LR =left and right CR =left center and right CL =right center and left</p> <p>-See power communications fascias chart for size restrictions</p> <p>Finishes: Fabric All standard Teknion panel fabrics</p>

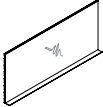
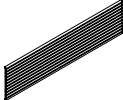
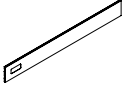
fascia basics (continued)

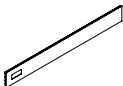
Product Name and Code	Illustration	Description	
<p>Whiteboard Fascia (UNEMB)</p>		<p>A whiteboard fascia that mounts into a panel wall frame -Available with or without a tray Heights: 22", 24", 30" and 37"h.</p>	<p>Widths: 36", 42" and 48"w. Finishes: Foundation Mica</p>
<p>Accessory Fascia (UNELA)</p>		<p>An accessory rail that mounts into a panel wall frame Heights: 6", 13" and 15"h Widths: 24" - 96"w. in 6" increments</p>	<p>Finishes: Foundation Mica</p>
<p>Metal Base Feed Fascia (UNELMB) (shown)</p>		<p>A 6"h. metal fascia with a cut out that allows power and communication cables to enter a panel wall frame at the base level Widths: 36" - 96"w. in 6" increments</p>	<p>Finishes: Foundation Mica</p>
<p>Metal Base Feed Fascia for Freestanding Application (UAELMB)</p>		<p>A 6"h. metal fascia with a cut out that allows power and communication cables to enter a freestanding panel wall frame at the base level -Height is nominal, actual sizes are 1/2" less to accommodate a support foot Widths: 36" - 96"w. in 6" increments</p>	<p>Cut Out Locations: Left Right Centered -See power communications fascias chart for location restrictions Finishes: Foundation Mica</p>
<p>Fabric Base Feed Fascia (UNELFB)</p>		<p>A 6"h. fabric fascia with a cut out that allows power and communication cables to enter a freestanding panel wall frame at the base level Widths: 24" - 96"w. in 6" increments Cut Out Locations: Left Right Centered -See power communications fascias chart for location restrictions</p>	<p>Finishes: Fabric All standard Teknion panel fabrics</p>

fascia basics (continued)

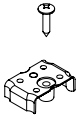
Product Name and Code	Illustration	Description
<p>Fabric Base Feed Fascia for Freestanding District (UAELEFB)</p>		<p>A 6"h. fabric fascia with a cut out that allows power and communication cables to enter a freestanding panel wall frame at the base level</p> <ul style="list-style-type: none"> -Height is nominal, actual sizes are 1/2" less to accommodate a support foot <p>Widths: 36" - 96"w. in 6" increments</p> <p>Locations: Left Right Centered</p> <ul style="list-style-type: none"> -See power communications fascias chart for location restrictions <p>Finishes: Fabric All standard Teknion panel fabrics</p>
<p>Fascia Clip Kit (UNELK)</p>		<p>Fascia Clips are required to mount clip-mounted fascias to a Convertible Panel Frame</p> <ul style="list-style-type: none"> -The quantity required varies depending on the size of the panel wall frame -Kits are available in packages of 25 or 100 clips

fascia basics (continued)

The following charts outline the number of clips required for each clip mounted fascia.

Panel Height	Panel Width	Number of Clips	
		Flush	Elevated
29	24	4	2
29	30	4	2
29	36	4	2
29	42	6	3
29	48	6	3
29	54	6	3
29	60	6	3
29	66	8	4
29	72	8	4
29	78	12	6
29	84	12	6
29	90	12	6
29	96	12	6
42	24	6	4
42	30	6	4
42	36	6	4
42	42	9	6
42	48	9	6
42	54	9	6
42	60	9	6
42	66	12	8
42	72	12	8
42	78	18	12
42	84	18	12
42	90	18	12
42	96	18	12

Panel Height	Panel Width	Number of Clips	
		Flush	Elevated
51	24	6	4
51	30	6	4
51	36	6	4
51	42	9	6
51	48	9	6
51	54	9	6
51	60	9	6
51	66	12	8
51	72	12	8
51	78	18	12
51	84	18	12
51	90	18	12
51	96	18	12
66	24	8	6
66	30	8	6
66	36	8	6
66	42	11	8
66	48	11	8
66	54	11	8
66	60	11	8
66	66	16	12
66	72	16	12
66	78	22	16
66	84	22	16
66	90	22	16
66	96	22	16

The following should be considered when planning with District Fascias.

clip-mounting vs. slot-mounting

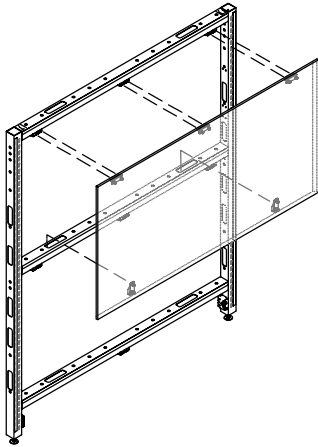

Fascias with Clips (“D” style)

- Intended to mount to Flush or Elevated Panels
- The clip on the fascia connects to the clip on the panel wall frame

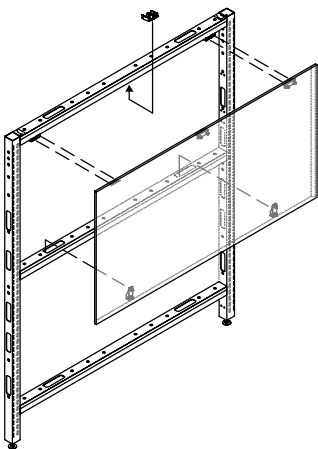

- Clip mounted fascias can also be mounted to a Convertible panel frame, however fascia clips will have to be installed on the panel wall frame (Fascia Clip Kit UNELK)

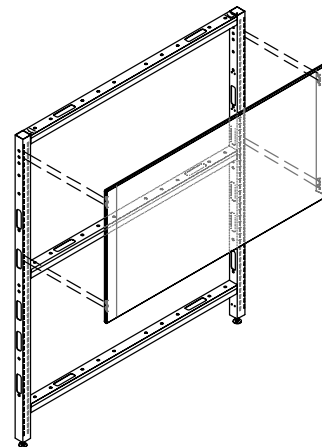

Slot Mounted Fascias (“L” style)

- Intended to mount to Convertible Panel Wall frames
- There are no clips on either the fascia or the frame, the fascias mount into the vertical slots of the frame
- Mounting into the slots will not interfere with slot accessibility for mounted storage or supports

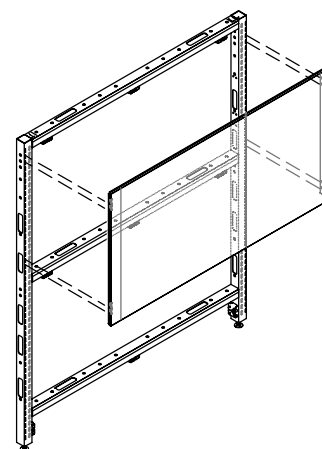

- Slot mounted fascias can also be mounted to a Flush or Elevated panel frame, however the existing clips on the frame will not be used

planning with fascias (continued)

fascia widths

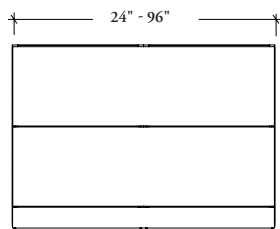

- Fascias can span the entire width of a panel wall frame regardless of whether it is made up of one or two frame sections as the fascias sit outside of the frame

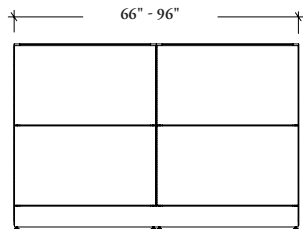

- On panel wall frames that are made up of two frame sections (66" or wider) two equally wide fascias can be specified, one mounting to each section

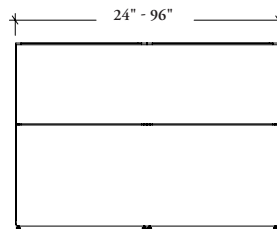

- Fascia widths can be different on opposite sides of a panel, and above and below the 29" high datum as long as they match the datum heights and the width of the panel frame sections

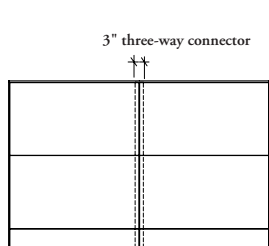
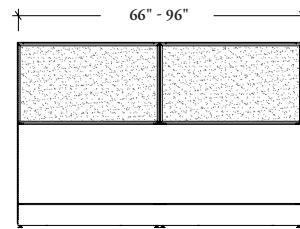

- Two Stretch Fascias span across a three-way connector to conceal the connector to provide a cleaner aesthetic
- A single stretch fascias **cannot** extend over two panel wall frames and the three-way connect, two fascias are required that meet in the middle of the connector

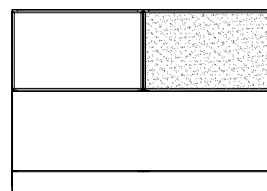
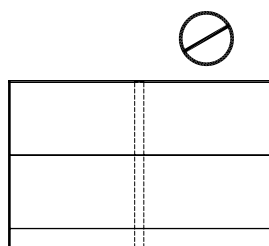

- Fascias above the 29" datum height are typically split to add functionality to a workstation

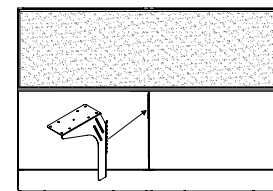

- Fascias below the 29" datum height are typically split when worksurface height-adjustability is required
- Height-adjustable cantilevers require the vertical slot on a panel wall to be exposed for mounting (see Supports section)

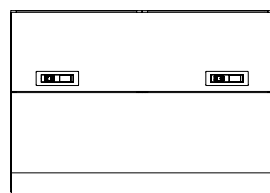

- Fascias above and below the worksurface can be split to achieve specific power/communication locations
- Fascia widths under 42" have cut outs available only in the center of the fascia, and fascia widths over 66" have power available only on the right or left side, so splitting fascias into smaller sizes can provide power closer to the center of the panel wall

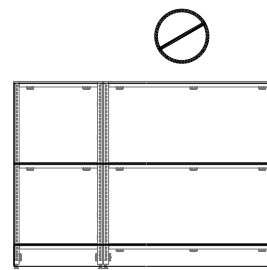
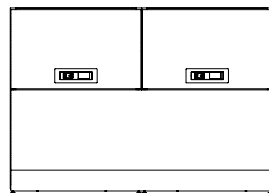

- A fascia over 66" w. must span across two equally sized frames
- Clip mounted fascias have specific clip locations that must line up with the locations on the frames
- Slot mounted fascias are often reinforced at the center point of the fascia so require the slots to attach to

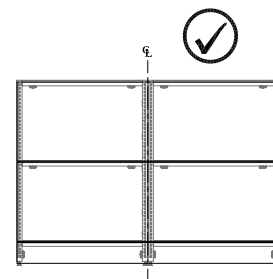

planning with fascias (continued)

fascia heights

- District fascias are available in a variety of heights to achieve different looks and levels of functionality
- The 6" and 29" h. are the only fixed rails

all panel heights (except 42" h)

- The 29" h. datum is always exposed

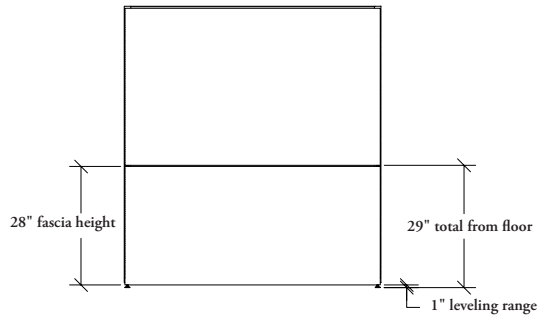

Monolithic aesthetic

- Segmentation only at the 29" datum height

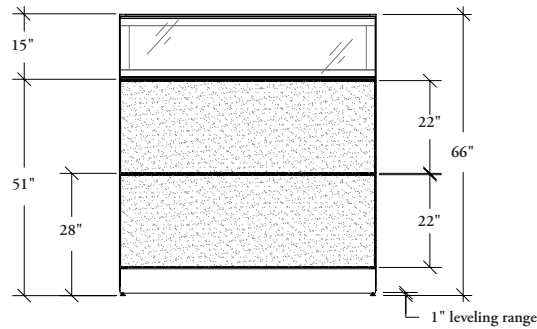

Above worksurface segmentation for added functionality

- If segmentation is required above the 29" h. rail, additional panel wall rails or light block rails are required (ex. above - one additional rail is required at the 51" h. datum)

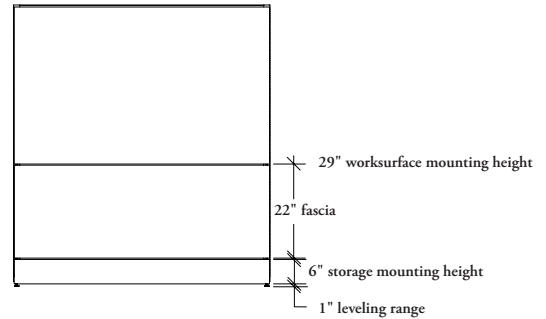

Below worksurface segmentation for added functionality

- 6" and 29" high horizontal segmentation allows for worksurface and storage mounting

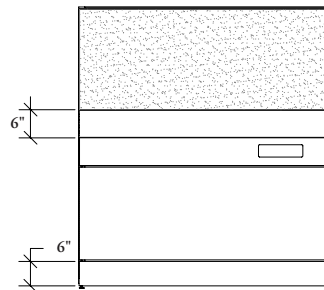

Reconfigurable fascias

- The same fascia can be used above and below the worksurface to add to the reconfigurability of a panel wall (ex. above - a 6" fascia is used at the base of the panel, and between 36" and 42" h.)

42" high panels only

- Monolithic fascias are available for 42" high panels only

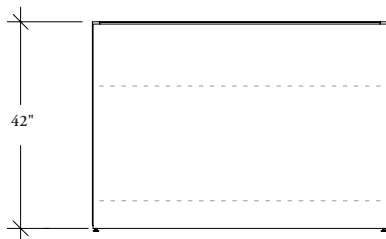

- A 41" h. fascia is used on a Flush or Conventional Panel Wall, and covers the 6" and 29" h. fixed rails

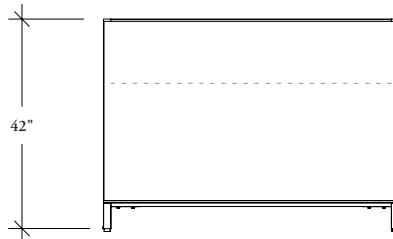

- A 35" h. fascia is used on an Elevated Panel Wall, and covers the 29" h. fixed rail

planning with window fascias

The following should be considered when planning with District Window Fascias.

- Window fascias mount into a panel wall frame, they do **not** mount above the frame

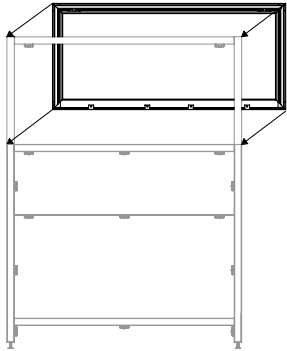

- A panel wall frame up to 60" w. is only one frame section so can accommodate a single window fascia

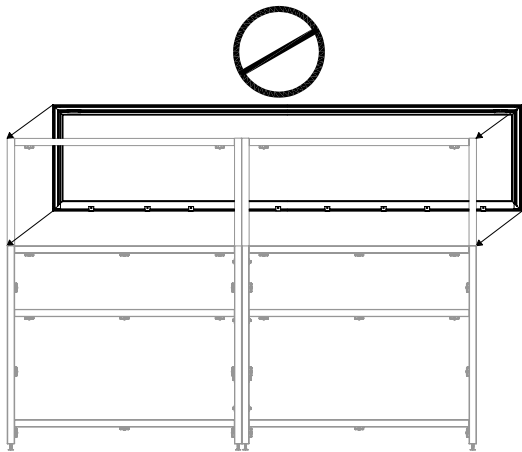

- A panel wall frame 66" w and wider consists of two frame sections
- It **cannot** accommodate a single window fascia

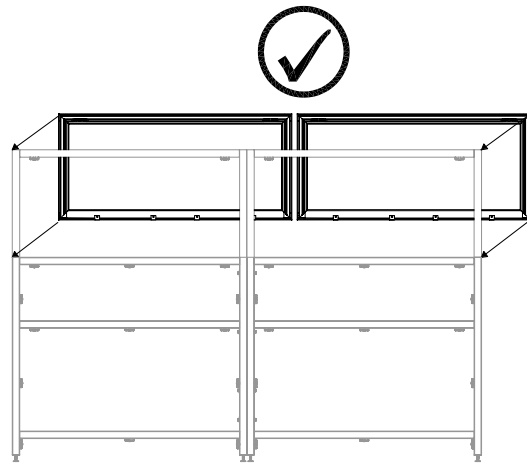

- Two equally sized windows must be specified, one will fit into each section of the panel wall frame

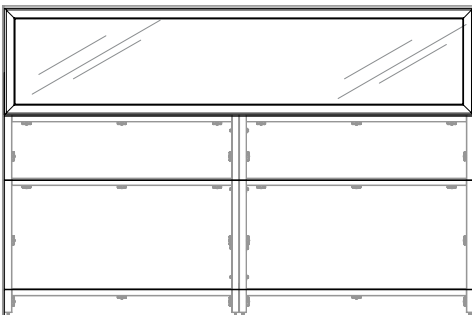

- If a single span of glass is desired for panels over 60" wide, the window / UNEWR must be used as it mounts above the frame

planning with power communications fascias on non freestanding panels

Power and Communication Fascia cut outs are available in a variety of locations depending on the size of the fascia. The following chart is an overview of the available locations.

fascias for non freestanding panels

- UNECL Solid Power Communications Fascia (Clip Mount)
- UNEIL Solid International Power Communications Fascia (Clip Mount)
- UNELCM Metal Power/Communications Fascia (Slot Mount)
- UNELIM Metal International Power Communications Fascia (Slot Mount)
- UNELCF Tackable Fabric Power/Communications Fascia (Slot Mount)
- UNELIF Tackable Fabric International Power Communications Fascia (Slot Mount)



		Horizontal Power/Communication Orientation													Vertical Power/Communications Orientation									
		Fascia Widths													Fascia Heights									
		24	30	36	42	48	54	60	66	72	78	84	90	96	7	13	21	22	27	28	37			
L-Left	All outlet configurations														T top									
R-Right	All outlet configurations														B bottom									
B-Both	All outlet configurations														F flush									
C-Center	2 (2 outlets)																							
	3 (2 outlets and 2 data)																							
	4 (4 outlets)																							
	5 (2 outlets CALA)																							
	6 (4 outlets CALA)																							

planning with power communications fascias on non freestanding panels (continued)

horizontal power/communications orientation

single width

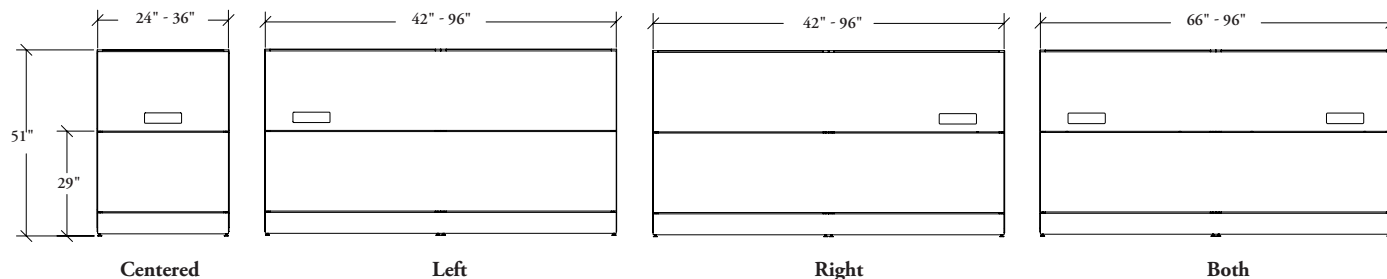

Duplex outlet plus VDM (2)

- UNECL Solid Power Communication Fascia
- UNELCM Metal Power Communication Fascia
- UNELCF Fabric Power Communication Fascia

Cut Out for two outlets (2)

- UNEIL International Solid Power Communication Fascia
- UNELIM International Metal Power Communication Fascia
- UNELIF International Fabric Power Communication Fascia

double width

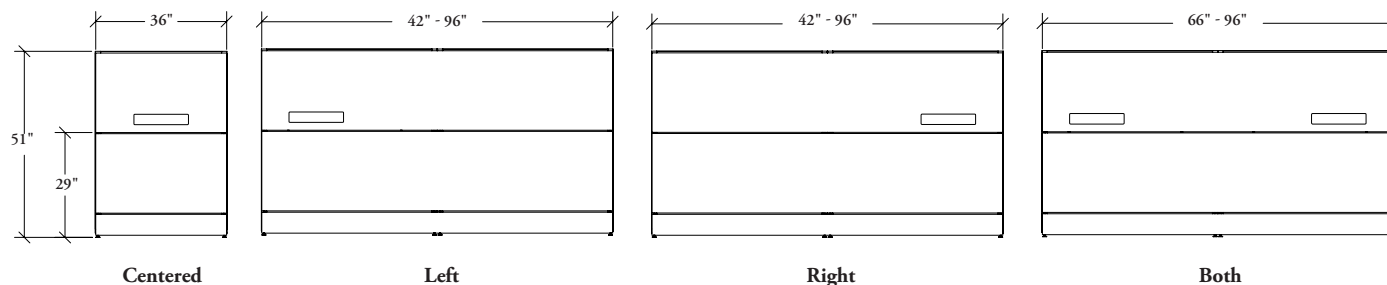

Cut Out for two outlets and one data/communications (3)

- UNEIL International Solid Power Communication Fascia
- UNELIM International Metal Power Communication Fascia
- UNELIF International Fabric Power Communication Fascia

CALA Cut Out for two outlets (5)

- UNEIL International Solid Power Communication Fascia
- UNELIM International Metal Power Communication Fascia
- UNELIF International Fabric Power Communication Fascia

Cut Out for two duplex outlets plus VDM (4)

- UNECL Solid Power Communication Fascia
- UNELCM Metal Power Communication Fascia
- UNELCF Fabric Power Communication Fascia

CALA Cut Outs for four outlets (6)

- UNEIL International Solid Power Communication Fascia
- UNELIM International Metal Power Communication Fascia
- UNELIF International Fabric Power Communication Fascia

planning with power communications fascias on non freestanding panels (continued)

vertical power/communication orientation

top location

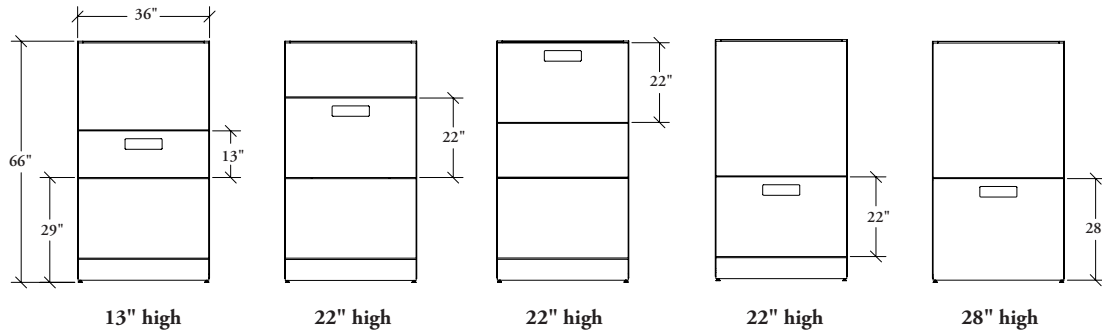

bottom location

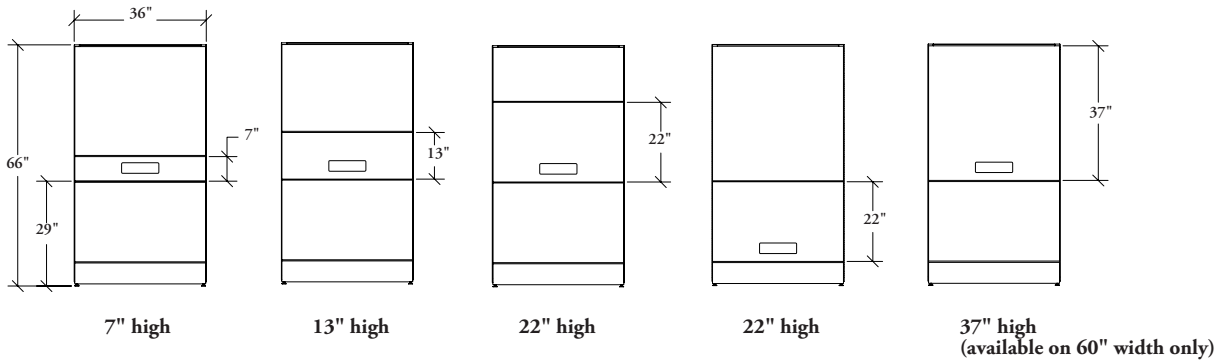

flush location

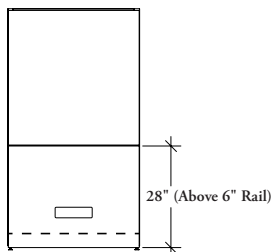

- When a power and communications fascia is installed on one side of a panel wall only, certain fascias, certain restrictions apply
- A solid fascia is the only clip mounted fascia that can be used on the opposite side
- All slot mounted fascias can be used on the opposite
- If a segmentation is required above the fascia, a light block rail must be used and it must be rotated 90° to allow more room inside of the panel frame

planning with power communications fascias on freestanding panels

Power and Communication Fascia cut outs are available in a variety of locations depending on the size of the fascia. The following chart is an overview of the available locations.

fascias for freestanding panels and panels with accessory rail

- UAECL Solid Power Communications Fascia (Clip Mount) for Freestanding District
- UAELI Solid International Power Communications Fascia for Freestanding District (Clip Mount)
- UAELCM Metal Power Communications Fascia for Freestanding District (Slot Mount)
- UAELIM Metal International Power Communications Fascia for Freestanding District (Slot Mount)
- UAELCF Tackable Fabric Power Communications Fascia for Freestanding District (Slot Mounted)
- UAELIF Tackable International Fabric Power Communications Fascia for Freestanding District (Slot Mounted)

Horizontal Power/Communication Orientation														Vertical Power/Communications Orientation							
		Fascia Widths												Fascia Heights							
		24	30	36	42	48	54	60	66	72	78	84	90	96	7	13	21	22	27	28	37
Left (L)	2 (2 outlets), 5 (2 outlets CALA)													Top (T)							
Right (R)	2 (2 outlets), 5 (2 outlets CALA)													Bottom (B)							
Left Center (LC)	2 (2 outlets), 5 (2 outlets CALA)													Flush (F)							
Right Center (RC)	2 (2 outlets), 5 (2 outlets CALA)																				
Left and Right (LR)	3 (2 outlets and 2 data), 4 (4 outlets), 6 (4 outlets CALA)																				
Left Center and Right (CR)	3 (2 outlets and 2 data), 4 (4 outlets), 6 (4 outlets CALA)																				
Right Center and Left (CL)	3 (2 outlets and 2 data), 4 (4 outlets), 6 (4 outlets CALA)																				

Available
 Not Available

planning with power communications fascias on freestanding panels (continued)

electrical/communication outlet locations

- Careful attention is required when planning with UA_ Power Communication Fascias.
- The support on the freestanding foot extends from the bottom of the panel to the top, so no electrical can be placed above it
- The UA_ fascia has additional location options to accommodate this

The UA_ fascia is not available 24" or 30"w, when these sizes are required a UN_ power communication fascia must be used
UN_ fascias can be used in freestanding applications, as long as the cut out location is not over a freestanding foot

fascias 36" - 60"

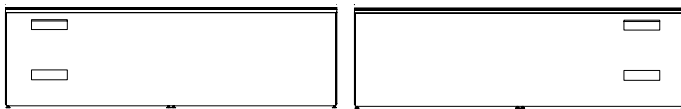

Left (LL)

Right (RR)

fascias 66" - 96"

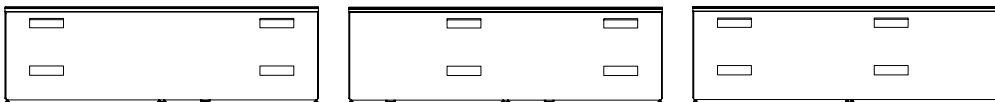

Left and Right (LR)

Left Center and Right (LC)

Right Center and Left (RC)



Left Center (LC)

Left Center (RC)

planning with power communications fascias on freestanding panels (continued)

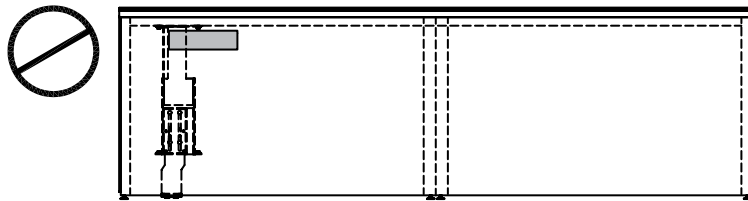

The following are recommended configurations for planning power/communication and support foot locations.

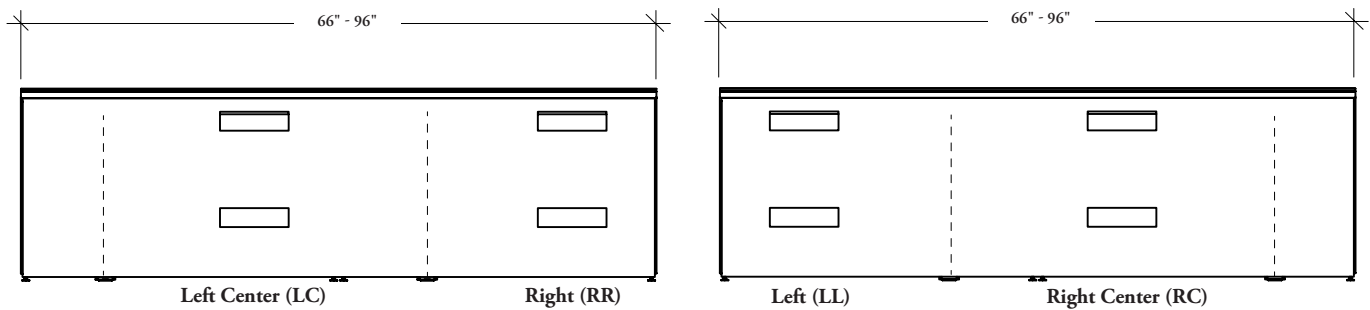

base feed fascias

Base Feed Fascias provide a cut out location for bringing power and communications wires into a workstation. The cut out locations vary depending on the width of the panel frame.

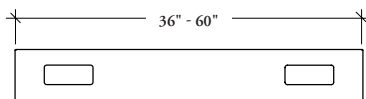

- When a 36" - 60" wide fascia is specified the Left and Right cut out will be justified to the outer sides of the fascia

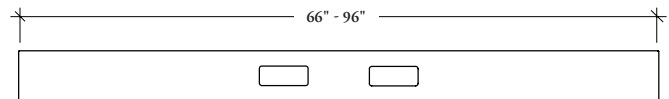

- When a 66" - 96" wide fascia is specified the Left and Right cut out will be justified to the center of the frame

power spine

power spine

UNDERSTANDING POWER SPINE	66
POWER SPINE BASICS	69
PLANNING WITH POWER SPINE PANELS & PANEL SPINE SUPPORT KIT FRAMES.	72
PLANNING WITH POWER SPINE ELECTRICS	79
POWER SPINE LATERAL FLOOR SCREENS BASICS	81
PLANNING WITH POWER SPINE LATERAL FLOOR SCREENS.	82
POWER SPINE WORKSURFACE UNDERSTANDING	85
POWER SPINE WORKSURFACE AND WORKSURFACE SUPPORT BASICS	86
PLANNING WITH POWER SPINE WORKSURFACE.	91
PLANNING WITH POWER SPINE RECTANGLE WORKSURFACE	94
PLANNING WITH POWER SPINE ZIG ZAG PANEL AND WORKSURFACE.	96
PLANNING WITH POWER SPINE 120 HUB AND WORKSURFACE	97
POWER SPINE HISPACE QUICK CONNECT TABLE BASICS	98
PLANNING WITH POWER SPINE HISPACE QUICK CONNECT TABLE.	101

understanding power spine

District Power Spine offers a simple and cost effective way to divide space and route power and data. It is available in Linear, Zigzag and 120 Hub profiles.

linear profile

Power Spine provides affordable power delivery, flexible planning and simple to specify linear planning.



zig zag profile

Zig Zag Power Spine provides an unique expression that gives the user the feeling of their own corner or nook.



120 hub profile

This 120-degree Hub offers privacy for heads down work, while optimizing the space in any office environment.



understanding power spine (continued)

Power Spine is designed to match the style of District although it is not a panel, it is a power spine. It has unique components and uses many components from District to complete a power spine configuration.

The unique components include:

- panel frame
- support kit
- lateral screens
- worksurface kits
- power spine specific to hiSpace tables

The shared District components include:

- fabric and metal fascias
- top and end trims
- add-on glass and felt screens
- desk mounted screens
- electrics

It can be planned in linear, zig zag and 120 hub configurations.

The Power Spine features a 15" high opening at the bottom of the panel.

Two frame heights are available:

- 29" (accepts a 13" add-on for an overall height of 42")
- 42" (accepts a 9" add-on for a maximum overall height of 51")

Power Spine can be planned for various applications from freestanding height-adjustable tables to fixed worksurfaces to casual lounge environments.

The following typical demonstrate layouts possible with Power Spine.

with height-adjustable tables

Mobile furniture and height-adjustable tables can be placed along the spine to meet task-intensive needs, yet still allow the furniture to be repositioned as needed.

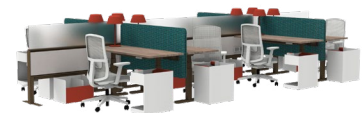

understanding power spine (continued)

with fixed worksurfaces

Semi-suspended worksurfaces combined with floor screens provide a more conventional workstation.



with casual lounge furniture

The spine provides space division and power access in casual environments and open collaborative spaces.



The Power Spine structure consists of a frame and support kit. End and top trims, fascias, screens and electrical components are added from the District offering.

linear

Power Spines are specified the complete length of the configuration and not as individual modules.

The Support Kit is also specified the complete length so that the proper amount of feet and posts are included.

- Module Widths: 48", 60", 72", 84"
- Overall Widths: 96", 120", 144", 144A", 168", 180", 192", 216", 240", 288", 252", 336"

Power Spine widths over 240" require lateral screens at the ends for support.

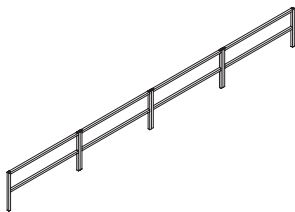
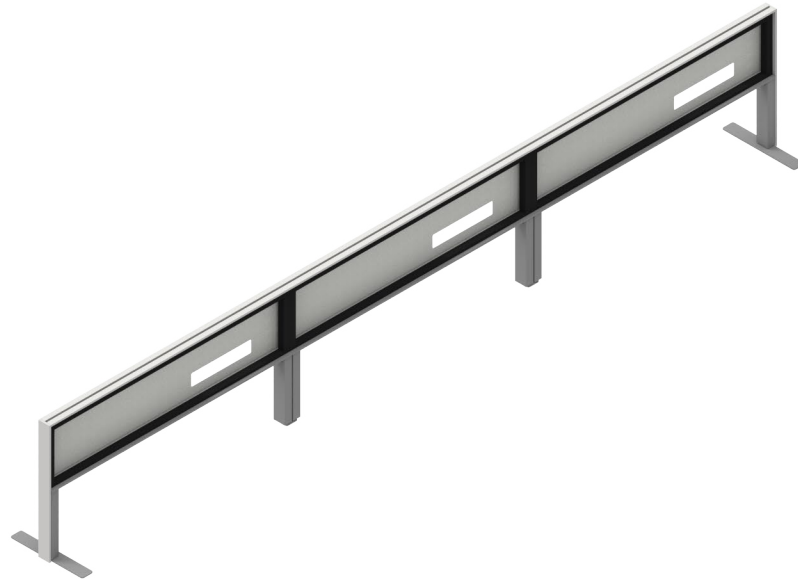

Power Spine Panel (UNPZ)

- Height: 29"
- Compatible with:
 - Standard District Top Trims
 - Panel Wall Add-On Screens - Glass
 - Panel Wall Add-On Screens - Felt
- Can accommodate semisuspended worksurfaces since the mounting channel at 29" high remains accessible
- 13" fabric or metal fascias are specified with this frame

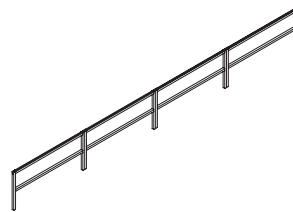

Power Spine Inset Panel (UYPZ)

- Height: 29", 42"
- Compatible with:
 - District Panel Top Trim for Panels with Inset Glass (6mm and 10mm)
 - District Panel Top Trim for Panels with Inset Smooth Felt
 - Panel Top Trim for Panels with Inset Glass
 - Panel Glass Blade for Panels with Inset Glass (6mm and 10mm)
 - Smooth Felt Blade for Panels with Inset
- 13" fabric or metal fascias are specified on the 29" high frame
- 26" fabric or metal fascias are specified on the 42" high frame
- Cannot accommodate worksurfaces on the 29" high frame
 - The 29" high datum is inaccessible due to the frame structure for inset glass or felt screens
 - 42" high panel
 - The 29" high datum is covered by the 26" high fascia

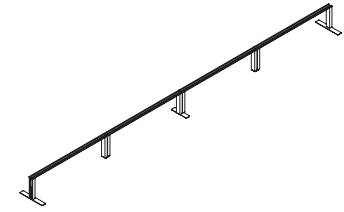

Power Spine Support Kit (UZPK)

- Height: 29", 42"
- Components include:
 - bottom trim
 - leg covers
 - large or medium feet
- Support Types:
 - no support post
 - with center support post
 - with offset support post
- Large feet are 18" deep
- Medium feet are 12" deep
- The number of large and medium is dependent on support kit selected
- Finishes:
 - Foundation
 - Mica
 - Accent

power spine basics (continued)

zig zag

Zig Zag Power Spines are specified the complete length of the configuration and not as individual modules. Includes a centralized single post at each junction.

The Support Kit is also specified the complete length so that the proper amount of feet and posts are included.

The Zig Zag spine is offered in spine lengths of three, four or five segments of standard module sizes, where the in line Power Spine is limited to four.

- Standard Height: 29"
- Inset Height: 29", 42"
- Module Widths: 48", 60", 72", 84"
- Overall Widths: 14A, 180", 192", 216", 240", 24A, 252", 288", 300", 336", 360", 420"

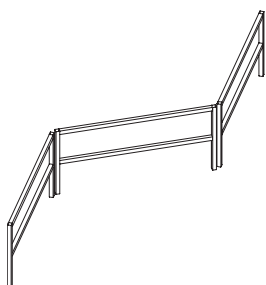

Power Spine Zig Zag (UNZZ)

- Height: 29"
- Compatible with:
 - Standard District Top Trims
 - Panel Wall Add-On Screens - Glass
 - Panel Wall Add-On Screens - Felt
- Can accommodate semisuspended worksurfaces since the mounting channel at 29" high remains accessible
- 13" fabric or metal fascias are specified with this frame

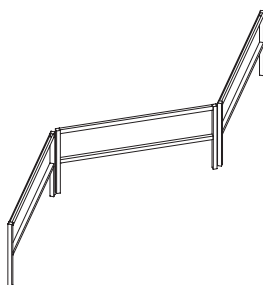

Power Spine Zig Zag Inset Panel (UYZZ)

- Height: 29", 42"
- Compatible with:
 - District Panel Top Trim for Panels with Inset Glass (6mm and 10mm)
 - District Panel Top Trim for Panels with Inset Smooth Felt
 - Panel Top Trim for Panels with Inset Glass - Panel Glass Blade for Panels with Inset Glass (6mm and 10mm)
 - Smooth Felt Blade for Panels with Inset
- 13" fabric or metal fascias are specified on the 29" high frame
- 26" fabric or metal fascias are specified on the 42" high frame
- Cannot accommodate worksurfaces on the 29" high frame
 - 29" high datum is inaccessible due to the frame structure for inset glass or felt screens
 - 42" high panel
 - The 29" high datum is covered by the 26" high fascia

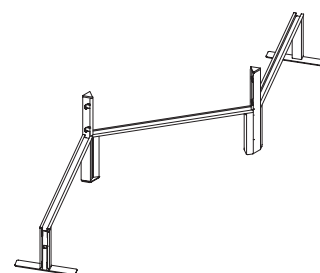

Power Spine Zig Zag Support Kit (UZZK)

- Height: 29", 42"
- Components include:
 - top cap
 - vertical trims
 - connectors
 - gaskets
 - shared feet
 - bottom trims and covers
 - 2 large feet
 - support feet
 - leg covers
- Large feet are 18" deep
- Finishes:
 - Foundation
 - Mica
 - Accent

power spine basics (continued)

120 hub panel

The 120 Hub consists of 3 panels in a 120 degree configuration and is specified as a complete frame. The Support Kit is also specified as a complete unit.

- Standard Height: 29"
- Inset Height: 29", 42"
- Module Widths: 48", 60"

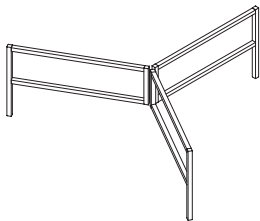

Power Spine 120 Hub (UNYH)

- Height: 29"
- Compatible with:
 - Standard District Top Trims
 - Panel Wall Add-On Screens - Glass
 - Panel Wall Add-On Screens - Felt
- Can accommodate semi-suspended worksurfaces since mounting channel at 29" high remains accessible
- 13" fabric or metal fascias are specified with this frame

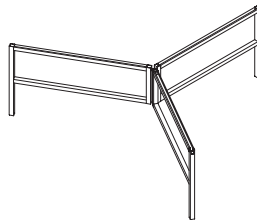

Power Spine 120 Hub Inset Panel (UZYH)

- Height: 29", 42"
- Compatible with:
 - District Panel Top Trim for Panels with Inset Glass (6mm and 10mm)
 - District Panel Top Trim for Panels with Inset Smooth Felt
 - Panel Top Trim for Panels with Inset Glass
 - Panel Glass Blade for Panels with Inset Glass (6mm and 10mm)
 - Smooth Felt Blade for Panels with Inset
- 13" fabric or metal fascias are specified on the 29" high frame
- 26" fabric or metal fascias are specified on the 42" high frame
- Cannot accommodate worksurfaces on the 29" high frame
 - 29" high datum is inaccessible due to the frame structure for inset glass or felt screens
 - 42" high panel
 - The 29" high datum is covered by the 26" high fascia

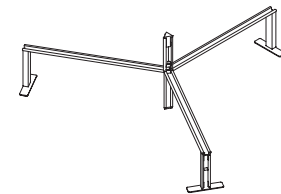

Power Spine 120 Hub Support Kit (UZYK)

- Height: 29", 42"
- Components include:
 - top cap
 - connectors
 - gaskets
 - central post
 - bottom trims
 - 3 med feet are 12" deep
- Finishes:
 - Foundation
 - Mica
 - Accent

planning with power spine panels & panel spine support kit frames

The following should be considered when planning with Power Spine Panels and Panel Spine support kits.

Two frame types are available for Linear, Zigzag and Hub Power Spine Panels.

power spine panel

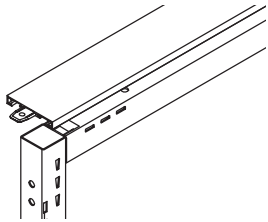

- Accepts a standard top trim
- If an add-on is desired, the top trim is replaced with a standard Panel Wall Add-On Screen – Glass or Felt Screen
- Must be used when semi-suspended worksurfaces are specified to allow access to the horizontal mounting rail

power spine inset panel

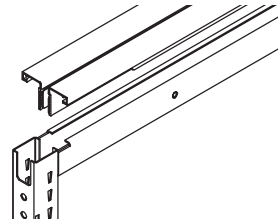

- Accepts a Panel Top Trim with Inset Glass or Felt
- **Cannot** be used when semi-suspended worksurfaces are specified as there is no horizontal mounting rail available

End trims, top trims and fascias are specified from the standard District product offering for all Panel Spine types:

- One metal or fabric fascia is required on each side of a module

linear power spine

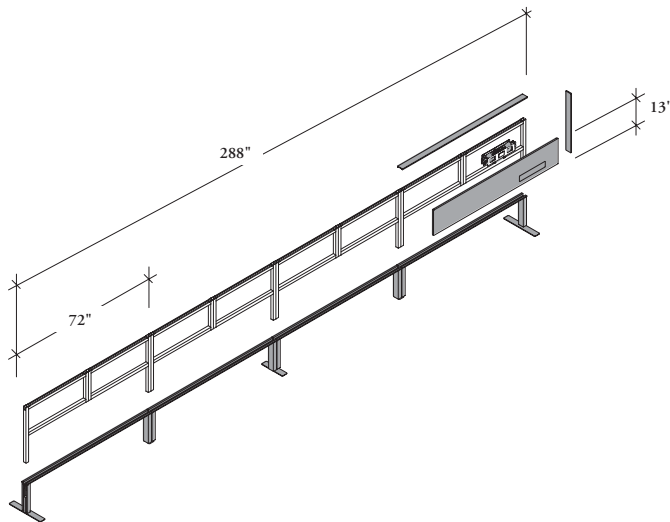

Example: 288" Power Spine
- Panels 29" high consisting of four 72" wide modules

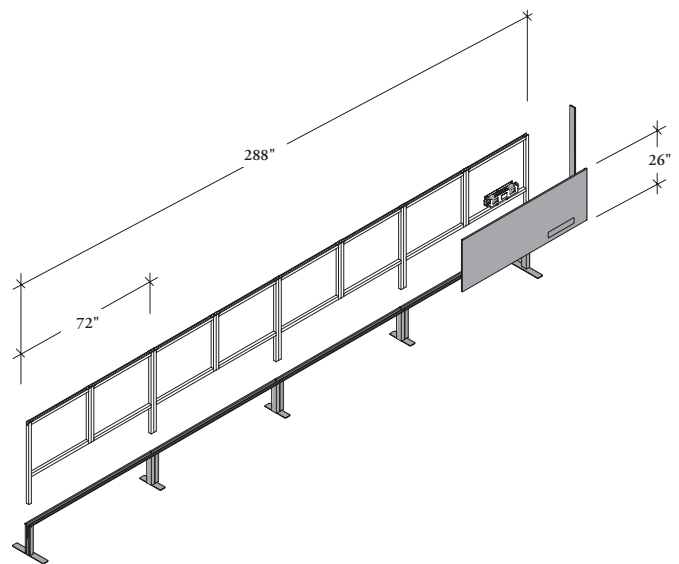

Example: 288" Power Spine
- Panels 42" high consisting of four 72" wide modules

planning with power spine panels & panel spine support kit frames (continued)

zig zag spine

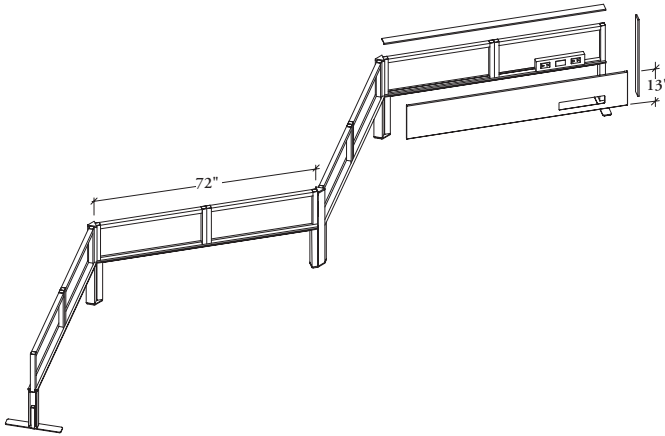

Example: 288" Power Spine
- Panels 29" high consisting of four 72" wide modules

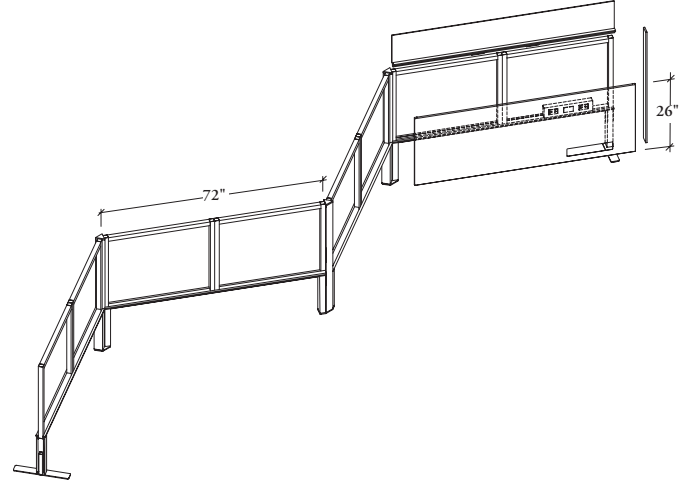

Example: 288" Power Spine
- Panels 42" high consisting of four 72" wide modules

power spine 120 hub

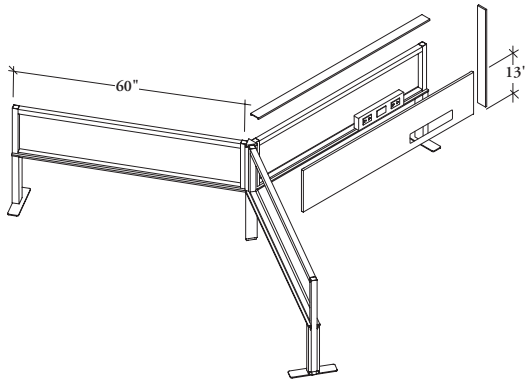

Example: 288" Power Spine
- Panels 29" high consisting of three 60" wide modules

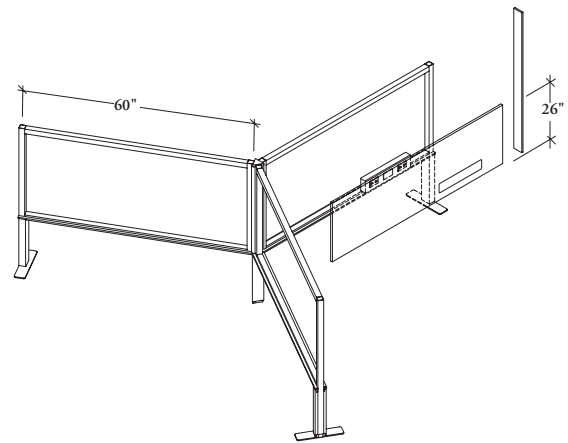

Example: 288" Power Spine
- Panels 42" high consisting of three 60" wide modules

planning with power spine panels & panel spine support kit frames (continued)

Linear Power Spine frames are available in three configurations.

All support kits have a foot at each end as well as additional feet and support along the length depending on the size and configuration.

No Support (N)

Allows for large spans without feet in these conditions:

- When no add-ons are used
- When felt screen add-ons are used

Cannot be used with glass add-on screens.

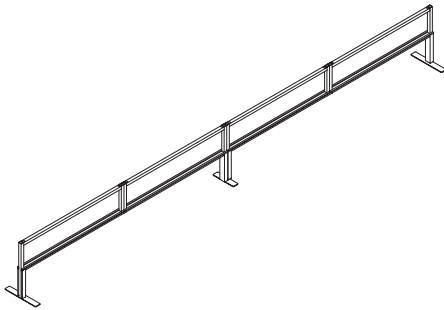

29" high frame shown

Center Support (C)

- Used when glass panel add-ons are used
- It provided the additional support required for the glass

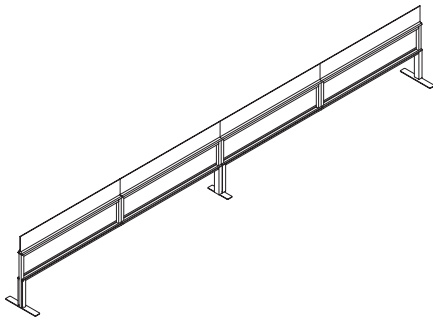

29" high frame shown.

Offset Support Post (F)

The offset placement allows for less visible support locations on a spine and is used when:

- When no add-ons are used
- When felt screen add-ons are used

Cannot be used with glass add-on screens.

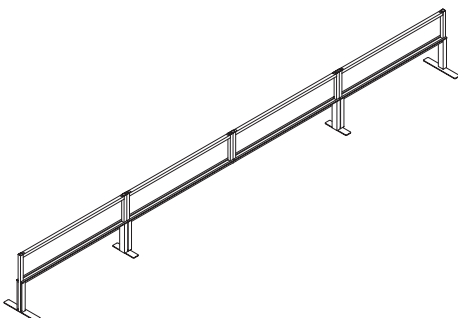

29" high frame shown

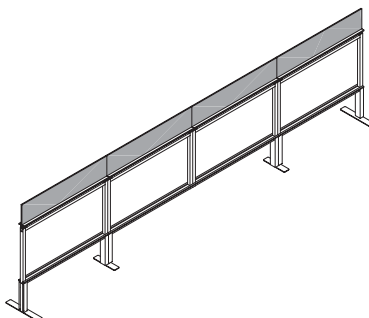

42" high frame shown

planning with power spine panels & panel spine support kit frames (continued)

the power spine zig zag panel always has a center support

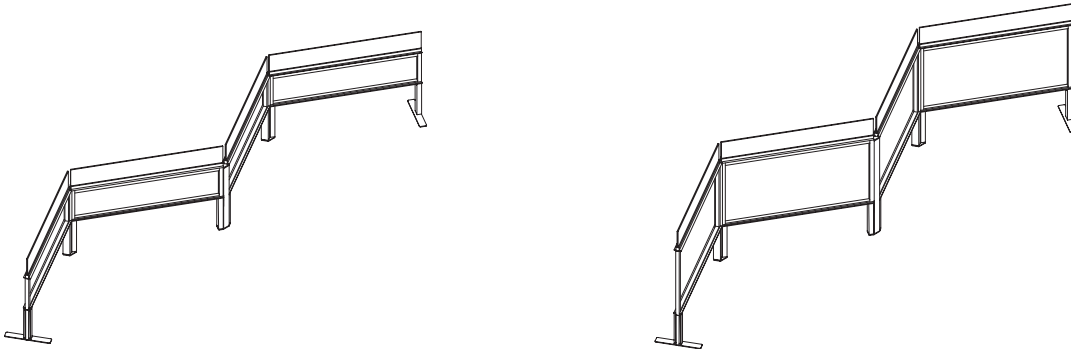

the power spine 120 hub panel always has a center support

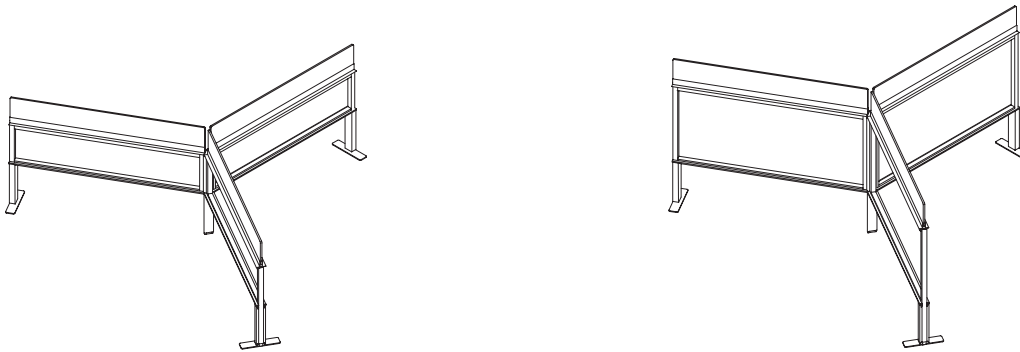

planning with power spine panels & panel spine support kit frames (continued)

Additional rules also apply when planning with Power Spine Linear.

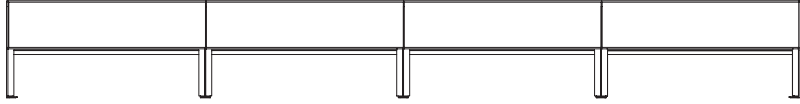

Any spine run length can be done as long as there is a support foot every 96".

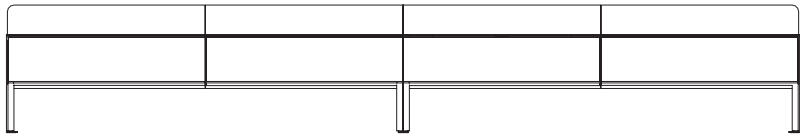

Any 29" high Power Spine with no centre support or offset support must be planned with a Smooth Felt Add On on top of the Power Spine.

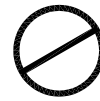
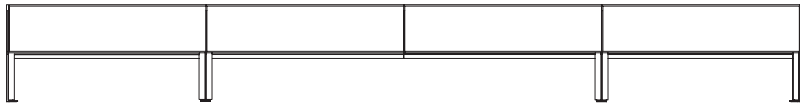

Spine Frame at 29" high with 120", 180" or 240"W without Felt or Add-on Screens cannot plan with any offset (F) or no support (N) options.

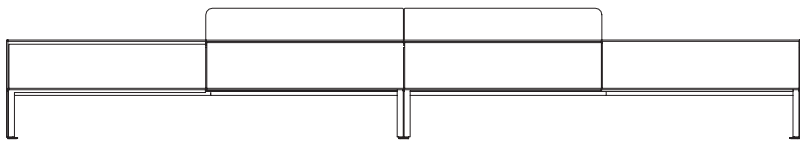

Spine runs with a span of 120" must be planned with a continuous PET Panel Wall Add-On Screens.

Cannot span only a partial width.











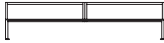
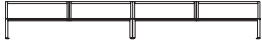

Any type of add-on screens should run the entire length of the spine.

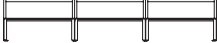
planning with power spine panels & panel spine support kit frames (continued)



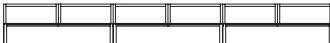







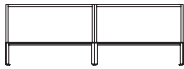
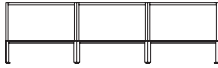
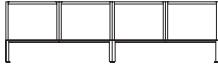
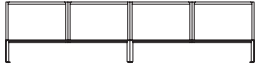

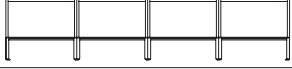
Each support kit type includes options for

- large support legs
- support leg covers
- horizontal support rails

The following chart outlines all options and what is included with each

29" Height	No Center Support Post	Support Kit
96" width		Two large support legs, two support leg covers and two horizontal support rails
120" width		Two large support legs, two support leg covers and two horizontal support rails
192" width		One medium support leg, two large support legs, four support leg covers and four horizontal support rails
240" width		One medium support leg, two large support legs, four support leg covers and four horizontal support rails
42" Height	No Center Support Post	Support Kit
96" width		Two support legs, two support leg covers and two horizontal support rails
192" width		One medium support leg, two large support legs, four support leg covers and four horizontal support rails
29" Height	Center Support Post	Support Kit
120" width		One medium support leg, two large support legs, four support leg covers and two horizontal support rails
14A width (144" – 3x48" w panels)		Two large support legs, four support leg covers, two support posts and three horizontal support rails
144" width		Two large support legs, four support leg covers, two support posts and two horizontal support rails
168" width		Two large support legs, one medium support leg, two supports, four leg covers and two horizontal support rails
180" width		Two large support legs, two medium support legs, six support leg covers and three horizontal support rails
192" width		One medium support leg, two large support legs, eight support leg covers, two support posts and four horizontal support rails
216" width		Two medium support legs, two large support legs, four support leg covers and three horizontal support rails
240" width		One medium support leg, two large support legs, two support posts, eight support leg covers, four support posts and four horizontal support rails
252" width		Two medium support legs, two large support legs, four support leg covers and three horizontal support rails
288" width		One medium support leg, two large support legs, two support posts, eight support leg covers, two support post and four horizontal support rails
336" width		Two medium support legs, two large support legs, one support post, eight support leg covers and four horizontal support rails

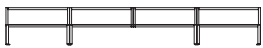
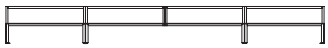
planning with power spine panels & panel spine support kit frames (continued)

42" Height	Center Support Post	Support Kit
120" width		One medium support legs, two large support leg, four support leg cover and two horizontal support rails
14A width (144" – 3x48"w panels)		Two support posts, two large support legs, six support leg covers and three horizontal support rails
144" width		One medium support leg, two large support legs, four support leg covers and two horizontal support rails
168" width		One medium support leg, two large support legs, four support leg covers and two horizontal support rails
180" width		Two medium support legs, two large support legs, six support leg covers and three horizontal support rails
192" width		One medium support leg, two large support legs, four support leg covers, two support post and four horizontal support rails
216" width		Two medium support legs, two large support legs, six support leg covers and three horizontal support rails
240" width		One medium support leg, two large support legs, eight support leg covers, two support post and eight horizontal support rails
252" width		Two medium support legs, two large support legs, four support leg covers and three horizontal support rails
288" width		Three medium support legs, two large support legs, ten support leg covers and four horizontal support rails
336" width		Three medium support legs, two large support legs, ten support leg covers and four horizontal support rails
29" Height	Offset Support Post	Support Kit
14A width (144" – 3x48"w panels)		One support post, two large support legs, four support leg covers and three horizontal support rails
180" width		Two large support legs, one medium support leg, four support leg covers and three horizontal support rails
192" width		Two medium support legs, two large support legs, six support leg covers, two support post and four horizontal support rails
240" width		Two medium support legs, two large support legs, six support leg covers, four support post and four horizontal support rails
42" Height	Offset Support Post	Support Kit
14A width (144" – 3x48"w panels)		One support post, two large support legs, four support leg covers and three horizontal support rails
192" width		Two medium support legs, two large support legs, four support leg covers and four horizontal support rails

planning with power spine electrics

The following should be considered when planning with power spine electrics.

The Power Spine uses standard District electrics.

The frame includes the following:

- Specific pass through for data cables with a capacity of 12 CAT6A cables (100% fill rate)
- Standard pass-through for power harnesses
- A cut out on the bottom frame to allow a base feed or ceiling feed to be installed in the interior of the frame

The following demonstrates how power enters Linear, Zig Zag or 120 Hub Power Spines.

ceiling feed

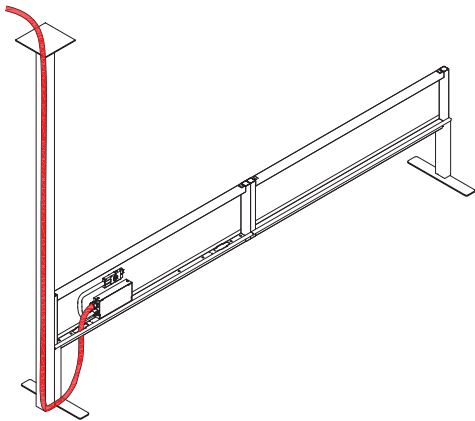

- The liquid cable extends through the cut out in the bottom of the frame, over the foot and into the power pole
- It then routes up to the ceiling

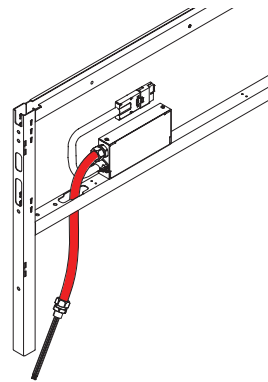

The base feed has a liquid tight cable that extends through the cut out in the bottom of the frame to the floor and remains exposed.

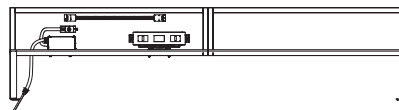
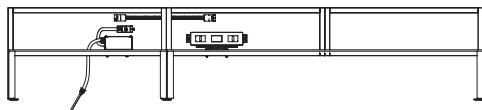
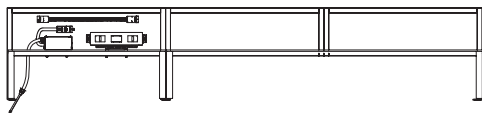

- On frame modules 48" wide the base feed and power module must be placed in separate frame modules
- 48" wide frame modules cannot accommodate both a base feed and power module, there isn't sufficient space for both

On frame modules 60" wide or wider, both can be placed in the same module.

planning with power spine electric (continued)

Zig Zag and 120 Hub configurations have specific electrical requirements.

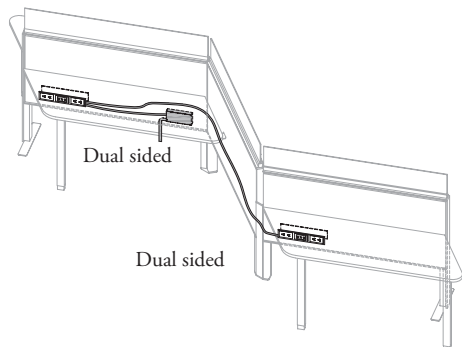

- In Power Spine Zig Zag configurations with parallel worksurfaces, longer harnesses will be required to make up the distance between power boxes
- Routing multiple harnesses through the connections is not recommended

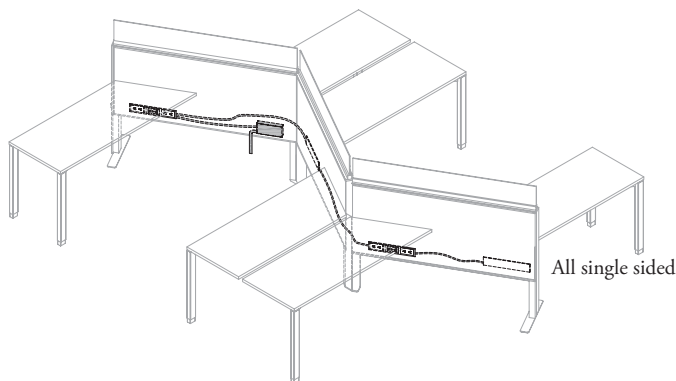

- In Power Spine Zig Zag configurations with dual perpendicular worksurfaces, power access will be limited to one power module for two users
- Parallel planning is best suited for the smaller 48" & 60" modules where Perpendicular planning is better for the larger modules to sufficient back to back space for the users

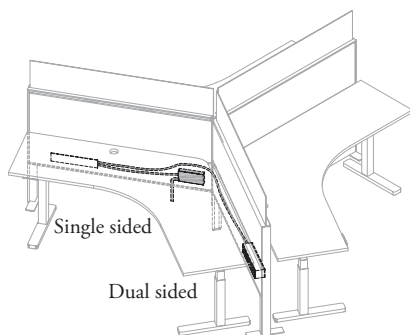

- When the Power Spine 120 Hub panel modules are 48" wide, the basefeed kit and power box cannot be in the same module
- The base feed will have to be installed on the exterior of the panel

power spine lateral floor screens basics

Lateral floor screens attach perpendicularly to the panel frame to provide privacy at ends and between users.

- Lateral floor screens are available for end and mid run applications
- Available solid or with glass
- A support foot is required on screens 48" w or larger when not mounted to a worksurface
- Provide support to panel runs
- Lateral Floor Screens are not available for Zig Zag or 120 Hub planning

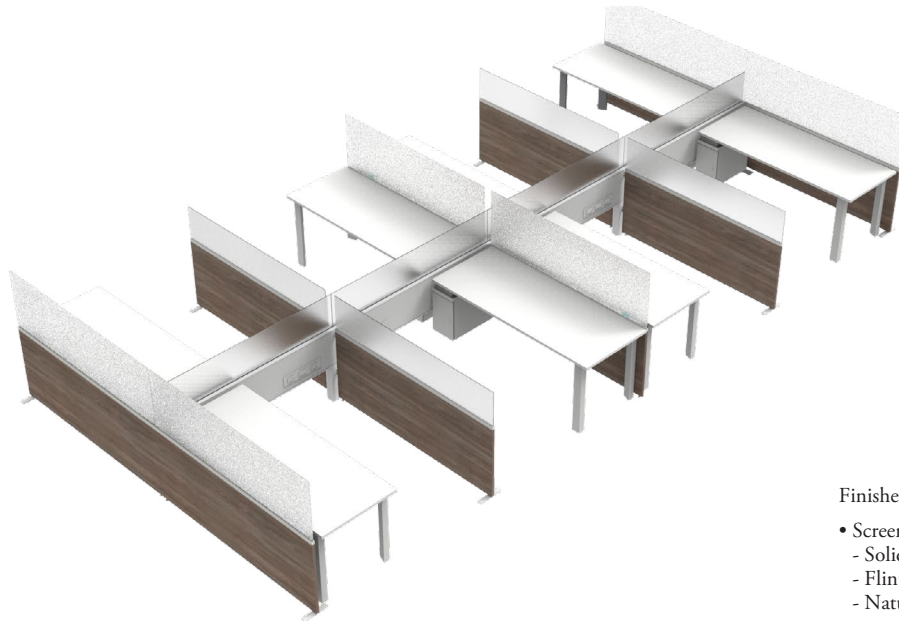

- Height: 42", 51"
- Depths: 24", 30", 36", 42", 48", 60", 72"
- Bracket Attachments:
 - End Mounted Single
 - End Mounted Double
 - End Mounted Shared
 - Mid Spine
- Handedness:
 - Left
 - Right
 - Not applicable
 - Handedness is determined by the location of the bracket when the user is facing the workstation
- Screen Support:
 - None - available on 24, 30, 36" and 42" w
 - Foot - required on 48", 60" and 72" w screens
 - Worksurface connection
- Not designed to support a worksurface
- The solid portion of the screen and the panel height should be the same for proper connection

Finishes:

- Screen:
 - Solid laminate
 - Flintwood (horizontal grain pattern)
 - Natural veneer
- Hardware:
 - Foundation
 - Mica
 - Accent
- Glass Finishes:
 - Clear
 - Frost

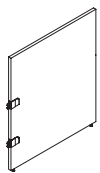

Power Spine Lateral Floor Screen Solid (UZSS)

- A solid screen with no glass

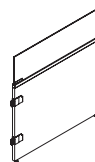

Power Spine Lateral Floor Screen with Glass (UZSG)

- A solid screen with a glass top
- Glass Options:
 - 42" total (31" solid + 11" glass)
 - Inset 42" (29" solid + 13" glass)
 - Inset 51" (42" solid + 9" glass)
 - Inset 51" (29" solid + 22" glass)

planning with power spine lateral floor screens

The following should be considered when planning with power spine lateral floor screens in linear applications.

Screens are available in the following configurations.

end mount double, handed

- Screens mount to the end of the spine panel run and extend to the mid point of the frame to provide a clean aesthetic on the outside of the workstations
- End Trim is not required on the panel frame in this application

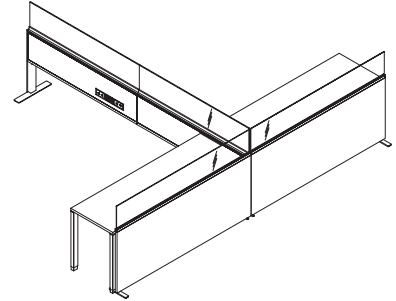
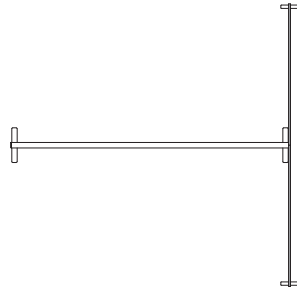

end mound shared, non-handed

- Screen mounts centered on the outside of the panel frame
- End Trim is not required on the panel frame in this application

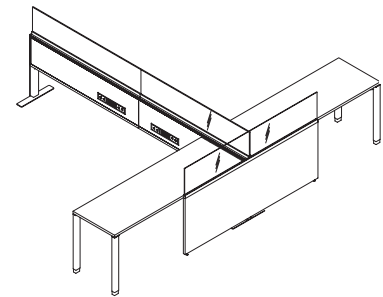
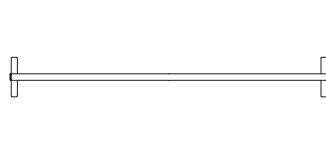

end mount single, handed

- Screen mounts outside of the panel frame and extends completely across the end of the frame to provide a clean aesthetic to the outside of the workstations in single sided applications

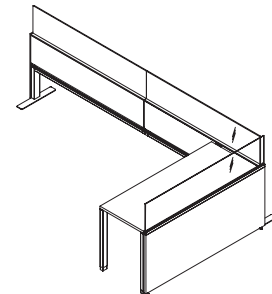
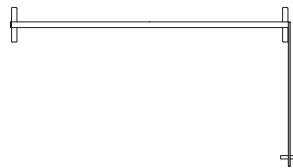

mid spine, handed

- Screen mounts mid run at a location with a support post

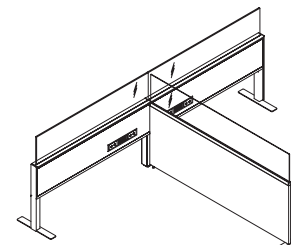
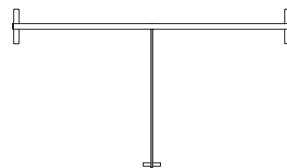

planning with power spine lateral floor screens (continued)

- Lateral screens are available with two datum height options for the glass:
 - from 29"
 - from 42"
- Can be used on either Power Spine Panel or Power Spine Inset Panel with inset glass depending on the application

29" high panel walls

- Panel Wall Add-On Screen - Glass has a 2" high metal frame bringing the glass datum height to 31" high when mounted to a panel
- It is recommended that the 31" glass option be selected for the Lateral Screen so that the datum heights align

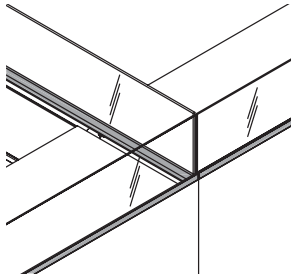

Recommended Lateral Screen: 31" high solid with 11" glass.

29" and 42" high power spine with panel glass blade for panels with inset glass

- Inset Panel Wall Add-On Screen - Glass has no metal frame so the datum height remains at 29" or 42" high when mounted to a panel
- It is recommended that the 29" glass option be selected for the Lateral Screen when used with the 29" high panel and 42" high glass option be selected when used with the 42" high option

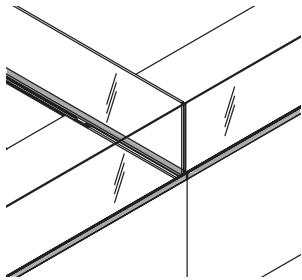

Recommended Lateral Screen: 29" high solid with 13" glass.

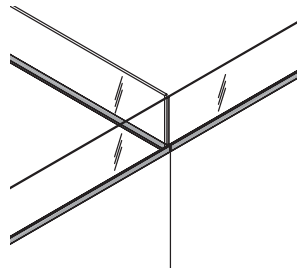

Recommended Lateral Screen: 42" high solid with 9" glass.

Two height options can be used in single sided applications with Add-On Screens on 29" high panels depending on the desired aesthetic.

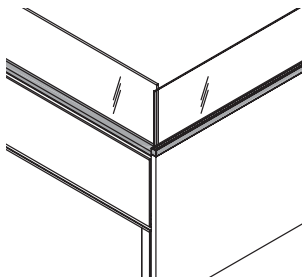

- Lateral screen with 31" high solid and glass above:
- the solid part of the screen and the solid part of the glass add-on trim will align

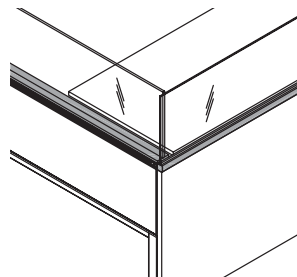

- Lateral screen with 29" high solid and glass above:
- the solid part of the screen and the top of the panel will align

planning with power spine lateral floor screens (continued)

mid run applications

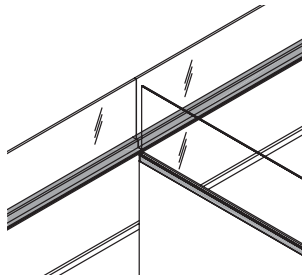

- In mid run applications it is recommended that the 29" high lateral screen with glass above be used
- This aligns the solid portion of the lateral screen or with the top of the panel frame eliminating unnecessary height changes and gaps

42" high panel walls

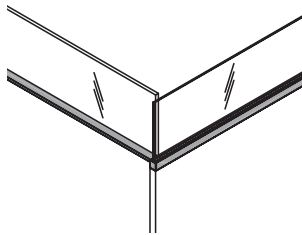

Only one option is available for adding glass to a 42" high panel

- Inset Glass Screen (the glass is inset, so no trim is visible, the datum height remains at 42")

Lateral Floor Screens provide support to panels when

- The maximum number of panel sections is four and the overall length does not exceed 192"
(ex. 4 x 48" sections = 192")
- Reminder: panels over 60"w. consist of two panel sections, so 2 x 48"w sections is the equivalent of 1 x 96"w panel
- The maximum number of panels sections is three when 60"w. panels are used and the overall length does not exceed 180" (ex. 3 x 60" sections = 180")
- Panel heights do not exceed 51"h.

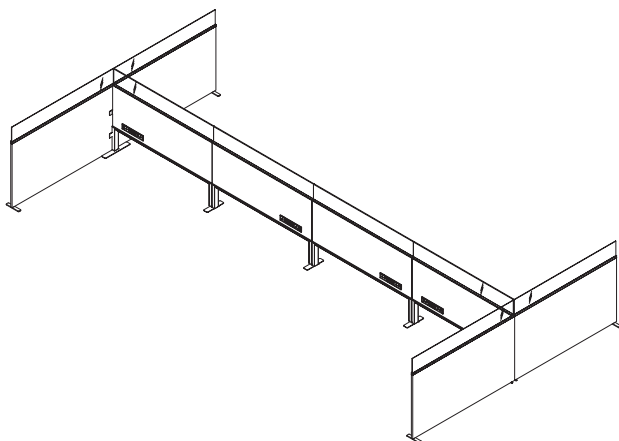

power spine worksurface understanding

District Power Spine provides a variety of worksurfaces and worksurface support bundles for Linear and 120 planning. The following outlines the features of District Power Spine worksurfaces and Worksurface Support bundles.

District Worksurfaces for Power Spine Panels are available in a variety of styles for both height-adjustable and fixed applications.

rectangular



Rectangular worksurfaces can be applied in Linear and Zig Zag Perpendicular and Parallel planning.

dual angled and 120 angled



Angled worksurfaces can be applied in Zig Zag Perpendicular and 120 Hub planning.

pallelogram



Parallelogram worksurfaces can be applied in Zig Zag Perpendicular and 120 Hub planning.

120 hub



120 Hub worksurfaces can be applied 120 Hub planning.

power spine worksurface and worksurface support basics

The Rectangular Worksurface and Support bundle is used in linear and Zig Zag applications.



Finishes:

- Worksurface Finishes:
 - Foundation Laminate
 - Flintwood
 - Natural Veneer
- Grommet Finishes
 - Storm White
 - Espresso
 - Platinum
 - Very White
- Support Finishes:
 - Foundation Colors
 - Mica Colors
 - Accent Colors

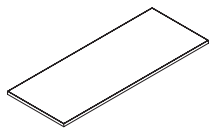

Power Spine Rectangle Worksurface (UZWE)

- Depths: 24", 30"
- Widths: 48", 54", 60", 66" 72"
- Edge:
 - (8) Flat
 - (H) Full Knife
- Optional grommets
- Applications:
 - (A) Freestanding - 4 legs
 - (B) Perpendicular (panel mounted) - 2 legs

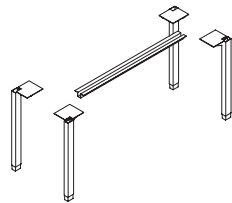

Power Spine Rectangular Worksurface Support Bundle (UZWC)

Used with the Power Spine Rectangle Worksurface.

- Depths: 24", 30"
- Widths: 48", 54", 60", 66", 72"
- Leg Type:
 - (L) Standard Leg
- Includes legs, mounting brackets and reinforcement channels depending on application
- Applications:
 - (A) Freestanding - 4 Legs
 - (B) Perpendicular - 2 legs, 2 brackets

power spine worksurface and worksurface support basics (continued)

The Angled Worksurface and Support bundle is used in Zig Zag applications.



Finishes:

- **Worksurface Finishes:**
 - Foundation Laminate
 - Flintwood
 - Natural Veneer
- **Grommet Finishes**
 - Storm White
 - Espresso
 - Platinum
 - Very White
- **Support Finishes:**
 - Foundation Colors
 - Mica Colors
 - Accent Colors

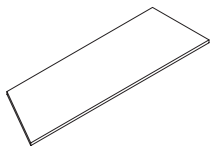

Power Spine Angled Worksurface (UZWA)

- Depths: 24", 30"
- Widths: 48", 54", 60", 66", 72"
- Edge:
 - (F) Flat
 - (H) Full Knife
- Optional grommets
- Handedness:
 - (LH) Left Hand
 - (RH) Right Hand
- Applications:
 - (B) Perpendicular - 2 Legs
 - (D) Parallel - 1 Legs

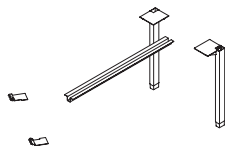

Power Spine Angled Worksurface Support Bundle (UZWB)

Used with the Power Spine Rectangle Worksurface.

- Depths: 24", 30"
- Widths: 48", 54", 60", 66", 72"
- Handedness:
 - (LH) Left
 - (RH) Right
- Leg Type:
 - (L) Standard Leg
- Applications:
 - (B) Perpendicular - 2 legs, 2 brackets
 - (D) Parallel - 1 leg, 3 brackets
- Leg Type:
 - (L) Standard Leg
- Applications:
 - (B) Perpendicular - 2 legs, 2 brackets
 - (D) Parallel - 1 leg, 3 brackets

power spine worksurface and worksurface support basics (continued)

The Parallelogram Worksurface and Support Bundle for 120 Zig Zag and Hub planning for semi-supported applications.



Finishes:

- **Worksurface Finishes:**
 - Foundation Laminate
 - Flintwood
 - Natural Veneer
- **Grommet Finishes:**
 - Storm White
 - Espresso
 - Platinum
 - Very White
- **Support Finishes:**
 - Foundation Colors
 - Mica Colors
 - Accent Colors

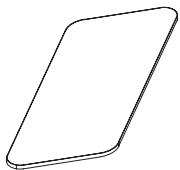

Power Spine Parallelogram Worksurface (UZWP)

- Depths: 24", 30"
- Widths: 48", 54", 60", 66", 72"
- Edge:
 - (F) Flat
 - (H) Full Knife
- Optional grommets
- Handedness:
 - (LH) Left Hand
 - (RH) Right Hand
- Applications:
 - (A) Freestanding - 4 legs
 - (C) Perpendicular - 2 Legs
 - (D) Parallel - 1 Legs

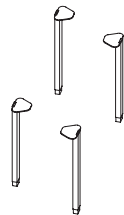

Power Spine Parallelogram Worksurface Support Bundle (UZWK)

Used with the Power Spine Rectangle Worksurface.

- Depths: 24", 30"
- Widths: 48", 54", 60", 66", 72"
- Handedness:
 - (LH) Left
 - (RH) Right
- Leg Type:
 - (C) Standard Leg for Curved Radius
- Applications:
 - (A) Freestanding - 4 Legs
 - (C) Parallel - 2 legs, 2 brackets
 - (D) Perpendicular - 1 legs, 3 brackets

power spine worksurface and worksurface support basics (continued)

The Dual 120 Angled Worksurface and Support Bundle for 120 Zig Zag Perpendicular planning for semi-supported applications.



Finishes:

- **Worksurface Finishes:**
 - Foundation Laminate
 - Flintwood
 - Natural Veneer
- **Grommet Finishes**
 - Storm White
 - Espresso
 - Platinum
 - Very White
- **Support Finishes:**
 - Foundation Colors
 - Mica Colors
 - Accent Colors

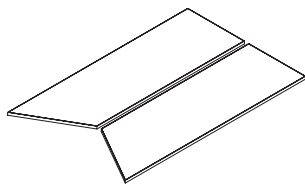

Power Spine Dual 120 Angled Worksurface (UZWD)

- Depths: 48", 60"
- Widths: 48", 54", 60", 66", 72"
- Edge:
 - (8) Flat
- Optional grommets
- Applications:
 - Perpendicular - 2 Legs
- Includes 2 angled worksurfaces

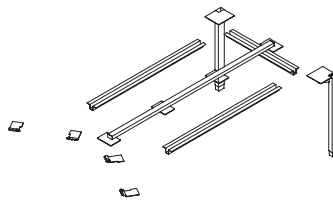

Power Spine Dual Angled Worksurface Support Bundle (UZDK)

Used with the Power Spine Rectangle Worksurface.

- Depths: 48", 60"
- Widths: 48", 54", 60", 66", 72"
- Leg Type:
 - (L) Standard Leg
- Applications:
 - (B) Perpendicular - 2 legs, 2 brackets

power spine worksurface and worksurface support basics (continued)

120 Hub corner worksurface to be supported by 2 legs and 3 brackets.



Finishes:

- Worksurface Finishes:
 - Foundation Laminate
 - Flintwood
 - Natural Veneer
- Grommet Finishes:
 - Storm White
 - Espresso
 - Platinum
 - Very White
- Support Finishes:
 - Foundation Colors
 - Mica Colors
 - Accent Colors

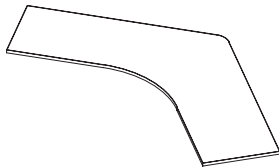

Power Spine 120 Hub Worksurface (UZWT)

- Depths: 24", 30"
- Widths: 48", 60"
- Edge:
 - (8) Flat
 - (H) Full Knife
- Optional grommets
- Applications:
 - (E) Semi-Supported - 2 legs

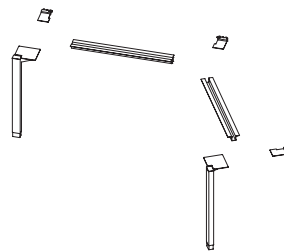

Power Spine 120 Hub Worksurface Support Bundle (UZWW)

Used with the Power Spine Rectangle Worksurface.

- Depths: 24", 30"
- Widths: 48", 60"
- Leg Type:
 - (L) Standard Leg
- Applications:
 - (E) Semi Supported - 2 legs

planning with power spine worksurface

The following should be considered when planning with Power Spine Worksurfaces.

The support configuration for fixed worksurfaces varies depending on the worksurface style and mounting condition.

freestanding planning



4x legs on all corners.

perpendicular applications

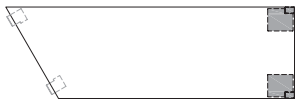

- 2 legs on one end of the worksurface
- 2 brackets on the opposite end (attached to panel)

parallel applications



- 2 legs on the front side of the worksurface
- 2 brackets on the panel side (attached to panel)

parallel and 120 hub applications



- 1 leg on the corner of the worksurface
- 3 brackets on the panel side (attached to panel)

Knife Edges on worksurfaces will vary depending on the worksurface type and application.

rectangular, angled and parallelogram



4 knife edges



3 knife edges

120 hub

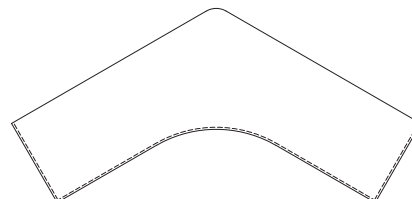

3 knife edges

Parallelogram worksurfaces **cannot** be used for perpendicular planning, Angled Worksurfaces should be used.

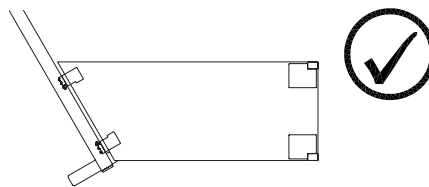
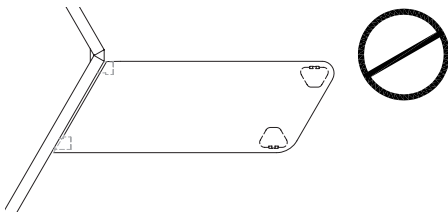

planning with power spine worksurface (continued)

Parallelogram worksurfaces have radiused corners, the amount is determined by the application.

4 legs (freestanding)



All corners are radiused.

2 legs and 2 brackets



2 corners are radiused.

1 leg and 3 brackets

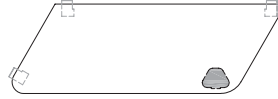

2 corners are radiused.

planning with power spine worksurface (continued)

The depth and width of Angled and Parallelogram worksurfaces is determine by the following:

- The nominal depth is the distance from the user edge to the face of the panel
- The nominal width matches the width of the panel that the worksurface sits in front of

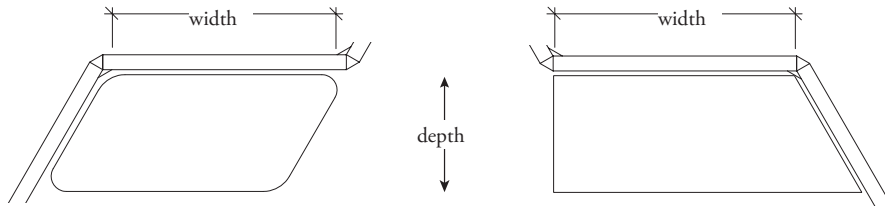

All Angled, Parallelogram and 120 Hub semi suspended worksurfaces follow the District worksurface protocol and have a 1" gap on all panel facing sides.

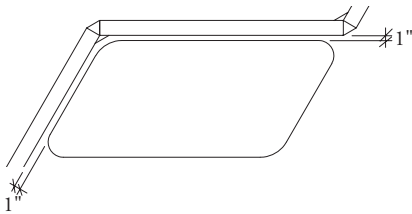

Angled and Parallelogram worksurfaces are handed.

- The handedness is determined by the location of the acute angled corner from the users perspective

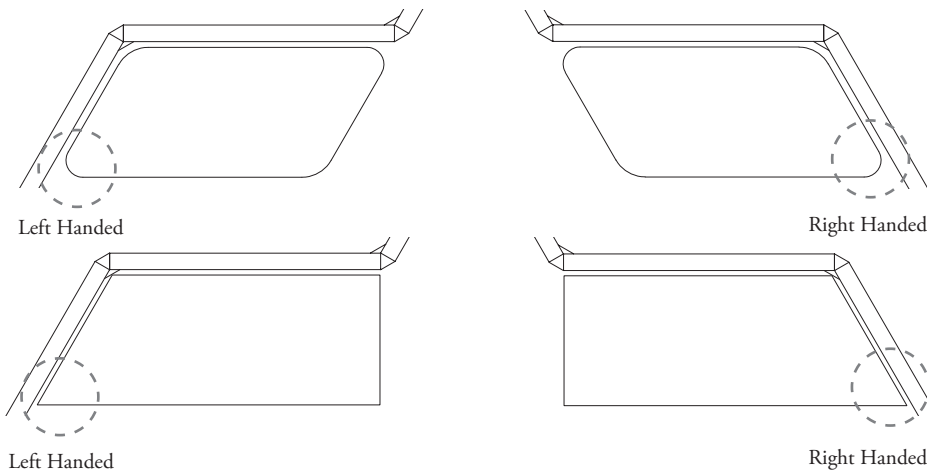

The 120 Hub worksurface has slight differences depending on whether it's use fixed or height adjustable.

- The width on height-adjustable surfaces is 1" less on each side
- The grommet locations are different:
 - The fixed worksurface grommets are inset 6-2/5" on center
 - The height-adjustable worksurface grommets are inset 3-2/5"

fixed

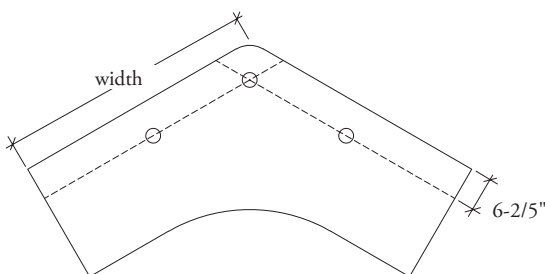

height-adjustable

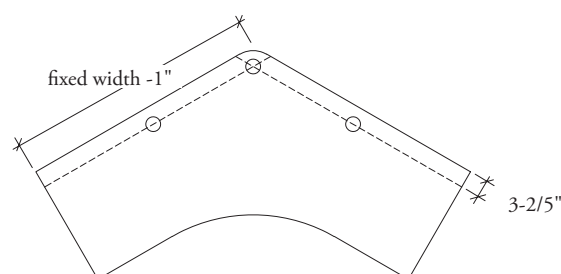

planning with power spine rectangle worksurface

The following should be considered when planning with rectangular worksurfaces and support kits in linear applications.

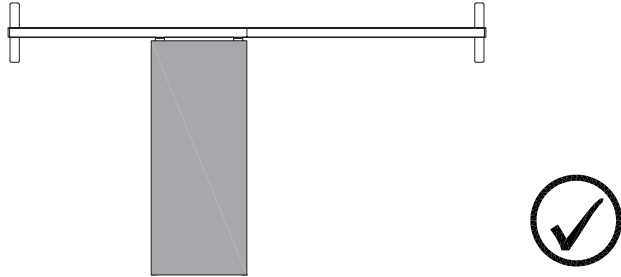

Worksurfaces mount perpendicular to the Power Spine Panel.

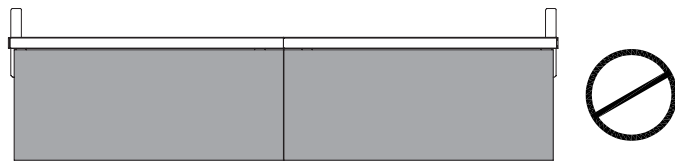

Worksurfaces **cannot** be mounted parallel to the panels.

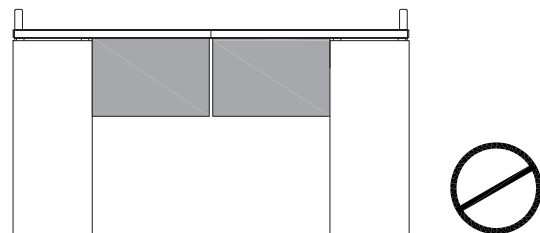

Worksurfaces **cannot** be used as a return worksurface.

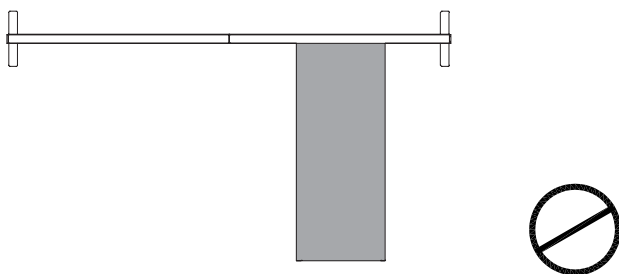

Off module planning

- For 48" and 60" frame modules, worksurfaces **cannot** be planned off module.

planning with power spine rectangle worksurface (continued)

When planning with lateral screens and semi-suspended worksurfaces the screens can be planned in two ways:

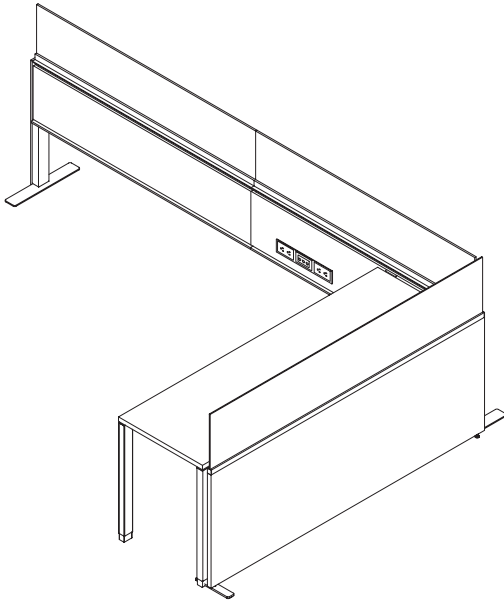

- Attached to the panel and not the worksurface
- a foot is required on screens 48" wide or wider
- Semi-suspended worksurfaces **cannot** be used with 42"H panels
- Semi-suspended worksurfaces **cannot** be used with inset panels

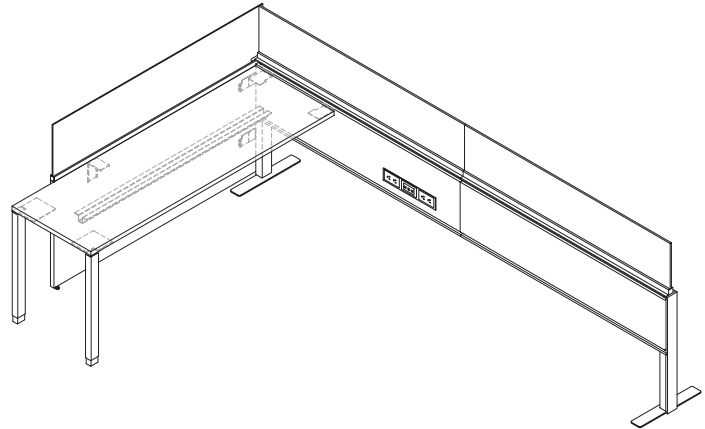

- The worksurface mounted screen has fixed bracket locations, the width of the screen must be equal to or smaller than the width of the worksurface
- Not designed to support the worksurface

planning with power spine zig zag panel and worksurfaces

The following should be considered when planning with Zig Zag worksurfaces and support kits in linear applications.

Zig Zag Power Spine panels can accept a variety of worksurface types.

single parallelogram worksurfaces

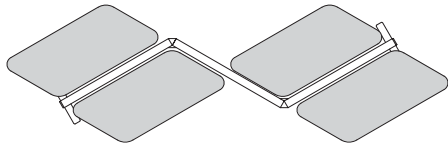

single rectangular worksurfaces

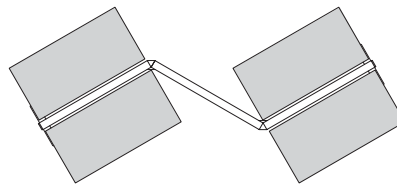

single and dual angled and dual angled worksurfaces

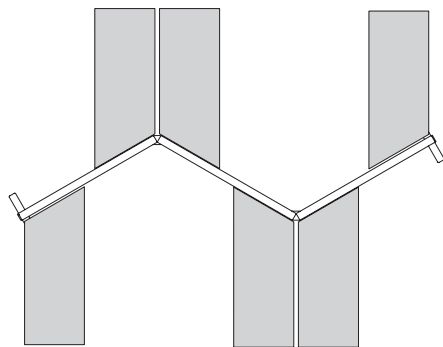

The recommended worksurface size is 72".

single and dual rectangular worksurfaces

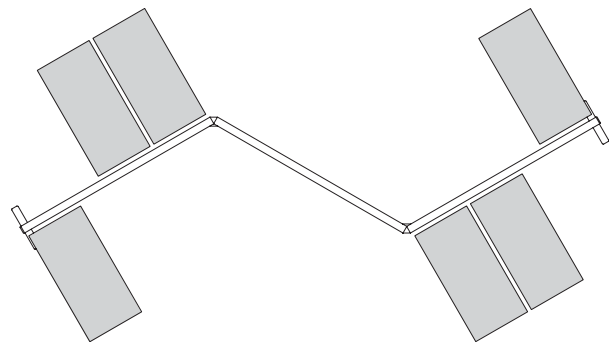

The recommended worksurface size is 72".

Recommended worksurface sizes for Perpendicular Planning Power Spine Zig Zag Panels is 72" wide.

The following recommendations are not recommended.

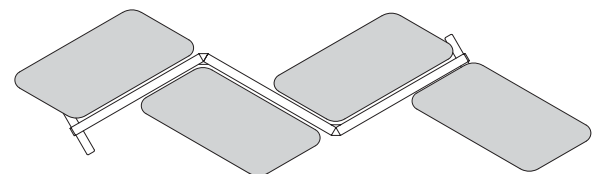
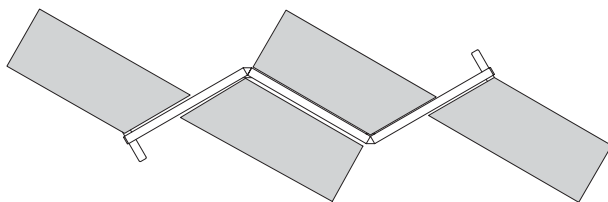

Not optimal use of space, only if freestanding desks required.

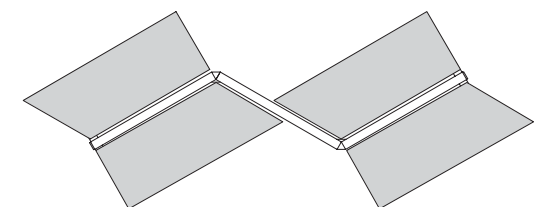

planning with power spine 120 Hub and worksurfaces

The following should be considered when planning with 120 Hub worksurfaces and support kits in linear applications.

120 Hub Power Spine panels can accept a variety of worksurface types.

angled worksurfaces

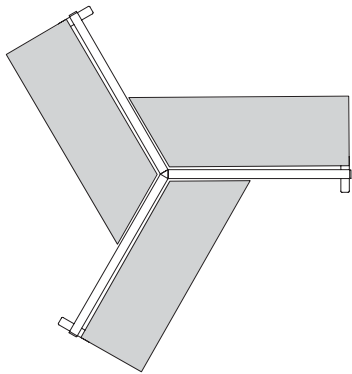

Planning with Angled Worksurface Semi-Suspended only.

120 hub worksurfaces

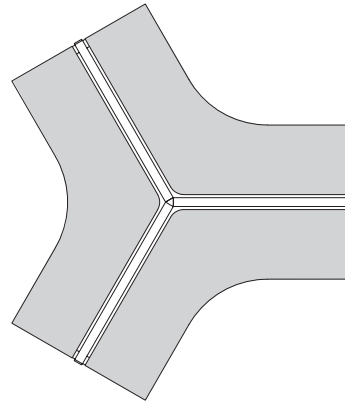

Planning with Classic Hub Worksurface Height-Adjustable, Semi-Suspended.

Acceptable Planning (with some drawbacks).

rectangular worksurfaces

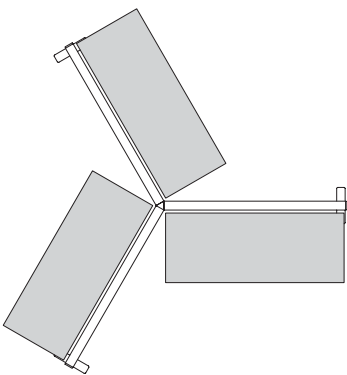

Rectangular - Semi Suspended or Freestanding Limited legs space.

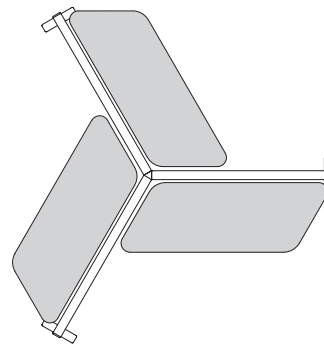

Rectangular Height-Adjustable, or Freestanding Creates gaps between Worksurface and panel.

power spine hispace quick connect table basics

Quick Connect Tables can be easily integrated into Power Spine configurations.

The Power Spine Quick Connect table has all of the same features as Quick Connect tables, available from Complements: *Teknion's Ergonomics & Accessories Program*.

rectangular

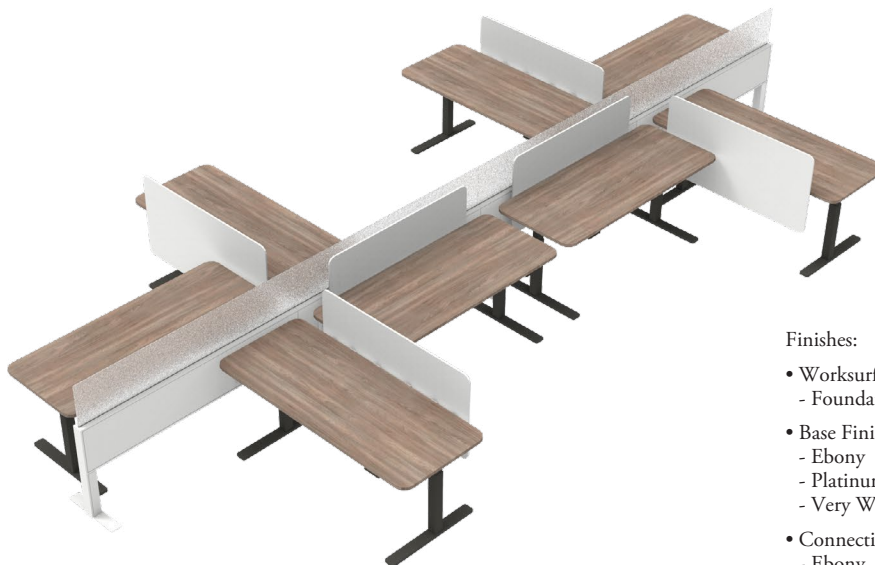

Finishes:

- Worksurface Finishes:
 - Foundation Laminate
- Base Finish:
 - Ebony
 - Platinum
 - Very White
- Connection Kit Finish:
 - Ebony
 - Platinum
 - Very White

- Bases and tops are ordered separately and must be the same size
- Depths: 23", 29"
- Widths: 52" 58" 64", 70"
- Orientations:
 - Spine Front & Centered for parallel (C) (only available for 52" wide)
 - Spine Left for Perpendicular (L)
 - Spine Right for Perpendicular (R)
- Base Mechanisms:
 - Extended electric (22.6" - 48.7")
- All configurations allow for desk edge screens
- Same Kit of Parts can adjust to fit all planning applications for:
 - Perpendicular, Frame Inset Left
 - Perpendicular, Frame Inset Right
 - Parallel, Frame Centered

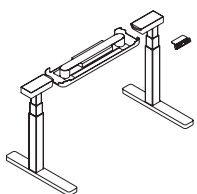

hiSpace Quick Connect Height-Adjustable Freestanding Table Mechanism for District Power Spine (YSZ)

- Switch: Display with Up/Down Memory
- Power PAK: Cable Organizer with Felt Cover
- Wire Management:
 - None
 - Vertical Wire Carrier

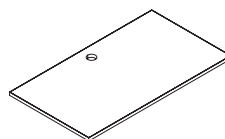

Rectangular Height-Adjustable Worksurface with Connection Kit for hiSpace Quick Connect with District Power Spine (WBZ)

- Grommet Style:
 - None
 - Round (2.75" Diameter)
 - Rectangular (Diamond Shaped Cutout)
- Cut Out Location: None, Center
- Edge Trim:
 - Flat Trim
 - Straight Trim
 - Bullnose Trim

power spine hispace quick connect table basics (continued)

parrallelogram



Finishes:

- Worksurface Finishes:
 - Foundation Laminate
- Base Finish:
 - Ebony
 - Platinum
 - Very White

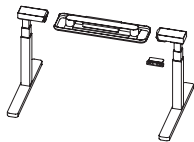

hiSpace Quick Connect Parallelogram Height-Adjustable Freestanding Table Mechanism for District Power Spine (YSB)

- Base Mechanism:
 - (9E) Extended Electric (22.6" - 48.7")
- Depth:
 - 23", 29"
- Width:
 - 60", 72"
- Handedness:
 - Spine Front and Centered for Parallel
 - Left hand
 - Right hand
- Switch:
 - Display with Up /Down Memory
- Power PAK:
 - None
 - Cable Organizer with Felt Cover
- Wire Management:
 - None
 - Vertical Wire Carrier

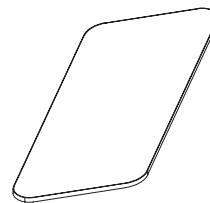

Parallelogram Height-Adjustable Worksurface with Connection Kit for hiSpace Quick Connect with District Power Spine (UZWP)

- Base Mechanism:
 - (9E) Extended Electric (22.6" - 48.7")
- Depth:
 - 23", 29"
- Width:
 - 60", 72"
- Power Spine Orientation:
 - (C) Spine Front and Centered for Parallel
- Handedness:
 - (LH) Left hand
 - (RH) Right Hand
- Grommet Style:
 - None
 - Round (.75" Diameter)
- Cut Out Location:
 - None
- Corner Condition:
 - (A) Four Radius Corners
- Edge Trim:
 - Flat Trim
 - Straight Trim
 - Bullnose Trim
 - Full Knife Trim

power spine hispace quick connect table basics (continued)

120 hub



Finishes:

- Worksurface Finishes:
 - Foundation Laminate
- Base Finish:
 - Ebony
 - Platinum
 - Very White

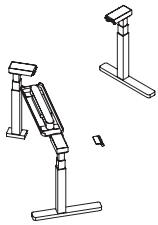

hiSpace Quick Connect 120 Hub Height-Adjustable Freestanding Table Mechanism for District Power Spine (YST)

- Base Mechanism:
 - (9E) Extended Electric (22.6" - 48.7")
- Depth:
 - 23", 29"
- Width:
 - 46", 58"
- Switch:
 - Display with Up/Down Memory
- Power PAK:
 - Cable Organizer with Felt Cover
- Wire Management:
 - None
 - Vertical Wire Carrier
- Under surface Cable Management:
 - None
 - Dual Plastic Tray

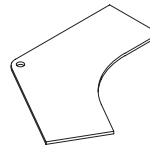

120 Hub Height-Adjustable Worksurface with Connection Kit for hiSpace Quick Connect with District Power Spine (WBT)

- Base Mechanism:
 - (9E) Extended Electric (22.6" - 48.7")
- Depth:
 - 23", 29"
- Width:
 - 46", 58"
- Grommet Style:
 - None
 - Round (.75" Diameter)
- Cut Out Location:
 - None
 - Center
 - Left
 - Right
 - Left and Right
 - Center and Left
 - Center Right
 - Center, Left and Right
- Edge Trim:
 - Flat Trim
 - Straight Trim
 - Bullnose Trim
 - Full Knife Trim

planning with power spine hispace quick connect table

The following should be considered when planning with Power Spine hiSpace Quick Connect Height-Adjustable Freestanding Table.

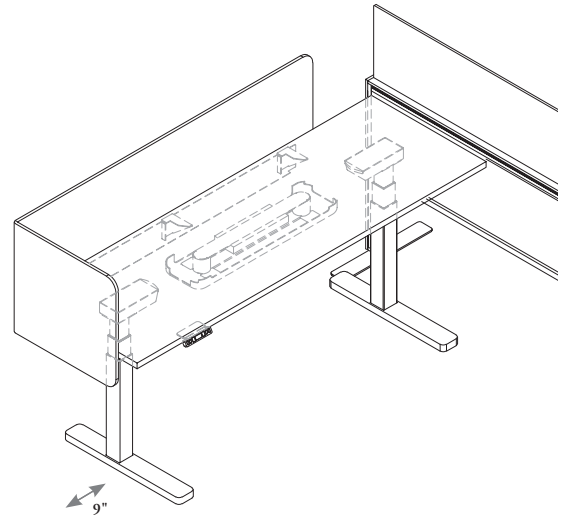
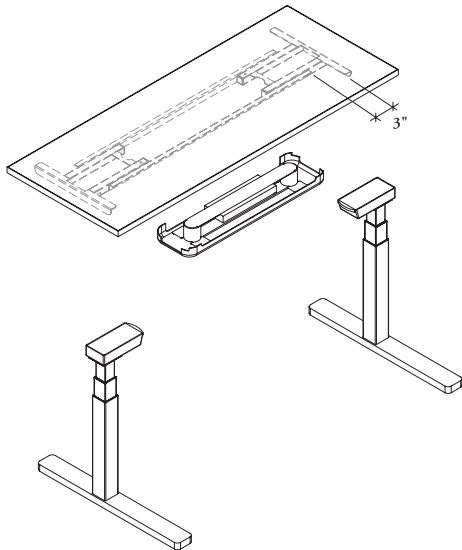

- The leg of the hiSpace Quick Connect base can be repositioned to allow for reconfiguration
- It can be adjusted up to 3", to allow approximately 7" overhang on the worksurface

Adjusting the leg position will also create a 9" leg clearance to avoid interference with the power spine panel leg.

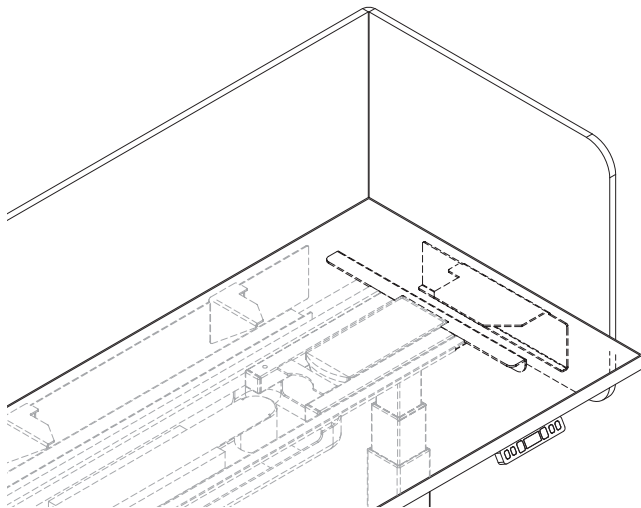

Regardless of the leg position, edge mounted screens will always fit.

planning with power spine hispace quick connect table (continued)

The following should be considered when planning with Power Spine 3 legged and Parallelogram hiSpace Quick Connect Height-Adjustable Freestanding Tables.

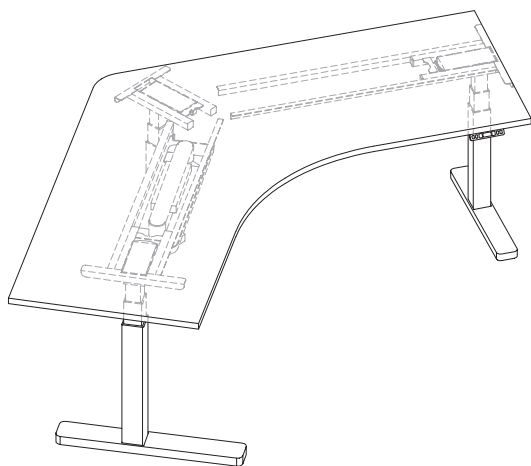

Under surface Cable Manager not available on 46" width.

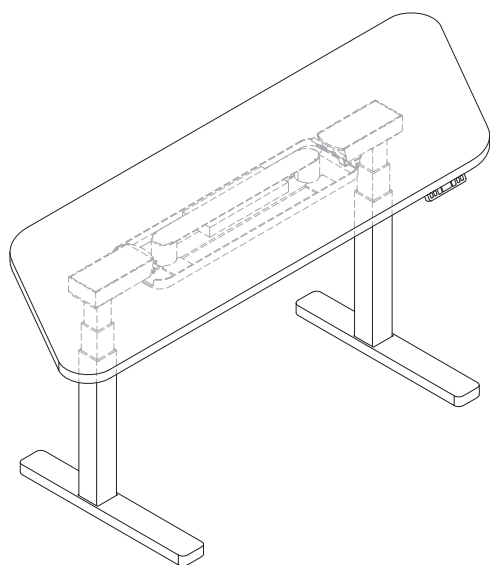

Under surface Cable Manager (YSB) not available on 60" width.

screens

screens

UNDERSTANDING SCREENS	106
DESK EDGE SCREEN BASICS	108
PLANNING WITH DESK EDGE SCREENS	113
DESKTOP LATERAL SCREEN BASICS	130
DESK TOP SCREEN BASICS	133
MODESTY SCREEN BASICS	134
PLANNING WITH MODESTY SCREENS	135
FLOOR SCREEN BASICS	136
PLANNING WITH FLOOR SCREENS	137
STORAGE SCREEN BASICS	138
PLANNING WITH STORAGE SCREENS	139
STORAGE SCREEN TYPICALS	140
SOLID LATERAL SCREEN BASICS	141
END MOUNT LATERAL SCREEN BASICS	142
PLANNING WITH END MOUNT LATERAL SCREENS	143
PANEL WALL ADD-ON SCREEN BASICS	146
PLANNING WITH WALL PANEL ADD-ON SCREENS	147
GLASS BLADES FOR PANELS WITH INSET GLASS BASICS	149
PLANNING WITH GLASS BLADES FOR PANELS WITH INSET GLASS	150

understanding screens

District provides a variety of screens for space division in panel wall and freestanding applications. They provide visual and territorial privacy and a lighter aesthetic than a panel wall in areas where shielded wire management is not required.

desk edge screens

Desk Edge Screens are available in five styles:

- Solid and Glass
- Infinity fabric, straight and curved
- Framed fabric
- Smooth Felt
- Desk Edge Screen with Glass

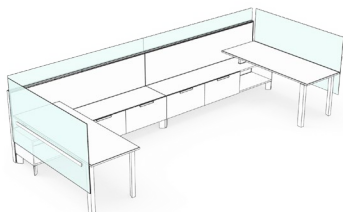

Solid and Glass Desk Edge Screens

- Mounts on- or off-module to the edge of single return worksurfaces
- Provides privacy at 42" h, 51" h and 57" h
- Available in glass at two modesty heights

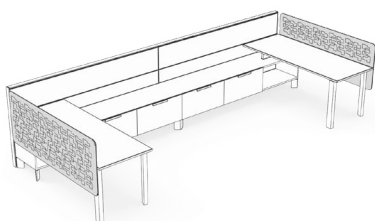

Infinity Desk Edge Screens, Desk Edge Floor Screens and Side Desk Edge Screens

- Attaches to worksurfaces to provide a lightweight, thin upholstered fabric screen
- Provides privacy at 42" h, 51" h and 57" h
- Provides a softer curvilinear aesthetic
- Creates space division and local desktop privacy at various heights

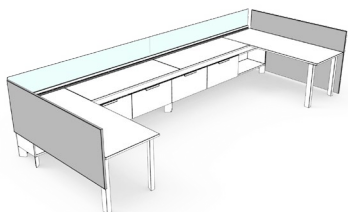

Framed Fabric Desk Edge Screens, Desk Edge Floor Screens and Side Desk Edge Screens

- Attaches to worksurfaces to provide an upholstered fabric screen
- Provides privacy at 42" h, 51" h and 57" h
- Is outlined by a frame
- Creates space division and local desktop privacy at various heights above and below the work surface

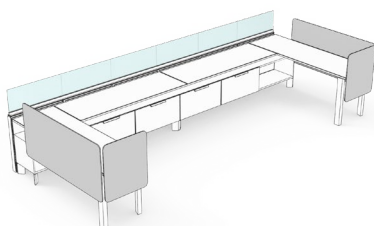

Smooth Felt Desk Edge Screens

- Attaches to work surface to provide privacy
- Create space division at 42" h and 51" h
- A smooth felt screen with a lightweight aesthetics
- Available in Complements: Teknion's Ergonomics & Accessories Program.

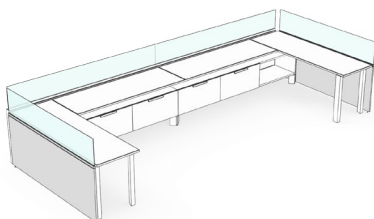

Desk Edge Screen with Glass

- A screen that is solid at the bottom and glass at the top
- 42", 51" and 57" heights with options for glass starting from desk height

understanding screens (continued)

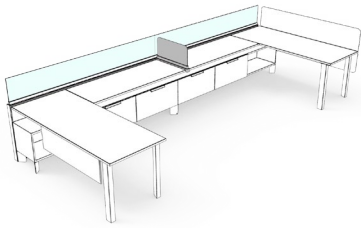

lateral screens

- Desktop Lateral screens attach to a worksurface to provide lateral space division
- Metal finish screens provides privacy at 51" h and other finishes provide privacy at 42" h, 51" h and 57" h
- Available in a variety of finishes:
 - Glass
 - Writable glass
 - Laminate
 - Writable laminate
 - Fabric
 - Metal
 - Smooth Felt

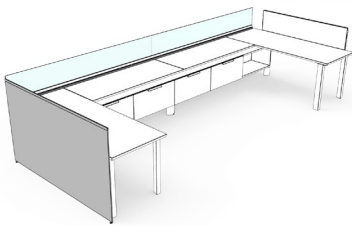

floor screens

- Floor Screens provide complete privacy by mounting on- or off-module to the back of a worksurface and extending to the floor
- Provides privacy at 42" h, 51" h and 57" h

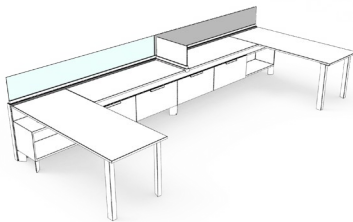

panel wall add-on screens

- Panel Wall Add-On Screens provide light, frameless privacy by mounting on- or off-module to a panel wall and offer an alternative to high panels with windows.

desk edge screen basics

Desk Edge Screens can be used on Freestanding or Panel Mounted Worksurfaces to provide visual privacy.

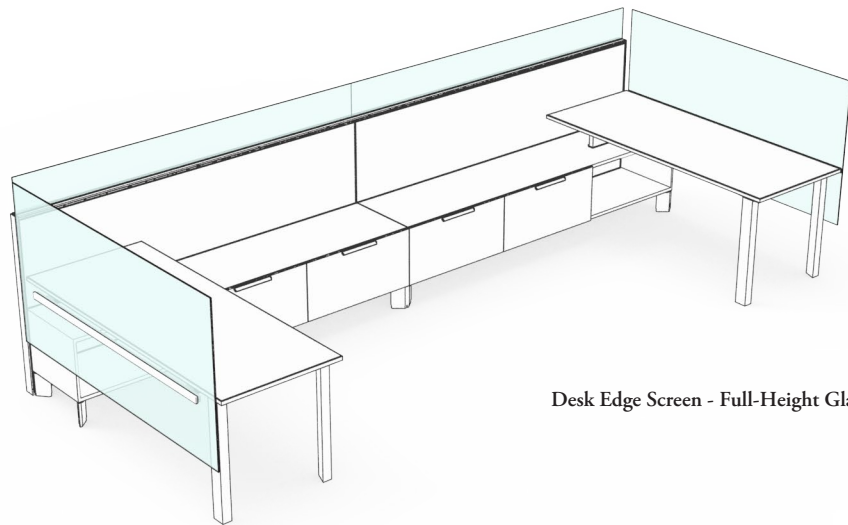

Desk Edge Screen - Full-Height Glass shown

desk edge screens

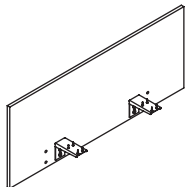

Desk Edge Screen (UNSDE)

- Heights:
 - 13" for a 42" h datum
- Widths: 23" to 96" in 1" increments
- Finishes:
 - Source Laminate
 - Flintwood
 - Natural Veneer

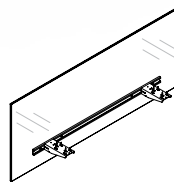

Desk Edge Screen – Glass (UNSDEG)

- Heights:
 - 13" for a 42" h datum
- Widths: 23" to 96" in 1" increments
- Finishes:
 - Glass

full-height desk edge screens

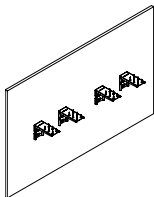

Desk Edge Screen – Full-Height (UNSFDE)

- Heights:
 - 13" (Overall height 30.4") to provide a 42" h datum
 - 22" (Overall height 37") to provide a 51" h datum
 - 28" (Overall height 43") to provide a 57" h datum
- Widths: 23" to 96" in 1" increments
- Modesty Base Heights:
 - 15" Modesty
- Finishes:
 - Source Laminate
 - Flintwood
 - Natural Veneer

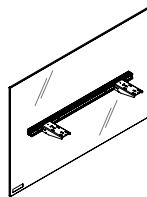

Desk Edge Screen – Full-Height Glass (UNSF DG)

- Heights:
 - 13" to provide a 42" h datum
 - 22" to provide a 51" h datum
 - 28" to provide a 57" h datum
- Widths: 23" to 96" in 1" increments
- Finishes:
 - 10mm thick etched tempered glass
 - Standard Frost

desk edge screen basics (continued)

infinity screens

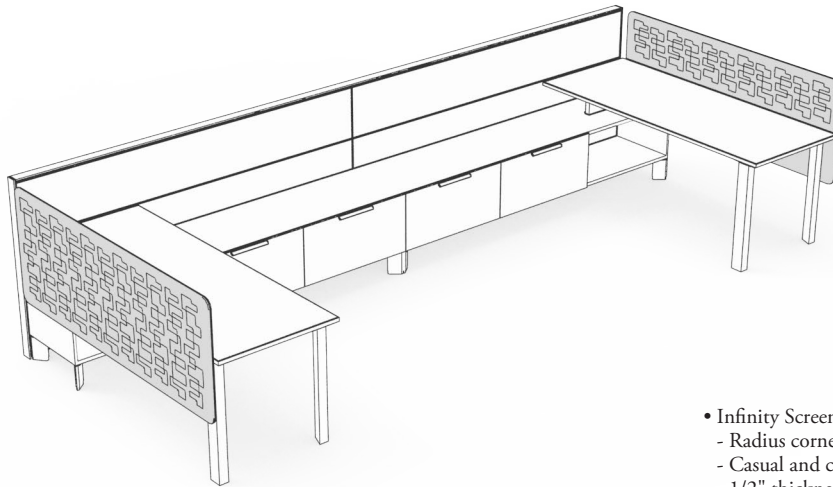

Quilted Infinity Desk Edge Screen shown

- Infinity Screen Features:
 - Radius corners
 - Casual and continuous corner applications
 - 1/2" thickness
 - Non-tackable
- Available in select panel and upholstery fabric, please refer to the *Teknion Textiles Program Guide*

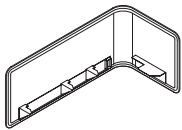

Infinity Curved Desk Edge Screen (GXCD)

- Depths: 20"
- Heights:
 - 13" for a 42"h datum
 - 22" for a 51"h datum
 - 28" for a 57"h datum
- Widths: 24" to 60" in 6" increments
- Modesty Base Heights:
 - 23" Partial Modesty
 - 15" Modesty
- Wire Manager is available

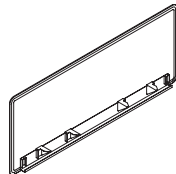

Infinity Desk Edge Screen (GXDD)

- Heights:
 - 13" for a 42"h datum
 - 22" for a 51"h datum
 - 28" for a 57"h datum
- Widths: 36" to 72" in 1" increments
- Modesty Base Heights:
 - 23" Partial Modesty
 - 15" Modesty
 - 6" Elevated
- Wire Manager is available

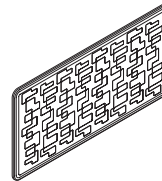

Quilted Infinity Desk Edge Screen (QDDE)

- Heights:
 - 13" for a 42"h datum
 - 22" for a 51"h datum
- Widths: 36" to 72" in 6" increments
- Modesty Base Heights:
 - 23" Partial Modesty
 - 15" Modesty
- Two Quilted Patterns:
 - Diode
 - Pico
- Wire Manager is available

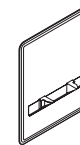

Infinity Side Desk Edge Screen (GXSD)

- Heights:
 - 13" for a 42"h datum
 - 22" for a 51"h datum
- Widths: 18" to 36" in 6" increments
- Modesty Base Heights:
 - 23" Partial Modesty
 - 15" Modesty
 - 6" Elevated

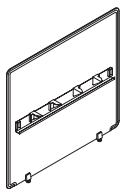

Infinity Desk Edge Floor Screen (GXFD)

- Heights:
 - 13" for a 42"h datum
 - 22" for a 51"h datum
- Widths: 36" to 72" in 1" increments
- Modesty Base Height: 1" Floor

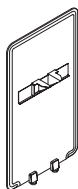

Infinity Side Desk Edge Floor Screen (GXED)

- Depths: 24", 30", and 36"
- Heights:
 - 13" for a 42"h datum
 - 22" for a 51"h datum
- Modesty Base Height: 1" Floor



Infinity Screen Alignment Clip (GXCC)

- Used to clip Infinity screens together in side-by-side applications

desk edge screen basics (continued)

framed fabric screens

Framed Fabric Desk Edge Floor Screen shown

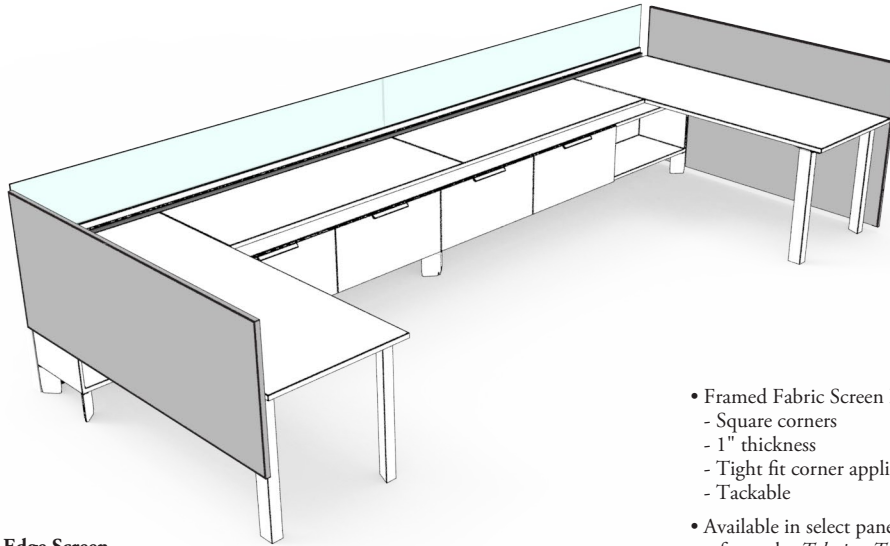

Framed Fabric Desk Edge Screen shown

- Framed Fabric Screen Features:
 - Square corners
 - 1" thickness
 - Tight fit corner applications
 - Tackable
- Available in select panel and upholstery fabric, please refer to the *Teknion Textiles Program Guide*

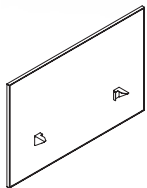

Framed Fabric Desk Edge Screen (GYDD)

- Heights:
 - 13" for a 42"h datum
 - 22" for a 51"h datum
 - 28" for a 57"h datum
- Widths: 36" to 72" in 1" increments
- Modesty Base Heights:
 - 23" Partial Modesty
 - 15" Modesty
 - 6" Elevated (not available at 57"h datum)

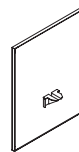

Framed Fabric Side Desk Edge Screen (GYSD)

- Depths: 18" to 36" in 6" increments
- Heights:
 - 13" for a 42"h datum
 - 22" for a 51"h datum
 - 28" for a 57"h datum
- Modesty Base Heights:
 - 23" Partial Modesty
 - 15" Modesty
 - 6" Elevated (not available at 57"h datum)

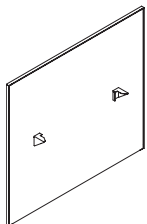

Framed Fabric Desk Edge Floor Screen (GYFD)

- Heights:
 - 13" for a 42"h datum
 - 22" for a 51"h datum
- Widths: 36" to 72" in 1" increments
- Modesty Base Height: 1" Floor

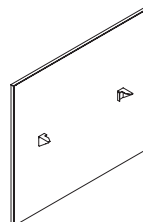

Framed Fabric Side Desk Edge Floor Screen (GYED)

- Depths: 18" to 36" in 6" increments
- Heights:
 - 13" for a 42"h datum
 - 22" for a 51"h datum
- Modesty Base Height: 1" Floor

desk edge screen basics (continued)

smooth felt desk edge screens

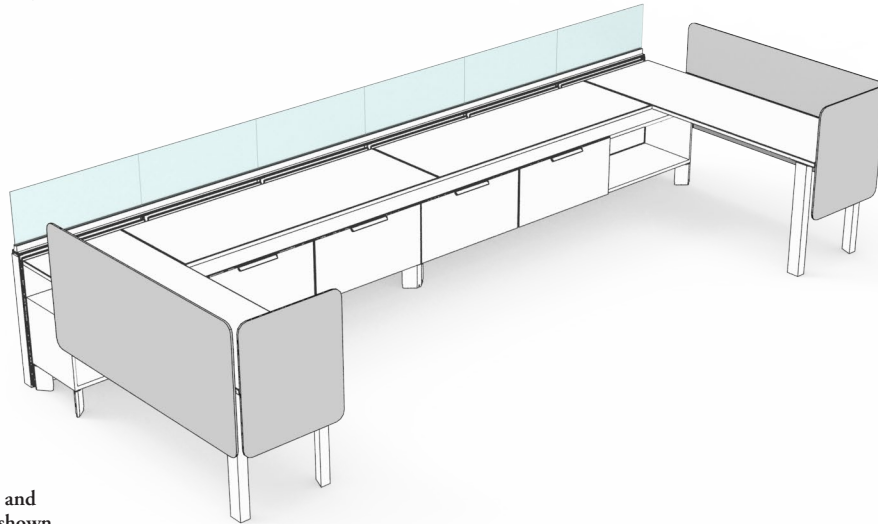

Smooth Felt Desk Edge and Side Desk Edge Screen shown

The Smooth Felt Screens can be used on District worksurfaces. They are available in Complements: *Teknion's Ergonomics & Accessories Program*.

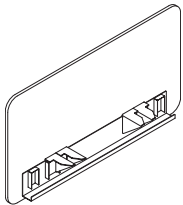

Smooth Felt Desk Edge Screen (GZDH)

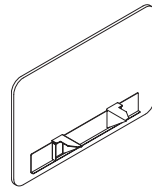

Smooth Felt Side Desk Edge Screen (GZSH)

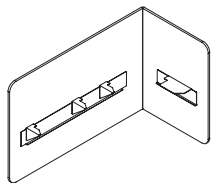

Smooth Felt Square Corner Desk Edge Screen (GZBH)

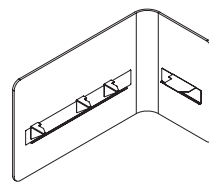

Smooth Felt Curved Radius Desk Edge Screen (GZCH)

desk edge screen basics (continued)

desk edge screens with glass

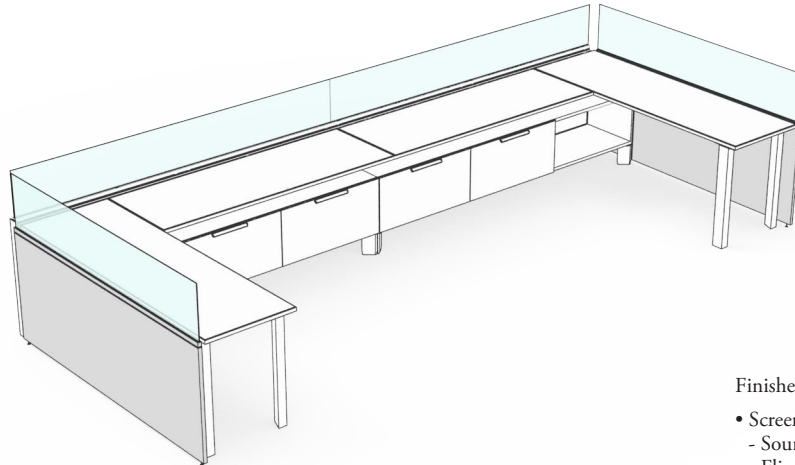

Finishes:

- Screen:
 - Source Lamiate
 - Flintwood (horizontal grain pattern)
 - Natural veneer
- Glass Options:
 - Clear
 - Frosted
- Hardware:
 - Foundation
 - Mica
 - Accent

- A screen that is solid at the bottom with glass at the top
- Two options are available:
 - Desk Edge Screen with Glass, Floor Height
 - Desk Edge Screen with Glass, Floor Height, Inset
- Designed to align with both standard panel glass add-on and inset glass blades

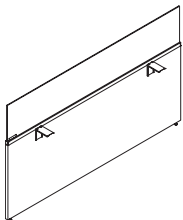

Desk Edge Screen with Glass (GVGD)

- Heights:
 - 31" Solid with 11" Glass to provide a 42" datum
 - 29" Solid with 13" Glass to provide a 42" inset datum
 - 44" Solid with 7" Glass to provide a 51" datum
 - 31" Solid with 20" Glass to provide a 51" datum
 - 42" Solid with 9" Glass to provide a 51" inset datum
 - 29" Solid with 22" Glass to provide a 51" inset datum
 - 44" Solid with 13" Glass to provide a 57" datum
 - 42" Solid with 15" Glass to provide a 57" inset datum
- Widths: 48" to 96" in 6" increments
- Modesty Base Height: 1" Floor

planning with desk edge screens

The following should be considered when planning with Desk Edge Screens.

Desk Edge Screens have restrictions depending on whether they are being used in panel mounted or freestanding applications.

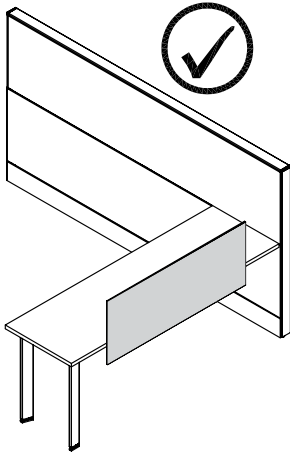

Panel Mounted Worksurface
Desk Edge Screens can be mounted to the worksurface with no restrictions.

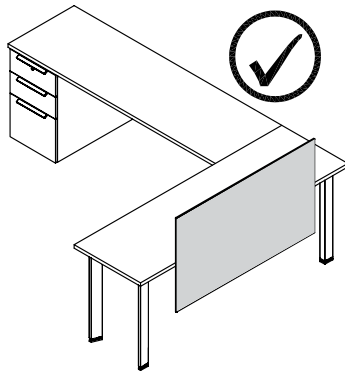

Freestanding Workstations with a Worksurface Return
Desk Edge Screens can be mounted to the worksurface return with no restrictions, the return surface provides adequate support.

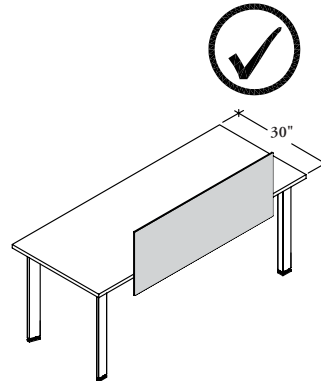

Freestanding Table without a Worksurface Return
Desk Edge Screens can be mounted if the worksurface is 30" deep or more. It cannot be mounted on a 24" deep worksurface.

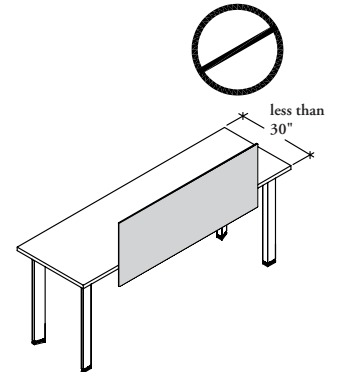

Desk Edge Screens mount on or off-module to the back or return edge of a worksurface to provide full width or casual fit with controlled gaps.



On-Module



Off-Module

- Desk Edge Screens can be used on height adjustable tables
- Full Height Solid Desk Edge Screens **cannot** be used due to interference when the table is lowered
- A Solid Desk Edge Screen **cannot** be used in combination with a Modesty Panel, the brackets will interfere

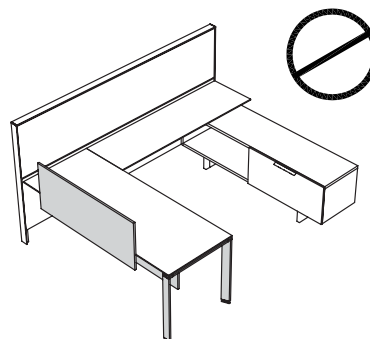
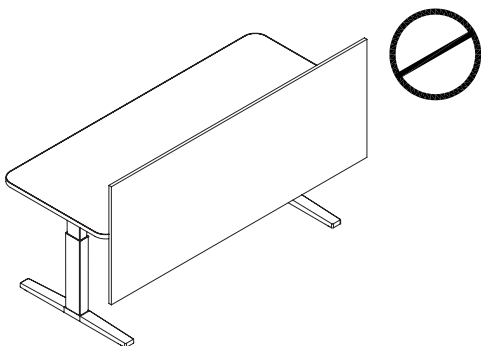

planning with desk edge screens (continued)

solid and glass desk edge screens

Desk Edge Screens provides visual privacy above desk height to a 42" datum with minimal modesty privacy below.

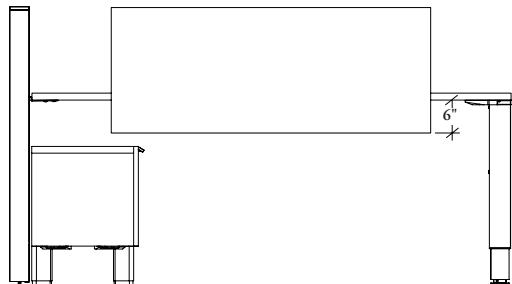

Desk Edge Screens extend 6" below the worksurface to provide minimal modesty privacy.

Desk Edge Screen – Full-Height (UNSFDE) provides visual privacy above and additional modesty privacy below.

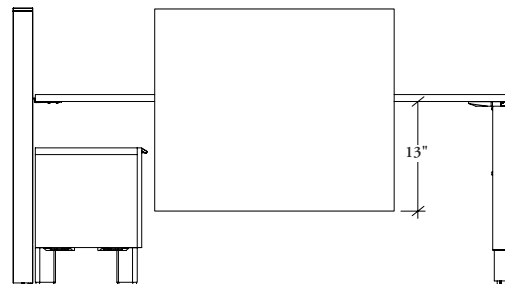

Desk Edge Screens – Full Height extend 13" below the worksurface to provide additional modesty privacy.

The Desk Edge Screen – Full Height (UNSFDE) can only be used on workspaces 30" and 36" deep when used in freestanding applications.

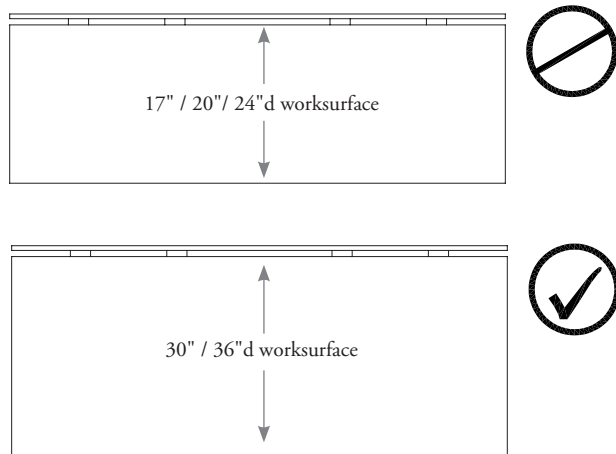

The Desk Edge Screen – Full Height (UNSFDE) can be used on all worksurface depths when workspaces are semi-suspended in panel wall applications.

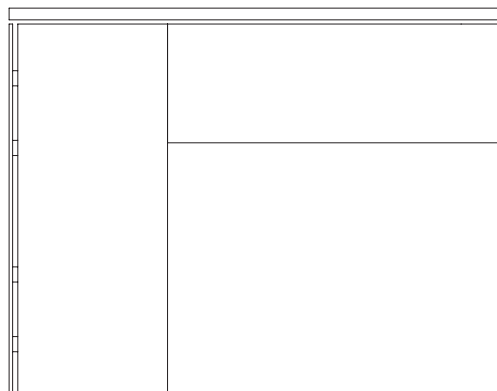

Solid and Glass Desk Edge Screens **cannot** be used on the side of a worksurface due to interference from storage and supports.

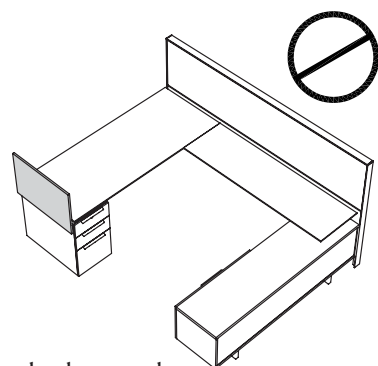

pedestal supported

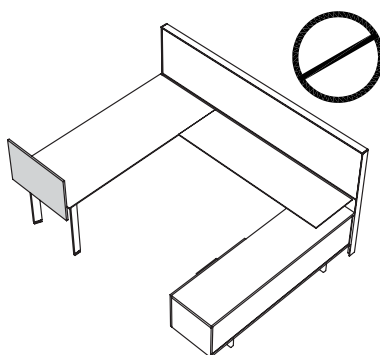

leg supported

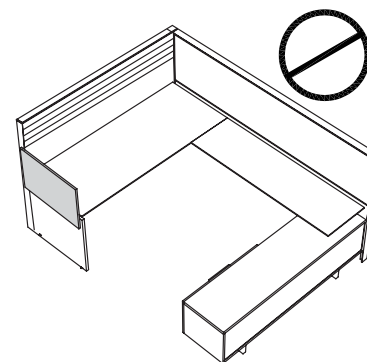

gable supported

planning with desk edge screens (continued)

The Desk Edge Screen (UNSD/ UNSDEG) is mounted with a 1" cable management gap from the surface.

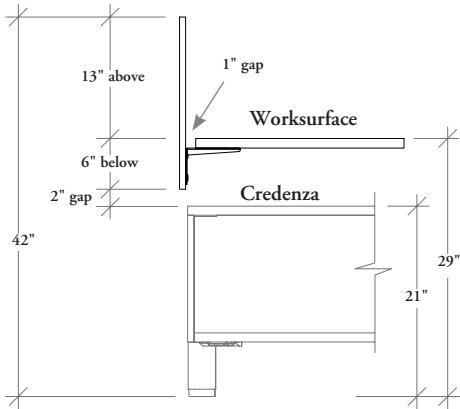

The Desk Edge Screen – Full-Height (UNSFDE/ UNSFDG) provides the 1" cable management gap.

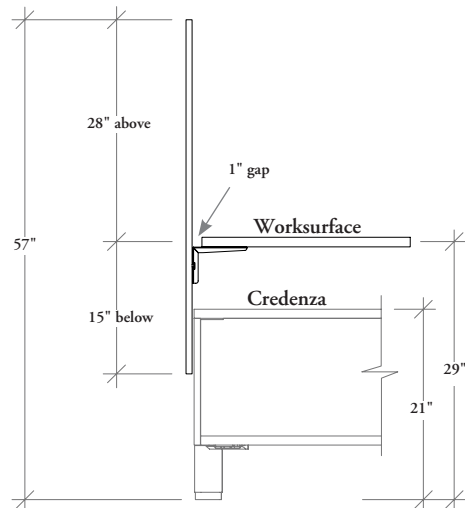
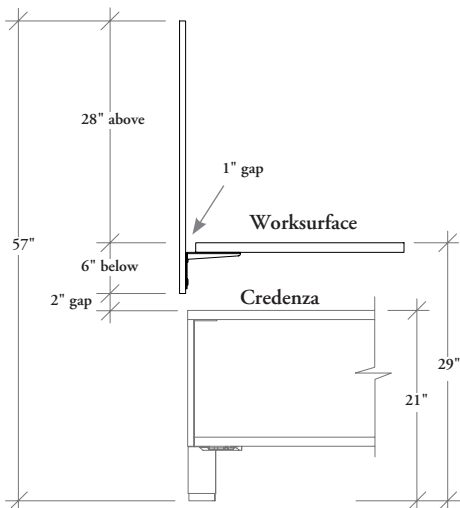
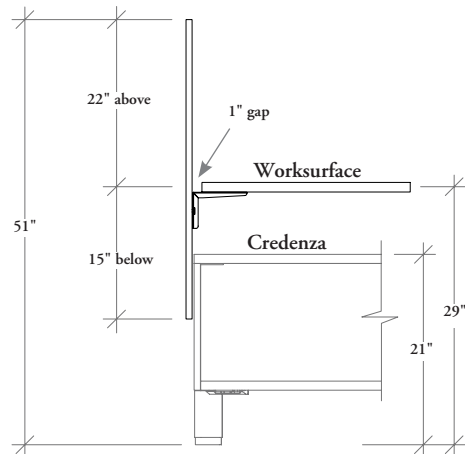
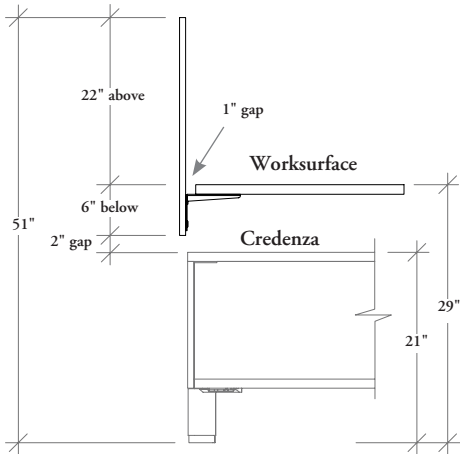
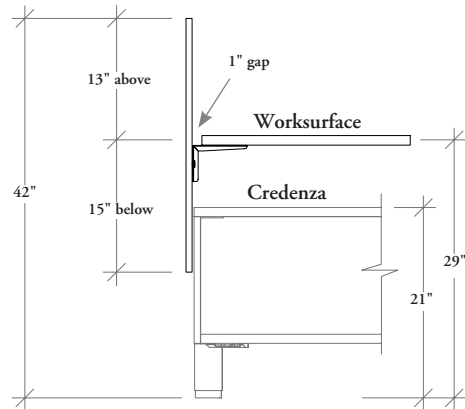

The desk edge screen extends 6" below the workspace providing a 2" clearance above a credenza.

The full height desk edge screen extends 15" (UNSFDE) or 17 2/5" (UNSF DG) below the workspace provides no clearance over a low credenza.

planning with desk edge screens (continued)

infinity screens

The following applications are available when planning with infinity screens.

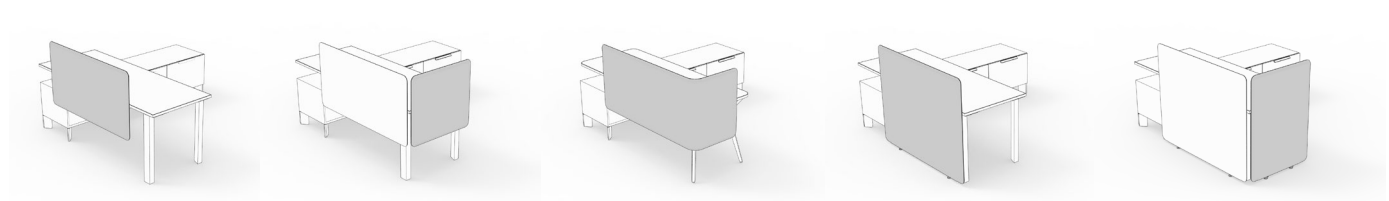

Desk Edge Screen

Side Desk Edge Screen

Curved Desk Edge Screen

Desk Edge Floor Screen

Side Desk Edge Floor Screen

Infinity Desk Edge Screens can be attached to worksurfaces in the following applications:

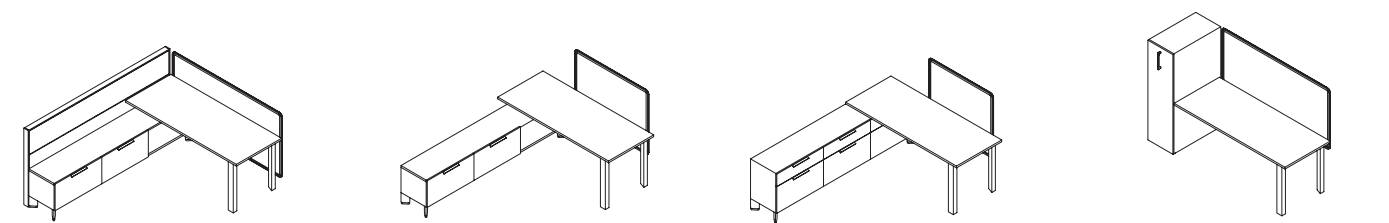

Worksurface attached to panel

Worksurface attached to low storage

Worksurface attached to high storage with width restrictions

Worksurface attached to the side of storage

The following are all of the possible datum and modesty heights for Desk Edge Screens.

Please refer to each individual screen for the list of specific heights available for that screen.

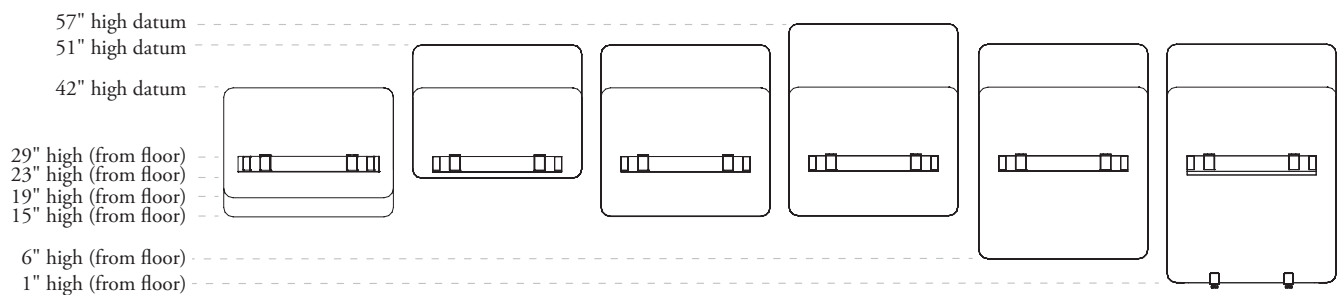

There are two types of patterns available when planning with the Quilted Infinity Desk Edge Screens:

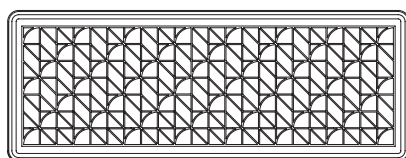

Pico

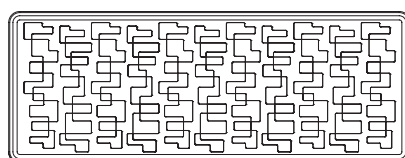

Diode

planning with desk edge screens (continued)

Infinity Screen widths are nominal.

- The actual width is 1/4" less on each side

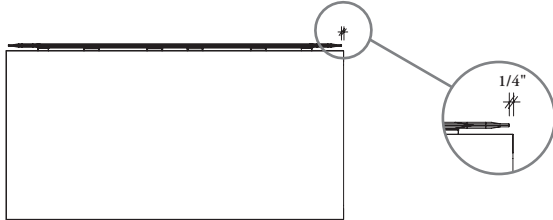

When two screens are planned side by side, there will be a 1/2" gap between the two screens.

- Screen Alignment Clips (GXCC) are used to align the two parallel screens

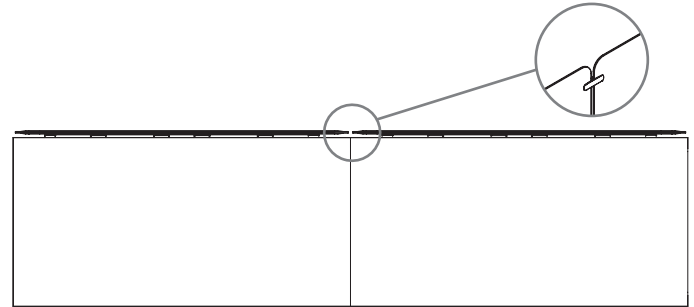

Infinity screens have no physical connection at corners. They are a casual fit.

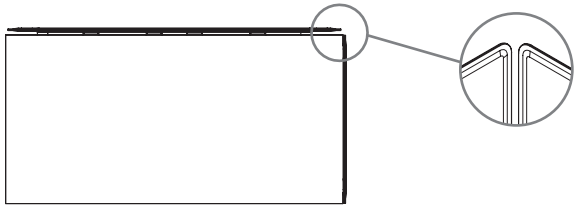

Infinity Desk Edge Screens offer an optional wire manager that accompanies the bracket connection.

- The gap will always be 1/2"
- A continuous trough allows for cable management
- The trough can accommodate a Power Rod (YEPD) or Power Bar (YEPS). Available from *Complements: Teknion's Ergonomics & Accessories Program*
- When planning with integrated height-adjustable tables, the wire manager should not be specified due to interference with storage below

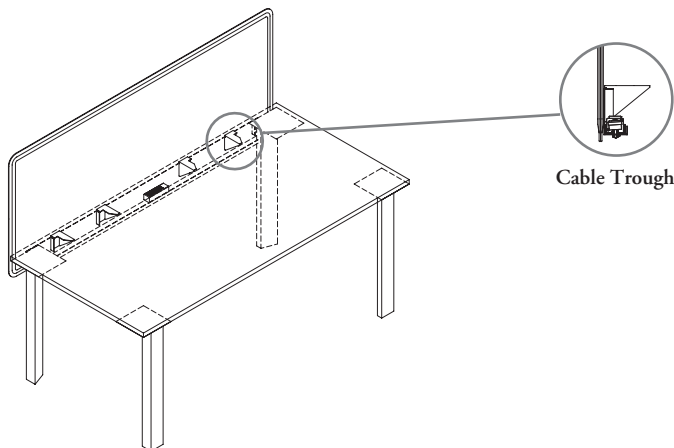

planning with desk edge screens (continued)

Curved Infinity Screens (GXCD) can be used with Rectangle with Radius Corners Worksurface (UNWC).

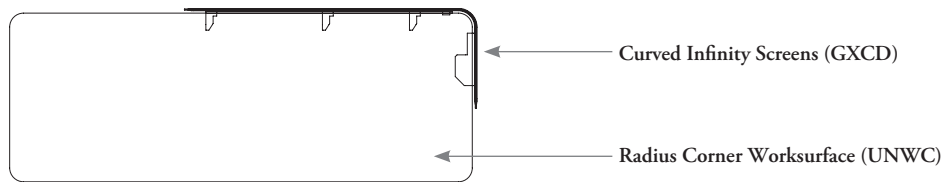

Two types of radius corner worksurfaces are available:

- rectangular with two radius corners
- rectangular with four radius corners

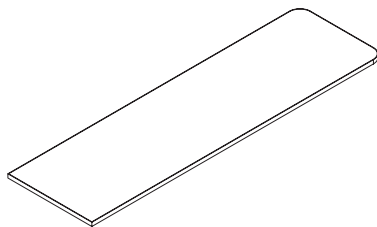

Rectangle with Radius Corners Worksurface (UNWC) - two radius

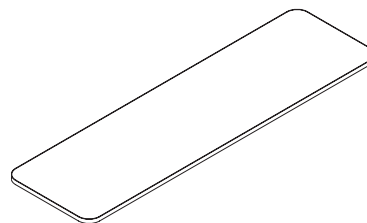

Rectangle with Radius Corners Worksurface (UNWC) - four radius

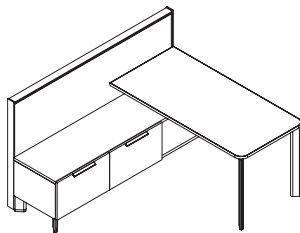

Two Radius Corners is suitable when the work surface needs to be terminated with square corners or when joined with a return work surface.

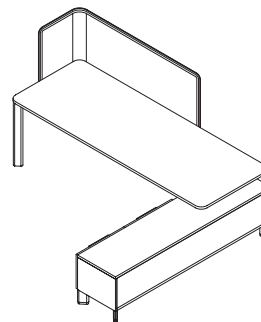

Four Radius Corners is suitable when a radius is desired on all corners of the surface and no other furniture is being planned against it.

For more information on Rectangle with Radius Corners Worksurfaces (UNWC), please see *Worksurfaces* section for more details.

The following leg styles can be used with Rectangle with Radius Corners Worksurfaces:

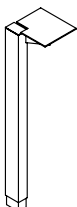

Interpret Leg (WWSWN)



upStage Leg (HTWD)

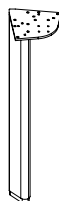

Leverage Leg (KLP1, KLP2, KLP3 and KLP4)

planning with desk edge screens (continued)

When planning a curved infinity screen with a District low credenza, the 23" h. modesty version must be used.

- The brackets on a 15"h. modesty will interfere with the credenza

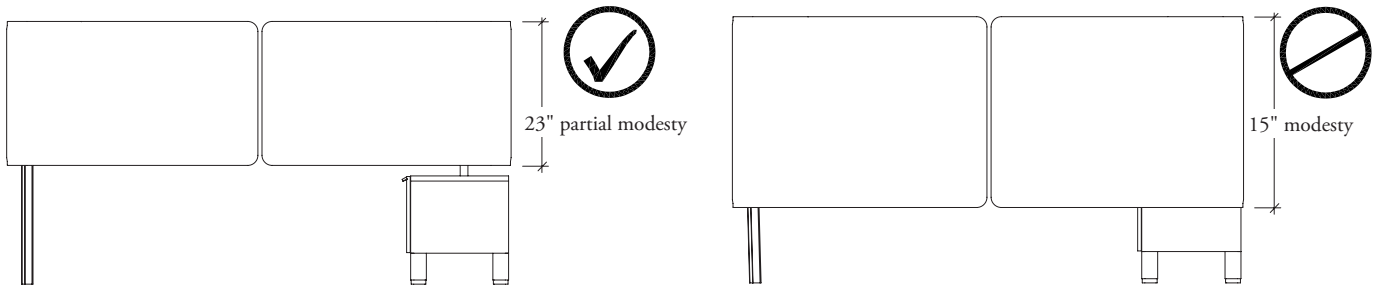

When Infinity Curved Desk Edge Screens are specified with credenza, screen needs to stop short of the edge of the desk when used with two worksurface supports depending on storage depth. For example, if 16" deep Credenza is specified, the screen must stop 16" from the edge of worksurface.

If Screen is justified to storage side with dual supports, Infinity Curved Desk Edge Screens with 30" to 60" width has to be specified.

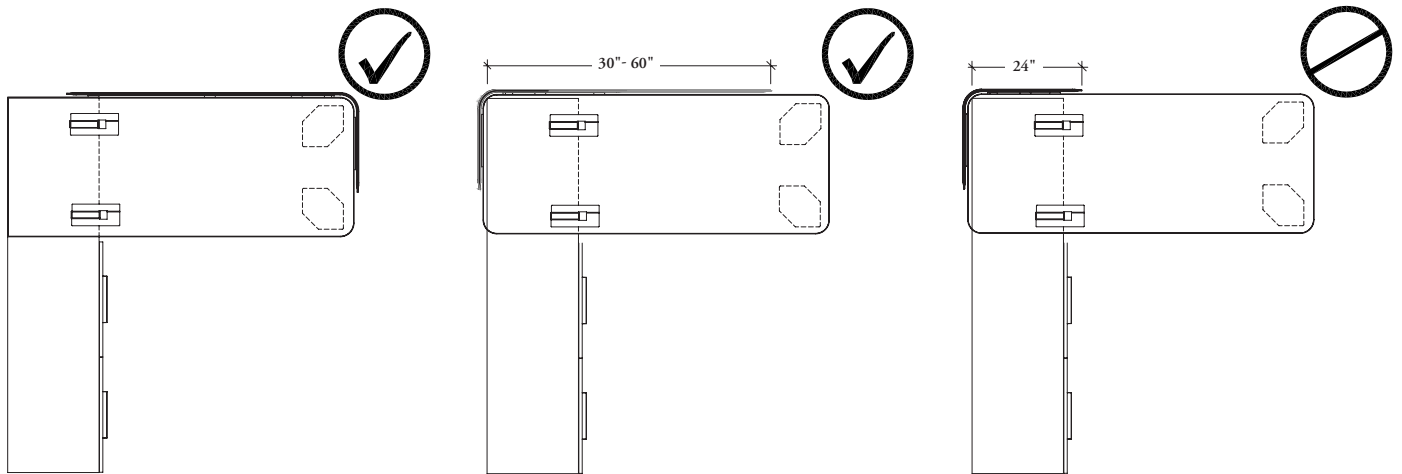

This application works with 23" modesty only.

If Infinity Curved Desk Edge Screen is justified to storage side with single support, any of the 24" to 60" wide screens can be specified.

When planning with a curved screen that almost fits the full width of the worksurface and the open end is facing the outside, it must stop a minimum of 4" from the edge to avoid post leg interferences.

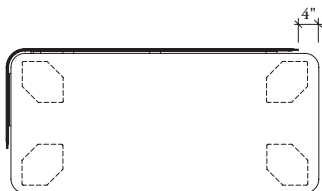

planning with desk edge screens (continued)

When planning with Infinity Desk Edge Screens with Rectangle with Radius Corners Worksurfaces, it is recommended to specify screens 6" less than the worksurface.

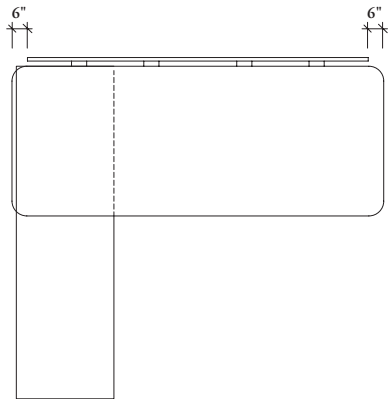

Infinity Curved Desk Edge Screen and Infinity Desk Edge Screen can be planned side-by-side

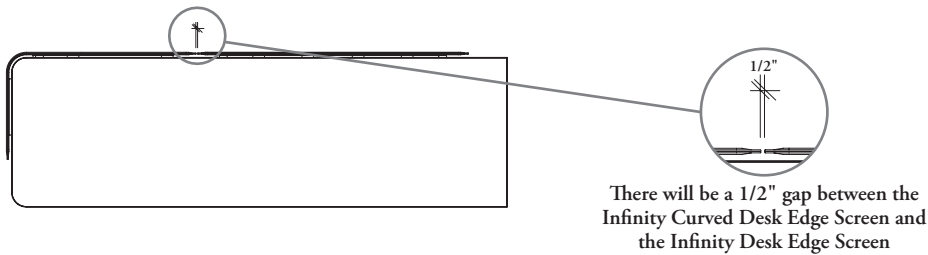

Infinity Desk Edge Screen with partial modesty (23") can be planned over low storage. With lower modesty heights (6", 15" and 19"), the screen must sit outside of the low storage to avoid interferences. Screens with 19" modesty heights are available in *Complements: Teknion's Ergonomics & Accessories*.

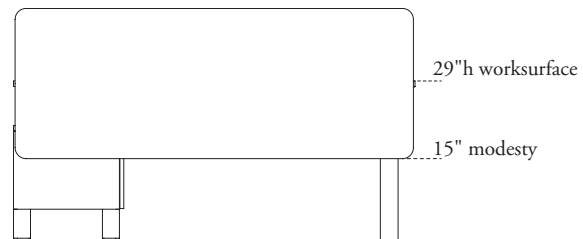
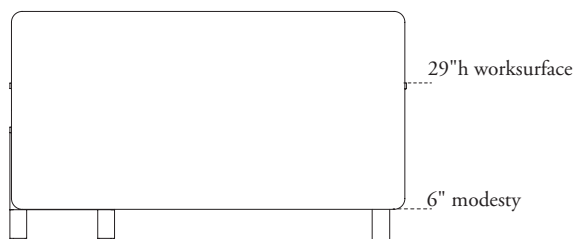
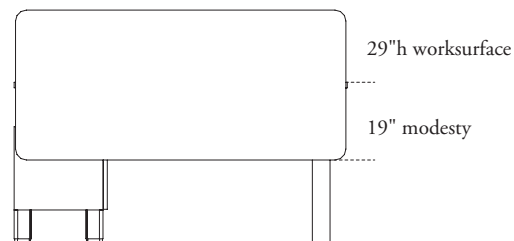
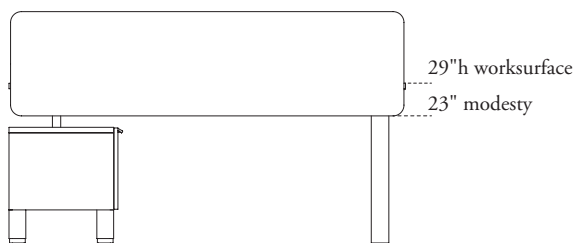

planning with desk edge screens (continued)

When planning with high storage, Infinity desk Edge Screen must stop short of storage as brackets will not be able to attach between storage and worksurface. The high storage should be specified to have open storage instead of drawers under the worksurface due to interference with the brackets.

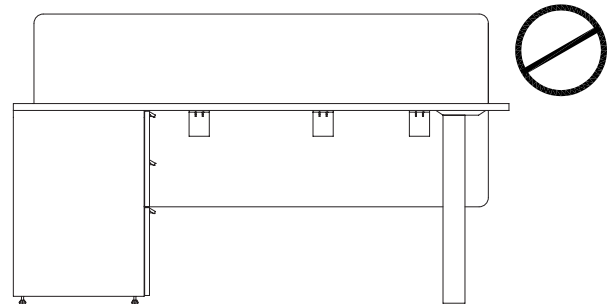
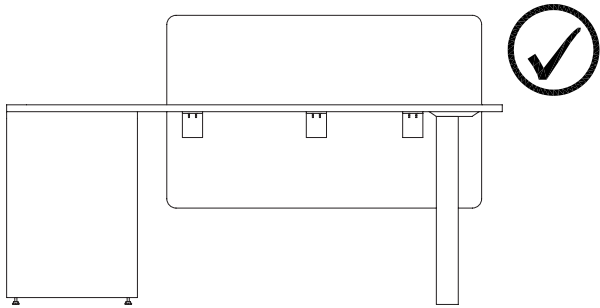

When planning an infinity desk edge screen perpendicular to a panel wall, the screen should extend to the panel wall to hide the 1" wire gap on the worksurface.

- It is not recommended that the screen extend past the end of the panel

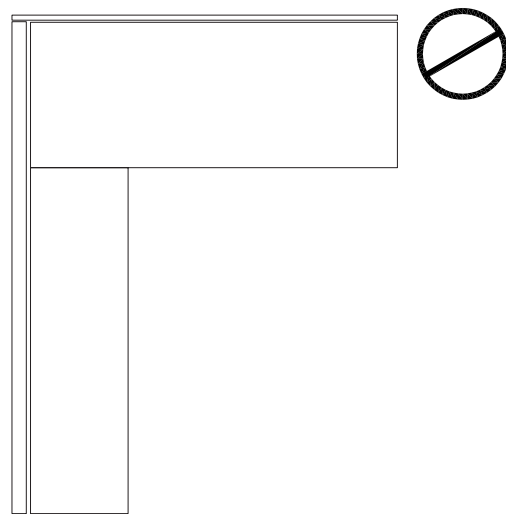
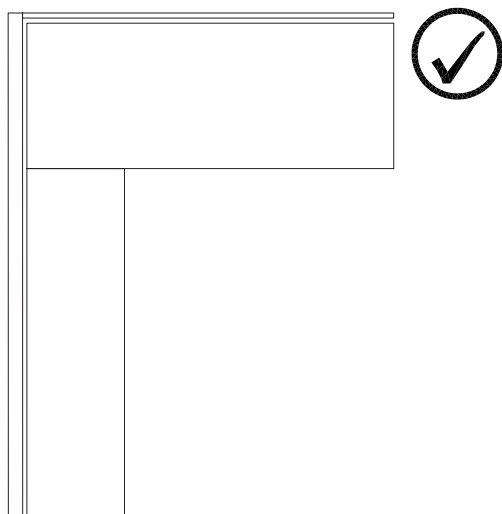

planning with desk edge screens (continued)

The following outlines the gables and legs that can be used with an infinity side desk edge screen.

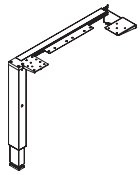

End Gable –
Height-Adjustable
(UNGEAN)

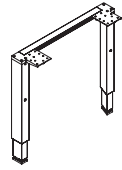

Semi-Suspended Gable
– Height-Adjustable
(UNGSAN)

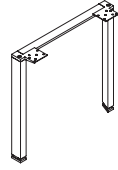

Semi-Suspended
Gable (UNGSN)

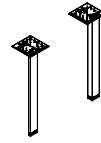

Leg – Pair
(UNLGPN)

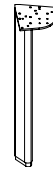

Leverage Leg
(KLP)



Infinity Side Desk Edge Screens can be planned in panel or to create corridor privacy on the end of return desks

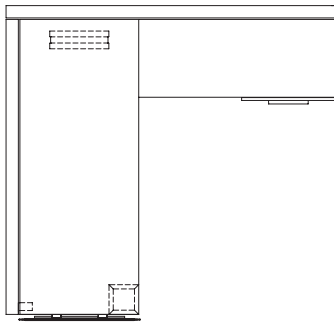

The screen provides additional privacy when used on the end of a workspace in a panel environment.

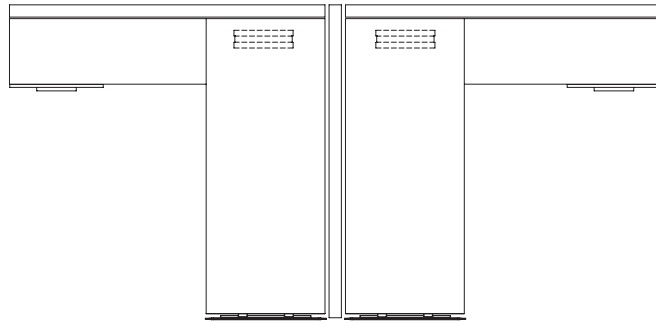

The screen provides corridor privacy in a non panel environment.

When planning with a low credenza, an infinity side desk edge screen can be used on the storage side.

- The screen must attach to the surface so that it sits outside of the credenza

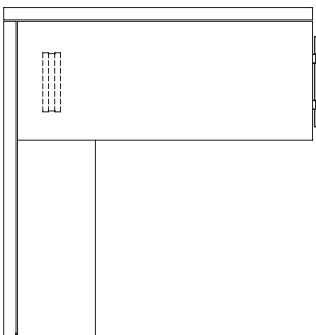

Low
Credenza

planning with desk edge screens (continued)

18" deep Infinity Side Desk Edge Screens (GXSD) and Infinity Side Desk Edge Floor Screens (GXED) have re-positionable brackets, allowing these screens to be planned on either side of the worksurface.

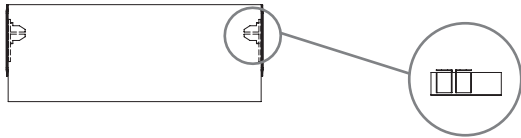

Infinity Side Desk Edge Screens can be planned at both partial and full depth.

All screens can be planned with 24"-36" d worksurfaces. Due to leg interference issues, this screen **cannot** be attached to 18" deep worksurfaces. An 18" side desk edge screen can be placed on a 23"/24" d worksurface as a partial fit.

<p>18" deep worksurface with 18" deep Infinity Side Desk Edge Screen (GXSD)</p>	<p>24" deep worksurface with 24" deep Infinity Side Desk Edge Screen (GXSD)</p>	<p>24" deep worksurface with 18" deep Infinity Side Desk Edge Screen (GXSD)</p>	<p>30" deep worksurface with 24" deep Infinity Side Desk Edge Screen (GXSD)</p>

planning with desk edge screens (continued)

framed fabric screens

The following applications are available when planning with framed fabric screens.

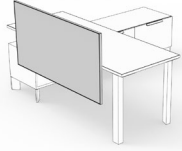

Desk Edge Screen

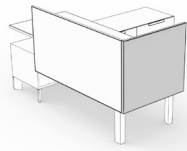

Side Desk Edge Screen

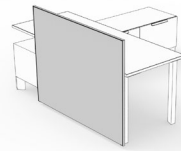

Desk Edge Floor Screen

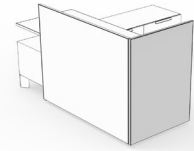

Side Desk Edge Floor Screen

Framed Fabric Desk Edge Screens can be attached to worksurfaces in the following applications:

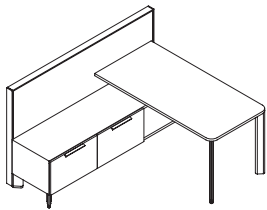

Worksurface attached to panel

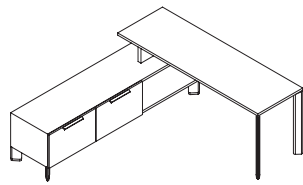

Worksurface attached to low storage

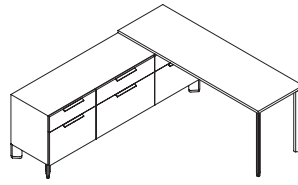

Worksurface attached to high storage with width restrictions

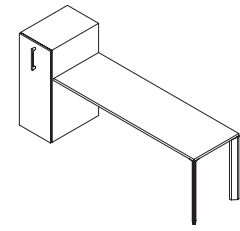

Worksurface attached to side of storage

Framed Fabric Screen widths are actual and will be same width as worksurface.



Framed Desk Edge Screens have a common bracket placement distance of 10-3/8" inset from the edge.



planning with desk edge screens (continued)

Framed Fabric Screen must be planned with a 1/2" wire gap in order to ensure front edge of the Framed Fabric Side Desk Edge Screen will be aligned to the front edge of the desk.

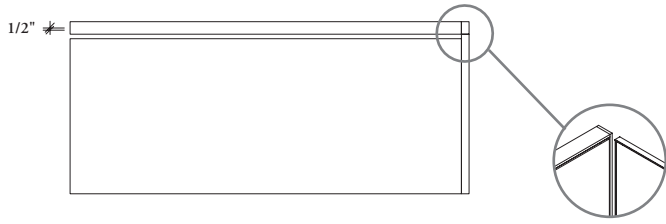

Corner detail with Framed Fabric Screens are closed and have physical connection between the Desk Edge Screen and Side Desk Edge Screen via extrusion trim.

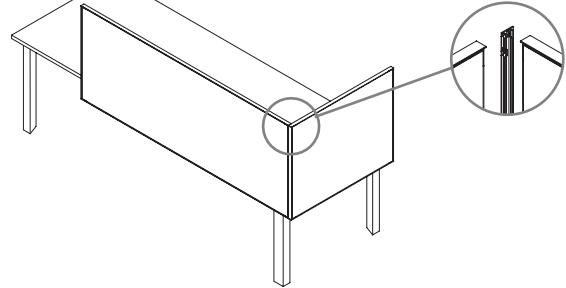

Framed Fabric Desk Edge Screen with partial modesty (23") can be planned over low storage. With lower modesty heights (6" and 15"), the screen must sit proud of the low storage to avoid interferences.

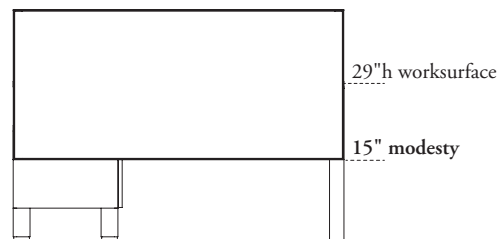
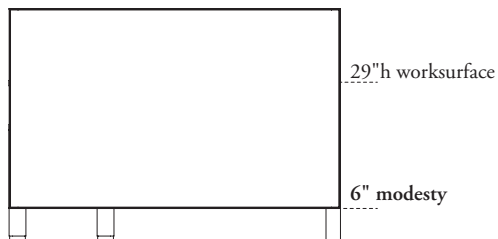
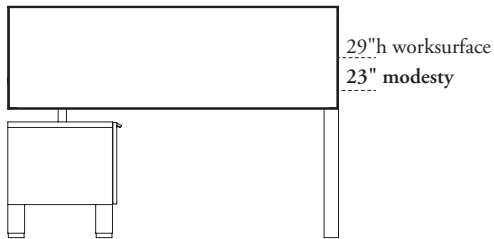

planning with desk edge screens (continued)

When planning with high storage, Framed Fabric Desk Edge Screen must stop short of storage as brackets will not be able to attach between storage and worksurface. The high storage should be specified to have open storage instead of drawers under the worksurface due to interference with the brackets.

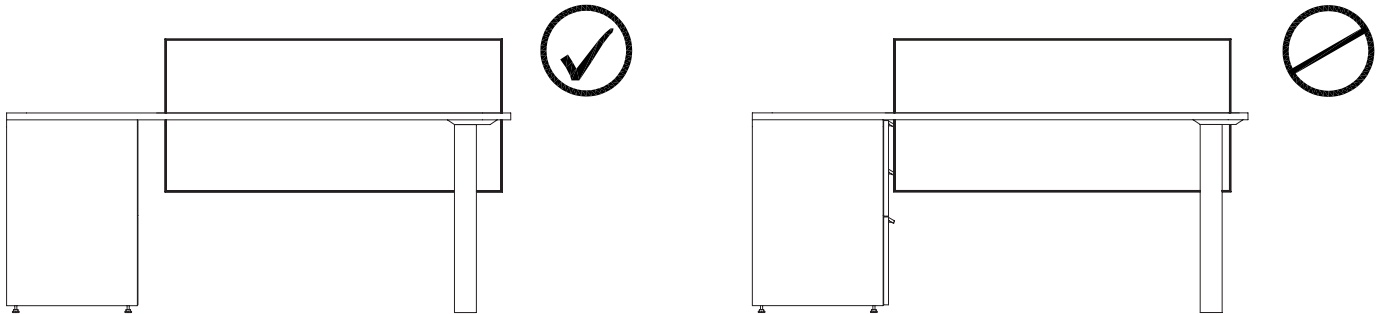

When planning a framed fabric desk edge screen perpendicular to a panel wall, the screen should extend to the panel wall to hide the 1" wire gap on the worksurface.

- It is not recommended that the screen extend past the end of the panel

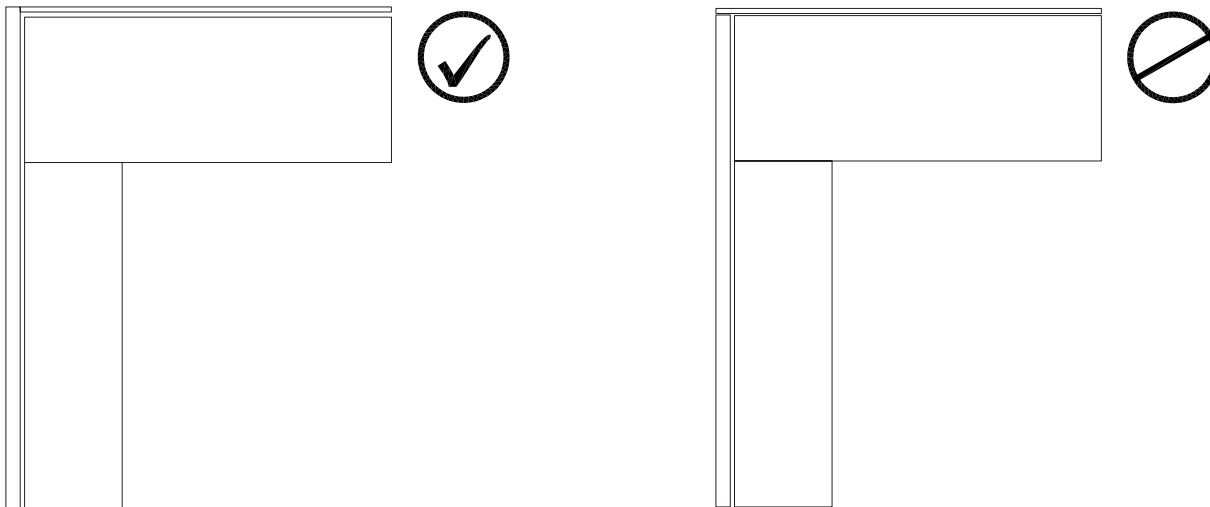

planning with desk edge screens (continued)

The following outlines the gables and legs that can be used with a framed fabric side desk edge screen.

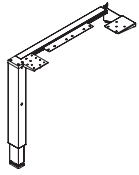

End Gable –
Height-Adjustable
(UNGEAN)

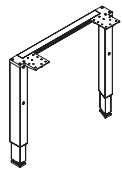

Semi-Suspended Gable
– Height-Adjustable
(UNGSAN)

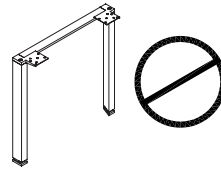

Semi-Suspended
Gable (UNGSN)

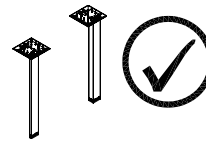

Leg – Pair
(UNLGPN)

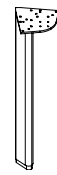

Leverage Leg
(KLP)

Framed Fabric Side Desk Edge Screens can be planned in panel or to create corridor privacy on the end of return desks

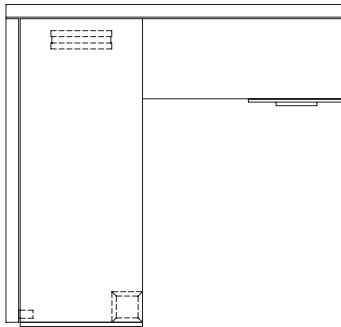

The screen provides additional privacy when used on the end of a worksurface in a panel environment.

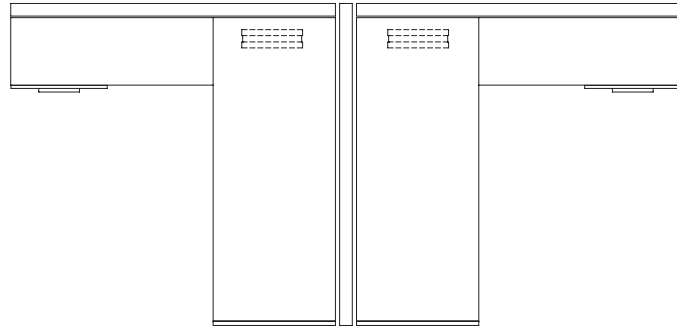

The screen provides corridor privacy in a non panel environment.

When planning with a low credenza, a framed fabric side desk edge screen can be used on the storage side.

- The screen must attach to the surface so that it sits outside of the credenza

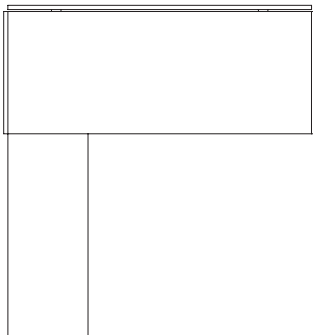

Low
Credenza

planning with desk edge screens (continued)

Framed Fabric Side Desk Edge Screens can be planned at both partial and full depth.

All screens can be planned with 24"-36"d worksurfaces. Due to leg interference issues, this screen **cannot** be attached to 18" deep worksurfaces. An 18" side desk edge screen can be placed on a 23"/24"d worksurface as a partial fit.



18" deep work surface with
18" deep Framed Fabric Side Desk
Edge Screen (GYSD)

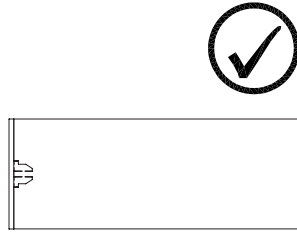

24" deep work surface with
24" deep Framed Fabric Side Desk
Edge Screen (GYSD)

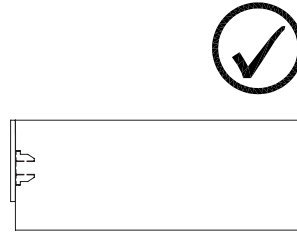

24" deep work surface with
18" deep Framed Fabric Side Desk
Edge Screen (GYSD)

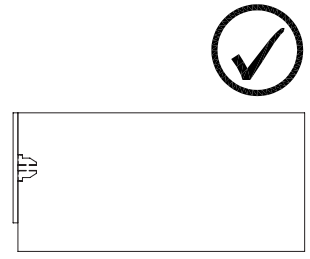

30" deep work surface with
24" deep Framed Fabric Side Desk
Edge Screen (GYSD)

planning with desk edge screens (continued)

desk edge screens with glass

Available in heights that match the datum heights of both Panel Wall Add-On Screens - Glass and Inset Glass Blades.

The support frame on a Panel Wall Add-On Screen - Glass is 2" high therefore increasing the datum height of the actual glass by 2".

Desk Edge Screens with Glass are also available with a 2" higher glass datum height.

When used together the two will align.

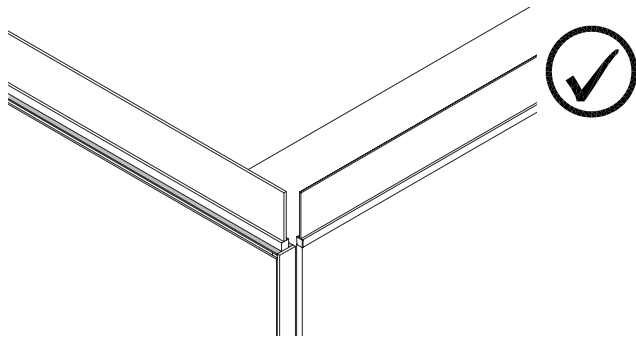

- Example shown:
42" high panel with 9" Panel Wall Add-On Screen = 51" overall height
- Recommended screen height with Glass:
44" h with 7" glass
- This allows for the 2" add-on glass frame height

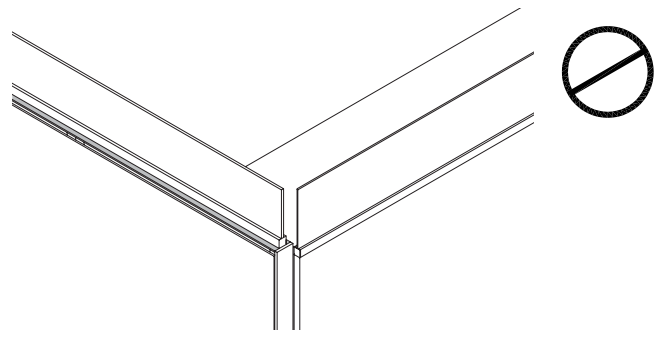

- Using a 42" h solid with 9" glass will result in a 2" difference in the datum heights of the glass

There is no support frame on an Inset Glass Blade, the glass mounts directly into the panel frame so the datum height of the glass does not change.

Desk Edge Screens with Glass are available with datum heights that match the top of a panel frame.

When used together the two will align.

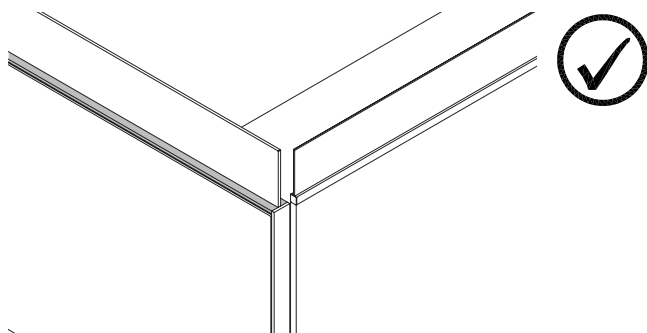

- Example shown:
42" h panel with 9" Inset Glass Blade = 51" overall height
- Recommended screen height:
42" solid with 9" glass
- This allows both glass datum heights to be at 42" h

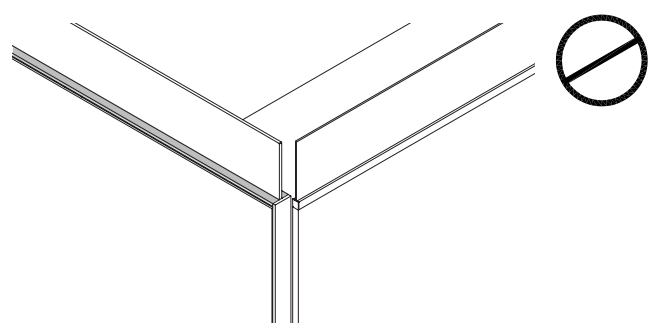

- Using a 44" solid with 7" glass will result in a 2" difference in the datum heights of the glass

desktop lateral screen basics

Lateral screens attach to the top of a worksurface to provide lateral privacy and space division at multiple heights.

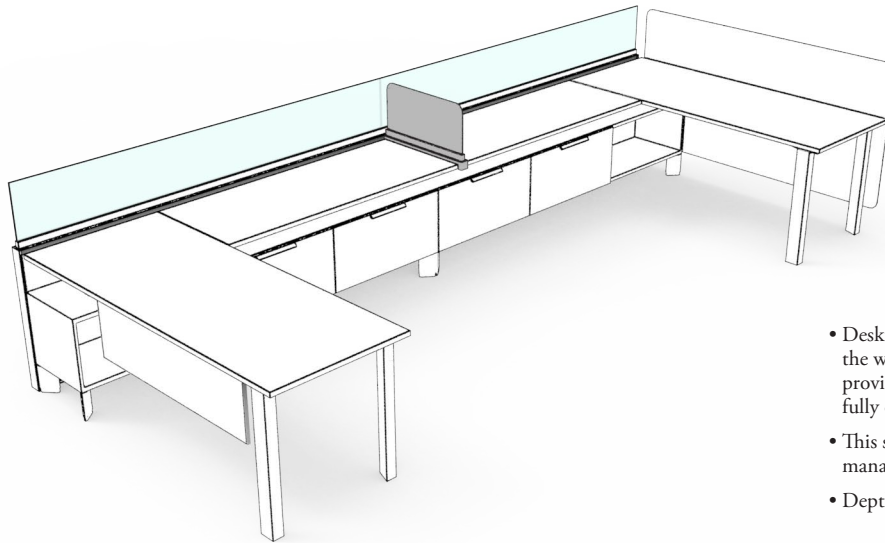

- Desktop Lateral Screens attach to the worksurface without any tools to provide lateral space division. It rests fully on the worksurface
- This screen has 1" gap for wire management
- Depths: 23", 29" and 35"

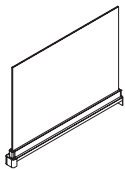

- 6mm Glass Lateral Screen (GNGD)**
- A 6 mm glass screen with a straight profile
 - Heights:
 - 13" for a 42"h datum
 - 22" for a 51"h datum
 - 28" for a 57"h datum
 - Finish:
 - Clear
 - Frost

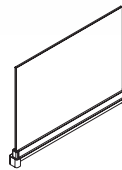

- 10mm Glass Lateral Screen (GNTD)**
- A 10 mm glass screen with a straight profile
 - Heights:
 - 13" for a 42"h datum
 - 22" for a 51"h datum
 - 28" for a 57"h datum
 - Finish:
 - Clear
 - Frost

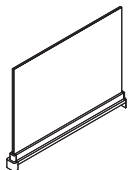

- Writable Glass Lateral Screen (GNWD)**
- A writable glass screen with a straight profile
 - Heights:
 - 13" for a 42"h datum
 - 22" for a 51"h datum
 - 28" for a 57"h datum
 - Finish:
 - Specialty Glass Laminate
 - Specialty Glass Grade 7

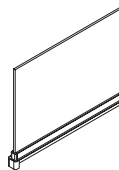

- Solid Lateral Screen (GNSD)**
- A solid screen with a straight profile
 - Heights:
 - 13" for a 42"h datum
 - 22" for a 51"h datum
 - 28" for a 57"h datum
 - Finish:
 - Source Laminate
 - Natural Veneer
 - Flintwood

desktop lateral screen basics (continued)

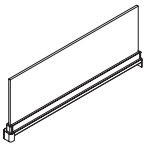

Writable Laminate Lateral Screen (GNLD)

- A writable laminate screen with a square profile
- Heights:
 - 13" for a 42"h datum
 - 22" for a 51"h datum
 - 28" for a 57"h datum
- Finish:
 - Specialty Writable Laminate

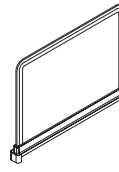

Infinity Fabric Lateral Screen (GNXD)

- A fabric screen with a curved profile
- Heights:
 - 13" for a 42"h datum
 - 22" for a 51"h datum
 - 28" for a 57"h datum
- Finish:
 - Select Panel and Upholstery fabrics are available - please refer to the *Teknion Textiles Program Guide*

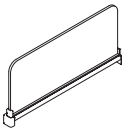

Smooth Felt Lateral Screen (GNZD)

- A felt screen with a curved profile
- Heights:
 - 13" for a 42"h datum
 - 22" for a 51"h datum
- Finish:
 - Strata
 - Pewter
 - Lunar

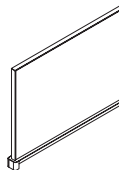

Framed Fabric Lateral Screen (GNYD)

- A framed fabric screen with a square profile
- Heights:
 - 13" for a 42"h datum
 - 22" for a 51"h datum
 - 28" for a 57"h datum
- Finish:
 - Select Panel and Upholstery fabrics are available - please refer to the *Teknion Textiles Program Guide*

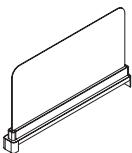

Metal Lateral Screen (GNMD)

- A metal screen with a curved profile
- Heights:
 - 13" for a 42"h datum
 - 22" for a 51"h datum
- Metal Finish:
 - Foundation
 - Mica
 - Accent

planning with desktop lateral screens

The following should be considered when planning with desktop lateral screens.

It is important to understand the depth of worksurfaces with panels when specifying lateral screens.

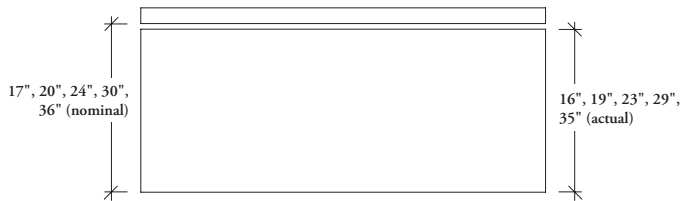

- All worksurfaces have nominal depths (the actual depth is 1" less than the nominal depth) to allow for a gap at the back
- The gap is not optional, it is the standard configuration

- Lateral screens have nominal depths and can be specified to fit Rectangular Worksurfaces (UNWR)
- Actual depths of lateral screens are:
 - 24" deep is 23" deep
 - 30" deep is 29" deep
 - 36" deep is 35" deep

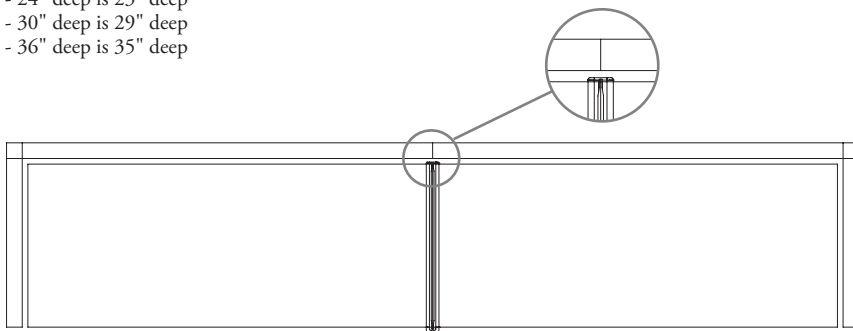

- The depth of Lateral Screens must always be the same depth as the work surface

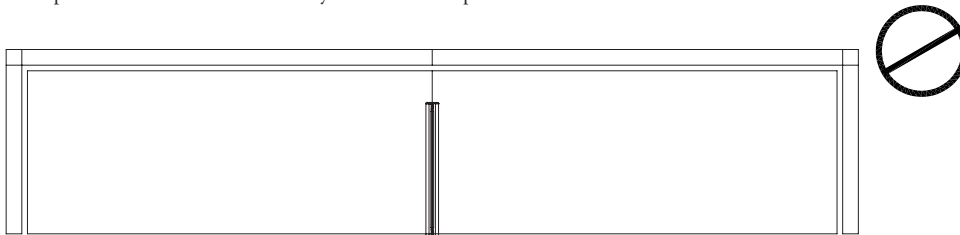

The following outlines the features of the Desk Top Casual Screen

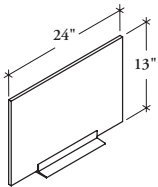
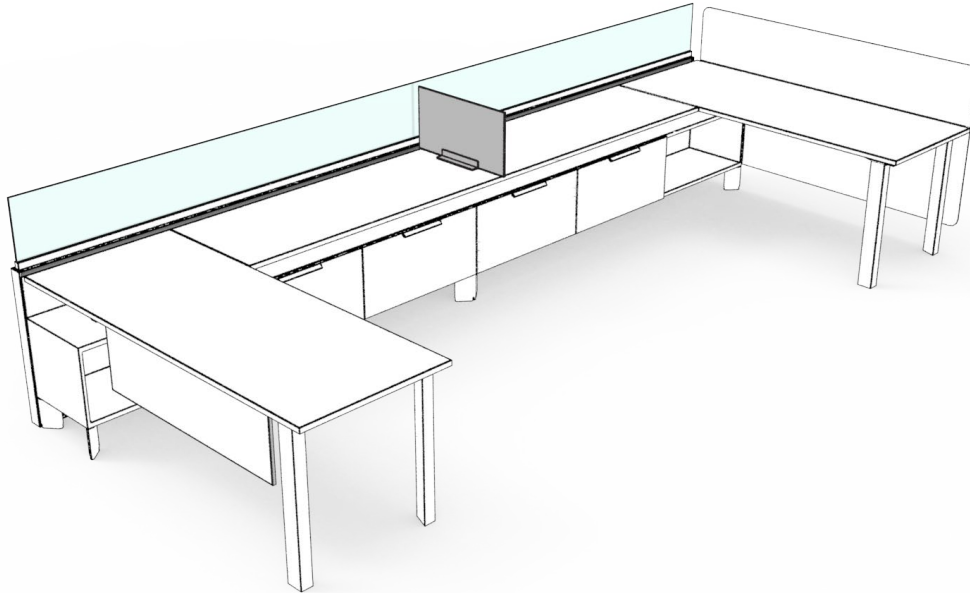

Desk Top Casual Screen (UNSDT)

- Is a freestanding screen which sits on top of the worksurface to provide privacy
 - extends 13" above the worksurface for seated height privacy
- Height: 13"
- Widths: 24"
- Screen Finishes:
 - Source Laminate
 - Flintwood
 - Natural Veneer
- Base Finishes:
 - Foundation
 - Mica
 - Clear Anodized

modesty screen basics

The following outlines the features of the Modesty Screen.

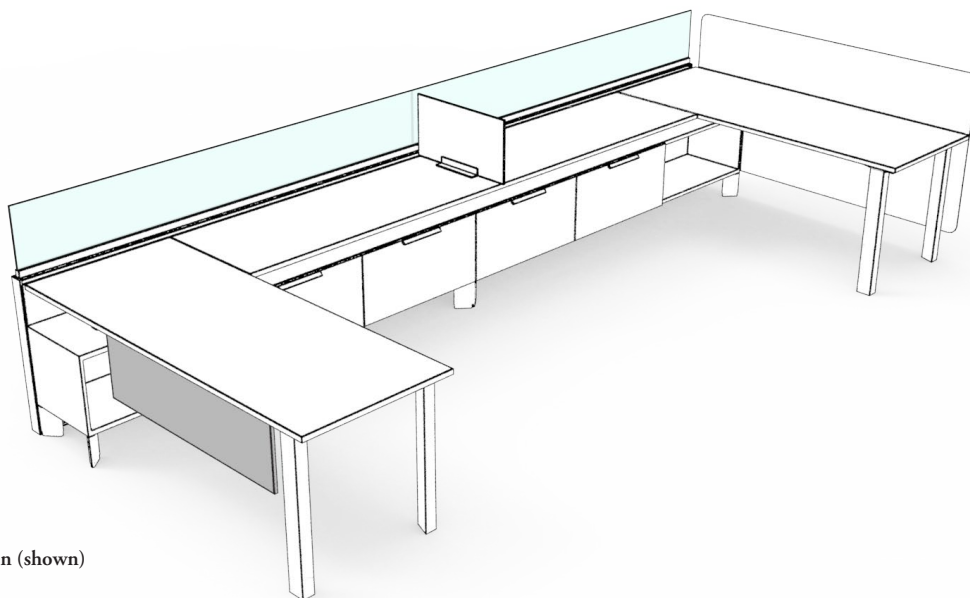

Modesty Screen (shown)

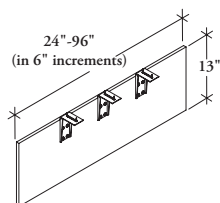

Modesty Screen (UNSM)

- Mounts 1" below worksurfaces to provide visual privacy
- Is an off-module casual fit
- Actual width is 1" less than the nominal width
- Available in Source Laminate, Fascia Laminate, Standard Flintwood and Natural Veneer finishes
- The Modesty Screen is 14" above finished floor

planning with modesty screens

The following should be considered when planning with Modesty Screens.

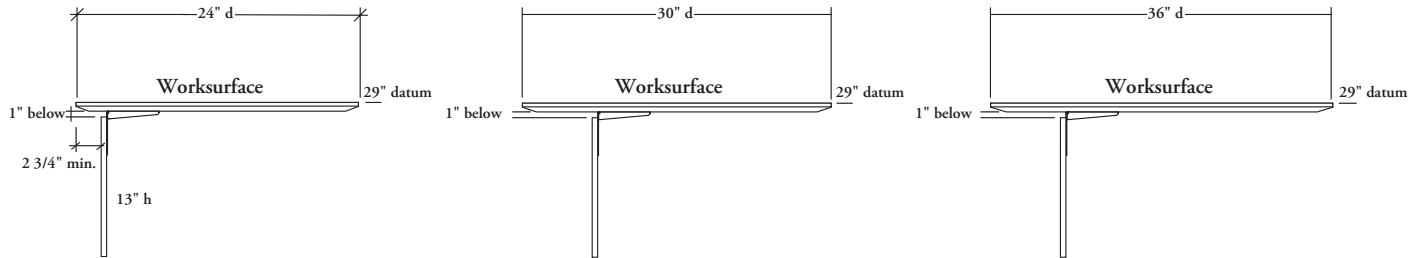

- The suggested minimum recess for the Modesty Screen is 2 3/4" from the back edge of the workspace
- The recommended distances are:
 24" workspace 2 3/4" inset
 30" workspace 6" inset
 36" workspace 12" inset

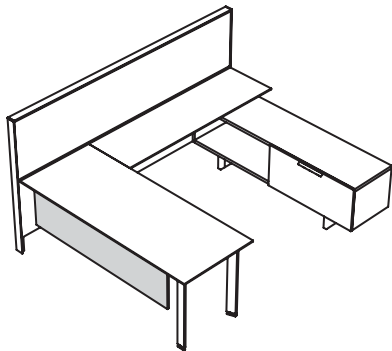

The Modesty Screen should be centered in the open space between supports.

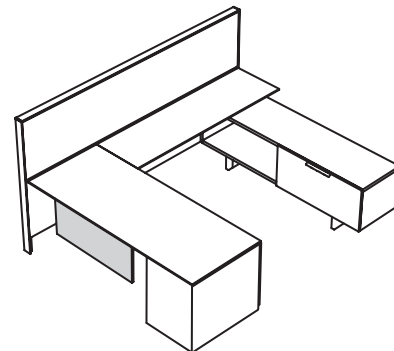

The Modesty Screen can be mounted on workspaces with various types of desk support options including storage – Attention must be given to reinforcement channel location (please see *Supports* section for details).

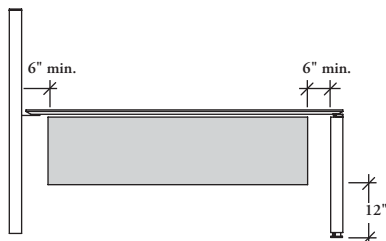

A casual fit is desired, it is recommended that the modesty screen be specified 6" less than the workspace width on both sides in the area of application.

floor screen basics

The following outlines the features of the Floor Screen.

Floor Screen (shown)

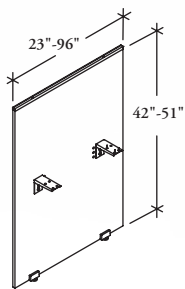
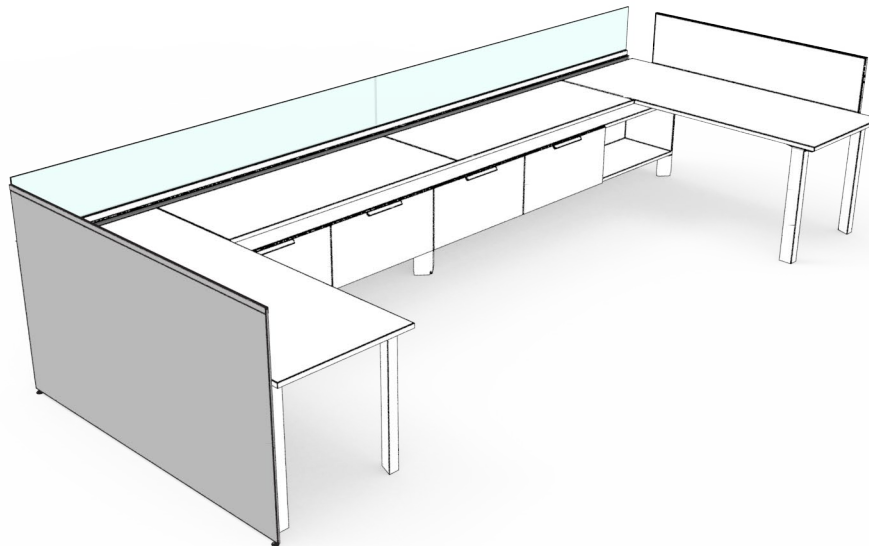

Floor Screen (UNSF)

- A 5/8" thick, 42" or 51" high visual screen that provides privacy to floor level
- Is mounted to a worksurface on- or off-module
- Available in widths from 23" to 96" in 1" increments for 42" high and 23" to 48" widths available in 1" increments for 51" and 57" high
- Provides full width or casual fit with controlled gaps
- Does **not** provide support to the worksurface
- Can only be attached to worksurfaces that are permanently affixed to at least one piece of storage, a Panel Wall, or to a freestanding desk with a return
- Aluminum top rail can accommodate the Pencil Tray (PAX94), Media Organizer (PAX96), Vertical Organizers (PAX99, PAX100) and Workstation Signage (ACWS). Available from Complements: *Teknion's Ergonomics & Accessories Program*
- Can be used with a Vertical Cable Manager (UNVC) which manages cables between the floors and the underside of the worksurface. Must be specified separately. (see *Electrics* section)

Floor Screen Extended Leveling Kit (UNSFXL)

- Available for height adjustment and leveling on uneven floors

grain direction

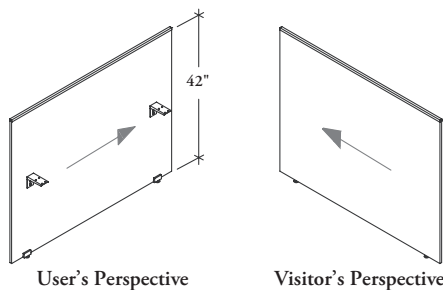

- For 42" high floor screens the grain runs horizontal
- For Cathedral Flintwood and Natural Veneers the grain direction is from left to right from the user's perspective. From the visitor's perspective, outside the workstation, the grain direction is right to left

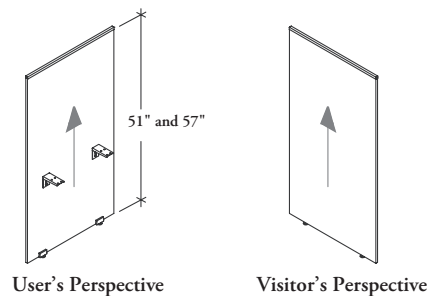

- For 51" and 57" high floor screens the grain runs vertical
- For Cathedral Flintwood and Natural Veneers the grain direction is from bottom to top from both the user's and visitor's perspective, inside and outside the workstation

planning with floor screens

The following should be considered when planning with Floor Screens.

workspace support

Floor screens can only be used with the following applications:

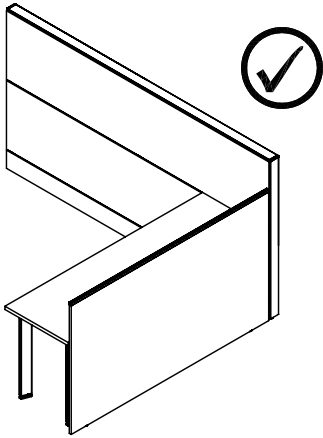

Worksurfaces that are fixed to a panel wall

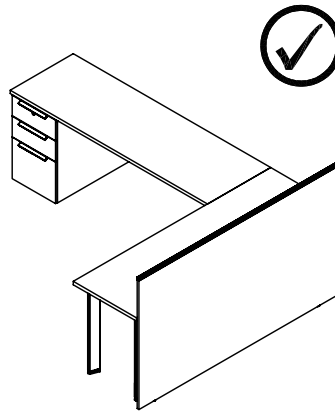

When permanently attached

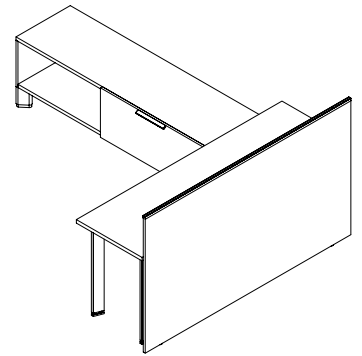

In freestanding applications with a workspace return

screen widths

Screens can be installed at different widths depending on the intended result and sizes available.

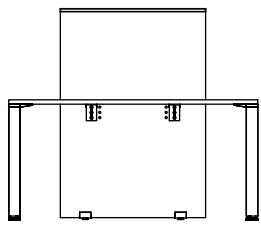

Casual width for partial privacy

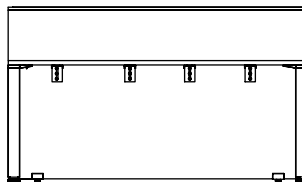

Full width for total privacy

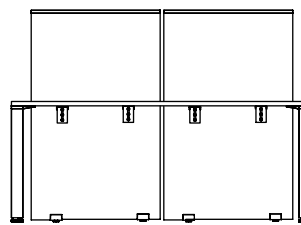

Side-by-side to achieve a specific width and height

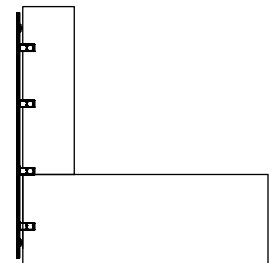

Single or multiple screens can span across two workspaces

gapping

The Floor Screen is mounted with a 1" gap for cable management.

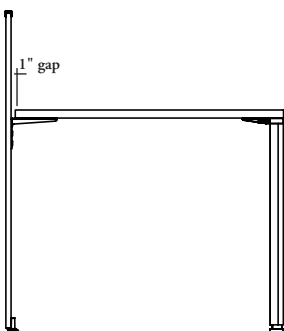

storage screen basics

The following outlines the features of the Storage Screen.

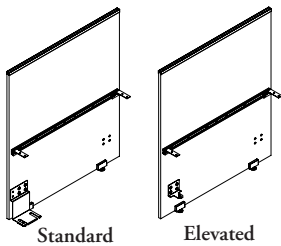
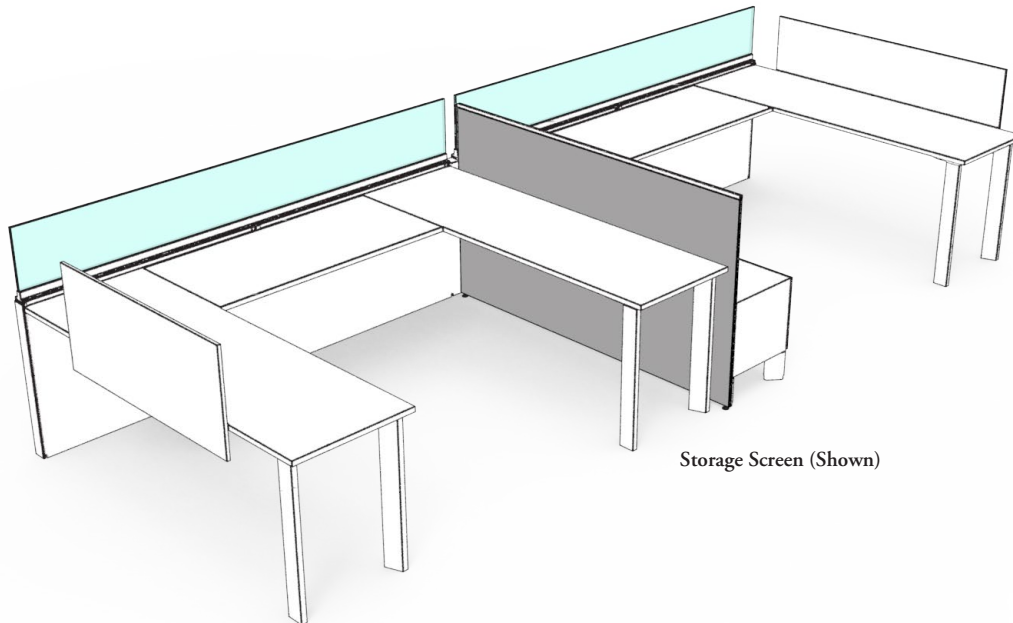

Storage Screen (UNSSS)

- Mounts to 21" high and 28" high storage credenzas to provide casual space division
- Heights:
 - 42"h
 - 51"h
 - 57"h
- Widths:
 - 24", 30"-96" in 1" increments
- The screen mounts into the slots on the back of credenzas or storage
- Has a leveling range of 0.5 down and the brackets allow it to remain attached to storage
- On storage less than 60" wide, the screen should be specified to span the entire width of the cabinet and on storage 60" wide and over, the screen can mount off-module and be specified shorter

planning with storage screens

The following should be considered when planning with Storage Screens.

The Storage Screen mounts into the slots on the back of low and high credenzas and storage units.

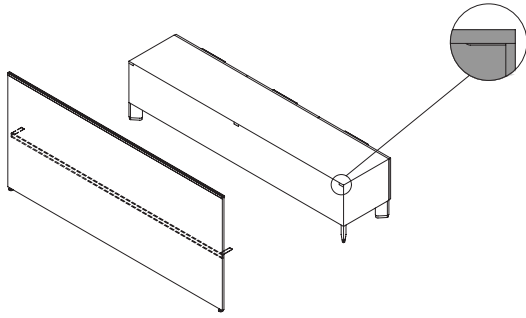

- Mounts on credenzas less than 60" wide, the screen must span the entire width of the storage

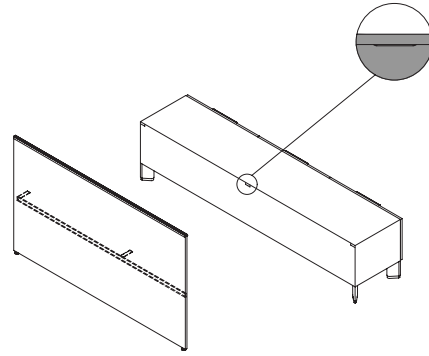

- Mounts on storage 60" wide and over, an additional slot is provided in the center of the credenza for off-module mounting
- To mount off-module, the screen must be at least half the width of the storage and must be flush to one end of the cabinet to align with slot location. The screen can **not** extend past the end of the storage

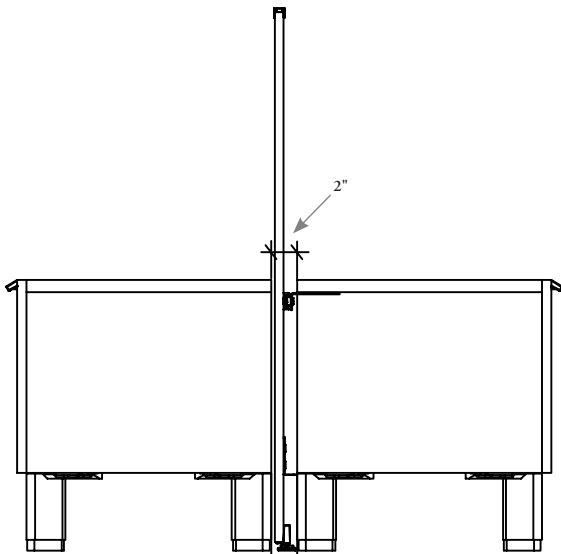

- When a screen is used between two credenzas the screen will mount only to the back of one credenza
- A 2" gap is required between credenzas for mounting

storage screen typicals

The following typicals demonstrate planning options for the storage screen.

double storage spine (full width)

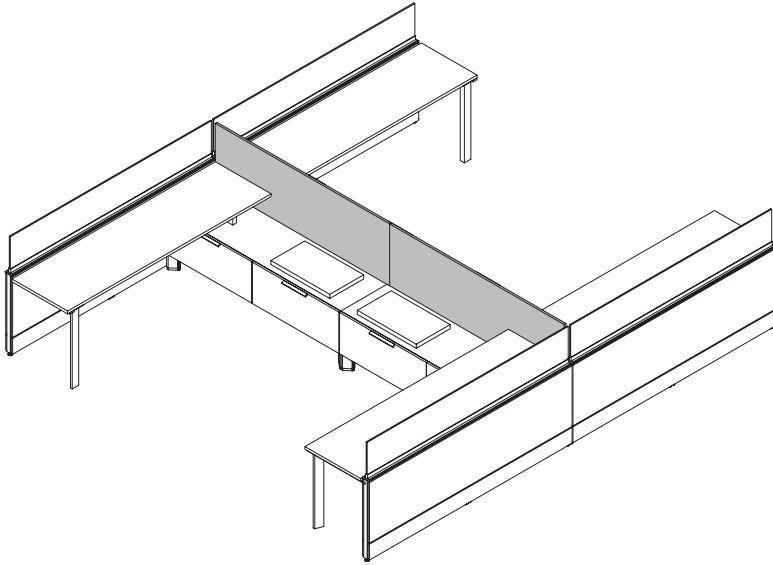

single corridor screen (full width)

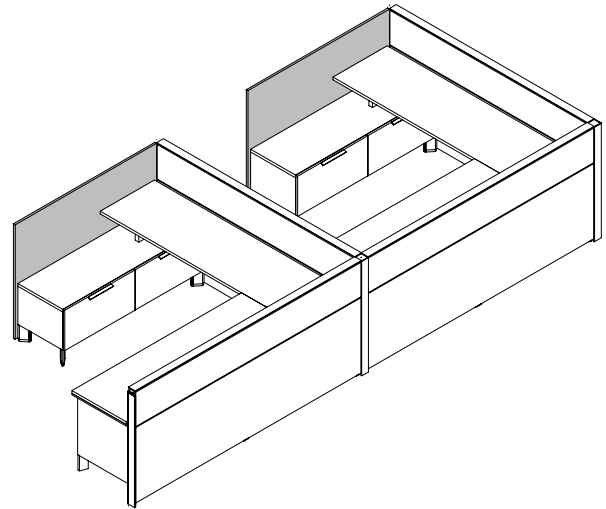

double storage wing divider (off-module)

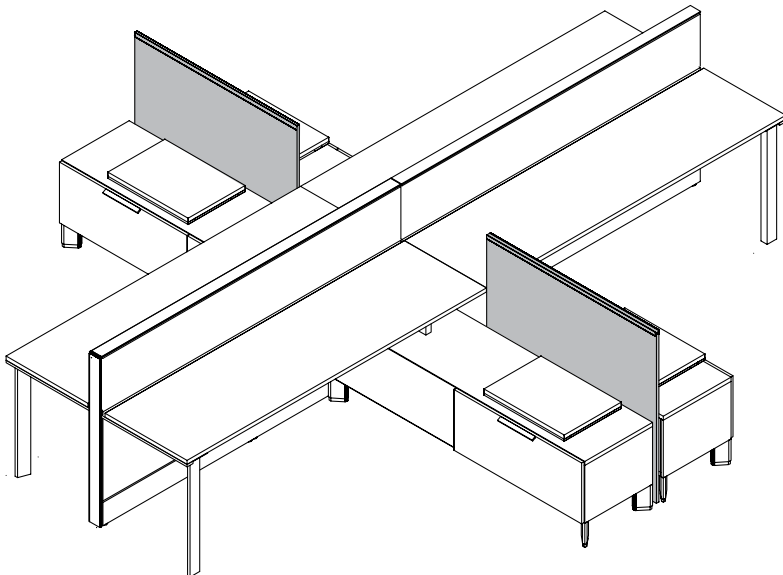

solid lateral screen basics

The Solid Lateral Screen is used with freestanding panels to provides a clean aesthetic and allows for seated privacy between users.

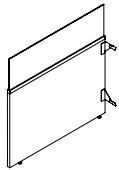
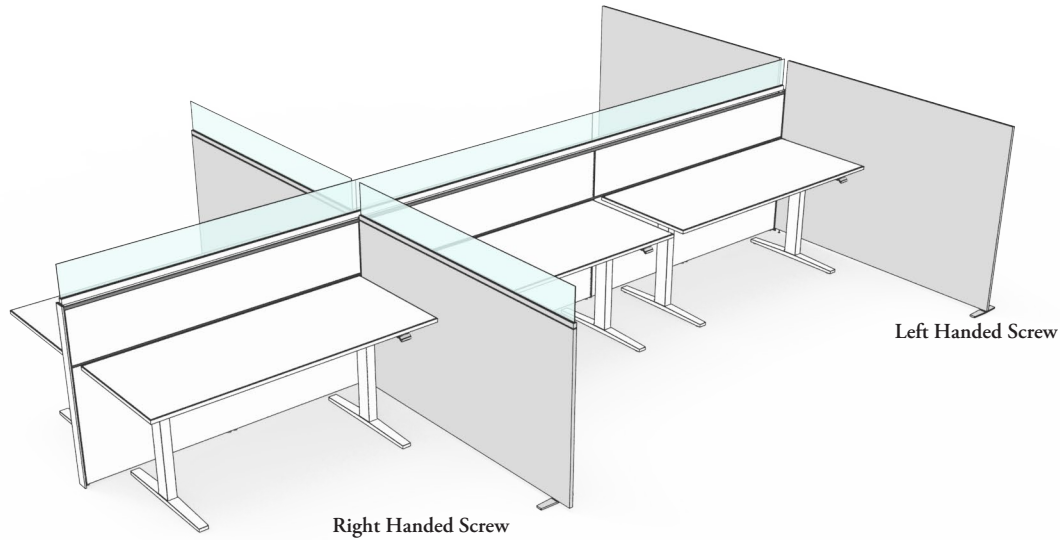

Solid Lateral Screen with Glass (UALSG)

- 42" high screen include 13" high glass in the overall height
- 51" high screen include options of 9" or 22" high glass in the overall height
- 57" high screen include 15" high glass in the overall height
- **Cannot** be used with the 29" Height Inset panels (UYPCR, UYPER, UYPER)
- For high solid lateral screens with Source Laminate finishes the grain runs horizontal. For Cathedral Flintwood and Natural Veneers the grain direction is from left to right from the user's perspective

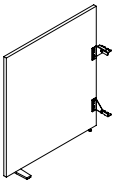

Solid Lateral Floor Screen (UALSS)

- Can accommodate a tack board
- **Cannot** be used with the 29" Height Inset panels (UYPCR, UYPER, UYPER)
- For high solid lateral screens with Source Laminate finishes the grain runs horizontal. For Cathedral Flintwood and Natural Veneers the grain direction is from left to right from the user's perspective

- Available in widths from 24" - 72" in 6" increments
- Available 42", 51" and 57" high
- The screen thickness is 1"
- A stability foot is included on screens 48" and wider
- The screen must mount into the 6" high horizontal rail, therefore the screen **cannot** be specified with monolithic fascias

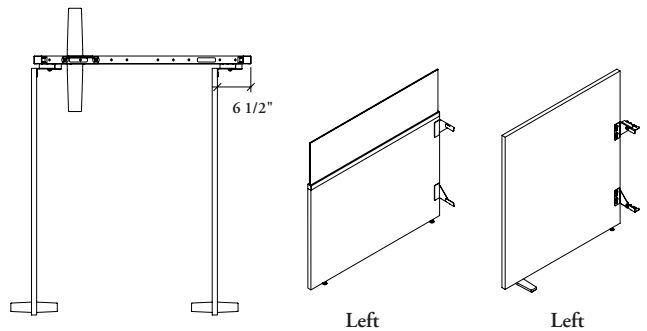

- The left handed orientation will have the visible mounting brackets on the right and the support foot (if required) will be on the left
- The right handed orientation will have the visible mounting brackets on the left and the support foot (if required) will be on the right
- It is especially important at the end condition. If it is specified with the incorrect handedness, the screen will sit in 6 1/2" from the end

end mount lateral screen basics

End Mount Lateral Floor Screens mount perpendicular to a panel to provide privacy and panel support.

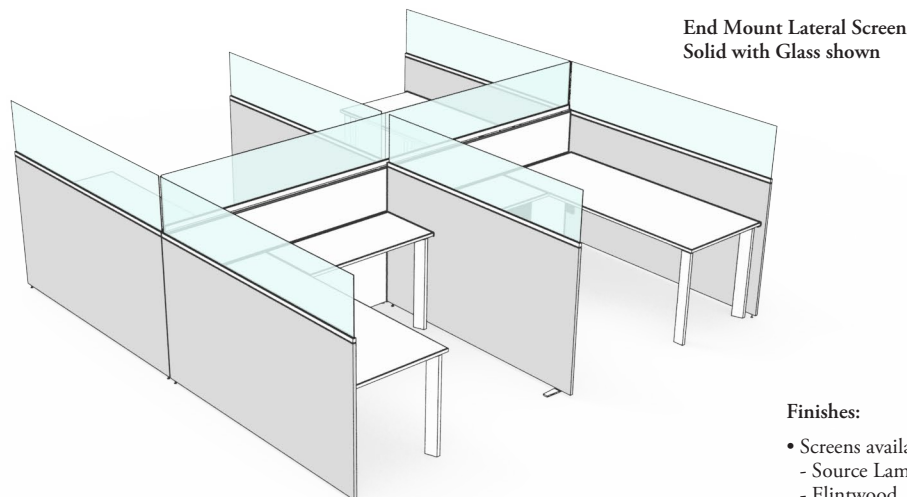

- Available solid or with glass at top
- Depths: 24", 30", 36", 42", 48", 60" and 72" (sizing are nominal, actual sizes vary by condition)
- Bracket Attachment:
 - End Mounted Single
 - End Mounted Double
 - End Mounted Shared
- Screen Support:
 - None
 - Foot
 - Worksurface Connection
 - lateral screens are not worksurface supporting
 - they can attach to a worksurface as an option to have a foot on the screen but worksurfaces must be properly supported as outlined in *Worksurface Supports* section

- Handedness:
 - Left
 - Right
 - Not Applicable
- The handedness is determined by the location of the screen in relation to the bracket when viewed from the users perspective

Finishes:

- Screens available
 - Source Laminate
 - Flintwood
 - Natural Veneer
- Hardware available
 - Foundation
 - Mica
 - Accent
- Glass available
 - Clear
 - Frost

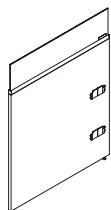

End Mount Lateral Screen Solid with Glass (UNLTG)

- Heights:
 - 31" Solid with 11" Glass to provide a 42" h datum
 - 44" Solid with 7" Glass to provide a 51" h datum
 - 31" Solid with 20" Glass to provide a 51" datum
 - 29" Solid with 13" Glass to provide Inset 42" h datum
 - 42" Solid with 9" Glass to provide Inset 51" h datum
 - 29" Solid with 22" Glass to provide Inset 51" h datum
 - 44" Solid with 13" Glass to provide 57" h datum
 - 42" Solid with 15" Glass to provide Inset 57" datum

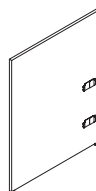

End Mount Lateral Screen Solid (UNLTS)

- Heights:
 - 42" high datum
 - 51" high datum
 - 57" high datum

planning with end mount lateral screens

End Mount Lateral Floor Screens are available in the following heights to provide various levels of privacy.

Solid

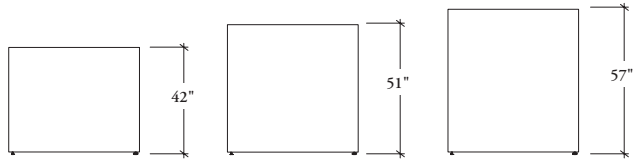

Solid with Glass

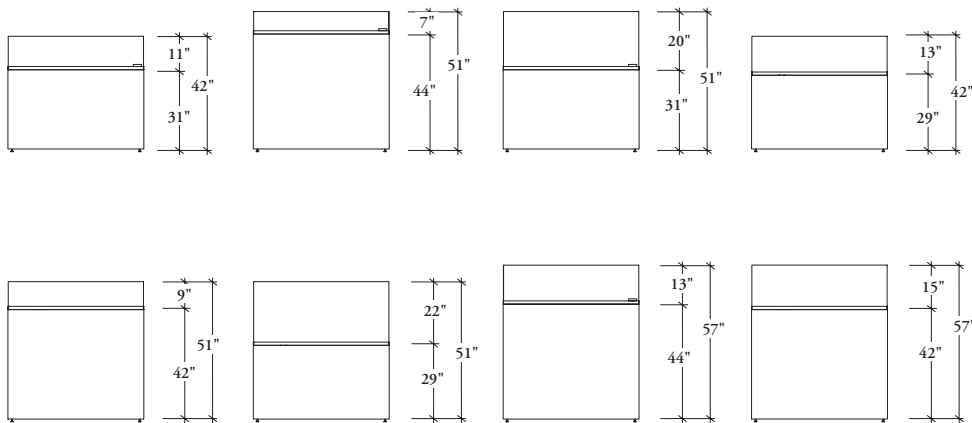

End Mount Lateral Screens can be used with or without a support foot.

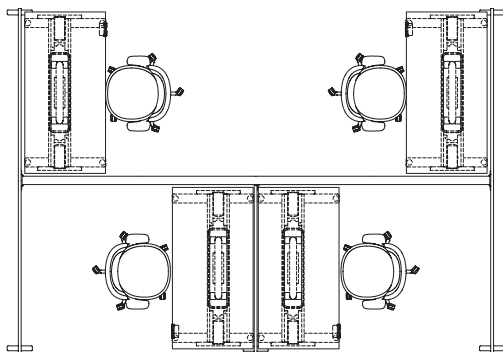

The support foot is required when
 - the screen is 48" wide or wider and not attached to a worksurface

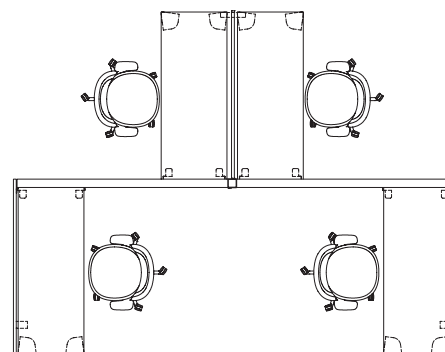

The support foot is not required when
 - the screen is attached to a fixed worksurface
 - the screen is 42" wide or less

planning with end mount lateral screens (continued)

Screens can be used in the following locations

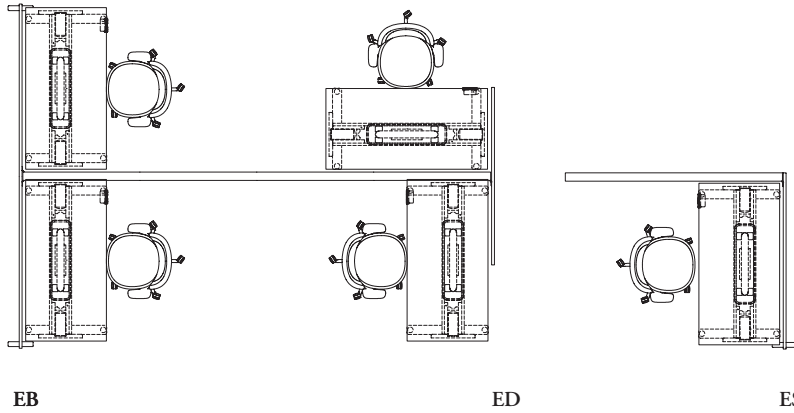

EB – End Mounted Double

- used on the outside of a workstation
- extends half way across the end of a panel run
- actual size = nominal size + 1-1/2"

ES - End Mounted Single

- used on the outside of a single workstation
- extends completely across the end of a panel run
- actual size = nominal size + 3"

ED – End Mounted Share

- shared on the outside of two workstations
- mounts centered to the end of a panel run
- actual size = nominal size + 1-1/2"

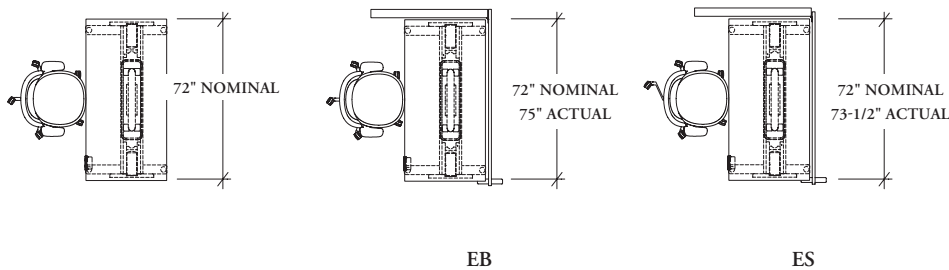

Regardless of the type of End Mount Lateral Screen used, the nominal dimension from the panel wall remains the same, allowing for a consistent footprint on all workstations.

planning with end mount lateral screens (continued)

End Mount Lateral Screens can provide panel support in place of return panels with the following restrictions:

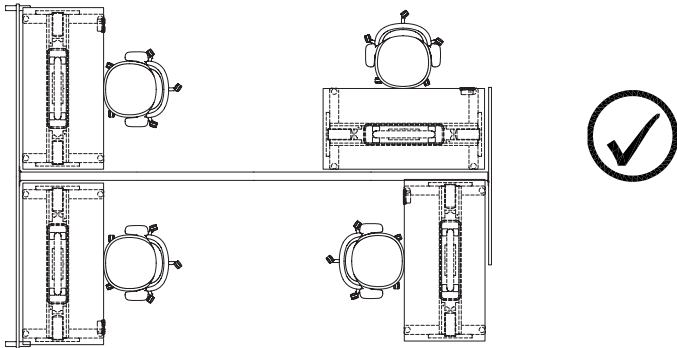

- The maximum number of panel sections is four and the overall length does not exceed 192" (ex. 4 x 48" sections = 192")
- The maximum number of panels sections is three when 60"w. panels are used and the overall length does not exceed 180" (ex. 3 x 60" sections - 180")
- Panel heights do not exceed 51" h.
- District panels over 60" w are made up of two segments so a 96" wide panel is considered 2 - 48" wide segments

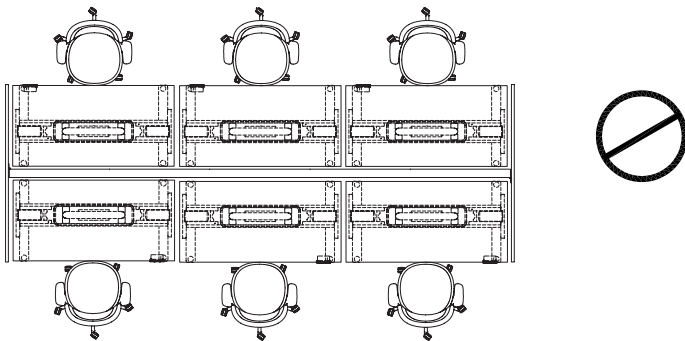

End Mount Lateral Floor Screens will not support a span of five or more segments, regardless of the width of each segment even if the overall length is less than 192".

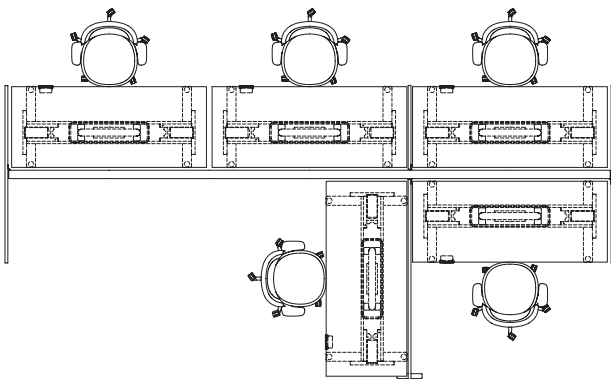

This example demonstrates how additional End Mount Lateral Screens can provide the panel support required.
example: double end screens and mid run screens

- there are no unsupported runs of more than four segments and the run does not exceed 192" without an additional screen

panel wall add-on screen basics

The Panel Wall Add-On Screen provides a casual option for finishing the top level of panel walls.

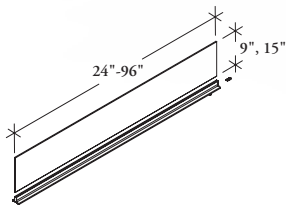
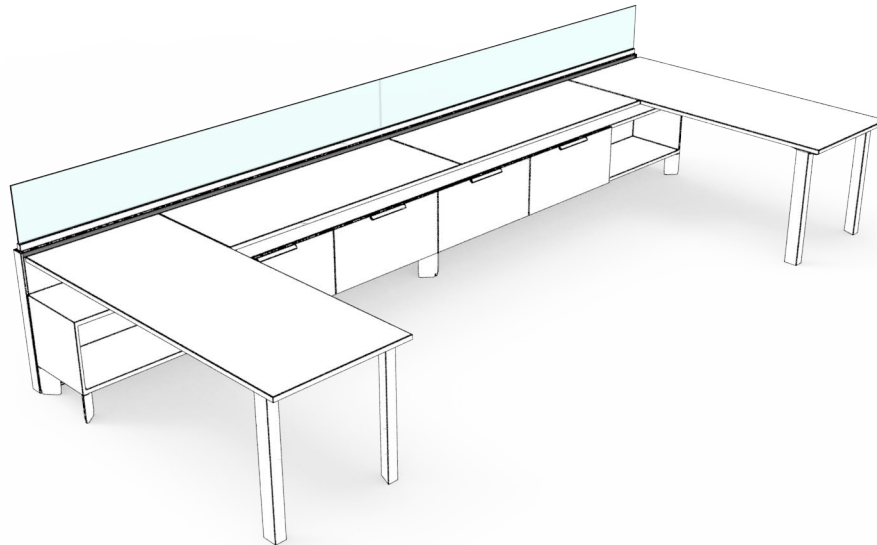

Panel Wall Add-On Screen – Solid (UNSPS)

- Provides a light frameless alternative to a solid fascia at the top of a panel
- Available in solid finish
- Can be mounted on- or off-module, or span two panel walls but **cannot** span a 180° spacer or 90° connection
- Replaces the top trim of the same width on the panel wall
- The support frame is visible above the Top Trim

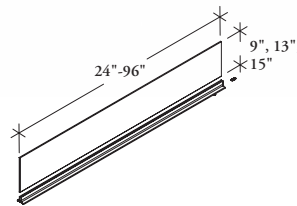

Panel Wall Add-On Screen – (UNSPG)

- Provides a light frameless alternative to a window at the top of a panel
- Glass is 10mm thick
- Can be mounted on- or off-module, or span two panel walls, cannot span a 180° spacer or 90° connection
- Replaces the top trim of the same width on the panel wall
- The support frame is visible above the Top Trim
- Available in heights of 9", 13" and 15"
- Available in widths of 24" to 96" in 6" increments
- Available in clear and specialty glass finishes

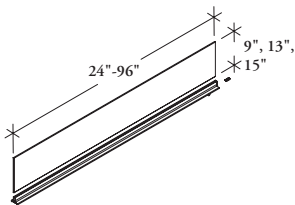

Panel Wall Add-On Screen – 6mm Glass (UNSPF)

- Provides casual space division and privacy with a slim frame less add-on screen at the top of panel
- Glass is 6mm thick
- Can be mounted on- or off-module, or span two panel walls, cannot span a 180° spacer or 90° connection
- Available in heights of 9", 13" and 15"
- Available in widths of 24" to 96" in 6" increments
- Available in clear and frosted glass finishes

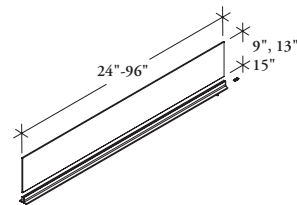

Smooth Felt Add-On (UNSPZ)

- Provides casual space division and privacy with a slim frame less add-on screen at the top of panel
- Smooth Felt Screen
- Can be mounted on- or off-module, or span two panel walls, cannot span a 180° spacer or 90° connection
- Available in heights of 9", 13" and 15"
- Available in widths of 24" to 96" in 6" increments
- Available in Strata (R4), Pewter (R5), Lunar (R6), Warm Ash (QZ)

planning with wall panel add-on screens

The following should be considered when planning with add-on screens.

on- and off-modular

- Add-on screens can be mounted on- or off-module, or span across two panels
- The base of the add-on screen mounts to the top of the panel frame, eliminating the need for a Top Trim in that location

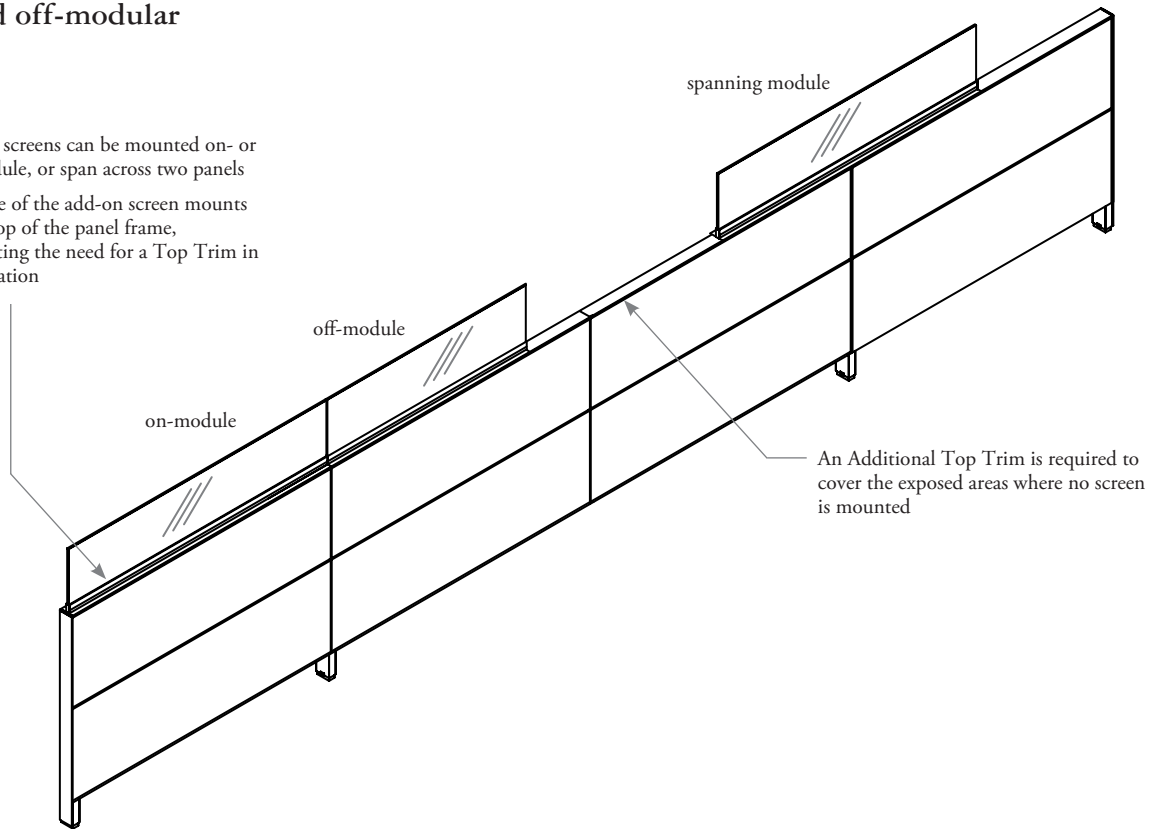

add-on screen end caps

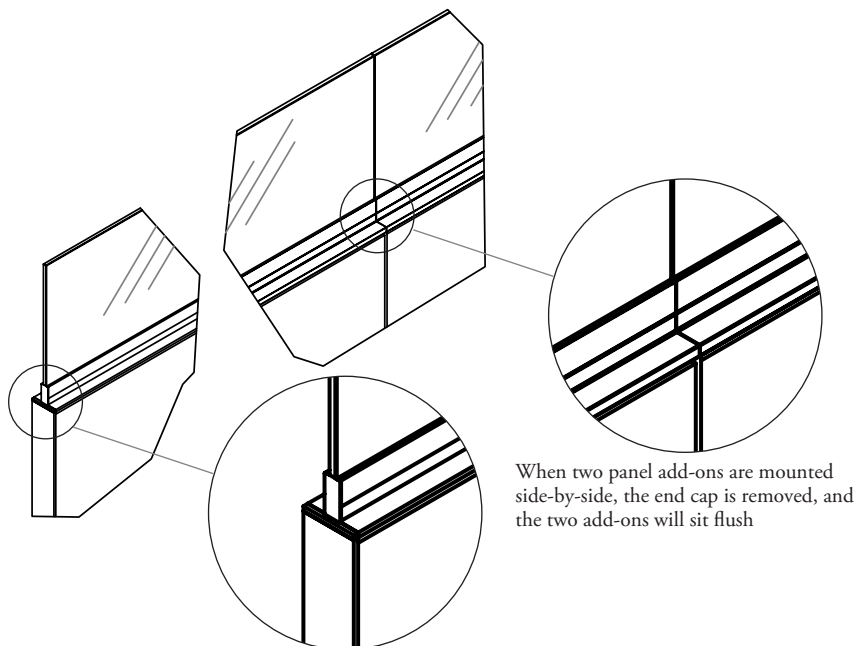

When two panel add-ons are mounted side-by-side, the end cap is removed, and the two add-ons will sit flush

Screens are complete with end caps to finish the trim, and sit beyond the add-on screen and over the end trim to create a finished end condition

planning with wall panel add-on screens (continued)

change of height conditions

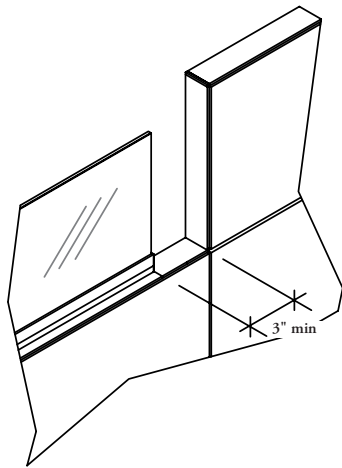

- When mounting panel add-on screens in change-of-height panel configurations, the add-on must start a minimum of 3" from the edge of the panel to allow for the Intermediate Trim thickness and a Top Trim must be ordered to fill the remaining width
- Top trim widths required below 24" are cut to size on site. The cut end should be applied against the adjoining panel, as the intermediate end trim will conceal the cut edge

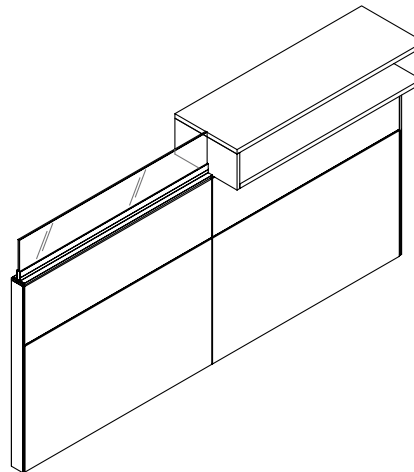

- When the change of height is due only to center-mounted storage and **not** a panel height change, the panel add-on can span the width of the frame it is mounted to

spanning connectors

An add-on screen **cannot** span over a 180° or 90° connection

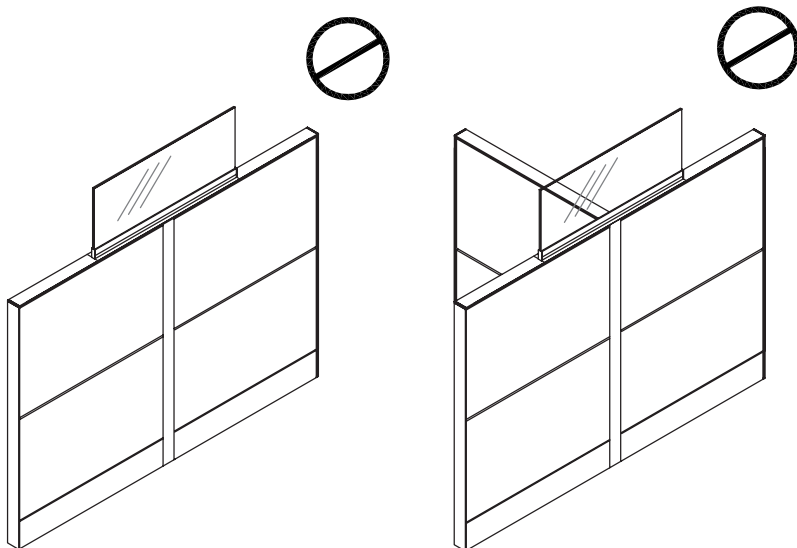

glass blades for panels with inset glass basics

The Glass Blade for Panels with Inset Glass provides a casual option for finishing the top level of panel walls. The Glass Blade recesses into the panel frame so less trim is visible.

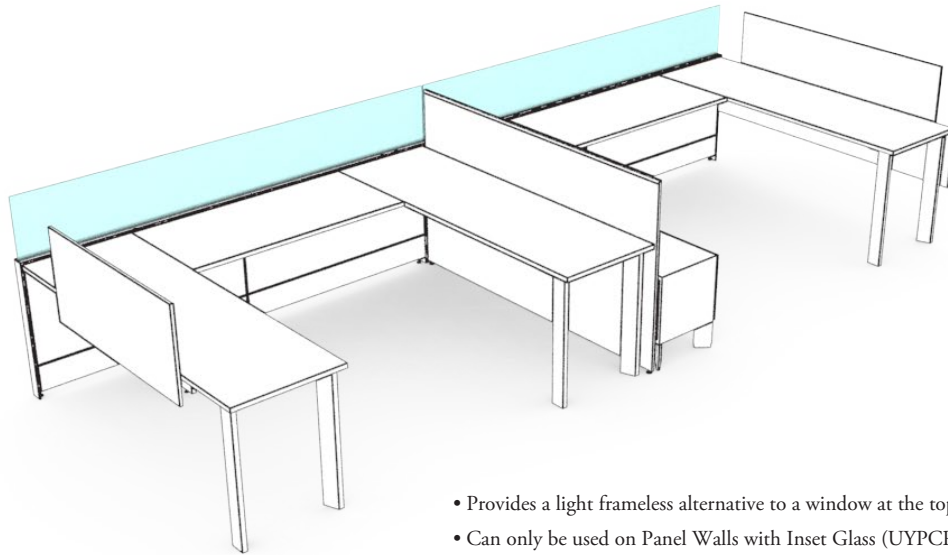

- Ten applications are available:
 - Both Standard
 - One Side Corner
 - One Side Notch
 - One Side Extended
 - Both Side Corner
 - Both Side Notch
 - Both Side Extended
 - Extended and Notch
 - Corner and Notch
 - Corner and Extended

- Provides a light frameless alternative to a window at the top of a panel
- Can only be used on Panel Walls with Inset Glass (UYPCR, UYPER and UYPER)
- Available with Standard Clear and Specialty Frost, white or Cool White Glass
- Can be mounted on- or off-module or span two panel walls

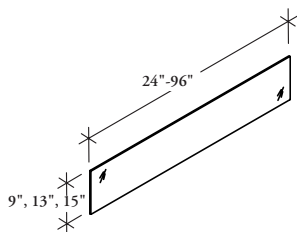

Panel Glass Blade for Panels with Inset Glass (UYSPG)

- Provides a glass blade inset into a panel frame without any exposed top trim
- Glass is 10mm thick
- Top trim must be specified separately, Panel Top Trim for Panels with Inset Glass (UYTT)

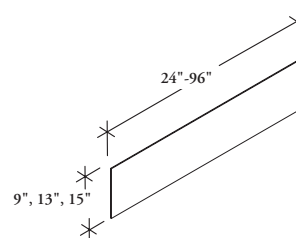

Panel Glass Blade for Panels with 6mm Inset Glass (UYSPF)

- Provides a 6mm thick glass blade inset into a panel frame without any exposed top trim
- Top trim must be specified separately, Panel Top Trim for Panels with Inset Glass (UYTT)
- Screen finishes includes clear glass and frost glass

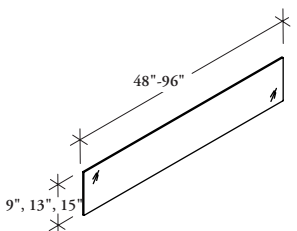

Bridged Glass Blade for Panels with Inset Glass (UYSCG)

- Provides an inset glass blade that spans over two panels being connected by a three-way connector
- Glass is 10mm thick
- Top trim must be specified separately, Bridged Top Trim for Panels with Inset Glass (UYCT)
- Widths are nominal and account for the 3" width of the three-way connector

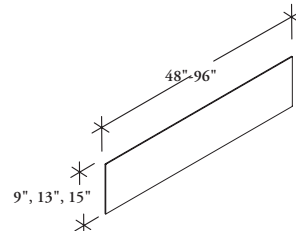

Bridged Glass Blade for Panels with 6mm Inset Glass (UYSCF)

- Provides a 6mm thick inset glass blade that spans over two panels being connected by a three-way connector
- Top trim must be specified separately, Bridged Top Trim for Panels with Inset Glass (UYCT)
- Screen finishes includes clear glass and frost glass
- Widths are nominal and account for the 3" width of the three way connectors

planning with glass blades for panels with inset glass

The following should be considered when planning with Glass Blade for Panels with Inset Glass.

panel glass blade

- Can be on- or off-module and can span across two panels
- The base of the Inset Glass must be embedded into a Panel Wall with Inset Glass (UYPCR, UYPER and UYPFR) and must be used with the Panel Top Trim for Panels with Inset Glass (UYTT)

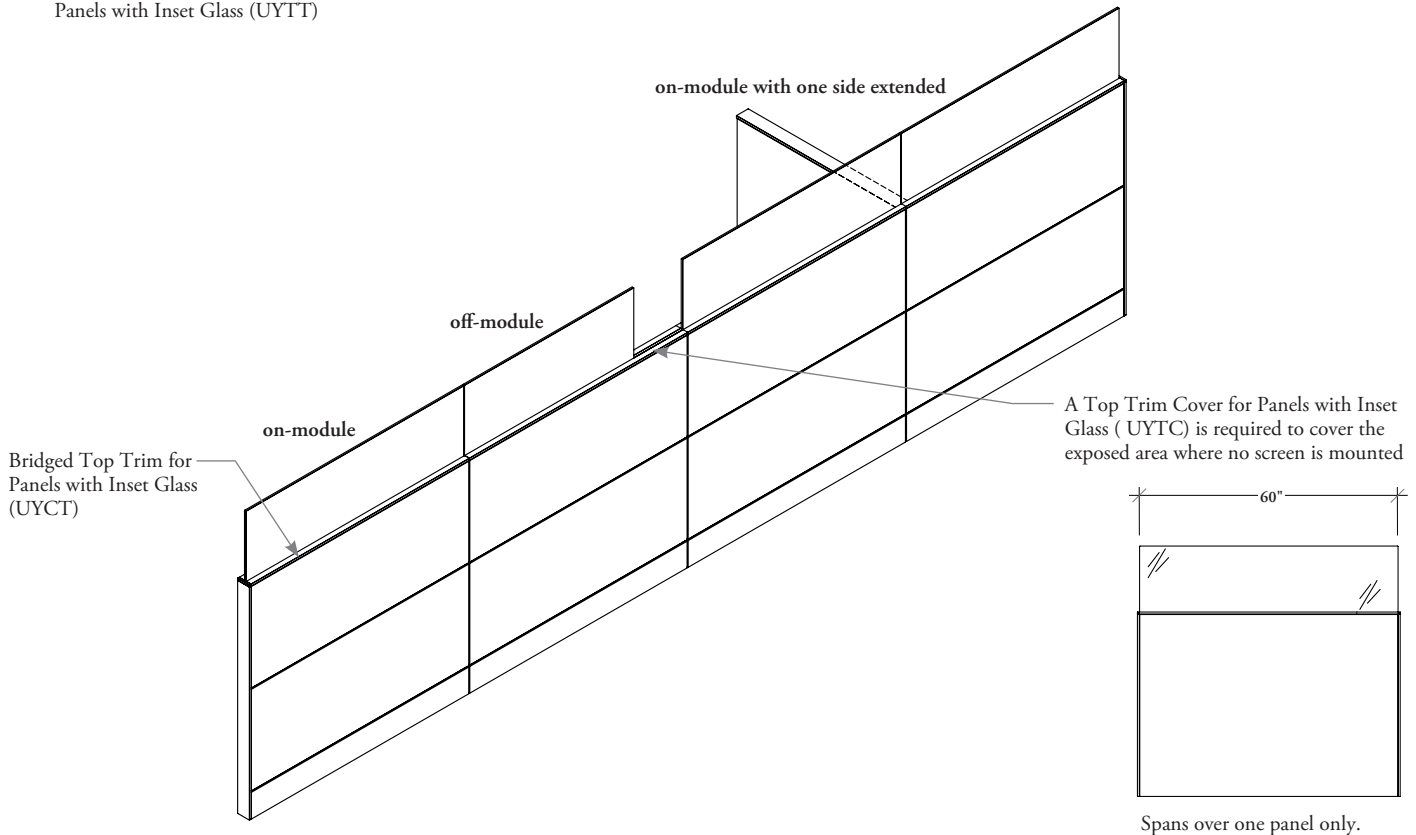

bridged glass blade

- Bridged Glass Blade for Panels with Inset Glass spans across two panels connected by a three-way connector, and can be mounted on- or -off module
- The base of the inset glass must be embedded into a Panel Wall with Inset Glass (UYPCR, UYPER and UYPFR) and must be used with Bridged Top Trim for Panels with Inset Glass (UYCT)
- When planning off-module it is recommended that the exposed top trim be covered by Bridged Top Trim for Panels with Inset Glass (UYCT)

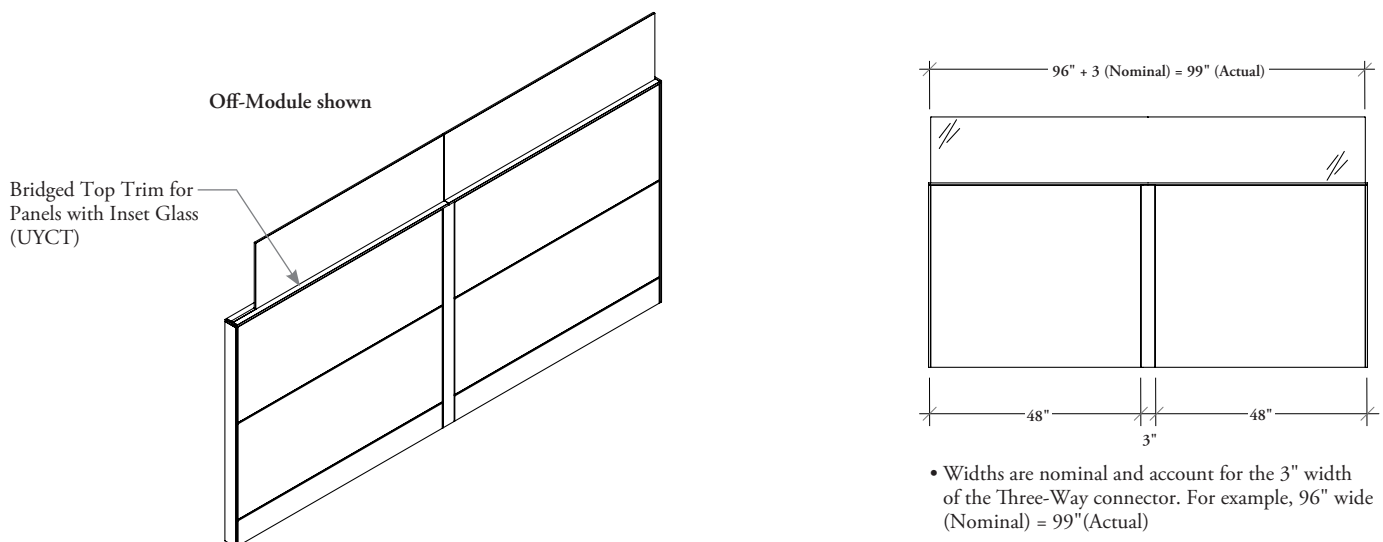

planning with glass blades for panels with inset glass (continued)

There are ten application available when planning with Glass Blades for Panels with Inset Glass:

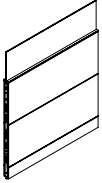

Both Standard (S)

Used when beside other panels with Inset Glass Blade and no extension is required on when the panel beside it has no glass blade.

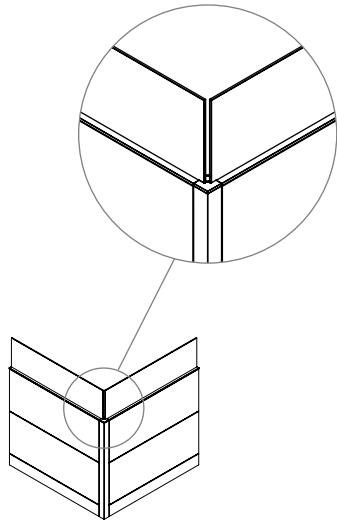

One Side Corner (G)

Used on a corner to reduce the gap between glass blades. Must be used with Two-Way 90° Corner Gap for Panels with Inset Glass (UYPC2).

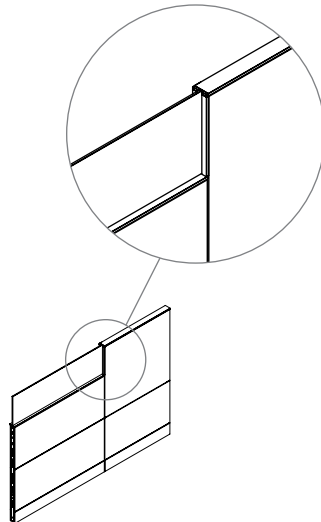

One Side Notch (K)

Used when planned against an Intermediate End Trim.

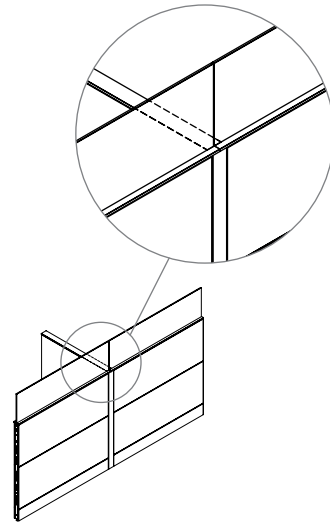

One Side Extended (E)

Extends 1 1/2" over a Three-Way Connector. Must be used with a second Glass Blade with Side Extended to cover the full Three-Way connector. The cap on Three-Way connector is removed to have both glass blades extend over it.

planning with glass blades for panels with inset glass (continued)

The following should be considered when planning with add-on screens.

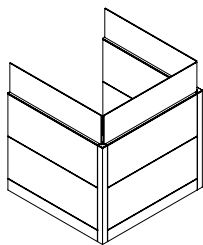

Both Side Corner (C)

Used when both ends are on a corner to reduce the gap between glass blades. Must be used with Two-Way 90° Corner Gap for Panels with Inset Glass (UYPC2).

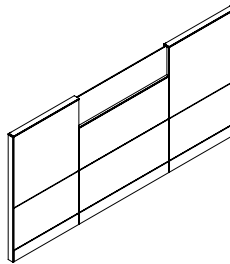

Both Side Notch (N)

Used when planned between two Intermediate End Trims.

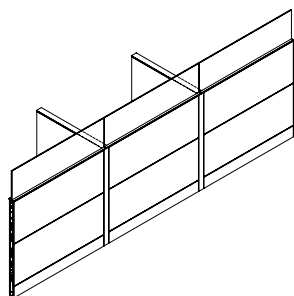

Both Side Extended (B)

Used to run 1 1/2" over a Three-Way Connector on either end. Must be used with a second Glass Blade with side Extended to cover full the Three-Way connector on each side.

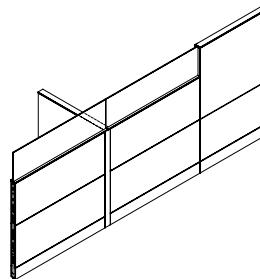

Extended and Notch (F)

Used to extend 1 1/2" over a Three-Way Connector on one end and against an Intermediate End Trim on the other. The Top cap on the Three-Way connector is removed to have both glass blades extend over it.

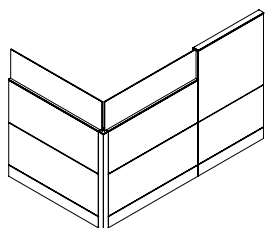

Corner and Notch (H)

Used when one end is on a corner to reduce the gap between glass blades and the other end is against an Intermediate End Trim. Must be used with Two-Way 90° Corner Gap for Panels with Inset Glass (UYPC2).

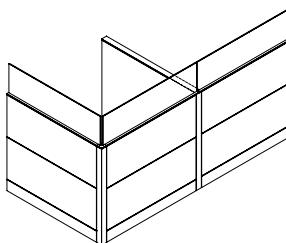

Corner and Extended (D)

Used when one end is on a corner to reduce the gap between glass blades and the other end extended 1 1/2" over a Three-Way Connector. Must be used with a second Glass Blade with side Extended to cover the full Three-Way connector. The Top cap on the Three-Way Connector is removed to have both glass blades extend over it. Must be used with Two-Way 90° Corner Gap for Panels with Inset Glass (UYPC2).

connections & trim

connections & trims

UNDERSTANDING TRIMS & CONNECTORS	156
TOP TRIM BASICS	157
END TRIM BASICS	158
CONNECTOR BASICS	159
CONNECTOR & TRIM CONFIGURATIONS	161
PLANNING WITH CONNECTORS & TRIMS	163

understanding trims & connectors

Trims and connectors are required to finish the tops, ends and corners of District Panel Walls and Add-On Windows.

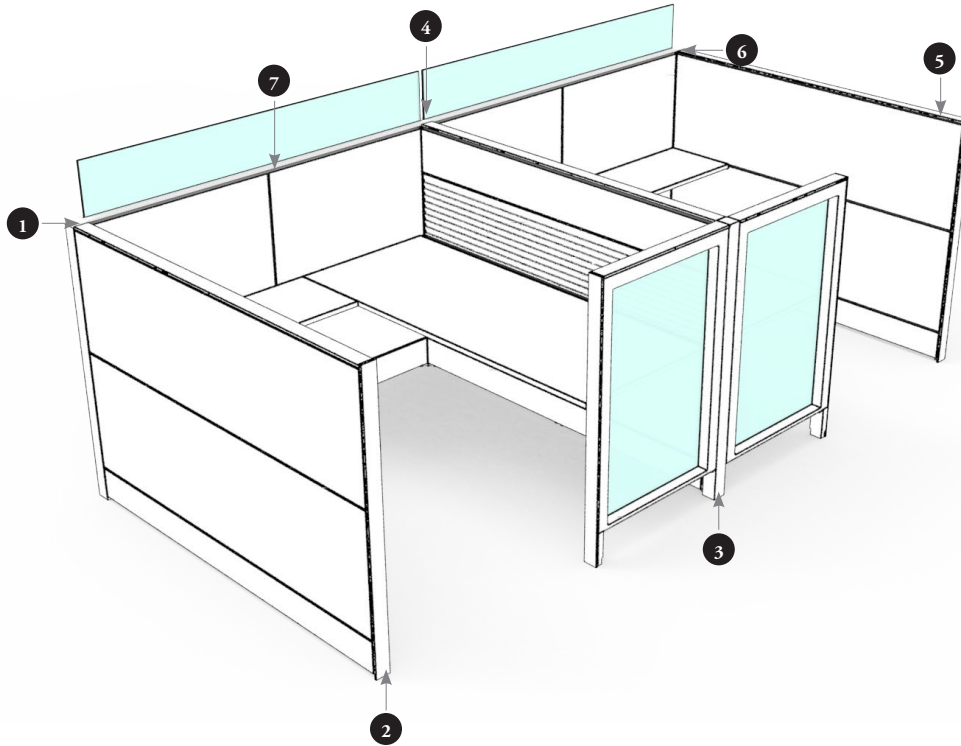

- 1 Corner connectors include brackets, trims and corner caps.
- 2 All trims are bolted to the panel wall for positive engagement and alignment.
- 3 Corner connectors are specified to match the panel type that they are being used with (ex. Flush/Convertible-to- Flush/Convertible, Elevated-to-Elevated, or Flush/Convertible-to-Elevated).
- 4 All panel wall connections are on-module.
- 5 Top trims are available up to 96" wide to span across all widths of panels including those made up of two sections.
- 6 Connectors are available for two-, three- and four-way connections as well as 180° connections.
- 7 Panel Top Trim for Panels with Inset Glass allows Panel Glass Blade for Panels with Inset Glass (UYSPG) to sit inset into a panel.

The following outlines the features of each of the top trims available in District.

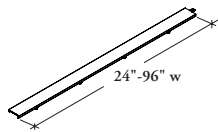
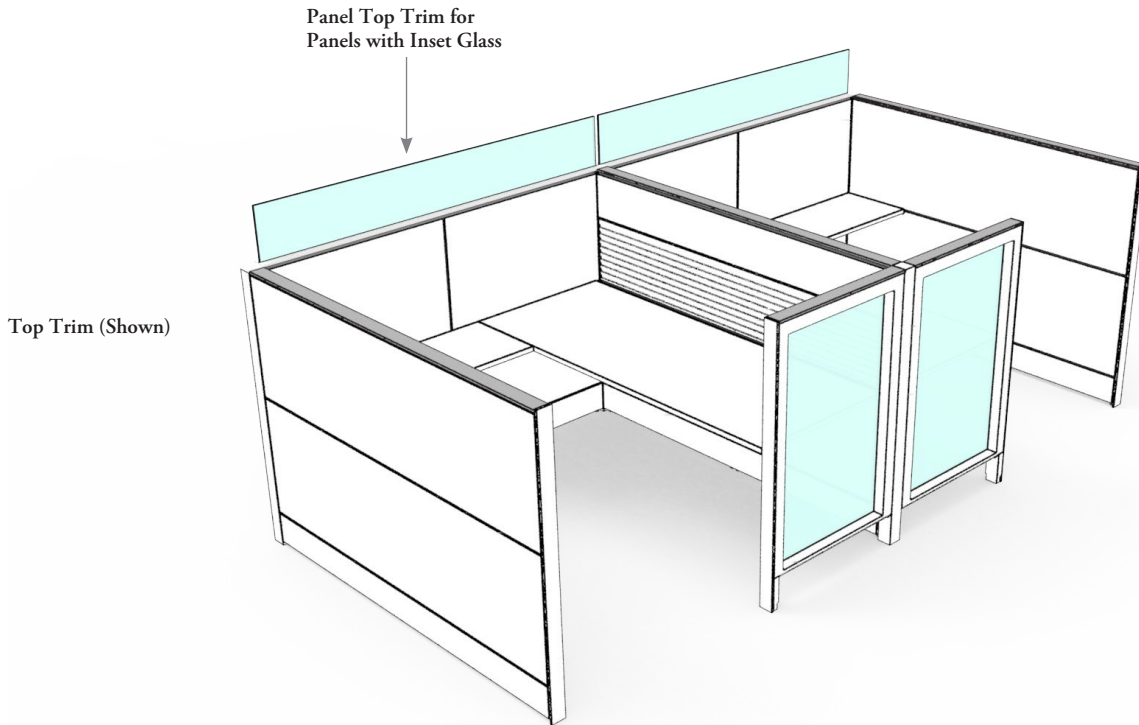

Top Trim (UNTT)

- A full width trim on the top of a panel wall or add-on window
- 7/16" thick

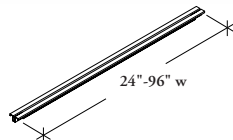

Panel Top Trim for Panels with Inset Glass for 6mm or 10mm (UYTT)

- Allows Panel Glass Blade for Panels with Inset Glass (UYSPG) to be inset into a panel wall
- Available in Both Extended, One Side Extended and Both Standard applications
- Must be used on Panel Wall with Inset Glass (UYPCR, UYPER and UYPPFR)
- Available in Foundation, Mica and Accent colors

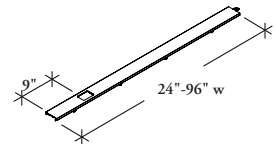

Top Trim – Power Pole Access (UNTTP)

- Same as the Top Trim except with a cut out to allow a Power Pole to be installed off-module 9" from a panel end
- Non-handed

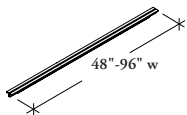

Bridged Top Trim for Panels with Inset Glass for 6mm or 10mm (UYCT)

- Allows Bridged Glass Blade for Panels with Inset Glass (UYSCG) to be inset into the panel wall while spanning over two panels attached by a three-way connector
- Optional brackets are available on one or both sides to connect to related end trim
- Available in Both Extended, One Side Extended and Both Standard applications
- Widths are nominal and account for the 3" width of the three-way connector
- Available in Foundation, Mica and Accent colors
- Non-handed

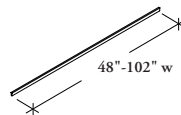

Top Trim Cover for 6mm or 10mm (UYTC)

- Used to fill exposed sections on Panel Top Trim for Panels with Inset Glass (UYTT) or Bridged Top Trim for Panels with Inset Glass (UYCT)
- Cut on site

end trim basics

The following outlines the features of each of the end trims available in District.

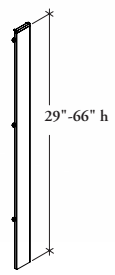
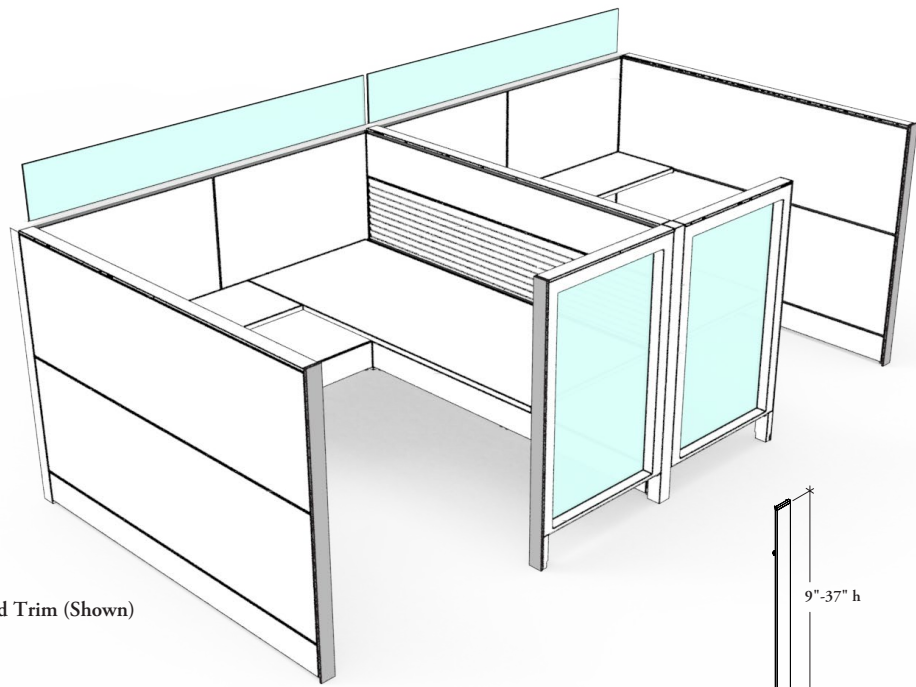

End Trim (Shown)

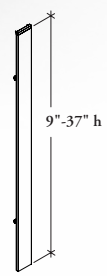

Intermediate End Trim (UNTM)

- Conceals an exposed portion of a panel wall, add-on window or full-height window in a change-of-height location

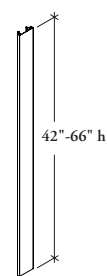

Transition Cover (UNTC)

- Used to provide a seamless vertical trim cover when an intermediate panel connection occurs above a full panel connection

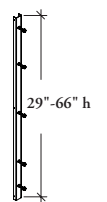

Wall Start (UNPCW)

- Used to connect either elevated or standard Panel Walls (no corners) to reinforced drywall
- Foot is specified separately for elevated Panel Walls at the wall start connector point

End Trim (UNTE)

- A full-height trim that conceals the end of a panel wall
- Heights matches the heights of Flush and Elevated Panel Walls and Convertible Walls
- Required to cover the full height of a panel wall, including add-on window and full-height window, if applicable
- Can be used on panel walls with or without Accessory Beam

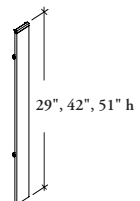

End Trim for Freestanding District (UATE)

- Used in freestanding applications to accommodate the support foot gaps
- Available in Mica and Foundation finishes
- Can be used on panel walls with or without Accessory Beam

The following outlines the features of each of the connectors available in District.

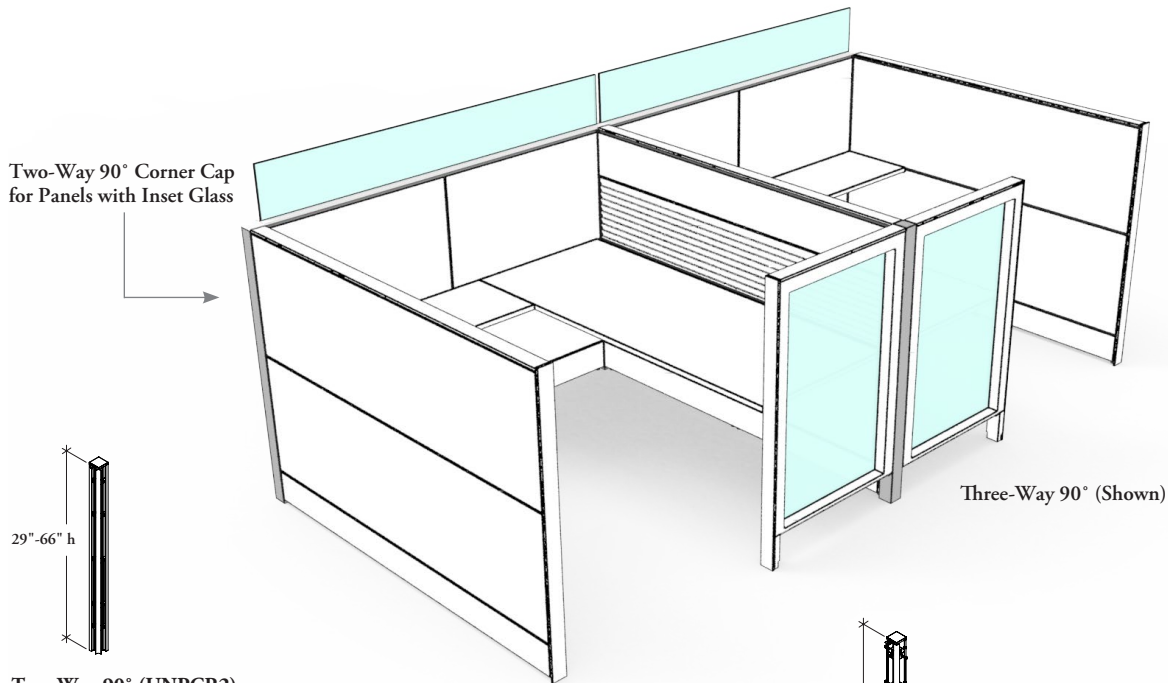

Two-Way 90° Corner Cap for Panels with Inset Glass

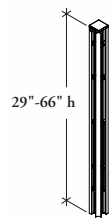

Two-Way 90° (UNPCR2)

- Connection is used to connect two panel walls and windows at 90° in same panel height or varying panel height configurations
- For change of heights, the connector is specified for the lowest height panel
- Available with options for connecting Flush, Elevated or Convertible Panel Walls

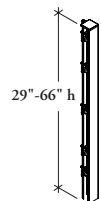

Three-Way 90° (UNPCR3)

- Connection is used to connect three panel walls at 90° in same panel wall height or varying panel wall height configurations
- Used for change of heights, the connector is specified for the lowest height panel wall
- Available in two configurations:
 - (1) one vertical cover and top cap which completely finishes the

connection when no Intermediate 180° Connector (UNIC3) will be used above it

- (0) no vertical cover or top cap is used for change-of-height connections when an Intermediate 180° Connector (UNIC3) is used above it, a separate Transition Cover (UNTC) must be ordered

- Available with options for connecting Flush, Elevated or Convertible Panel Walls



Two-Way 90° Corner Cap for Panels with Inset Glass for 6mm or 10mm (UYPC2)

- Used with Two-Way 90° (UNPCR2) and replaces the cap on existing connector to accommodate Panel Top Trim for Panels with Inset Glass (UYTT) and Panel Glass Blade for Panels with Inset Glass (UYSPG) in a corner application
- Available in Clear Anodized, Foundation and Mica

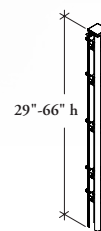

Three-Way 90° (Shown)

Four-Way 90° (UNPCR4)

- Connection is used to connect four panel walls and full-height windows at 90° in same panel height or varying panel height configurations
- Used for change of heights, the connector is specified for the lowest height panel wall
- Available with options for connecting Flush, Elevated or Convertible Panel Walls

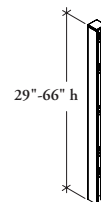

Two-Way 180° Spacer (UNPCCR)

- Connection is used when a spacer is required between two panel walls, full-height windows or add-on windows joined at 180° to match either panel wall lengths or to provide a needed space for screens etc.
- Used for change of heights, the connector is specified for the lowest height panel wall
- Available with options for connecting Flush, Elevated or Convertible Panel Walls
- In most layouts no spacer is needed, panel walls are bolted together with 0" gap

connector basics (continued)

The following outlines the features of each of the connectors available in District.

Two-Way Intermediate (Shown)

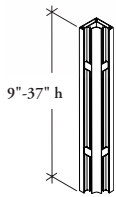
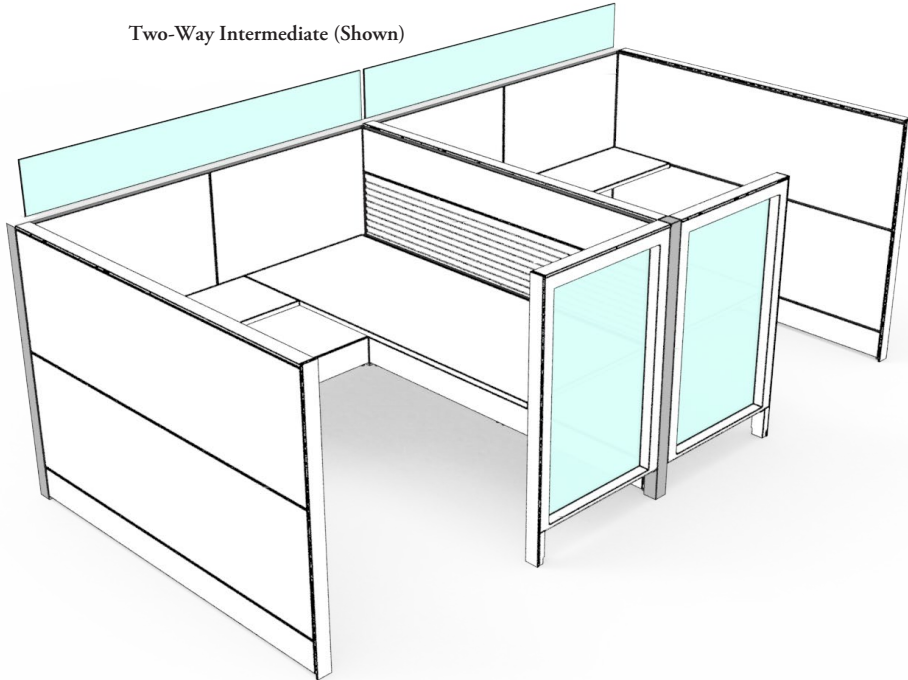

Two-Way Intermediate 90° (UNIC2)

- Connection is used to fill the exposed ends of panel walls above a three-way or four-way connection in a change-of-height configuration

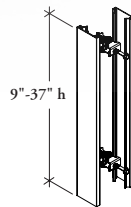

Two-Way Intermediate 180° (UNIC4)

- Connections is used to fill the exposed ends of panel walls or add-on windows above a 180° spacer in change-of-height configurations
- Available in two configurations;
 - (2) two vertical covers (completely finishes both sides with equal length trim covers)
 - (1) one vertical cover only (select when a two-way Intermediate 180° connection is above a three-way 90° connection a Transition Cover (UNTC) is ordered separately to cover the open side)

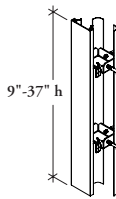

Three-Way Intermediate 90° (UNIC3)

- Connection is used to fill the exposed ends of panel walls or add-on windows above a four-way connector in change of height configurations



Four-Way Intermediate 90° (UNIC4)

- Connection is used to fill the gap created when four add-on windows are added above an existing four-way connection

connector & trim configurations

A minimal number of connector types are required to make a large number of connections possible in District.

two-way

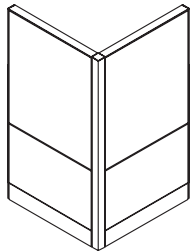

Two-Way 90° Connector (UNPCR2)

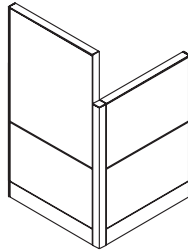

Two-Way 90° Connector (UNPCR2)
Intermediate End Trim (UNTM)

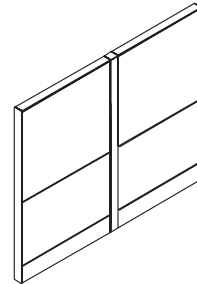

Two-Way 180° Spacer (UNPCCR)

three-way

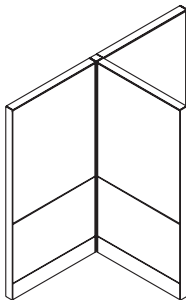

Three-Way 90° Connector (UNPCR3)

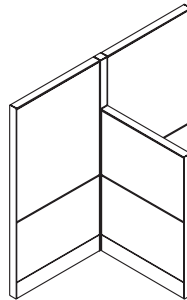

Three-Way 90° Connector (UNPCR3)
(no vertical trim option)

Two-Way Intermediate 180° Spacer
(UNICC) (one vertical trim only
option)

Transition Cover (UNTC)

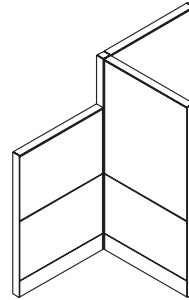

Three-Way 90° Connector (UNPCR3)
Two-Way 90° Intermediate (UNPC2)

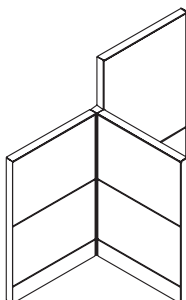

Three-Way 90° Connector (UNPCR3)
Intermediate End Trim (UNTM)

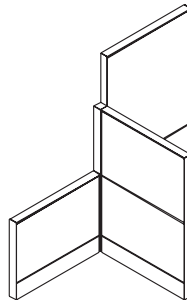

Three-Way 90° Connector (UNPCR3)
Two-Way 90° Connector (UNIC2)
Intermediate End Trim (UNTM)

connector & trim configurations (continued)

four-way

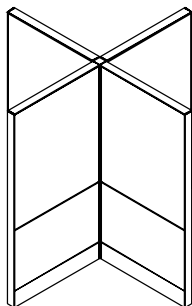

Four-Way 90° Connector (UNPCR4)

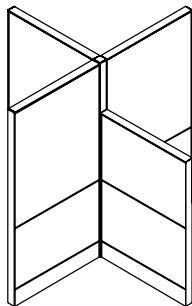

Four-Way 90° Connector (UNPCR4)
Three-Way Intermediate 90° (UNIC3)

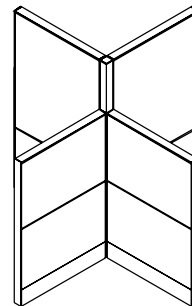

Four-Way 90° Connector (UNPCR4)
Two-Way Intermediate 90° (UNIC2)

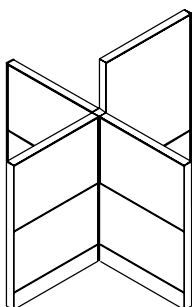

Four-Way 90° Connector (UNPCR4)
Intermediate End Trim (UNTM)

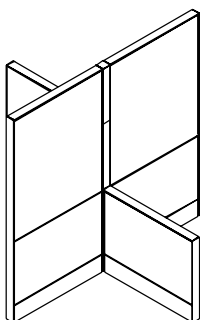

Four-Way 90° Connector (UNPCR4)
Three-Way Intermediate 90° (UNIC3)
Two-Way Intermediate 180° (UNICC)

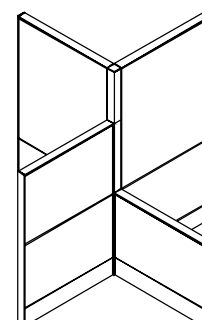

Four-Way 90° Connector (UNPCR4)
Three-Way Intermediate 90° (UNIC3)
Two-Way Intermediate 90° (UNIC2)

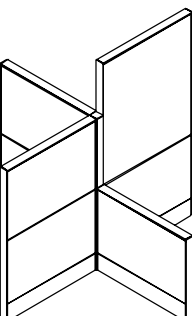

Four-Way 90° Connector (UNPCR4)
Three-Way Intermediate 90° (UNIC3)
Intermediate End Trim (UNTM)

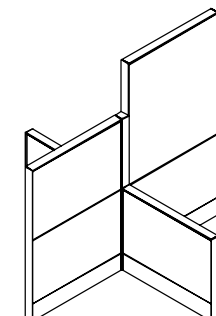

Four-Way 90° Connector (UNPCR4)
Two-Way Intermediate 180° (UNICC)
Intermediate End Trim (UNTM)

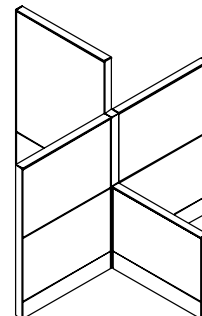

Four-Way 90° Connector (UNPCR4)
Three-Way Intermediate 90° (UNIC3)
Intermediate End Trim (UNTM)

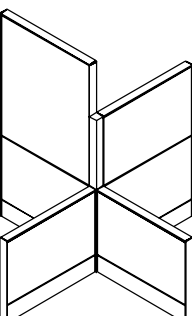

Four-Way 90° Connector (UNPCR4)
Two-Way Intermediate 90° (UNIC2)
Intermediate End Trim (UNTM)

planning with connectors & trims

The following should be considered when planning with District trims and connectors.

trims and connectors

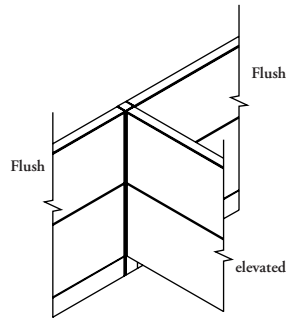

- The combination of panel types used must be indicated when specifying a corner connector because elevated connectors include the panel foot. In this example a UNPCR3EA is used which indicates two Flush panels or Convertible panels or one Elevated panel

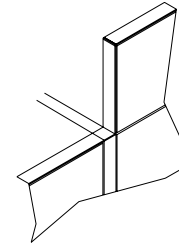

- In change of height applications, the connector is specified at the height of the lowest panel
- Intermediate Connectors and Intermediate Trims are used above that height to conceal all exposed ends

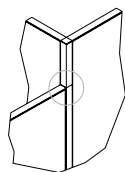

- When an L-shaped corner connector meets a straight corner connector, (ex. Three-Way 90° (UNCPRC3) with a Two-Way Intermediate 90° (UNIC2) above), a seam will be visible

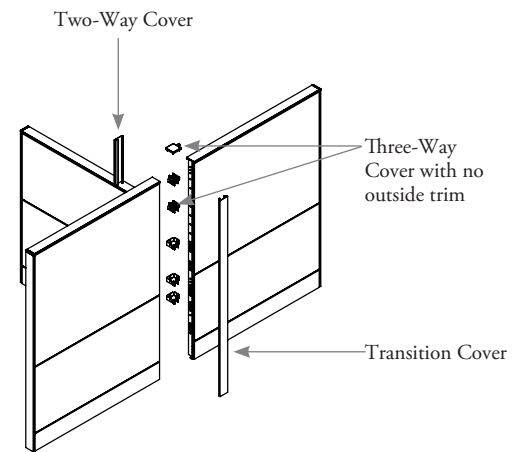

- When a Two-Way Intermediate 180° (UNICC) is mounted above a 90° Connector (ex. Three-Way 90° (UNPCR3)) the connectors should be specified **without** the outside trims. A Transition Cover (UNTC) is specified to extend the full height of the connection, eliminating the seam

planning with connectors & trims (continued)

panel top trim for panels with inset glass

- Panel Top Trims for Inset Glass are required when the inset glass blade is used
- When the Extended option is specified over a three-way connector the existing top cap is removed and the Panel Top Trim for Panels with Inset Glass is run over top to conceal the three-way connector and allow for glass blades to meet

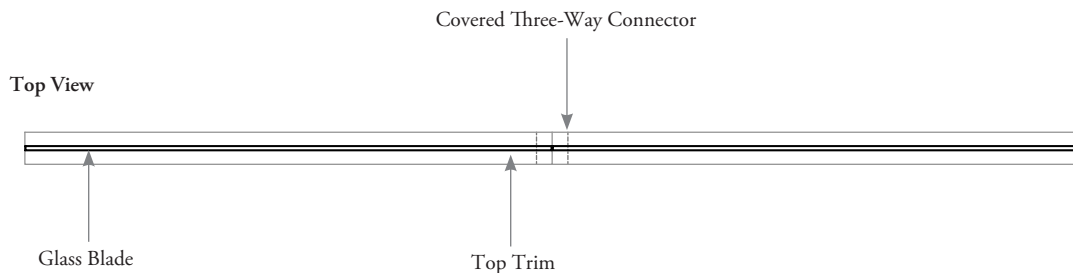

top trim cover

If an off-module application is specified, the Top Trim Cover must be specified to fill the exposed trim locations. The Top Trim Cover can be cut on site to ensure accuracy.

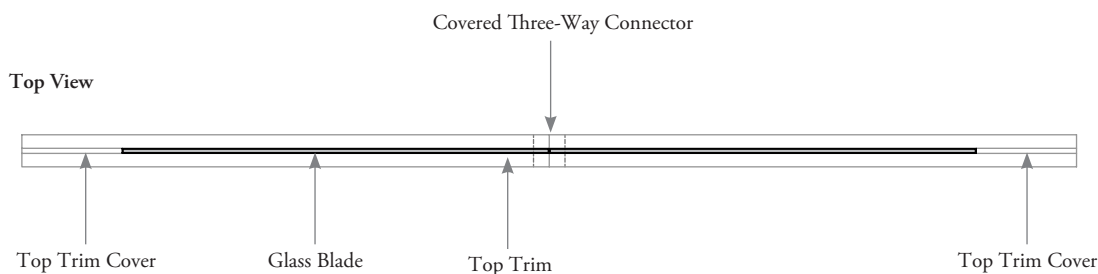

When Notched option is desired to accommodate an Intermediate End Trim the Panel Top Trim for Panels with Inset Glass must be specified as standard and only the Panel Glass Blade for Panels with Inset Glass will be specified Notched.

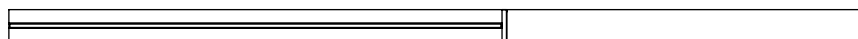

two-way 90° corner cap for panels with inset glass

When planning with Panel Glass Blade for Panels with Inset Glass (UYSPG) or Bridged Glass Blade for Panels with Inset Glass (UYSCG) on a corner application, a Two-Way 90° Corner Cap for Panels with Inset Glass must be specified to replace existing cap on two-way connector to allow inset glass to meet.

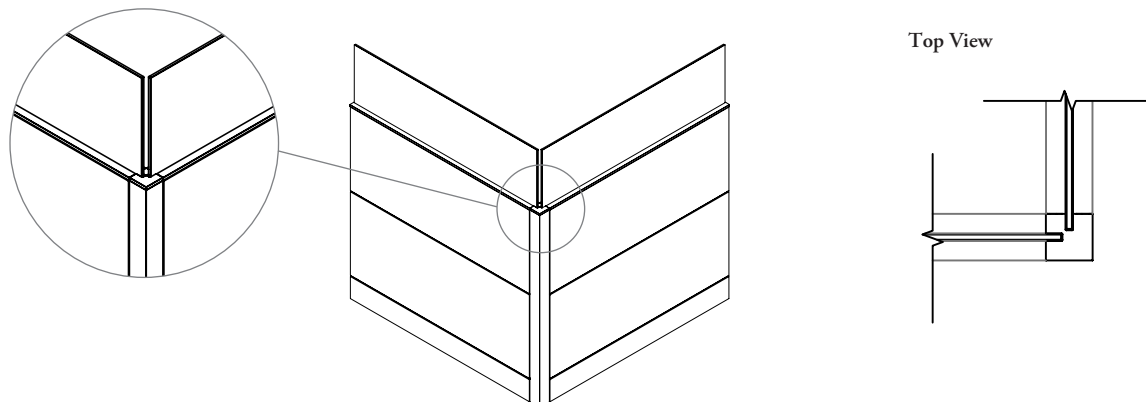

planning with connectors & trims (continued)

levelers

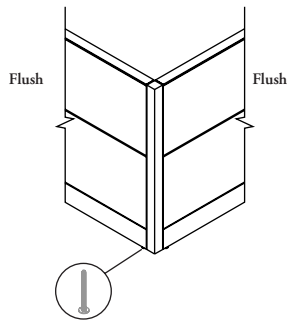

- When a flush corner connector is used the trim extends to the floor but the levelers may be visible

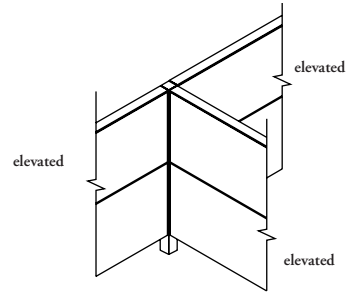

- When an elevated corner connector is used, the foot is visible but the levelers will be concealed
- The foot extends over the leveler

finish detail

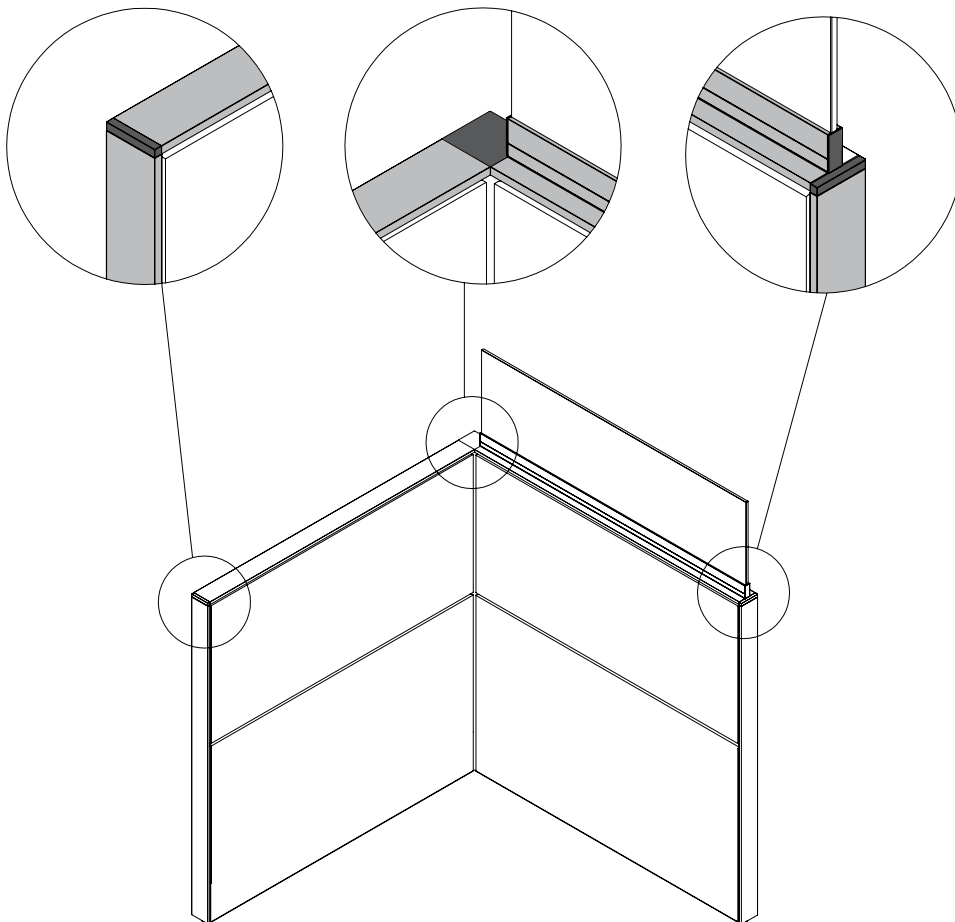

- When the Anodized Aluminum finish is specified on connectors and trims, there will be a visual difference between the top and end trims and the corner caps (Extruded Aluminum vs Cast Aluminum). If a consistent finish is required, it is recommended that Mica Paint be specified

worksurfaces

worksurfaces

UNDERSTANDING WORKSURFACES.	168
WORKSURFACE BASICS.	169
PLANNING WITH WORKSURFACES	170
PLANNING WITH WORKSURFACE GAPS	171
PLANNING WITH SMALL FOOTPRINT WORKSURFACES.	173
PLANNING WITH GROMMETS.	174
WORKSURFACE GRAIN/PATTERN DIRECTION	175
EDGE TRIM STYLE OVERVIEW	177

understanding worksurfaces

District provides a variety of worksurface shapes for primary and secondary worksurfaces. The following outlines the features of District worksurfaces.

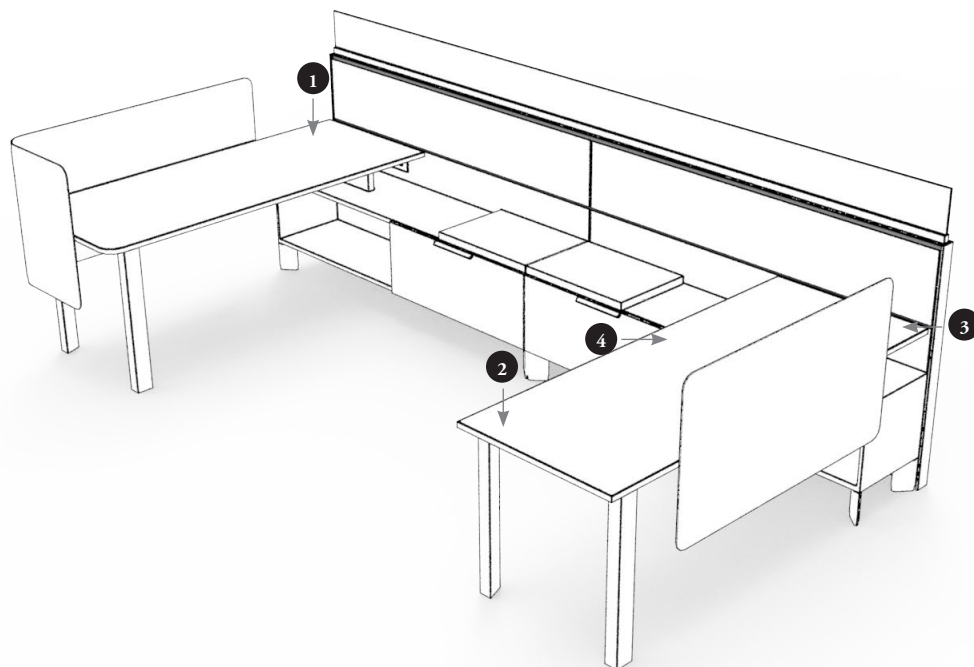

- 1 District surfaces are standard with a 1" gap on the back side for cable access
- 2 Worksurface widths are available in 1" increments to allow for an optional 1" gap on one or both sides of a worksurface and to match up with storage components (see *Storage* section)
- 3 Worksurfaces can be panel wall- or storage-mounted or specified with legs to create freestanding or semi-supported surfaces (see *Supports* section)
Worksurfaces can be mounted on- or off-module
- 4 The orientation of worksurfaces is determined by the location of the deepest end from the users perspective

The following worksurface shapes are available in District.

Worksurfaces **cannot** be mounted to 29" high Panel Walls with Inset Glass with the Panel Wall Bracket (UNBP). Please see Planning with Worksurface Support – Horizontal section for more details.

Nominal depth dimensions shown

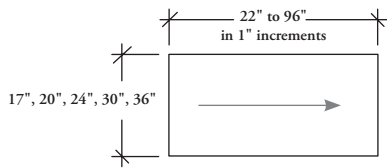

Rectangle Worksurface (UNWR)

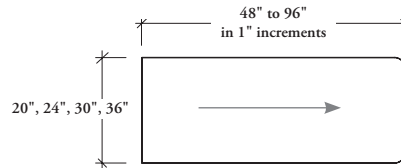

Rectangle with Radius Corners Worksurface (UNWC)

Finishes

- Worksurfaces are available in Foundation Laminate, Flintwood and Natural Veneer finishes
- Edge trims are available in Acrylic, ABS, Flintwood and Natural Veneer
- Acrylic is available with Foundation Laminate
- ABS is available with Foundation Laminate
- Flintwood edge trims are finished to match the Flintwood surface
- Natural Veneer edge trims are finished to match the Natural Veneer surface

planning with workspaces

The following should be considered when planning with District workspaces.

conventional vs. district

- District allows for the re-interpretation of conventional corner oriented workstations to maximize work flow

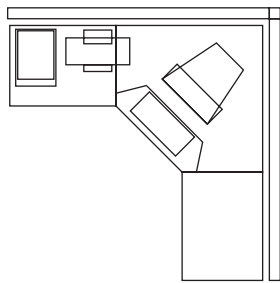

- **Conventional planning** typically uses a deep corner surface with keyboard tray and equal depth returns

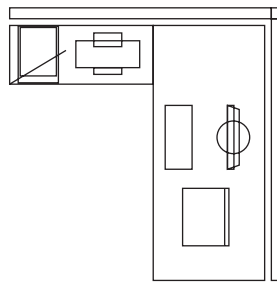

- **District planning** provides a deep primary workspace and shallow secondary surface for clear articulation of work-zones
- Worksurface shapes are optimized for rectangular and tapered configurations

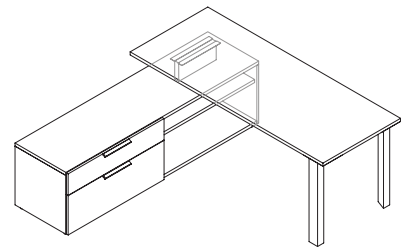

- **District planning** uses overlapping surfaces and volumes to allow more "stacking" and less filing surfaces

workspace edge profiles

- District workspaces are available with flat and full knife edge profiles

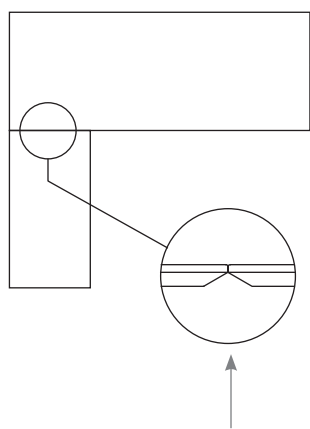

- All sides of the workspace have the same edge profile (both the user back and return edges of a full knife edge workspace have the full knife edge profile). This reduces the instances of a workspace becoming handed

- Workspaces are **not** offered with an eased edge so that gutters are **not** created when workspaces are butted up against each other
- The edge profile does **not** affect the placement of supports

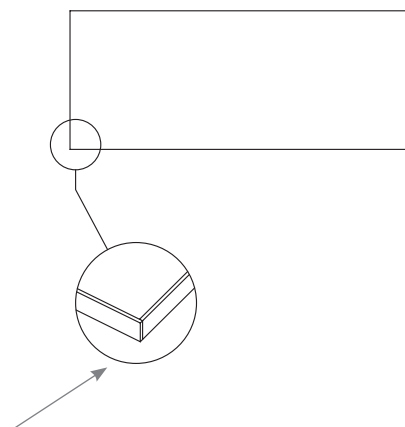

- Workspace outside corners are **not** radiused. Edge trims meet at 90° at the outside corners of a workspace

planning with worksurface gaps

The following should be considered when planning for gapping on worksurfaces.

worksurface depths

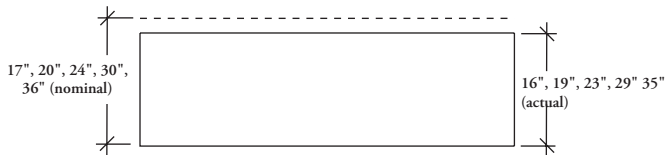

- All worksurfaces have **nominal** depths (the actual depth is 1" less than the nominal depth) to allow for a gap at the back
- The gap is **not** optional, it is the standard configuration
- The gap is for cable management, access to electrics and alignment with storage and panel walls (International electrics may require a grommet to be specified to accommodate larger sized plugs). Grommets available in center, left or right side

worksurface widths

District worksurfaces are available in 1" increment widths to allow for a continuous gap around all sides of a workstation bounded by panel walls.

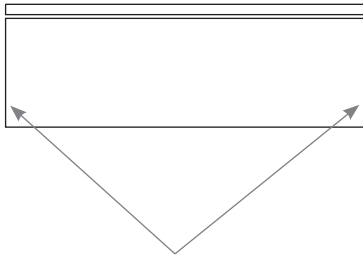

Worksurface is specified at same width as panel because no gap is required on either end

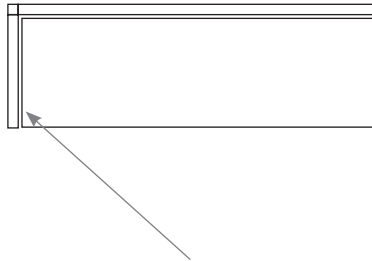

Worksurface is specified 1" less than width of panel to allow a gap on one side only

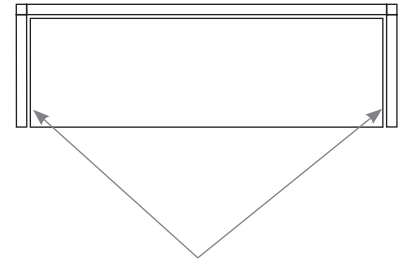

Worksurface is specified 2" less than the panel width to allow a gap on both sides

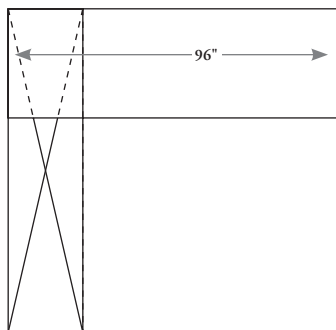

For freestanding applications, gapping is **not** an issue, so a full width worksurface should be specified.

planning with worksurface gaps (continued)

The following examples demonstrate a variety of typical gapping applications.

96" Panel Walls

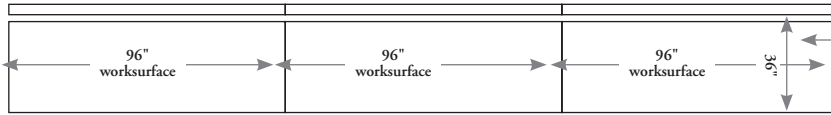

The depth is always nominal so the 36" depth is actually 35" with a 1" gap.

Full width worksurfaces are used because no return panel walls are used on the sides.

96" Panel Wall

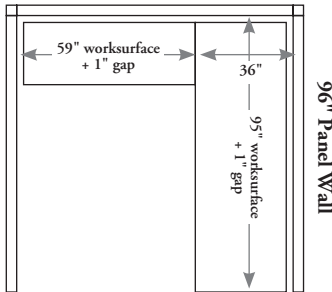

Both worksurfaces are 1" less than the width of the panel walls.

96" Panel Wall

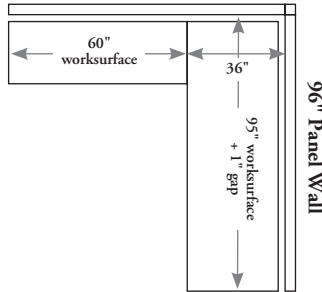

Only the primary surface is 1" less than the width of the panel wall, because there is no gap on the return surface.

96" Panel Wall

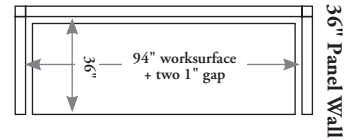

Worksurface is 2" less than the width of the panel wall to allow for a gap on either side.

96" Panel Wall

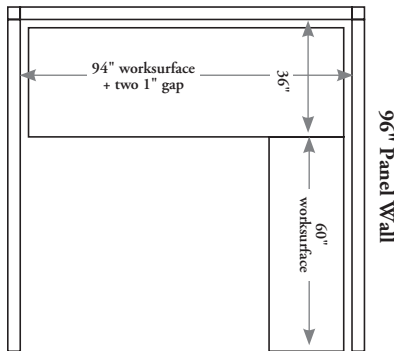

The primary worksurface is wrapped on both sides by panels so it is 2" less than the width of the panel, the return remains the full width.

96" Panel Wall

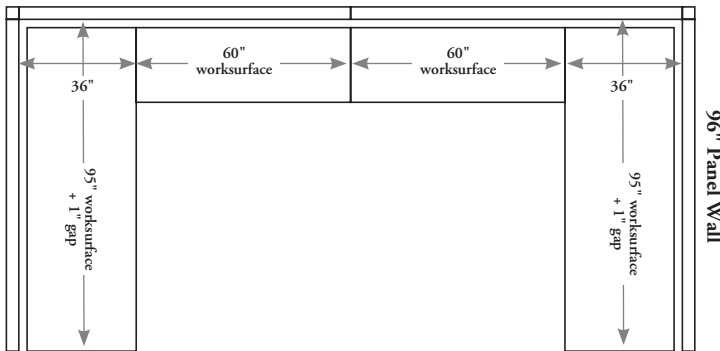

The two returns meet each other in the center so no gaps are required.

96" Panel Wall

48"

96" Panel Wall

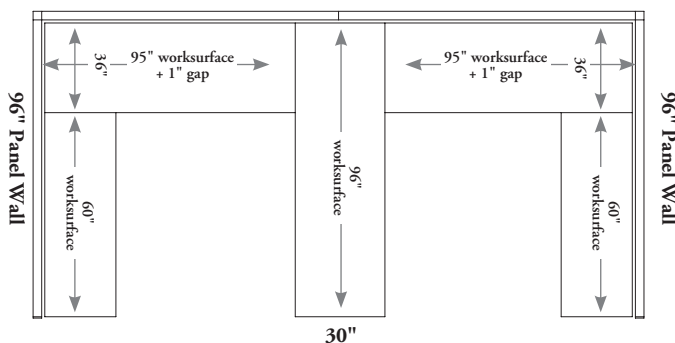

The center worksurface and return remains the full panel width and the outside primary surfaces have a 1" gap.

96" Panel Wall

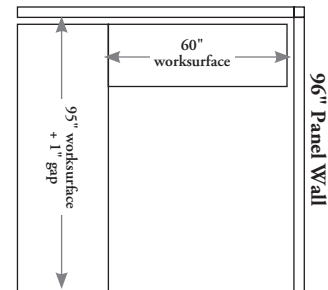

When a semi-suspended worksurface is used, it should be aligned with the panel end. The 1" gap then moves to the corner without having to reduce the return surface by 1".

planning with small footprint worksurfaces

District provides a limited collection of Small Footprint Worksurfaces that optimize efficiency within small scale workstation layouts.

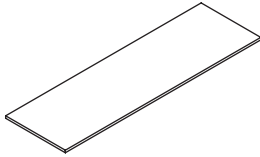

Rectangle Worksurface (UNWR)

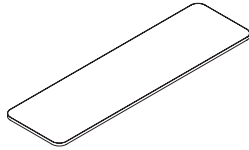

Rectangle with Radius Corners Worksurface (UNWC)

- Worksurfaces are available in depths of 17" to allow for maximum planning capability in temporary or permanent address workstations

rectangular worksurfaces

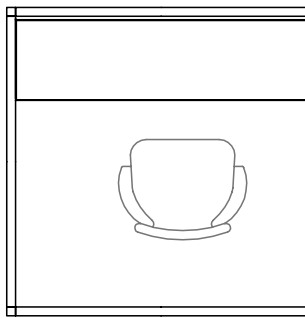

- 17" deep surfaces provide adequate chair space in 5' x 5' workstations

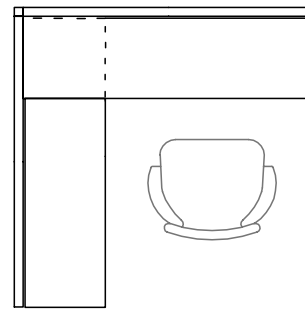

- When worksurfaces are requires above a 16" deep low storage, the cabinet depths will align

planning with grommets

The following needs to be considered when selecting grommets

worksurfaces combined with supports

Grommets can be located left, right or centered. The left and right grommets are centered on the depth to avoid interference with supports. See *Supports* for more details.

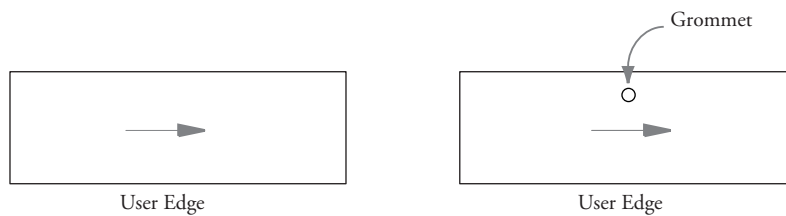
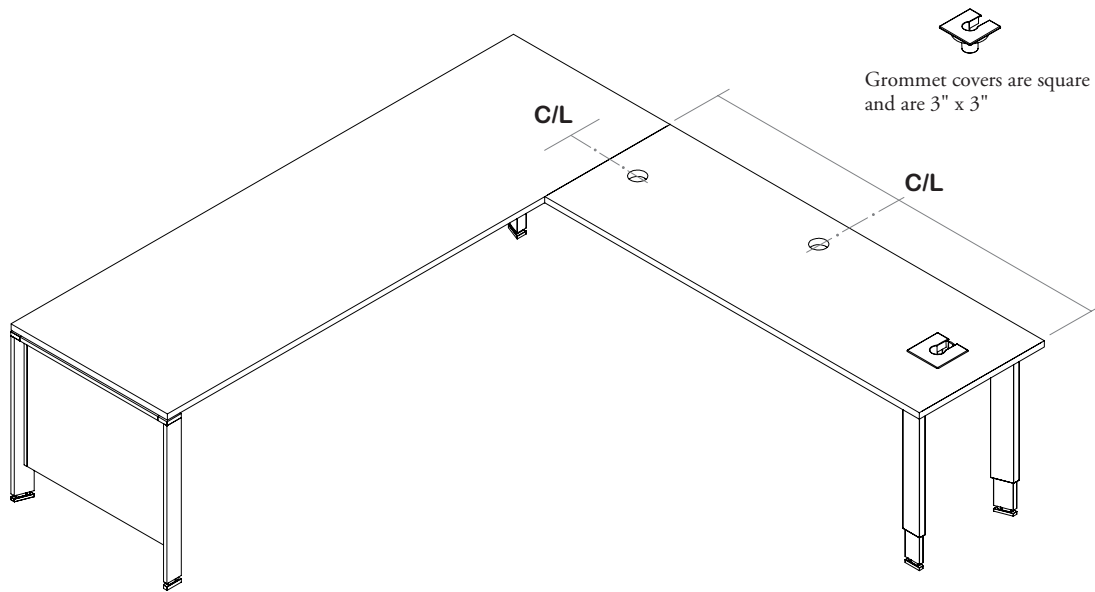

- Careful attention must be given to worksurfaces with a grain direction
- For surfaces with no grommet the grain direction should be going from left to right to match surface with grommets



worksurface grain/pattern direction

Attention to grain/pattern direction is important when planning worksurfaces.

- There is no user edge so care must be taken during installation to match grain/pattern direction
- Grain/patterns are **not** “centered” on worksurface or support
- Applies to Foundation Laminate (wood grain patterns), Flintwood (Standard and Cathedral) and Natural Veneer

worksurfaces

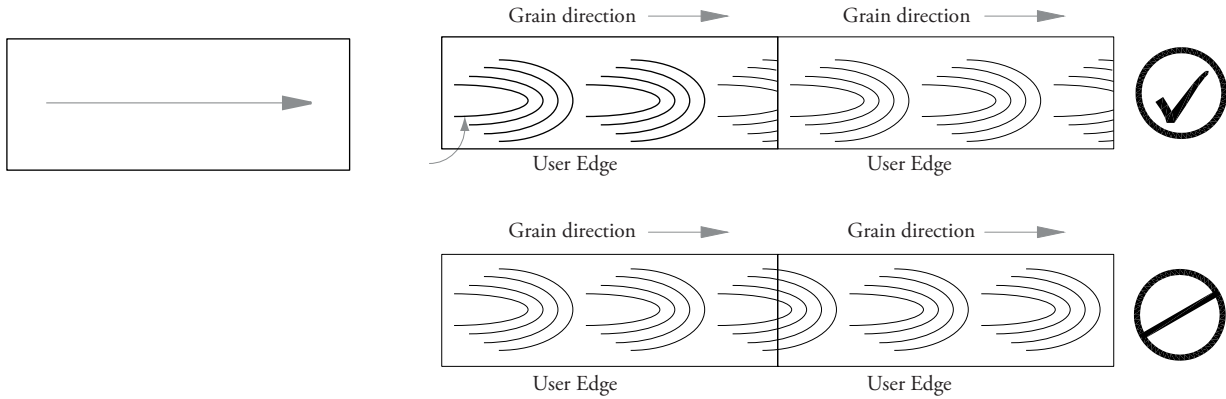

- Grain direction will appear in the same direction, from side to side
- For Cathedral Flintwoods and Natural Veneers the grain will run from left to right from the user’s prospective
- Grain patterns are **not** centered on worksurface
- Includes Laminate, Flintwood (Standard and Cathedral) and Natural Veneers



worksurface grain/pattern direction (continued)

Attention to grain/pattern direction is important when planning worksurfaces. The following examples demonstrate this.

- There is no user edge so care must be taken upon installation to match grain/pattern direction
- Grain/patterns are **not** “centered” on worksurface or support
- Includes Foundation Laminate, Flintwood (Standard and Cathedral) and Natural Veneer

bridge worksurfaces

District does **not** offer a bridge worksurface so grain direction changes will always occur

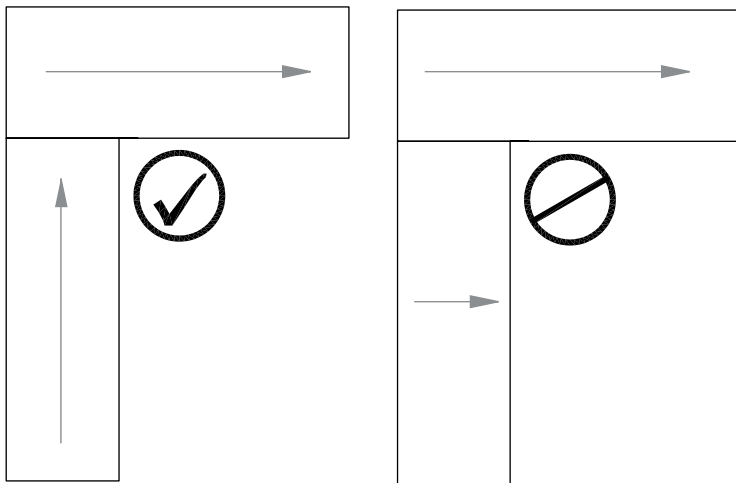

worksurfaces combined with supports

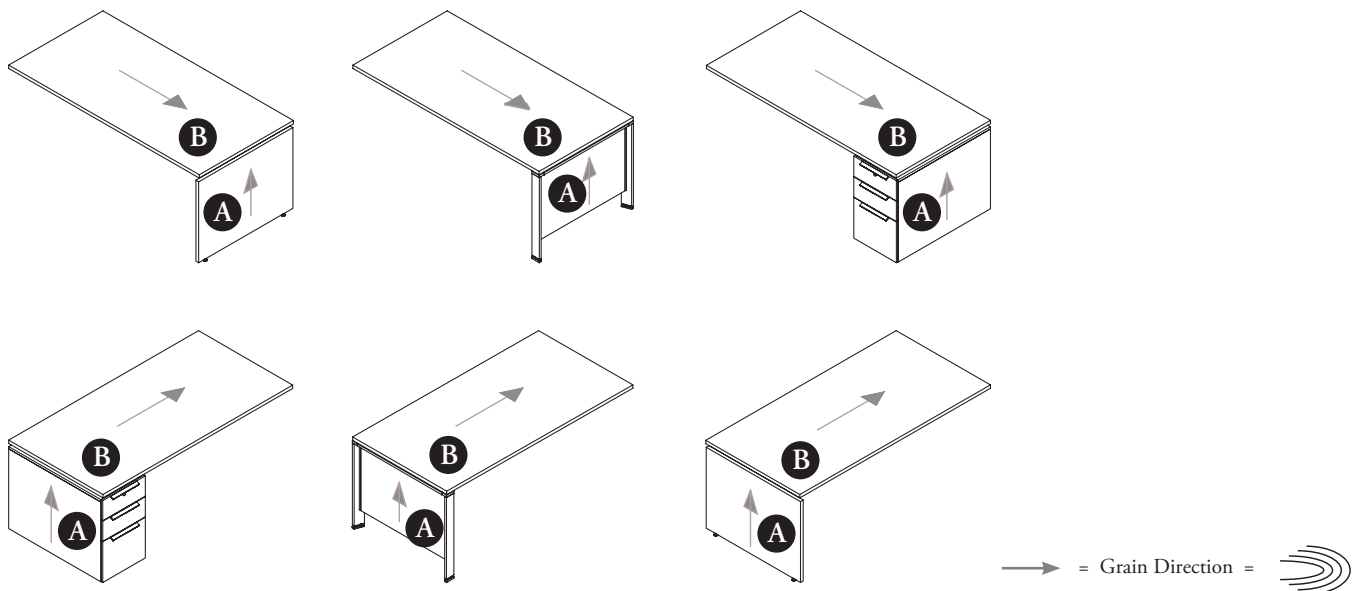

- Grain direction on Supports is always vertical
- For Cathedral Flintwoods and Natural Veneers the grain runs from bottom to top
- There is no matching grain across Supports (A) and Worksurfaces (B)



edge trim style overview

The chart below indicates which edge trim style can be specified with each District worksurface finish.

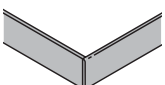
Both user edge and non-user edges have the same edge trim style.

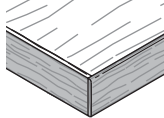
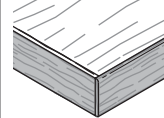
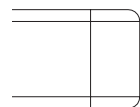
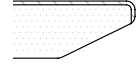
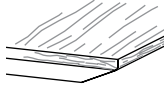
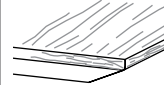
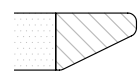
		Foundation Laminate Surface	Flintwood Surface	Natural Veneer Surface
Flat (8) All Edges			n/a	n/a
Flintwood Flat (9) All Edges		n/a		
Flat (G) All Edges		n/a	n/a	n/a
Full Knife (H) User Edge		*		
Full Knife (X) User Edge		n/a	n/a	n/a

height-adjustability

height-adjustability

UNDERSTANDING HEIGHT-ADJUSTABILITY	180
NAVIGATE HEIGHT-ADJUSTABLE BUILD-IN PERPENDICULAR TABLE BASICS	181
NAVIGATE HEIGHT-ADJUSTABLE BUILD-IN PARELLEL TABLE BASICS	182
NAVIGATE HEIGHT-ADJUSTABLE FREESTANDING TABLE BASICS	183
HISPACE HEIGHT-ADJUSTABLE BUILD-IN PERPENDICULAR TABLE BASICS	184
HISPACE HEIGHT-ADJUSTABLE BUILT-IN PARALLEL TABLE BASICS	185
PLANNING WITH HEIGHT-ADJUSTABLE TABLES	186
CREDENZAS FOR HEIGHT-ADJUSTABLE TABLES OVERVIEW . .	196
CREDENZAS FOR HEIGHT-ADJUSTABLE TABLE BASICS	197
HEIGHT-ADJUSTABLE CREDENZA DRAWER WIDTHS	198
PLANNING WITH CREDENZAS FOR HEIGHT-ADJUSTABLE TABLES	200
HEIGHT-ADJUSTABLE TABLES WITH SCREEN OVERVIEW	205
PLANNING WITH HEIGHT-ADJUSTABLE TABLES AND SCREENS .	206
HEIGHT-ADJUSTABLE CREDENZA LOCK CHART	212

understanding height-adjustability

District provides a variety of height-adjustable desking options which include credenzas and height-adjustable worksurfaces.

There are two options in height-adjustable tables:

navigate

- Option of two types of base mechanisms:
 - Standard Range Electric
 - Extended-Electric-Restricted
- Leg styles:
 - Post Leg and T-Leg
 - T-Legs
 - T-Leg and Gable Leg
- Two worksurface styles:
 - Rectangular
 - Rectangular worksurface with Radius Corners
- Worksurface finishes:
 - Foundation Laminate
 - Flintwood
 - Natural Veneer
- Power and undersurface cable management options available

hiSpace

- Option of one type of base mechanism:
 - Extended Electric with Riser
- Leg styles:
 - T-Legs
- Two worksurface styles:
 - Rectangular
 - Rectangular worksurface with Radius Corners
- Worksurface finishes:
 - Foundation Laminate
- Power and undersurface cable management options available

Both Navigate and hiSpace Height-adjustable tables can be planned with credenza storage in a variety of perpendicular and parallel applications.

perpendicular height-adjustable worksurfaces

Height-adjustable tables run perpendicular to the panel spine with credenzas running parallel to the spine.



parallel height-adjustable worksurfaces

Height-adjustable tables run parallel to the panel spine with credenzas running perpendicular to the spine.



perpendicular storage

Credenza storage runs perpendicular to the panel spine with Height-Adjustable tables running parallel to the spine.



parallel storage

Credenza storage runs parallel to the panel spine with Height-Adjustable tables running perpendicular to the spine.



navigate height-adjustable built-in perpendicular table basics

District with Navigate Height Adjustable Tables offers options for planning in perpendicular applications.



Perpendicular Height-Adjustable Built-in Worksurfaces)

- Used with same sized Navigate Height-Adjustable Built-in Bases
- Depth: 30"
- Grommet Cut Out Styles
 - Round (2-3/4" diameter)
- Cut Out Location:
 - None
 - Center
 - Left
 - Right

Navigate HA Built-in Base Perpendicular Planning

- Used with same sized Perpendicular Height-Adjustable Worksurfaces
- Depth: 30"
- Base Mechanism:
 - Standard Range Electric (27" - 43")
 - Extended Range Electric - Restricted (25" - 48.7")
- Switch Styles:
 - Standard Up/Down
 - Display with Up/Down Memory
- Toggle Up/Down
- Display Toggle with Memory and Navigate GPS
- Cut out Location:
 - None
 - Center
 - Left
 - Right

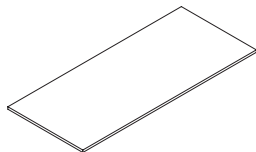

Perpendicular Rectangular Height-Adjustable Built-in Worksurface (WLD)

- A work surface with rectangular edges be used with either:
 - Built-in Bases, Perpendicular Planning
 - Built-in Gable Base - Perpendicular Planning
- Widths: 53", 59", 65", 71", 77", 83"

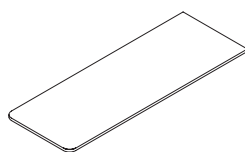

Perpendicular Rectangular Height-Adjustable Built-in Worksurface with Two Radius Corners (WMD)

- A work surface with radius edges that can used with:
 - Built-in Bases, Perpendicular Planning
- Widths: 65", 71", 77", 83"

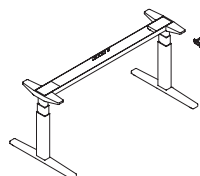

Navigate HA Built-in Base - Perpendicular Planning (YGD)

- A height-adjustable table base used with:
 - Rectangular Height-Adjustable Worksurface, Perpendicular Planning
 - Rectangular Height-Adjustable Worksurface with Two Radius Corners, Perpendicular Planning
- Width (to work with work surface width):
 - 65", 71", 77", 83"
- Leg Styles:
 - T-Leg (30" deep)

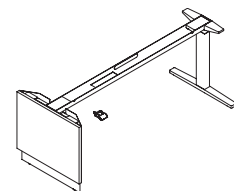

Navigate HA Built-in Gable Base - Perpendicular Planning (YVD)

- A height-adjustable base with integrated gable leg used with:
 - Rectangular Height-Adjustable Worksurface, Perpendicular Planning
- Width (to work with work surface width):
 - 53", 59", 65", 71", 77" 83"
- Leg Styles:
 - Gable Leg (30" deep)

navigate height-adjustable built-in parallel table basics

District offers a variety of options for height-adjustable planning in parallel applications.



Navigate HA Built-in Base - Parallel Planning

- Used with same sized Perpendicular Height-Adjustable Worksurfaces
- Depth:
 - 29"
- Base Mechanism:
 - Standard Range Electric (27" - 43")
 - Extended Range Electric - Restricted (25" - 48.7")
- Switch Styles:
 - Standard Up/Down
 - Display with Up/Down Memory
 - Toggle Up/Down
 - Display Toggle with Memory and Navigate GPS

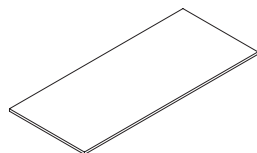

Parallel Rectangular Height-Adjustable Built-in Worksurface (WHD)

- A work surface with rectangular edges used with:
 - Built-in Bases, Parallel Planning
 - Built-in Gable Base - Parallel Planning
- Depths:
 - 29"
- Widths:
 - 52", 58", 64", 70", 76", 82"
- Grommet Cut Out Styles:
 - Round (2-3/4" diameter)
- Cut out Location:
 - None
 - Center
 - Left
 - Right

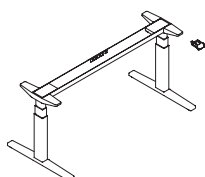

Navigate HA Built-in Base - Parallel Planning (YHD)

- A height-adjustable table base used with:
 - Rectangular Height-Adjustable Worksurface, Parallel Planning
- Width (to work with work surface width):
 - 52", 58", 64", 70", 76", 82"
- Leg Styles:
 - T-Leg (30" deep)

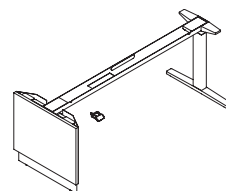

Navigate HA Built-in Gable Base - Parallel Planning (YWD)

- A height-adjustable base with integrated gable leg used with:
 - Rectangular Height-Adjustable Worksurface, Parallel Planning
- Width (to work with work surface width):
 - 46", 52", 58", 64", 70", 76", 82"
- Leg Styles:
 - Gable Leg (30" deep)

navigate height-adjustable freestanding table basics

District offers a variety of options for height-adjustable planning in freestanding applications.

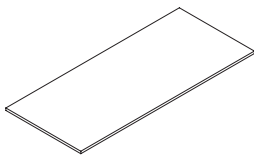

Freestanding Table Rectangular Height-Adjustable Worksurface (WBD)

- A worksurface with rectangular edges used with:
 - Built-in Base, Freestanding Planning
- Depths:
 - 23", 29", 35"
- Widths:
 - 45", 51", 57", 63", 69", 75", 81"
- Grommet Cut Out Styles:
 - Round (2-3/4" diameter)
- Cut out Location:
 - None
 - Center
 - Left
 - Right

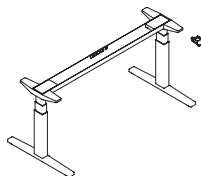

Navigate Freestanding Table, Base Only (YAD)

- A height-adjustable table base used with:
 - Rectangular Height-Adjustable Worksurface, Parallel Planning
- Depths (to work with worksurface depth):
 - 23", 29", 35"
- Width (to work with worksurface width):
 - 45", 51", 57", 63", 69", 75", 81"
- Leg Styles:
 - T-Leg (30" deep)
- Base Mechanism:
 - Counterbalance - Standard (29.5" - 49.5")
 - Counterbalance - Lower Edition (26.5" - 43.5")
 - Standard - Electric (27" - 43")
 - Extended Electric - Restricted (25" - 48.7")
 - Extended Electric - Extended (22.6" - 48.7")
- Switch Styles:
 - Standard Up/Down
 - Display with Up/Down Memory
 - Toggle Up/Dow
 - Display Toggle with Memory and Navigate GPS

hiSpace height-adjustable built-in perpendicular table basics

District offers a variety of options for height-adjustable planning in perpendicular applications.



Perpendicular Height- Adjustable Built-in Worksurfaces:

- Depths: 30"
- Widths: 65", 71"
- Grommet Cut Out Styles:
 - Round (2-3/4" diameter)
- Cut out Location:
 - None
 - Center
 - Left
 - Right

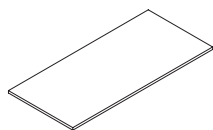

Perpendicular Rectangular Height-Adjustable Built-in Worksurface with Connection Kit for Quick Connect (WBG)

- A worksurface with rectangular edges used with:
 - Built-in Bases, Perpendicular Planning
 - Built-in Gable Base - Perpendicular Planning

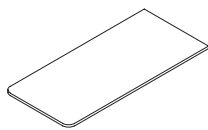

Perpendicular Rectangular Height-Adjustable Built-in Worksurface with Connection Kit for Quick Connect with Radius Corners (WJE)

- A worksurface with radius edges used with:
 - Built-in Bases, Perpendicular Planning

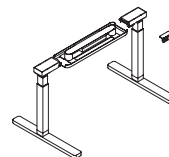

hiSpace Quick Connect Height-Adjustable Built-in Base Perpendicular Planning (YSG)

- A height-adjustable table base used with:
 - Rectangular Height-Adjustable Worksurface, Perpendicular Planning
 - Rectangular Height-Adjustable Worksurface with Two Radius Corners, Perpendicular Planning
- Depths (to work with worksurface depth):
 - 30"
- Width (to work with worksurface width):
 - 65", 71"
- Leg Styles: T-Leg (30" deep)
- Base Mechanism:
 - Extended Electric with Riser - (25" - 51.1")
- Switch Styles:
 - Display with Up/Down Memory
- Optional Undersurface Cable Management:
 - None
 - Cable Organizer with Felt Cover
 - Dual Plastic Trays & Powerbar
 - Dual Plastic Trays
- Vertical Wire Carrier:
 - None
 - Vertical Wire Carrier Finish

hiSpace height-adjustable built-in parallel table basics

District offers a variety of options for height-adjustable planning in parallel applications.

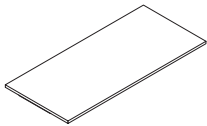

Parallel Rectangular Height-Adjustable Built-in Worksurface (WBF)

- A worksurface with rectangular edges used with:
 - Built-in Bases, Parallel Planning
- Depths:
 - 29"
- Widths:
 - 52", 58", 64", 70"
- Grommet Cut Out Styles:
 - Round (2-3/4" diameter)
- Cut-out Location:
 - None
 - Center
 - Left
 - Right

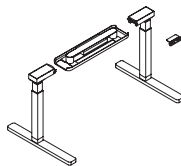

hiSpace Height-Adjustable Built-in Base - Parallel Planning with connection kit for Quick Connect (YSP)

- A height-adjustable table base used with:
 - Rectangular Height-Adjustable Worksurface, Parallel Planning
- Depths (to work with worksurface depth):
 - 29"
- Width (to work with worksurface width):
 - 52", 58", 64", 70"
- Base Mechanism:
 - Extended Electric with Riser - (25" - 51.1")
- Switch Styles:
 - None
 - Cable Organizer with Felt Cover
 - Dual Plastic Trays & Powerbar
 - Dual Plastic Trays
- Vertical Wire Carrier:
 - None
 - Vertical Wire Carrier Finish

planning with height-adjustable tables

The following should be taken into consideration when planning with height-adjustable tables.

height-adjustment range

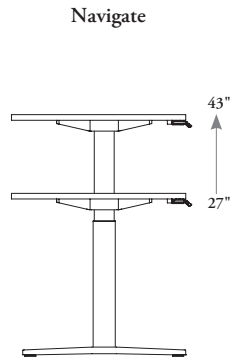

Standard Electric

- Minimum Height: 27"
- Maximum Height: 43"

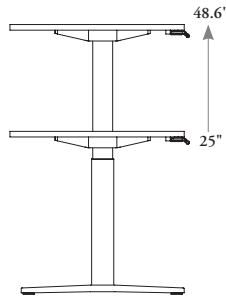

Extended Electric - Restricted

- Minimum Height: 25"
- Maximum Height: 48.6"
- Minimum height is restricted so it does not interfere with a credenza.

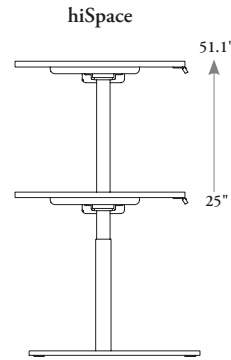

Extended Electrics with Riser

- Minimum Height: 25"
- Maximum Height: 51.1"

cut outs and grommets

Cut outs with grommets are used to direct wires to the underside of the desk so they can be plugged into an under worksurface power bar or directed to a District panel. Only the cut out is included in the worksurface, grommets must be ordered separately.

The following cut out locations can be specified:

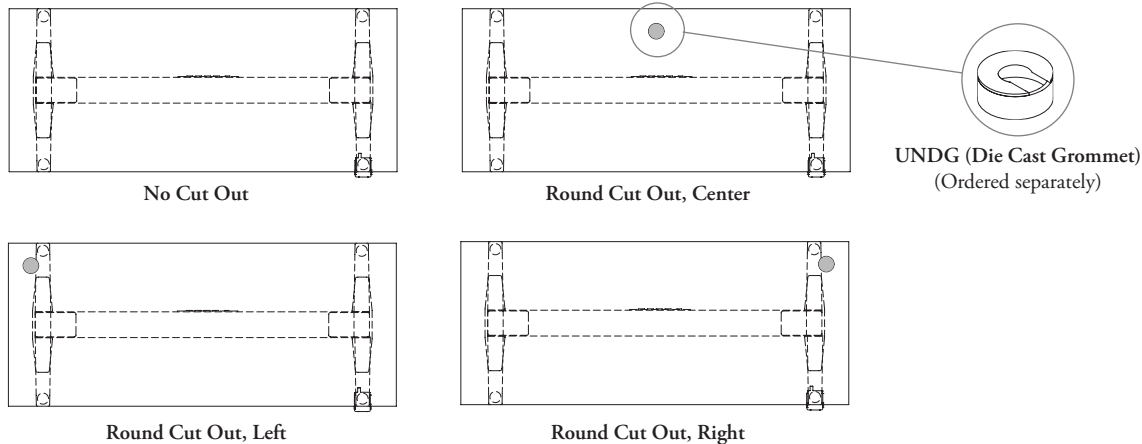

The following outlines the location of the grommet cut outs:

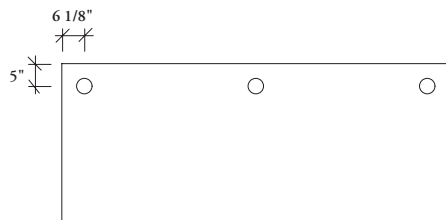

Center cut out is always centered on worksurface.
Left and right cut outs are 5" from edge for 30" deep worksurfaces and 3" for 29" deep worksurfaces.

planning with height-adjustable tables (continued)

switches

The following switches are available for upStage Navigate and hiSpace Height-Adjustable Built-In bases:

- Navigate
 - Standard Up/Down
 - Display with Up/Down Memory
 - Toggle Up/Down
 - Display Toggle with Memory & Navigate GPS
- hiSpace
 - Display with Up/Down Memory

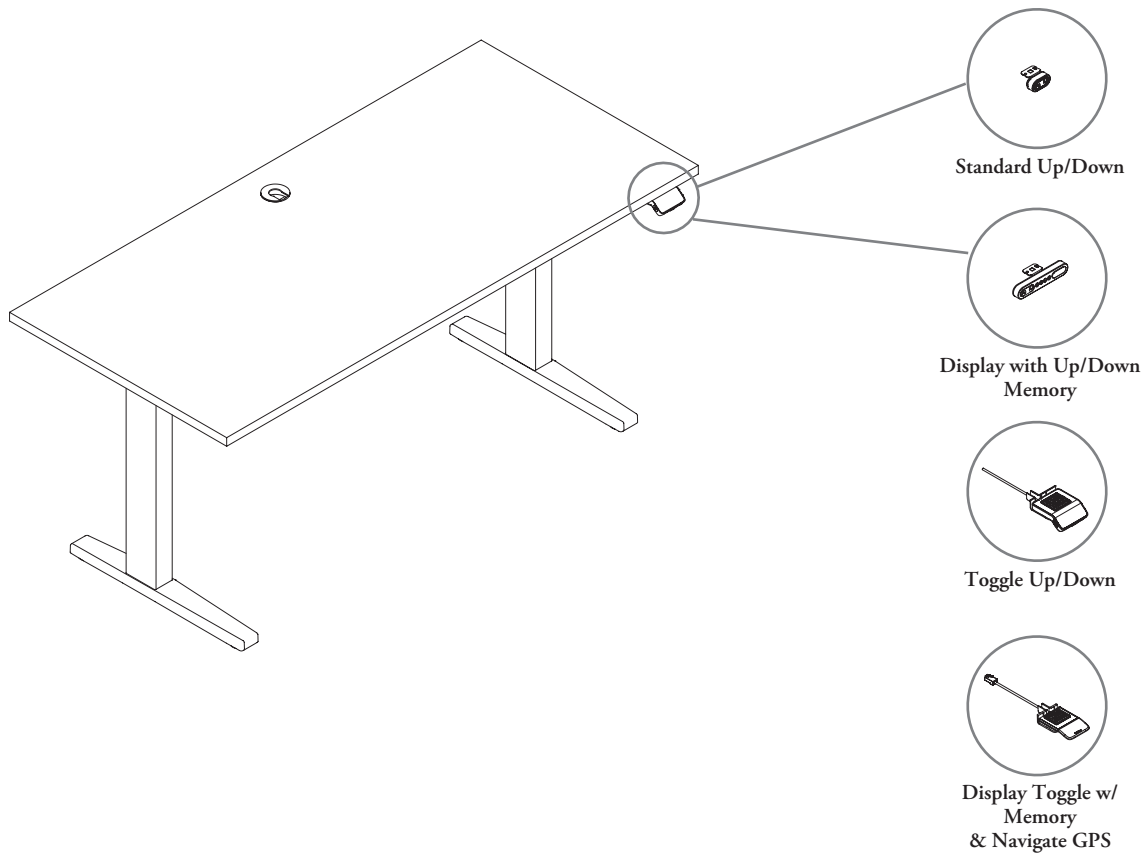

power bars and iec connection

There is an optional Cross Channel Integrated Power Bar which is mounted under the worksurface.

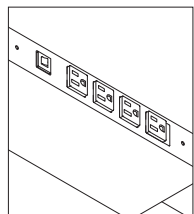

Cross Channel Integrated Powerbar - 4 Outlets (I)

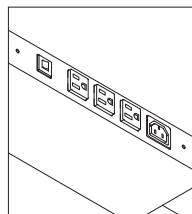

Cross Channel Integrated Powerbar - 3 Outlets + 1 IEC (C)

- Available on worksurfaces with 53" - 83" widths

If no Cross Channel Integrated Power Bar is specified, a cover plate will be provided.

For more information about planning with IEC connection and height-adjustability, refer to Complements: *Teknion's Ergonomics & Accessories Program*.

power pack on hiSpace

There is an optional power pack integrated with Cable Organizer with felt cover.

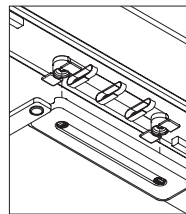

- Available on worksurfaces 53" - 71"

planning with height-adjustable tables (continued)

undersurface cable management

The following under surface are available for upStage Navigate and hiSpace Height-Adjustable Built-In bases:

- Navigate
 - None
 - Cable organization with felt cover (Only available on worksurface depths 30")
 - Cable organization with no cover
 - Dual Plastic Trays & Power Bar
 - Dual Plastic Trays
- hiSpace
 - None
 - Dual Plastic Trays & Power Bar
 - Dual Plastic Trays

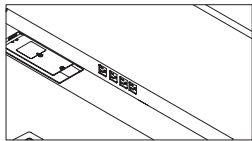

None

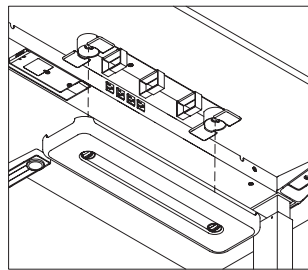

Cable organization with felt cover
(Only available on worksurface depths 31")

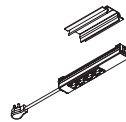

Dual plastic trays, power bar
and under surface mount

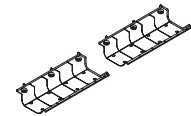

Dual plastic trays

planning with height-adjustable tables (continued)

vertical wire carrier

Vertical Wire Carriers can be specified on Height-Adjustable Built-in Bases and come with a mounting bracket.

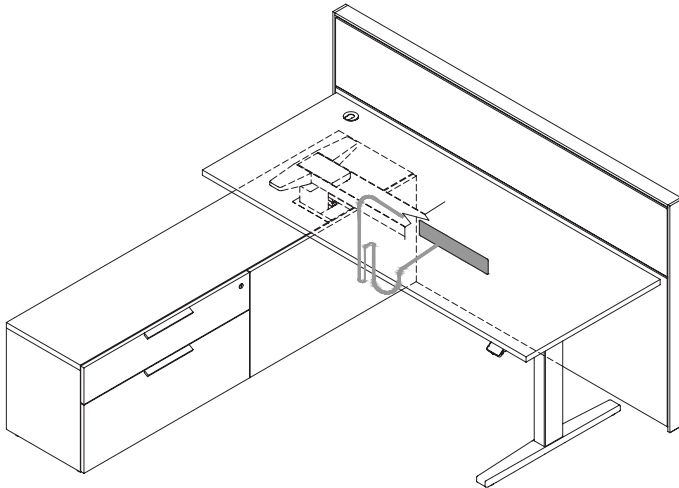

If an Vertical Wire Carrier is specified, it is recommended that it be planned within a credenza.

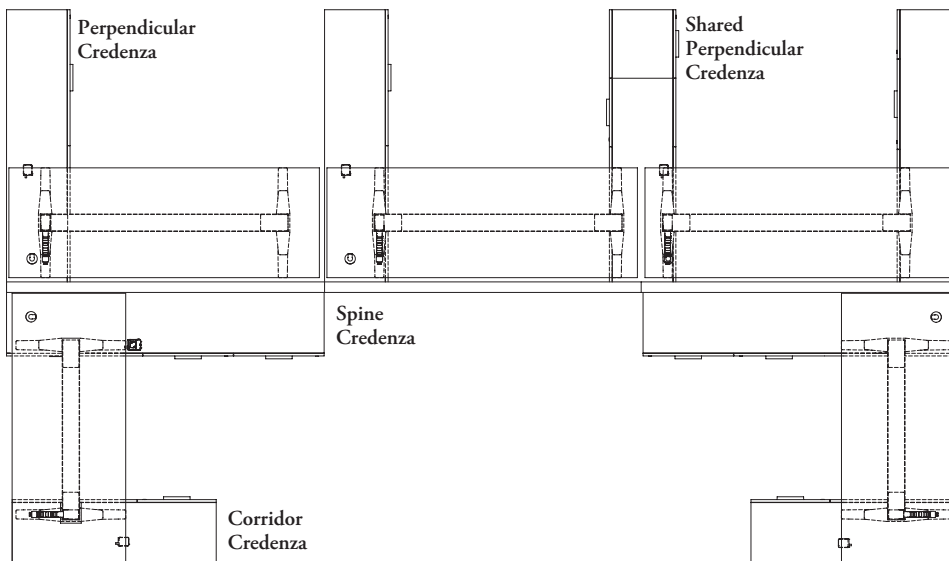

Vertical Wire Carriers cannot be planned within a Parallel Corridor Credenza (UPCC).

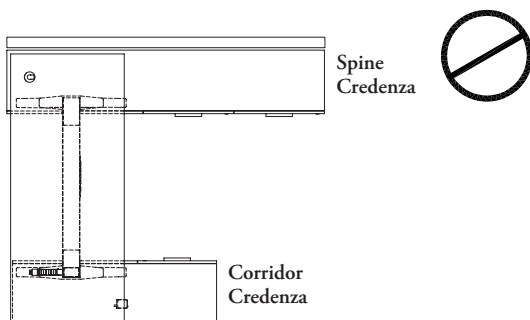

planning with height-adjustable tables (continued)

perpendicular planning with worksurfaces

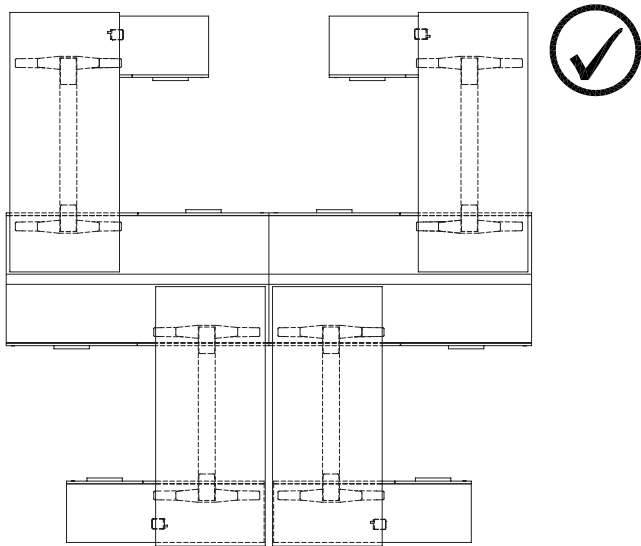

Planning with Perpendicular Rectangular Height-Adjustable Built-in Worksurfaces to the panel spine

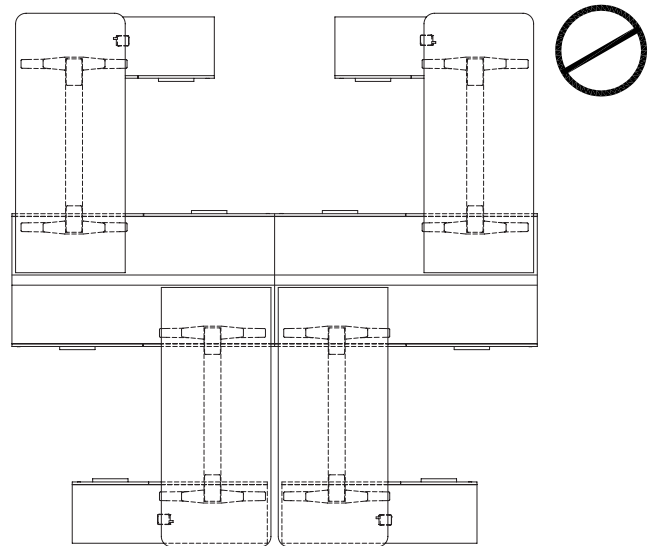

Planning with Perpendicular Rectangular Height-Adjustable Built-in Worksurfaces with Two Radius Corners to the panel spine

parallel planning with worksurfaces

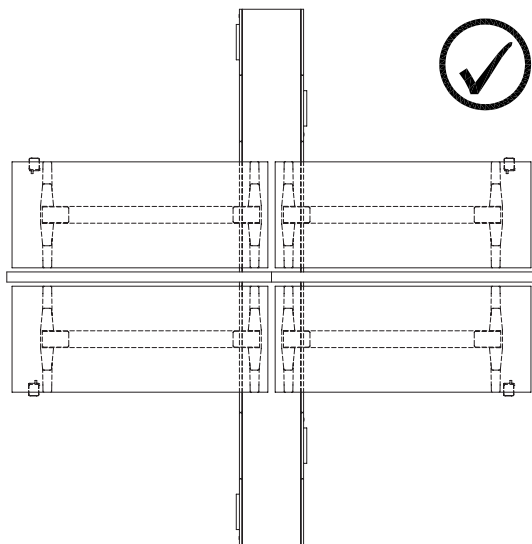

When planning with worksurfaces parallel to the spine, only Parallel Rectangular Height-Adjustable Built-in Worksurface can be specified.

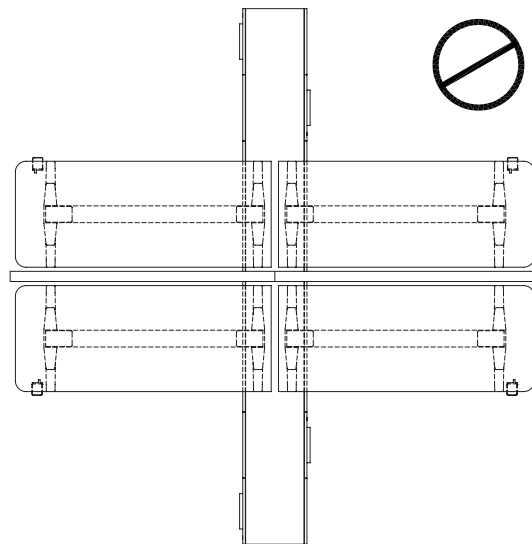

It is not recommended to use Perpendicular Rectangular Height-Adjustable Built-in Worksurface with Two Radius Corners parallel to the panel spine.

planning with height-adjustable tables (continued)

navigate perpendicular worksurfaces and height-adjustable table bases

District Navigate height-adjustable table bases have options for the leg location in order to accommodate the applications they are being used in. In order to specify the correct worksurface to match the height-adjustable base, it is required to know the leg application of the workstation beforehand.

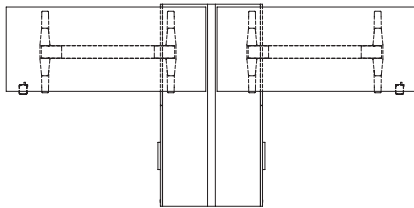

TSL
Left Leg in Corridor,
Right Leg in Parallel
Spine Credenza

TSR
Right Leg in Corridor,
Left Leg in Parallel
Spine Credenza

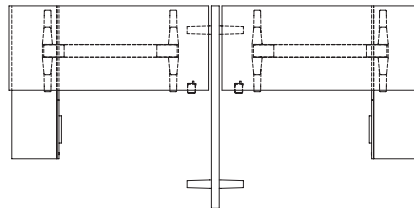

TCL
Left Leg in Parallel
Corridor Credenza,
Right Leg along Panel

TCR
Right Leg in Parallel
Corridor Credenza,
Left Leg along Panel

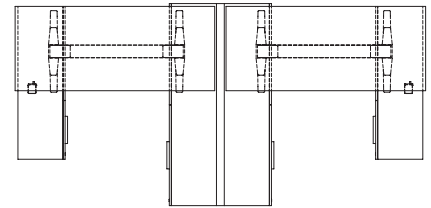

TBL
Left Leg in Parallel
Corridor Credenza,
Right Leg in Parallel
Spine Credenza

TBR
Right Leg in Parallel
Corridor Credenza,
Left Leg in Parallel
Spine Credenza

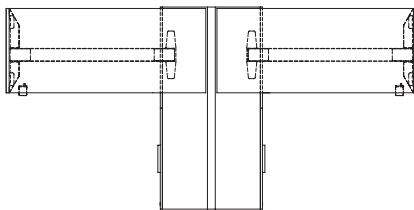

GSL
Left Leg is Gable Leg
in Corridor, Right
Leg in Parallel Spine
Credenza

GSR
Right Leg is Gable
Leg in Corridor, Left
Leg in Parallel Spine
Credenza

Once the application has been chosen, the worksurface is then specified to match the height-adjustable table base. The following is an example of how to specify a height-adjustable table that is perpendicular to the spine. Make certain that 3-digit Leg Application codes match to ensure proper fit.

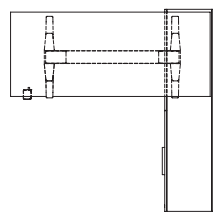
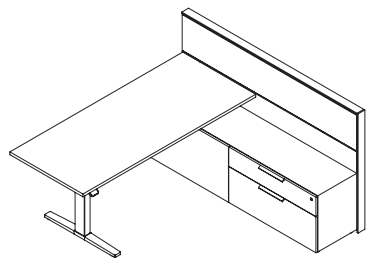

TSL (Leg Application code)
Left Leg in Corridor,
Right Leg in Parallel Spine
Credenza

Navigate Height-Adjustable Built-in Base Perpendicular Planning - YGDTSL7S31711

Height-Adjustable Base Type	Leg Application	Base Mechanism	Base Depth	Base Width	Undersurface Cable Manager
YGD	TSL / TSR	7S	31"	65"	1
	TCL / TCR	9C		71"	
	TBL / TBR			77"	
	GSL / GSR			83"	

Perpendicular Rectangular Height-Adjustable Built-in Worksurface - WLDTSL7S3171NN

Worksurface Type	Leg Application	Base Mechanism	Worksurface Depth	Worksurface Width	Undersurface Cable Manager
WLD	TSL / TSR	7S	31"	53"	GC (Grommet, Center)
	TCL / TCR	9C		59"	GL (Grommet, Left)
	TBL / TBR			65"	GR (Grommet, Right)
	GSL / GSR			71"	NN (Grommet, None)
				77"	

planning with height-adjustable tables (continued)

navigate parallel worksurfaces and height-adjustable table bases

District Navigate height-adjustable table bases have options for the leg location in order to accommodate the applications they are being used in. In order to specify the correct worksurface to match the height-adjustable base, it is required to know the leg application of the workstation beforehand.

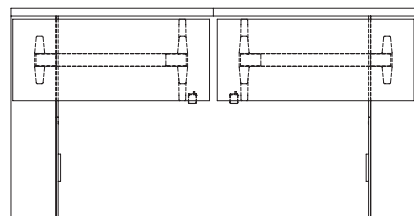

TZL
Left Leg in Credenza,
Right Leg in the
Middle

TZR
Right Leg in Credenza,
Left Leg in the Middle

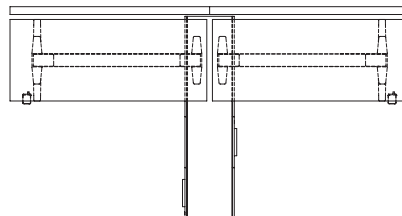

TDL
Left Leg Outside,
Right Leg in Shared
Perpendicular Credenza

TDR
Right Leg Outside,
Left Leg in Shared
Perpendicular Credenza

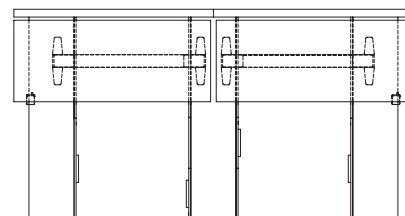

THL
Left Leg in
Perpendicular Credenza,
Right Leg in Shared
Perpendicular Credenza

THR
Right Leg in
Perpendicular
Credenza, Left Leg in
Shared Perpendicular

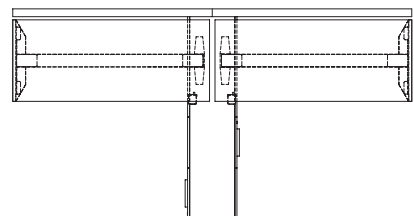

GDL
Left Gable Leg toward
the outside, Right
T-Leg in Shared
Perpendicular Credenza

GDR
Right Gable Leg toward
the outside, Left T-Leg
in Shared Perpendicular
Credenza

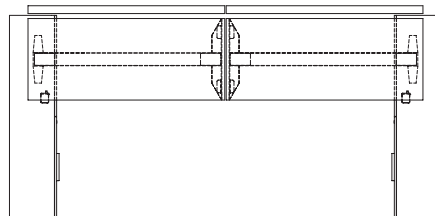

GZL
Left T-Leg in
Perpendicular
Credenza, Right Gable
Leg toward the middle

GZR
Right T-Leg in
Perpendicular
Credenza, Left Gable
Leg toward the middle

Once the application has been chosen, the worksurface is then specified to match the height adjustable table base. The following is an example of how to specify a height-adjustable table that is parallel to the spine. Make certain that 3-digit Leg Application codes match to ensure proper fit.

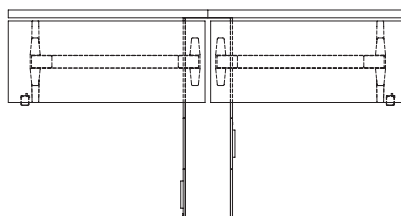
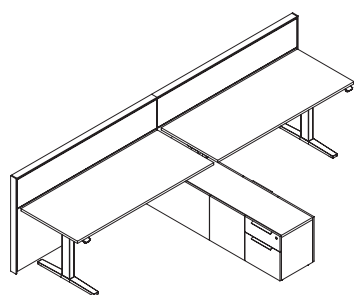

TDL (Leg Application code)
Left T-Leg in Perpendicular
Credenza, Right Gable
Leg toward the middle

Navigate Height-Adjustable Built-in Base Parallel Planning - YHDTDL7S29701

Height-Adjustable Base Type	Leg Application	Base Mechanism	Base Depth	Base Width	Undersurface Cable Manager
YHD	TZL / TZR	7S	29"	52"	1
	TDL / TDR	9C		58"	
	THL / THR			64"	
	GDL / GDR			70"	
	GZL / GZR			78"	
				82"	

Parallel Rectangular Height-Adjustable Built-in Worksurface - WLDTDL7S2970NN

Worksurface Type	Leg Application	Base Mechanism	Worksurface Depth	Worksurface Width	Undersurface Cable Manager
WHD	TZL / TZR	7S	29"	52"	GC (Grommet, Center)
	TDL / TDR	9C		58"	GL (Grommet, Left)
	THL / THR			64"	GR (Grommet, Right)
	GDL / GDR			70"	NN (Grommet, None)
	GZL / GZR			78"	
				82"	

planning with height-adjustable tables (continued)

hiSpace perpendicular worksurfaces and height-adjustable table bases

District hiSpace height-adjustable table bases have options for the leg location in order to accommodate the applications they are being used in. In order to specify the correct worksurface to match the height-adjustable base, it is required to know the leg application of the workstation beforehand.

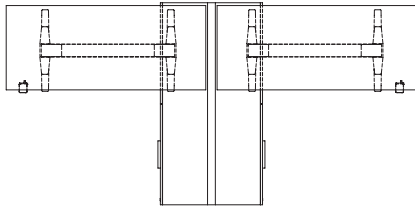

TSL
Left Leg in Corridor,
Right Leg in Parallel
Spine Credenza

TSR
Right Leg in Corridor,
Left Leg in Parallel
Spine Credenza

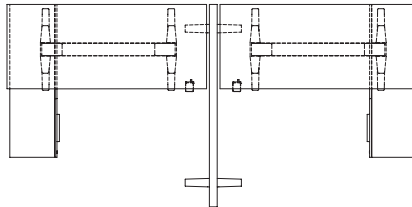

TCL
Left Leg in Parallel
Corridor Credenza,
Right Leg along Panel

TCR
Right Leg in Parallel
Corridor Credenza,
Left Leg along Panel

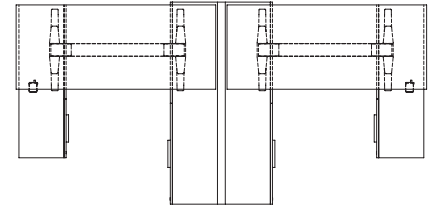

TBL
Left Leg in Parallel
Corridor Credenza,
Right Leg in Parallel
Spine Credenza

TBR
Right Leg in Parallel
Corridor Credenza,
Left Leg in Parallel
Spine Credenza

Once the application has been chosen, the worksurface is then specified to match the height-adjustable table base. The following is an example of how to specify a height-adjustable table that is perpendicular to the spine. Make certain that 3-digit Leg Application codes match to ensure proper fit.

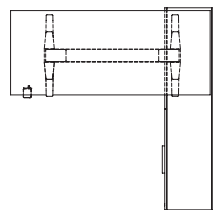
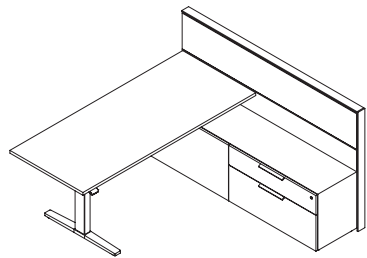

TSL (Leg Application code)
Left Leg in Corridor,
Right Leg in Parallel Spine
Credenza

hiSpace Height-Adjustable Built-in Base Perpendicular Planning - YSGTSL9U30711

Height-Adjustable Base Type	Leg Application	Base Mechanism	Base Depth	Base Width	Undersurface Cable Manager
YGD	TSL / TSR TCL / TCR TBL / TBR	9U	30"	65" 71"	1

hiSpace Perpendicular Rectangular Height-Adjustable Built-in Worksurface - WLDTSL9U3071NN

Worksurface Type	Leg Application	Base Mechanism	Worksurface Depth	Worksurface Width	Undersurface Cable Manager
WBG	TSL / TSR TCL / TCR TBL / TBR	9U	30"	71"	GC (Grommet, Center) GL (Grommet, Left) GR (Grommet, Right) NN (Grommet, None)

planning with height-adjustable tables (continued)

navigate parallel worksurfaces and height-adjustable table bases

District Navigate height-adjustable table bases have options for the leg location in order to accommodate the applications they are being used in. In order to specify the correct worksurface to match the height-adjustable base, it is required to know the leg application of the workstation beforehand.

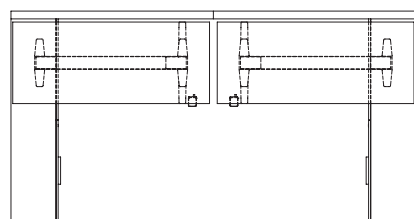

TZL
Left Leg in Credenza,
Right Leg in the
Middle

TZR
Right Leg in Credenza,
Left Leg in the Middle

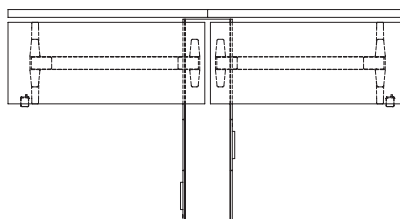

TDL
Left Leg Outside,
Right Leg in Shared
Perpendicular Credenza

TDR
Right Leg Outside,
Left Leg in Shared
Perpendicular Credenza

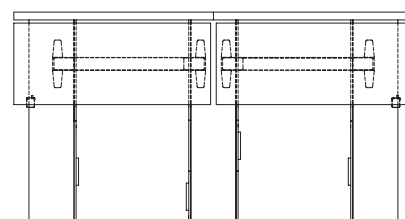

THL
Left Leg in
Perpendicular Credenza,
Right Leg in Shared
Perpendicular Credenza

THR
Right Leg in
Perpendicular
Credenza, Left Leg in
Shared Perpendicular

Once the application has been chosen, the worksurface is then specified to match the height adjustable table base. The following is an example of how to specify a height-adjustable table that is parallel to the spine. Make certain that 3-digit Leg Application codes match to ensure proper fit.

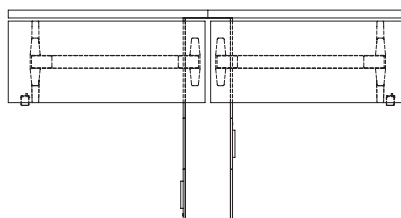
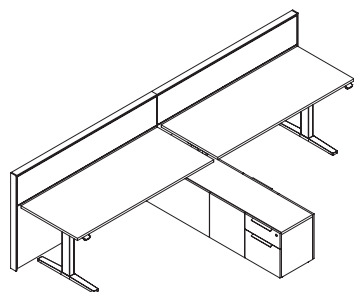

TDL (Leg Application code)
Left T-Leg in Perpendicular
Credenza, Right Gable Leg
toward the middle

hiSpace Height-Adjustable Built-in Base Parallel Planning - YSPTDL9U29701

Height-Adjustable Base Type	Leg Application	Base Mechanism	Base Depth	Base Width	Undersurface Cable Manager
YSP	TZL / TZR	9U	29"	52"	1
	TDL / TDR			58"	
	THL / THR			64"	
				70"	

hiSpace Parallel Rectangular Height-Adjustable Built-in Worksurface - WLDTDL7S2970NN

Worksurface Type	Leg Application	Base Mechanism	Worksurface Depth	Worksurface Width	Undersurface Cable Manager
WHD	TZL / TZR	9U	29"	52"	GC (Grommet, Center)
	TDL / TDR			58"	GL (Grommet, Left)
	THL / THR			64"	GR (Grommet, Right)
				70"	NN (Grommet, None)

planning with height-adjustable tables (continued)

gapping

When planning with height-adjustable tables there will be a 1" gap between the worksurfaces and panels to avoid any pinch points.

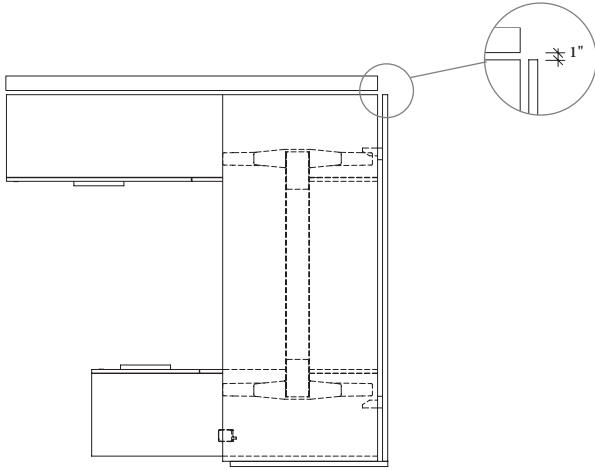

Perpendicular to spine Navigate or hiSpace Height-Adjustable Table wrapped with screens.

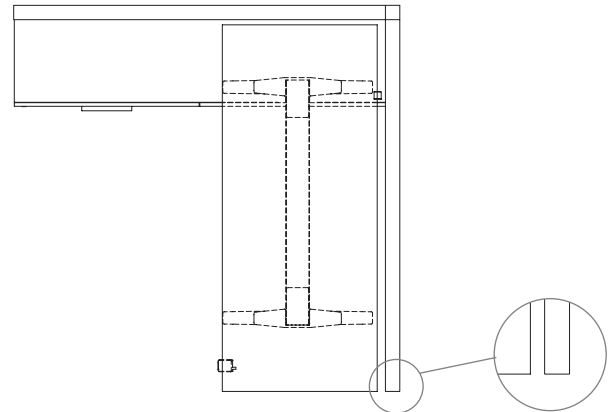

Perpendicular to spine Navigate or hiSpace Height-Adjustable Table wrapped with a Freestanding District Panel.

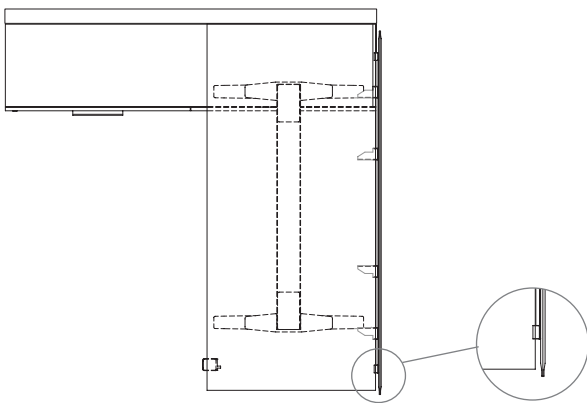

Perpendicular to spine Navigate or hiSpace Height-Adjustable Table with Screen.

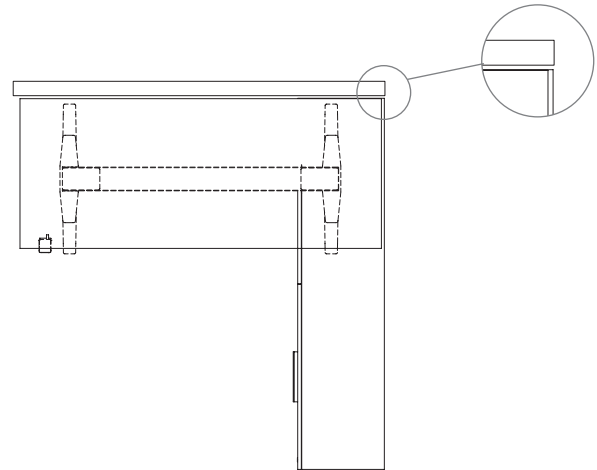

Parallel to spine Navigate or hiSpace Height-Adjustable Table.

credenzas for height-adjustable tables overview

When choosing a credenza for height-adjustable tables in District, there are two styles, perpendicular and parallel which are defined by the relationship of the credenza to the panel spine.

perpendicular credenzas

Credenzas run perpendicular to the panel spine with height-adjustable tables running parallel to the spine.

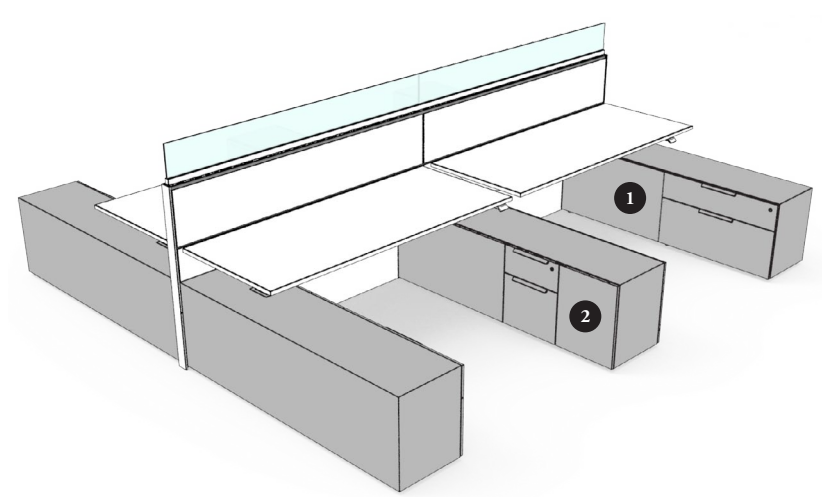

- 1 Perpendicular Credenza for Height-Adjustable Table - Full Drawer (UPPC)
- 2 Shared Perpendicular Credenza for Height-Adjustable Table (UPCS)

parallel credenzas

Credenzas run parallel to the panel spine with height-adjustable tables running perpendicular off of the spine.

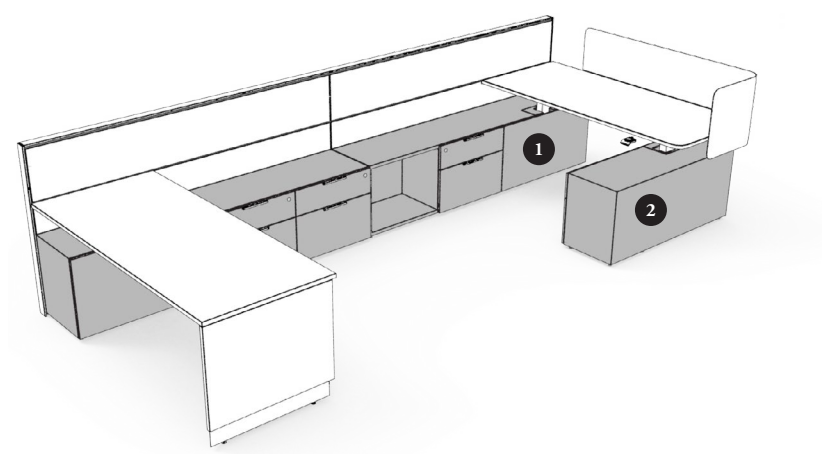

- 1 Parallel Spine Credenza for Height-Adjustable Table - Open with Drawer (UPSC)
- 2 Parallel Corridor Credenza for Height-Adjustable Table (UPCC)

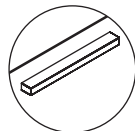
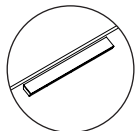

District Handle Pull Rectangular Handle Pull

Two handle styles are available on District credenzas for height-adjustability.

credenzas for height-adjustable table basics

District offers a variety of credenza options for height-adjustable planning in parallel and perpendicular applications.

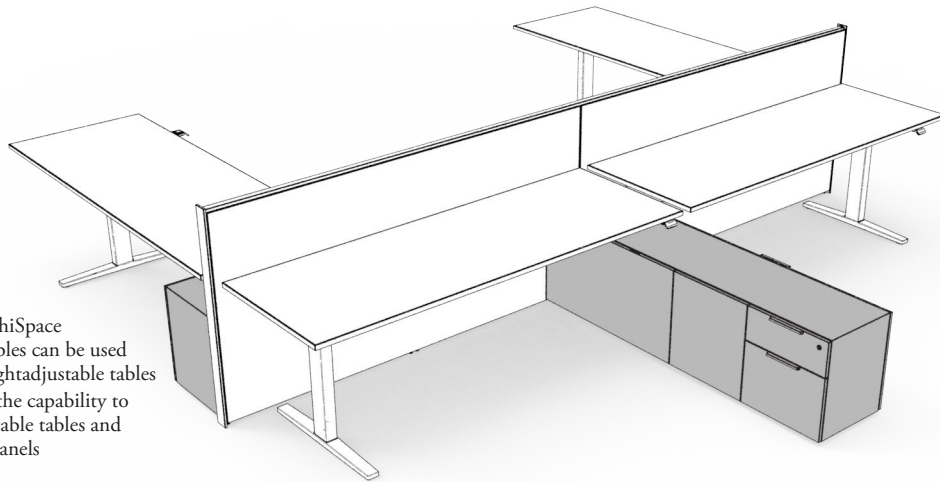

- District Navigate and hiSpace Height-Adjustable Tables can be used with credenzas for heightadjustable tables
- Provides storage with the capability to integrate height-adjustable tables and support stackers and panels
- Height:
 - 21"
- Depth:
 - 16"
- Leveling Range is -0.625" to +0.375"
- Lock option is standard locks
- Storage extented leveling kit (UNSLXC)

- Finishes:
- Laminate
 - Flintwood
 - Wood Veneer

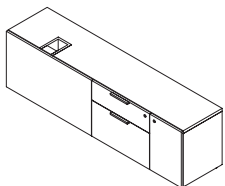

Perpendicular Credenza for Height-Adjustable Table (UPPC)

- Configurations:
 - Full Drawer
 - File with Hinged Door
- Can be used with:
 - N avigate Height-Adjustable Built-in Base - Parallel Planning
 - N avigate Height-Adjustable Built-in Gable Base -Parallel Planning
 - hiSpace Height-Adjustable Built-in Base Quick Connect - Parallel Planning
- Widths:
 - 48", 54", 60", 66", 72"

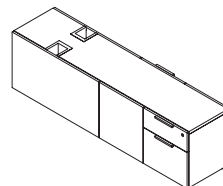

Shared Perpendicular Credenza for Height-Adjustable Table (UPCS)

- Can be used with:
 - Navigate Height-Adjustable Built-in Base - Parallel Planning
 - Navigate Height-Adjustable Built-in Gable Base -Parallel Planning
 - hiSpace Height-Adjustable Built-in Base Quick Connect - Parallel Planning
- Widths:
 - 66", 72"

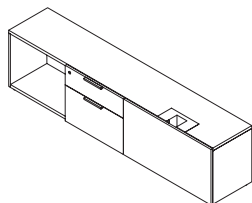

Parallel Spine Credenza for Height-Adjustable Table (UPSC)

- Configurations:
 - Full Drawer
 - Open with Drawer
- Can be used with:
 - Navigate Height-Adjustable Built-in Base - Perpendicular Planning
 - Navigate Height-Adjustable Built-in Gable Base - Perpendicular Planning
 - hiSpace Height-Adjustable Built-in Base Quick Connect - Perpendicular Planning
- Widths:
 - 72", 78", 84"

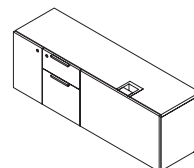

Parallel Corridor Credenza for Height-Adjustable Table (UPCC)

- Configurations:
 - Full Drawer
 - File with Hinged Door
- Can be used with:
 - Navigate Height-Adjustable Built-in Base - Perpendicular Planning
 - Navigate Height-Adjustable Built-in Gable Base - Perpendicular Planning
 - hiSpace Height-Adjustable Built-in Base Quick Connect - Perpendicular Planning
- Widths:
 - 48", 54", 60"

height-adjustable credenza drawer widths

The following illustrates District height-adjustable credenza drawer and open section widths.

Perpendicular Credenza for Height-Adjustable Table (UPPC)

48" Width - Full Drawer (F)

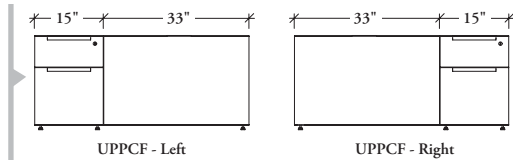

54" Width - Full Drawer (F)

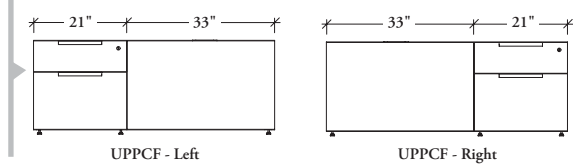

60" Width - Full Drawer (F)

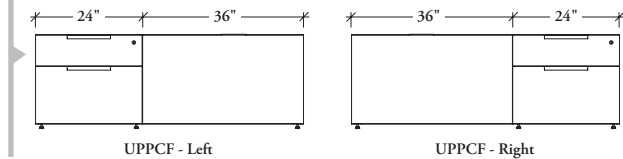

60" Width - File with Hinged Door (H)

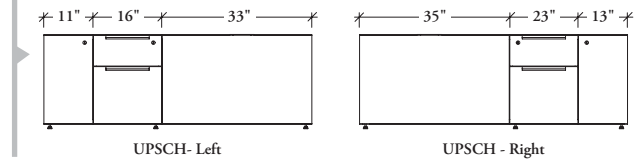

66" Width - Full Drawer (F)

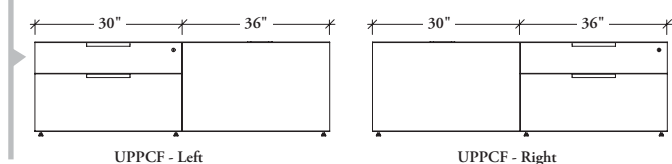

66" Width - File with Hinged Door (H)

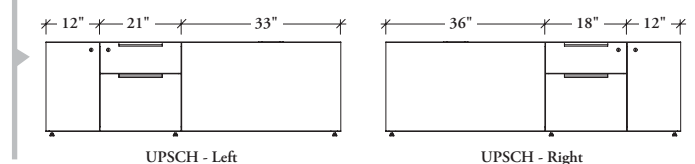

72" Width - Full Drawer (F)

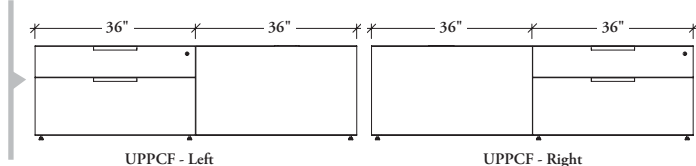

72" Width - File with Hinged Door (H)

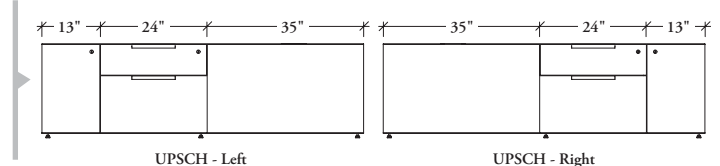

Shared Perpendicular Credenza for Height-Adjustable Table (UPCS)

66" Width

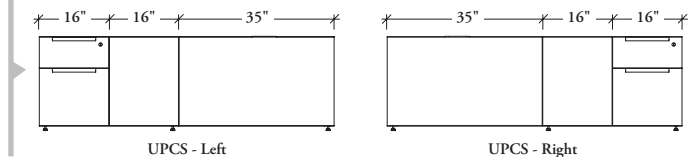

72" Width

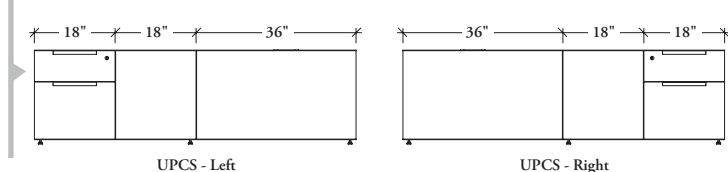

height-adjustable credenza drawer widths (continued)

The following illustrates District height-adjustable credenza drawer and open section widths.

Parallel Spine Credenza for Height-Adjustable Table (UPSC)

72" Width - Full Drawer (F)

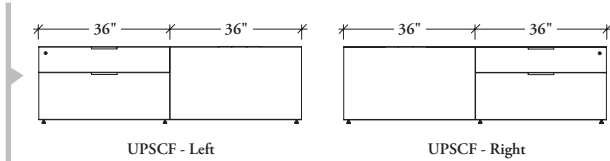

72" Width - Open with Drawer (P)

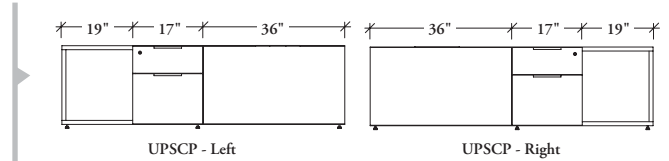

78" Width - Full Drawer (F)

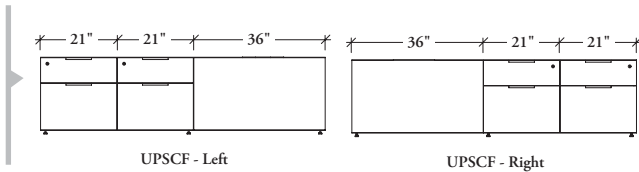

78" Width - Open with Drawer (P)

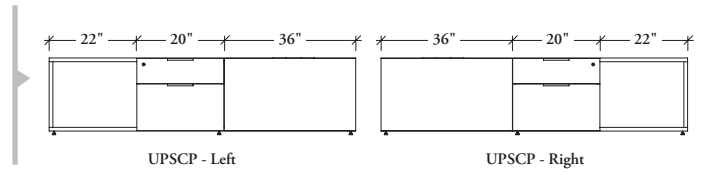

84" Width - Full Drawer (F)

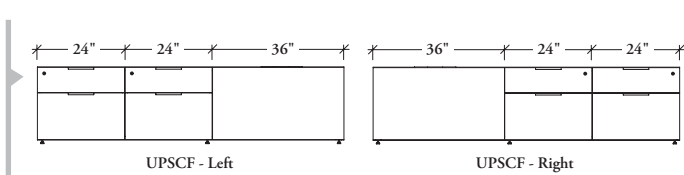

84" Width - Open with Drawer (P)

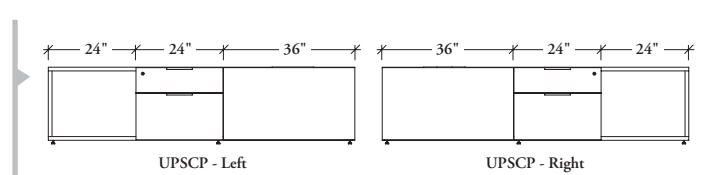

Parallel Corridor Credenza for Height-Adjustable Table (UPCC)

48" Width - Full Drawer (F)

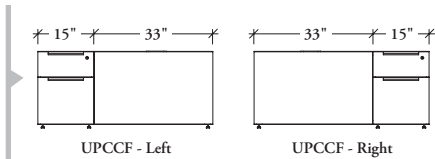

60" Width - File with Hinged Door (H)

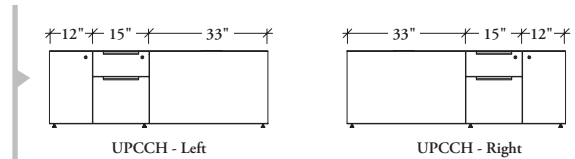

54" Width - Full Drawer (F)

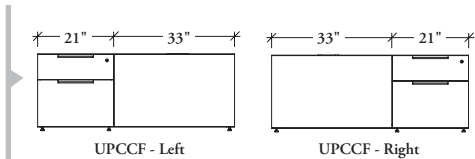

planning with credenzas for height-adjustable tables

When planning with credenzas for height-adjustable tables, the following should be taken into consideration.

planning with credenzas perpendicular to the panel spine

Credenzas and height-adjustable tables can be planned in the following configurations.

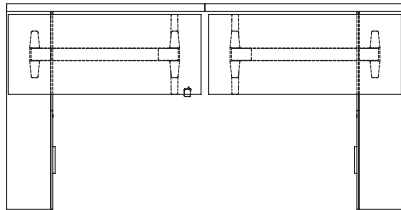

Navigate or hiSpace height-adjustable tables with credenzas and freestanding panels along spine.

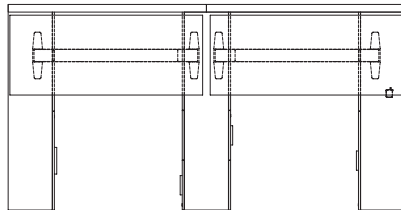

Navigate or hiSpace height-adjustable tables with credenzas attached to fixed panels along the spine.

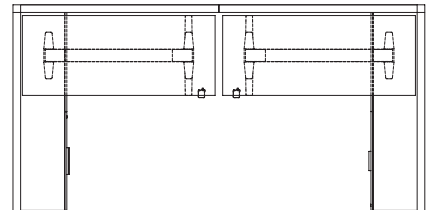

Navigate or hiSpace height-adjustable tables with credenzas attached to freestanding panels and fixed return panels.

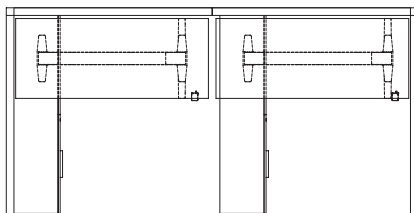

Navigate or hiSpace height-adjustable tables with credenzas attached to fixed panels and freestanding panels along the corridor.

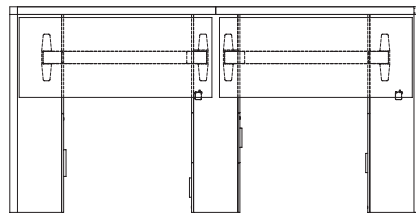

Navigate or hiSpace height-adjustable tables with credenzas attached to fixed panels.

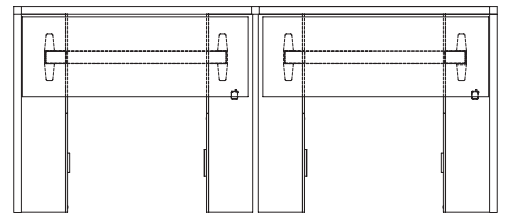

Navigate or hiSpace height-adjustable tables with credenzas attached to fixed panels.

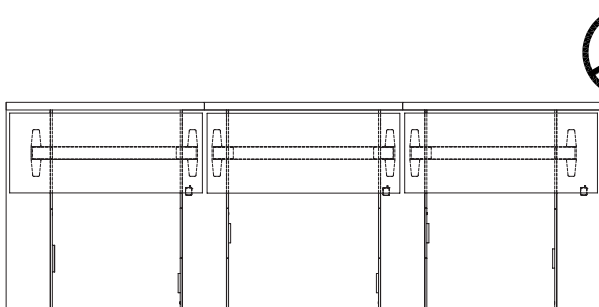

Navigate or hiSpace height-adjustable tables cannot be planned in three-packs of shared credenzas.

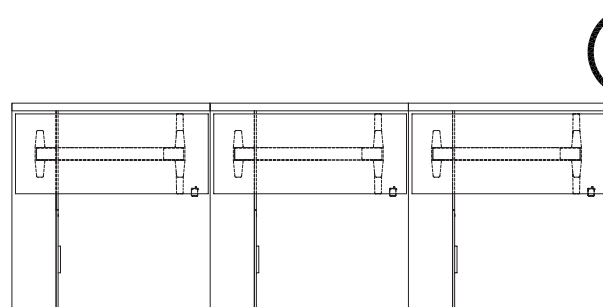

This is an alternative planning solution for a run of three height-adjustable workstations and perpendicular credenzas



planning with credenzas for height-adjustable tables (continued)

planning with credenzas parallel to panel spine

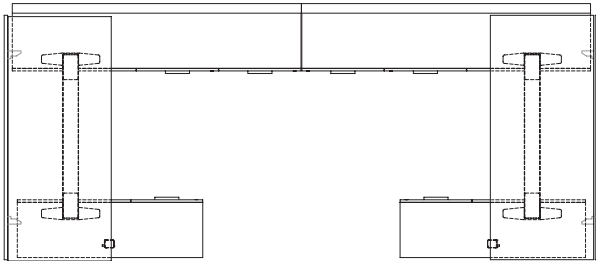

Navigate or hiSpace height-adjustable tables wrapped with screens will allow for the required gaps.

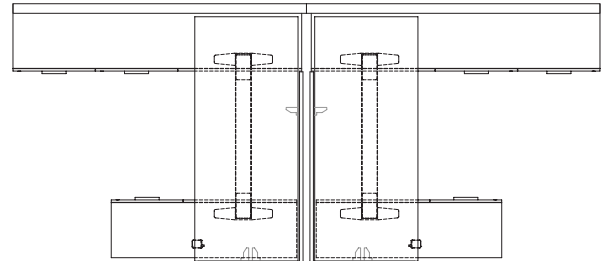

Back-to-back Navigate or hiSpace height-adjustable tables wrapped with screens will allow for the required gaps.

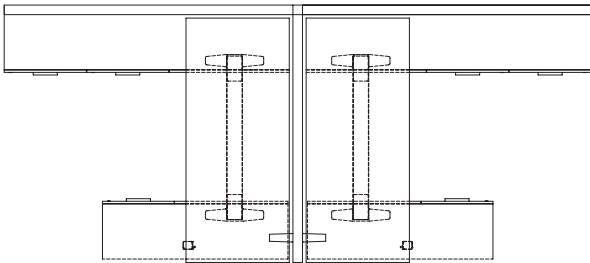

Back-to-back Navigate or hiSpace height-adjustable tables with a freestanding panel will allow for the required gaps.

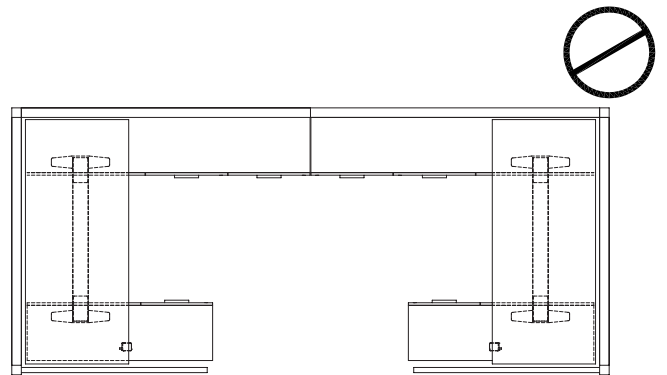

Panels wrapped around Navigate or hiSpace height-adjustable tables will not allow for the required 1" gaps.

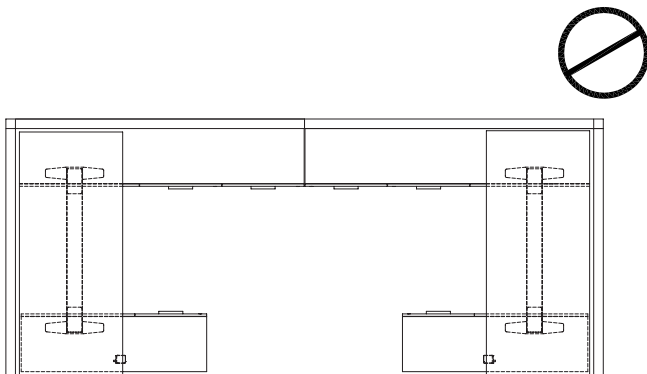

Return panels off of the spine cannot attach to a Parallel Corridor Credenza for Height-Adjustable Table (UPCC) or Navigate or hiSpace height-adjustable table.

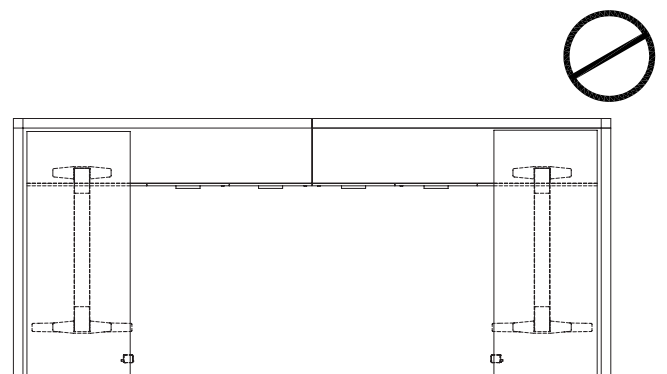

Freestanding panels are unable to attach to Navigate or hiSpace height-adjustable tables.

planning with credenzas for height-adjustable tables (continued)

stackers

The width of the storage section on a height-adjustable credenza will vary depending on the overall width of the credenza. District stackers are available in widths to match the width of the storage section of each credenza.

The following is recommended if stacker widths are to match with Perpendicular Credenzas for Height-Adjustable Tables (UPPC).

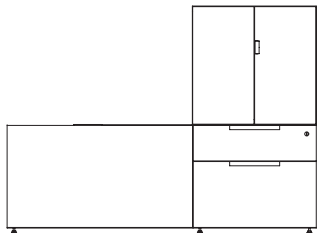

60" wide credenza with 24" wide stacker
(Full drawer right shown)

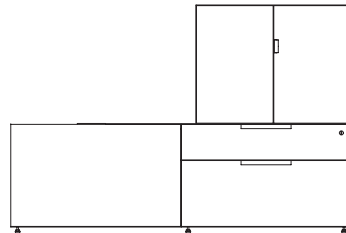

66" wide credenza with 30" wide stacker
(Full drawer right shown)

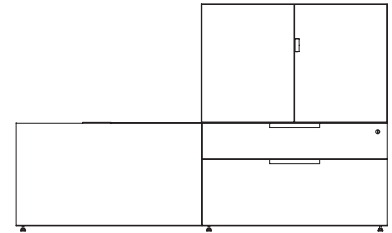

72" wide credenza with 36" wide stacker
(Full drawer right shown)

The following is recommended if stacker widths are to match with Shared Perpendicular Credenzas for Height-Adjustable Tables (UPCS).

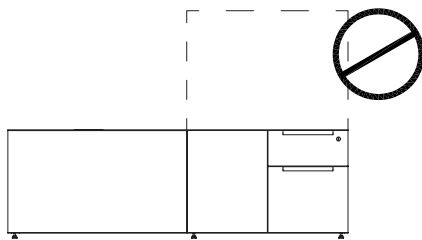

66" wide credenza with 36" wide stacker
(Full drawer right shown)

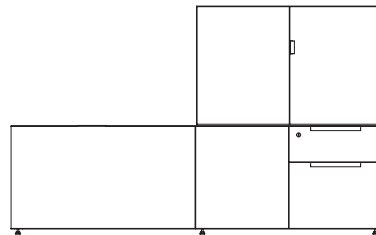

72" wide credenza with 36" wide stacker
(File with hinged door right shown)

The following is recommended if stacker widths are to match Parallel Spine Credenzas for Height-Adjustable Tables (UPSC).

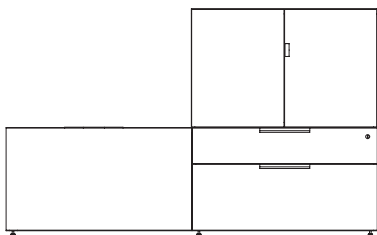

72" wide credenza with 36" wide stacker
(Full drawer right shown)

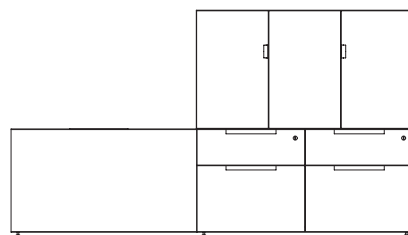

78" wide credenza with 42" wide stacker
(Full drawer right shown)

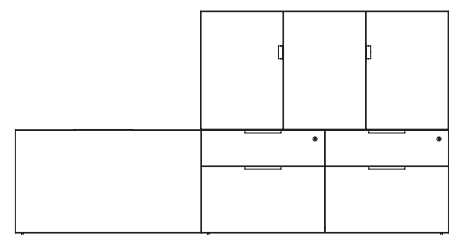

84" wide credenza and 48" wide stacker
(Full drawer right shown)

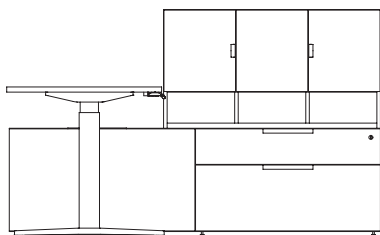

Always ensure there is a minimum 1" gap between Height-Adjustable table and stackers to avoid any pinch points.

planning with credenzas for height-adjustable tables (continued)

electrics and credenzas for height-adjustable tables

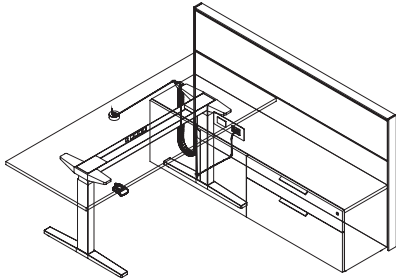

- Parallel Spine Credenzas for Height-Adjustable Tables (UPSC) are the only credenzas that can be specified with a cut out in the back
- The grommet into the Vertical Wire Carrier and then to the credenza to power box in panel

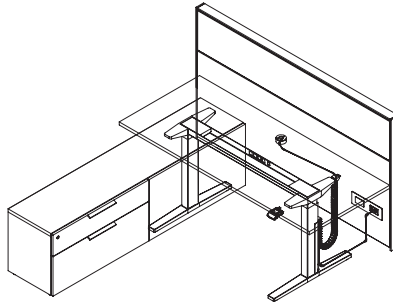

- Perpendicular Credenzas for Height-Adjustable Tables (UPPC) do not have the option of specifying a cut out
- Wires will be routed through the grommet to the power box in the panel

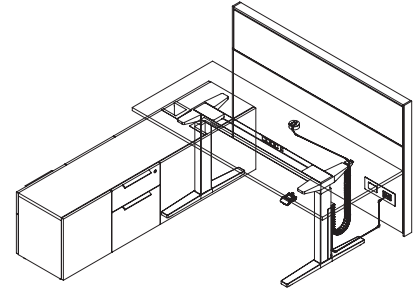

- Shared Perpendicular Credenzas for Height-Adjustable Tables (UPCS) do not have the option of specifying a cut out
- Wires will be routed through the grommet to the power box in panel

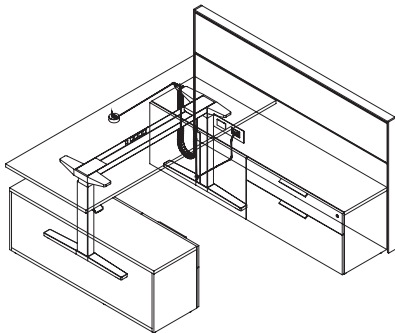

- Parallel Corridor Credenzas for Height-Adjustable Tables (UPCC) do not have the option of specifying a cut out
- There is no option to specify a Vertical Wire Carrier
- Wires will be routed through the grommet through to the Parallel Spine Credenza for Height-Adjustable Table (UPSC)

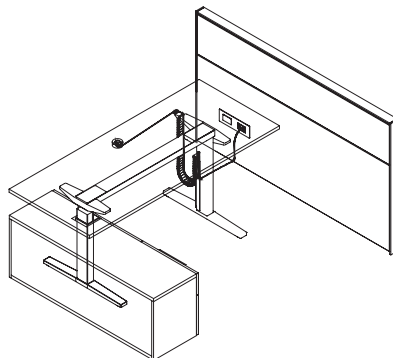

- If Parallel Corridor Credenzas for Height-Adjustable Tables (UPCC) are specified without a Parallel Spine Credenza for Height-Adjustable Table, a Vertical Wire Carrier (YEEE) should be specified separately
- Vertical Wire Carrier (YEEE) is available from Complements: *Teknion's Ergonomics & Accessories Program*. For more information, please see the *Applications Guidelines* section.

planning with credenzas for height-adjustable tables (continued)

fascias

When specifying fascias on District panels to accommodate power, it is important to consider the location of the fascia with cut out to avoid interference with the height-adjustable table and/or credenza.

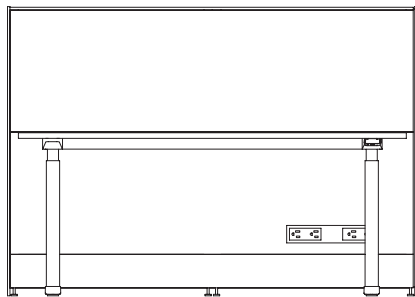

51" high District Panel with Fascias for Freestanding District with Power/Communication cut out bottom.

There is no interference with power cables plugged into the power box on the panel.

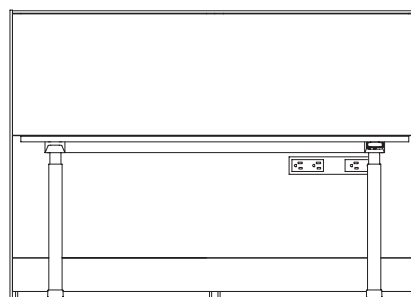

51" high District Panel with Fascias for Freestanding District with Power/Communications cut out top.

Location will cause interference with power cables plugged into the power box on the panel.

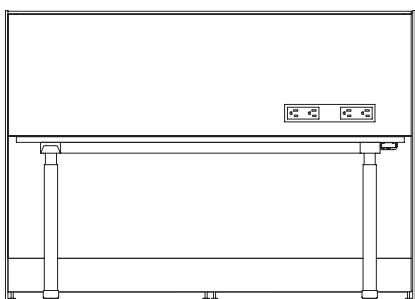

51" high District Panel with Fascias for Freestanding District with Power/Communications cut out Bottom

Location will cause interference with power cables plugged into the power box on the panel.

height-adjustable tables with screens overview

District Screens can be planned with height-adjustable tables and credenzas in both parallel and perpendicular applications.

perpendicular planning with height-adjustable tables and screens

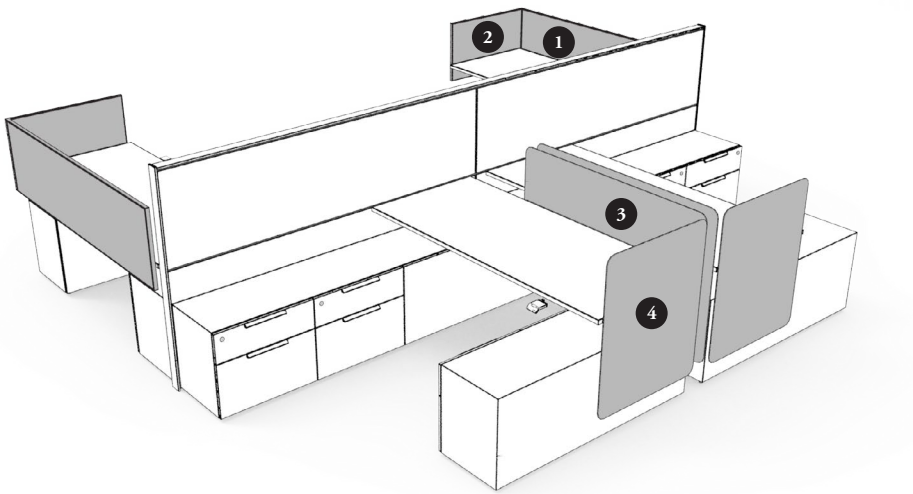

- 1 Framed Fabric Desk Edge Screen (GYDD)
- 2 Framed Fabric Side Desk Edge Screen (GYSD)
- 3 Infinity Desk Edge Screen (GXDD)
- 4 Infinity Side Desk Edge Screen (GXSD)

parallel planning with height-adjustable tables and screens

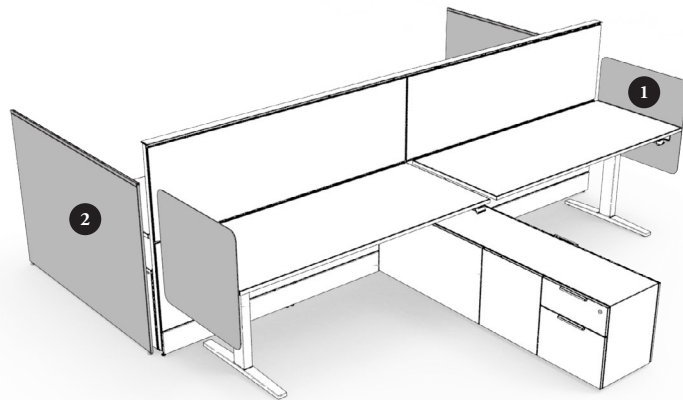

- 1 Infinity Side Desk Edge Screen (GXSD)
- 2 Storage Screen (UNSSS)

planning with height-adjustable tables and screens

The following should be considered when planning with navigate height-adjustable tables and screens.

The following chart outlines the screens that can be used with height-adjustable tables when planning perpendicular to the panel spine

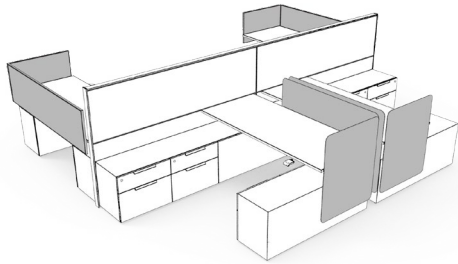

Screen Type	Perpendicular Planning
ALL Desk Edge Screens	✓
Curved Desk Edge Screens	✓
Desktop Casual Screen	✓
HAB Study Carrel	
Modesty Screens	✓
ALL Desk Edge Floor Screens	
Storage Screens	
Lateral Floor Screens	
Desktop Lateral Screens	
Glass Desk Edge Screens	

✓ Applicable

The following chart outlines the screens that can be used with height-adjustable tables when planning parallel to the panel spine

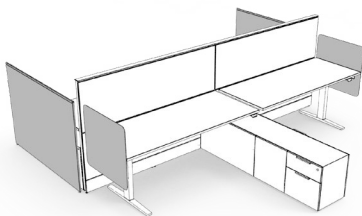

Screen Type	Parallel Planning
ALL Desk Edge Screens	
Curved Desk Edge Screens	
Desktop Casual Screen	✓
HAB Study Carrel	
Modesty Screens	
ALL Desk Edge Floor Screens	
Storage Screens	✓
Lateral Floor Screens	
Desktop Lateral Screens	✓
Glass Desk Edge Screens	

✓ Applicable

planning with height-adjustable tables and screens (continued)

gapping

When planning with screens on perpendicular worksurfaces, ensure that there are proper pinch gaps between credenzas and screens.

The cut out is wide enough to accommodate various planning configurations.

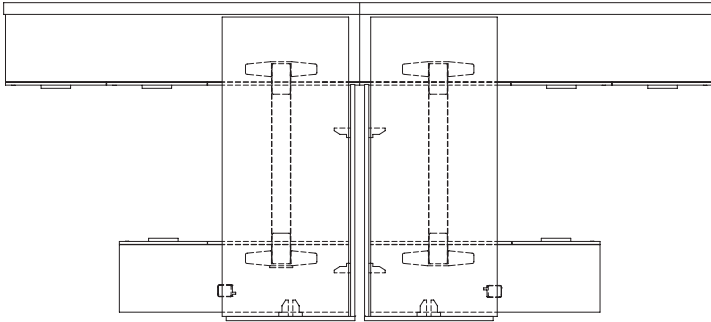

Height-adjustable table can shift back 3" to allow for the recommended pinch gap when specifying desk edge screens in face-to-face applications.

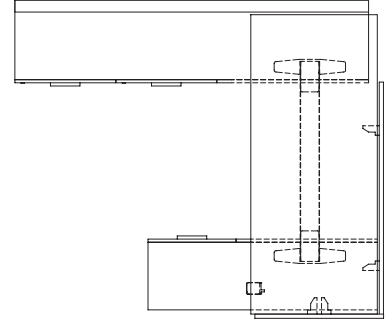

Height-adjustable table can shift forward to allow for screen to overlap credenza.

When specifying screens attached to height-adjustable tables, there should always be a 1" gap to avoid pinch points.

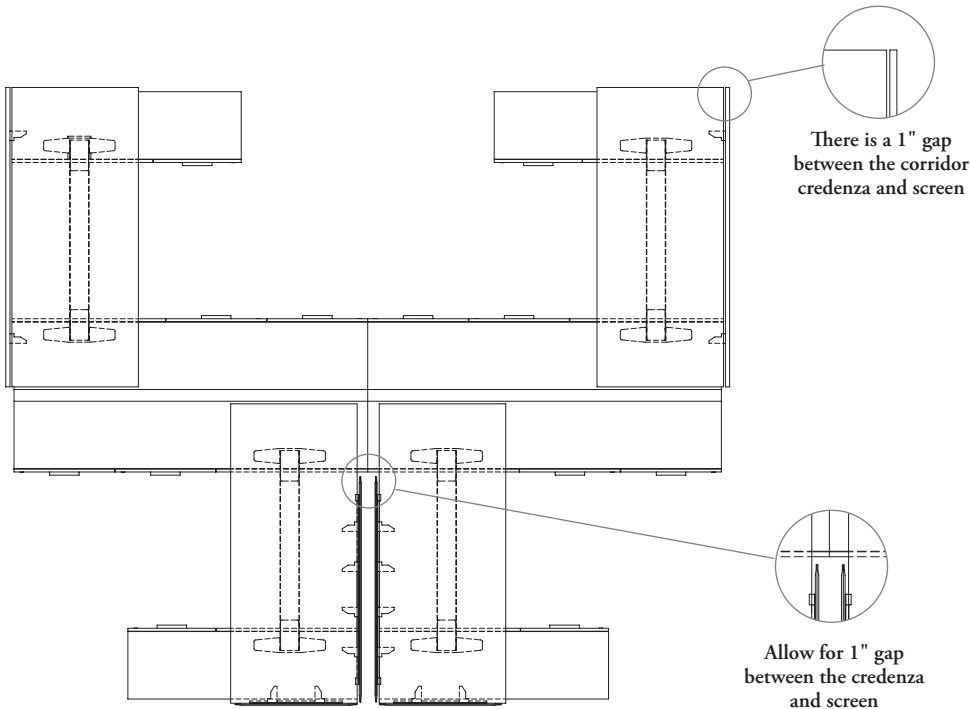

planning with navigate height-adjustable tables and screens (continued)

desk edge screens

The following screen types can be specified on height-adjustable tables, either full or partial width:

- Desk Edge Screen (UNSD E)
- Infinity Desk Edge Screen (GXDD)
- Framed Fabric Desk Edge Screen (GYDD)

Glass screens should not be used on height-adjustable tables.

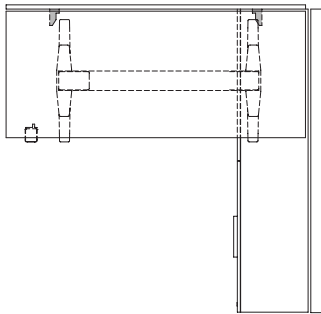

Desk Edge Screens can span entire width of work surface.

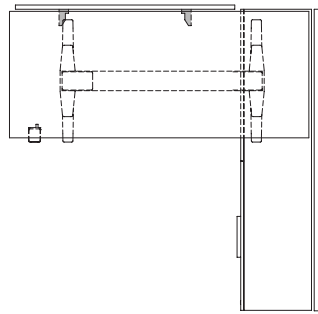

Height-adjustable tables can be pushed back in spine credenza with Desk Edge Screens spanning only part of the width of the work surface.

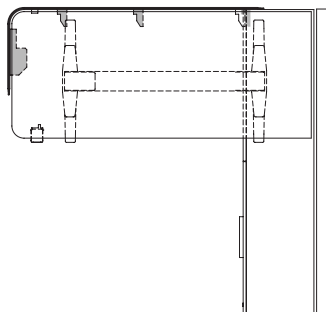

Infinity Curved Desk Edge Screen (GXCD) can span along the front edge of the work surface.

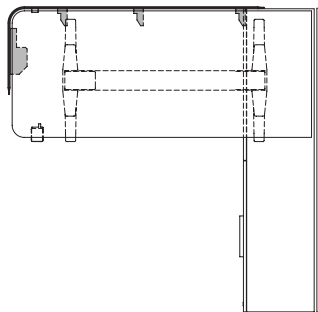

Height-adjustable tables can be pushed back in spine credenza with Infinity Curved Desk Edge Screen (GXCD) screen spanning only part of the work surface.

side desk edge screens

The following screen types can be specified on height-adjustable tables with T-Legs:

- Framed Fabric Side Desk Edge Screen (GYSD)
- Infinity Side Desk Edge Screen (GXSD)

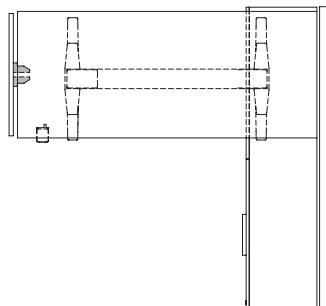

Side Desk Edge Screen on a Navigate Height-Adjustability Built-in Base - Perpendicular Planning with T-Legs.

planning with navigate height-adjustable tables and screens (continued)

curved infinity desk edge screens

Curved Infinity Desk Edge Screens are available with and without wire management.

The option of no wire management must be specified if there is a Parallel Corridor Credenza for Height-Adjustable Table (UPCC) with a Curved Infinity Desk Edge Screen (GXCD).

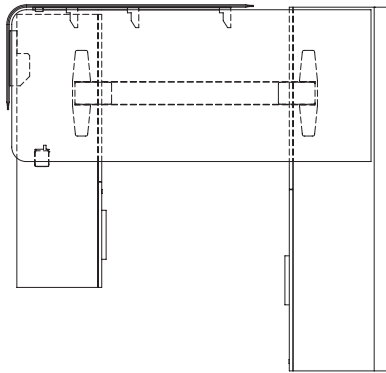

No wire management.

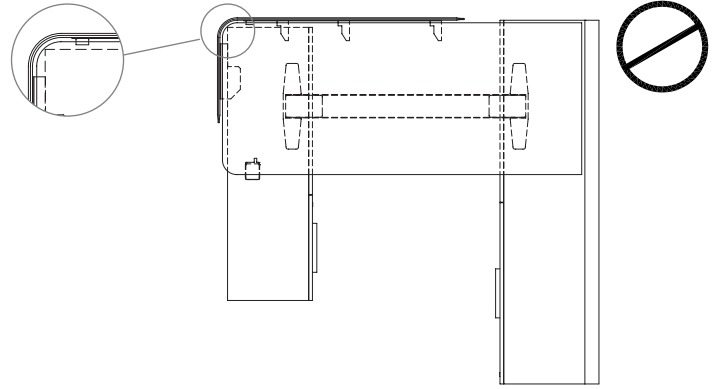

Wire management interferes with credenza if Height-adjustable table is moved up/down.

modesty screens

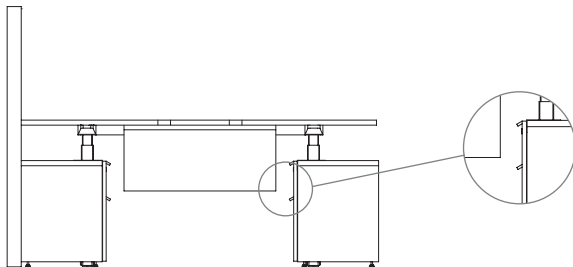

Allow minimum 1" gap between Modesty Screen (UNSM) and credenzas.

When planning with modesty screens, there could be interference with cut outs and credenzas for height-adjustable tables.

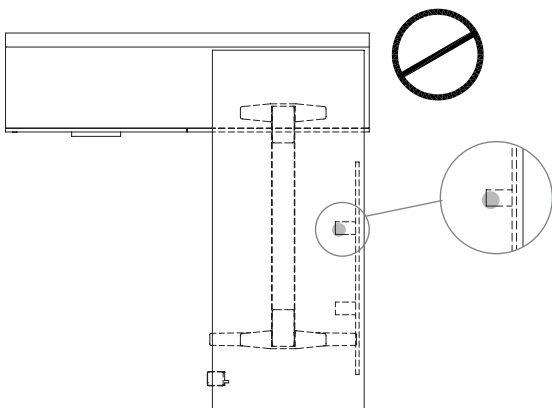

Modesty panel interferes with cut out when centered between the edge of the worksurface and credenzas.

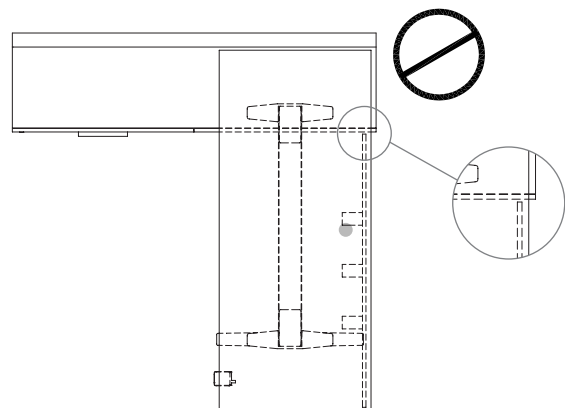

There is a 1" pinch gap between the modesty panel and credenza. There is interference between the modesty panel and cut out.

planning with navigate height-adjustable tables and screens (continued)

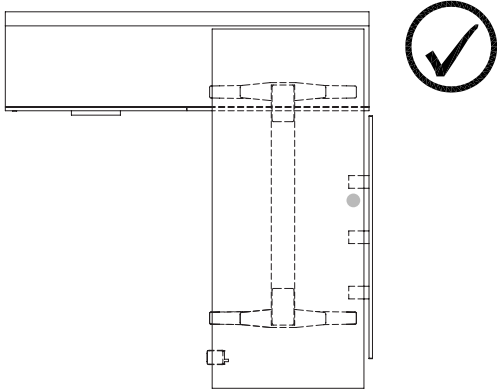

Modesty panel is centered on the worksurface and does not interfere with cut out.

planning with navigate height-adjustable tables and screens (continued)

lateral screens

All lateral screens can only be planned with height-adjustable worksurfaces that are parallel to the panel spine.

- Lateral screens have nominal depths and can be specified to parallel worksurfaces.
- Actual depths of lateral screens are:
 - 24" deep is 23" deep
 - 30" deep is 29" deep
 - 36" deep is 35" deep

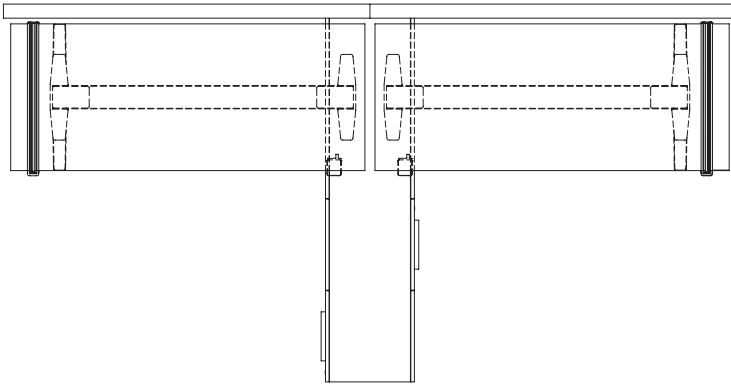

Parallel Rectangular Height-Adjustable Built-In Worksurfaces (WHD) can accommodate all lateral screens.

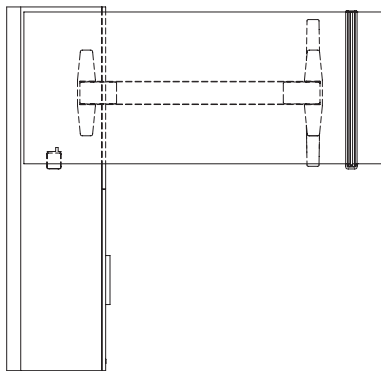

When specifying a lateral screen on a Height-Adjustable Built-in Gable Base - Parallel Planning (YHD), the screen must be inserted so it does not interfere with the base.

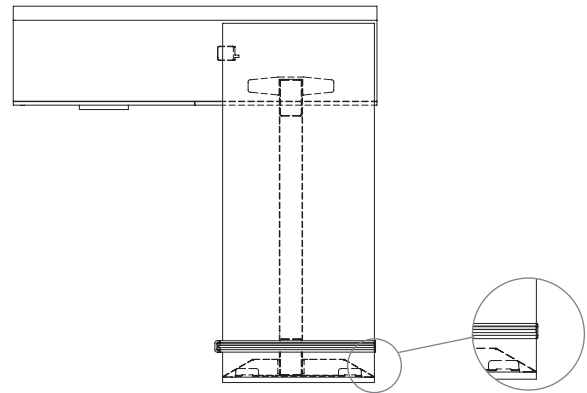

Lateral screen depths are 29" and **cannot** be planned with 30" deep Perpendicular Rectangular Height-Adjustable Built-In Worksurfaces.

height-adjustable credenza lock chart

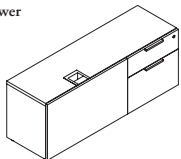
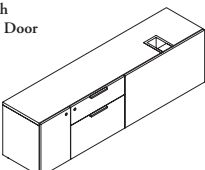
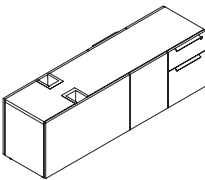
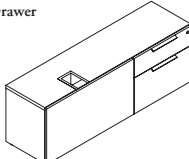
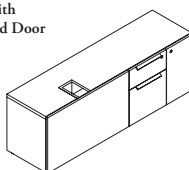
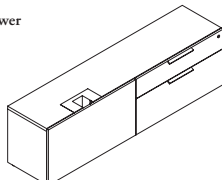
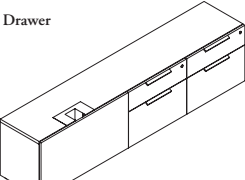
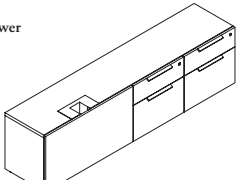
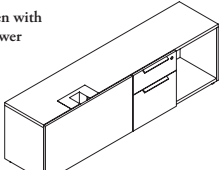
	number of locks		number of locks		number of locks
<p>Full Drawer</p>  <p>Line 1</p> <p>File with Hinged Door</p>  <p>UPPC</p>	1 x	 <p>UPCS</p>	2 x	<p>Full Drawer</p> 	1 x
	2 x				<p>File with Hinged Door</p>  <p>UPCC</p>
<p>Full Drawer 72"</p> 	1 x	<p>Full Drawer 84"</p> 	2 x		
<p>Full Drawer 78"</p>  <p>UPSC</p>	2 x	<p>Open with Drawer</p>  <p>UPSC</p>	1 x		

storage

storage

UNDERSTANDING STORAGE	219
UNDERSTANDING DISTRICT STORAGE	220
PEDESTAL BASICS	225
PLANNING WITH PEDESTALS	226
STRETCH PEDESTAL & LATERAL FILE STORAGE BASICS	227
PLANNING WITH STRETCH PEDESTALS	228
PLANNING WITH LATERAL FILES	229
BOOKCASE BASICS	230
CREDENZA BASICS	231
CREDENZA DRAWER WIDTHS	239
PLANNING WITH CREDENZAS	243
STACKER BASICS	246
PLANNING WITH STACKERS	248
SINGLE LOCKER BASICS	250
PLANNING WITH SINGLE LOCKERS	252
DUAL, TRIPLE & QUAD LOCKER BASICS	254
PLANNING WITH LOCKERS	255
CUBBY LOCKER BASICS	256
TOWER BASICS	257
PLANNING WITH TOWERS	262
PEDESTAL TOWER BASICS	264

storage

storage (continued)

PLANNING WITH PEDESTAL TOWERS	266
STORAGE-TO-STORAGE SUPPORT BASICS	267
OVERHEAD BASICS	268
PLANNING WITH OVERHEAD CABINETS	269
CENTERMOUNT OVERHEAD BASICS	271
PLANNING WITH CENTERMOUNT OVERHEAD CABINETS	272
SIDE FILER & MINI SIDE FILER BASICS	274
PLANNING WITH SIDE FILERS	275
PLANNING WITH MINI SIDE FILERS	278
PLANNING WITH SIDE FILERS & MINI SIDE FILERS	279
PLANNING WITH SIDE FILER, MINI SIDE FILER & USB POWER	281
ACCESSORY BUNDLE BASICS	284
GRAIN DIRECTION	285
LOCK CHART	290

District storage is available in a variety of formats, from pedestals, to stackers and lockers. The following outlines the various storage options available.

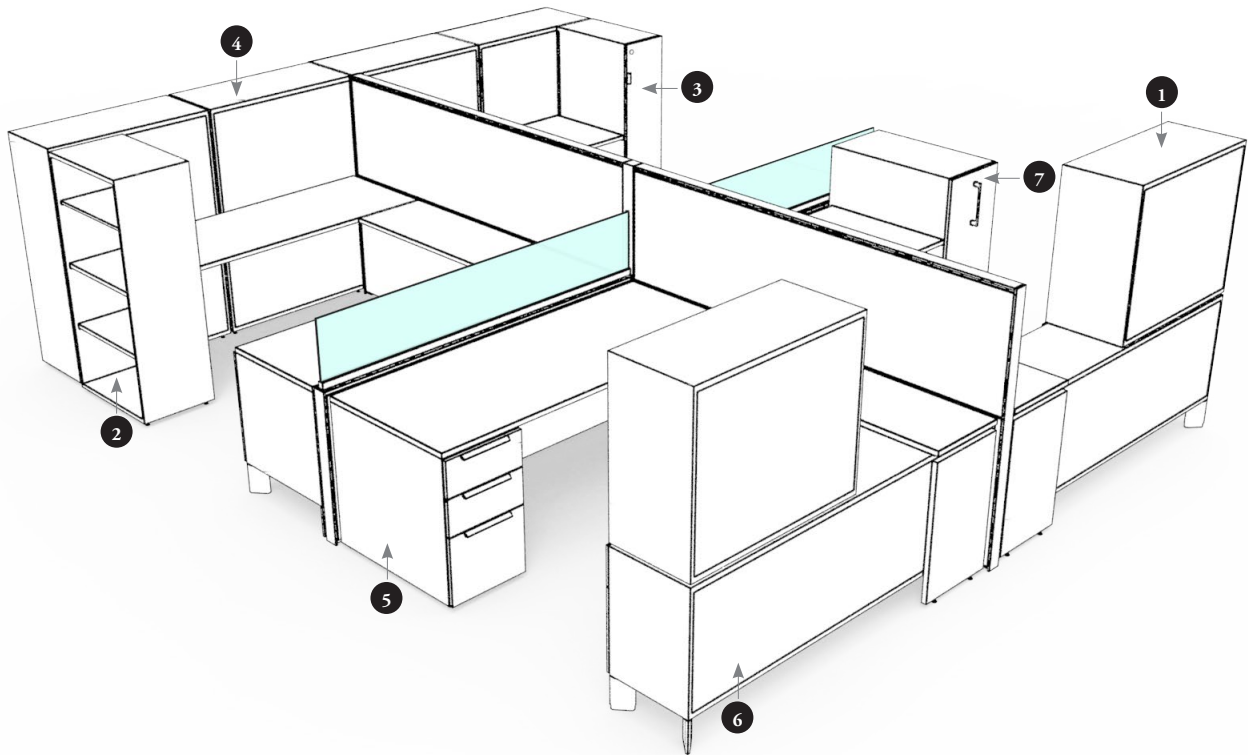

- 1 **Stackers** stack onto other base storage units and can face the same direction as the base, or opposite directions.
- 2 **Bookcases** are available to maximize open storage.
- 3 **Lockers** provide coat and shelf storage in a variety of configurations including with cubbies, with solid backs, dual, triple and quad lockers, front or side closet locations and mail slots.
- 4 **Towers** combine coat storage, box and file and open compartments in front and side locations.
- 5 **Undersurface storage** includes pedestals with solid backs and cubbies, rolling pedestals, stretch pedestals, single lockers and credenzas.
Lateral files are available 36" and 42" high when higher storage is required.
- 6 **Credenza** options include full drawer, open, and open with drawer hinged door, or sliding door combinations.
- 7 **Side Filers** provide coat and shelf storage, along with optional USB power and accessories.

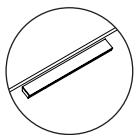

District Handle Pull

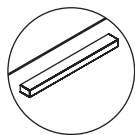

Rectangular Handle Pull

Finishes

- All storage is available in Laminate, Flintwood and Wood Veneer finishes
- When Laminate case is specified, the sides and back of the cabinets will both be Laminate, and the fronts can be Laminate or Flintwood
- Laminate cases are **not** available on 96" wide
- When Flintwood or Veneer cases are specified, the backs and fronts can all be different wood finishes, the fronts **cannot** be Laminate
- Handles are available in Foundation, Mica and Accent. Feet are available in Storm White (Q), Platinum (7), Very White (V), Anthracite (X), Graphite (M) and Burnished Bronze (2)
- Grommets are finished in Platinum
- Glass is available in Frost or back-painted glass in various colors

understanding district storage

District storage can be planned as space division, panel or worksurface support, or in a more conventional manner where it is incorporated into panel environments. A wide variety of finish protocols are available to suit different planning styles and budgets. District storage also lends itself to integration with the Teknion Leverage system.

topography



- In conventional planning, panels tend to be one height and the storage is contained within the station

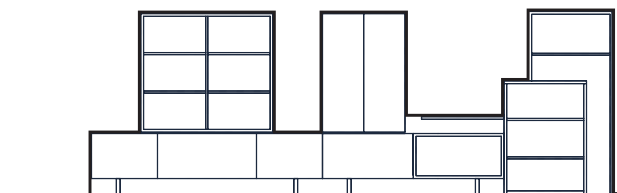

- District typically uses storage to provide space division, offering a varied workspace topography. The line of site can be varied to allow open spaces with different shapes and sizes

district storage styles

- District is available in three different styles and each provides a different function, and varying levels of power and communication access

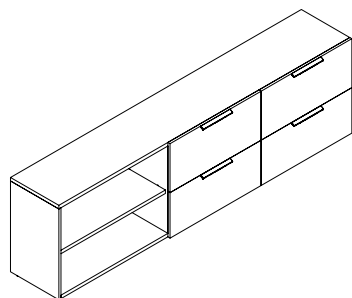

- Standard Storage has levelers only which allow case to sit 1" above floor height. Power and communications **cannot** be passed through it

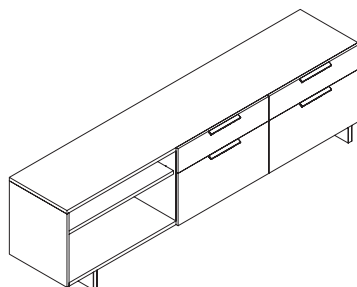

- Elevated Storage with District Feet provides a lighter aesthetic by raising the storage 6" off the floor
- Available on 19" deep credenzas only
- Power and data communications **cannot** be passed through the storage

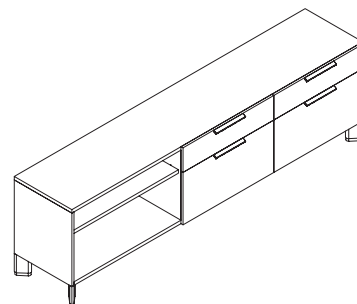

- Elevated Storage with Angled Feet provides the most options and flexibility. The legs are on the corners, allowing a power and communications channel to pass along the bottom of the storage to provide power in the storage at either belt line or base level

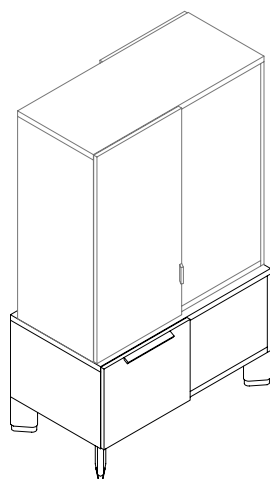

- Shared storage within workstations allows room for collaboration as well as space division
- Allows for planning in smaller spaces more accommodating to storage
- Power and data communications **cannot** be passed through the storage

understanding district storage (continued)

storage depths

- Storage is available in varying depths to correspond with worksurface depths, create stackable spine storage, or for an increased sense of spaciousness in small workstations

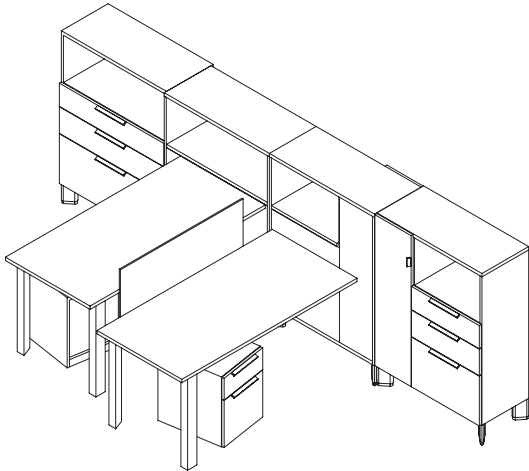

- Storage in depths of 16" allows for cabinets to be stacked flush in spine planning applications

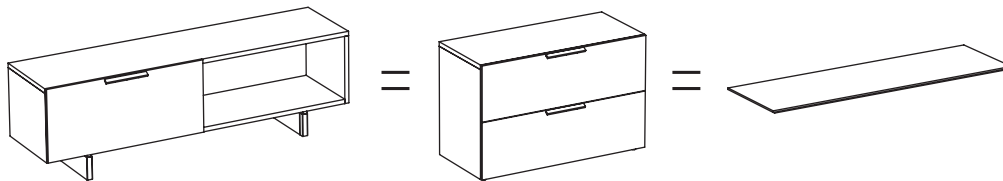

- Credenzas, files and worksurfaces in 19" depths allow worksurfaces to be layered over the storage

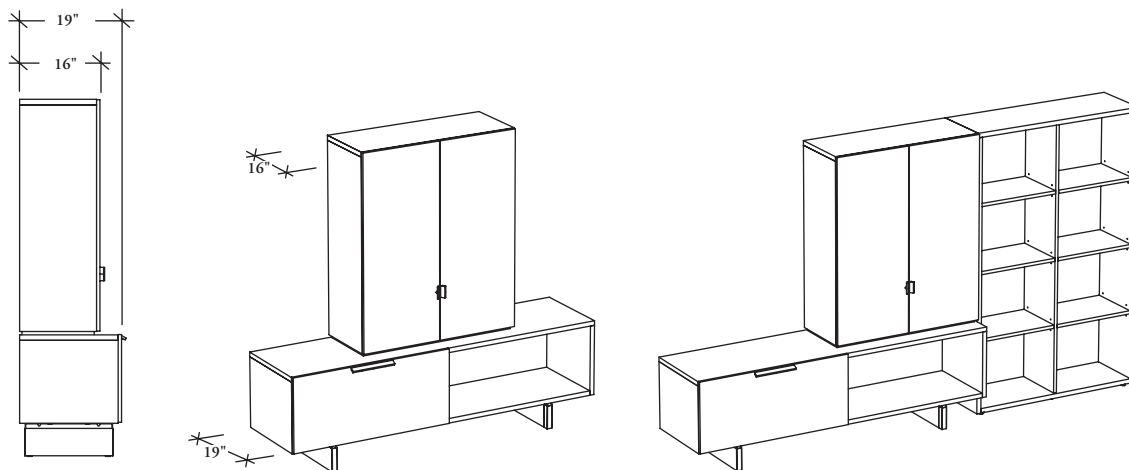

- Depths can be varied, to create a furniture look and feel and an increased sense of spaciousness in a workstation

understanding district storage (continued)

secure and accessible areas

- District storage includes secure or enclosed and accessible areas to allow for a variety of storage options. Backs can also be open or closed on some units to maximize flexibility

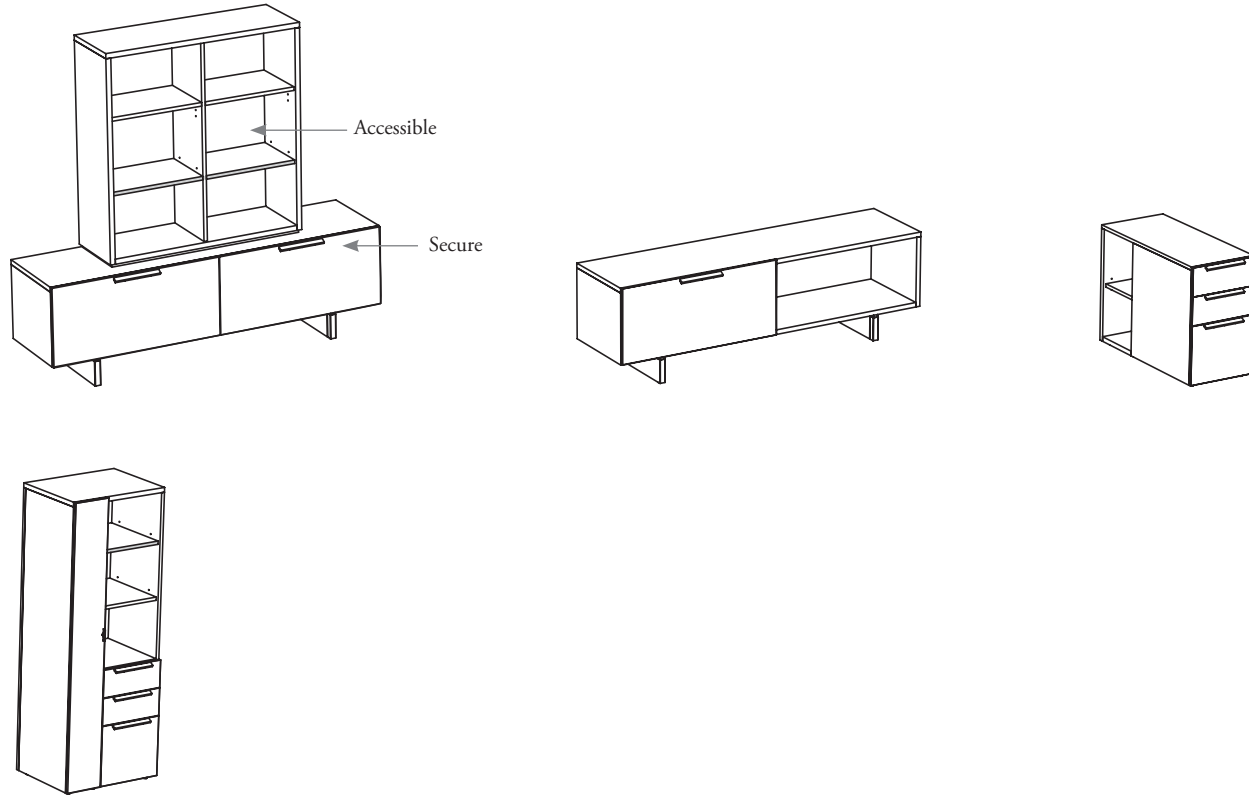

on- or off-module capability

- Storage can be stacked the full width of lower cabinets, or in off-module configurations

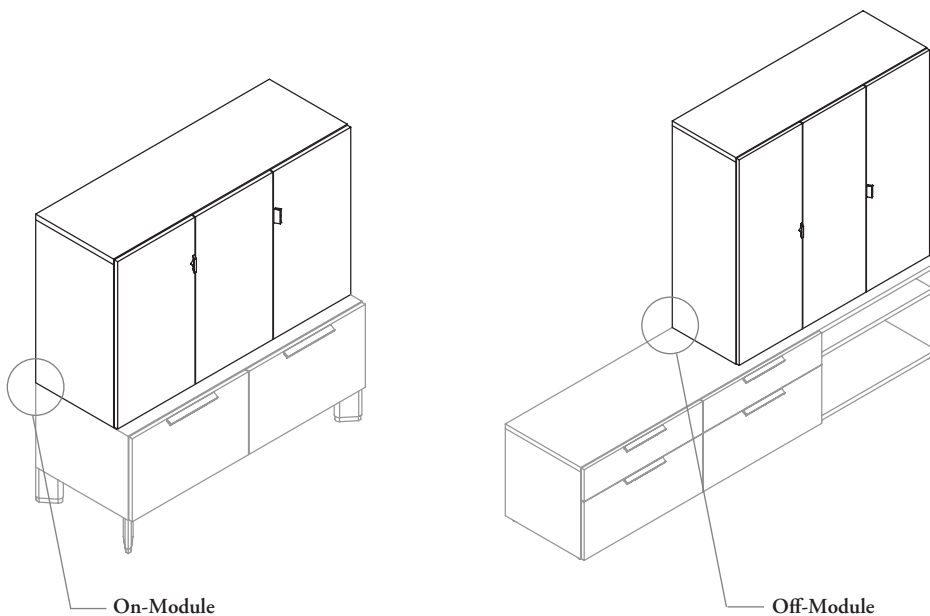

understanding district storage (continued)

maximized support

- Worksurface support has been maximized so that virtually any storage component can serve as support for worksurfaces (See *Supports* section for actual support brackets required)

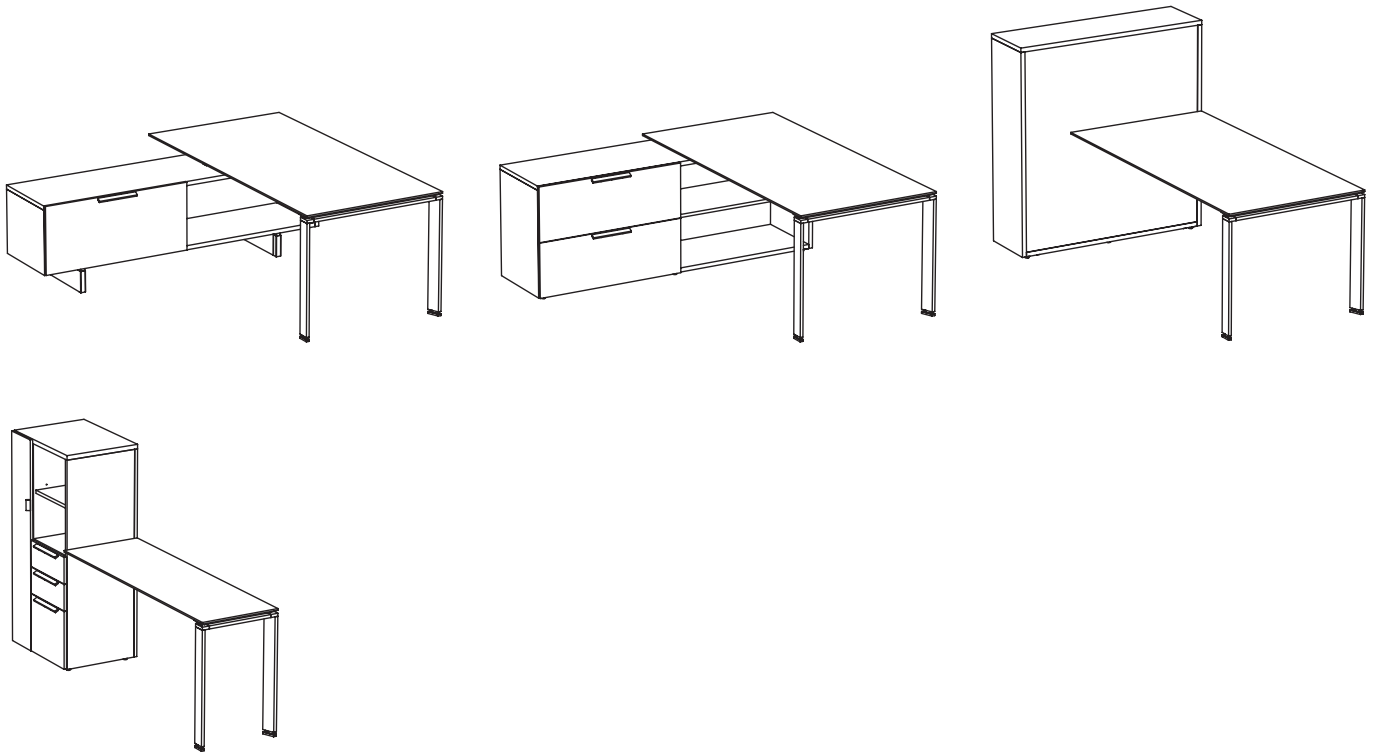

- Storage units that can attach to panels to provide support are complete with slots on the back to accept the support brackets. This allows for maximum flexibility because holes do **not** need to be drilled into the units exterior surface for mounting the brackets

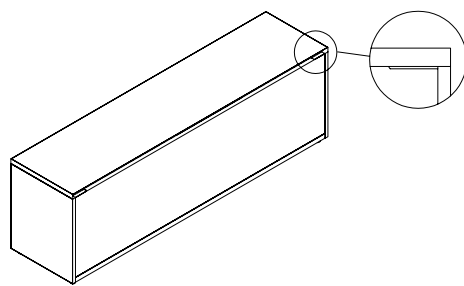

Credenza – Back View

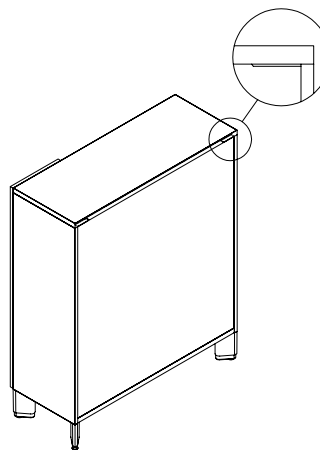

Combo Tower – Back View

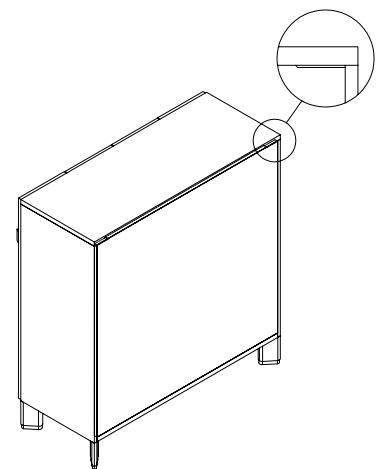

Quad Locker – Back View

understanding district storage (continued)

layering

- District provides the opportunity to layer worksurfaces over storage to allow for extra piling surfaces
- The amount of piling worksurface area is maximized by the gap between the shelf at 36" high, the worksurface at 29" high and the credenza at 21" high

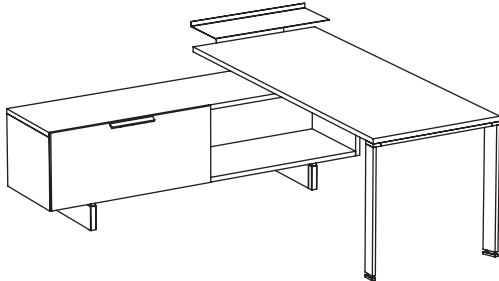

standard storage heights

- 1" of levelers are included in the total height of the storage (eg. If height is 51", actual height of the case is 50" and levelers, fully extended, make up 1")

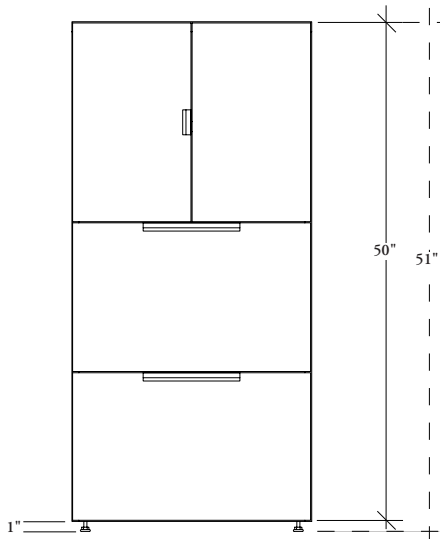

leveling range

standard storage

- The following storage units (UPFDS, UPSS, UFLS, ULDS, UHDS, UTLS, UTDD, UTW) will receive extended levelers (UNSXLB) which will allow the unit to be leveled 0.625" down and 0.375" up
- All other units will have a standard leveler which will allow for leveling 0.625" down and 0" up, but an extra kit of 2 x UNSXLA and 2 x UNSXLC will be included for on site replacement for extra leveling range up to +0.75"

elevated storage

- Leveling range of .5" down and 2.5" up

The following outlines the features of District Pedestals.

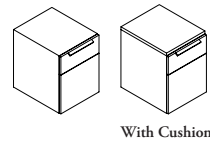
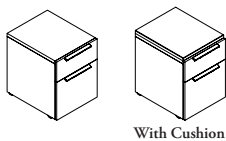
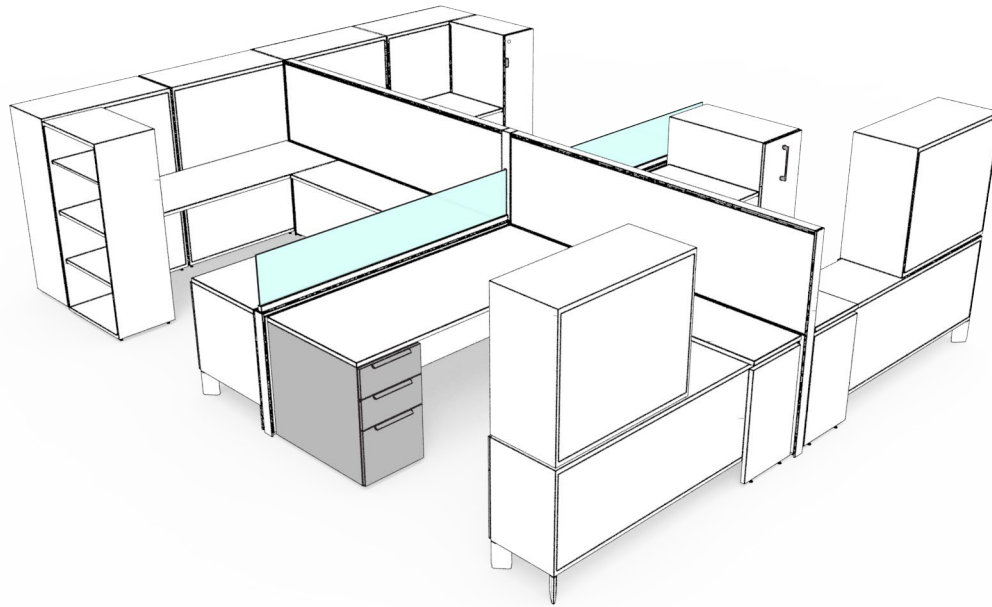

Rolling Pedestal (UPR)

- 21" high mobile box/file pedestal with option for a seat cushion allows for additional seating capability within a workstation
- Configuration box/file smooth slide option has a cut out in the back of the pedestal to allow it to clear the legs on a height-adjustable tables for a tighter fit
- Includes a pencil tray
- Available 19" deep and 16" wide

Rolling Pedestal with Box Drawer and Hinged Door (UPRB)

- 16" wide, 21" high solid back in 19" depth
- Option for seat cushion that allows for additional seating
- Two locks on the box drawer and one on the hinged door

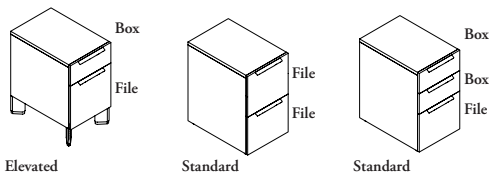

Pedestal with Solid Back (UPFD)

- 16" wide, 28" high solid back pedestal available in depths of 19", 23", 29" to match District worksurface depths
- Elevated style with angled leg configuration includes a box/file drawer, and the standard style is available with box/box/file or file/file drawer combinations
- Box/box/file and box/file combination includes a pencil tray

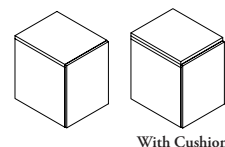

Rolling Pedestal with Hinged Door (UPRH)

- 16" wide, 21" high solid back in 19" depth
- Option for seat cushion that allows for additional seating
- Door swing direction can be determined by the location of the hinges on the door
- Hinged door is push latch, no handle required.

planning with pedestals

The following should be considered when planning with District Pedestals.

pedestals

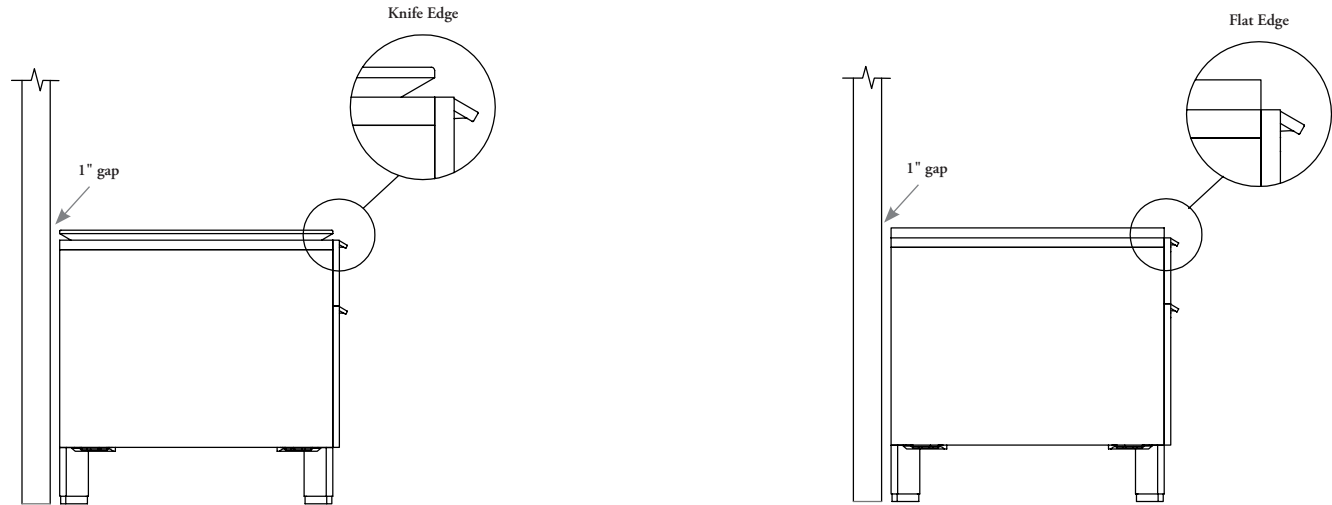

- District pedestal depths match the depth of District worksurfaces (19", 23", 29" and 35") to maintain the 1" gap at the back of the surface
- The body of the cabinet aligns with the District worksurface, and the drawer sits in front of the surface

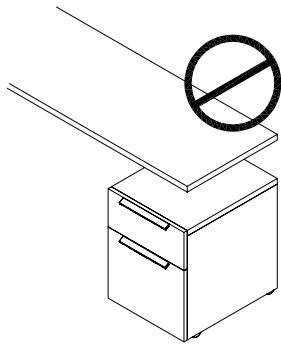

- The rolling pedestal **cannot** be used for support

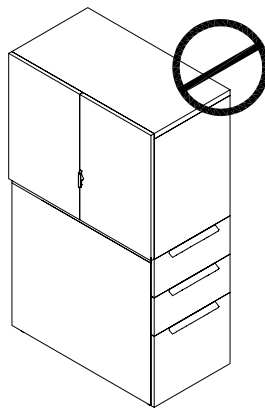

- Stackers **cannot** be stacked onto pedestals

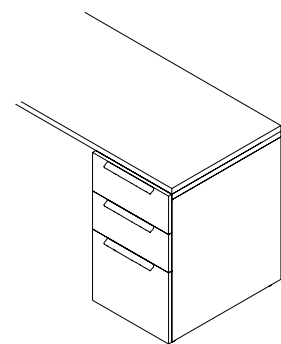

- The 28" high pedestal provides support to worksurfaces, but must be the same depth as the surface

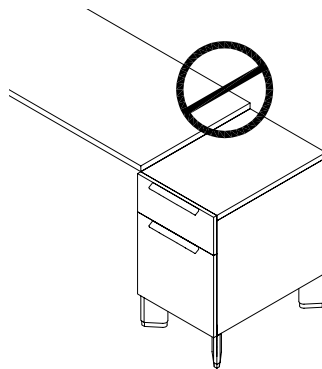

- Worksurfaces **cannot** be mounted off of the end of a pedestal – this condition will **not** provide adequate support

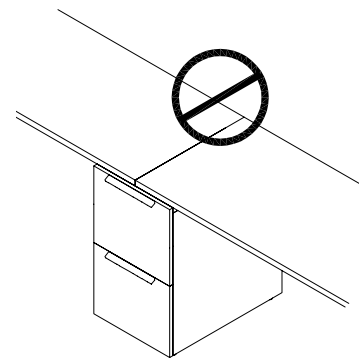

- A pedestal **cannot** be placed between two worksurfaces to provide support to the surfaces – They must be installed fully under one surface

stretch pedestal & lateral file storage basics

The following outlines the features of District Stretch Pedestals and Lateral File Cabinets.

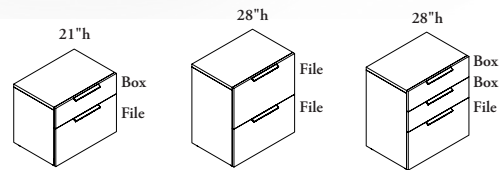
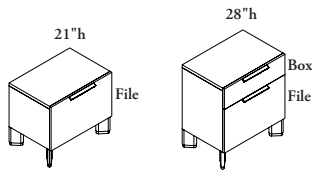
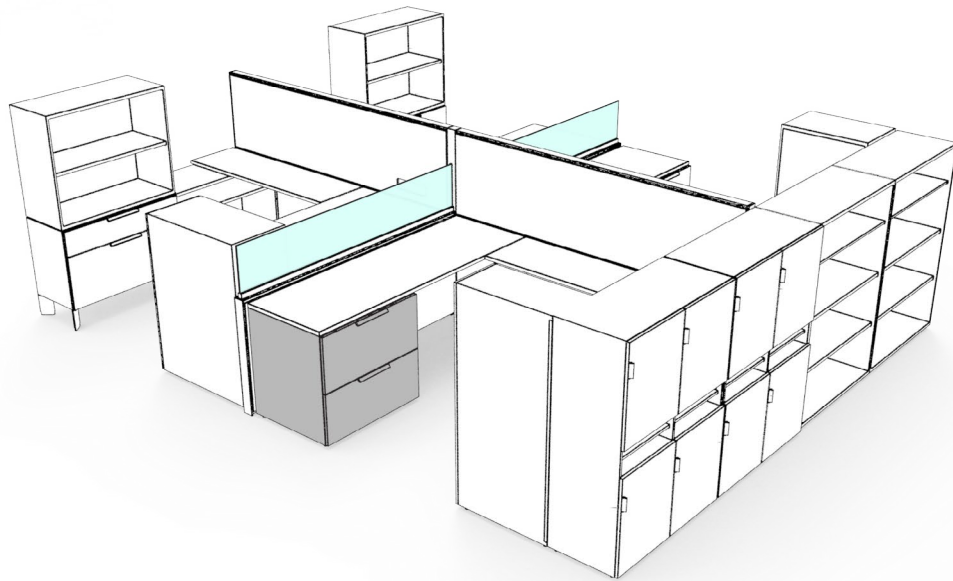

Stretch Pedestal – Elevated (UPSE)

- Takes the place of a two drawer high filing cabinet within a workstation but can be used outside of a station for two high filing
- Available 21" high with a single file drawer, or 28" high with a box/file drawer combination
- 21" high cabinet can be specified with an optional red drawer accessory insert if it is 19" deep
- Depths include 16", 19", 23", 29" to match standard worksurface depths
- Available in widths of 24", 30", 36"
- 16" deep pedestal does **not** provide full drawer extension
- 16" deep and 19" deep pedestals offer electrical cut out options for base back cut out

Stretch Pedestal – Standard (UPSS)

- 21" high cabinet is available with a box/file drawer combination and the 28" high cabinet is available with box/box/file drawer or file/file drawer combinations
- Available in the same depths and widths as the Stretch Pedestal – Elevated, but has no options for red drawer accessory inserts or electrical cut outs
- File/file drawer combination is available with individual locks on each drawer for shared address applications
- 16" deep pedestal does **not** provide full drawer extension

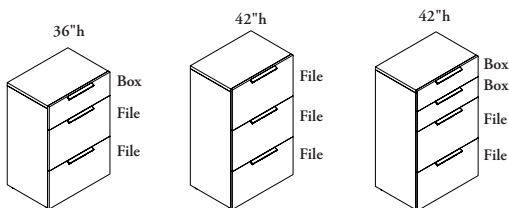

Lateral File – Standard (UFLS)

- 36" high cabinet is available with a box/file/file drawer combination and the 42" high cabinet is available with file/file/file and box/box/file/file drawer combinations
- 16" deep lateral file does **not** provide full drawer extension
- There is no option for individual locks or electrical cut outs

planning with stretch pedestals

The following should be considered when planning with District Stretch Pedestals.

filing drawer capacities

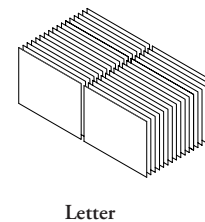
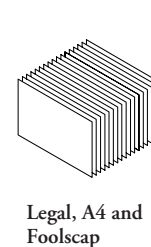
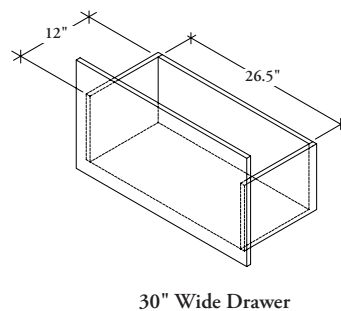
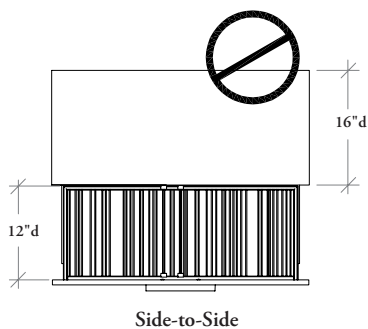
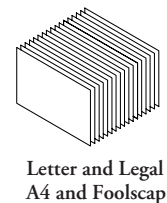
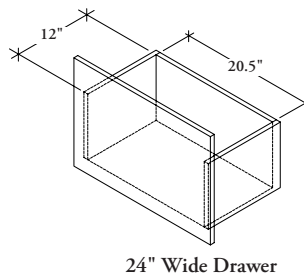
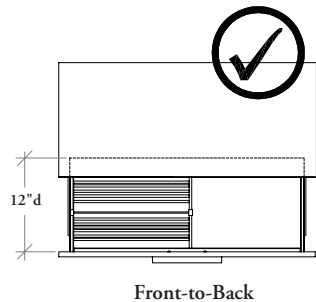

- 16" deep file drawers do **not** have full extension files
- Filing must be front-to-back **not** side-to-side
- On 24" width file drawers only one front-to-back filing section can be used (letter, legal, A4 or foolscap)
- On 30" width file drawers two front-to-back filing sections can be used (letter) or one filing section (legal, A4 or foolscap)
- On 36" width filing drawers, front-to-back filing sections can be used (letter, legal, A4 or foolscap)

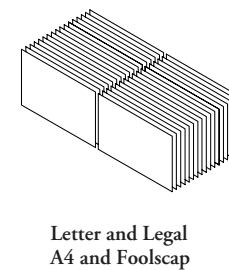
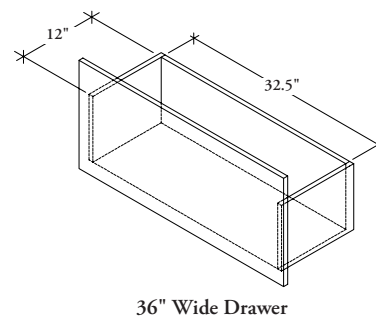

stretch pedestals

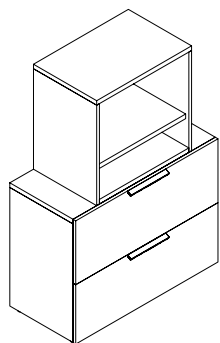

- Stackers can be stacked onto stretch pedestals

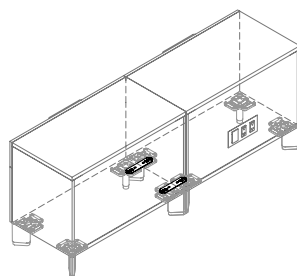

- When the flush mounted power and data unit is mounted into the back of a stretch pedestal a counterweight **cannot** be installed in the cabinet however, when electricians are used, the storage unit must be linked to another storage unit there by removing the need for a counterweight

planning with lateral files

The following should be considered when planning with District Lateral File Cabinets.

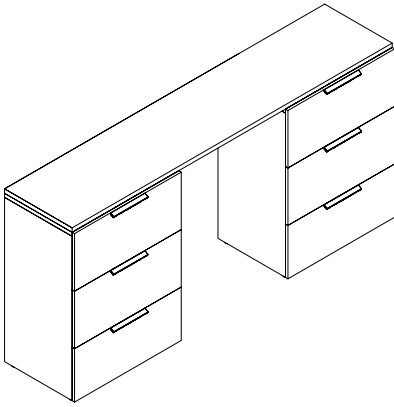

- A work surface can also be mounted over a three-high lateral file to create a counter height working space

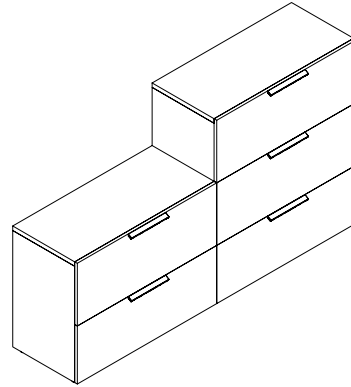

- Stretch pedestals and lateral files have matching datum lines and dimensions so can be planned side-by-side
- Stretch pedestals are only two-high in order to fit under a work surface
- Lateral files are three-high and higher

bookcase basics

The following outlines the features of District bookcases.

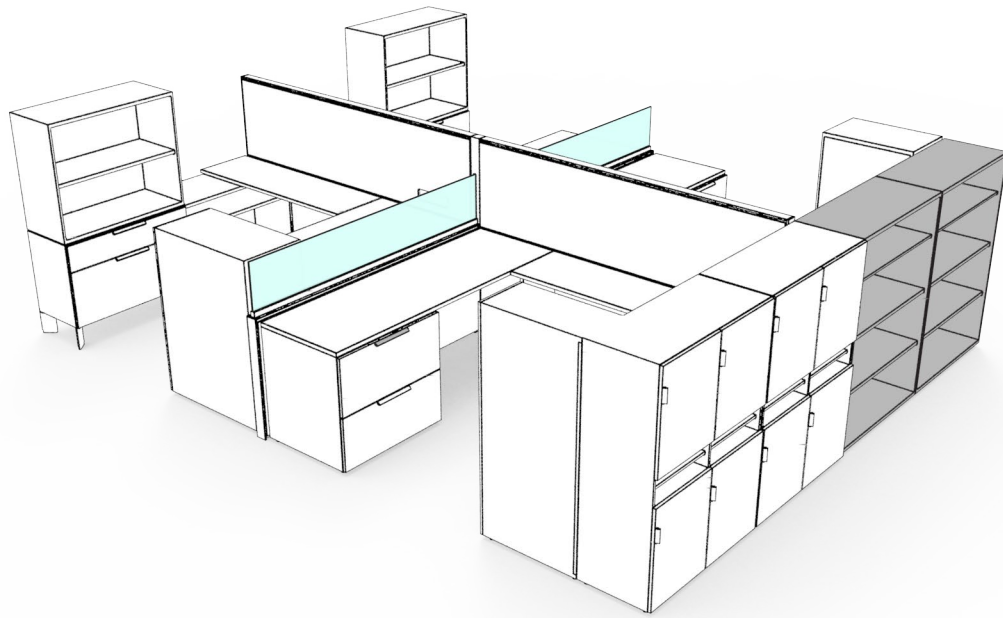

24", 30", 36" widths

42", 48" widths

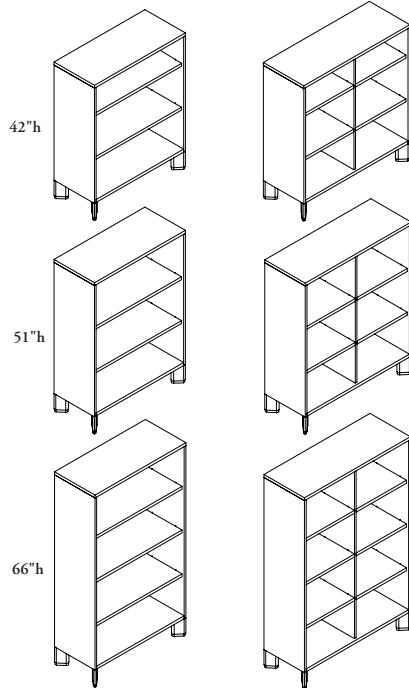

24", 30", 36" widths

42", 48" widths

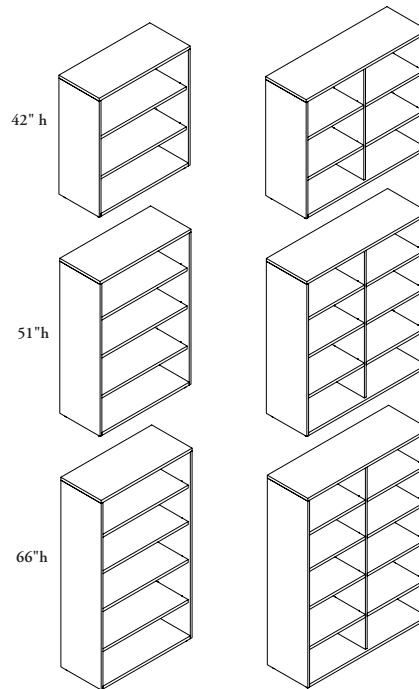

Bookcase – Elevated (UBKE)

- Provides open book storage within a workstation
- Available in heights of 42", 51" and 66", widths of 24" - 48" and a depth of 16"
- The number of shelves varies by height and width
- Offers electrical options of base grommet center (on widths 24" - 36"), base grommet left and base grommet right (on widths 42" or 48")

Bookcase – Standard (UBKS)

- Similar to the Bookcase – Elevated (UBKE) but with no electrical options

low full drawer credenzas

- Provide full drawer storage
- Available 21" high and depths of 16" and 19"
- Available in widths from 48" - 96" (Laminate is **not** available on 96" wide credenzas)
- 16" deep credenzas do **not** have full extension filing (see filing charts for filing capacity)

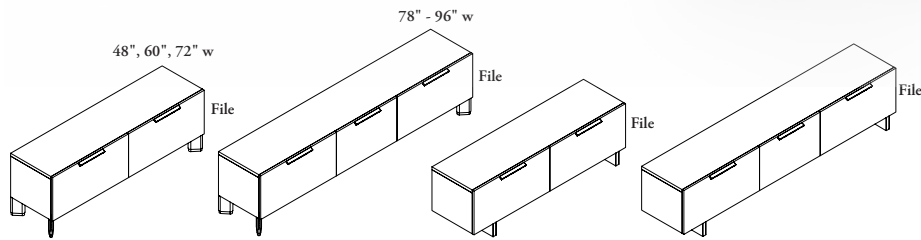
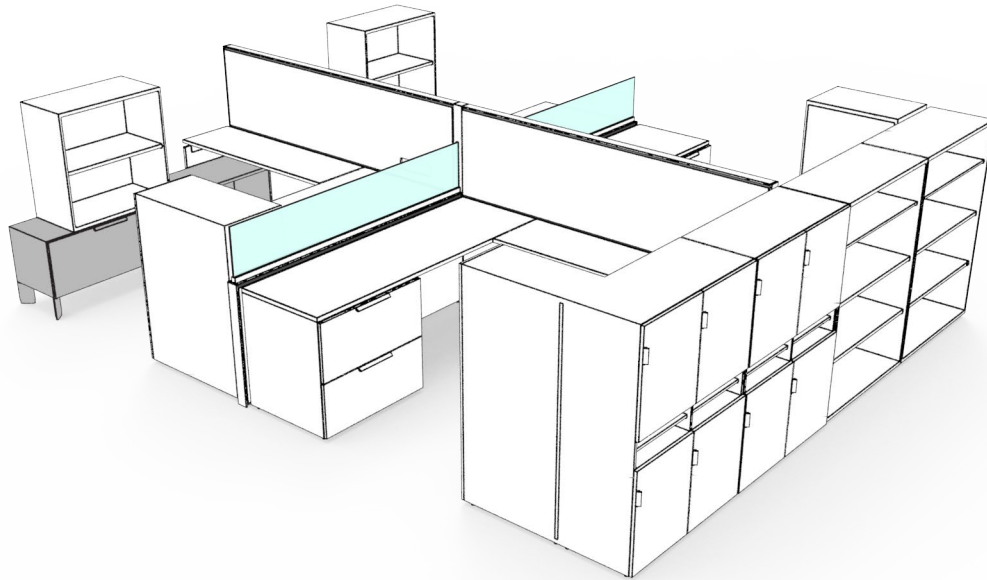

Angled Foot

District Foot (19" depth only)

Low Full Drawer Credenza – Elevated (ULDE)

- Available in a file drawer configuration
- 16" deep credenza has the option of angled feet only while the 19" depth has the option of angled or District feet
- 48", 60", 72" wide credenzas have two file drawers and when specified with angled feet, have the electrical cut out capability for base back, left or right
- 78" - 96" wide credenzas have three file drawers and when specified with angled feet, have the electrical cut out capability for base back, left right or center
- 19" deep credenza can accommodate optional red drawer accessories

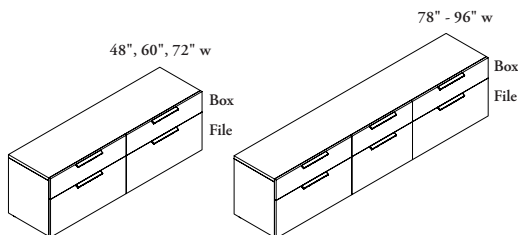

Low Full Drawer Credenza – Standard (ULDS)

- Available in a box/file drawer combination in each section
- Unable to be powered and **cannot** accommodate red drawer accessories

credenza basics (continued)

high full drawer credenzas

- Provide full drawer storage at a 28" height and 16" or 19" depths
- Available in widths from 48" - 96" (Laminate is **not** available on 96" wide credenzas)
- If widths of 24", 30" or 36" is required, see Stretch Pedestals
- 16" deep credenzas do **not** have full extension filing (see filing charts for filing capacity)

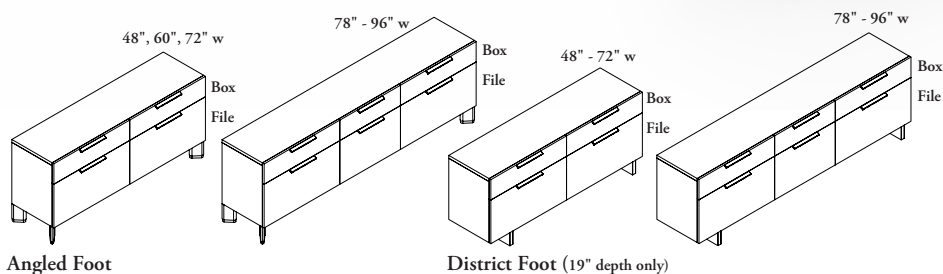
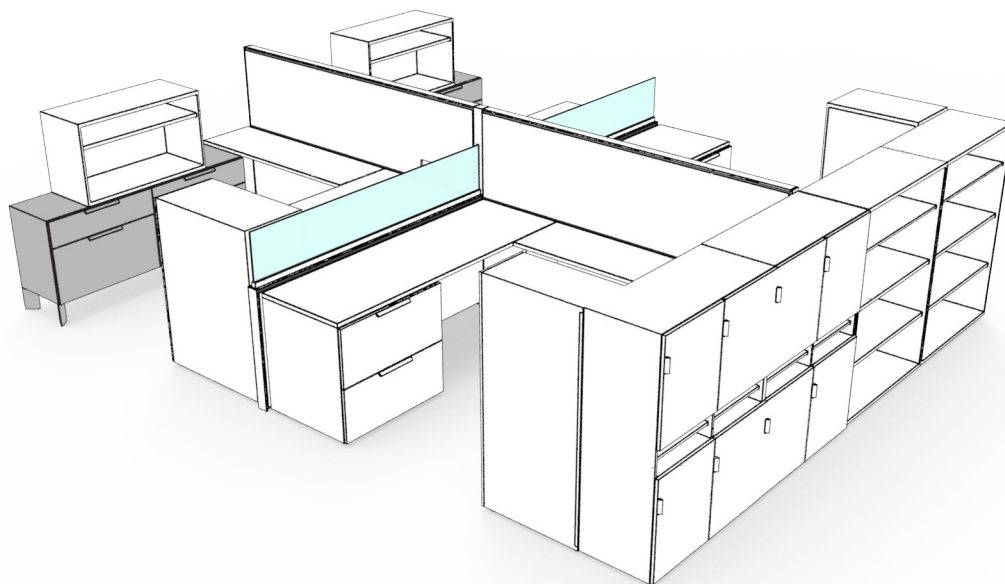

High Full Drawer Credenza – Elevated (UHDE)

- Available in a box/file drawer combination
- 16" deep credenza has the option of angled feet only while the 19" depth has the option of angled or District feet
- 48", 60" and 72" credenzas have two box/file drawers and when specified with angled feet, have the electrical cut out capability for base back, left or right
- 78" - 96" wide credenzas have three box/file drawers and when specified with angled feet, have the electrical cut out capability for base back, left right or center
- Red drawer accessories **cannot** be accommodated in high credenzas

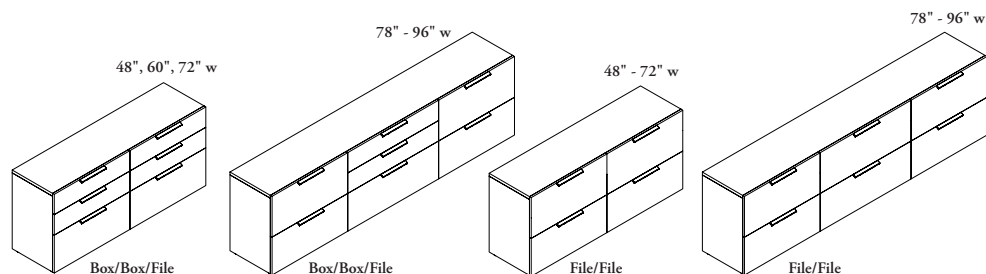

High Full Drawer Credenza – Standard (UHDS)

- Available in box/box/file or file/file combinations
- Available in 16" or 19" depths
- On 78" - 96" wide credenzas with the option of a box/box/file drawer combination, only the middle section will have a box/box/file, the other sections will have the file/file combination
- Unable to be powered and **cannot** accommodate red drawer accessories

credenza basics (continued)

low open credenzas

- Available 21" high and depths of 16" and 19"
- Available in widths from 24" - 96" (Laminate is **not** available on 96" wide credenzas)
- Consists of open shelves only. Number of sections varies by size

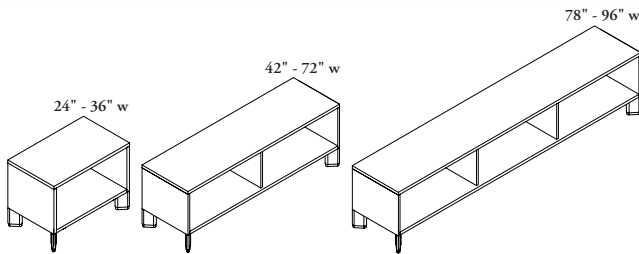
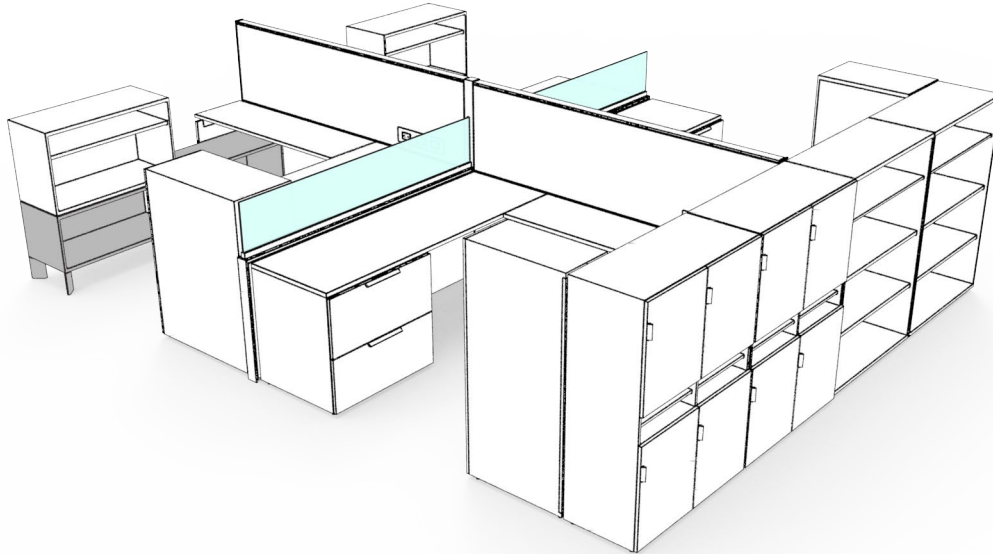

Angled Foot

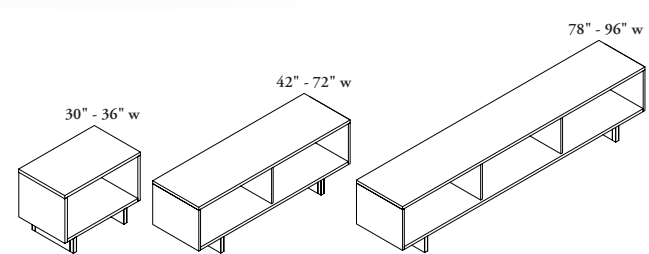

District Foot (19" depth only)

Low Open Credenza – Elevated (ULOE)

- Open sections are single-height
- 16" deep cabinets are available with angled feet only while 19" deep cabinets have the option of angled or District feet
- The angled foot is available with a Base and Top Grommet option into which a Cubby Power Monument (EWQPM) can be mounted

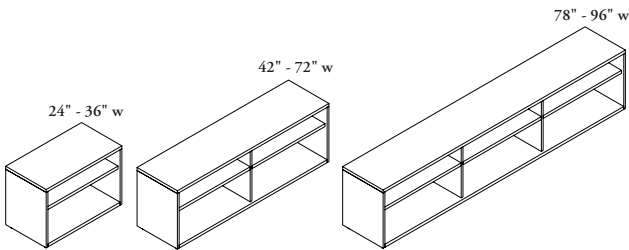

Low Open Credenza – Standard (ULOS)

- Open sections have one adjustable shelf each
- Grommet options are unavailable

credenza basics (continued)

high open credenzas

- Available 28" high and depths of 16" and 19"
- Available in widths from 24" - 96" (Laminate is **not** available on 96" wide credenzas)
- Consists of open shelves only. Number of sections varies by size

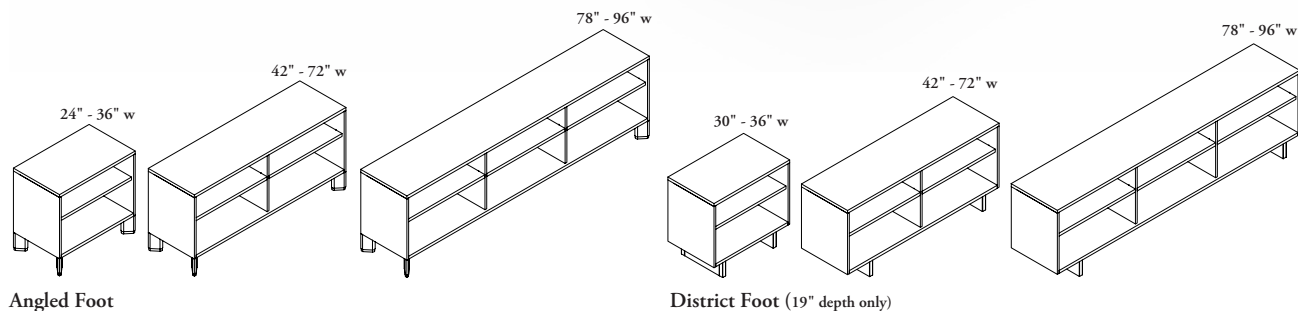
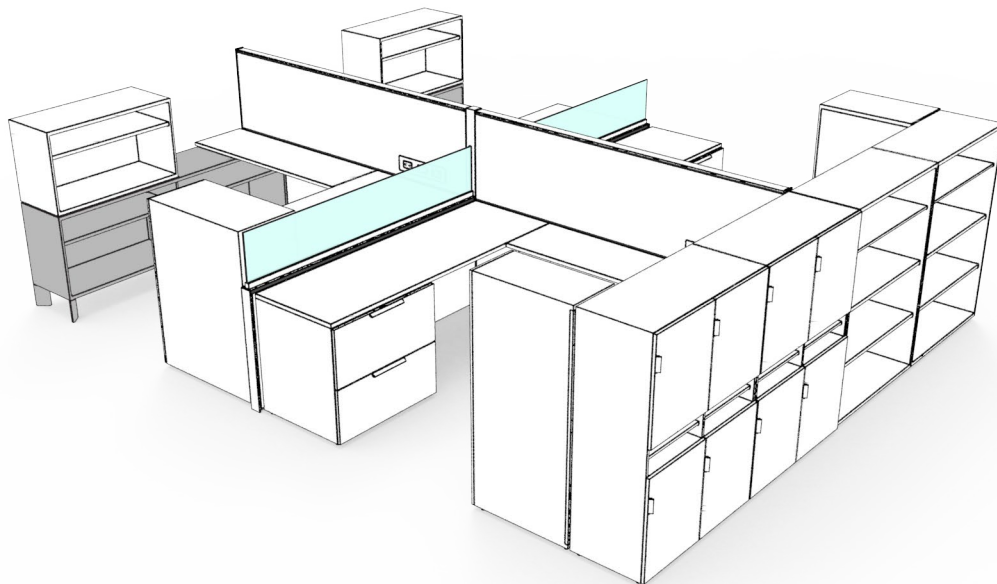

High Open Credenza – Elevated (UHOE)

- Open sections have one adjustable shelf each
- 16" deep cabinets are available with angled feet only while 19" deep cabinets have the option of angled or District feet
- The angled foot is available with a Base and Top Grommet option into which a Cubby Power Monument (EWQPM) can be mounted

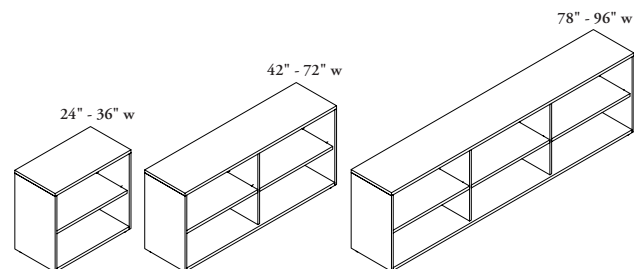

High Open Credenza – Standard (UHOS)

- Open sections have one adjustable shelf each
- Grommet options are unavailable

credenza basics (continued)

low open with drawer credenzas

- Available 21" high and depths of 16" and 19"
- Available in widths from 30" - 96" (Laminate is **not** available on 96" wide credenzas)
- Consists of one open section and one or two filing sections depending on width
- Cabinets are handed, determined by the location of the open section
- 16" deep credenzas do **not** have full extension filing (see filing charts for filing capacity)

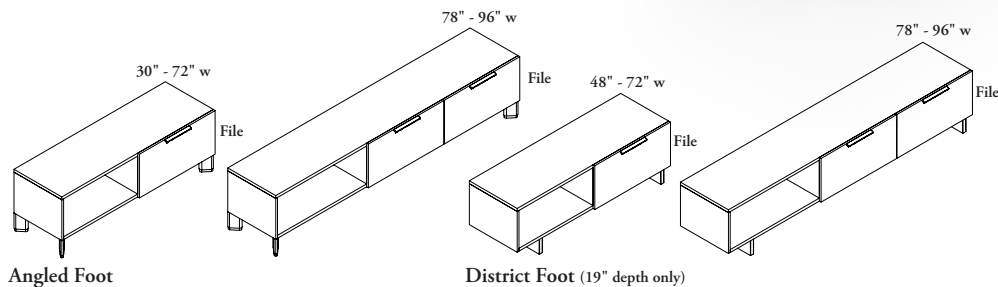
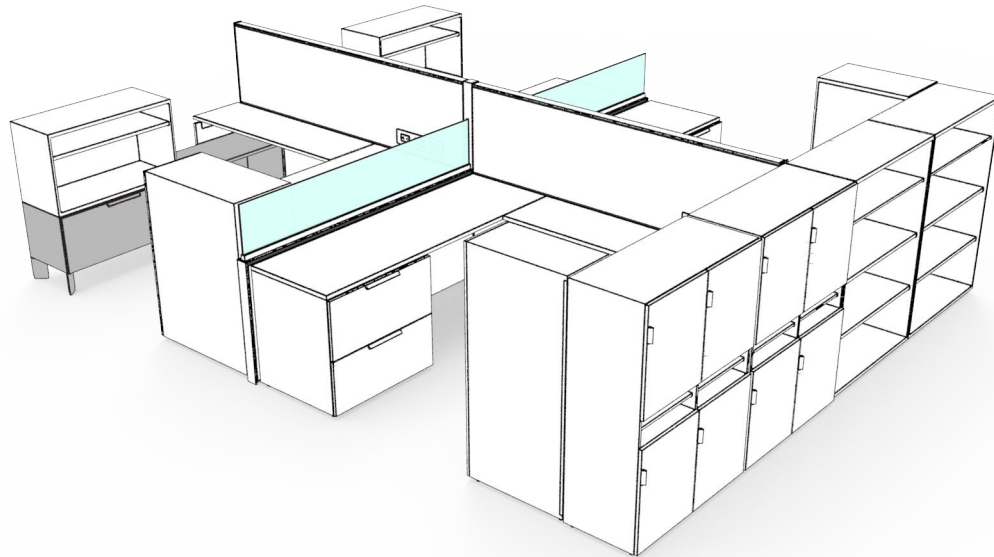

Low Open with Drawer Credenza – Elevated (ULHE)

- Available with a file drawer configuration and a single-height opening
- 16" deep credenzas are available with angled feet and the option of Base Back Cut Out or Base and Top Grommets
- 19" deep credenzas are available with angled feet and the option of Base Back Cut Out or Base and Top Grommets, or with District feet, which has no option for grommets
- If Base Back Cut Out is selected, cut out will appear on the back of the section with the drawer. If the width of the credenza is longer than 78" (two drawers) then the cut out is at the end section (**not** the center). If Base and Top Grommet is selected, it will appear in the open section of the credenza
- The Cubby Power Monument (EWQPM) can be mounted into the base grommet holes providing power and data access in the open sections of a credenza

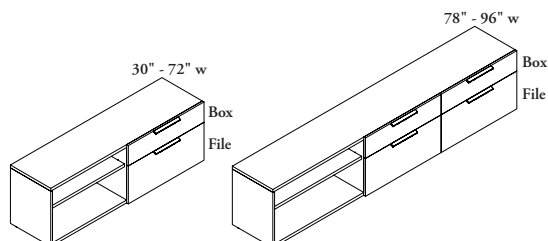

Low Open with Drawer Credenza – Standard (ULHS)

- Available with box/file drawer combination and one adjustable shelf in open section
- Grommet options are unavailable

credenza basics (continued)

high open with drawer credenzas

- Available 28" high and depths of 16" and 19"
- Available in widths from 48" - 96" (Laminate is **not** available on 96" wide credenzas)
- Consists of one open section and one or two filing sections depending on width
- Cabinets are handed, which is determined by the location of the open section
- 16" deep credenzas do **not** have full extension filing (see filing charts for filing capacity)

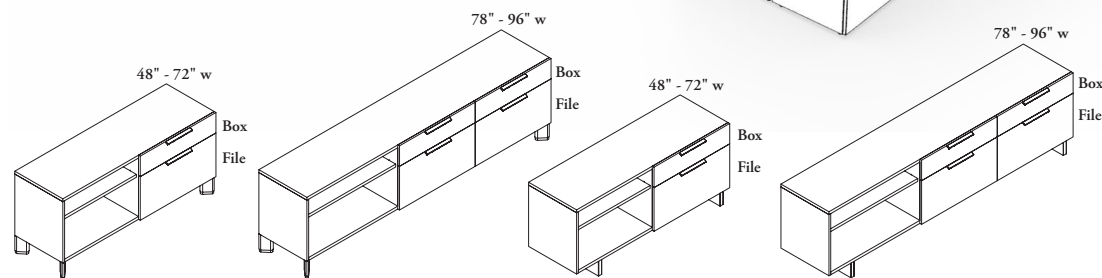
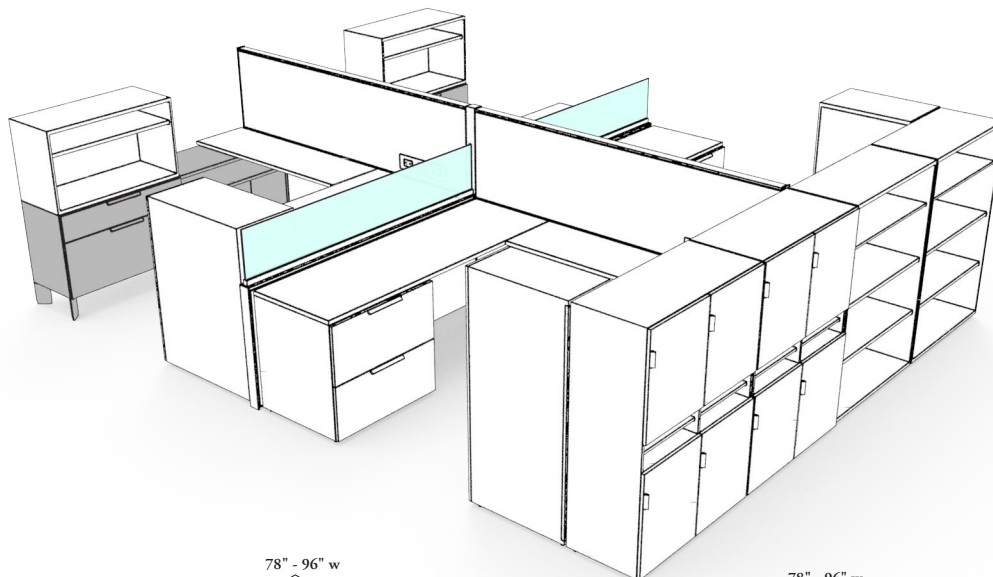

Angled Foot

District Foot (19" depth only)

High Open with Drawer Credenza – Elevated (UHHE)

- Available with a box/file drawer combination and one adjustable shelf in open section
- 16" deep credenzas are available with angled feet and the option of Base Back Cut Out or Base and Top Grommets
- 19" deep credenzas are available with angled feet and the option of Base Back Cut Out or Base and Top Grommets, or with District feet, which has no option for grommets
- If Base Back Cut Out is selected, cut out will appear on the back of the section with the drawer. If the width of the credenza is longer than 78" (two drawers) then the cut out is at the end section (**not** the center). If Base and Top Grommet is selected, it will appear in the open section of the credenza

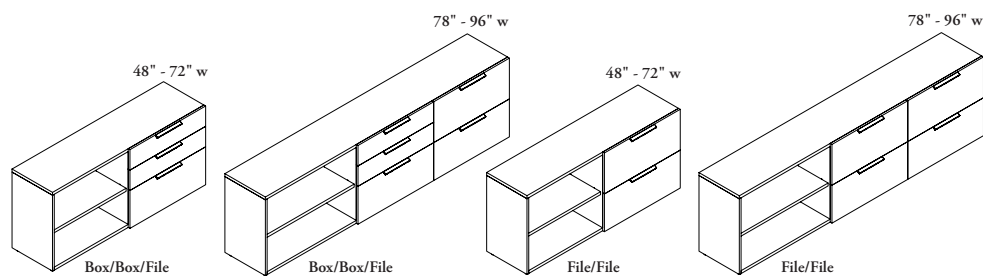

High Open with Drawer Credenza – Standard (UHHS)

- Available with box/box/file or file/file drawer combination and one adjustable shelf in each open section
- When the 78" - 96" wide credenza is specified with the box/box/file drawer combination, only the center section will have the box drawers, the other sections will have the file/file drawer combination
- Grommet options are unavailable

credenza basics (continued)

low double sliding door credenzas

- Available in a height of 21" and depths of 16" and 19"
- Available in widths from 42" - 96" (Laminate is not available in 96" wide credenza)
- Consists of two sections with two sliding doors
- Sliding doors are available in solid or glass finish

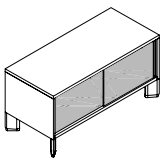
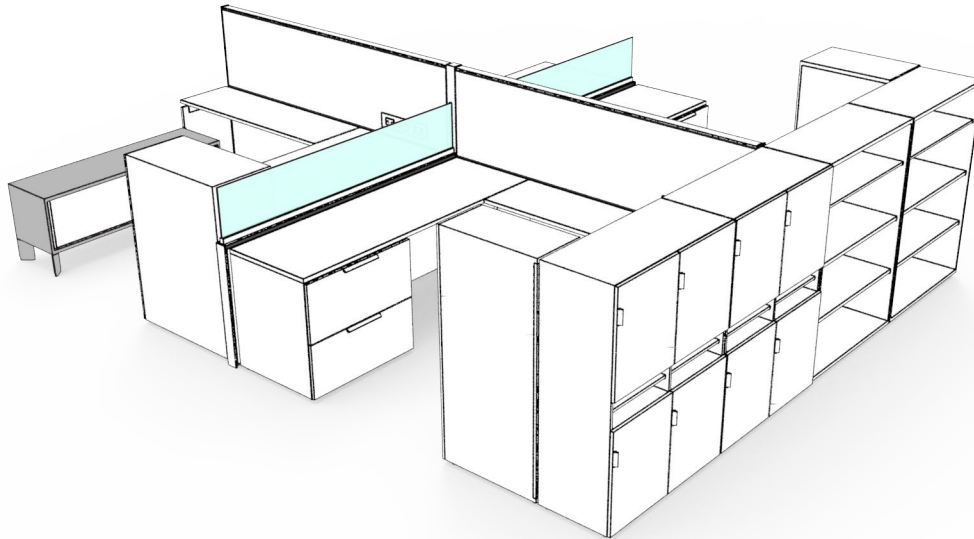
**Low Double Sliding Door Credenza – Elevated (ULSE)**

- 16" deep credenzas are available with angled feet and the option of Base and Top Grommets
- 19" deep credenzas are available with angled feet and the option of Base and Top Grommets, or with District feet, which has no option for grommets
- Double Sliding Door Credenzas will always have two sections secured with two sliding doors regardless of the width of the unit
- The 16" deep **cannot** be specified with a District Foot (D)
- Grommet option is available for casual power and data routing only. The Cubby Power Monument (EWQPM) **cannot** be used
- The Reconfigurable Low Credenza-to-Worksurface Support (UWCPWN) **cannot** be used with this unit as it will interfere with the sliding door
- It is **not** recommended that Double Sliding Door Credenzas be used to support worksurfaces in a perpendicular application as handle pulls will be difficult to reach under the worksurface

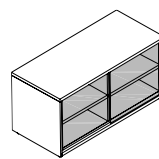
**Low Double Sliding Door Credenza – Standard (ULSS)**

- Double Sliding Door Credenzas will always have two sections secured with two sliding doors regardless of the width of the unit
- Each section will come with one adjustable shelf
- The Reconfigurable Low Credenza-to-Worksurface Support (UWCPWN) **cannot** be used with this unit as it will interfere with the sliding door
- It is **not** recommended that Double Sliding Door Credenzas be used to support worksurfaces in a perpendicular application as handle pulls will be difficult to reach under the worksurface
- Grommet options are unavailable

credenza basics (continued)

high double sliding door credenzas

- Available in a height of 28" and depths of 16" and 19"
- Available in widths from 42" - 96" (Laminate is not available in 96" wide credenza)
- Consists of two sections with two sliding doors
- Sliding doors are available in solid or glass finish

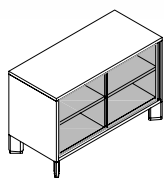
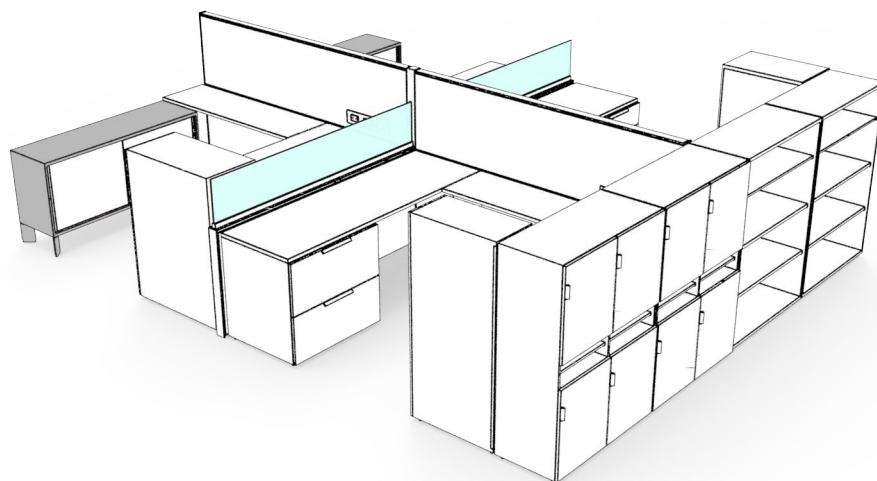

High Double Sliding Door Credenza – Elevated (UHSE)

- 16" deep credenzas are available with angled feet and the option of Base and Top grommet
- 19" deep credenzas are available with angled feet or with District feet and the option of Base and Top grommet or with District feet which has no options for grommets
- Double Sliding Door Credenzas will always have two sections secured with two sliding doors regardless of the width of the unit
- Each section will come with one adjustable shelf
- The 16" deep **cannot** be specified with a District Foot (D)
- Grommet option is available for casual power and data routing only. The Cubby Power Monument (EWQPM) **cannot** be used
- It is **not** recommended that Double Sliding Door Credenzas be used to support worksurfaces in a perpendicular application as handle pulls will be difficult to reach under the worksurface

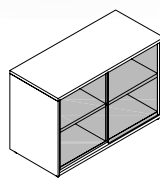

High Double Sliding Door Credenza – Standard (UHSS)

- Each section will come with one adjustable shelf
- Double Sliding Door Credenzas will always have two sections secured with two sliding doors regardless of the width of the unit
- It is **not** recommended that Double Sliding Door Credenzas be used to support worksurfaces in a perpendicular application as handle pulls will be difficult to reach under the worksurface
- Grommet option is available for casual power and data routing only. The Cubby Power Monument (EWQPM) **cannot** be used

credenza drawer widths

The following illustrates District credenza drawer and open section widths.

30" Width

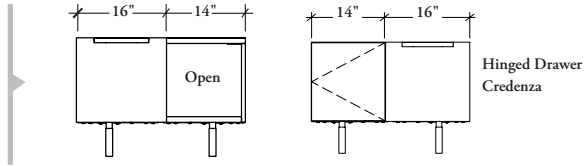

36" Width

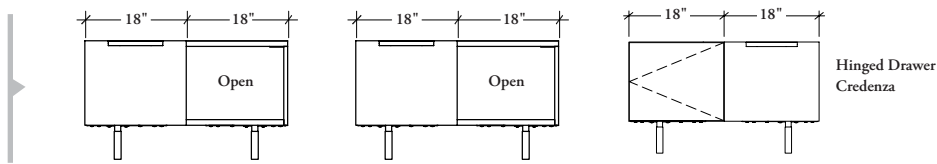

42" Width

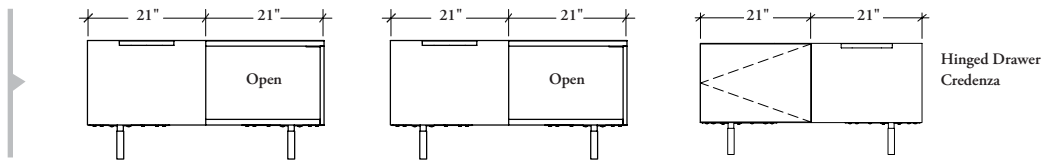

48" Width

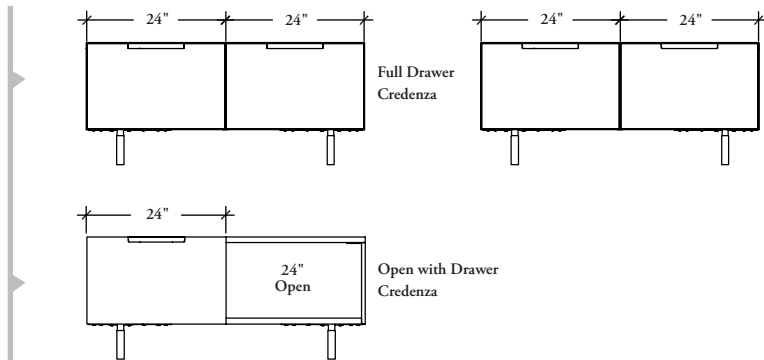

credenza drawer widths (continued)

The following illustrates District credenza drawer and open section widths.

54" Width

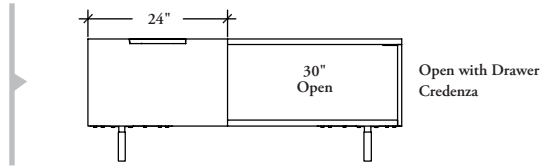

60" Width

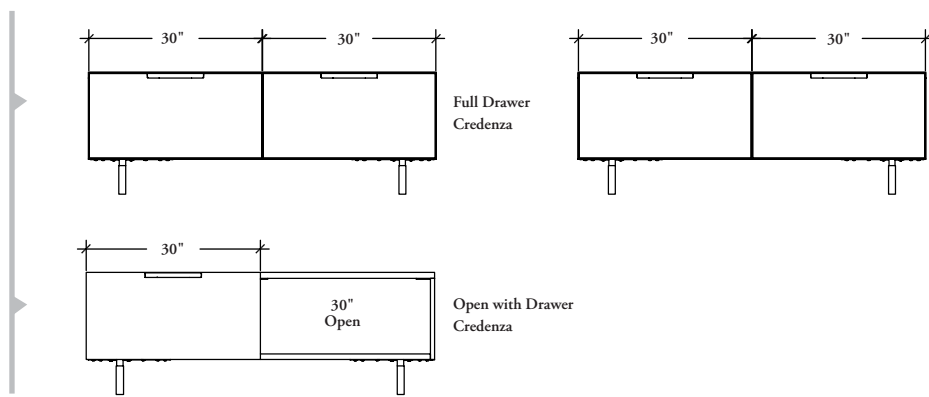

66" Width

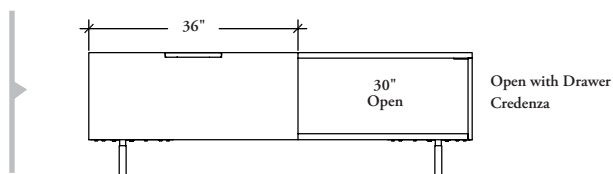

credenza drawer widths (continued)

The following illustrates District credenza drawer and open section widths.

72" Width

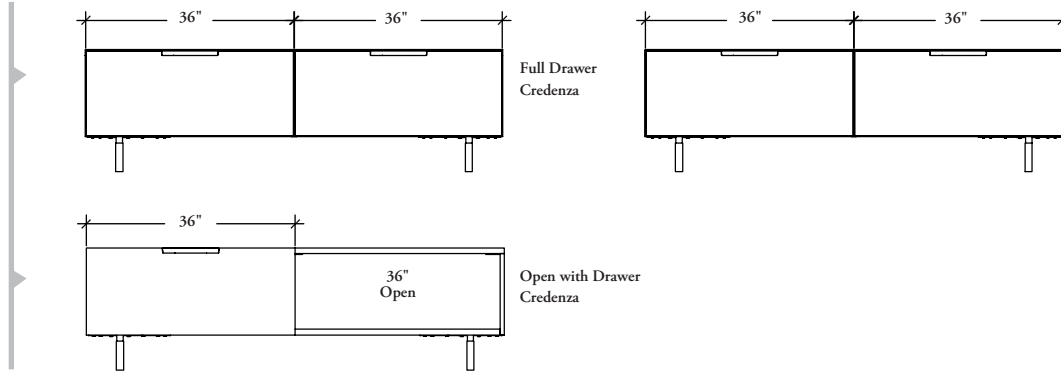

78" Width

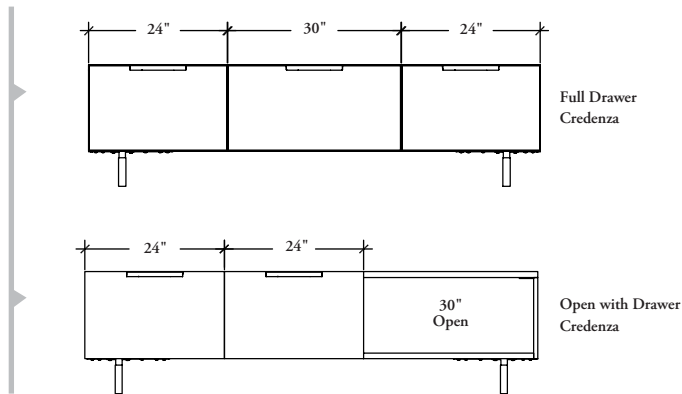

84" Width

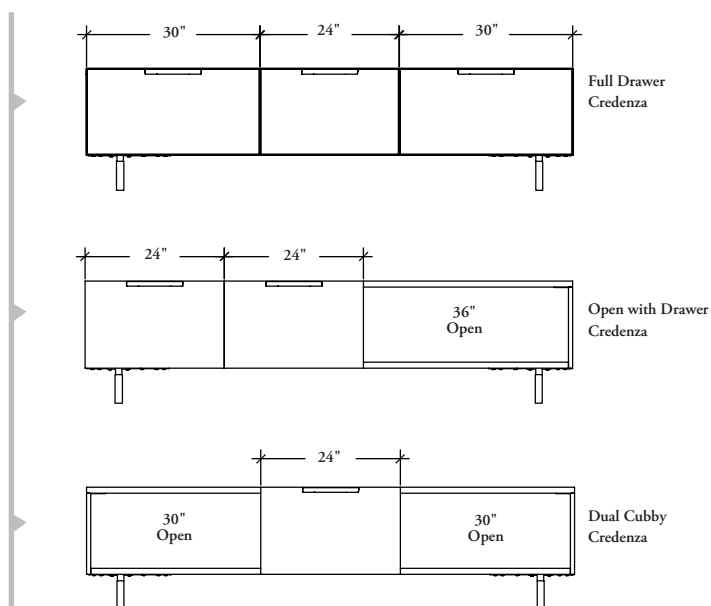

credenza drawer widths (continued)

90" Width

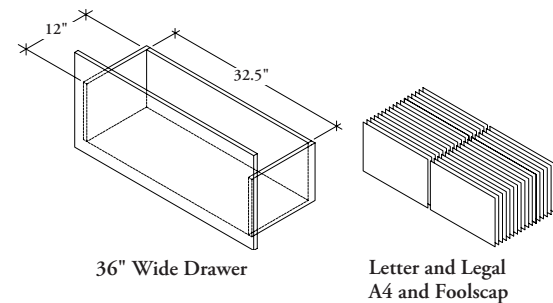
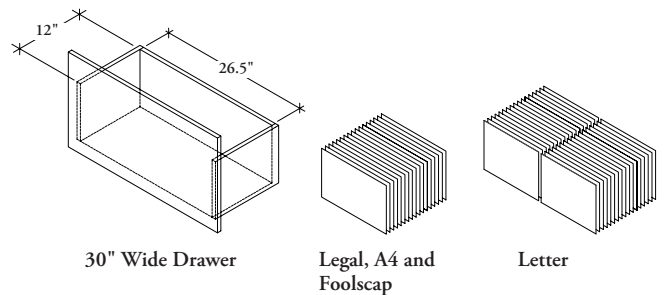
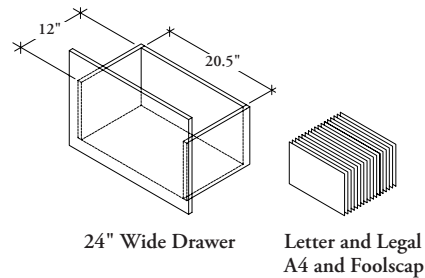
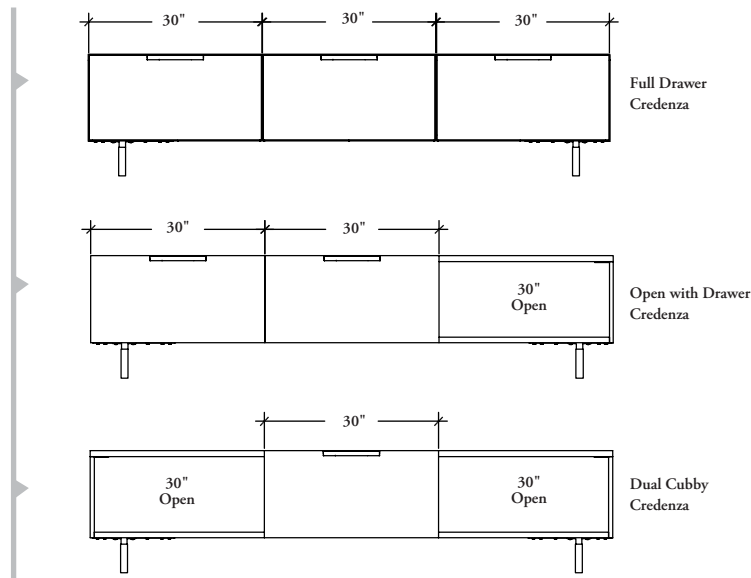

96" Width

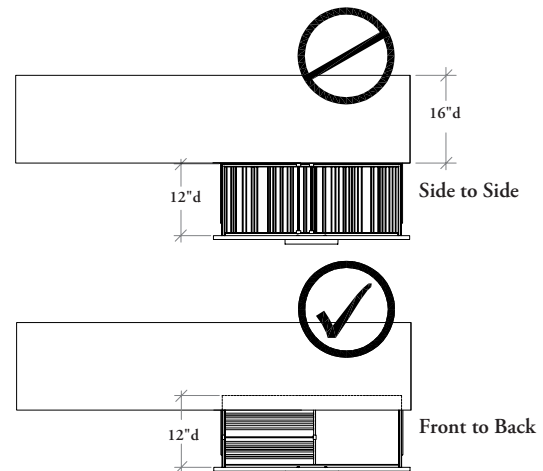
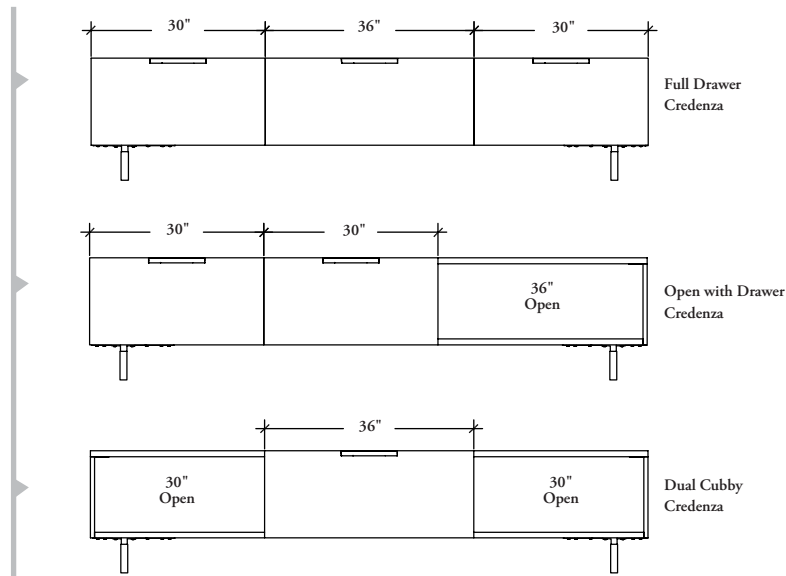

- 16" deep file drawers do **not** have full extension files
- Filing must be front-to-back **not** side-to-side
- On 24" width file drawers only one front-to-back filing section can be used (letter, legal, A4 or foolscap)
- On 30" width file drawers two front-to-back filing sections can be used (letter) or one filing section (legal, A4 or foolscap)
- On 36" width filing drawers, front-to-back filing sections can be used (letter, legal, A4 or foolscap)

planning with credenzas

The following should be considered with planning with District credenzas.

depths

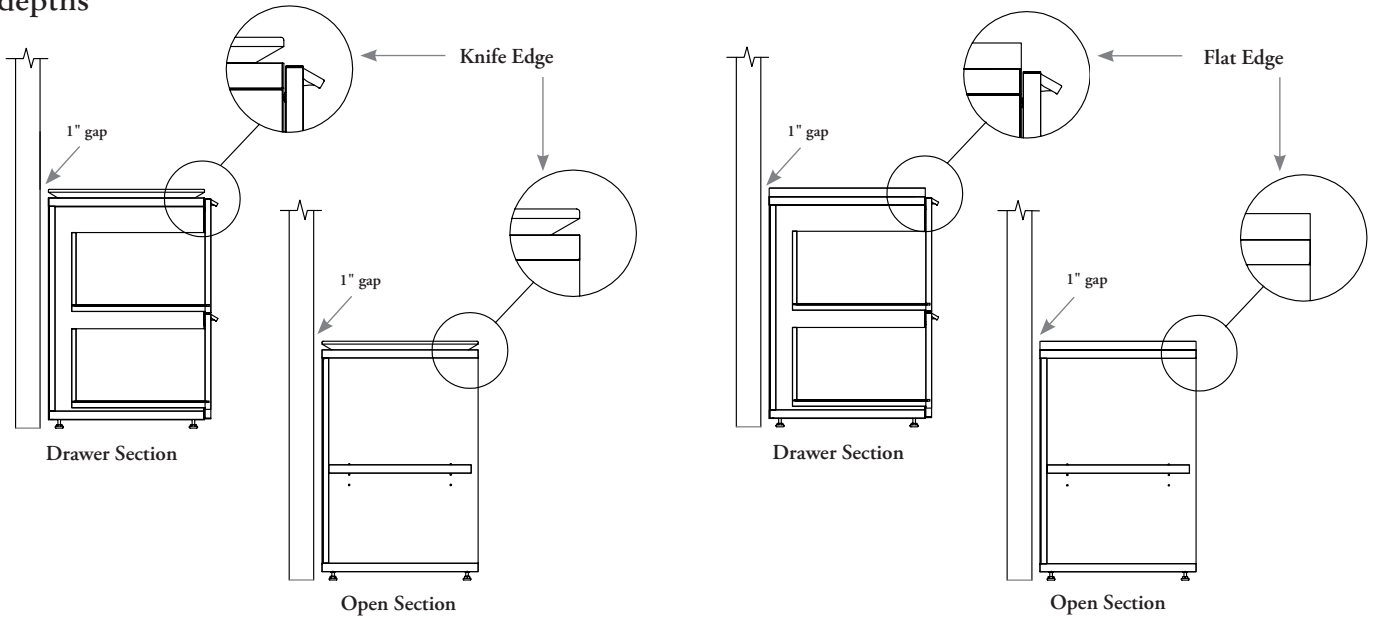

- District credenzas are sized to match the actual depth of District worksurfaces (i.e., 19")
- The body of the credenza, including the open shelf section aligns with the District work surface, and the door on the drawer section sits in front of the surface

heights

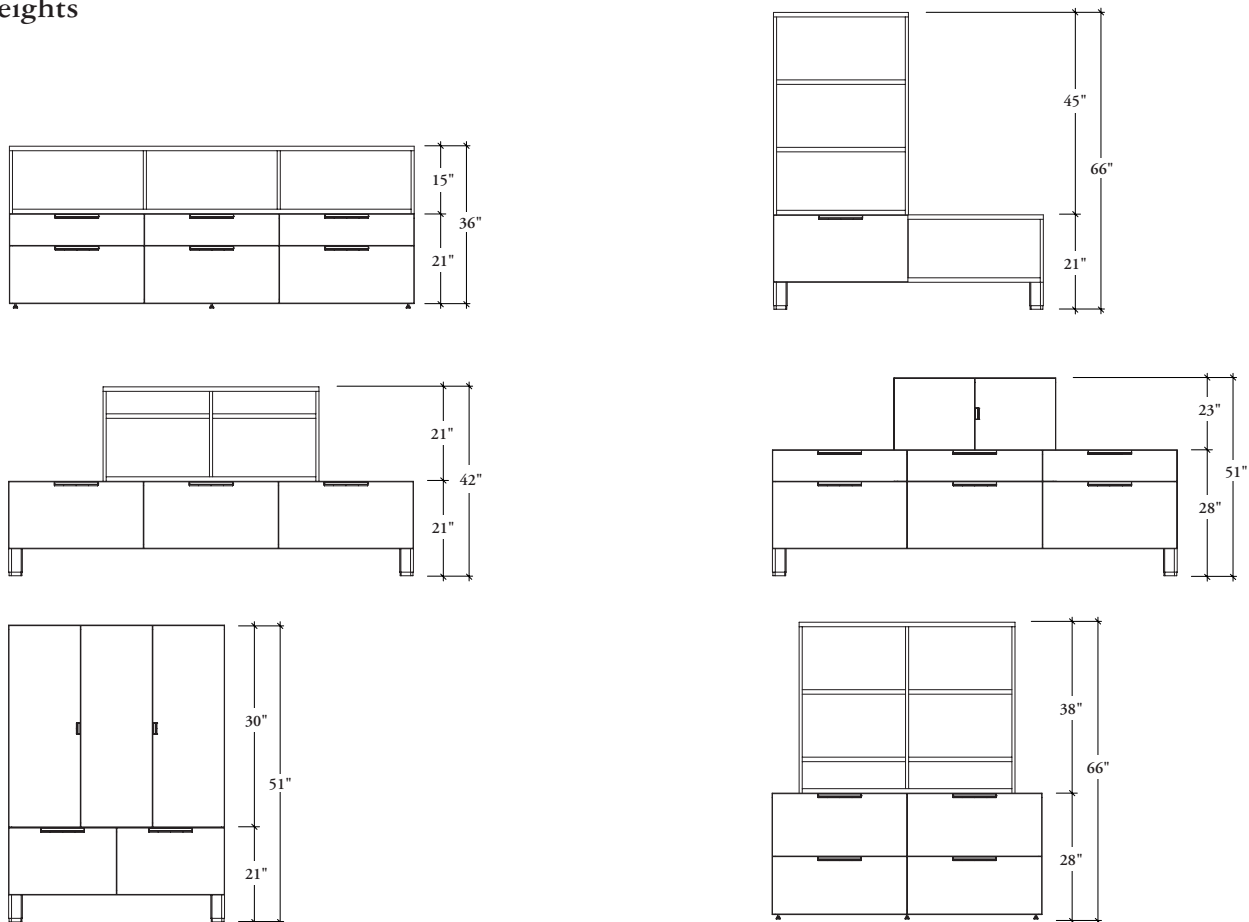

- District credenza heights when combined with stackers match typical Teknion datum heights

planning with credenzas (continued)

double sliding door location

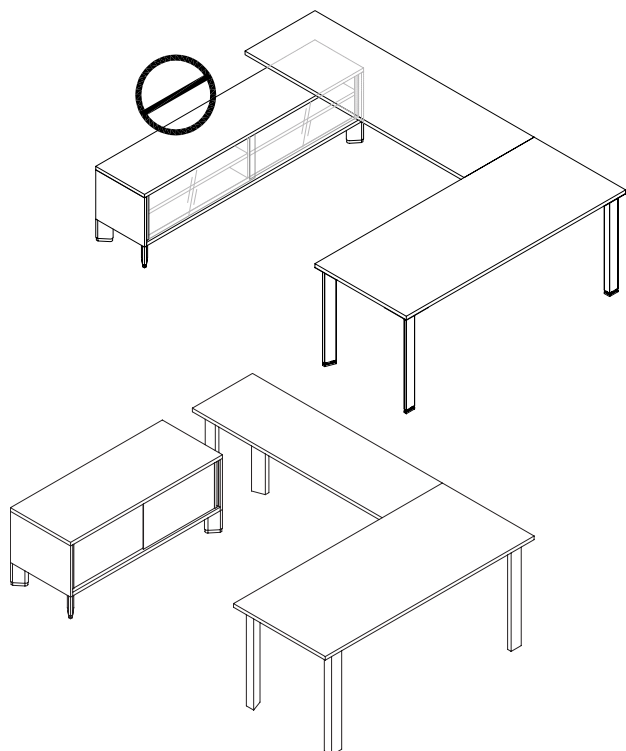

- The pulls on Double Sliding Door Credenzas are on the outside ends of the doors, **not** in the center; it is **not** recommended that they be used under a worksurface as it is difficult to reach the handle

counterweights

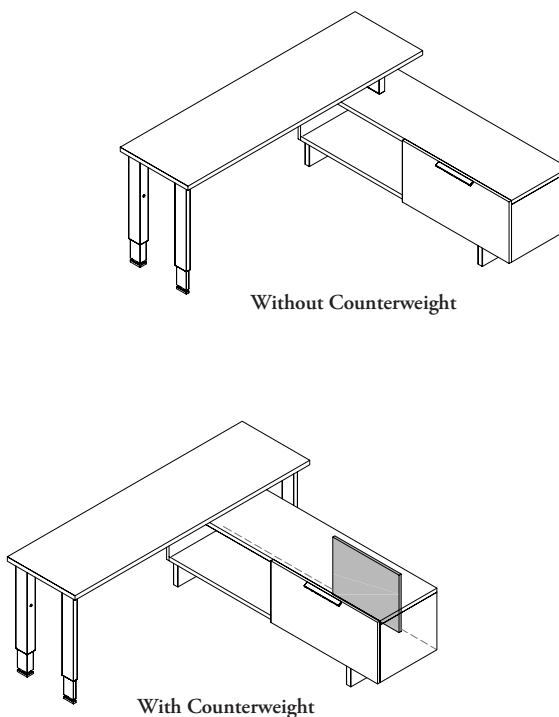

- District credenzas with drawers are available with a counterweight option. Counterweights are only required if the credenza is freestanding
- If it is attached to a panel or worksurface, the counterweight is **not** required

electrical

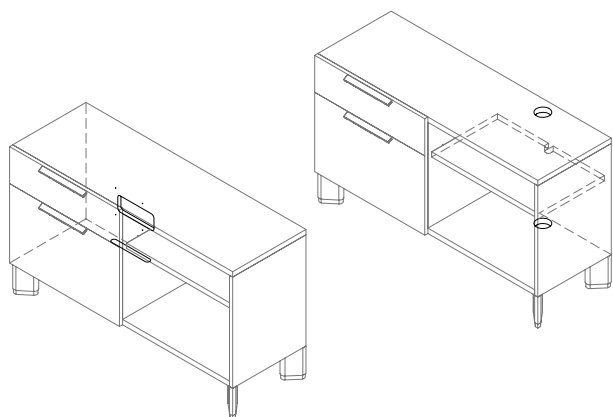

- Electrical options are not available on widths 30", 36" and 42"
- Both the open section and the drawer filing section of a credenza with angled legs can accommodate power
- The open cubby section can accommodate a grommet for casual wire management or a Cubby Power Monument (EWQPM) purchased separately for multi-circuit power and data
- The drawer section can be specified with a "back cut out" where a Flush Mount Power & Data (EWQP) unit can be mounted for multi-circuit power and data on the back of the storage unit

red drawer accessories

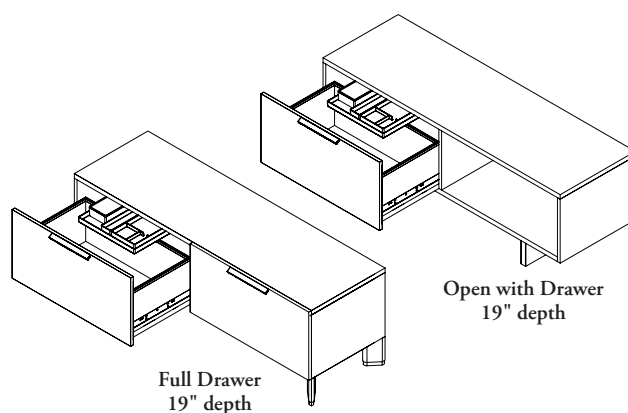

- The Red Tray Accessory option is available on 19" deep credenzas that have a single file drawer, they are **not** available on 16" deep credenzas
- They can be used with the angled or District foot options except widths 30", 36" and 42"
- Red Tray Accessories will only come in one drawer
- When credenzas have three drawers, the red tray accessories are located in the center drawer. When credenzas have two drawers, accessories are located in the left drawer

stacker basics

The following outlines the features of District stackers.

stackers

- Stack onto base storage units to provide storage to an overall maximum height of 66"
- Can be used for space division when panels are **not** required
- **Cannot** be used as stand alone storage or stacked onto each other, they must be stacked onto another base storage unit
- All stackers are 16" deep and can be stacked onto 16" or 19" deep lower storage

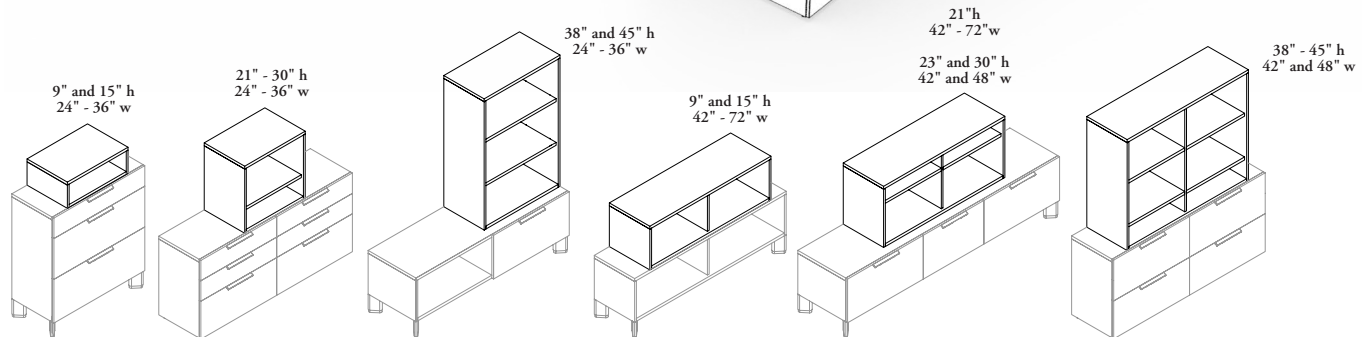
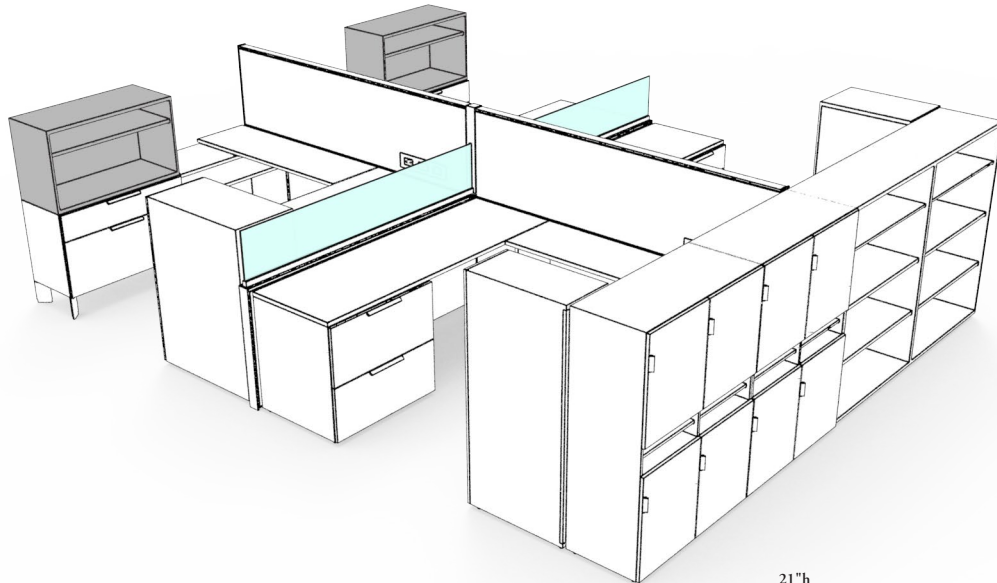

Single-Sided

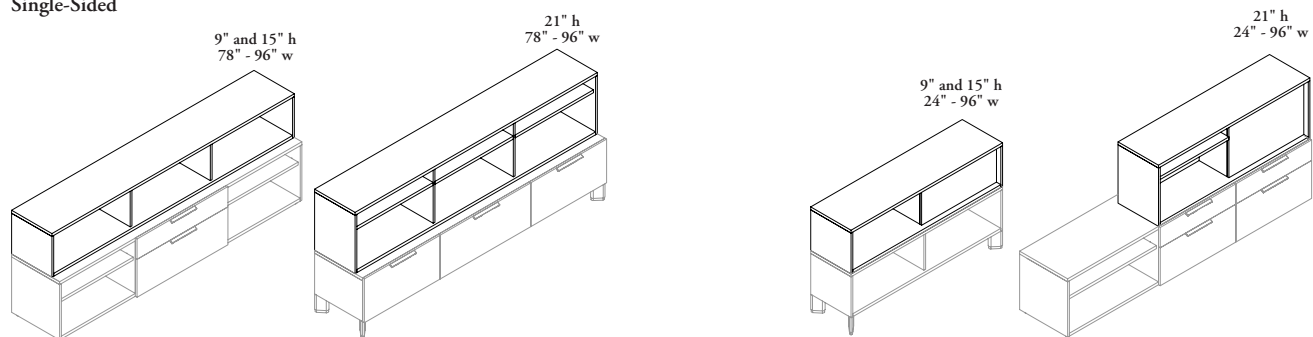

Single-Sided

Double-Sided

Open Stackers (UCO)

- Provide open stacked storage
- Available in heights of 9" - 45", to match standard District datum heights (36", 42", 51", 66") and widths of 24" - 96"
- Number of open compartments varies depending on height and width (see charts)
- Heights 9", 15" and 21" are available single- or double-sided to allow maximum planning flexibility
- Double-sided configuration is handed, which is determined by the location of the open section

stacker basics (continued)

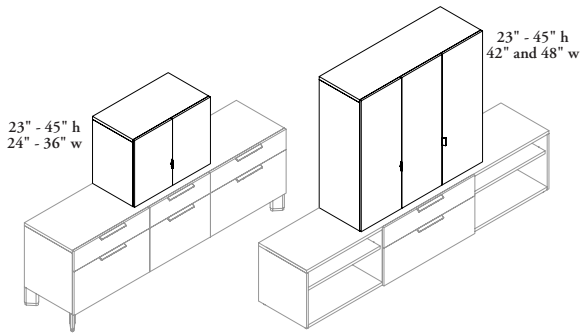

Closed Stackers (UCC)

- Provide closed stacked storage
- Available in heights of 23", 30", 38" and 45", to match standard District datum heights when combined with corresponding base units and widths of 24" - 48"
- 24" - 36" wide stackers are complete with two single-hinged doors and 42" - 48" wide stackers are complete with three doors, two that bi-fold and one hinged door
- All units are handed. Handedness on widths 24", 30" and 36" is determined by the location of the pull, whereas handedness on widths 42" and 48" will indicate the location of the single hinged door

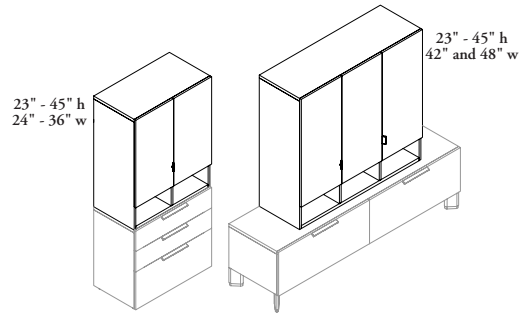

Closed Stacker with Cubbies (UCB)

- Provides closed stacked storage with open cubbies at the bottom
- Available in heights of 23", 30", 38" and 45", to match standard District datum heights (42", 51" and 66"), and widths of 24" - 48" in 6" increments
- 24" - 36" wide stackers are complete with two hinged doors and the 42" and 48" wide stackers are complete with three doors, two that bi-fold and one hinged door
- The handedness of 24", 30" and 36" units refer to handle location.
- The handedness of 42" and 48" units is determined by the opening orientation of the bi-fold door.

planning with stackers

The following should be considered with planning with District stackers.

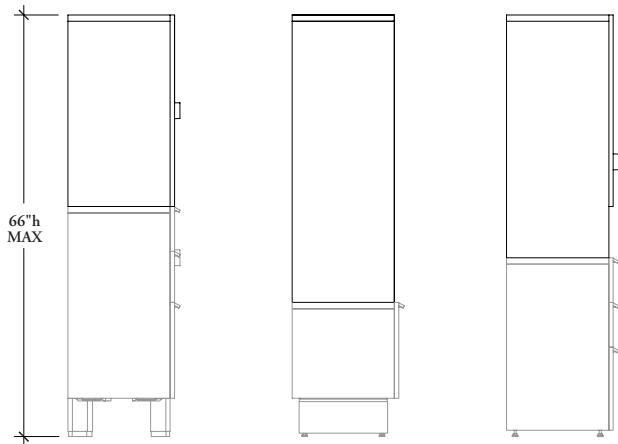

• Cabinets can be stacked in various combinations up to a maximum of 66" high

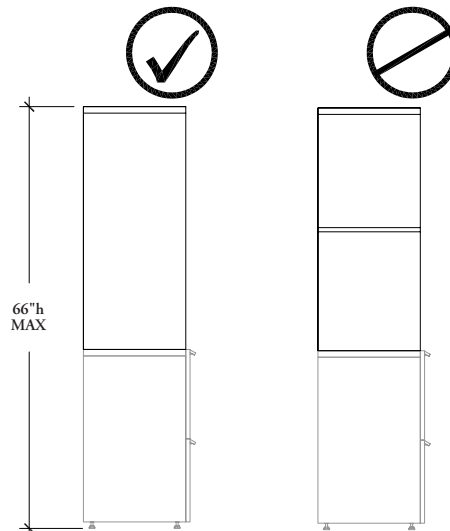

• Only one stacker can be used, the 66" high maximum

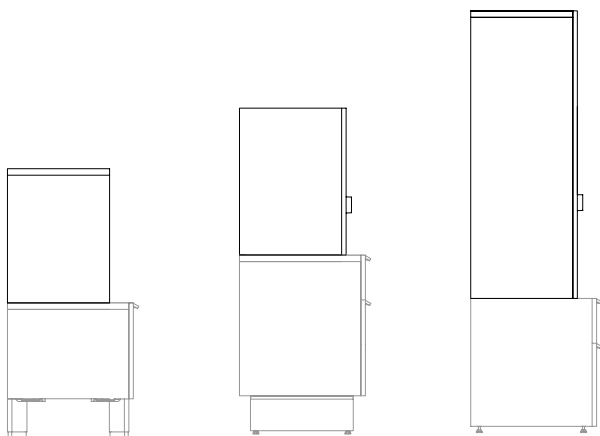

• Stackers do **not** need to be the same depth as the cabinet to which they are being stacked (ex. 16" deep stackers can be stacked onto 19" deep credenzas)

planning with stackers (continued)

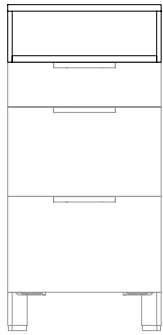

Base Cabinet: Lateral File

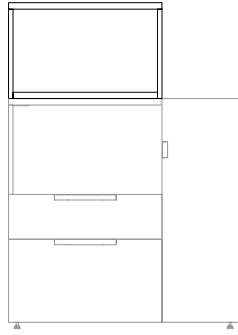

Base Cabinet: Tower

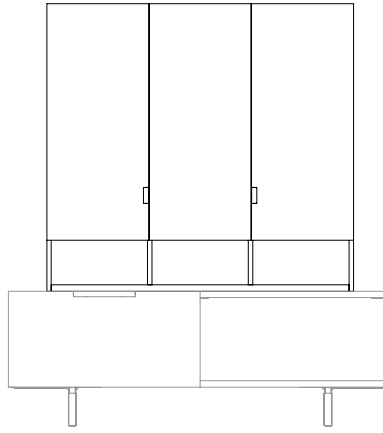

Base Cabinet: Credenza

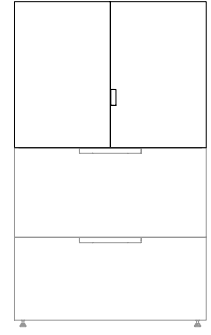

Base Cabinet: Stretch Pedestal

- Stackers must be stacked onto a base cabinet, they **cannot** start from the floor
- Base cabinets include lateral files, towers, credenzas and stretch pedestals

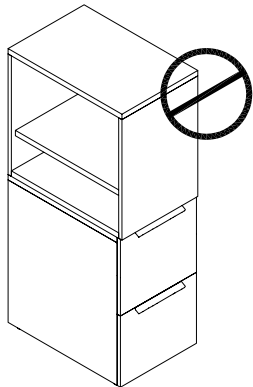

Stacker on Pedestal

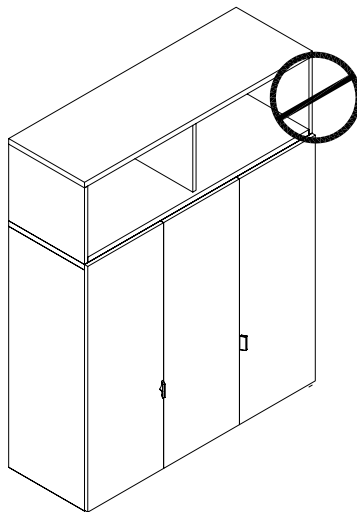

Stacker on Stacker

- Stackers **cannot** be stacked on pedestals, single lockers or other stackers

single locker basics

The following outlines the features of District Lockers.

single lockers

- Single Lockers are available in a variety of combinations to provide coat storage, cubbies and secured shelving
- Available in heights from 21" - 66" depending on the configuration
- Available in elevated and standard styles, elevated style having the angled foot
- The 12" single locker must be linked to a panel or worksurface
- Lockers must be specified left or right, handedness being determined by the location of the open section or hinge, depending on the configuration (see individual descriptions)

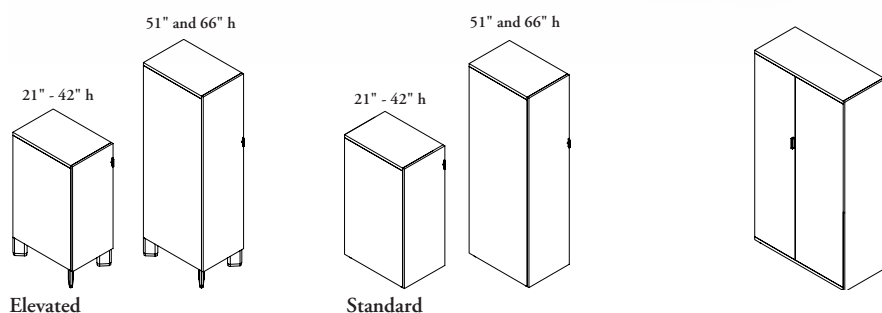
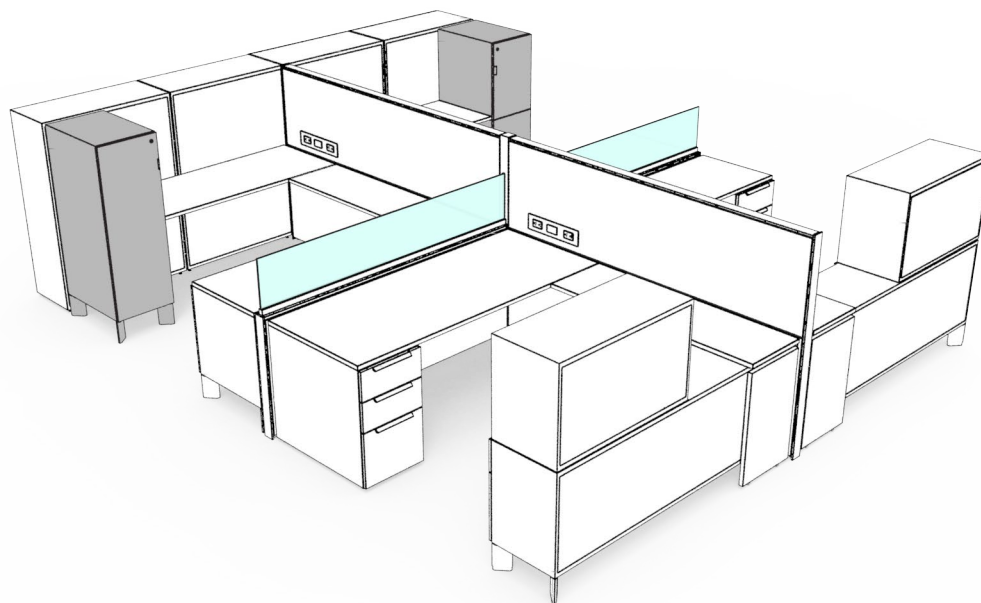

Single Locker with Solid Back (UKSD)

- Provides coat or shelf storage accessible from the front with an option for a full or split door
- Coat hooks are available depending on the cabinet depth when Closet (C) interior configuration is specified
- Available in depths of 16", 19" or 23" and widths of 12" and 16" to match typical District planning sizes
- Full door option is available with either a closet configuration (51" or 66" high) or secured shelving configuration.
- Grommet options are unavailable

Single Locker with Side Closet (UKC)

- Provides storage accessible from the front of the cabinet, and a closet on the side
- Available in heights of 51" and 66" in depths of 23", 29" and 35" and in widths of 12" and 16" to match typical District planning sizes
- Side closet is a full door and can be specified on either the right or the left side, handedness is determined by the location of the closet
- Front door is available in full-height or split-height
- The 12" wide locker **cannot** be used in a freestanding application. It must be attached to a worksurface or panel or linked to another storage unit
- When Full Door (F) option is specified, the front section will be configured with shelves
- The 23" depth will come with one coat hook and the 29" and 35" depths will come with two coat hooks for the side closet
- The front section will always be 16" deep, regardless of total depth of the unit. The width of the side closet will vary

planning with single lockers

The following should be considered with planning with District Lockers.

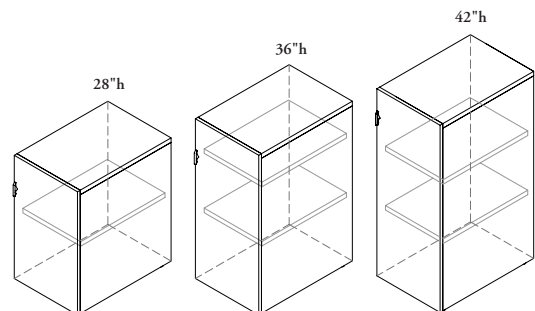

Full Door with Shelves (only option on 28", 36" and 42" heights)

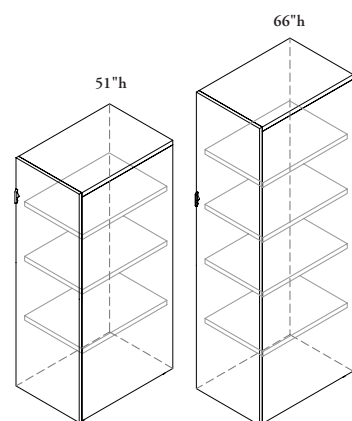

Full Door with Shelves

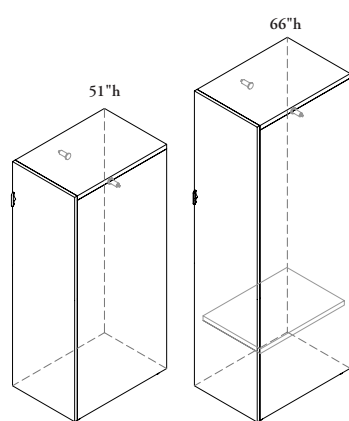

Full Door with Closet

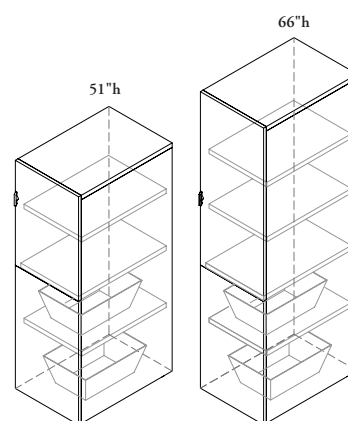

Split Door with Shelves and Recycling Compartment

- 28", 36" and 42" high single lockers are available with a full door and shelves only, but the 51" and 66" high lockers are available with a split door with shelves and a recycling compartment, full door with closet, or full door with shelves
- The 23" deep Solid Back Locker or the 35" deep Cubby Back Locker will include a coat rod (as apposed to a coat hook) if Closet configuration is selected

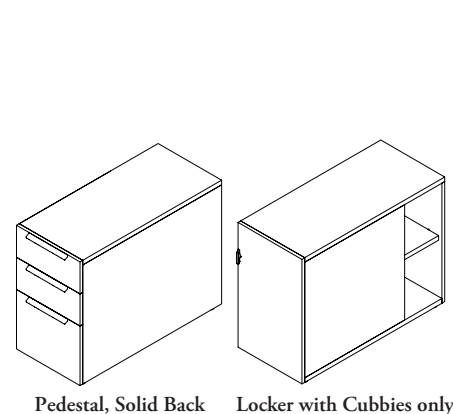

Pedestal, Solid Back

Locker with Cubbies only

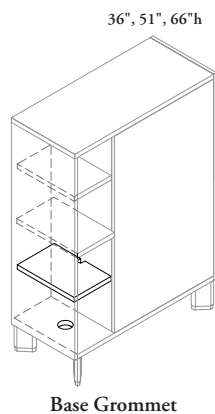

Base Grommet

- 29" and 35" deep single lockers are different in configuration than pedestals of the same depths
- Pedestals are available either full depth or with cubbies, but the locker is only available with the cubby option
- There is no option for a full depth single lockers

- The single locker with angled foot has a base grommet or base cut out option

planning with single lockers (continued)

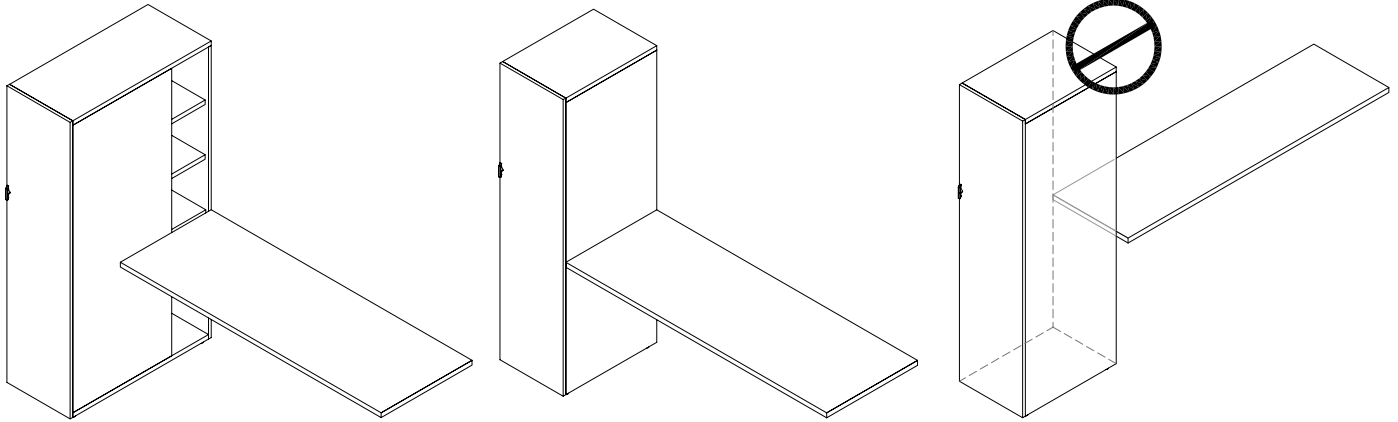

• Worksurfaces can mount from the side of a single locker, either the same depth or when the cabinet is deeper than the surface – they also mount to the side when the unit is complete with cubbies

• The surface **cannot** mount from the end of the cabinet, they must mount to the side

locker with side closet

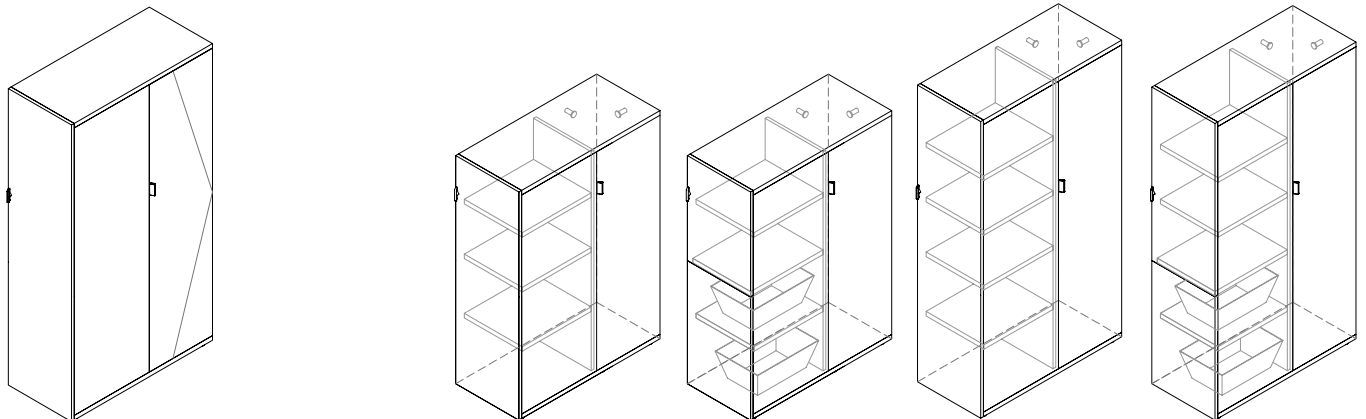

Right Handed

Full Door

Split Door

Full Door

Split Door

• Handedness of a locker with side closet is determined by the side that the closet is on

- Available in heights of 51" and 66" only and with options for a split door which contains shelves and a recycling compartment, or a full door with shelves only
- Front shelf section is always 16" deep the width of the side closet is dependent on the depth of the unit specified

dual, triple & quad locker basics

dual and quad lockers

- Dual and Quad Lockers provide coat storage, shelf storage or a combination of both in dual or quad configurations
- Can be linked to each other or to other storage

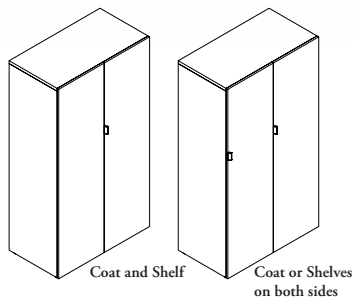
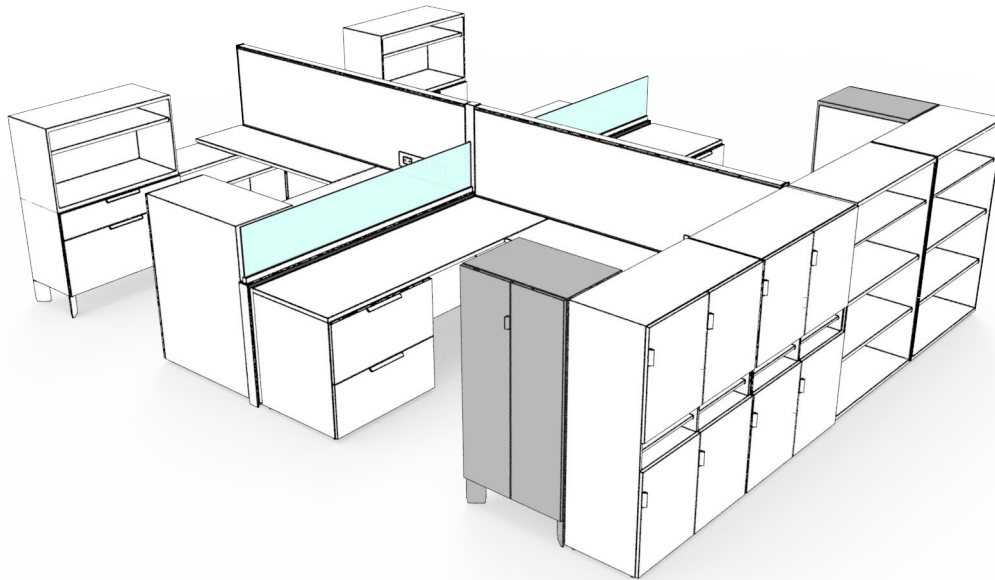

Coat and Shelf

Coat or Shelves on both sides

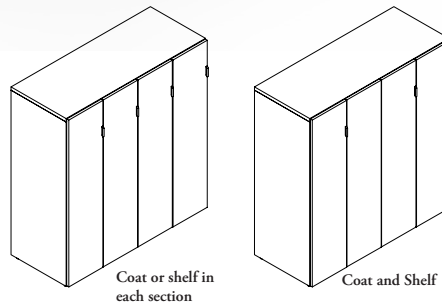

Coat or shelf in each section

Coat and Shelf

Dual Locker (UKD)

- Locker with two sections and options for coats on both sides, shelves on both sides or a combination
- Available in 16" and 19" depths, widths of 24", 30", 36" and 42" and heights of 42", 51" and 66"
- When the coat/coat option, or shelf/shelf option is specified, each door will have separate locks, but if the coat/shelf combination is specified it will only have one lock

Quad Locker (UKQ)

- Locker with four sections and options for coats on both sides, shelves on both sides or a combination
- Available in 16" and 19" depths, width of 48" and heights of 51" and 66"
- When the coat/coat option, or shelf/shelf option is specified, each door will have separate locks, but if the coat/shelf combination is specified each combo section will have one lock

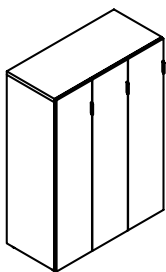

Triple Locker (UKT)

- Available in 16" depth, widths of 36", 42" and 48" and heights of 42", 51" and 66"
- Can be all coat storage or all shelves
- Shelves and coat hooks are reconfigurable

dual, triple and quad lockers

interior configurations

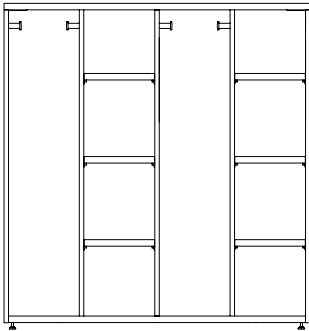

Combination Interior

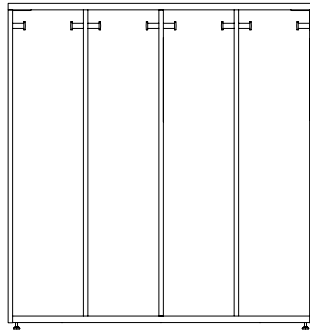

All Coat Interior

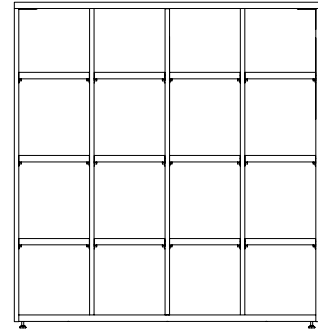

All Shelf Interior

handle locations

dual lockers

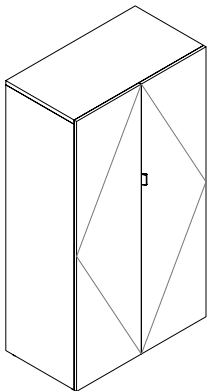

Coat and Shelves

- Will have one handle and will open from middle

triple lockers

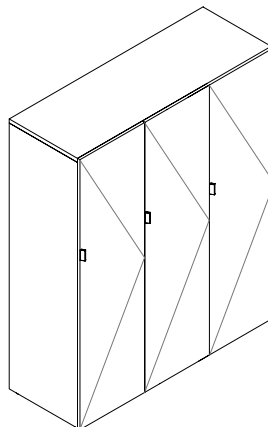

All coats or all shelves

- All sections open in same directions

quad lockers

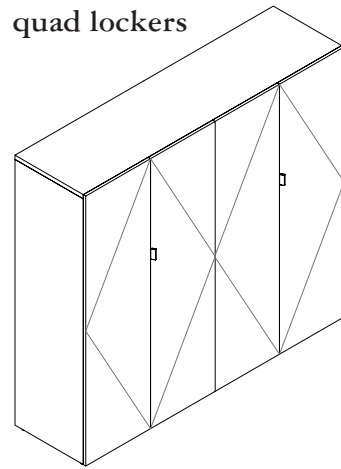

Coat and Shelves

- Will have one handle for each combo section and will open from middle of each section

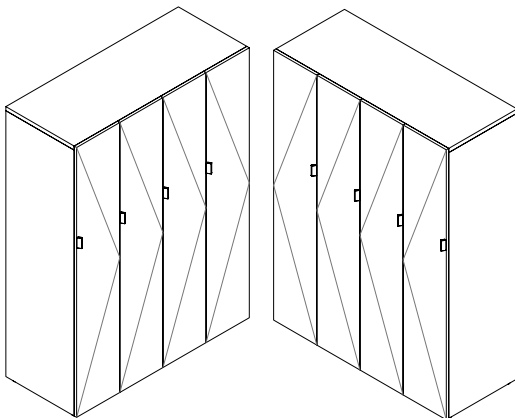

All Coats or all Shelves

- All sections open in same direction

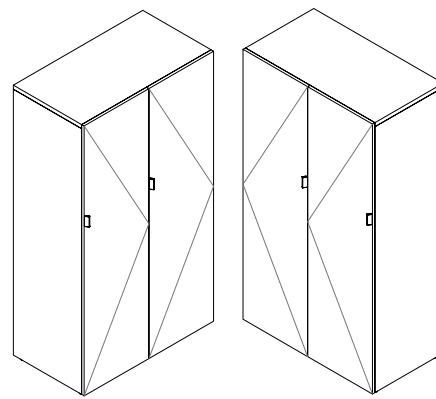

All Coats or all Shelves

- All sections open in same direction

cubby locker basics

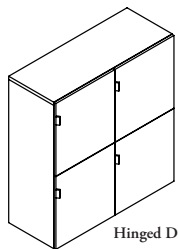
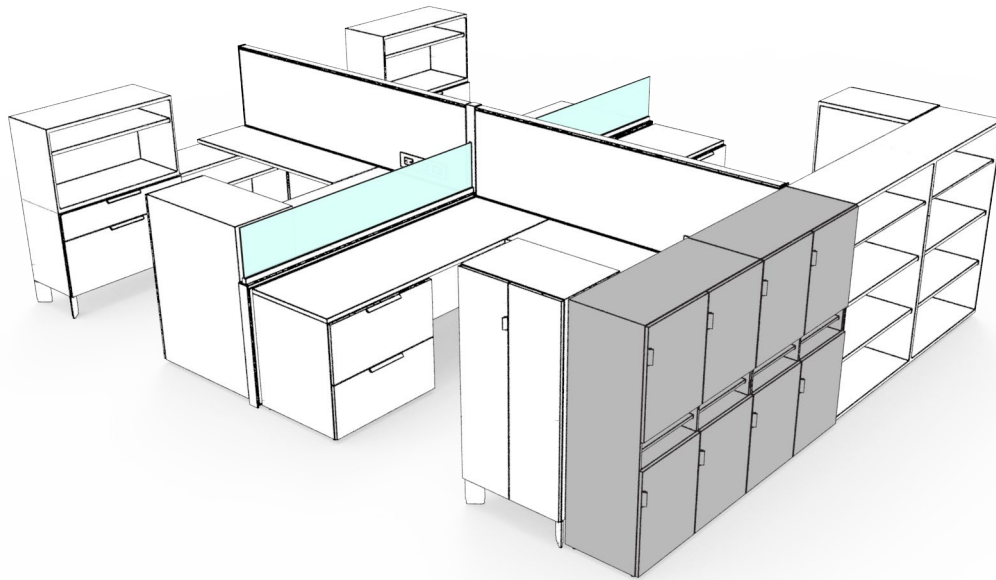

Hinged Doors

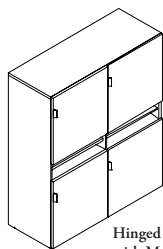

Hinged Doors
with Mail Slots

Cubby Locker (UKN)

- Provides locker cubby storage
- Available in heights 42", 51", and 66" and depth of 16"
- Widths available are 30", 36" and 42"
- Option of hinged doors or hinged doors with mail slots
- **Cannot** be powered

side open towers

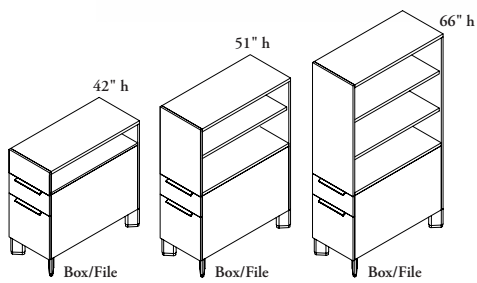
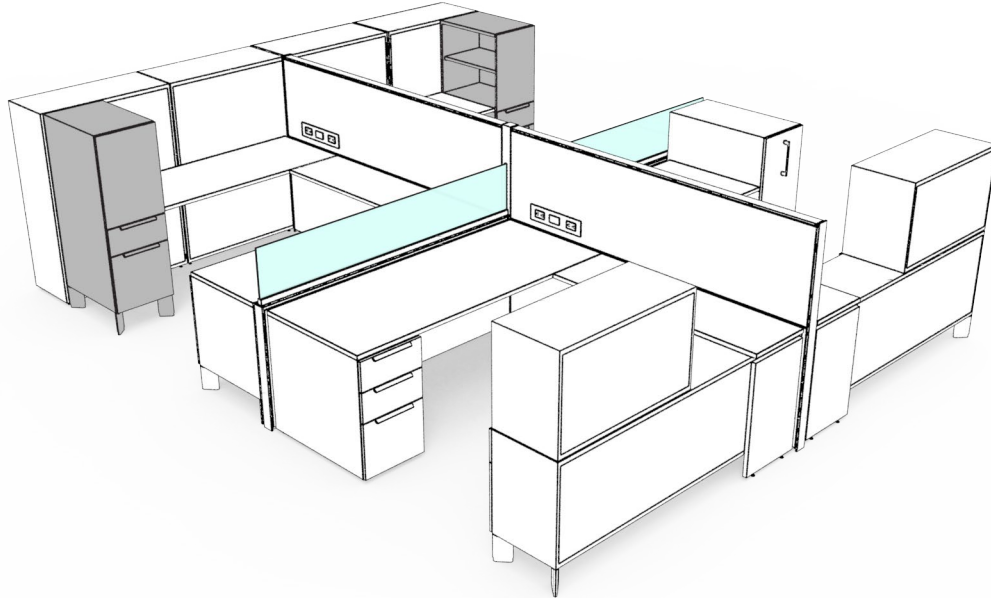

Elevated

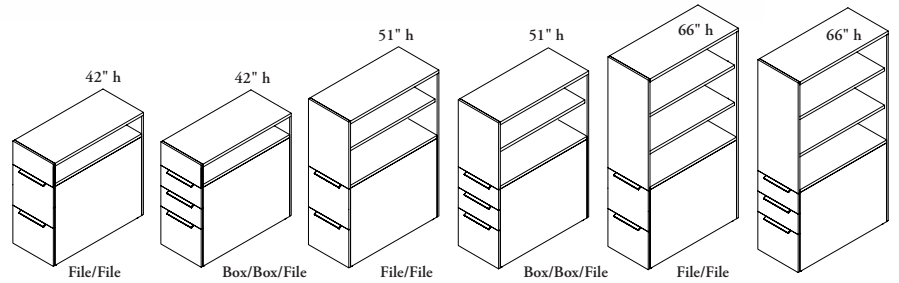

Standard

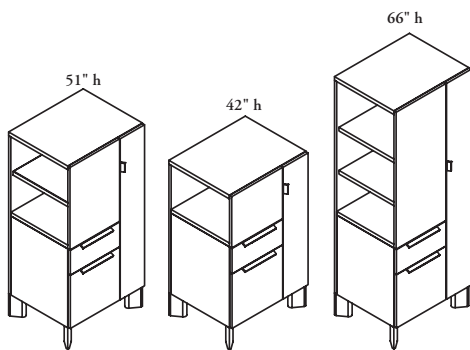

Elevated

Box/File

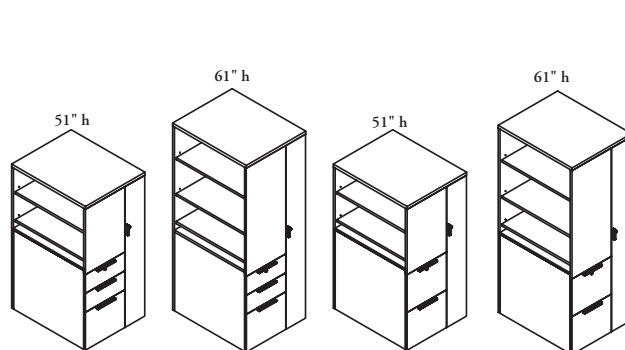

Standard

Box/Box/File

File/File

Side Open Tower (UTW) and Wide Side Open Tower (UTWW)

- Contains front facing box/file drawer for elevated and box/box/file, or file/file drawer for standard, plus side open shelves
- Available in elevated and standard styles, elevated having the angled feet
- Available in heights of 42", 51" and 66" and depths of 19", 23", 29", or 35"
- Open shelves have a solid back, therefore the units are handed, handedness being determined by the side with the open shelves
- Unable to be powered

tower basics (continued)

lateral towers

- Provide filing and storage from the front of the unit, with options for closed back and secure storage
- Available in heights of 42", 51" and 66", widths of 24", 30" and 36" and a depths of 16" and 19" to match Combo Tower depths

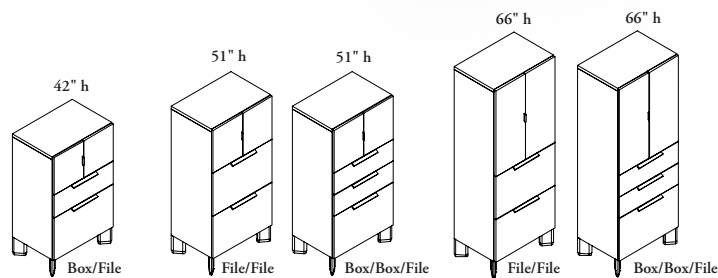
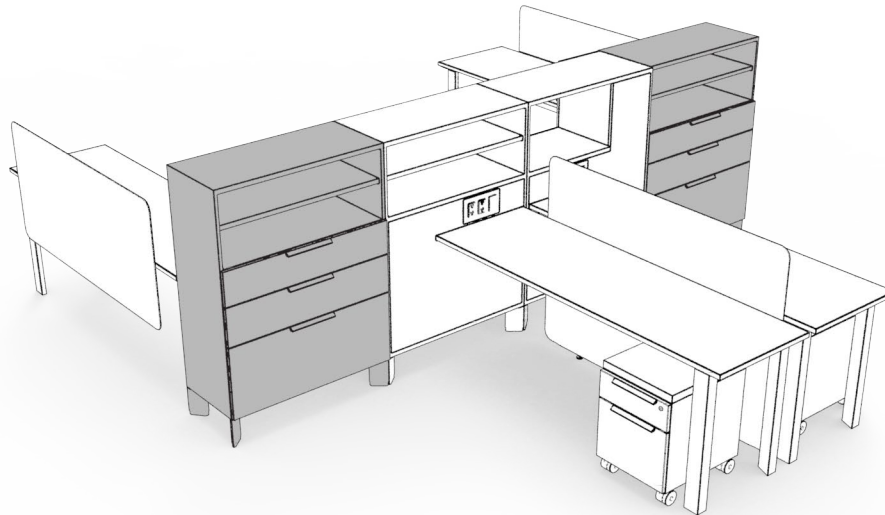

Secured

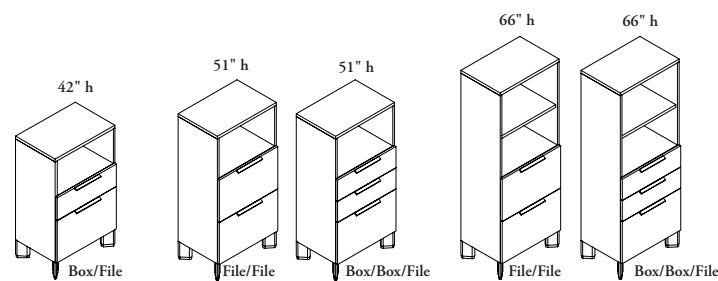

Closed Back

Lateral Tower – Elevated (UTLE)

- Complete with angled legs and options for base back cut out power on all heights and belt-line back cut out electrics on all heights except 42"
- See application pages for all drawer configuration options
- The 42" high Elevated Lateral Tower comes in a Box/File (X) drawer combination
- The 51" and 66" high Elevated Lateral Tower is available in a Box/Box/File (B) or File/File (F) drawer combination
- Belt-line Back Cut Out (E) electrical option **cannot** be specified on the 42" high tower, base back cut out is available on all
- Individual Locks may be specified on the File/File (F) drawer combination

tower basics (continued)

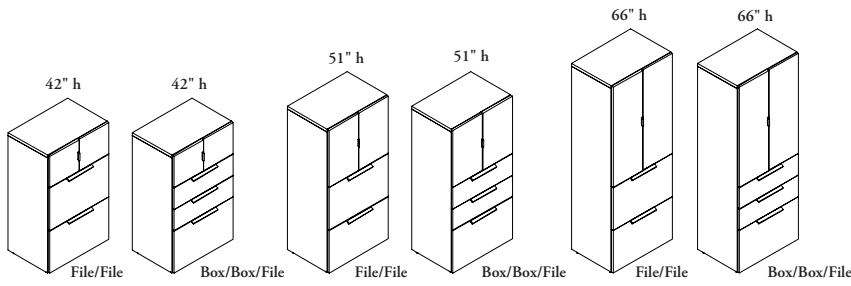

Secured

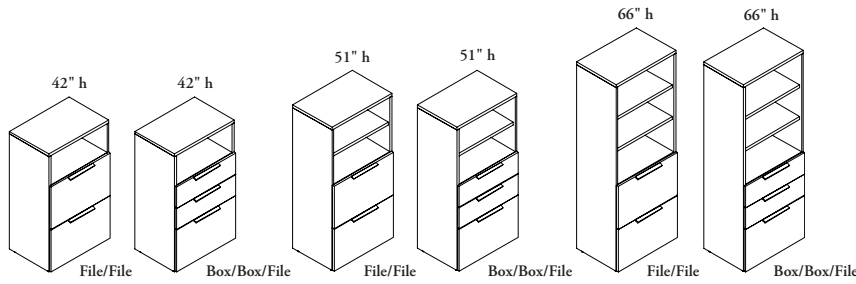

Closed Back

Lateral Tower – Standard (UTLS)

- Unable to be powered
- The 42", 51" and 66" high Standard Lateral Tower is available in a Box/ File (B) or File/File (F) drawer combination.
- Individual Locks may be specified on the File/File (F) drawer combination.

tower basics (continued)

The following outlines the features of District Towers.

combo towers

- Provides coat storage, drawers and shelving
- Available in heights of 42", 51" and 66" and depths of 16" and 19" to match typical District planning depths
- Available in widths from 24" - 48" in 6" increments
- Towers are handed, which is determined by the hinge location of the closet
- Open compartment is available closed back or secured

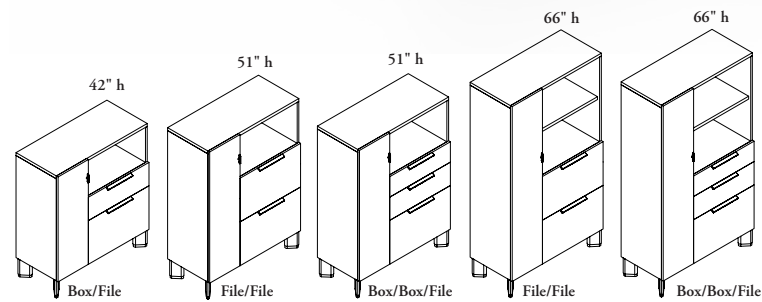
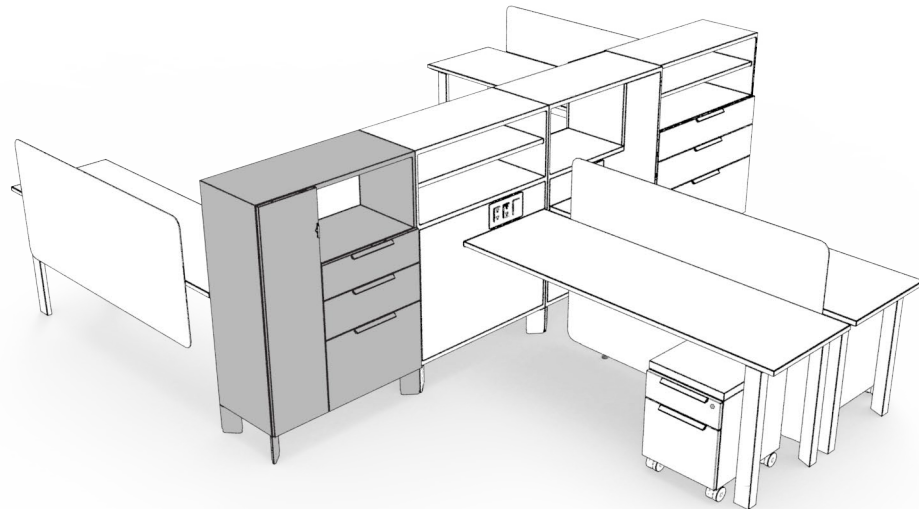

Closed Back

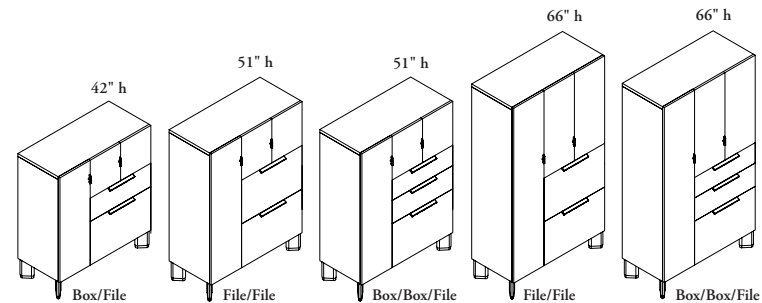

Secured

Combo Tower – Elevated (UTCE)

- Complete with angled legs and options for base back cut out power on all heights and belt-line back cut out on all heights except 42"
- 51" and 66" high cabinets are available with box/box/file and file/file drawer combinations, and the 42" high cabinet is available with a box/file drawer combination only
- 42" high towers include shelves in wardrobe section, 51" and 66" high towers include a coat hook in wardrobe section, 66" high towers include a boot shelf in wardrobe section

tower basics (continued)

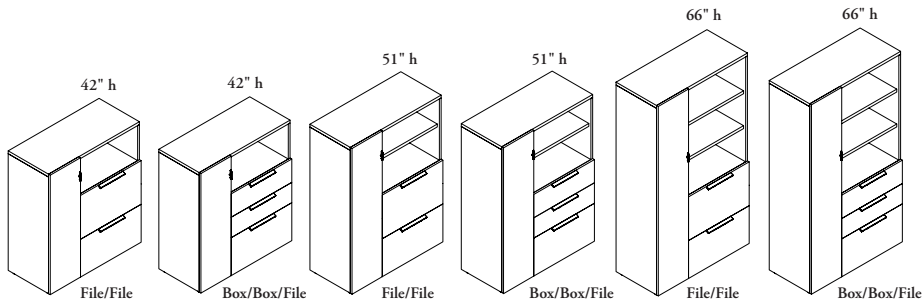

Closed Back

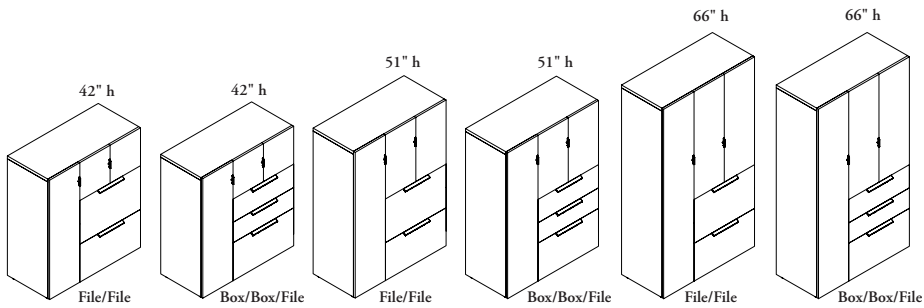

Secured

Combo Tower – Standard (UTCS)

- 42", 51" and 66" high cabinets are available with box/box/file or file/file drawer combinations
- Unable to be powered

planning with towers

The following should be considered with planning with District towers.

combo towers

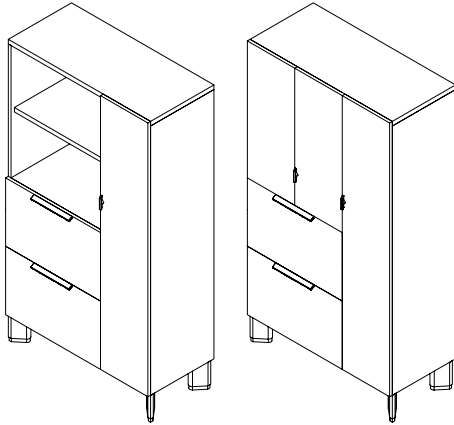

- The combo tower is available with open through, closed back or a secured area above the files

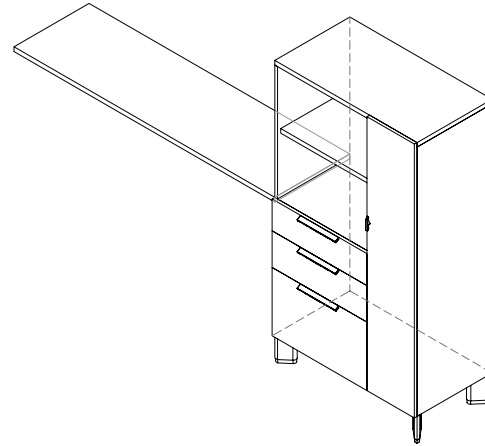

- The 19" deep worksurface can mount to the side of a combo tower

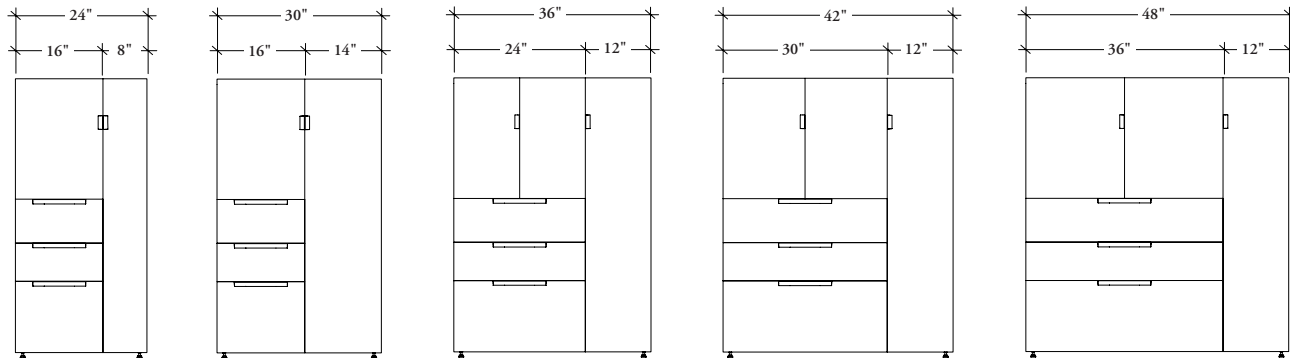

- The 24" and 30" wide combo towers are complete with 16" wide pedestal drawers and have one door on the secured storage section
- The 24" wide tower has an 8" wide wardrobe and the 30" wide tower has a 14" wide wardrobe
- 36", 42" and 48" wide towers have file drawers, with 12" wide wardrobes

planning with towers (continued)

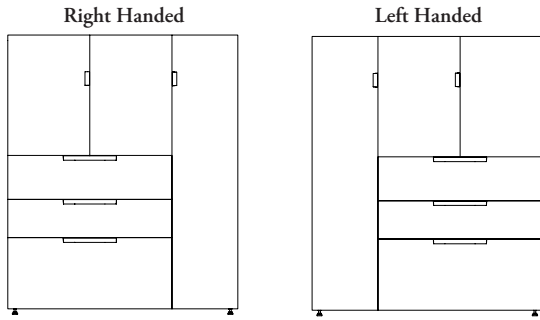

- The handle on the combo tower with two doors (36", 42" and 48" widths) secured storage section are always on the left regardless of whether the wardrobe is on the right or the left

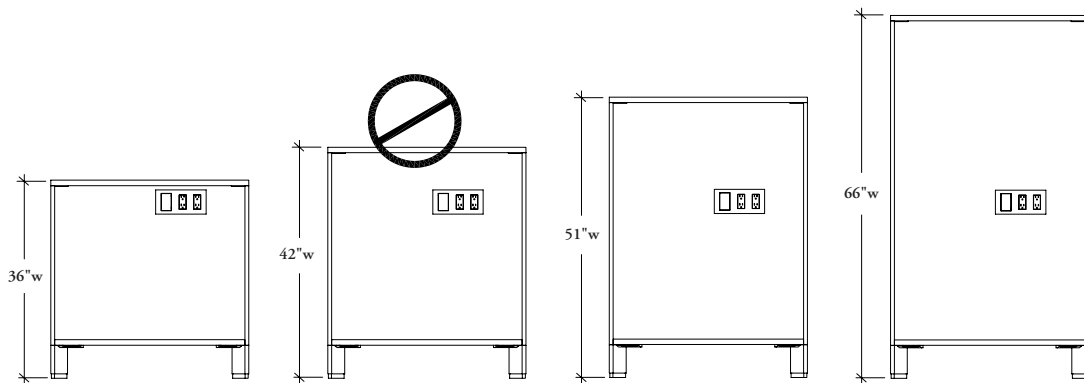

- Belt-line power is available in the 36", 51" and 66" high combo towers, but **not** in the 42" height

side open tower

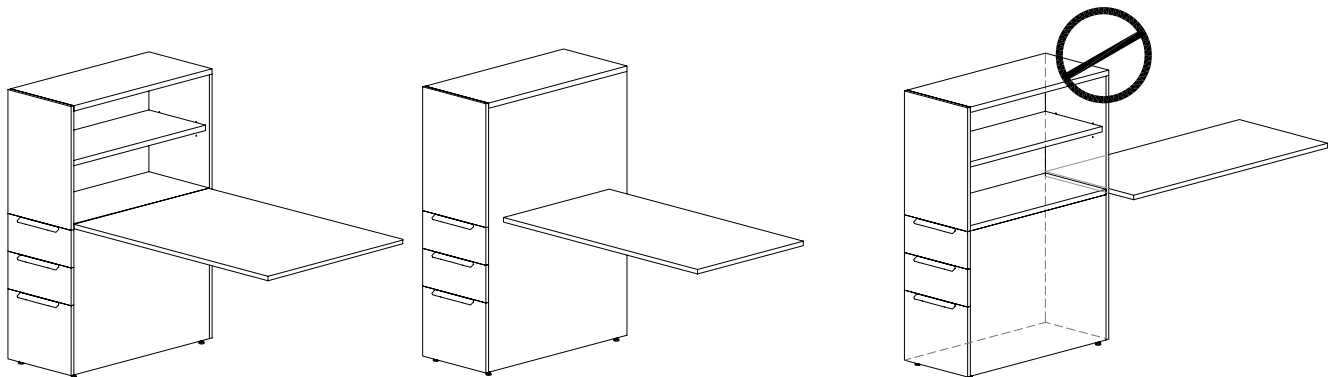

- Worksurfaces can mount to either side of a side open tower with or without a back
- The tower depth must be equal to or greater than the depth of the worksurface
- Worksurfaces are **not** intended to mount to the back of a side open tower

pedestal tower basics

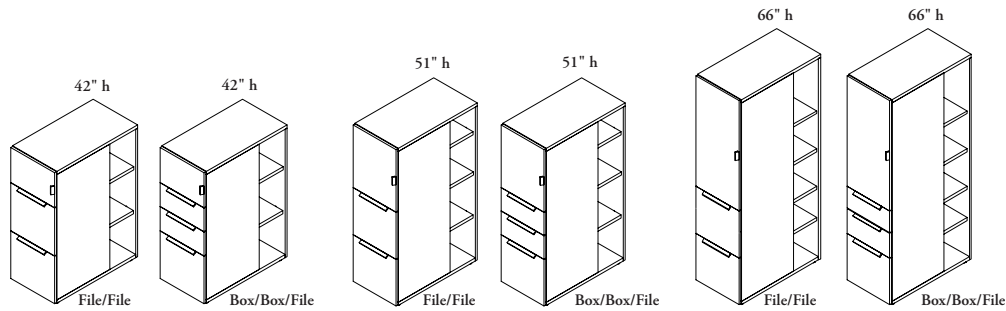
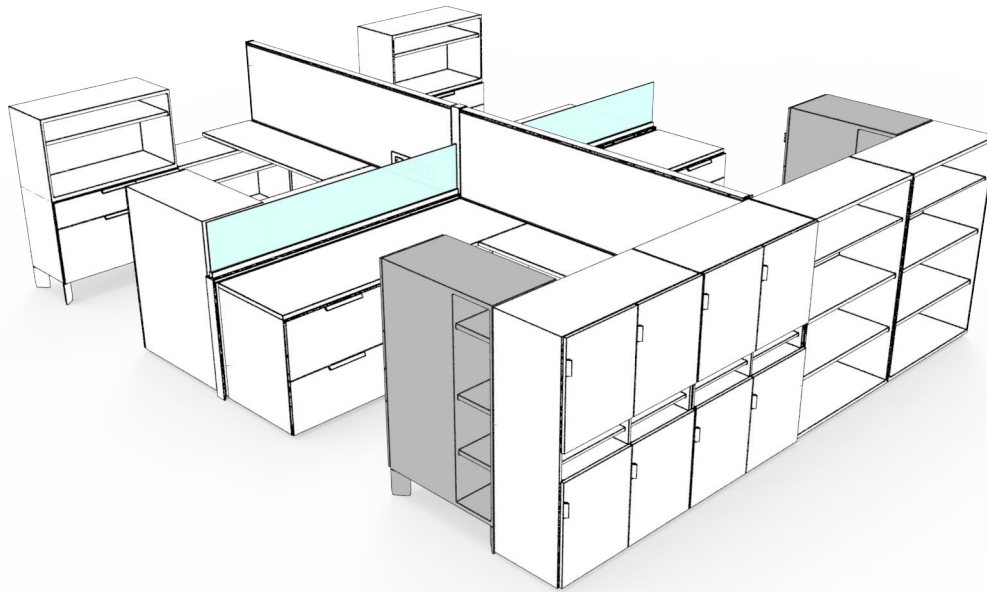

Standard

Pedestal Tower with Cubby (UTDC)

- Provides filing and secure storage from the front of the unit and open cubbies from the side
- Available 16" wide, heights of 42", 51" and 66" and depths of 29" and 35" to match worksurface depths
- Unit **cannot** be powered
- Towers are handed, which is determined by the location of the hinge on the secure section
- In the Standard (S) Style, the 42", 51" and 66" heights are available in Box/Box/File (B) and File/File (F) drawer combinations
- Belt-line Back Cut Out (E) **cannot** be applied to 36" or 42" Pedestal Towers

pedestal tower basics (continued)

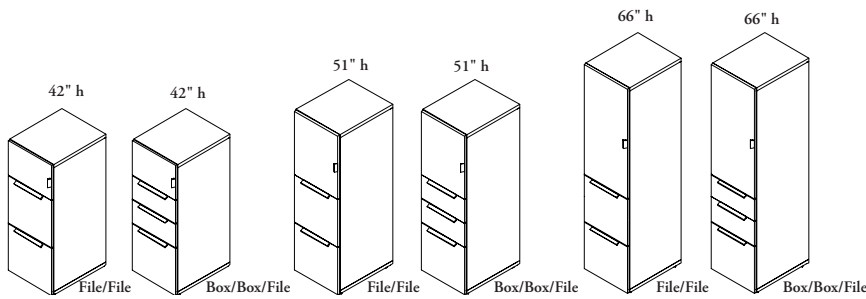

Standard

Pedestal Tower with Solid Back (UTDD)

- Similar to the Pedestal Tower with filing and secure storage, but with no cubbies at back
- Available 16" wide in heights of 42", 51" and 66" and depths of 19" and 23" to match worksurface depths
- Unit **cannot** be powered
- Towers are handed, which is determined by the location of the hinge on the secure section
- See application pages for all drawer configurations options

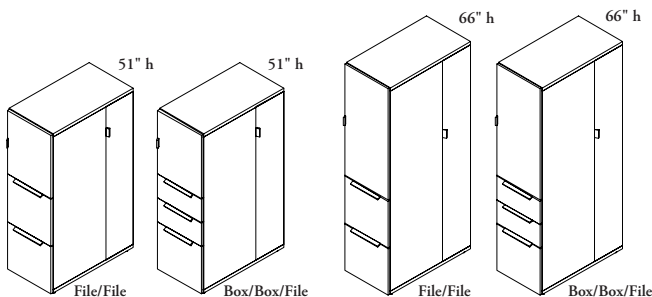

Standard

Pedestal Tower with Side Closet (UTDK)

- Similar to the Pedestal Tower with filing and secure storage, but with a closet on the side
- Available 16" wide, heights of 51" and 66" and depths of 29" and 35"
- Filing section will always be 19" deep with the closet in the 19" being 10" and the 23" depth being 16" deep
- Towers are handed, handedness being determined by the location of the closet
- See application pages for all drawer configurations options

planning with pedestal towers

The following should be considered when planning with pedestal towers.

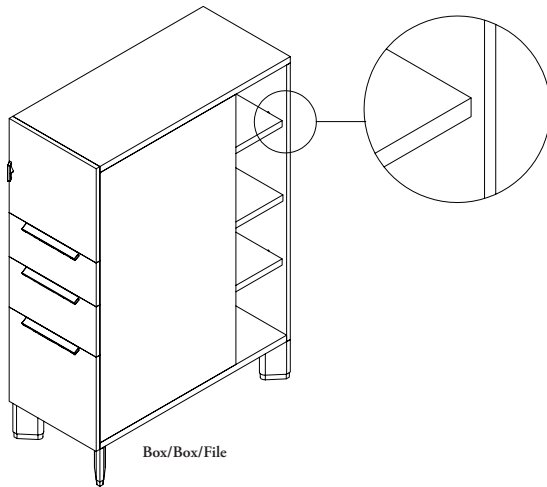

Box/Box/File

- Shelves are inset 1" on the same side as the door hinge to allow for an infill panel (See *Accessories* section)

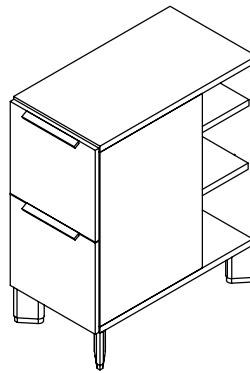

- The 36" high unit, even though it does not have a hinged door, is still considered handed in order to determine the side that the infill will go onto

pedestal towers

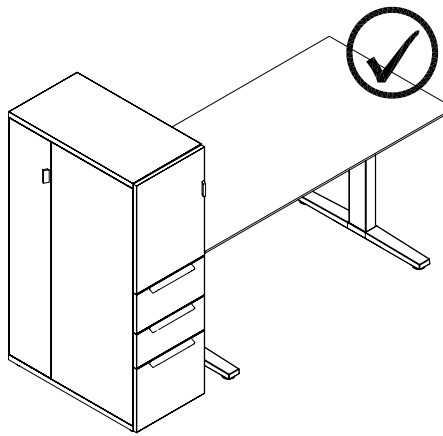
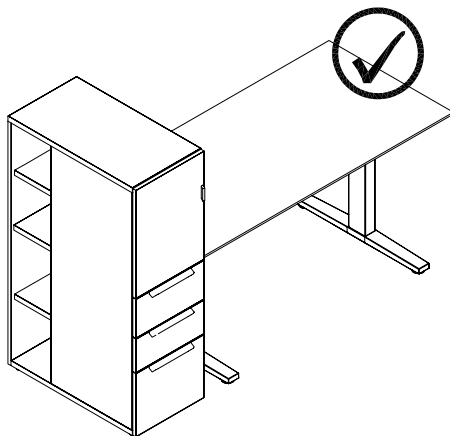

- Pedestal Towers with Cubbies and Side Closet can be used in a freestanding application

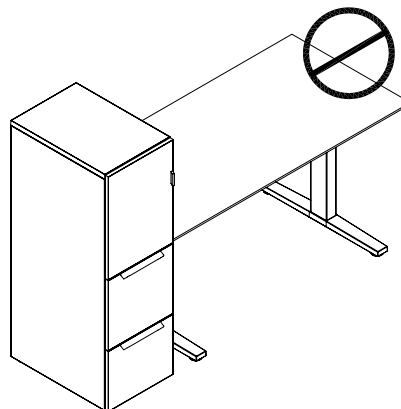
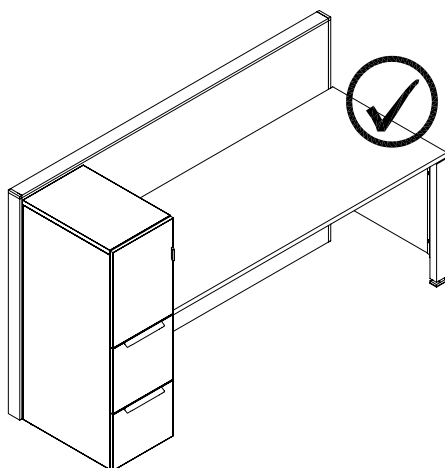

- Pedestal Towers with Solid Backs **cannot** be used in a freestanding application because counterweights are **not** available, they must be attached to a panel, worksurface or another storage unit

storage-to-storage support basics

The following outlines the features of storage-to-storage support.

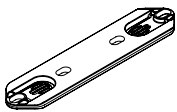
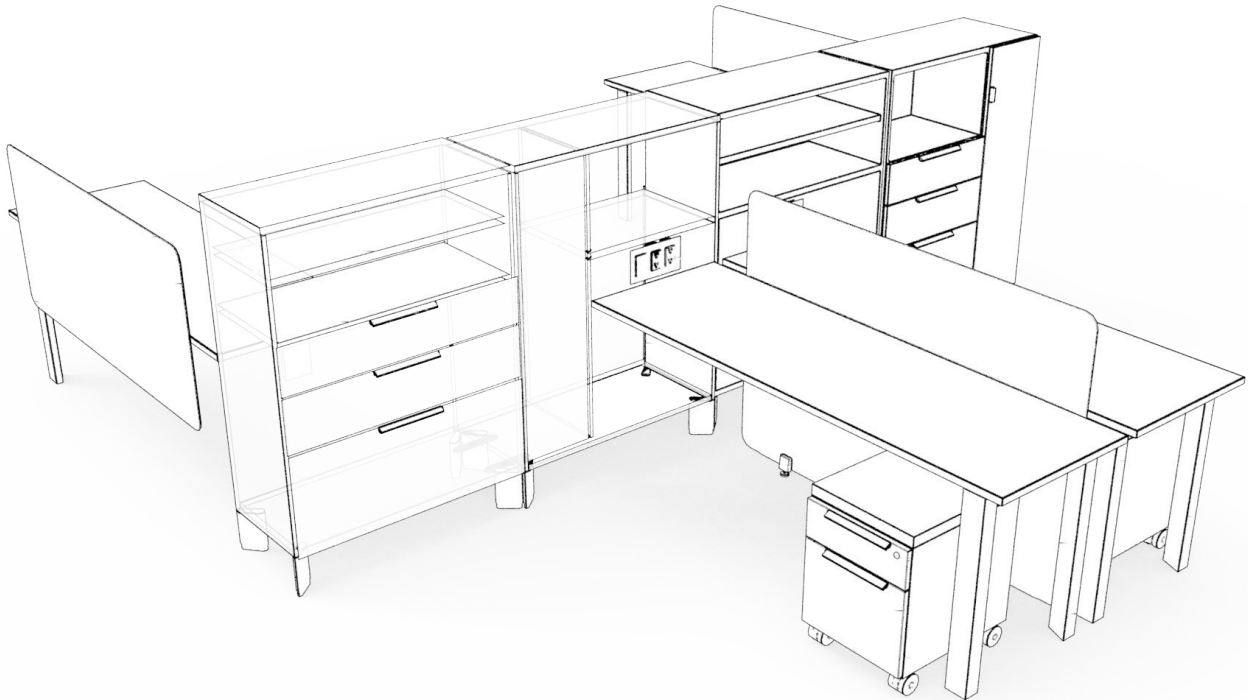

For Elevated Storage

Linking Bracket for Elevated Storage (UNSLBE)

- Connect storage units together
- Used to align cabinets in space applications
- Must be used when routing electrics beneath a storage spine

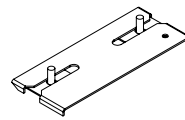

For Standard Storage

Linking Bracket for Standard Storage (UNSLBS)

- Standard storage units can be linked together for alignment and stability

overhead basics

The following outlines the features of District Overheads.

overhead cabinets

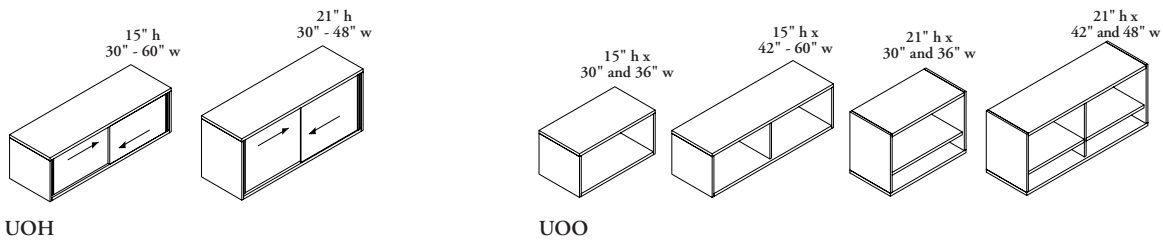
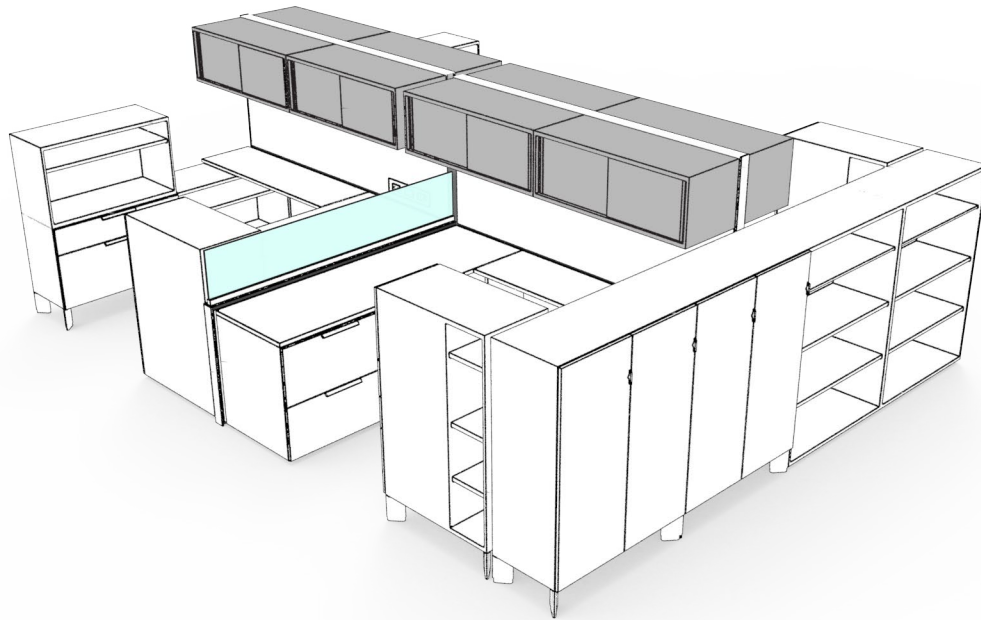

Sliding Door Overhead (UOH) and Open Overhead (UOO)

- Mount on-module to District panels, Altos walls, Leverage and drywall
- Proper mounting hardware must be specified

planning with overhead cabinets

The following should be considered with planning with District overheads.

panel-mounted overheads

- 15" and 21" high Sliding Door Overhead (UOH) and 15" and 21" high Open Overhead Cabinets (UOO) can be panel-mounted in a traditional panel layout

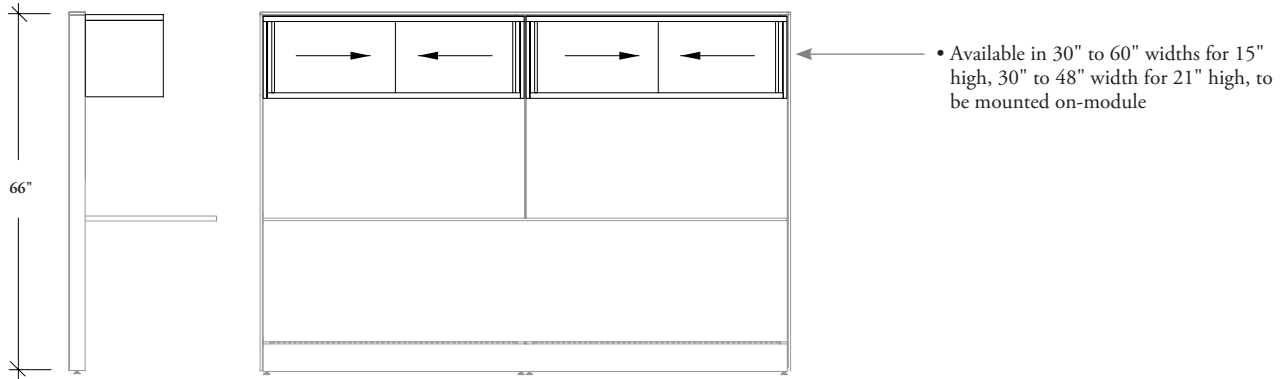

panel support for overheads

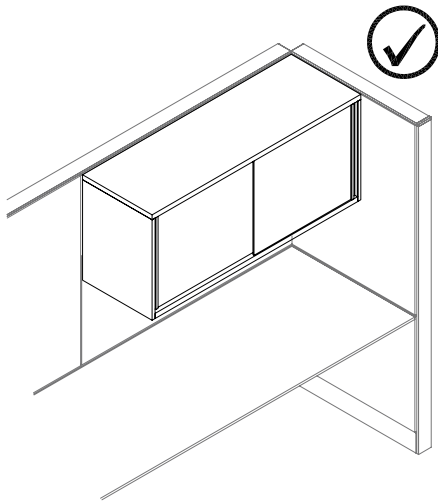

- Overhead storage must be mounted at a corner where panels meet at 90° to ensure proper support

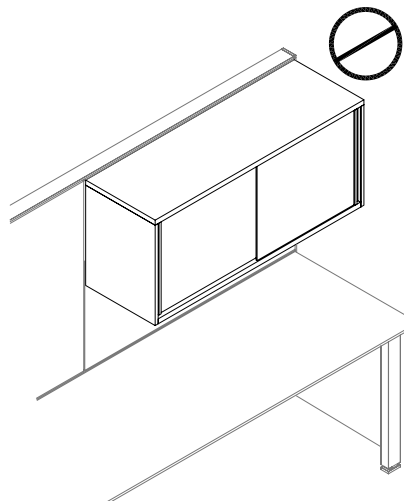

- A work surface with floor support alone does **not** provide adequate support

planning with overhead cabinets (continued)

off-module restriction

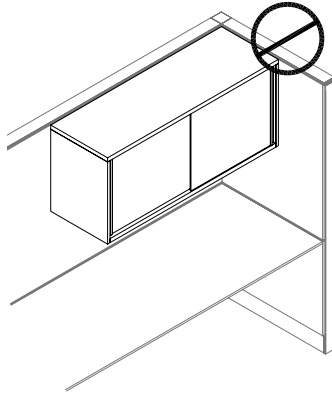
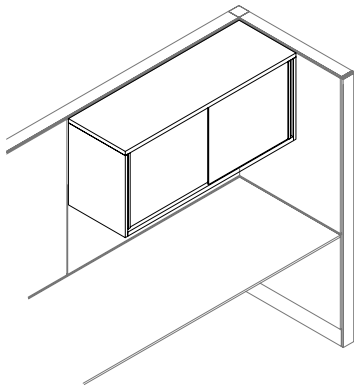

- Overheads must be mounted on-module
- They require a vertical channel on both sides for mounting
- On panels over 60" wide which consist of two frames, two separate fascias can be specified to allow access to the center vertical channel

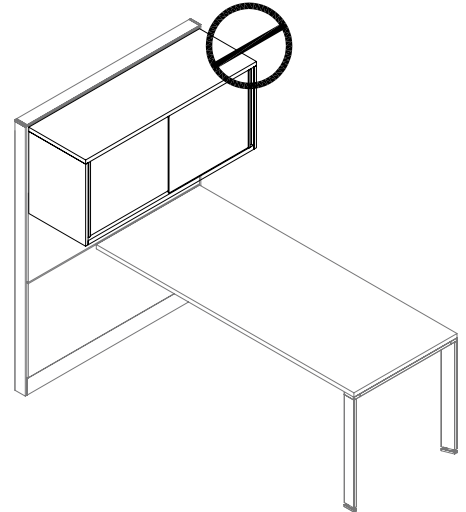
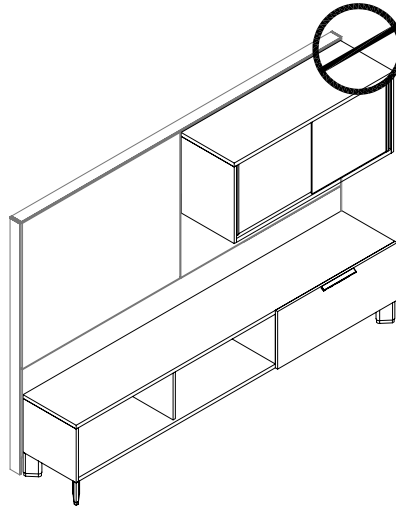
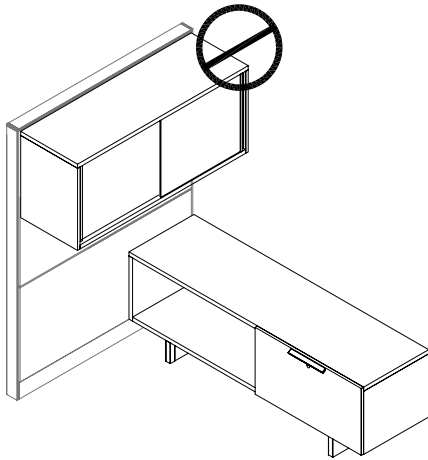

- Neither a panel-mounted perpendicular or panel-mounted parallel storage unit will adequately support an overhead
- A semi-supported worksurface will **not** support a overhead

centermount overhead basics

The following outlines the features of District Centermount Overheads.

centermount overhead cabinets

- Centermounts mounted on-module on top of District and Leverage panels
- Widths range from 30" - 96" depending on application and finish
- Available in heights of 9", 15" and 21" to match typical District datum heights
- Available with sliding doors or open
- Available single- or double-sided
- Double-sided overhead is handed, which is determined by the side of the open cabinet

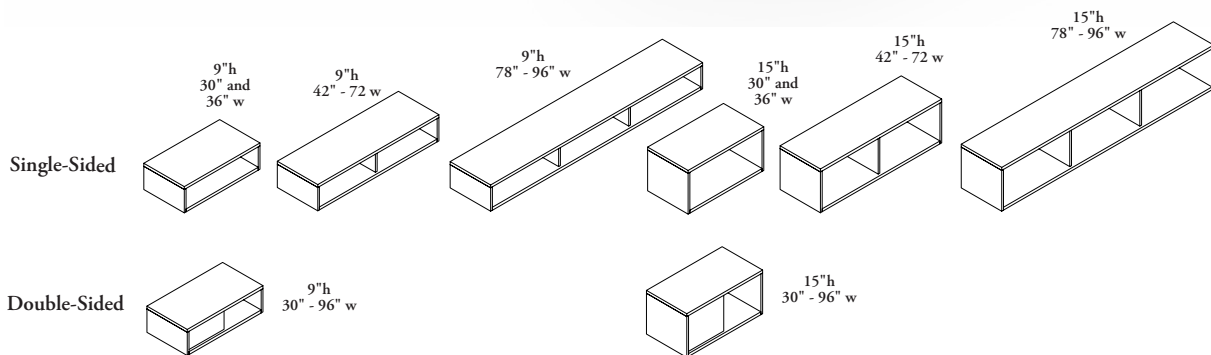
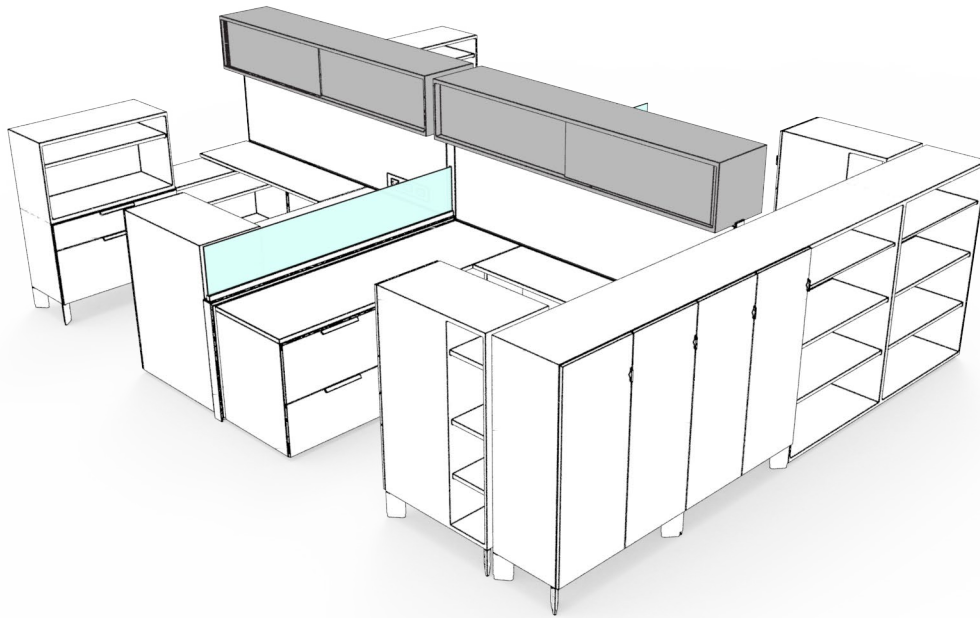

Open Centermount Overhead (UOOC)

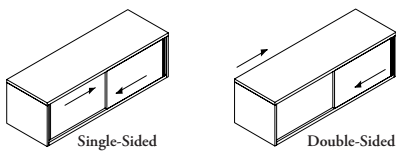

Sliding Door Centermount Overhead (UOHC)

planning with centermount overhead cabinets

The following should be considered when planning with District Centermount Cabinets.

mounted directly to panel top

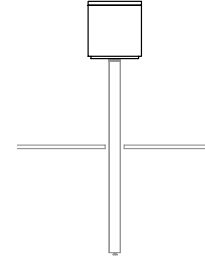
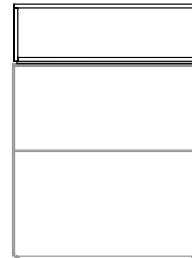
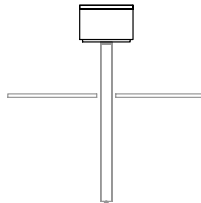
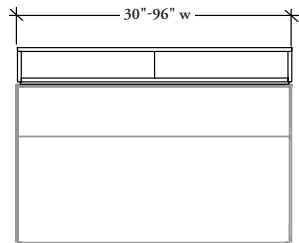

- The UOHC and UOOC can be mounted directly on to the top of a Panel Wall
- When planning with District with Inset Glass Panel (UYPF, UYPER and UYPCR), a return panel must be specified on both sides of a panel run when using center mounted overhead storage

- The Centermount Cabinet Bracket & Top Trim (UNODT) is required for mounting to the panel and must be the same width as the cabinet

mounted above panel with centermount posts

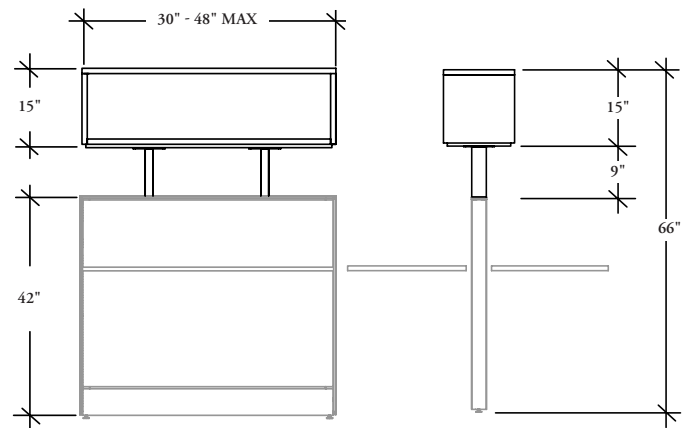
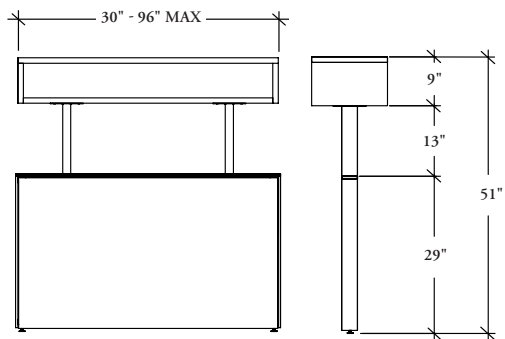

- Overheads can be mounted on posts over the panel – the Centermount Cabinet Support Posts & Trim (UNOPT) centermount post is 9" or 13" high and is used to match typical Teknion datum heights
- Overheads mounted on posts **cannot** be applied to District with Inset Glass Panels (UYPF, UYPER, UYPCR)

planning with centermount overhead cabinets (continued)

cabinet widths

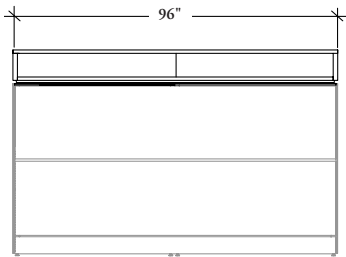

- 9" and 15" high cabinets are available up to 96" wide for flush mounting (Laminate is only available to 90" wide)

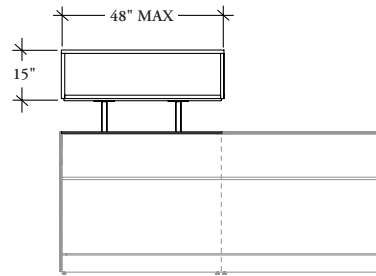

- When 15" high cabinets are mounted on posts, the maximum width allowed is 48"

on-module mounting

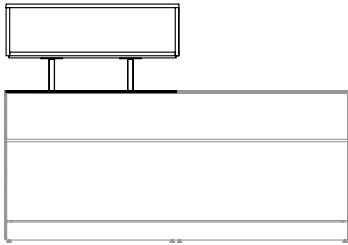

- Supports attach to specific cut out locations in the top rail of the panel wall frame. The cabinet width and posts must match the panel wall frame width (30" - 48") and mount on-module to the frame. Panel wall widths specified over 60" provide two equal width frames. The above diagram shows on-module alignment with one of these frames
- A Top Trim (UNTT) is required to complete the remainder of the frame with no cabinet mounted to it

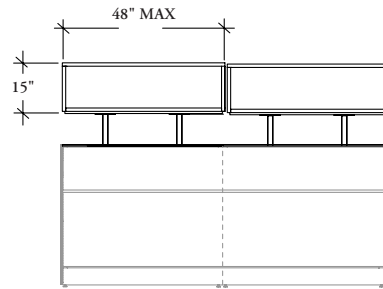

- One or two cabinets can span the width of a panel on panels over 60" wide made up of two frames each cabinet must be equal to the widths of the individual frames

off-module mounting

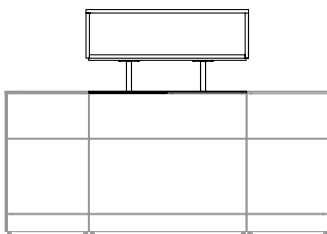

- If the cabinet requires centering across the width of the workstation, Panel Walls must be planned so that the center Panel Wall width matches the cabinet/support width

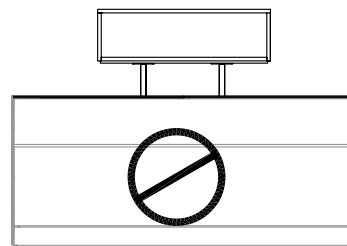

- This application will **not** work

side filer & mini side filer basics

The following outlines the features of District Side Filer and Mini Side Filers.

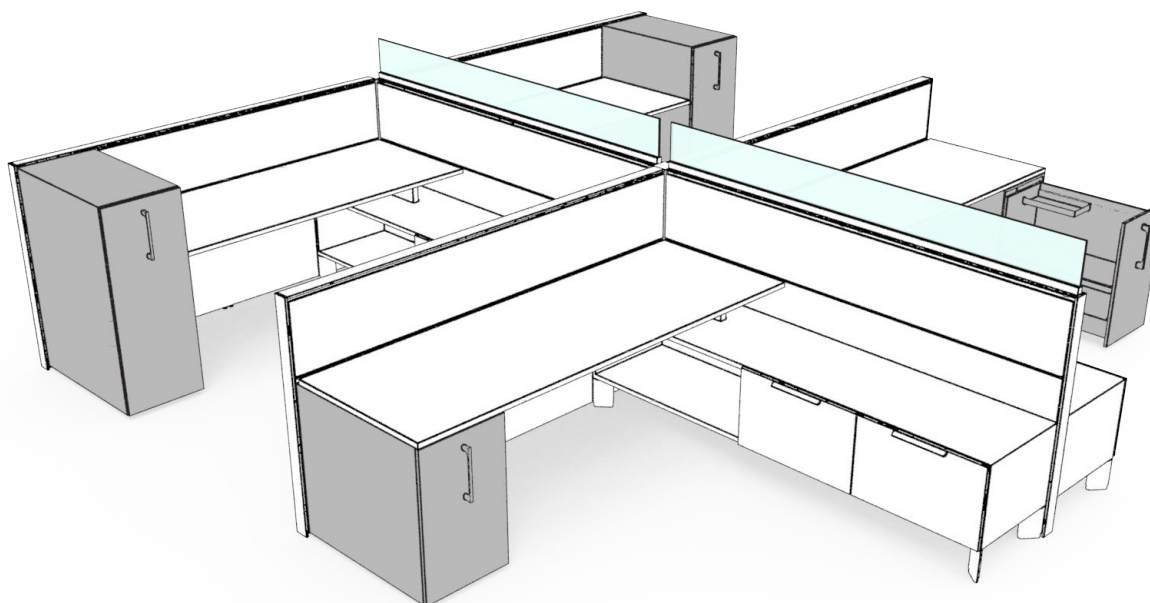

- Side Filers and Mini Side Filers provide personal storage
- Side Filers provide personal storage and space division
- Available left or right handed, handedness is determined by the location of the Side Filer in relation to the user
- Width: 16"

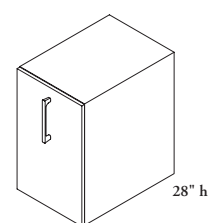
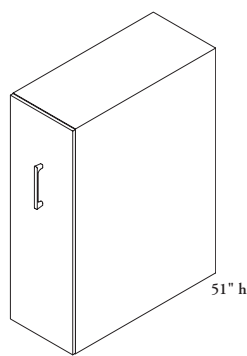
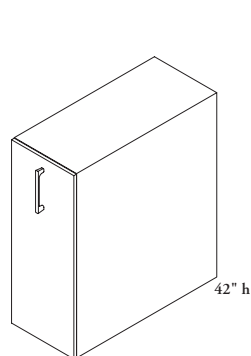

Side Filer (UTS)

- Heights: 42" and 51"
- Depths: 24", 30" and 36"
- Can be used:
 - with fixed height tables
 - with height-adjustable tables
 - freestanding
- Leveling Range:
 - no leveling range since the unit is supported with a caster when extended
 - the levelers ensure that the unit is plum

- Available in six Configurations:
 - (N) No Accessories, with Wardrobe
 - (A) Accessory Bundle A, with Wardrobe
 - (B) Accessory Bundle B, with Wardrobe
 - (K) No Accessories, No Wardrobe
 - (M) Accessory Bundle A, No Wardrobe
 - (P) Accessory Bundle B, No Wardrobe
- USB Options:
 - (N) No USB
 - (S) Grommet on the Side
 - (B) Grommet on the Bottom
- Lock Option is standard locks

Mini Side Filer (UTM)

- Height: 28"
- Depths: 23" and 29"
- Provides support to a worksurface
- Leveling Range is -0.5" to +2.5"
- Available in three Configurations:
 - (N) No Accessories
 - (A) Accessory Bundle A
 - (B) Accessory Bundle B
- Available with optional USB
- Lock Option is standard locks

planning with side filers

interior configurations of side filers

All Side Filers are complete with accessory shelves, rails, bag drop area and the option for a wardrobe and accessory bundles. The storage area will vary depending on the depth and configuration selected. See details of Accessory Bundle configurations in this section.

42" High Side Filer

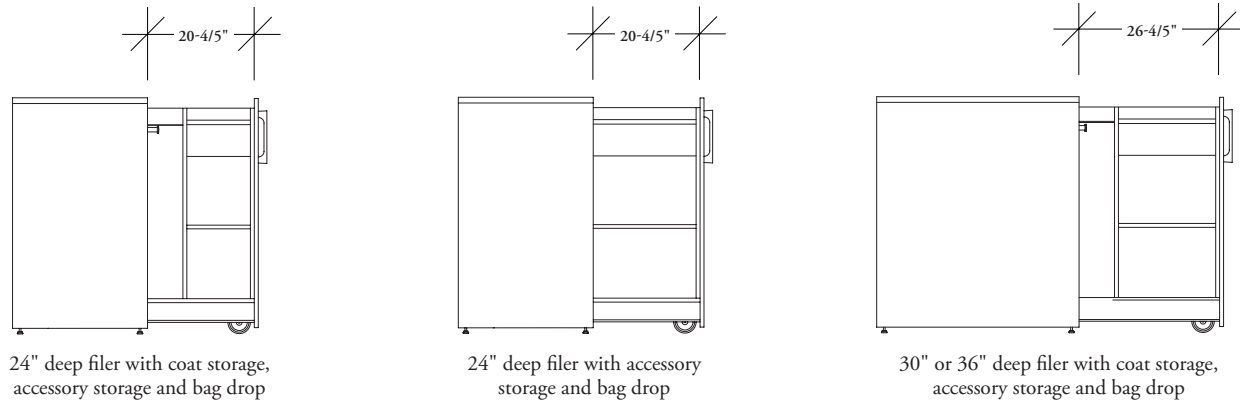

51" High Side Filer

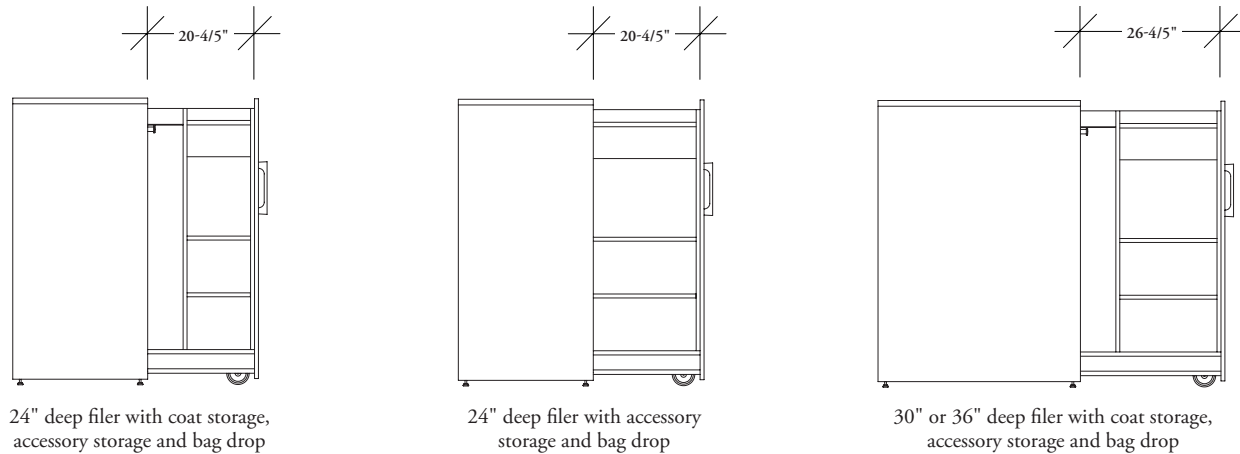

interior configurations of mini side filers

All mini side filers are complete with a mini shelf, accessory rail, lower cubby and optional accessory bundle. The storage area will vary depending on the depth and configuration selected. See details of Accessory Bundle configurations in this section.

28" High Mini Side Filer

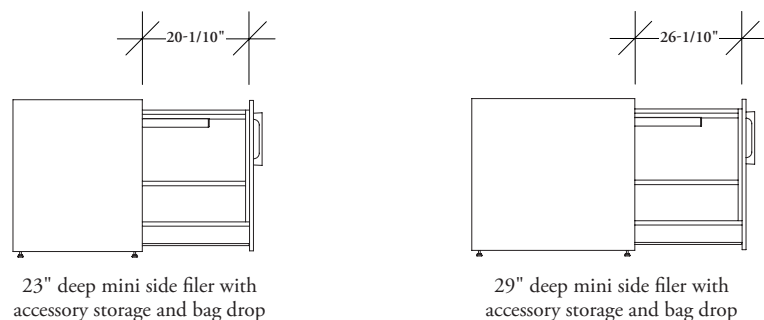

planning with side filers (continued)

The following should be considered when planning with District Side Filers.

parallel planning

When planning with a panel behind the Side Filer, there will be a 3/8" gap between the Side Filer and worksurface.

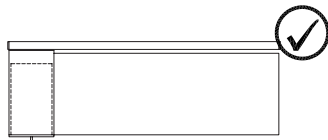

Single-Sided Application

- When planning with Side Filers in Single-Sided Applications there must be added support by specifying a Flush End Gable (UNGEF)

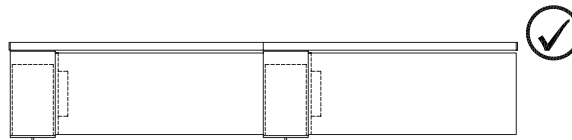

Single-Sided Application

- Parallel planning with Side Filers.
- Single-Sided Applications must have added support by specifying a Flush End Gable (UNGEF)

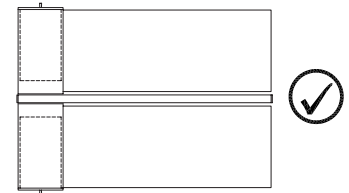

Back-to-Back Application

parallel planning with panel behind side filer

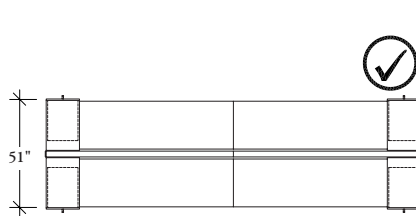

24" deep worksurface with 24" deep side filer

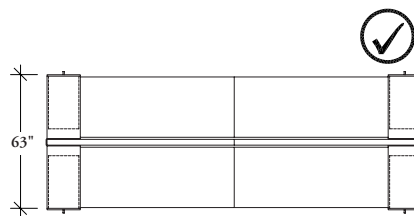

30" deep worksurface with 30" deep side filer

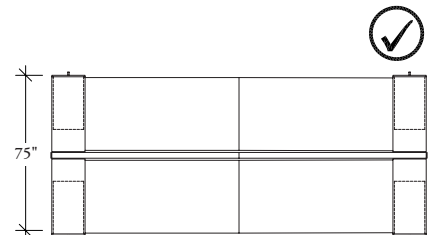

36" deep worksurface with 36" deep side filer

parallel planning with no panel behind side filer

When planning with no panel behind the Side Filers, the Side Filer will extend beyond the front edge of the worksurface.

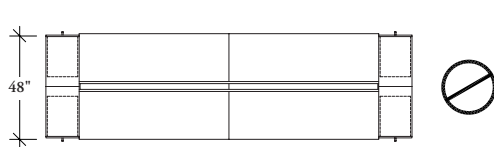

24" deep worksurface with 24" deep side filer

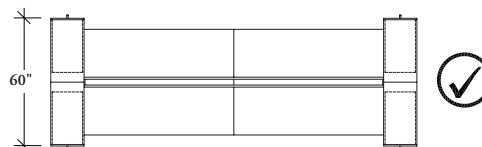

24" deep worksurface with 30" deep side filer

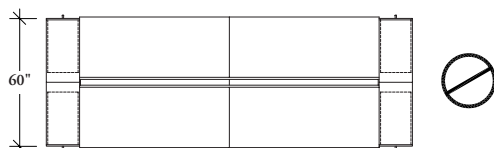

30" deep worksurface with 30" deep side filer

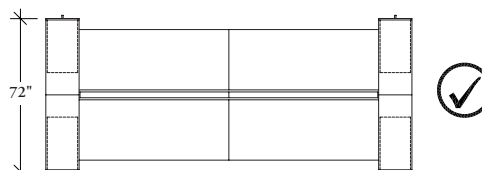

30" deep worksurface with 36" deep side filer

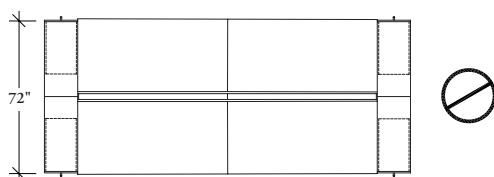

36" deep worksurface with 36" deep side filer

planning with side filers (continued)

parallel planning with side filers and height-adjustable tables

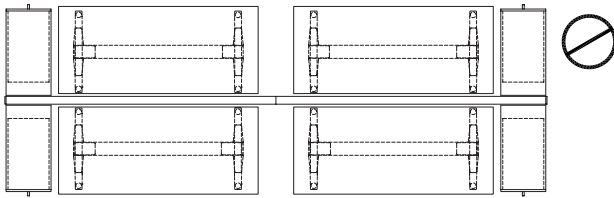

Non-Freestanding Planning

Panels **cannot** support Side Filers and worksurfaces without extra support.

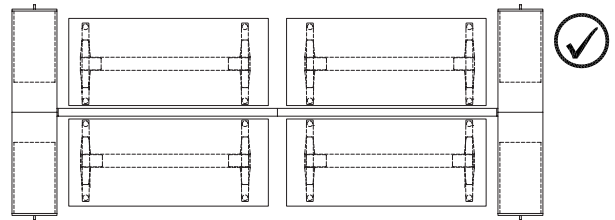

Freestanding Planning

Freestanding District panel solution allows for height-adjustable use with panels and Side Filers.

perpendicular planning

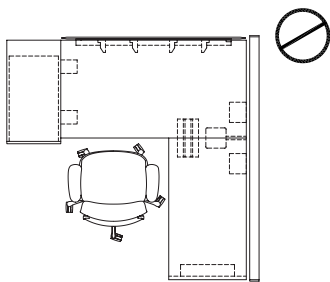

When planning in perpendicular applications, there must always be a panel behind the worksurface for stability.

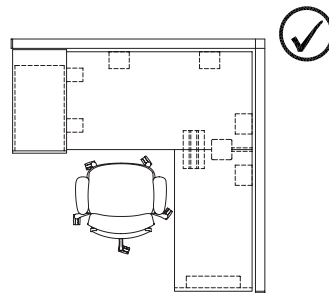

When planning in perpendicular applications with a panel behind the Side Filer, there will be a 3/8" gap between the worksurface and panel.

planning with mini side filers

The following should be considered when planning with Mini Side Filers.

Mini Side Filers can be planned in parallel and perpendicular applications. They can be flush to the worksurface and are worksurface supporting.

parallel planning

When planning with a panel behind the Mini Side Filer, there will be a 1" gap.

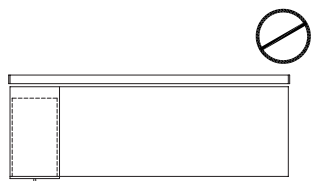

Single-Sided Application

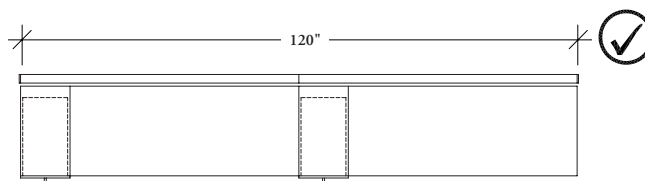

Single-Sided Application

The Run must be minimum 120" in length.

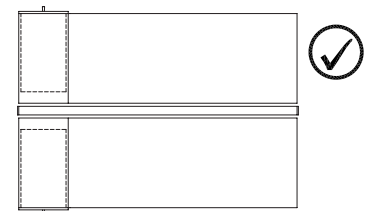

Back-to-Back Application

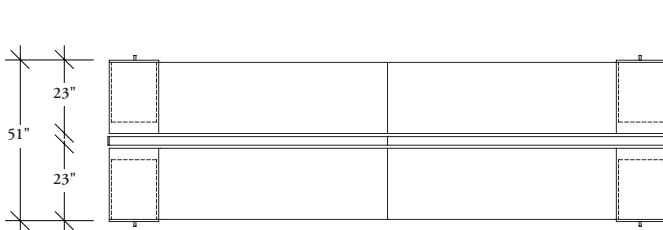

The 24" deep worksurface with 23" deep Mini Side Filer.

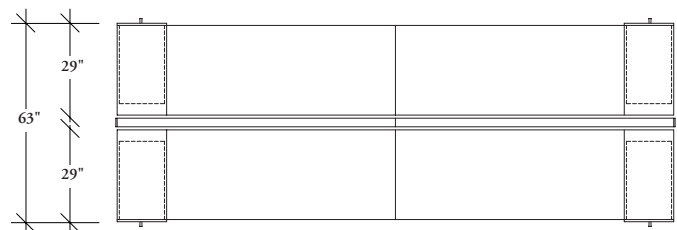

The 30" deep worksurface with 29" deep Mini Side Filer.

perpendicular planning

When planning perpendicular with the Mini Side Filers, there must always be a District panel along the back of the worksurface.

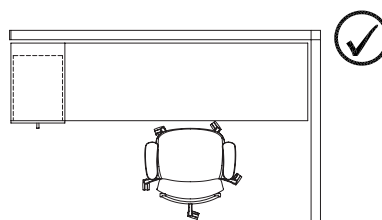
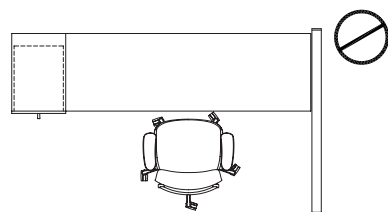

planning with side filers & mini side filers

handedness

Handedness is determined by the location of the Side Filer and Mini Side Filer in relation to the user.

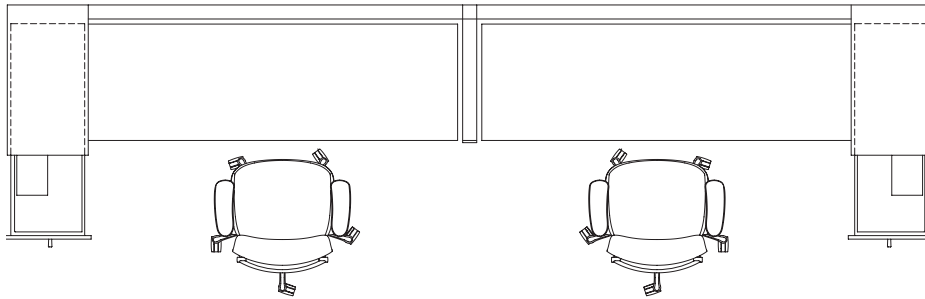

Left Hand Orientation

Right Hand Orientation

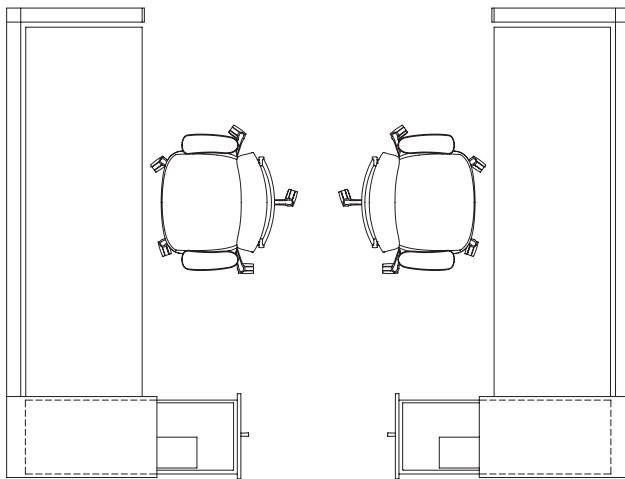

When planning with side filers and mini side filers, sufficient clearance must be left between workstations to allow both side filers to be opened at the same time.

planning with side filers & mini side filers (continued)

The following should be considered when planning with Side Filers, Mini Side Filers and connecting to panels.

connecting to panels

District Side Filer Support Kits (UWSPK) are used to connect both Side Filers and Mini Side Filers to panels. Support kits include a Tower Bracket Kit, Worksurface Panel Wall Bracket and a Panel to Storage Bracket.

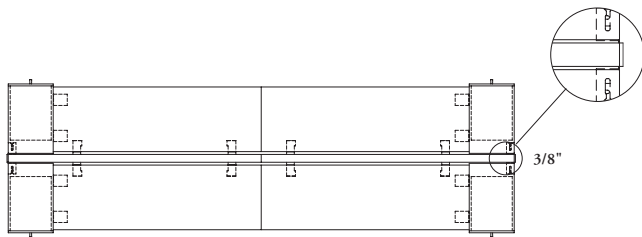
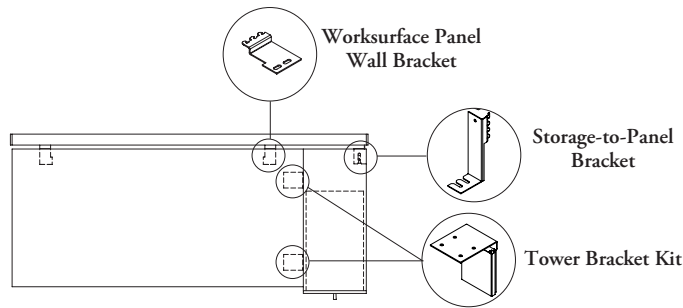

Side Filer

There will be a 3/8" gap between Side Filer (UTS) and the panel when using a District Side Filer Support Kit (UWSPK).

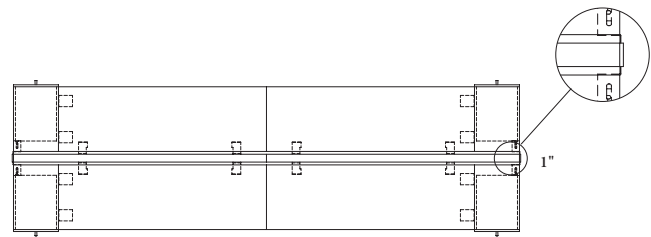

Mini Side Filer

There will be a 1" gap between Mini Side Filer (UTM) and the panel when using a District Side Filer Support Kit (UWSPK).

handedness with support kits

District Side Filer Support Kits (UWSPK) are handed.

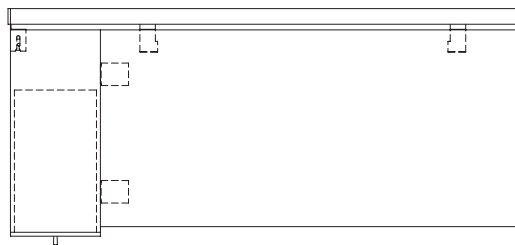

Left Handed Orientation Application

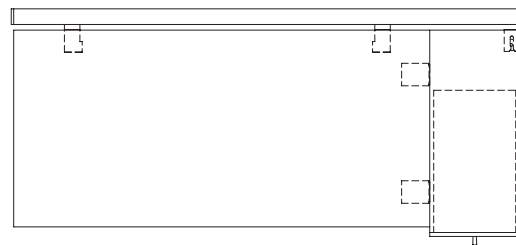

Right Handed Orientation Application

planning with side filer, mini side filer & USB power

The following should be considered when planning with District Side Filers, District Mini Side Filers and USB Power.

The optional USB add-on provides two USB-A ports in the pocket drop area to allow for the charging of USB powered devices.

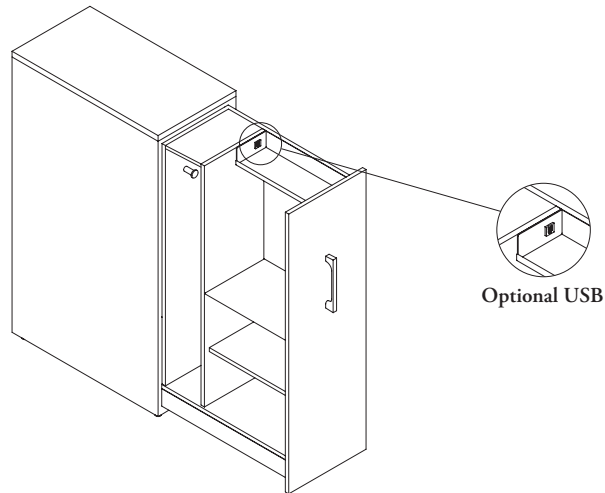

power cord locations

The power location for Side Filers can be specified in either the bottom (non-handed) or on the side (handed) of the unit. For Mini Side Filers, the power cord location can only be specified on the side (handed) of the unit.

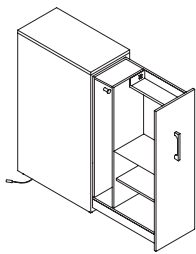

Side Filer
Bottom Power Location

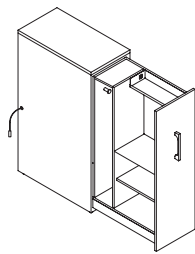

Side Filer
Right Side Power Location

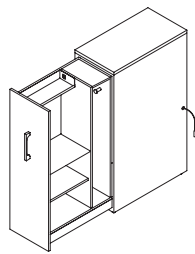

Side Filer
Left Side Power Location

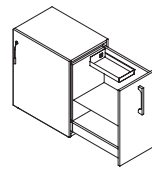

Mini Side Filer
Right Side Power Location

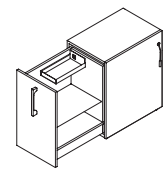

Mini Side Filer
Left Side Power Location

power cord heights

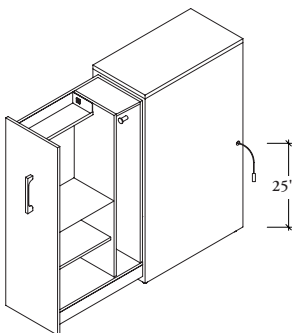

- Height from floor to power cord location in Side Filers is 25" high
- The side filer can be planned at least 50" away from a power source

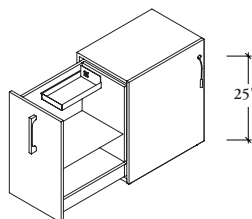

- Height from floor to power cord location in Mini Side Filers is 25" high
- The mini side filer can be planned at least 80" from a power source

planning with side filer, mini side filer & USB power (continued)

side filers with fixed worksurfaces

- When planning parallel with Fixed Worksurfaces and Side Filers, the power cord will run from the side of the Filer (left shown) to Power Rod, Under-Worksurface Mount with Cable Tray (YEPD6)
- It is recommended Wire Management Clips (YESW) are specified. It is available from Complements: *Electrics Program*

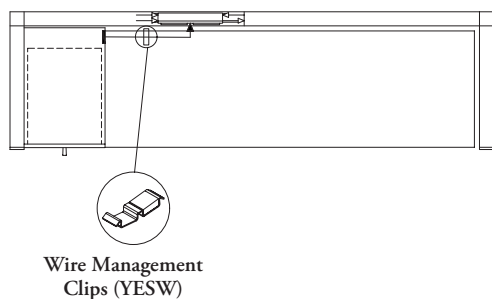

- When planning perpendicular with Fixed Worksurfaces and Side Filers, the power cord will run from the side of the Filer (left shown) to Power Rod, Under-Worksurface Mount with Cable Tray (YEPD6)
- It is recommended Wire Management Clips (YESW) are specified. It is available from Complements: *Electrics Program*

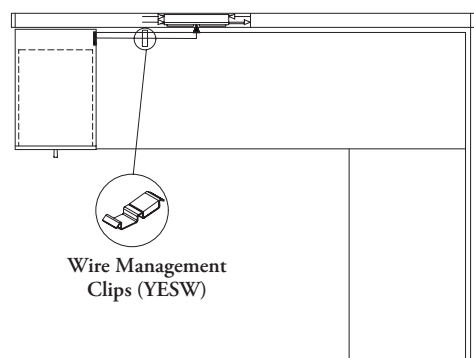

side filers with height-adjustable tables

- When planning parallel with Height-Adjustable Tables and Side Filers, the power cord will run from the bottom of the Side Filer to a District Panel
- Ensure Power Box (UNQP) is accessible on the panel to both the Height-Adjustable table, and the Side Filer

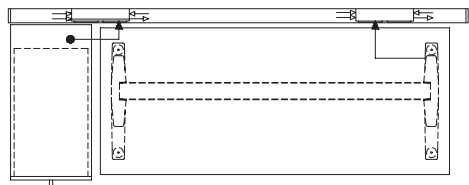

- When planning perpendicular with Height-Adjustable Tables and Side Filers, the power cord will run from the bottom of the Side Filer to a District Panel
- Ensure Power Box (UNQP) is accessible on the panel to both the Height-Adjustable table, and the Side Filer

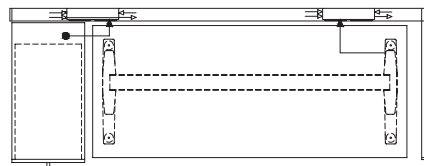

planning with side filer, mini side filer & USB power (continued)

mini side filers with fixed worksurfaces

- When planning parallel with Mini Side Filers, the power cord will run from the side of the Filer (left shown) to Power Rod, Under-Worksurface Mount with Cable Tray (YEPD6)
- It is recommended Wire Management Clips (YESW) are specified. It is available from Complements: *Electrics Program*

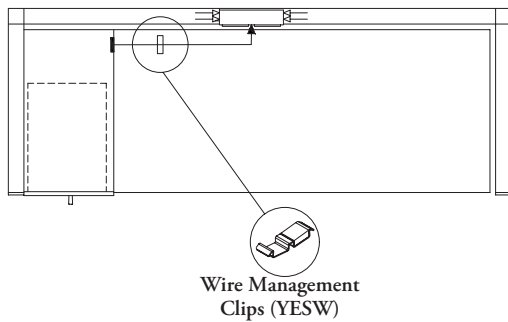

- When planning perpendicular with Fixed Worksurfaces and Mini Side Filers, the power cord will run from the side of the Filer (left shown) to Power Rod, Under-Worksurface Mount with Cable Tray (YEPD6)
- Power Rod (YEPD) cord will run and plug into a powered District Panel. It is recommended Wire Management Clips (YESW) are specified

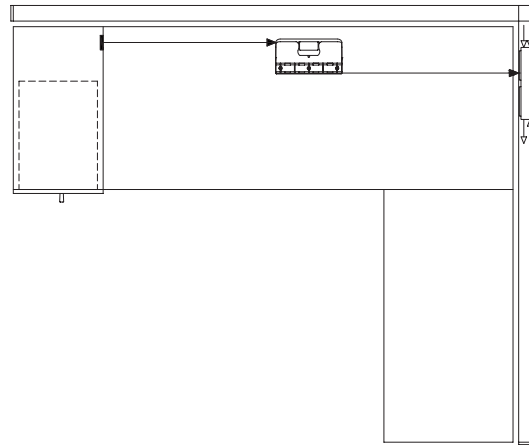

accessory bundle basics

District Side Filers and Mini Side Filers are available with or without Accessory Bundles. Accessory Bundles provide organization within the unit and are available in two groupings, Default and Accessorized.

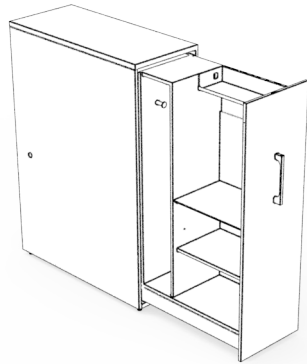

Default (no accessory bundle)

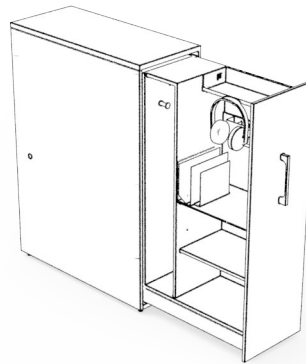

Accessorized (with accessory bundle)



Hanging Pen Pocket

- Finishes:
 - Foundation
 - Mica
 - Accent
- Provides storage for pens, pencils, markers and scissors
- Attaches to the accessory rail

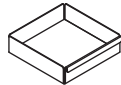

Hanging Tray

- Finishes:
 - Foundation
 - Mica
 - Accent
- Provides storage for small office accessories
- Attaches to the accessory rail



Headphone Hook

- Finishes:
 - Foundation
 - Mica
 - Accent
- Provides storage for standard headphones
- Attaches to the top shelf or accessory rail

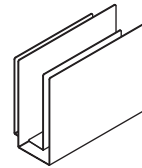

Paper Filer

- Finishes:
 - Foundation
 - Mica
 - Accent
- Accommodates file folders, books and papers

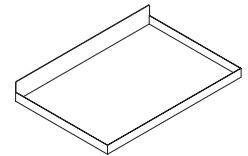

Boot Tray (UNBW)

- Finishes:
 - Foundation
 - Mica
 - Accent
- Provides storage for shoes and boots
- Designed to sit on bottom shelf
- Ordered separately

accessory bundles

Accessory Bundles (UNAB) are available in the following:

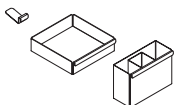

Bundle A includes:

- Hanging Pen Pocket
- Hanging Tray
- Headphone Hook

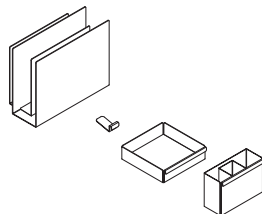

Bundle B includes:

- Hanging Pen Pocket
- Hanging Tray
- Headphone Hook
- Paper Filer

grain direction

Attention to grain/pattern direction is important when planning storage. The following examples demonstrate this. Laminates do not have a one-way grain direction like veneers but rather a bi-directional grow pattern.

Rolling Pedestal (UPR)

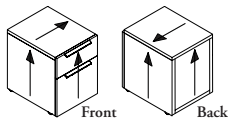

Laminate and Veneer

Rolling Pedestal with Box Drawer & Hinged Door (UPRB)

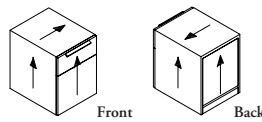

Laminate and Veneer

Rolling Pedestal with Hinged Door (UPRH)

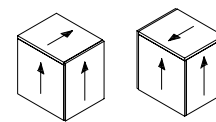

Laminate and Veneer

Pedestal with Solid Back (UPFD)

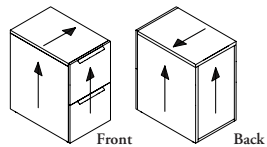

Laminate and Veneer

Stretch Pedestal – Elevated (UPS)

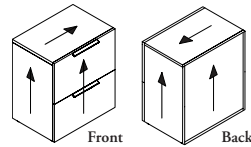

Laminate and Veneer

Lateral File (UFL)

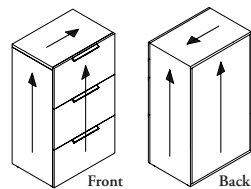

Laminate and Veneer

Grain Matching Fronts



Laminate and Veneer grains DO match across fronts on:

Pedestals, Stretch Pedestals and Lateral File Cabinets

Bookcase (UBK)

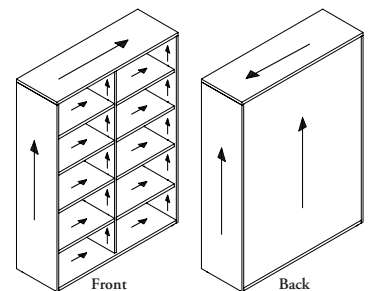

Laminate and Veneer

Low Full Drawer Credenzas (ULD) and High Full Drawer Credenzas (UHD)

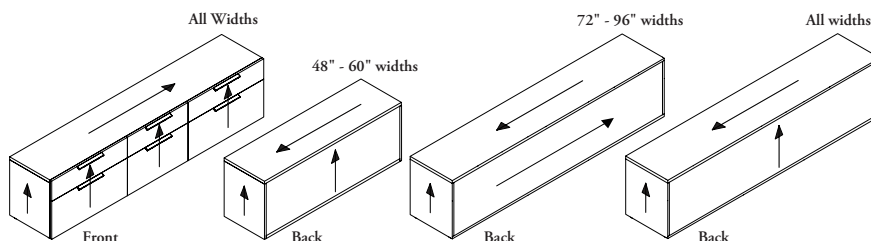

Laminate and Veneer

Laminate

Laminate

Veneer

Grain Matching Fronts

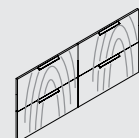

Laminate and Veneer grains DO match Vertically NOT Horizontally across fronts on:

Full Drawer Credenzas



grain direction (continued)

Low Open Credenzas (ULO) and High Open Credenzas (UHO)

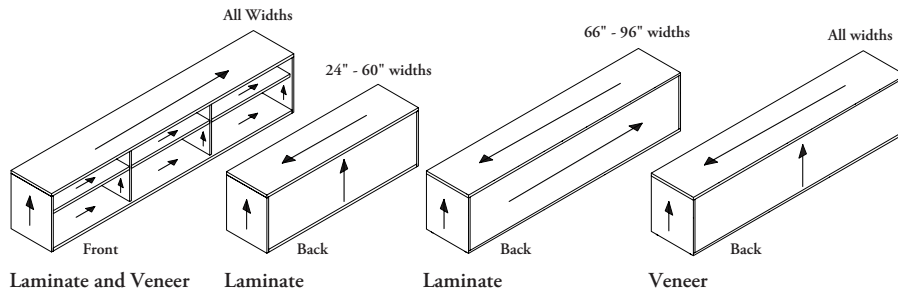

Low Open with Drawer Credenzas (ULH) and High Open with Drawer Credenzas (UHH)

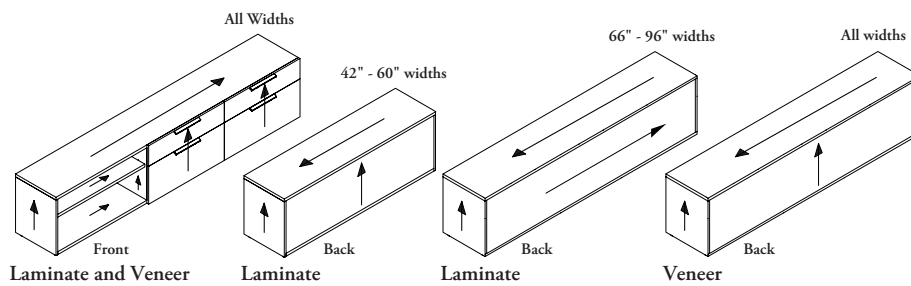

Grain Matching Fronts

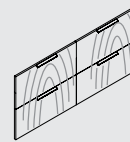

Laminate and Veneer grains
DO match Vertically
NOT Horizontally
across fronts on:

Open with Drawer Credenzas and
Dual Cubby Credenzas

Low Double Sliding Door Credenzas (ULS) and High Double Sliding Door Credenzas (UHS)

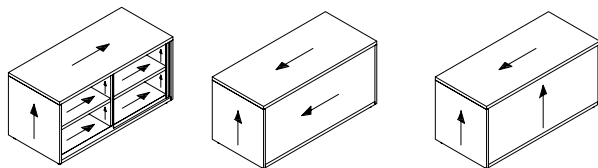

Open Stackers (UCO)

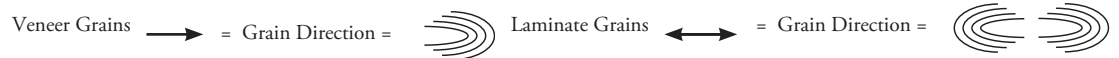
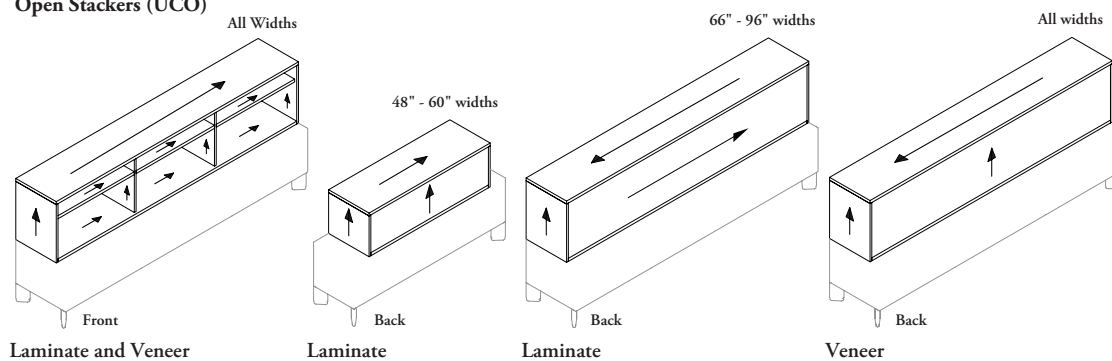

grain direction (continued)

Double-Sided Stackers

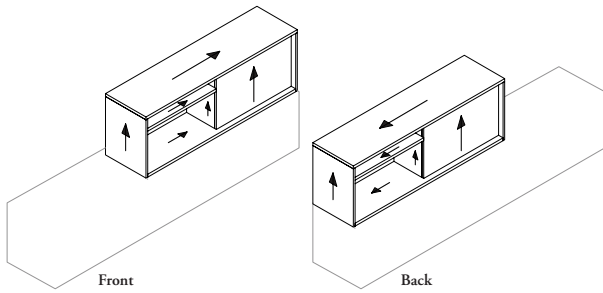

Laminate and Veneer

Closed Stacker (UCC)

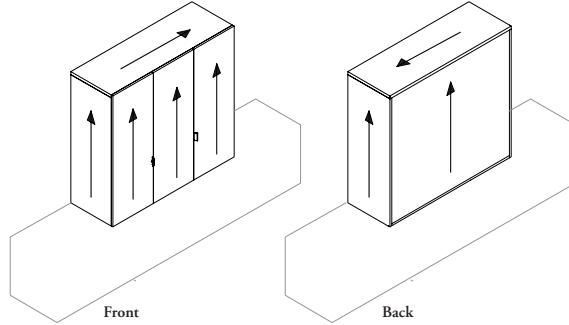

Laminate and Veneer

Closed Stacker with Cubbies (UCB)

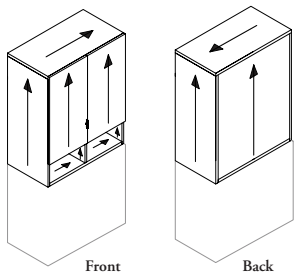

Laminate and Veneer

Grain Matching Fronts

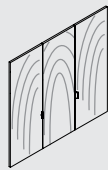

Laminate and Veneer grains
DO NOT
match across fronts on:

Stackers with Doors

Single Locker with Solid Back (UKSD)

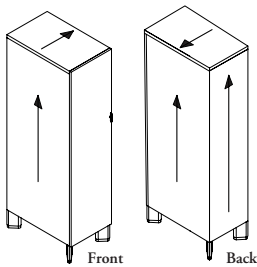

Laminate and Veneer

Single Locker with Side Closet (UKC)

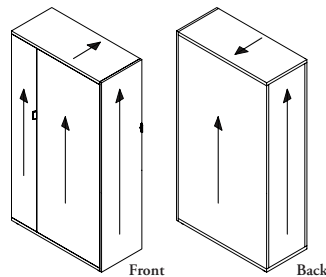

Laminate and Veneer

Grain Matching Fronts



Laminate and Veneer grains
DO
match across fronts on:

Split Door Single Lockers

Cubby Locker (UKN)

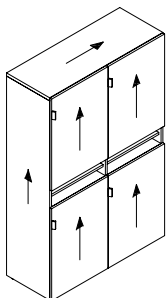

Dual Locker (UKD)

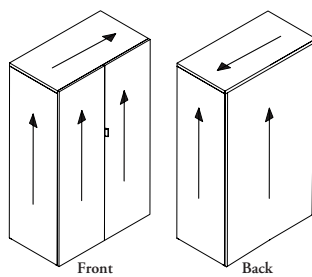

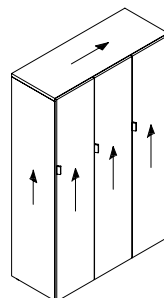

Laminate and Veneer

Triple Locker (UKT)

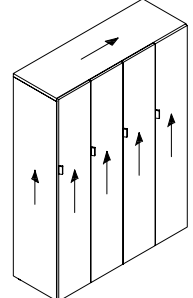

Quad Locker (UKQ)

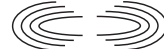

Veneer Grains \rightarrow = Grain Direction =  Laminate Grains \leftrightarrow = Grain Direction = 

grain direction (continued)

Lateral Tower (UTL)

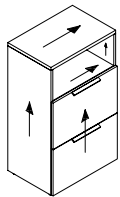

Combo Tower (UTC)

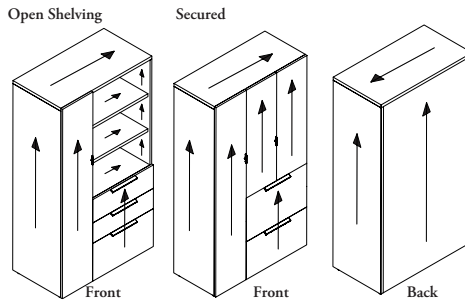

Laminate and Veneer

Pedestal Tower with Cubby Back (UTDC)

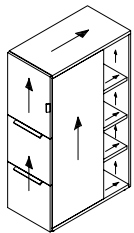

Pedestal Tower with Solid Back (UTDD)

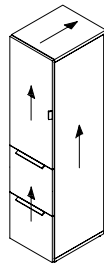

Pedestal Tower with Side Closet (UTDK)

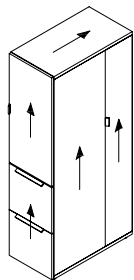

Side Open Tower (UTW) and Wide Side Open Tower (UTWW)

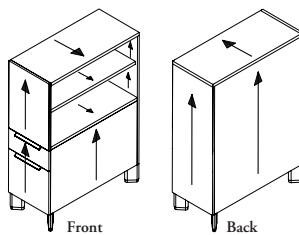

Sliding Door Overhead (UOH)

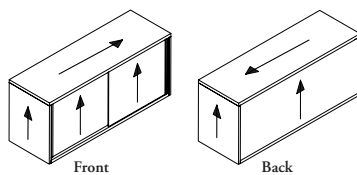

Grain Matching Fronts

Laminate grains
DO NOT
match across door fronts but do
match across drawer fronts on:
Lockers and Towers

Veneer grains
DO NOT
match horizontally
across fronts on:

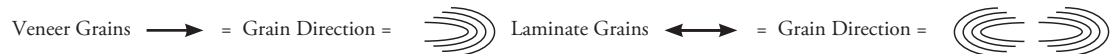

grain direction (continued)

Sliding Door Centermount Overhead (UOHC)

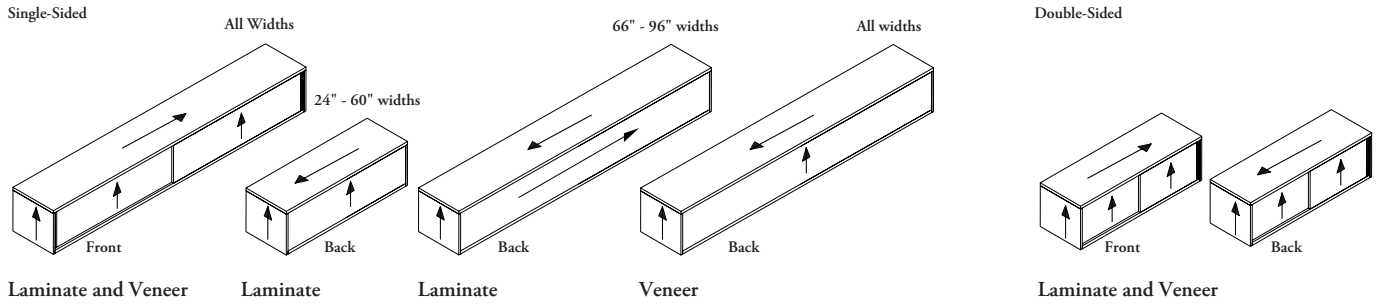

Open Overhead (UOO)

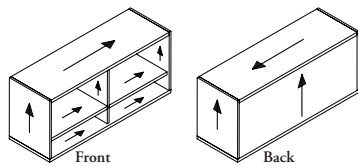

Open Centermount Overhead (UOOC)

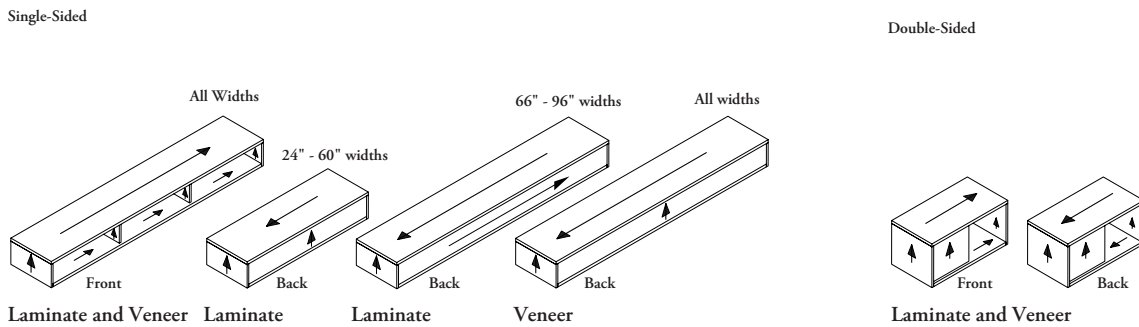

Side Filer (UTS) and Mini Side Filer (UTM)

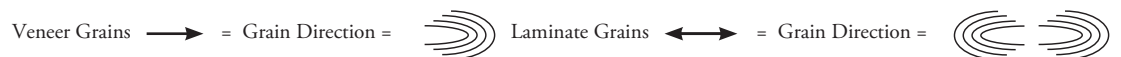
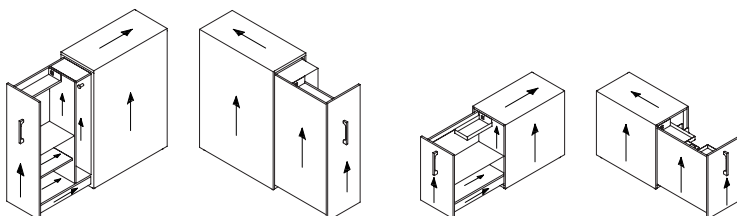

lock chart

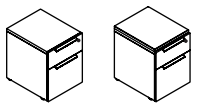
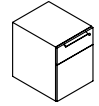
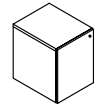
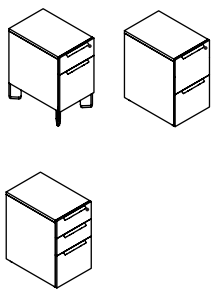
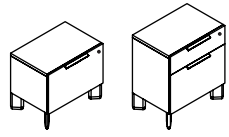
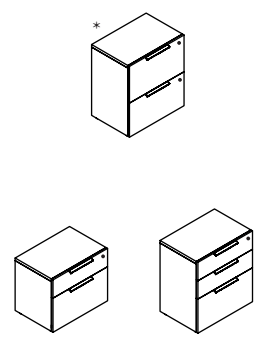
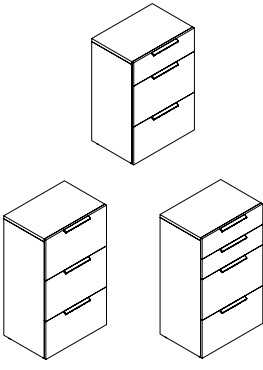
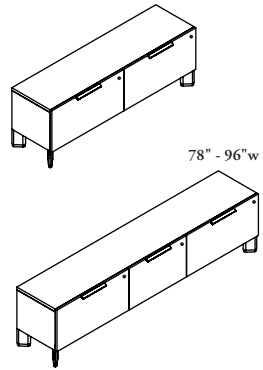
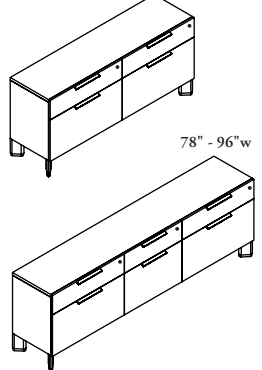
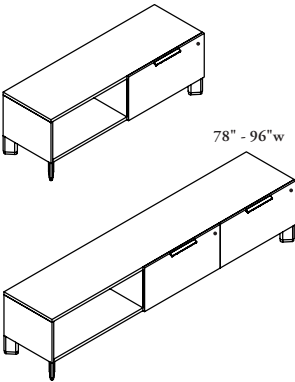
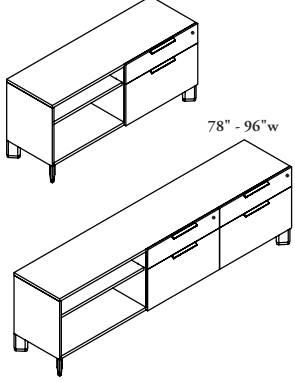
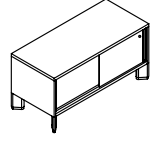
	number of locks		number of locks		number of locks
 <p>UPR</p>	1 x	 <p>UPRB</p>	2 x	 <p>UPRH</p>	1 x
 <p>UPFD</p>	1 x	 <p>UPSE</p>	1 x	 <p>UPSS</p>	<p>2 x on File/File (If specified)</p> <p>1 x</p>
 <p>UFLS</p>	1 x	<p>48" - 72"w</p>  <p>ULDE (shown) / ULDS</p>	<p>2 x</p> <p>3 x</p>	<p>48" - 72"w</p>  <p>UHDE (shown) / UHDS</p>	<p>2 x</p> <p>3 x</p>
<p>48" - 72"w</p>  <p>ULHE (shown) / ULHS</p>	<p>1 x</p> <p>2 x</p>	<p>48" - 72"w</p>  <p>UHHE (shown) / UHHS</p>	<p>1 x</p> <p>2 x</p>	 <p>ULSE (shown) / ULSS</p>	1 x

* Can have two locks if Individual Lock is specified

lock chart (continued)

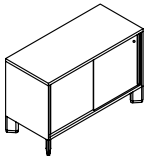
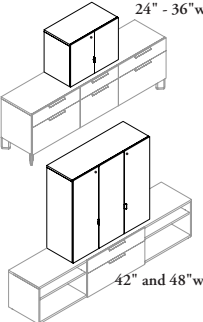
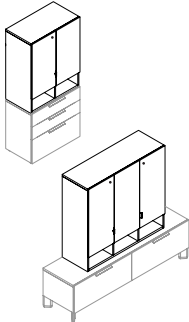
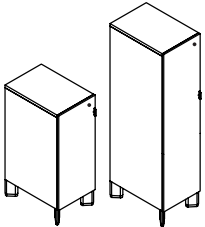
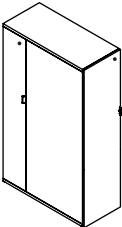
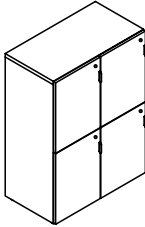
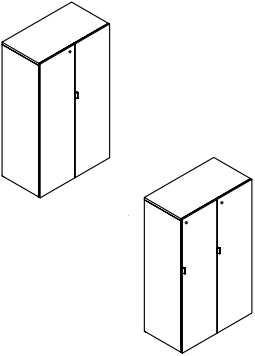
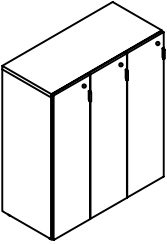
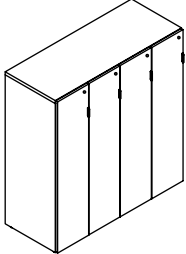
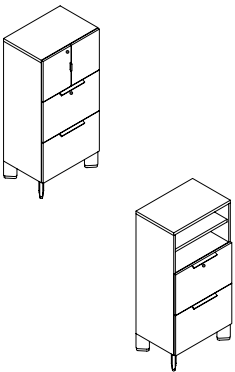
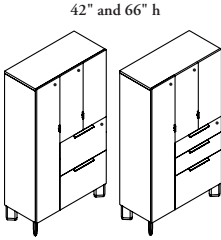
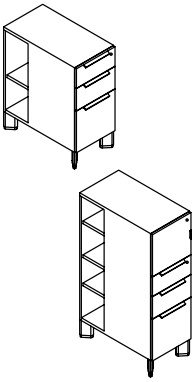
	number of locks		number of locks		number of locks
 UHSE (shown) / UHSS	1 x	 UCC	1 x	 UCB	1 x
			2 x		2 x
 UKSD	1 x	 UKC	2 x	 UKN	4 x
 UKD	1 x	 UKT	3 x	 UKQ	4 x
	2 x				
 UTLE (shown) / UTLS	2 x	 UTCE (shown) / UTCS	2 x	 UTDC	1 x
	1 x				

lock chart (continued)

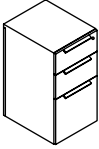
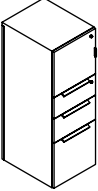
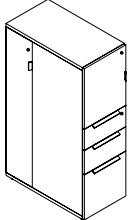
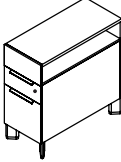
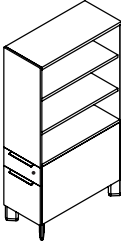
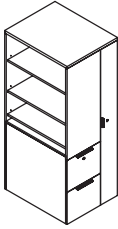
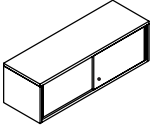
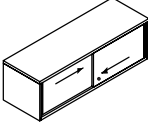
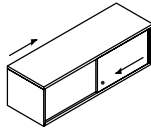
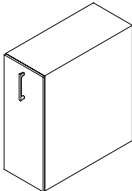
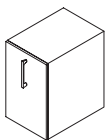
	number of locks		number of locks		number of locks
  UTDD	1 x 2 x	 UTDK	3 x	  UTW	1 x
 UTWW	2 x	 UOH	1 x	 Single-Sided  Double-Sided UOHC	1 x 2 x
  UTS / UTM	1 x				

* Can have two locks if Individual Lock is specified

supports

supports

UNDERSTANDING DISTRICT SUPPORT	296
WORKSURFACE SUPPORT BASICS – HORIZONTAL	297
PLANNING WITH WORKSURFACE SUPPORTS – HORIZONTAL . . .	298
WORKSURFACE SUPPORT BASICS – VERTICAL	302
PLANNING WITH PANEL-MOUNTED CANTILEVERED SUPPORTS . . .	303
WORKSURFACE SUPPORT, FREESTANDING BASICS	304
PLANNING WITH WORKSURFACE SUPPORTS, FREESTANDING	305
PLANNING WITH SEMI-SUSPENDED SUPPORTS	306
WORKSURFACE-TO-STORAGE SUPPORT BASICS	307
PLANNING WITH WORKSURFACE TO STORAGE SUPPORTS . . .	308
STORAGE-TO-PANEL SUPPORT BASICS	310
SELECTING THE CORRECT STORAGE-TO-PANEL BRACKET . . .	311
PLANNING WITH KEYBOARD TRAYS	313

understanding district support

The following outlines the guidelines for supporting panels and worksurfaces in panel-mounted applications.

- When planning with District panels, the end of run conditions must be supported at 6" and 29" high and at the front of a work-surface or storage. There are different ways of providing support, depending on whether storage or end gables are used
- When properly supported, the method of support forms a triangle

end of run with no storage

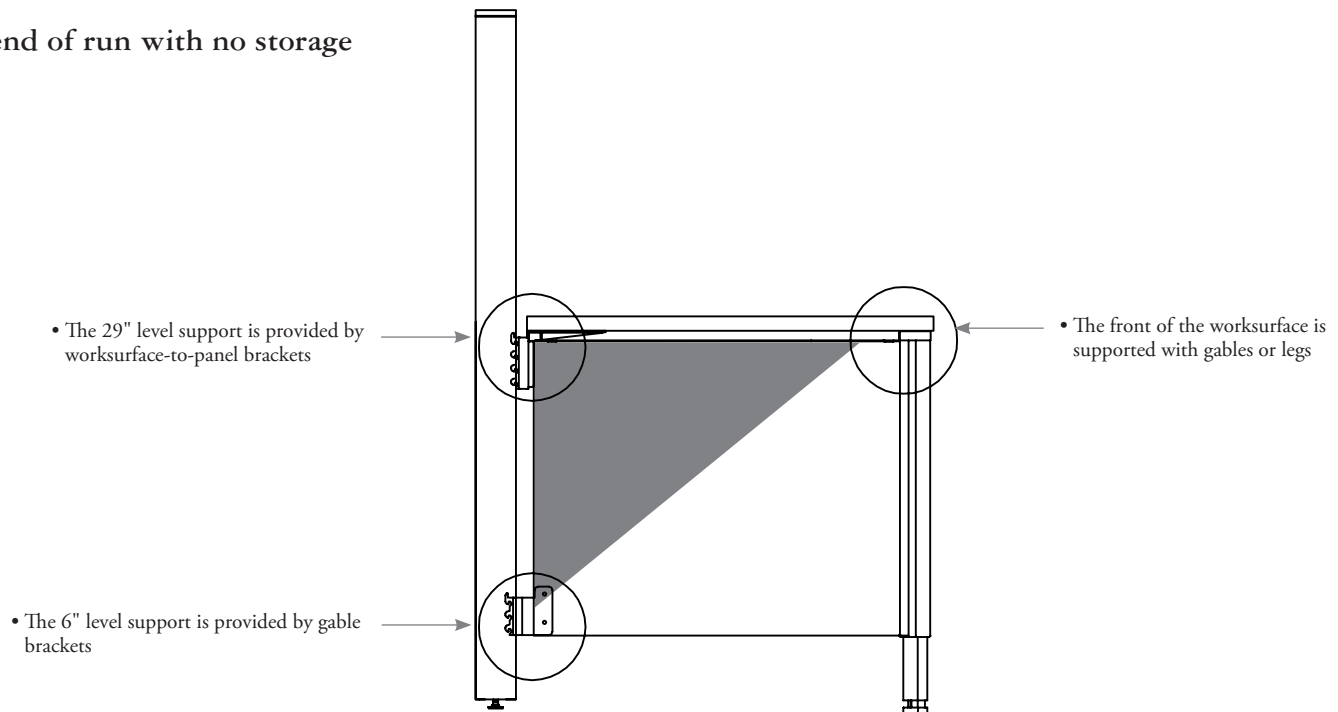

end of run with low storage

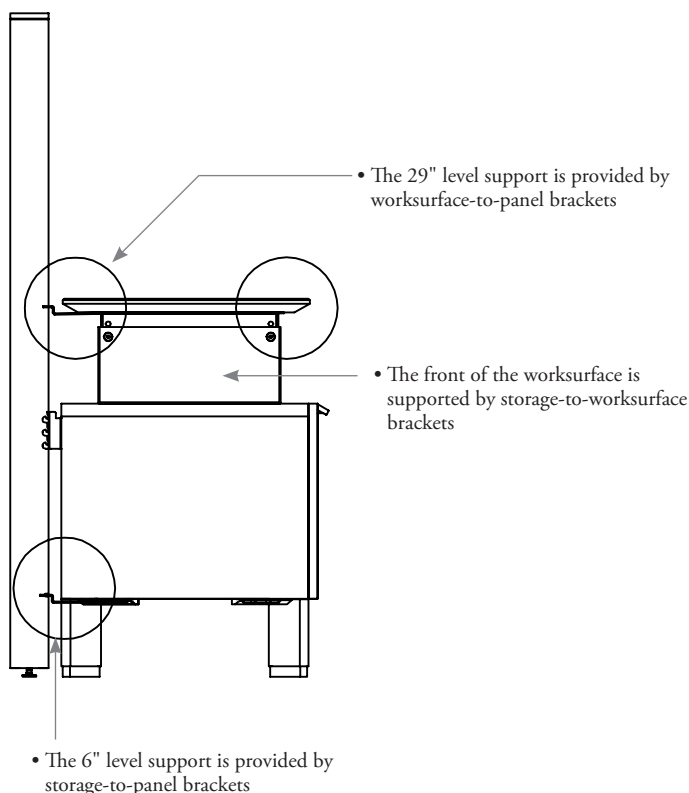

end of run with high storage

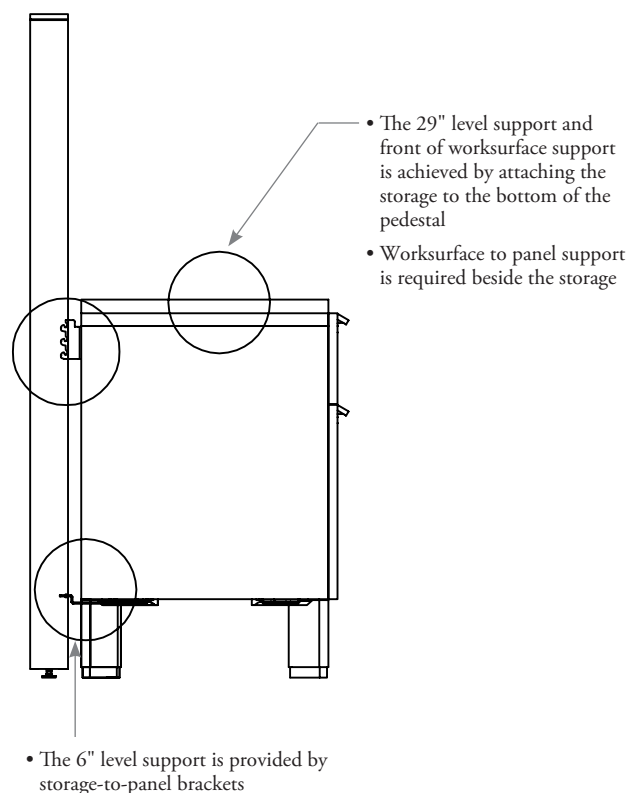

worksurface support basics – horizontal

The following outlines the features of supports that connect horizontally, either below worksurfaces, or for connecting worksurface to panel walls.

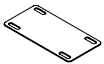
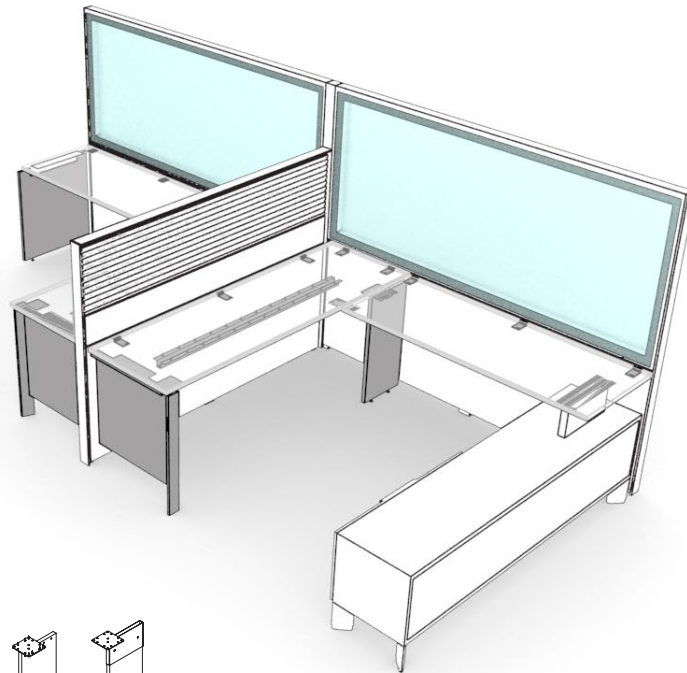

Flush Plate (UNRF)

- Used in conjunction with other supports to maintain alignment of worksurfaces
- **Cannot** be used in freestanding applications, is used in panel wall application only
- **Not** required when cantilevers are used

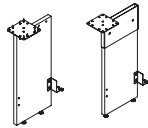

Mid Gable (UNGMF) and Mid Gable – Height-Adjustable (UNGMFA)

- Used on worksurface spans larger than 72" to provide additional floor support or to join two worksurfaces, also includes a bracket at the 6" high level to provide support to the panel wall if required
- (UNGMFA) offers a height-adjustable leveling option with a range of 3" (2" above and 1" below worksurface)

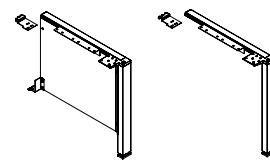
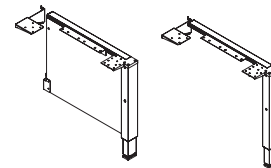

End Gable (UNGEN) and End Gable – Height-Adjustable (UNGEAN)

- Consists of a single leg and a support to allow it to be attached to the underside of a worksurface and to the panel to provide floor support to a panel wall at the end of a worksurface run available in depths to match 17", 20", 24", 30", 36" deep worksurfaces
- Available in depths to match 17", 20" 24" 30" and 36" deep worksurfaces
- Available open or with an infill panel
- The infill has a bracket at the 6" high level and is used when panel support is required at the 6" level - the no infill option **cannot** be used for supporting panels as it does **not** include the bracket
- (UNGEAN) offers a height-adjustable leveling option with a range of 6" (3" above and 3" below worksurface) and is available with or without an infill
- **Cannot** be used on Elevated or Convertible Panel Walls with Inset Glass (UYPER, UYPCR)

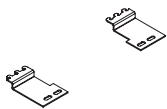

Worksurface Panel Wall Brackets (UNBP)

- Off-module connectors that attach the worksurface to a Panel Wall
- Are mounted in the 29" high horizontal rail and can be connected at any point along the width of the worksurface and Panel Wall but must be spaced minimally every 48"
- Are **not** height-adjustable
- **Cannot** be used on Elevated or Convertible Panel Walls with Inset Glass (UYPER, UYPCR)

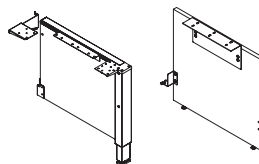

Flush End Gable (UNGEF) and Flush End Gable – Height-Adjustable (UNGEFA)

- Consists of a solid gable and a support to allow to be attached to the underside of a worksurface and to a panel available in depths to match 17", 20", 24", 30", 36" deep worksurfaces
- Available in depths to match 17", 20" 24" 30" and 36" deep worksurfaces
- (UNGEFA) offers a height-adjustable leveling option with a range of 3" (2" above and 1" below worksurface)
- Provides floor support to a panel wall at the end of worksurface run and also has a bracket at the 6" high level to provide panel support

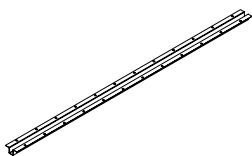

Worksurface Reinforcement Channel (UNRC)

- Adds rigidity to worksurface to reduce deflection in the worksurface
- Required for all worksurfaces with an unsupported span over 48"

planning with worksurface supports – horizontal

The following should be considered when planning with worksurface horizontal supports.

Worksurface Panel Wall Brackets

- Panel wall brackets mount into the 29" high horizontal rail of the panel wall, to support worksurface on- or off-module

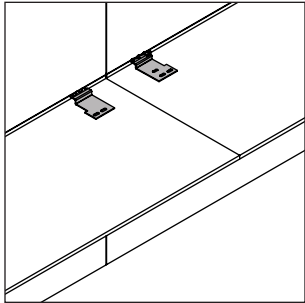

On-Module worksurface shown

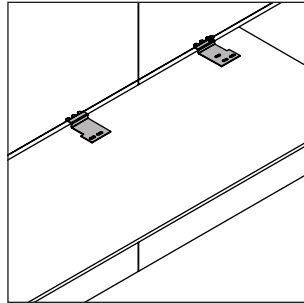

Off-Module worksurface shown

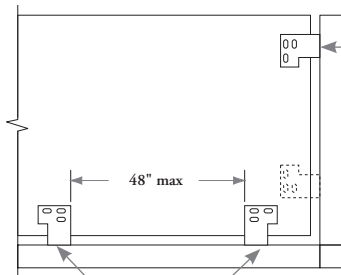

- A corner bracket located at the side edge can support worksurface end when it **cannot** be located along the back edge
- Typically worksurface ends only require one bracket towards the user edge for support

- Brackets are required at every 48" along a worksurface
- At least one left and one right bracket should be used for anti-dislodgement – brackets are packaged in pairs, one right and one left

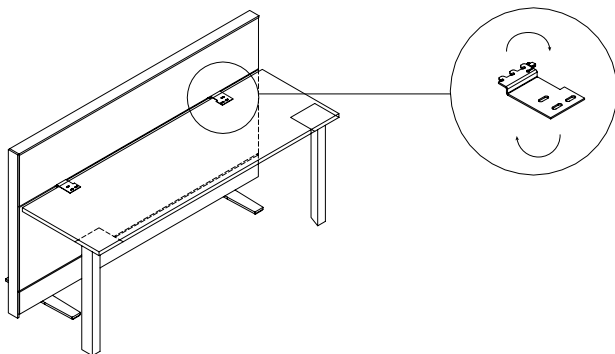

When mounting a worksurface to a freestanding panel, the Worksurface Panel Wall Bracket (UNBP) must be rotated 180° to have the worksurface reach a 28" datum.

planning with worksurface supports – horizontal (continued)

Mid Gable and Mid Gable – Height-Adjustable

- The 12" deep mid gable is used for 20" and 24" deep worksurfaces and the 18" deep half gable is used for 30" and 36" deep worksurfaces

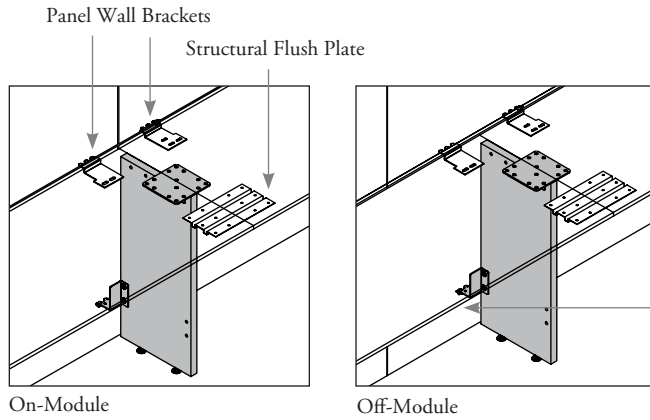

- The mid gable provides support to the panel by mounting to the 6" rail
- A 22" high and 6" high fascia must be specified for use with the gable (See Fascias section for details)

- Worksurface panel wall brackets are required on either side of the mid gable when connecting two worksurfaces
- A Structural Flush Plate is required at the front of the surfaces to maintain alignment

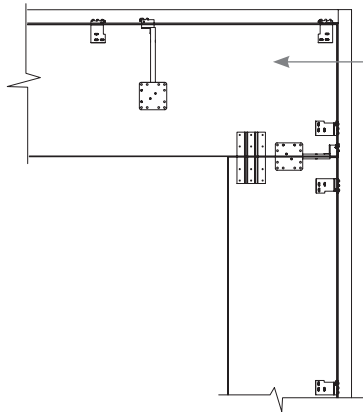

- Worksurfaces on- or off-module in straight runs or in L-shaped configurations are used to connect or support

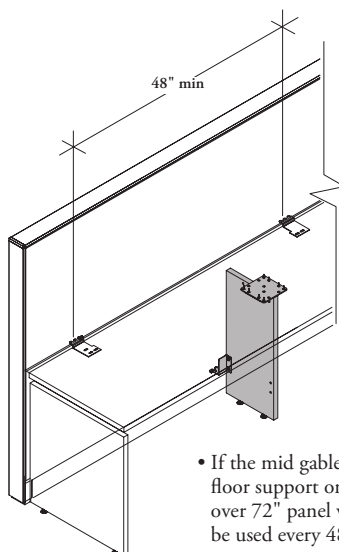

- If the mid gable is used for additional floor support on worksurface runs over 72" panel wall brackets must still be used every 48"

planning with worksurface supports – horizontal (continued)

End Gable and End Gable – Height-Adjustable

- End gables mount into the 6" and 29" high levels to provide support to the end of a panel run

- A Panel Wall Bracket is included to provide the support at 29" high

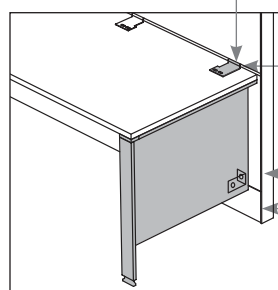

- Mounts flush with the outside edge of the worksurface regardless of the worksurface profile
- A 22" and 6" high fascia must be specified with the end gable with infill

- The infill panel option includes a mounting bracket at the 6" high level so must be used when support is required at the 6" horizontal level
- The bottom edge of the infill panel aligns with the 6" high horizontal rail
- On the height-adjustable option, it has a different bracket which attaches to the vertical channel of the frame and travels up and down with the infill

Flush End Gable and Flush End Gable – Height-Adjustable

- Provides the same support as an end gable, but is solid to provide an alternative aesthetic

- A Panel Wall Bracket is included to provide the support at 29" high

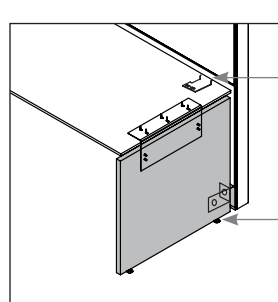

- Provides support at the 6" high horizontal rail of the panel wall

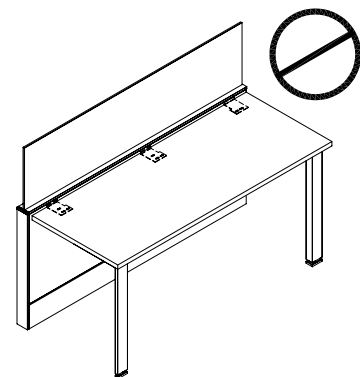

Worksurfaces **cannot** be mounted to 29" high Panel Walls with Inset Glass using Worksurface Panel Wall Bracket (UNBP) due to restricted access to the top horizontal rails.

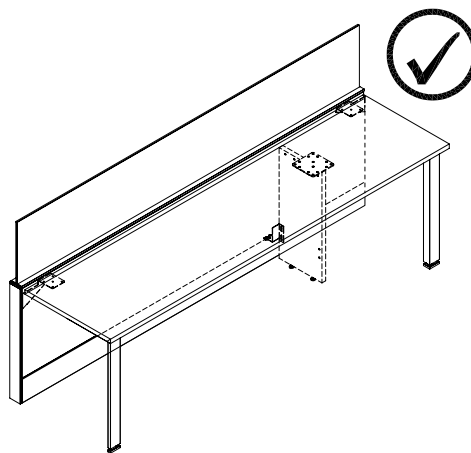

To accommodate 29" high Panels with Inset Glass with a worksurface mounted you must specify a Worksurface Panel Wall Bracket – Height Adjustable (UNBPA) on either end of the worksurface. If the Panel width is greater than 72" a Mid Gable (UNGMF) must also be specified every 72".

planning with worksurface supports – horizontal (continued)

reinforcement channel requirements

- When a worksurface has an unsupported span of a 48" or more reinforcement channels are required
- The unsupported span is the distance between two supports or storage units

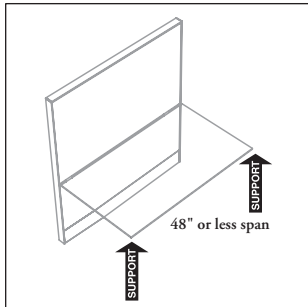

For unsupported spans 48" or less, no reinforcement channels are required for all depths of worksurfaces.

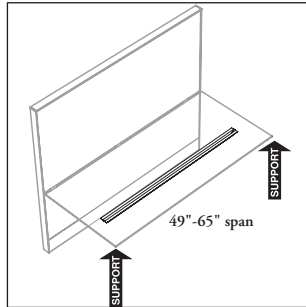

For unsupported spans from 49" to 65", one reinforcement channel only is required for all depths of worksurfaces.

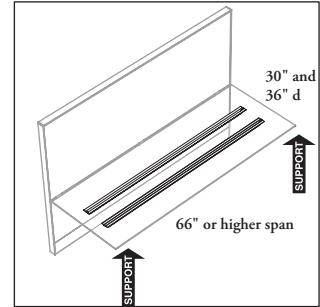

- Worksurfaces 30" or 36" deep two reinforcement channels are required
- One reinforcement channel is required on worksurfaces 24" deep



- A deduction allowance can be given for the mounting plates on supports
- Allow 6" for all supports except: for the low credenza worksurface support 10"
- The reconfigurable low credenza worksurface bracket which is either 16" or 19"

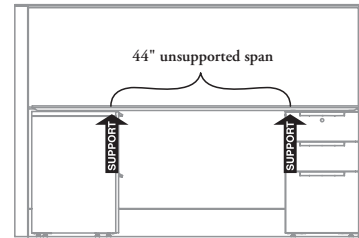

- Example: a 78" wide worksurface supported by a pedestal and a 19" deep credenza has an unsupported span of 44"
- No reinforcement channel is required because the unsupported span is less than 48"

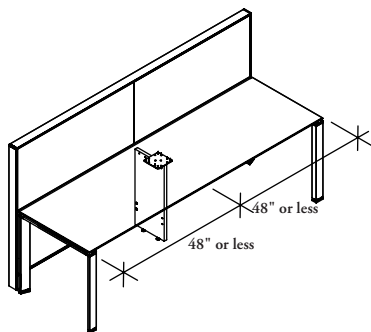

- When planning with surfaces wider than 72" that will require secondary floor support, consider placing the support where it will shorten the unsupported distance on each side to 48" or less
- No reinforcement channel will be required, this is important to consider when planning with keyboard trays

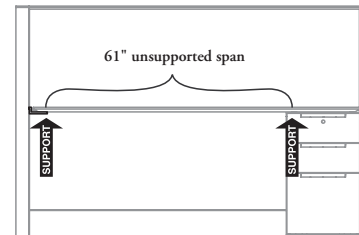

- Example: a 78" wide worksurface supported by a pedestal and panel brackets has an unsupported span of 61"
- One reinforcement channel is required

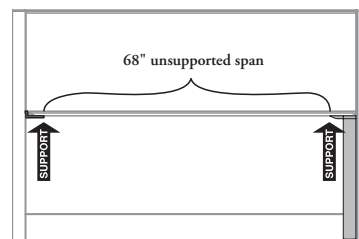

- Example: a 78" wide worksurface supported by a gable and panel brackets has an unsupported span at 66"
- 2 reinforcement channels are required if the surface is 30" or 36" deep

worksurface support basics – vertical

The following outlines the features of vertical supports that allow for height-adjustable worksurface mounting.

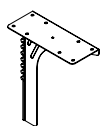
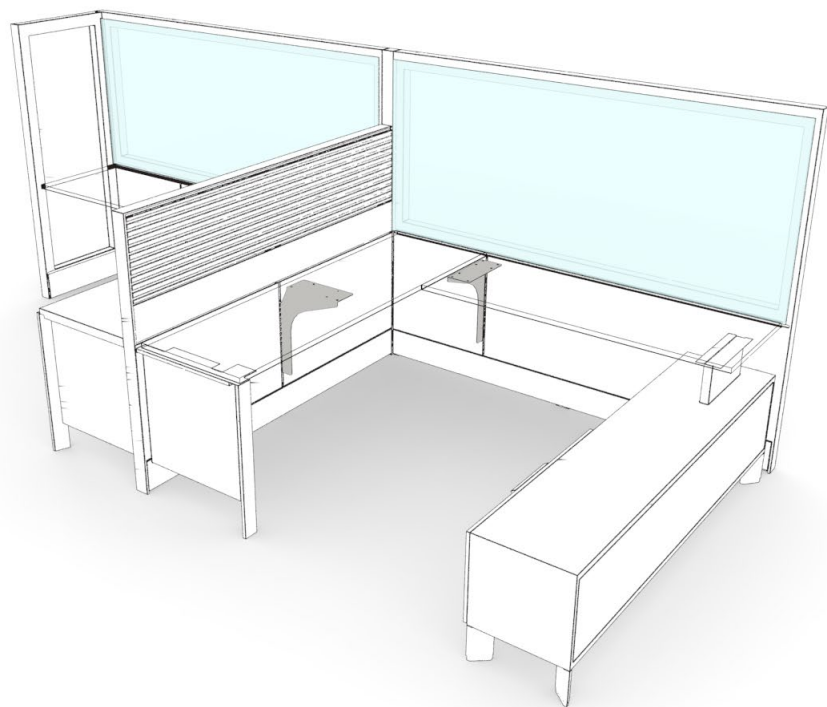

Cantilever (UNLVR)

- Mounts into the center vertical channel of a panel wall over 60" wide to provide on module height-adjustable worksurface support at 1" increments available in depths of 11" and 14"
- Available in depths to match 11" and 14"

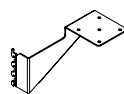

Worksurface Panel Wall Bracket – Height-Adjustable (UNBPA)

- Mounts into the vertical channel at the end of a Panel Wall to provide on-module height-adjustable support for worksurfaces
- Used with Flush Full-Height Windows – Single and Double Glazed (UNPFWS, UNPFWD) to support worksurfaces as no horizontal channel is available at 29" high

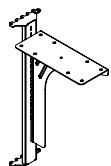

Off-Module Cantilever (UNLVFN)

- Mounts in the 6" and 29" horizontal channels of the Panel Wall to allow for height-adjustable off-module applications
- Can be used in place of the Mid Gable (UNGMF) and Height-Adjustable Mid Gable (UNGMFA), height-adjustable on an elevated panel as it does **not** extend below the 6" horizontal rail available in depths of 11" and 14"
- Available in depths to match 11" and 14"
- **Cannot** be used on Elevated or Convertible Panel Walls with Inset Glass (UYPER, UYPCR)

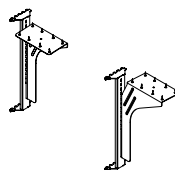

Off-Module Cantilever for Panels with Accessory Beam (UALVFN)

- Available in depths to match 11" and 14"
- Left or Right handed available
- Mounts to the horizontal channel of the panel to provide on-module height-adjustable worksurface support at 1" increments
- Used only when using a panel frame with accessory rail in order to accommodate the gap from the beam

planning with panel-mounted cantilevered supports

The following should be considered when planning with cantilevered height-adjustable supports.

- On worksurfaces attached to panel walls, support is required every four feet and secondary floor support every six feet
- Cantilevers are **not** considered floor support

Cantilever (UNLVR)

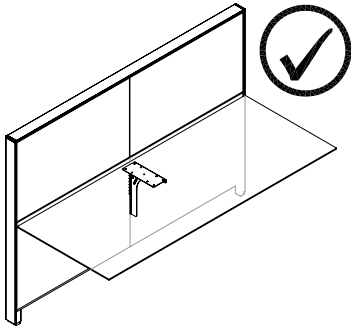

- Cantilevers mount vertically so are used only in the middle of a panel run where there is a vertical break in the panel (including one panel wider than 66" with split fascias)

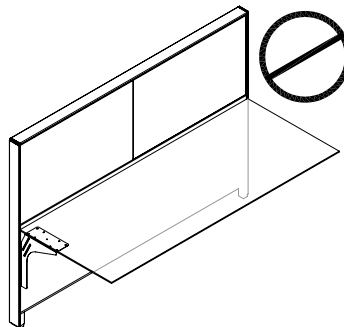

- **Cannot** be used as an end-of-run support

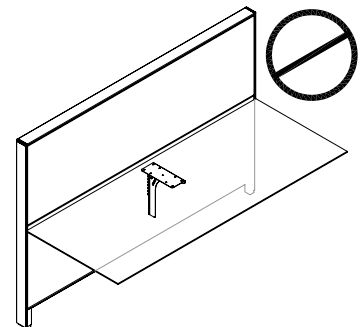

- **Cannot** be used on panels less than 60" wide because there is no center vertical frame to attach to

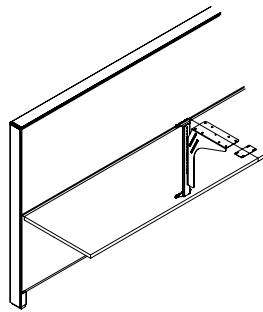
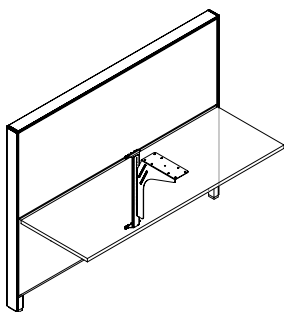

Off-Module Cantilever (UNLVF)

- Placed directly below a work surface or the connection of two work surfaces and can be mounted anywhere along the length of a panel
- Is mounted into the horizontal rails of the panel (6" and 29")
- The flange is wide enough to span the connection (with or without knife-edge work surfaces)
- A Flush Plate should be used for added alignment if used at the intersection of two surfaces
- A 22" and 6" lower fascia are required for use with this cantilever if a flush panel is used
- Recommended for use with Elevated Panel Walls because the bracket does **not** extend below the 6" horizontal rail

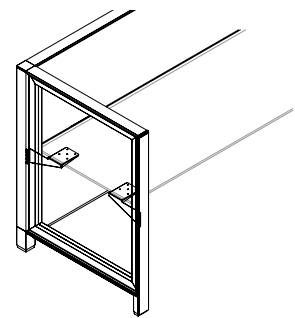
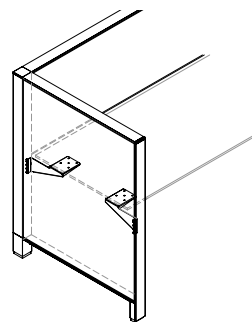

Work surface Panel Wall Bracket – Height-Adjustable (UNBPA)

- Hooks into the vertical channel at the end of a panel wall only to provide height-adjustable support
- Is an on-module bracket only
- Can be used for non height-adjustable mounting with Flush Full-Height Windows – Single and Double Glass (UNPEWSR, UNPFWDR) where no horizontal channel is available at 29" high

worksurface support, freestanding basics

The following outlines the features of supports that are typically used in freestanding or semi-supported environments.

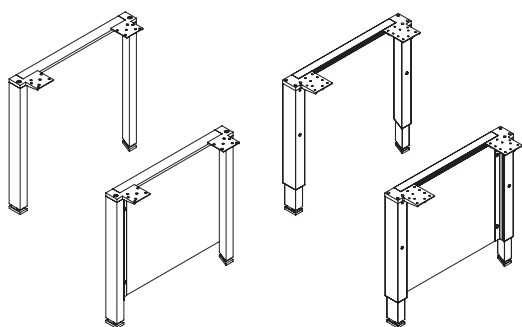
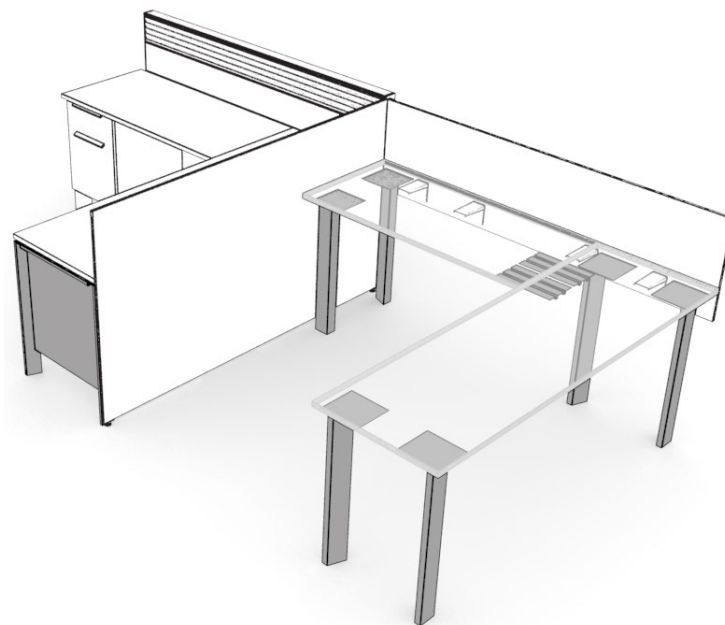

Semi-Suspended Gable (UNGSN) and Semi-Suspended Gable – Height-Adjustable (UNGSAN)

- Consists of two legs and a support, and is used at the open end of a panel wall mounted semi-suspended worksurface
- Available with or without an infill, standard or height-adjustable
- Have a height-adjustable range of 6" (3" above and 3" below)

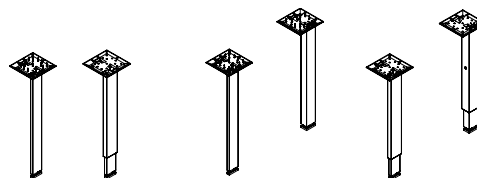

Leg – Single (UNLGN), Leg – Height- Adjustable Single (UNLGA), Leg – Pair (UNLGPN) and Leg – Height-Adjustable Pair (UNLGPA)

- Used primarily in freestanding applications to provide worksurface support but can also be used for intermediate support in panel wall applications
- Available in single or pairs, standard or height-adjustable
- Have a height-adjustable range of 6" (3" above and 3" below)

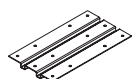

Structural Flush Plate (UNRFS)

- Used to join two worksurfaces in freestanding application
- Two Structural Flush Plates used with a leg provides the required stability to create freestanding desks

planning with worksurface supports, freestanding

The following should be considered when planning with freestanding supports.

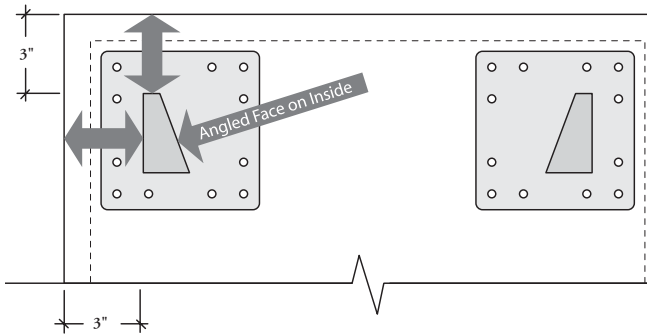

When post legs are used at the end of a worksurface the legs are inset from each end by 3" and the angled face is always on the inside

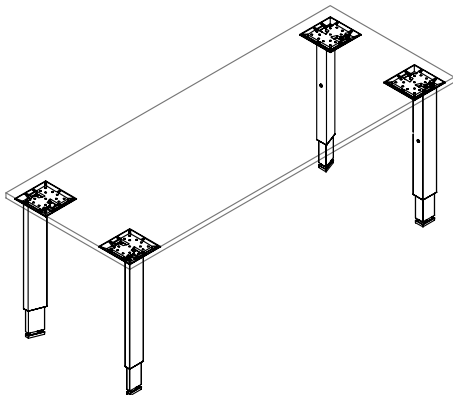

Freestanding desks can be created using a District worksurface and either two pairs or four single legs.

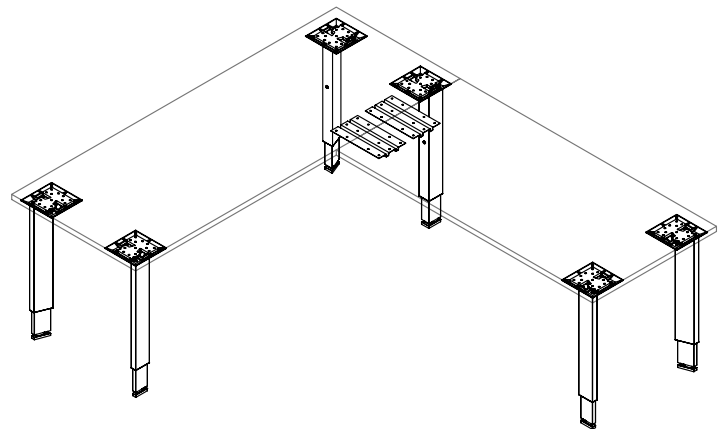

When an "L" shaped freestanding workstation is created the leg between the two worksurfaces is **not** shared, it mounts to one worksurface and two Structural Flush Plates are used to connect the two surfaces.

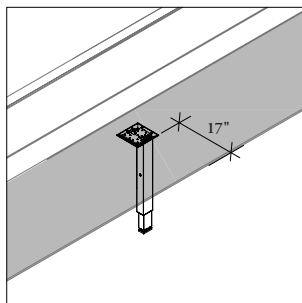

Leg as an Intermediate Support

- A leg can be used as an intermediate support to provide floor support
- The position on the leg is the same regardless of the worksurface profile, and is always 17" from the user edge of the worksurface

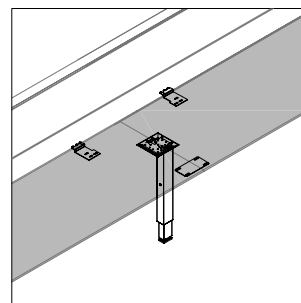

Leg as a Shared Intermediate Support

- When used in a shared position one leg supports both worksurfaces, and the 3" flat worksurface of the Post Leg is oriented toward the user
- A Flush Plate is required to align the two surfaces

planning with semi-suspended supports

The following should be considered when planning with semi-suspended supports.

Semi-Suspended Gable (UNGSN) and Height-Adjustable Semi-Suspended Gable (UNGSAN)

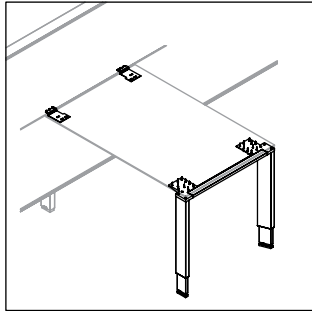

- Has a horizontal bar connecting the two legs for added support in semi panel-mounted applications

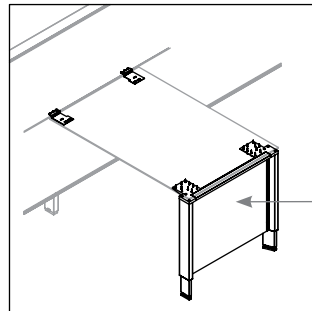

- An infill is **not** necessary for rigidity of a Semi-Suspended Gable. It is an aesthetic option for matching panel-mounted gables with infills

mounting semi-suspended surfaces to panel walls

- Two Worksurface Panel Wall Brackets (UNBP) are required on any panel supported worksurface end

- The size of the semi-supported worksurface can be increased using a half depth gable to reduce the unsupported span

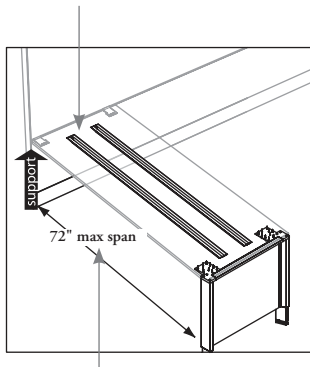

- The maximum width of the worksurface is 72" unless additional floor support is added

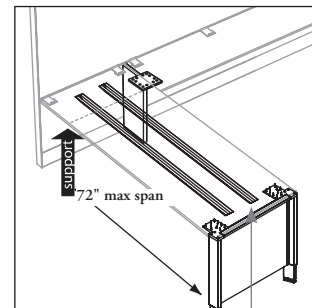
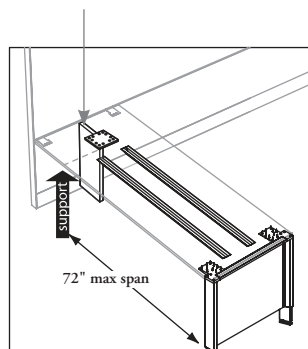

- Mid Gables (UNGMF) or Cantilevers should be used at connections between panel supported and semi-supported worksurfaces

worksurface-to-storage support basics

The following outlines the features of supports that connect storage to panel walls, worksurfaces and walls.

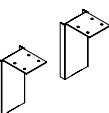
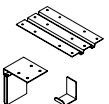
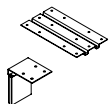
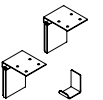
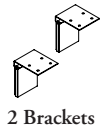
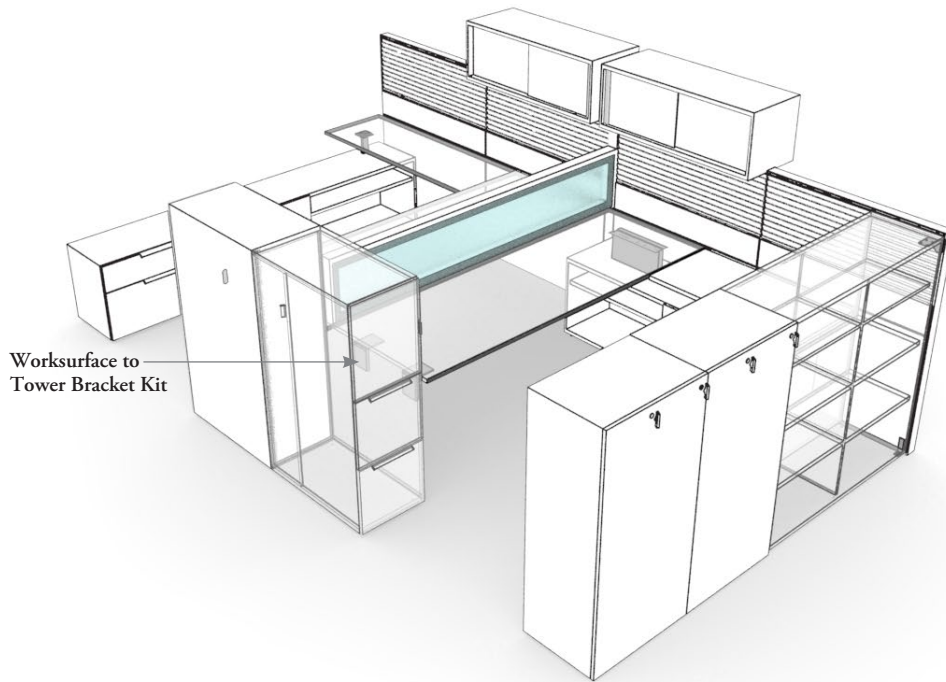

Worksurface-to-Tower Bracket Kit (UWBT)

- Used to attach worksurfaces to storage components
- Available with four options:
 - (BB) two brackets, which are used with storage with no cubbies – the brackets attach to the underside of the worksurface and the side of the storage
 - (HB) two brackets, one hook, which are used with storage with no cubbies – the brackets attach to the underside of the worksurface and the side of the storage, and the hook attaches to the bracket to hang personal items
 - (BF) one bracket, one flush plate, which are used with storage with cubbies – the bracket attaches to the underside of the worksurface and the side of the storage, and the flush plate attaches the worksurfaces and a shelf in the cubby section of the storage
 - (HF) one bracket, one flush plate, one hook, which are used with storage with cubbies – the bracket attaches to the underside of the worksurface and the side of the storage, the flush plate attaches the worksurfaces and a shelf in the cubby section of the storage, and the hook attaches to the bracket to hang personal items

Height-Adjustable Worksurface-to-Tower Bracket Kit (UWBTH)

- **Cannot** be used on a Tower with Cubby Back (UTDC).

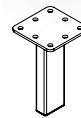

Mini Leg (UNCLN)

- Used in place of the Low Credenza Worksurface Support (UNCPWN) when panel support and height-adjustability is **not** required because it does **not** attach the storage, it simply rests on it
- **Cannot** be used in freestanding desking applications
- Must be used with Worksurface Panel Wall Bracket (UNBP) and Storage-to-Panel Bracket (UWSPB). This combination provides support to panels

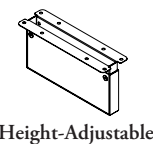
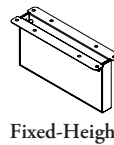

Low Credenza-to-Worksurface Supports (UNCPWN)

- Mount to the underside of a worksurface and to the top of a Low Credenza to provide support to the worksurface
- When used in combination with the Worksurface Panel Wall Bracket (UNBP) and Storage-to-Panel Bracket (UWSPB), support is provided for panels
- Offer a height-adjustable leveling option with a range of 4" (3" above the fixed height of 7" or 1" below the fixed height of 7")

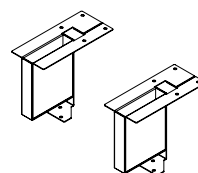

Reconfigurable Low Credenza-to-Worksurface Support (UWCPWN)

- Mounts to the underside of the worksurface, wraps around the top of an open compartment on low storage and attach to the underside of the open section
- Does **not** attach to the top of a storage unit, therefore **not** making it to allow for reconfigurability
- Is **not** height-adjustable

planning with worksurface to storage supports

The following should be considered when planning with worksurface to storage supports.

Low Credenza-to-Worksurface Supports (UNCPWN)

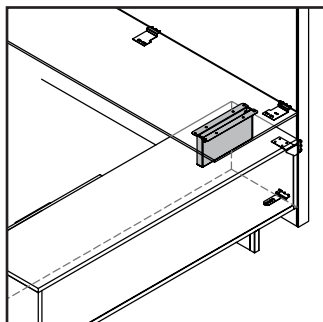

panel-mounted

- Can be used in panel-mounted applications to support the front of the worksurface
- Attaches the bottom of a worksurface to the top of a low credenza
- Does **not** add rigidity to the panel on its own; worksurface and storage supports must be specified at the 6", at 29" to give adequate support

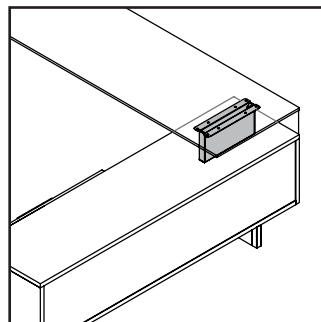

freestanding

- Can be used in freestanding applications to attach the bottom of a worksurface to the top of a low credenza
- Is available in a height-adjustable option

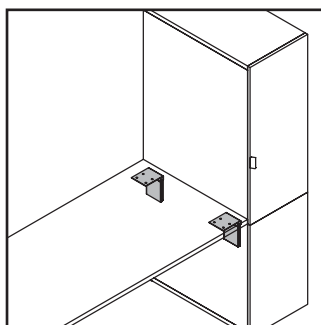
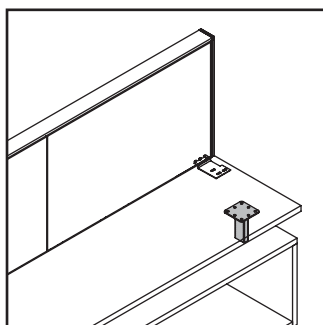

Worksurface-to-Tower Bracket Kit (UWBTBB) – (2 brackets)
Height-Adjustable Worksurface-to-Tower Bracket Kit (UNBTHBB) – (2 brackets)

- When mounting worksurfaces to storage, two brackets are required for support
- **Cannot** be used with storage with cubbies

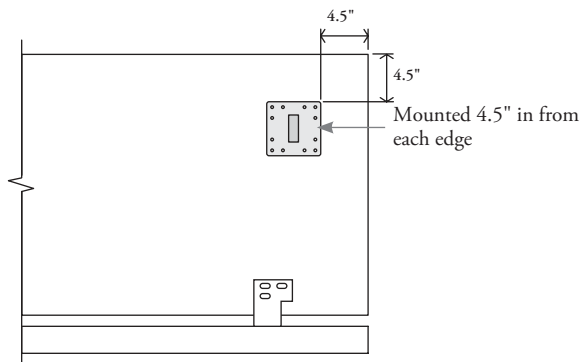

Mini Leg (UNCLN)

- Is an alternative support used to support the front of a worksurface over a low credenza in panel-mounted applications
- **Cannot** be used in freestanding desking applications because the support rests on top of the credenza without being fastened to it
- Is **not** height-adjustable

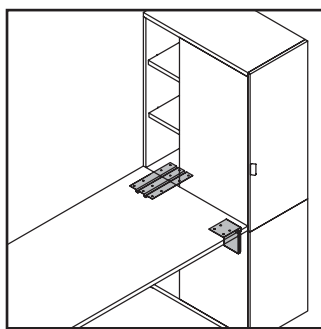

Worksurface-to-Tower Bracket Kit (UWBTBF) – (1 bracket, flush plate)
Height-Adjustable Worksurface-to-Tower Bracket Kit (UNBTHBF) –

- When mounting worksurfaces to storage with cubbies, the option for bracket with flush plate must be selected – the flush plate attaches the worksurface to a shelf in the storage

planning with worksurface to storage support (continued)

Reconfigurable Low Credenza-to-Worksurface Support (UWCPWN)

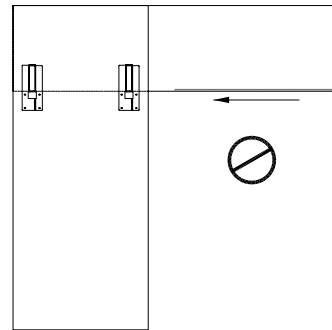
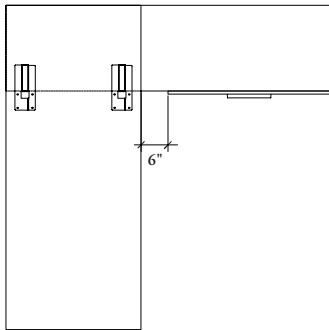
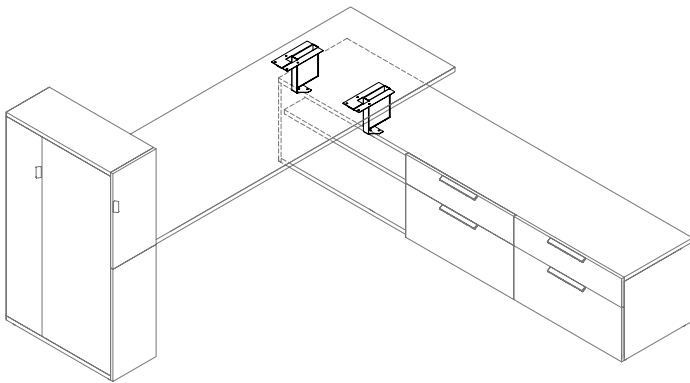

- The brackets are mounted towards the edges of the worksurface
- The open section of the storage below **cannot** be more than 6" wider than the worksurface to which it is attached to provide adequate support, therefore, a 24" deep worksurface **cannot** mount to the 36" wide open cubby of a 72", 84" or 96" wide credenza; the width difference is more than 6"

The sliding door credenza **cannot** be used with the reconfigurable low credenza-to-worksurface support because the track obstructs mounting

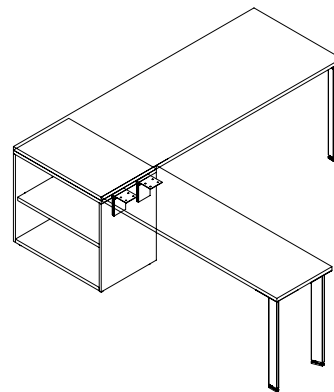
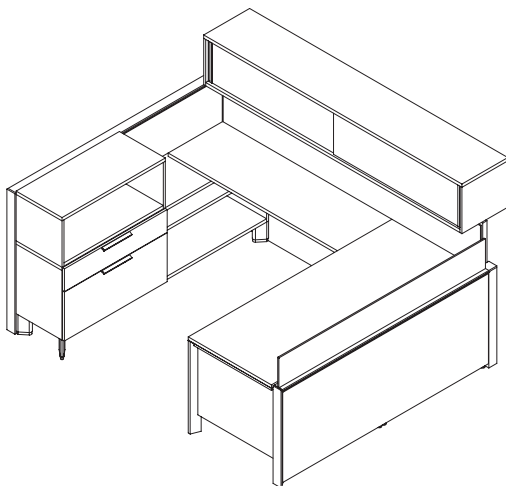

- When a high credenza or storage unit is mounted below a worksurface, it does not allow room for a Worksurface Panel Wall Bracket (UNBP) in the same location, therefore, in panel mounted applications (particularly when overhead storage is used) proper panel support is required
- The storage is attached to the underside of the worksurface, the worksurface is attached to the panel as closely as possible to the storage with the Worksurface Panel Wall Bracket (UNBP), and the storage is mounted to the panel with the Storage-to-Panel Bracket (UWSPB). If a return panel is used, the Storage-to-Panel Bracket (UWSPB) is not required, the return panel will support the spine. The storage needs to be attached to the worksurface only

- High storage, mounted to the underside of a worksurface will obstruct the ability to flush plate a return worksurface to the primary worksurface
- In this application the Worksurface-to-Tower Bracket Kit (UWBT), must be used, to mount the return worksurface to the side of the storage, and then the storage is attached to the bottom of the primary worksurface

storage-to-panel support basics

The following outlines the features the supports that connect storage-to-panels.

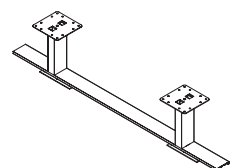
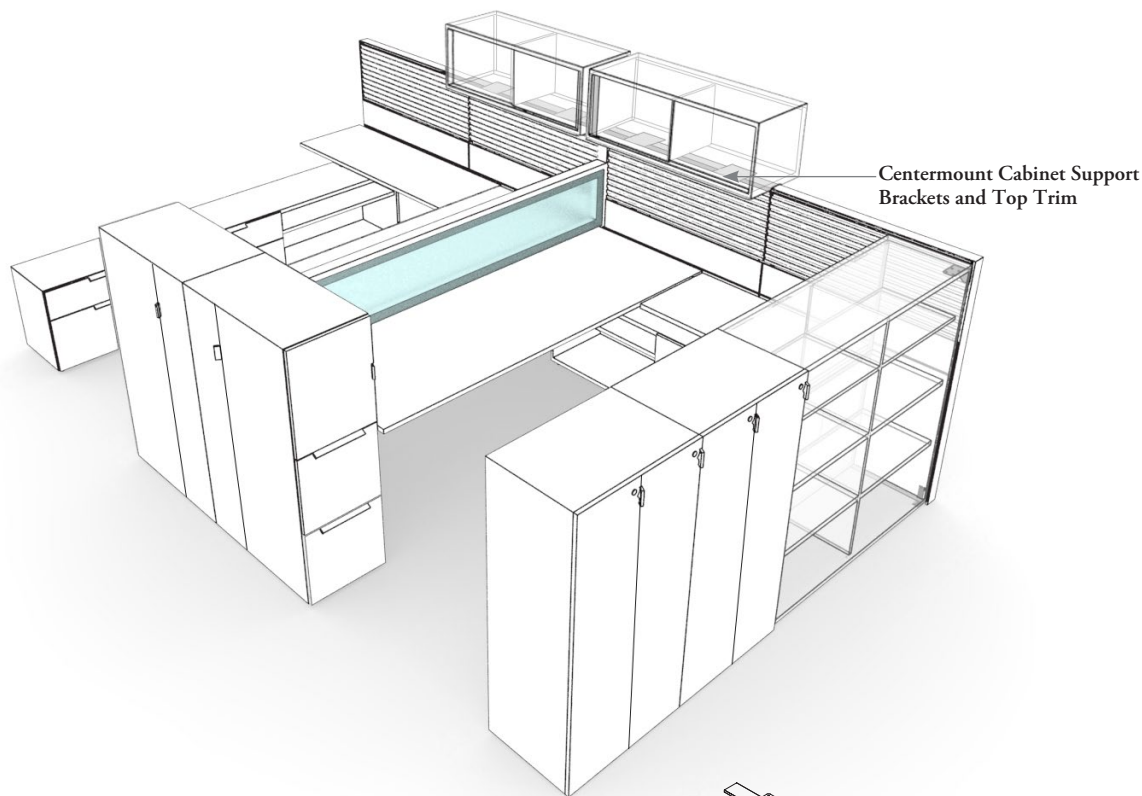

Centermount Cabinet Support Posts & Top Trim (UNOPT)

- Used to support upmount cabinets on-module
- Include the top trim and posts, so replaces a standard top trim
- Available 9" high or 13" high posts and 30"- 60" wide
- To maintain District datum heights it is recommended on a panel 42" high use a 9" post and a 15" cabinet for 66" high datum, and on a panel 29" high use 13" post and a 9" cabinet for a 51" high datum

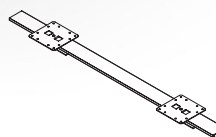

Centermount Cabinet Support Brackets & Top Trim (UNOBT)

- Similar to Centermount Cabinet Support Posts & Top Trim (UNOPT) except that there are no posts
- Are available from 30" - 96" wide

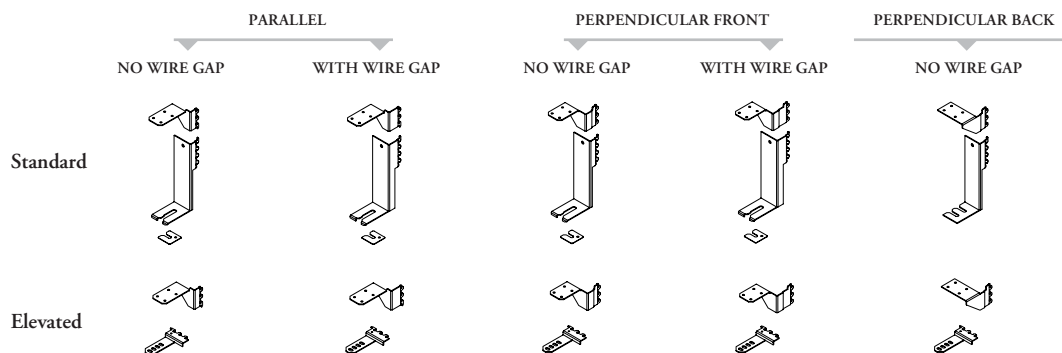



Storage-to-Panel Bracket (UWSPB)

- Attaches to the back or side of a storage component and mounts into the vertical channel of a District panel, to provide support to a panel wall
- Options are available for parallel and perpendicular mounting at either the front or back of the cabinet, and for elevated and standard credenza heights
- Available with wire gap options
- Must be specified left or right handed, handedness being determined by the side of the panel to which storage is attached

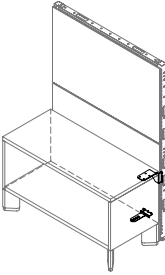

selecting the correct storage-to-panel bracket

All storage units attach to panels with either parallel, perpendicular front or perpendicular back brackets. The following outlines each option, and which cabinets use each individual option.

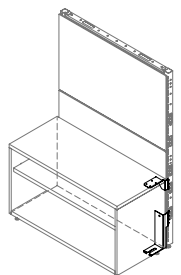
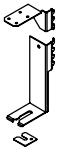
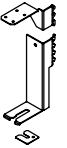
parallel mounting



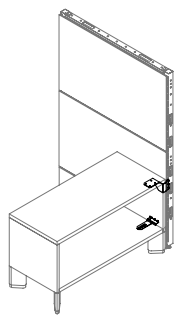

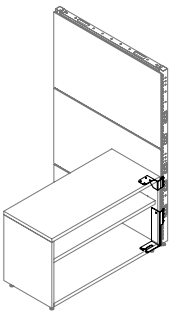
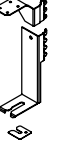
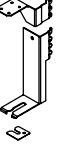
		<ul style="list-style-type: none"> • 3/8" offset (no gap) Elevated Storage 	<ul style="list-style-type: none"> • Used on storage with a closed back that fits flush or parallel to a panel wall • Bracket will attach to the storage unit through the slot located on the back of the unit • Available with 3/8" offset when no gap is required between the storage and panel wall, and 1" offset when a gap is required • Available for elevated and standard storage heights • Bracket fits into the vertical slots of the District panel wall • Handedness is determined by the side of the panel when facing it onto which the storage is mounted <p>Parallel mounting is used on the following storage units: UBKE, UBKS, UFLS, UKC, UKQ, UTLE, UTLS, UTCE, UTCS, UPFD, UPSE, UPSS, UKSD, UTDD, UTDK all credenzas</p>
		<ul style="list-style-type: none"> • 1" offset (with gap) Elevated Storage 	
		<ul style="list-style-type: none"> • 3/8" offset (no gap) Standard Storage 	
		<ul style="list-style-type: none"> • 1" offset (with gap) Standard Storage 	

perpendicular mounting, front

		<ul style="list-style-type: none"> • 3/8" offset (no gap) Elevated Storage 	<ul style="list-style-type: none"> • Used when bracket is being attached to the inside of an open cubby space (not through a slot in the back). This mounting option is appropriate for units that have: <ul style="list-style-type: none"> - open section (open credenzas, bookcases, etc), - cubby back (single lockers, pedestals) and - door in the mounting location (dual lockers etc) • Available with 3/8" offset when no gap is required between the storage and panel wall, and 1" offset when a gap is required • Available for elevated and standard storage heights • Bracket fits into the vertical slots of the District panel wall • Handedness is determined by the side of the panel when facing it onto which the storage is mounted <p>Perpendicular mounting, front is used on the following storage units: UBKE, UBKS, UHHE, UHHS, UHOE, UHOS, ULHE, ULHS, ULOE, ULOS, UTCE, UTCS, UTDC, UTLE, UTLS</p>
		<ul style="list-style-type: none"> • 1" offset (with gap) Elevated Storage 	
		<ul style="list-style-type: none"> • 3/8" offset (no gap) Standard Storage 	
		<ul style="list-style-type: none"> • 1" offset (with gap) Standard Storage 	

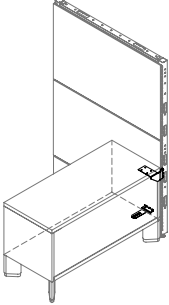
selecting the correct storage-to-panel bracket (continued)

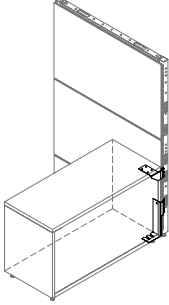
perpendicular mounting, back

		<ul style="list-style-type: none"> • 3/8" offset (no gap) Elevated Storage 	<ul style="list-style-type: none"> • Used on storage that sits perpendicular to the panel but attachment is through the back of the storage unit through the slots • Available with 3/8" offset only (no gap) • Available for flush and elevated configurations • Bracket fits into the vertical slots of the Leverage panel • Handedness is determined by the side of the panel when facing it onto which the storage is mounted
		<ul style="list-style-type: none"> • 3/8" offset (no gap) Standard Storage 	<p>Perpendicular mounting, back is used on the following storage units: UBKE, UBKS, UFLS, UKQ, UPSE, UPSS, UTCE, UTCS, UTLE, UTLS all credenzas</p>

planning with keyboard trays

The following keyboard trays and components can be used on District workspaces with Reinforcement Channels.

- When mounting a keyboard tray to workspaces where a support is located, certain conditions apply, consult Complements: *Teknion's Ergonomics & Accessories Program* for details and Application Matrices
- When the unsupported workspace span is 48" or less, no reinforcement channels are required thus facilitating keyboard tray installation

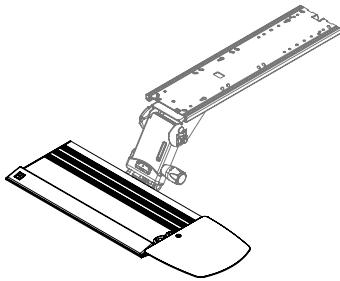

Tiers "T1" Aluminum Complete Keyboard Solution (YKT1)

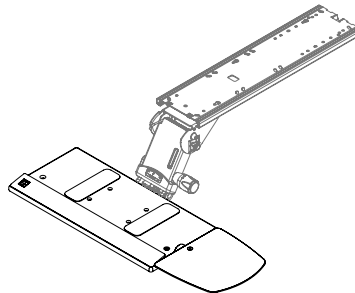

Tiers "T2" HDPE Complete Keyboard Solution (YKT2)

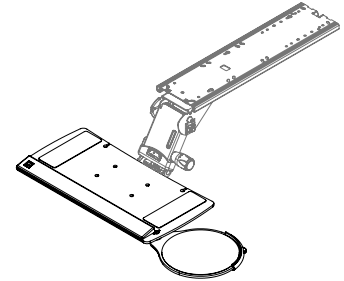

Tiers "T3" Small Phenolic Complete Keyboard Solution (YKT3)

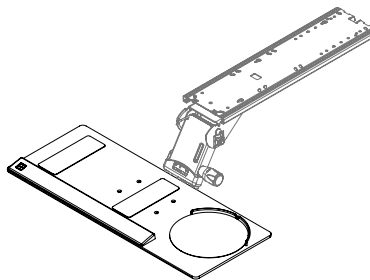

Tiers "T4" Large Phenolic Complete Keyboard Solution (YKT4)

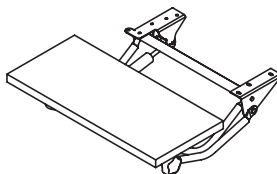

Rectangular Keyboard Tray (YKKW)

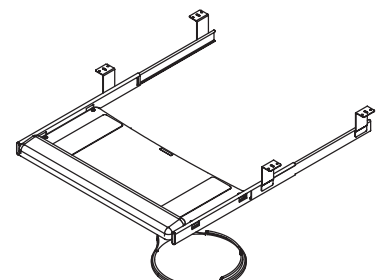

Retractable Keyboard Tray (YKRT)

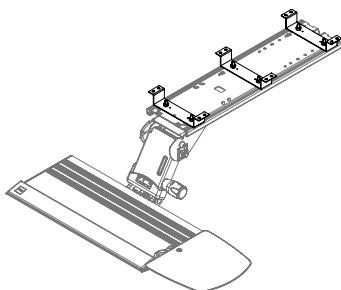

Accessories Offset Mount (YKMT-150)

planning with keyboard trays (continued)

compatibility with cantilevers

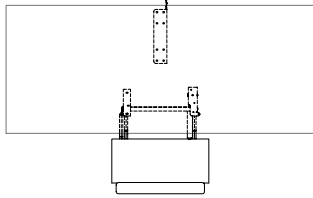

Rectangular Keyboard Tray (YKKW)
Fits on worksurface depths 24", 30", 36" and must sit 4" from cantilever

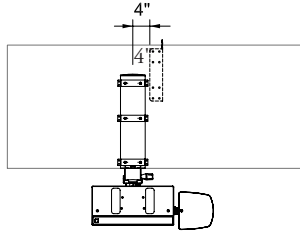

Accessories Offset Mount (YKMT-150)
Compatible with worksurface depths 24", 30", 36"

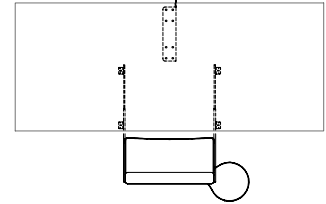

Retractable Keyboard Tray (YKRT)
Fits on worksurface depths 24" and 30"

worksurfaces supported by a mid-gable

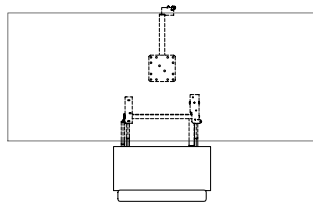

Rectangular Keyboard Tray (YKKW)
Compatible with all worksurface depths when the proper mid gable depth is specified

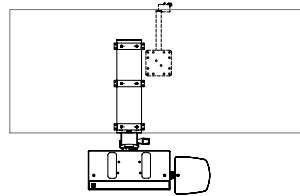

Accessories Offset Mount (YKMT-150)

- Fits on worksurface depths 30" and 36"
- Fits on 24" worksurface if keyboard tray handle does **not** interfere with half gable

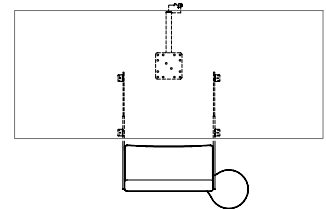

Retractable Keyboard Tray (YKRT)
Fits on worksurface depths 24", 30", 36"

planning with keyboard trays (continued)

The following charts outline keyboard compatibility with reinforcement channels.

Keyboard Tray (YKKW) used on rectangular worksurfaces

10.5" is required to the first reinforcement channel

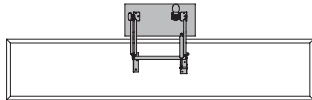

20" deep Rectangular Worksurface without Worksurface Reinforcement Channels

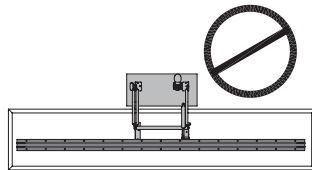

20" deep Rectangular Worksurface with Worksurface Reinforcement Channels

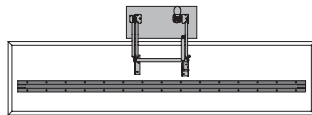

24" deep Rectangular Worksurface with one Worksurface Reinforcement Channel

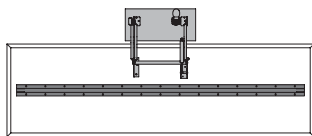

30" deep Rectangular Worksurface with one Worksurface Reinforcement Channel

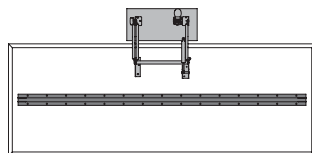

36" deep Rectangular Worksurface with one Reinforcement Channels

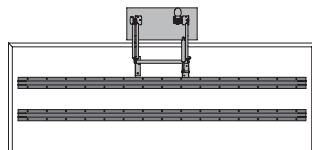

36" deep Rectangular Worksurface with two Reinforcement Channels

Keyboard Tray (YKKW) used on angled worksurfaces

Can be used on Wedge, Extended Wedge and Wing Worksurfaces

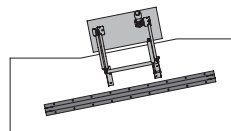

24" - 30" deep Transition Worksurface with one Worksurface Reinforcement Channel

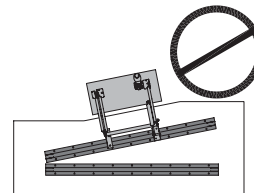

24" - 30" deep Transition Worksurface with two Worksurface Reinforcement Channels – keyboard tray **cannot** be installed here

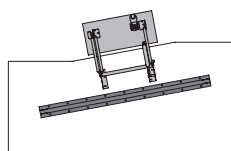

30" - 36" deep Transition Worksurface with one Worksurface Reinforcement Channel

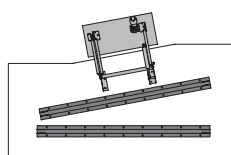

30" - 36" deep Transition Worksurface with two Worksurface Reinforcement Channels

planning with keyboard trays (continued)

The following charts outline keyboard compatibility.

Keyboard Tray (YKRT) used on Rectangular Worksurfaces (UNWR)

- Can be used with all worksurface depths regardless of the need for Worksurface Reinforcement Channels
- The brackets extend over the Worksurface Reinforcement Channels



20" deep Rectangular Worksurface with one Worksurface Reinforcement Channel



24" deep Rectangular Worksurface with one Worksurface Reinforcement Channel

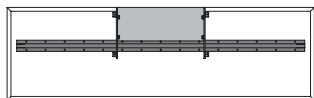

30" deep Rectangular Worksurface with one Worksurface Reinforcement Channel

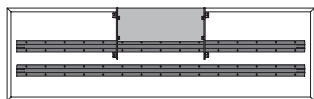

30" deep Rectangular Worksurface with two Worksurface Reinforcement Channels

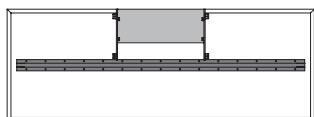

36" deep Rectangular Worksurface with one Worksurface Reinforcement Channel

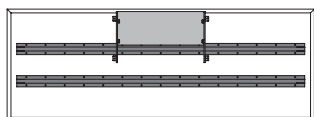

36" deep Rectangular Worksurface with two Worksurface Reinforcement Channels

Keyboard Tray (YKRT) used on Transition Worksurface (UNWT)

Can be used on Wedge, Extended Wedge and Wing Worksurfaces

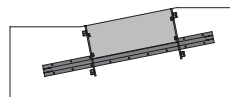

24" - 30" Deep Transition Worksurface with one Worksurface Reinforcement Channel

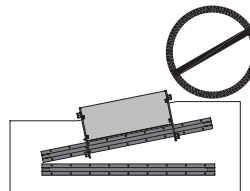

24" - 30" deep Transition Worksurface with two Worksurface Reinforcement Channels – keyboard tray **cannot** be installed here

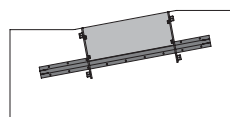

30" - 36" deep Transition Worksurface with one Worksurface Reinforcement Channel

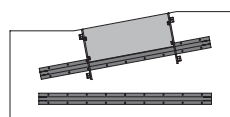

30" - 36" deep Transition Worksurface with two Worksurface Reinforcement Channels

accessories

accessories

UNDERSTANDING ACCESSORIES.	321
STORAGE MOUNTED FASCIA BASICS.	322
PLANNING WITH STORAGE MOUNTED FASCIAS	323
SCREEN & PANEL MOUNTED FASCIA BASICS	324
PLANNING WITH SCREEN-MOUNTED & PANEL-MOUNTED FASCIAS.	325
TOWER & LOCKER INFILL BASICS.	326
PLANNING WITH TOWER & LOCKER INFILLS	327
SEAT CUSHION BASICS.	328
COMPLEMENTS ACCESSORY BASICS	329

understanding accessories

A variety of accessories are available to enhance the functionality to District workstations.

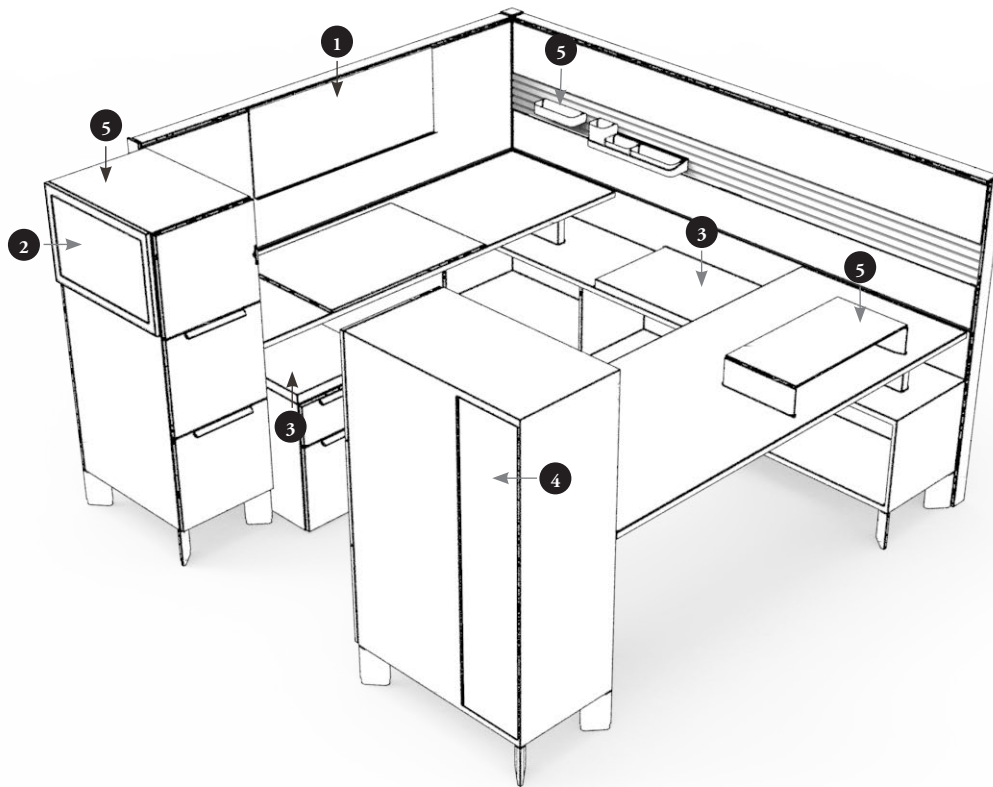

- 1 Screen- and Panel-Mounted Tackboards** provide additional functionality to screens and panel walls. The **Tackboard** provides a framed tackable surface and the **whiteboard** provides an erasable writing surface.
- 2 Tackable and Whiteboard Storage Fascias** are available for mounting to Standing Storage and Stacking Storage in heights that correspond with Elevated and Standard storage heights.
- 3 Seat cushions** provide additional guest seating in a workstation and are available for low credenzas or rolling pedestals.
- 4 Storage Infills** provide the ability to enclose and add functionality to open cubbies with options for solid whiteboard and tackboard depending on format.
- 5** The Teknion Complements program offers additional accessories such as desk pads, binder dividers organizing trays for storing smaller items, and Podium.

storage mounted fascia basics

The following mounted fascias are available for use with Standing and Stacking Storage and for screen and Panel Wall mounting.

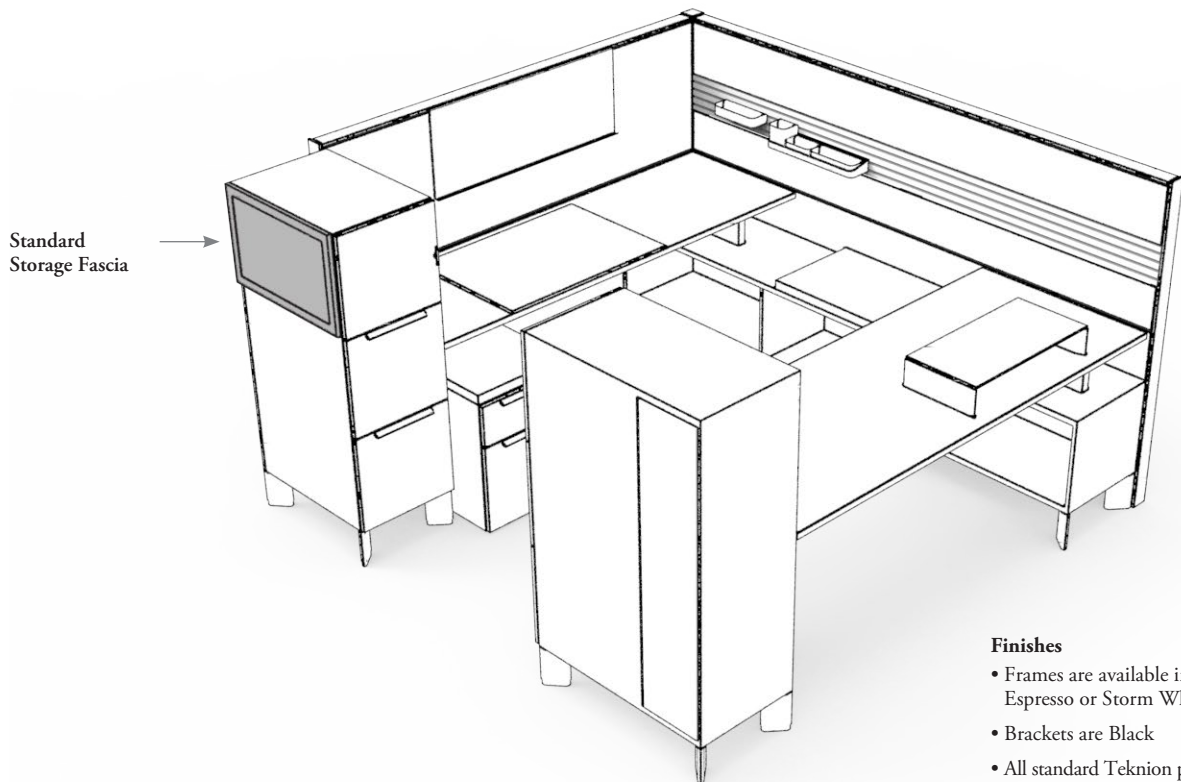

- Finishes**
- Frames are available in Clear Anodized and Espresso or Storm White paint finishes
 - Brackets are Black
 - All standard Teknion panel fabrics are available, however Architectural Fabrics are available on widths up to 48" only

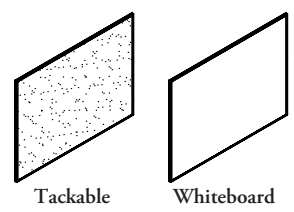

- Standing Storage Fascia (UNPSF)**
- Mounts to storage units that are freestanding and **not** stacked onto other storage units
 - Available in tackable and whiteboard finishes
 - Can be mounted onto a single unit only, and **cannot** span across two units
 - Available in heights from 12" to 60" in 1" increments and widths from 12" to 48" in 1" increments
 - Whiteboard sizes are restricted to widths of 48"
 - Can be mounted to the back or side of units
 - Sizes are available to accommodate lockers with open cubbies at the back –the fascia will cover only the closed portion of the cabinet

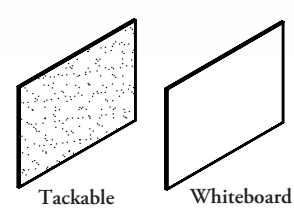

- Stacking Storage Fascia (UNPSS)**
- Mounts to storage units that are stacked onto a credenza or other base unit
 - Available in tackable and whiteboard finishes
 - Can be mounted onto a single unit only and **cannot** span across two units
 - Available in heights from 15" to 45" in 1" increments and width from 24" to 96" in 6" increments
 - Whiteboard sizes are restricted to widths of 48"

planning with storage mounted fascias

The following should be taken into consideration when planning with mounted fascias on standing and stacking storage.

determining fascia sizes required for standing storage

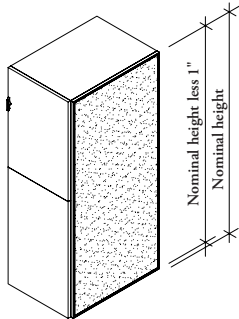

- For standard storage, the storage fascias must be ordered 1" shorter than the nominal height of the cabinet to allow for the gap at the base of all cabinets
- The width should match either the width or depth of the cabinet, depending on whether the fascia is being mounted to the back or side of the unit

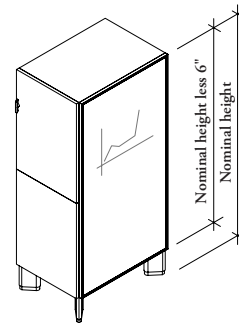

- For elevated storage, the storage fascias must be ordered 6" shorter than the nominal height of the cabinet to allow for the ht. of the feet
- The width should match either the width or depth of the cabinet, depending on whether the fascia is being mounted to the back or side of the unit

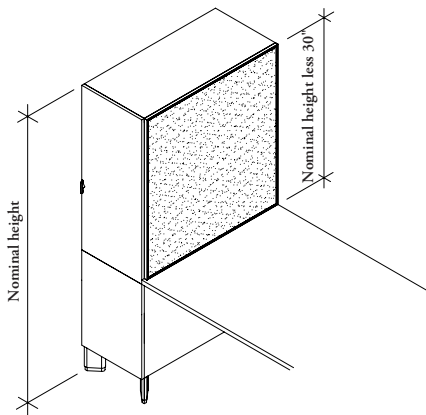

- For standard and elevated storage, where the storage fascia is required to be above the worksurface only, the tackable fascia must be ordered 30" shorter than the nominal height of the cabinet

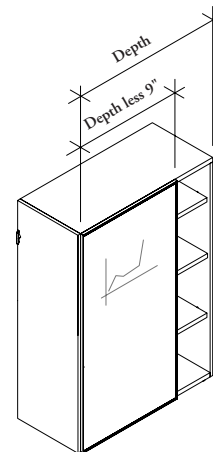

- For single lockers and pedestal towers with cubbies that are 29" and 35" deep and have an open section at the back, the storage fascia should be ordered 9" narrower than the overall depth of the cabinet

determining mounted fascias for stacking storage

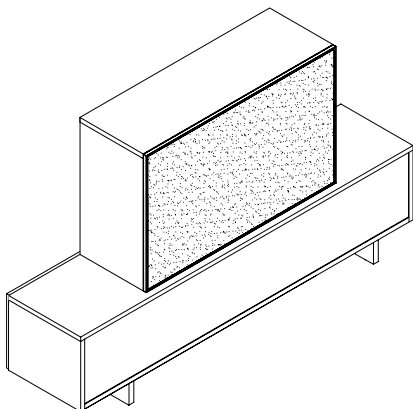

- Mounted fascias for stacking storage are specified the same width and height as the stacking cabinet

whiteboard widths

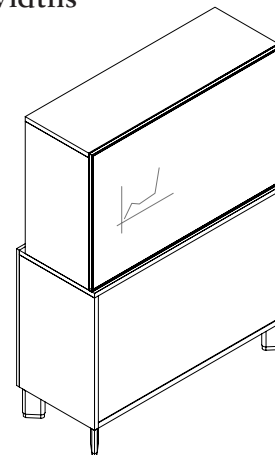

- Whiteboards widths are restricted to 48"

screen & panel mounted fascia basics

The following mounted fascias are available for use with Standing and Stacking Storage and for screen and Panel Wall mounting.

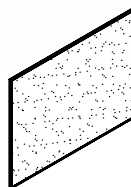
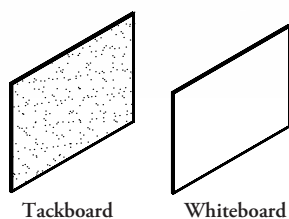
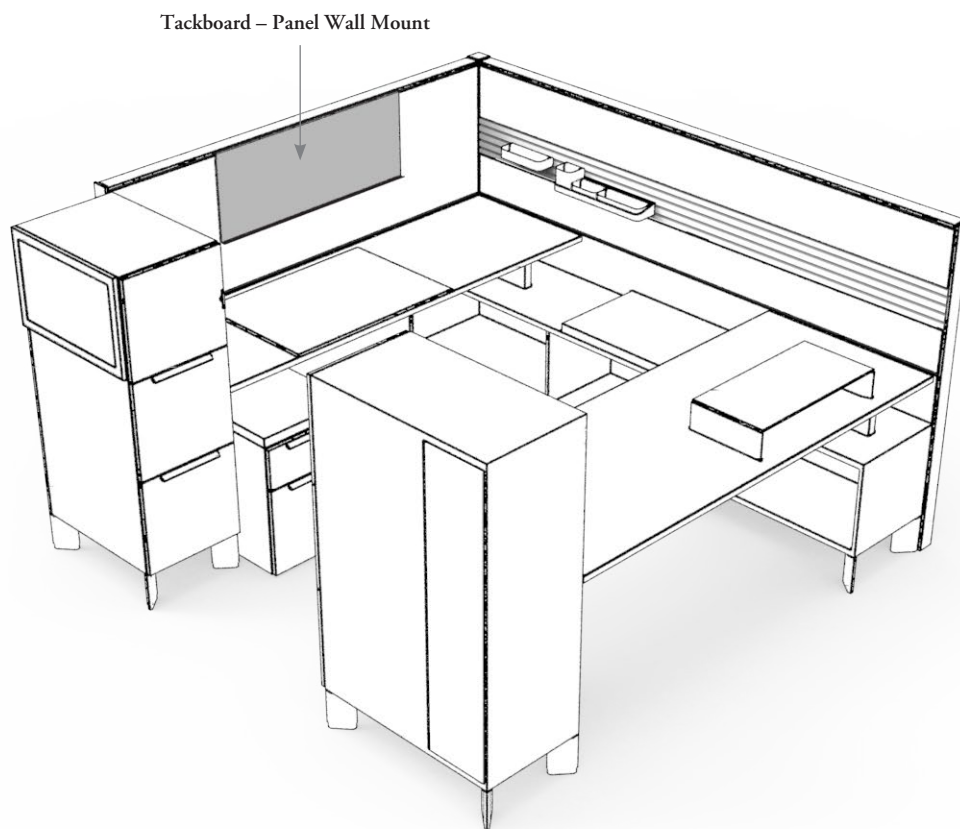

Tackboard – Screen Mount (UNTBS) and Whiteboard – Screen Mount (UNTBW)

- Mounts to a floor desk-edge or storage screen
- Can be mounted on- or off-module and can be user relocated
- Covers the mounting rail of a floor screen, so mounting personal accessories **cannot** be used when the tackboard is used
- Available in heights of 13" and 22" to match above worksurface datum heights in
- Tackboards available in widths from 23" - 96" and the Whiteboard available from 23" - 48"
- Mounting brackets are available in the same finishes as the top rail on the floor screen
- Mounting brackets are available in the same finishes as the top rail on the floor screen

Tackboard – Panel Wall Mount (UNTBP)

- Mounts to the top rail of a panel wall to provide a panel-mounted tackboard
- Can be mounted anywhere along the panel wall and can be user relocated
- Available in heights of 13", 22" and 37" to match above worksurface datum heights and in widths from 23" to 96" in 1" increments

planning with screen-mounted & panel-mounted fascias

The following should be taken into consideration when planning with tackboards, screen mounted.

screen mount tackboard and whiteboard

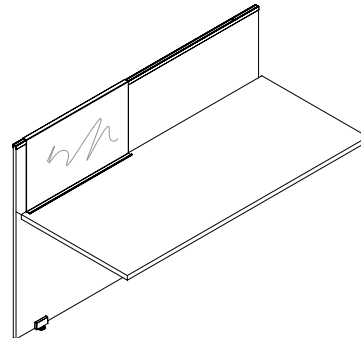
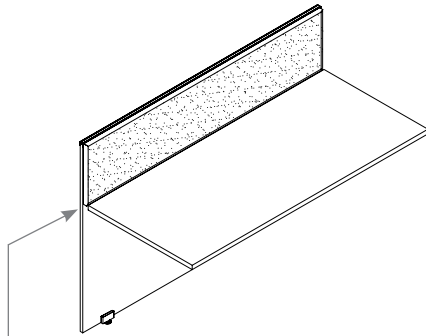

- Can be mounted on Floor Screens and Storage Screens
- Actual height will be 1" less than nominal height to allow clearance for cable management
- Nominal widths = actual widths, the tackboard will match that actual width of the screen
- **Cannot** be used with Casual Lateral Screens

panel-mounted tackboard

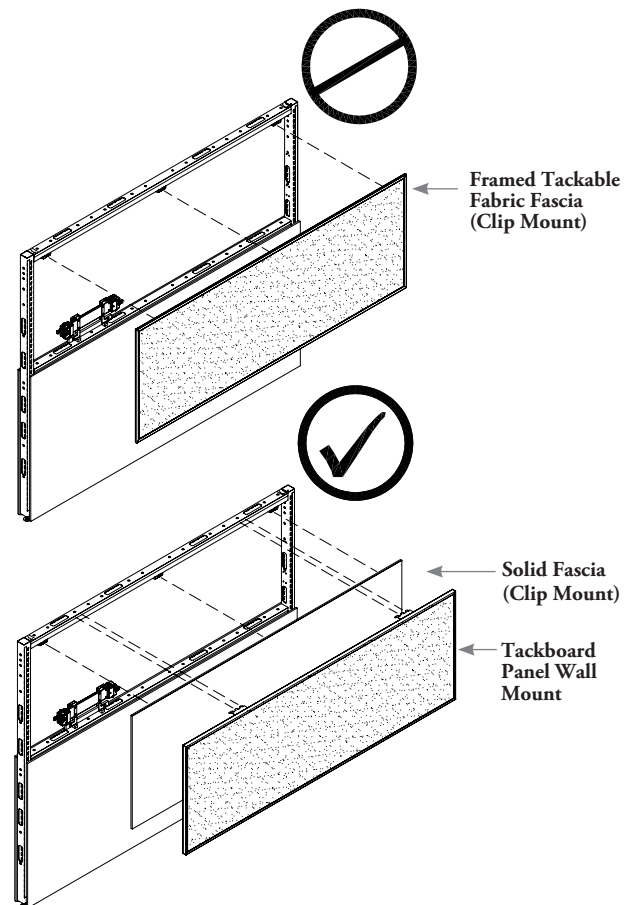
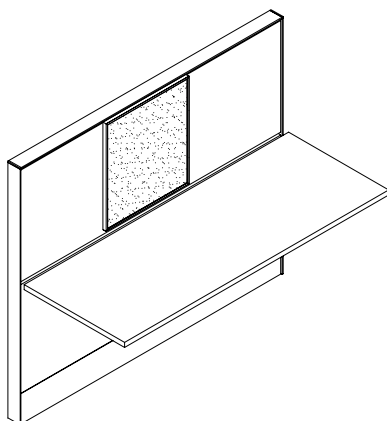

- The panel wall mounted tackboard is an ideal solution when planning with "D-Style" hard surface fascias and only a small area of tackboard is required
- The tackboard mounts onto the face of a hard surface fascia and can be any width, allowing for on- or off-module planning

- Tackboard panel wall mount is ideal for use when a framed tackboard is required on the back side of a single-sided power application (a standard framed tackable fascia will **not** fit in this application, see Fascia section). The framed tackboard can mount onto a solid fascia, and maintain similar aesthetic to adjoining workstations

tower & locker infill basics

Infills are used with towers and lockers to convert open formats to fully enclosed and secure cabinets. The following outlines the features of each type.

lateral tower, combo tower, pedestal tower with cubby and single locker infills

- Mount into either Elevated or Standard height cabinets
- Available in heights of 36", 42", 51" and 66"
- Height and width is determined by the size of the cabinet, **not** the size of the opening into which it is mounting
- Solid finishes are available in Source Laminate, Flintwood and Natural Veneer

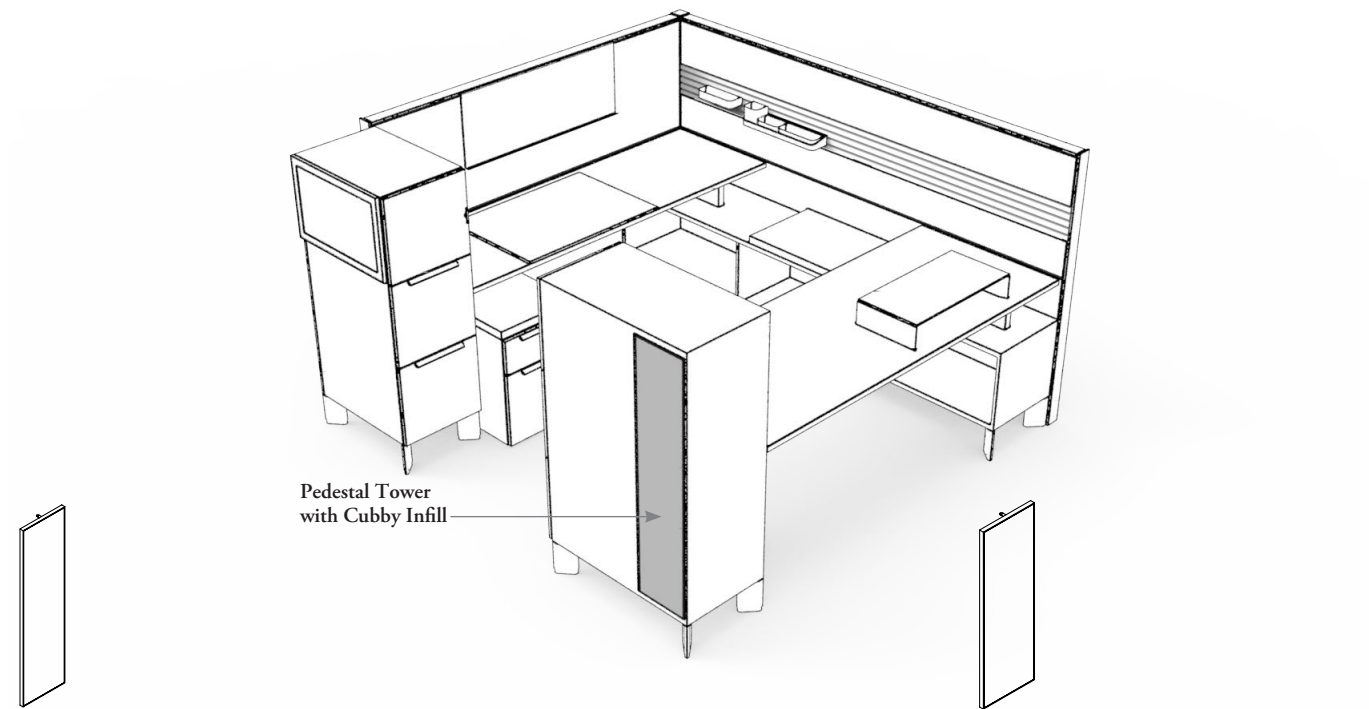

Single Locker with Cubby Infill (UKSCIS)

- A solid finish on the inside and outside to provide a closed back

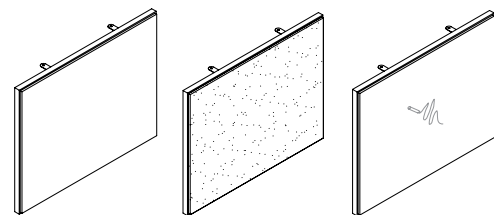

Combo Tower Infill (UTCXIS)

Cannot be used on Combo Tower with Source Laminate Case

Source Laminate Combo Tower Infill (UTCXIX)

Can only be used on Combo Tower with Source Laminate Case

Solid Outside

- A solid finish on the inside and outside to provide a closed back

Fabric Outside

- Provides a fabric tackboard on the outside of the cabinet; inside is a painted finish

Whiteboard Outside

- Provides a whiteboard on the outside of the cabinet; inside is a painted finish

Pedestal Tower with Cubby Infill (UTDCIS)

- A solid finish on the inside and outside to provide a closed back

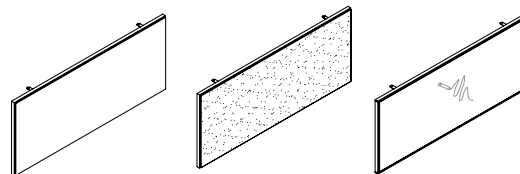

Lateral Tower Infill (UTLXIS)

- There is no 35" high elevated option

Solid Outside

- A solid finish on the inside and outside to provide a closed back

Fabric Outside

- Provides a fabric tackboard on the outside of the cabinet; inside is a solid finish

Whiteboard Outside

- Provides a whiteboard on the outside of the cabinet; inside is a solid finish

planning with tower & locker infills

The following should be considered when planning with infills

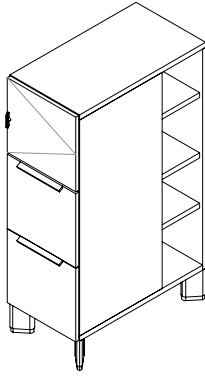

- All towers and lockers that accommodate infills are handed; handedness being determined by the hinge location of the storage section
- The cubby shelf is inset on the same side to accommodate the infill
- On 36" high cabinets with no storage section, the unit is still considered handed because of the shelf inset

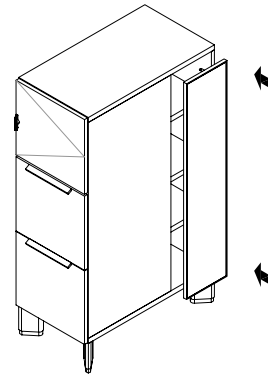

- When specifying the infills the size is determined by the actual size of the cabinet it is being used on, **not** the size of the opening

seat cushion basics

The following options are available for District seat cushions.

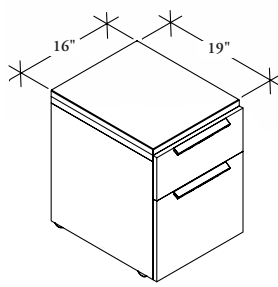
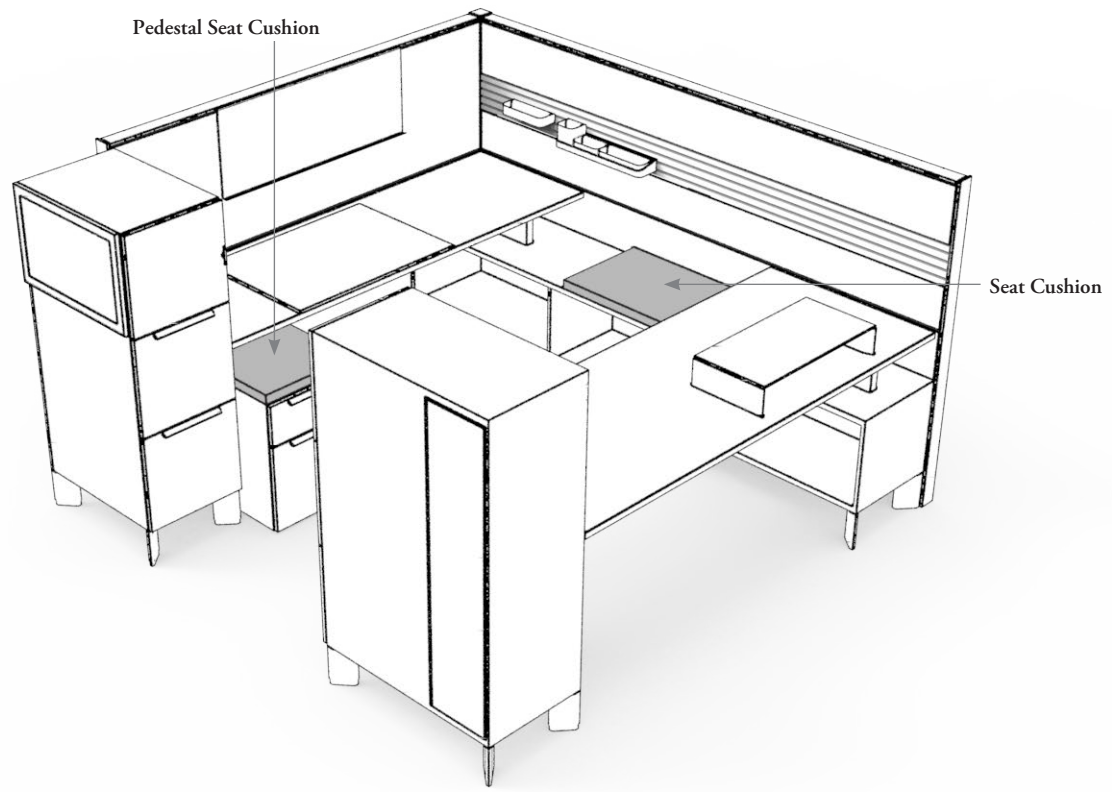

Pedestal

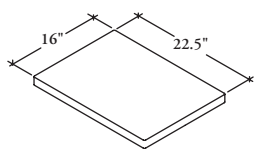

Credenza

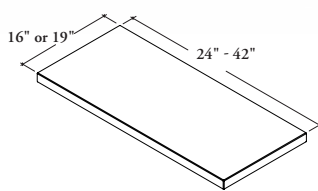

Credenza

Seat Cushion (UWLC)

- Provides space saving casual guest seating in a workstation
- Available in two options:
 - C - used on low credenzas (placed upon but **not** affixed)
 - R - mounted onto rolling pedestals only
- Can be specified on the Rolling Pedestal (UPR) at the time of order, or can be ordered separately and retrofitted onto an existing Rolling Pedestal
- The credenza option is sized to be used on 16" and 19" deep credenzas
- Available in all of Teknion's standard Seating fabrics

Fitted Seat Cushion (UWLF)

- Sized to fit precisely onto credenza tops
- Match depths of credenzas and the widths match drawer widths of credenzas
- Available in all Teknion standard seating fabrics except leather

complements accessory basics

Teknion's Ergonomics and Accessories program, Complements, offers a number of accessories that are designed for use with District.

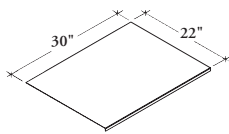
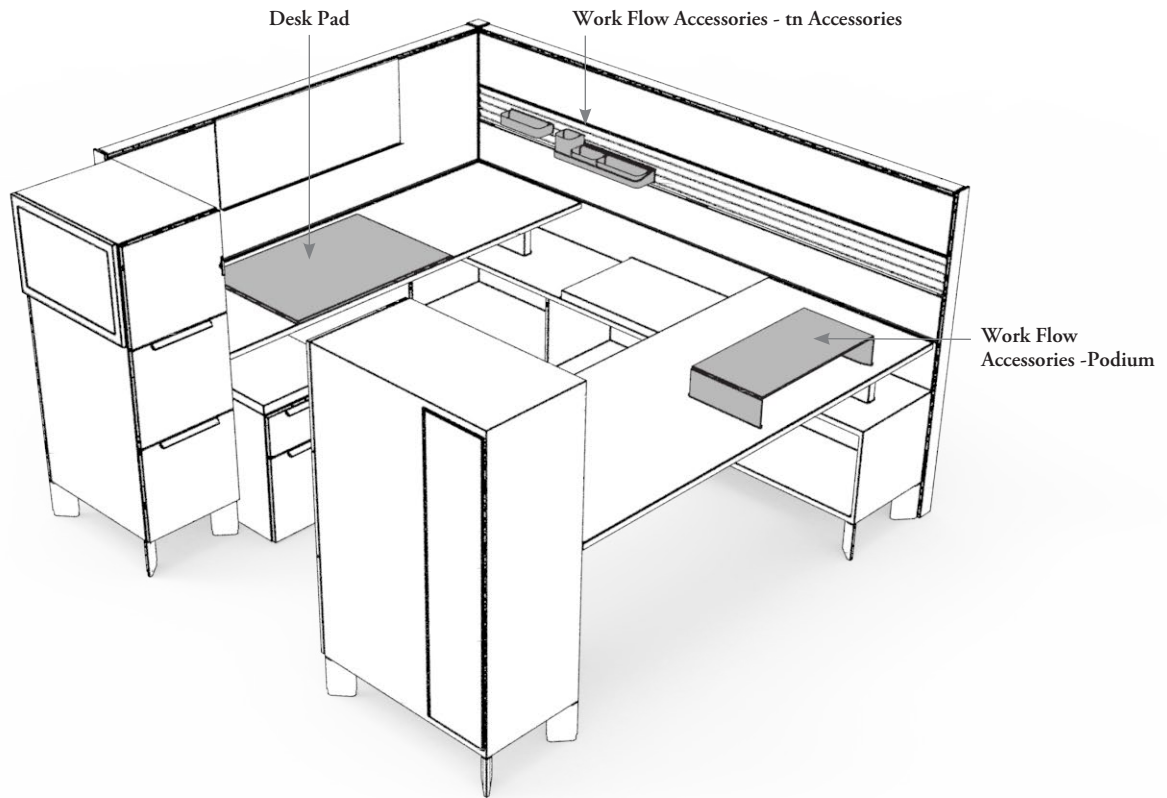

Desk Pad (YPDP)

- Lays onto any thickness of worksurface with a flat or knife edge style without tools
- Can span the corner between two worksurfaces to create a conventional angled computer corner
- Includes an integral cable management retainer for easy laptop plug in

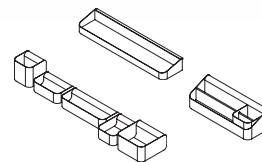

tn Accessories

- A series of Desktop and Freestanding Storage items that complement any workspace.

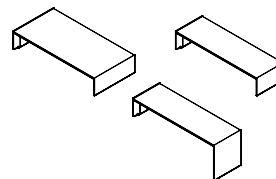

Podium

- A collection of shelves and accessories to organize laptops, flat screen monitors, and multiple hand-held electronic peripherals

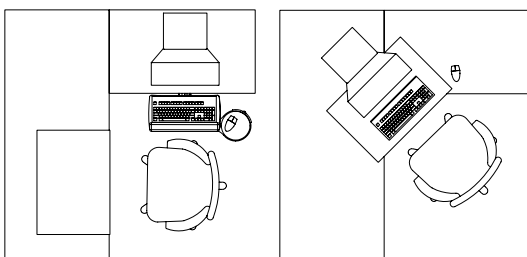

- The desk pad is typically used on the primary worksurface, however it can also span across the corner of two worksurfaces to create a conventional angled computer corner – the steel inner construction provides the stability required to support a keyboard tray – **cannot** be used if the two surfaces are at different heights

electrics

electrics

ELECTRICS & COMMUNICATIONS OVERVIEW	332
POWER ENTRY BASICS – PANEL-MOUNTED WORKSTATIONS . . .	335
PLANNING WITH POWER POLES	334
POWER & COMMUNICATIONS BASICS – PANEL-MOUNTED WORKSTATIONS.	335
PLANNING WITH POWER BOXES & OUTLETS.	336
WIRING SYSTEMS.	338
POWER DISTRIBUTION BASICS – PANEL-MOUNTED WORKSTATIONS.	339
PLANNING WITH HARNESES	340
DETERMINING HARNESES LENGTHS	341
CASUAL ELECTRICS BASICS – PANEL-MOUNTED WORKSTATIONS.	342
STORAGE ELECTRICS BASICS	343
PLANNING WITH STORAGE	346
POWER CONSERVATION SYSTEM BASICS.	349
PLANNING WITH POWER CONSERVATION SYSTEM	350

electrics & communications overview

District offers a non-directional wiring system that allows for maximum flexibility and simple reconfiguration.

Power must be turned off during all installations and reconfigurations.

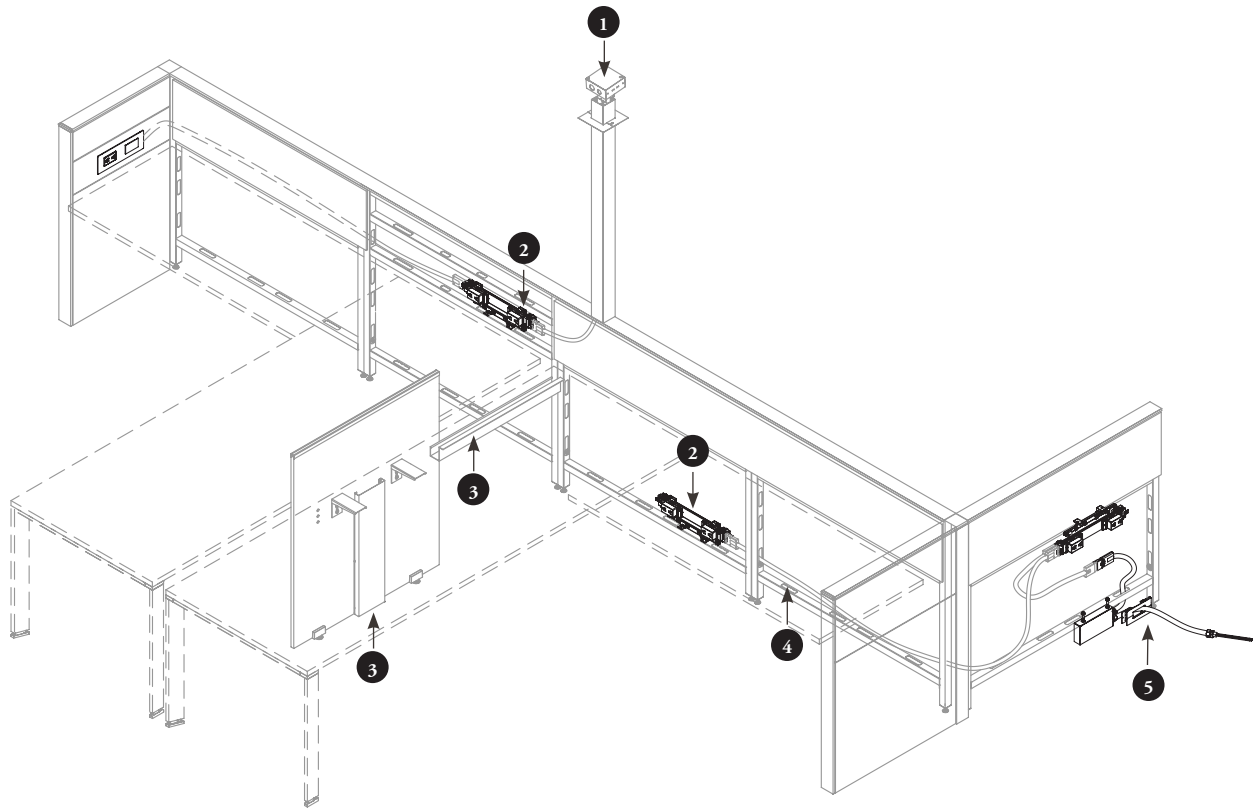

- 1 Power is provided to workstations by either a power pole or through a base feed.
- 2 Power boxes can be mounted above or below worksurface height.
- 3 When panels are **not** available for routing cables, casual wire management is available.
- 4 Power is distributed by harnesses connected by power boxes – the power box can accommodate up to four outlets, two on either side of the box, and the power can run in either direction from the box.
- 5 Power is provided to workstations by either a power pole or through a base feed.

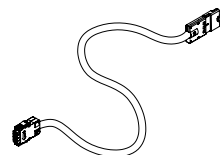

- A compatibility harness is available to connect the new style of power with the previous version of District electrics

power entry basics – panel-mounted workstations

Power and communications cables enter a workstation either through a base feed or a ceiling feed. The options are detailed below. The following outlines the features of the electrical and communication components available for use in District panel environments.

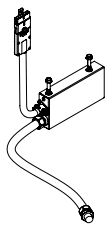
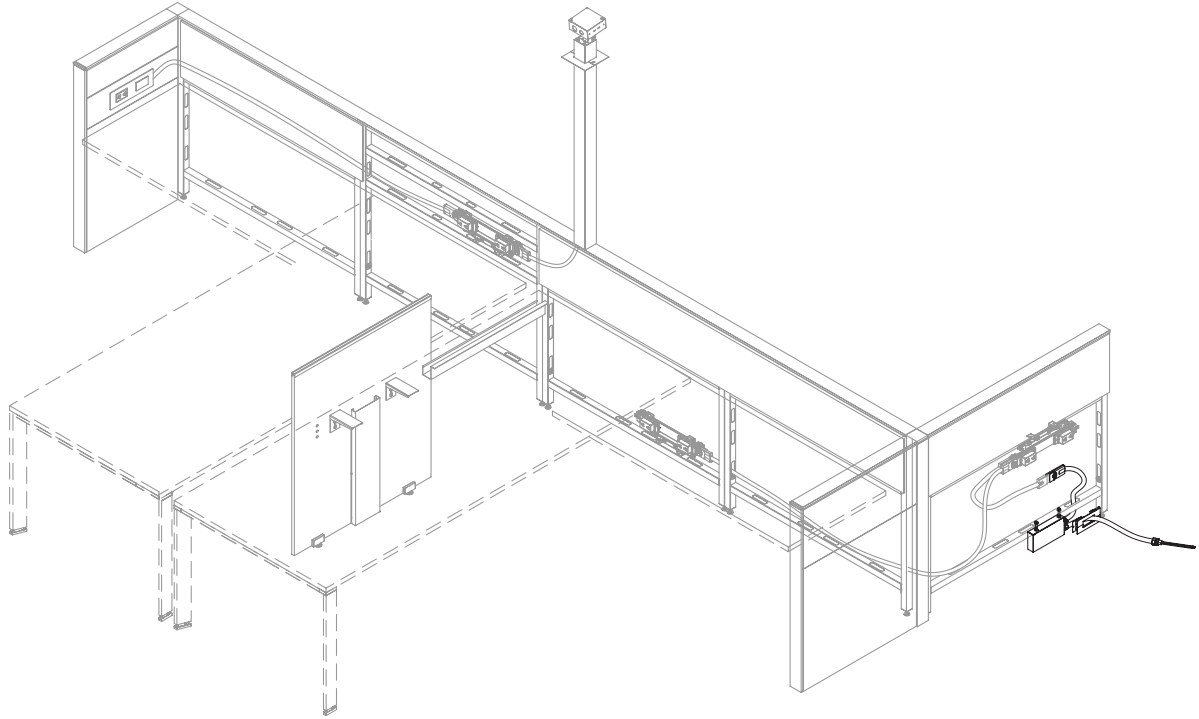

Base Feed (UNQBFR)

- A hard wired connection that supplies power into a panel from the building power source
- Both base feeds and harnesses can be used in the same panel
- Available in 8T, 7T, 8K and 7K wiring options to allow for most common Teknion wiring configurations
- Available in options for mounting into either solid fascias or metal or fabric fascias
- Available in a PVC free option
- If a base feed kit is mounted onto an elevated panel, it will be below the rail, therefore will be exposed.

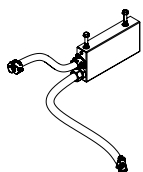

Chicago Base Feed (UNQBFRCH)

- Provides the conduit only for Chicago electricians wiring restrictions that require that all wiring and connections be supplied and connected by a licensed electrician
- Supplied with three wires for a single circuit only
- Available 72" long only
- Box painted Platinum

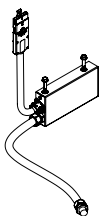

Split Base Feed (UNQBFSR)

- Same as the base feed except that it is hard wired to the building power supply in two places for New York City wiring restrictions
- Accommodates hard wiring within the floor monument and in the wiring junction box
- Box painted Platinum

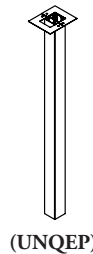

(UNQEP)



(UNQEPR)

Power Pole (UNQEP) and End of Run Power Pole (UNQEPR)

- Used to house the ceiling feed and includes a pole divider for separating the ceiling power feed from the communications and data cables
- Available in 48", 72" and 96" heights for up to 10' ceilings
- Available in options for corner mounting and off-module mounting
- End of Run Power Pole (UNQEPR) **cannot** be installed off-module or on a corner



Ceiling Feed (UNQCFR)

- Routes power into the panel from the ceiling through the power pole
- Includes a junction box to connect to the building power supply at the ceiling
- Also connects to a power harness
- Available in 8T, 7T, 8K and 7K wiring options to allow for most common Teknion wiring configurations
- Length of the feed represents the length of the harness encased in flexible conduit – an additional 6" of cable is provided for connection the ceiling junction box



Chicago Ceiling Feed (UNQCFRCH)

- Same as ceiling feed except that there is no connector on the bottom end due to Chicago electricians wiring restrictions
- Supplied with three wires for a single circuit only

planning with power poles

The following should be considered when planning with the Ceiling Feed Harness, Power Pole, End of Run Power Pole and Off-Module Power Pole

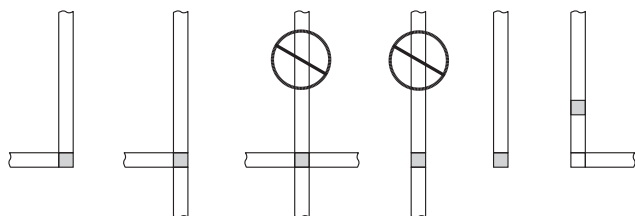

Two-Way 90° Three-Way 90° Four-Way 90° Two-Way 180° End of run Off-Module

- The Power Pole can be located at Two and Three-Way 90° corners and at end of run and off-module locations

Power Poles located at corners:

- Always terminates at the top of a corner assembly
- Connectors are specified to the highest height, and then the Power Pole is installed
- **Cannot** extend below highest panel

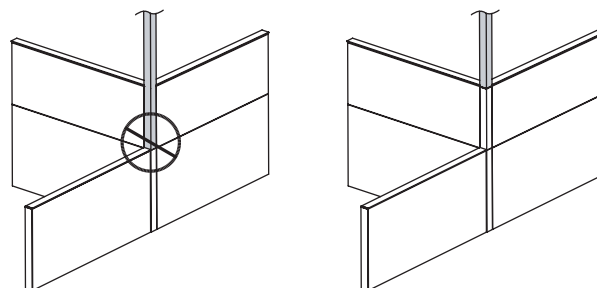

- Available in 48", 72" and 96" heights, and can be cut on site to required height
- Required height is the distance between finished ceiling height and top of the panel plus 4"
- Ceiling harness (120") is compatible for ceilings up to 10'
- Removable cover on one side gives access to the inside of the pole

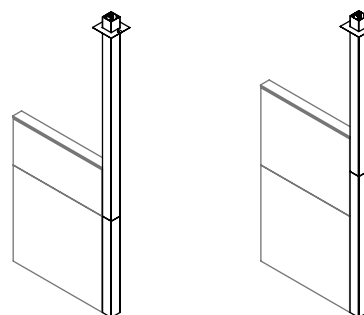

end of run power pole

- Is typically used when no corner location is available for the Power Pole
- Available in two heights. 29" high for 29" high Panel Walls or where only below worksurface panel entry for Power Harness is required and 42" high for Panel Walls 42" or higher, entry for Power Harness can be either above or below the worksurface
- An additional Power Pole to ceiling height must be specified above that

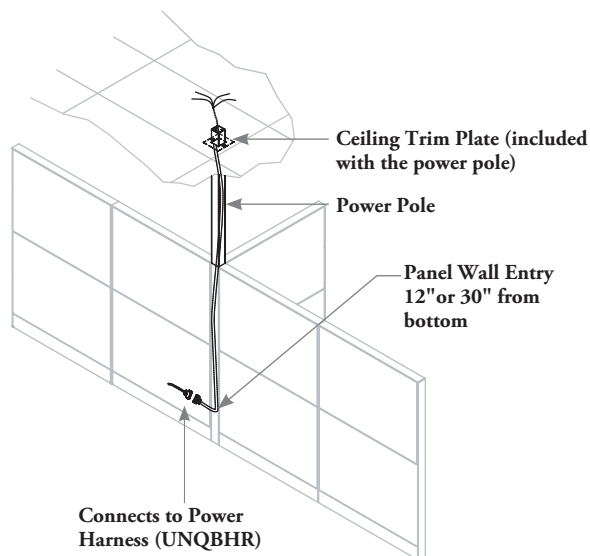

ceiling feed

- Available hardwired for building connection
- The other end of the harness is a female connection
- A power harness is required to route ceiling harness to a power box
- Chicago version must connect to a distribution box

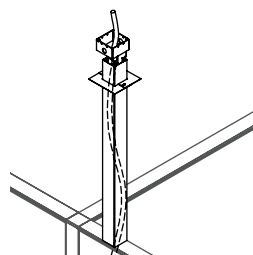

off-module power pole

- The Off-Module Power Pole Top Trim (UNTTTP) is complete with a cutout to accommodate the Power Pole (ordered separately) at 9" from any Panel Wall End.
- Can only be located where solid fascias or accessory rails are applied
- **Cannot** be located directly above a Tackable Fascia, Whiteboard or Glazed Fascias

power & communications basics – panel-mounted workstations

Power can be accessed at various heights within a panel wall through the use of power boxes and receptacles.

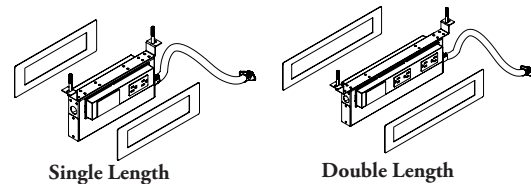
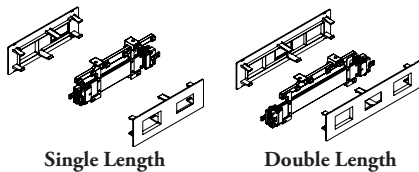
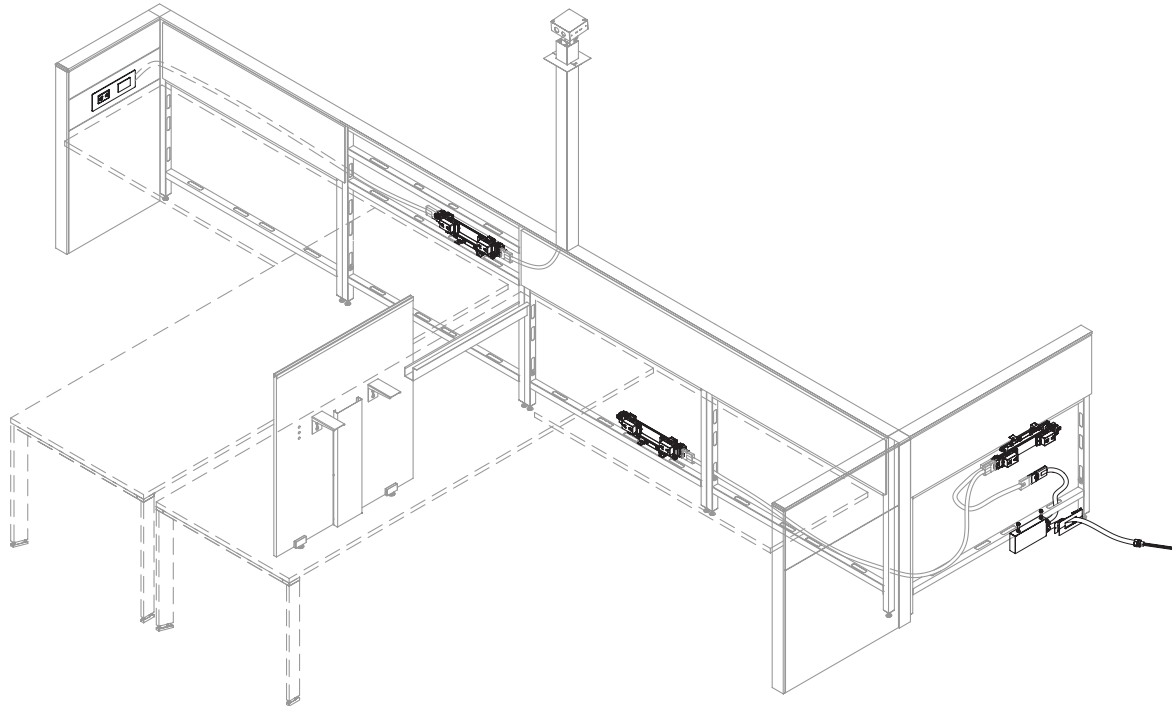

Power Box (UNQPR)

- A module for mounting receptacles (specified separately)
- Mounts to the panel frame below or above panel wall rails but does **not** clip to light block rails
- Available in single (S) or double (D) lengths – the 24" and 30" wide panels can only accommodate the single box
- Single length power box is 12" long and includes a bezel with one receptacle and one data opening
- Double length power box is 16" long and includes a bezel with two receptacle and one data opening
- Either a one-sided or back-to-back application must be specified (even though it is the same box), so that the proper amount of bezels will be included
- Available in a PVC free option

Chicago Power Box (UNQPRCH)

- Same as the power box except for Chicago electrics applications
- Includes the outlets and faceplates, but does **not** include any connectors – electrical connections must be done on site by a certified electrician
- Must be specified single or double length, and one-sided or back-to-back
- When placing the Power Box at the Base (Bottom Level 1), the "U" Above Worksurface Height (Upper Fascia) mounting location should be used

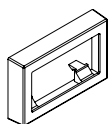

Data Extender Plate (UNQDE)

- The Data Extender Plate is placed over a communication opening to provide extended depth for data jacks which may be required in some applications. Consult your data cabling supplier for clearance requirements



Receptacle Outlet (UNQRO)

- A single duplex receptacle that slides onto the power box module to provide power
- Specified individually for maximum circuit flexibility
- Styles include Standard 15 amp, T-Slot 20 amp, USB, Controlled 15 and 20 amp
- Outlet configurations consist of Circuit 1, Circuit 2, Circuit 3 (use 8T only), Circuit 5 (8T and 8K only), Circuit 6 (use 8K only), Circuit A (7T and 7K only), Circuit B (7K only) and USB

planning with power boxes & outlets

The following should be considered when planning with District power boxes and outlets.

- Panel data capacity: minimum 24 cat. 5 cables at 60% fill
- Power Pole capacity: minimum 24 cat. 5 cables at 60% fill
- Frame openings for vertical routing are present on all panel frames. Each frame opening can accommodate a minimum of two harnesses

above and below worksurface power

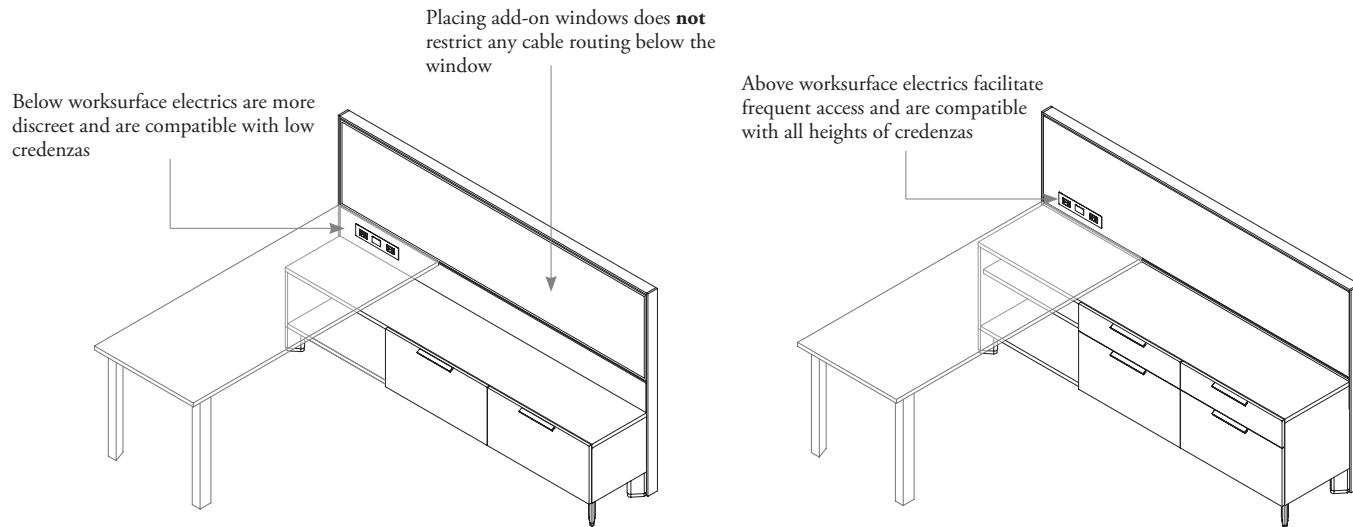

power cut out locations

- Power boxes can be placed at the top or bottom of a fascia with electrical cut outs depending on the height of the fascia

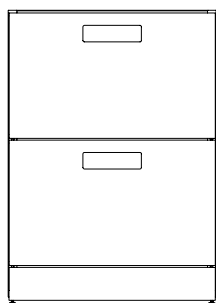

- Top cut outs are available in 13", 22" and 28" high fascias

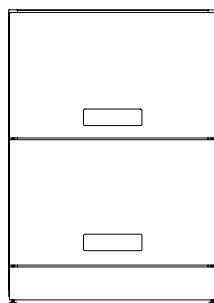

- Bottom cut outs are available in 7", 13", 22" and 37" high fascias

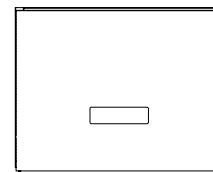

- Flush cut outs are available 28" high for use only on the base of the panel, and will be at the bottom

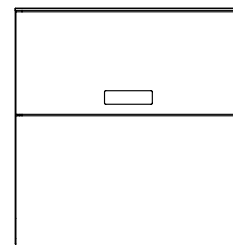
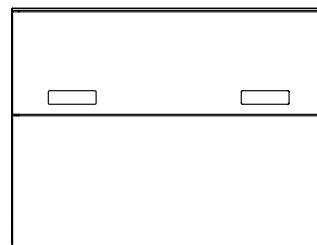
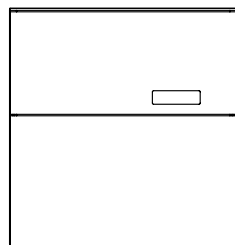
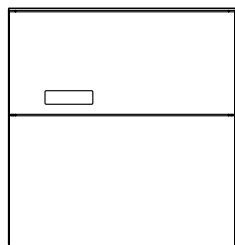

- Cut outs are available left, right or centered depending on panel width (See Fascia section)

planning with power boxes & outlets (continued)

data access

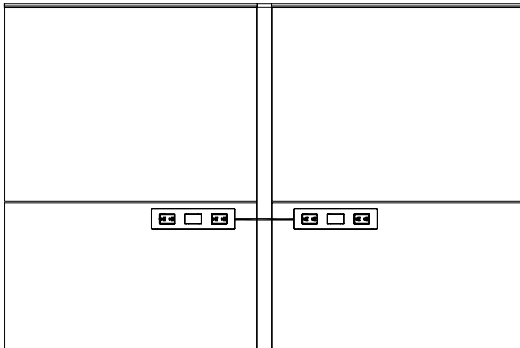

- Data access is in the center of the module and symmetrical on both sides of the panel

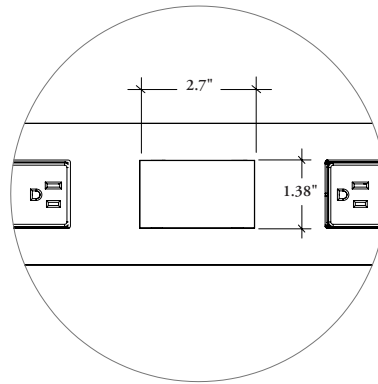

- Data access is provided in the cut outs on power/communications fascias, and on the faceplates included with power boxes
- Cut Outs will accommodate most standard communication faceplates
- The depth available for data jacks is 1.35" when using data faceplates

single-sided power

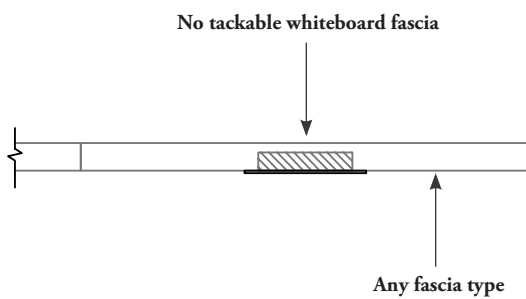

- When single-sided electrics are used, the fascia on the back side **cannot** be a D-Style fascia with a frame and clips except for the solid fascia; a slot-mounted fascia must be used to allow sufficient space for the power box

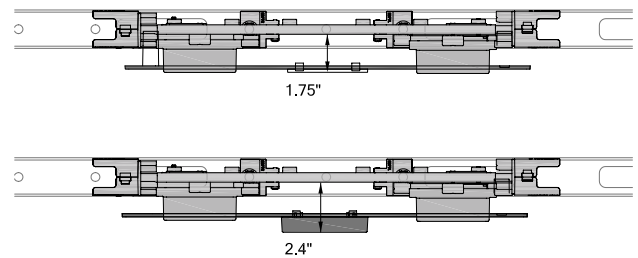

- The depth can be increased to 2" by using the Data Extender Plate (UNQED)

wiring systems

Four wiring systems are available for Interpret 8-Wire Isolated (8T), 7-Wire Non Isolated (7T), 8-Wire Dual Isolated (8K) and 7-Wire Dual Non Isolated (7K). Most common Teknion wiring configurations are achieved with these wiring systems.

For sites where Isolated Ground is not available, Teknion offers Non-Isolated Ground options for furniture wiring. The site electrician or electrical contractor/consultant can identify sites where Isolated Ground is not available. For those sites, please specify Teknion 7T or 7K wiring systems.

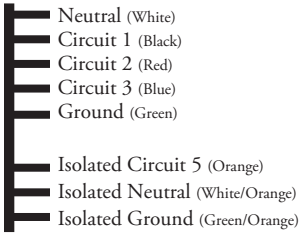
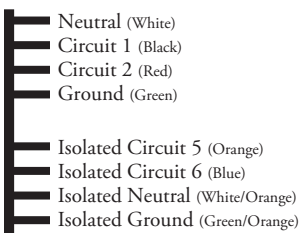
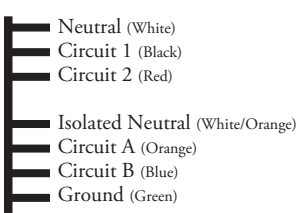
	No. Regular Circuits	No. Isolated Circuits
8-Wire Isolated (8T) (3+1) 	3	1
8-Wire Dual Isolated (8K) (2+2) 	2	2
7-Wire Non Isolated (7T) (3+1) 	4	0
7-Wire Dual Non Isolated (7K) (2+2) 	4	0

wiring system/receptacles

	Wiring System			
	8T	8K	7T	7K
Regular Ground Receptacles	1, 2, 3	1, 2	1, 2	1, 2, A, B
Isolated Ground Receptacles	5	5, 6	n/a	n/a

- All receptacles except Circuit 6 can be used with the 8T wiring system (**cannot** accept a 2nd Isolated Circuit)
- All receptacles except Circuit 3 can be used with the 8K wiring system (**cannot** accept a 3rd Regular Circuit)
- Circuit A is compatible with 7T and 7K. Circuit B is compatible with 7K only

wiring system/related circuit

	Wiring System			
	8T	8K	7T	7K
Regular Circuit 1 Receptacle	✓	✓	✓	✓
Regular Circuit 2 Receptacle	✓	✓	✓	✓
Regular Circuit 3 Receptacle	✓		✓	
Isolated Circuit 5 IG Receptacle	✓	✓		
Isolated Circuit 6 IG Receptacle		✓		
Regular Circuit A Receptacle			✓	✓
Regular Circuit B Receptacle				✓

✓ Applicable

15 Amp

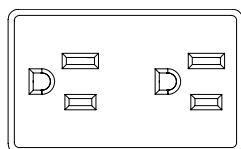

20 Amp

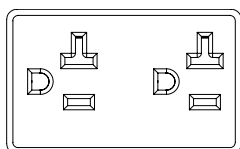

USB

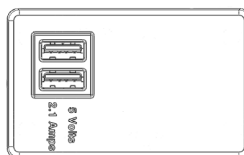

- Outlets are available 15, 20 amp or USB
- The 20 Amp is only available in Black
- USB is always on Circuit 1
- Outlets are available with marking indicating it is connected to a control system in both 15 and 20 amp options.

power distribution basics – panel-mounted workstations

Power is routed through panel walls with harnesses. The options are listed below.

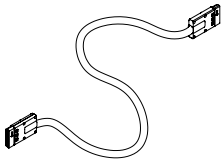
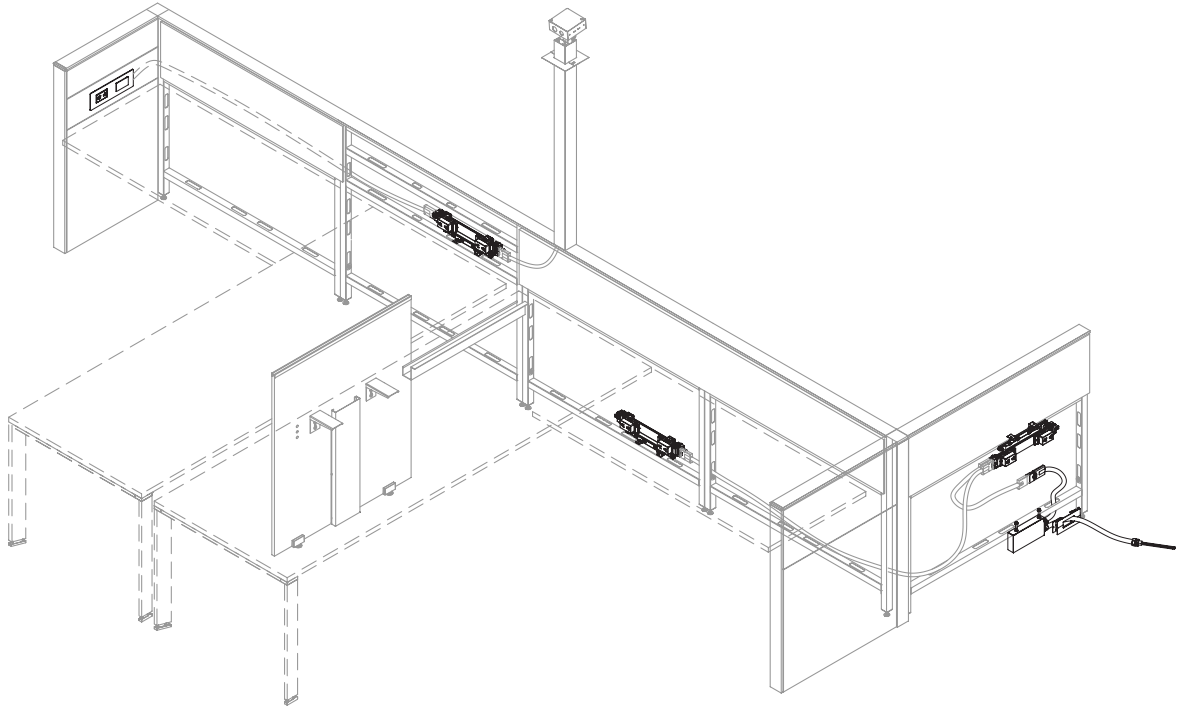

Power Harness (UNQBHR)

- Routes power from one power box to another and is non directional
- Also connects to base feeds and ceiling feeds
- Available in various lengths from 9" to 144" and can be used within any panel
- 9", 12" and 24" conduit is mesh, providing a greater bend radius, and all conduits are oval to be able to pass between panels
- Available in a PVC free option



I-Connector (EWIC)

- Used to join two harnesses when a single harness length is **not** long enough

planning with harnesses

Power boxes allow for non-directional routing, so power can enter and exit from the same end of the power box. Up to four power harnesses can be used on one power box.

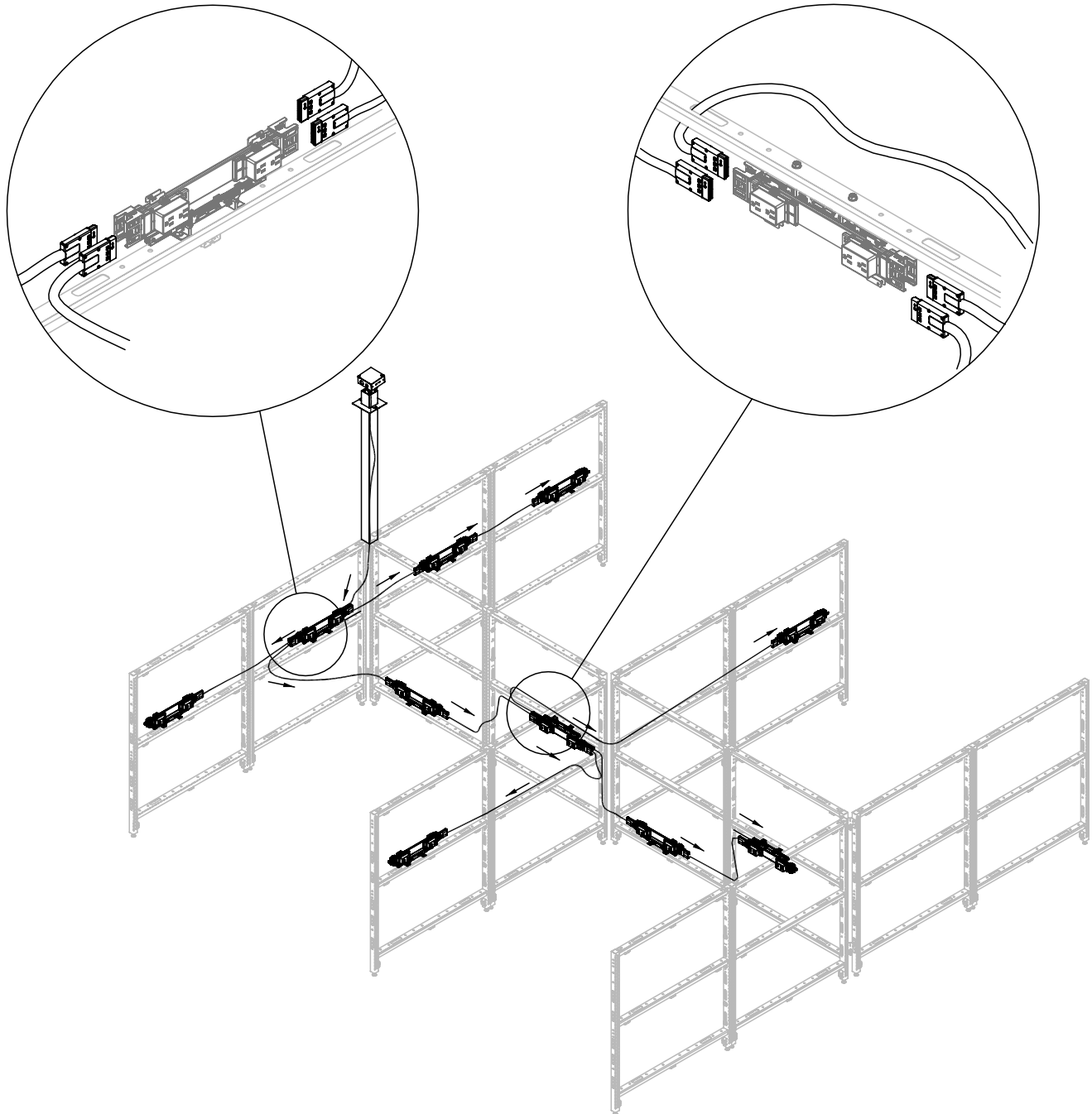

determining harness lengths

The following outlines the harness lengths required for connecting power boxes.

harness length requirements

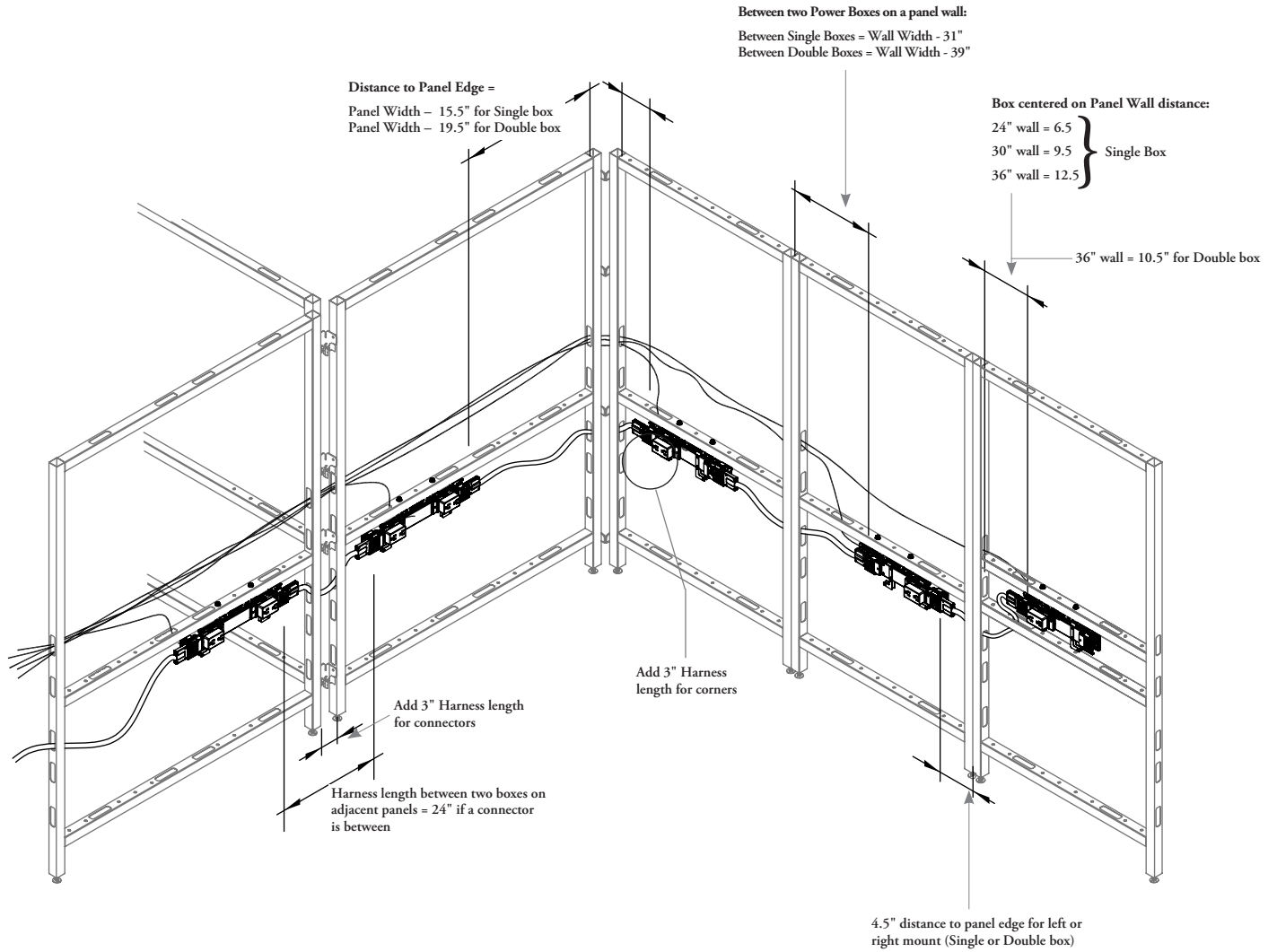

casual electric basics – panel-mounted workstations

District offers options for adding casual power to workspaces, without the use of panels.

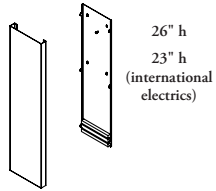
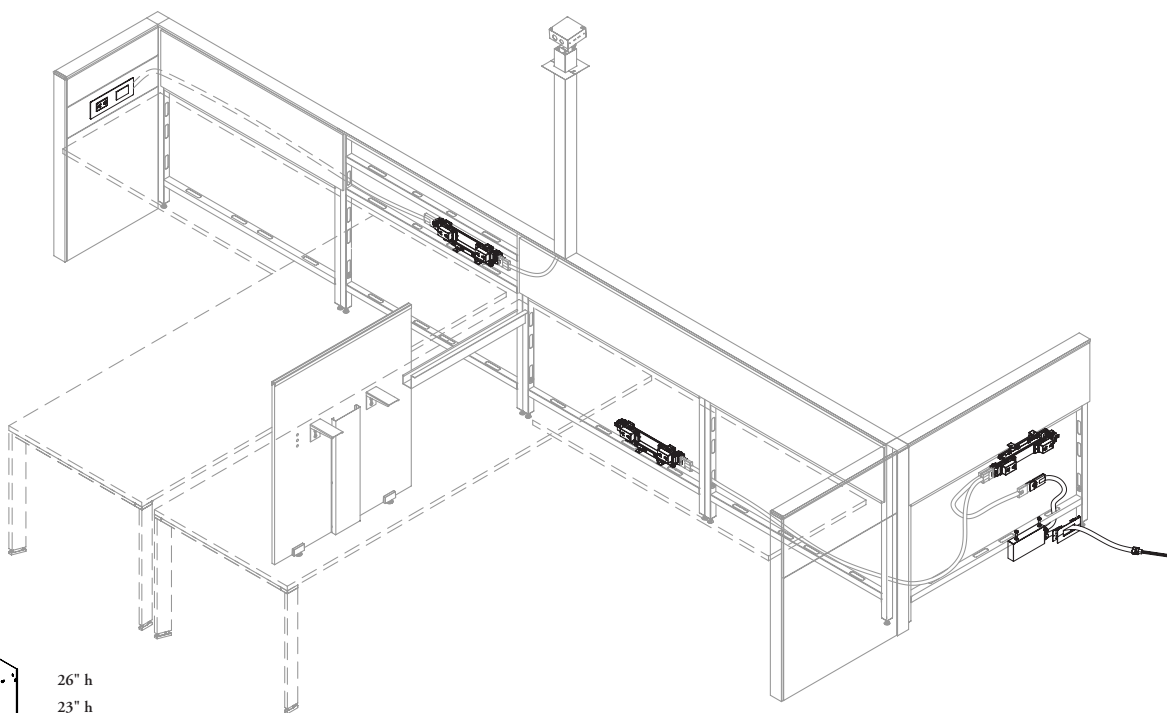

Vertical Cable Manager (UNVC)

- Used to conceal and route cables vertically below the desk
- Mounts to a floor screen or to storage
- Two heights to accommodate North American and International electrics
- The International version allows space to mount an International Outlet Box (VED)

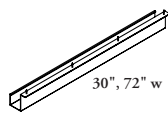

Cable Trough (UNQCT)

- An ABS cable trough is mounted below a worksurface to manage wires coming from the worksurface level on to Panel Wall electrics or floor monuments
- The 30" wide is the optimum size to fit between worksurface brackets

Grommets

- Available as an option for workspaces, credenzas and elevated high credenzas
- Available from Complements: *Teknion's Ergonomics & Accessories Program*

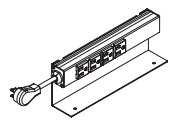

Desk Clamp with Self-Tapping Screws

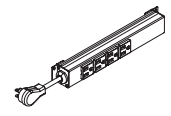

Under-Worksurface Mount

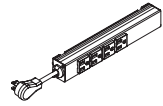

Lyft Base Mount

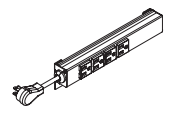

Accessories Element Mount

Power Bar (YEPD)

- Available from Complements: *Teknion's Ergonomics & Accessories Program*
- Attaches to a desk or the underside of a worksurface or to a modesty panel to provide casual power
- Does **not** include data capability

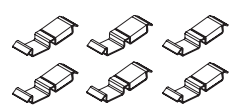

Worksurface Wire Clips (YESW)

- Available from Complements: *Teknion's Ergonomics & Accessories Program*
- Package of six undersurface cable clips that can be installed on the underside of a worksurface
- Provide two separate channels, one to run electrical and another to run communications cables
- The communications channel has a built-on soft sponge to protect the cables

Power can be routed through elevated District storage to provide power to workstations with no panel walls.

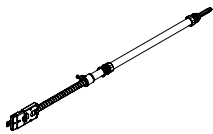
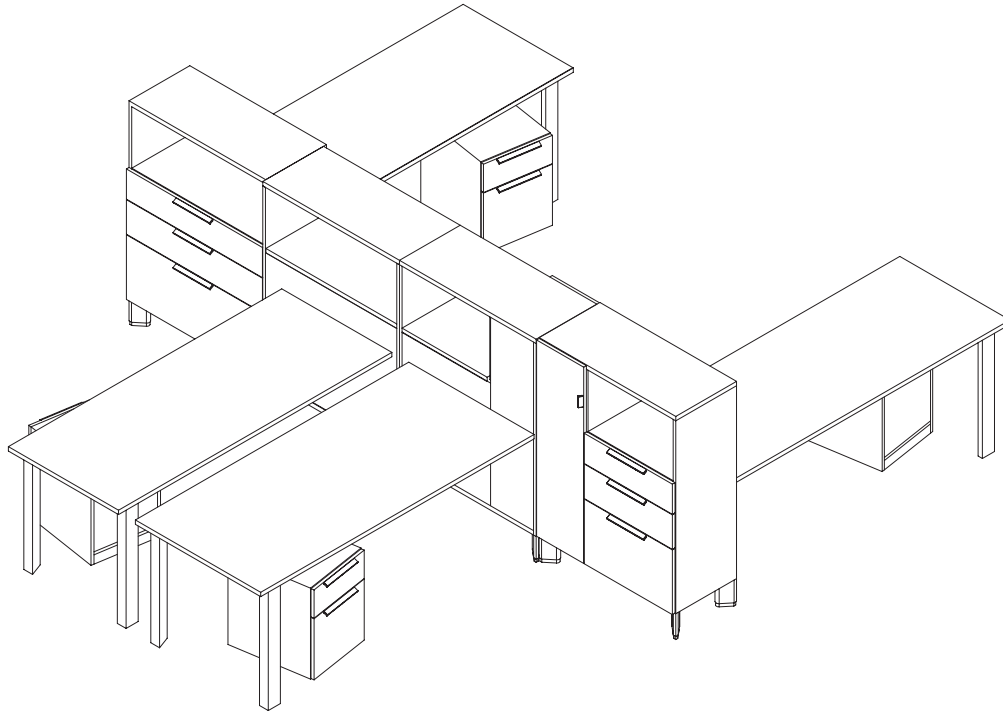

Storage Base Feed (EWBF)

- Provides power from the floor to the underside of the storage cabinet and connects to harnesses
- Available in 72" and 144" lengths in 8T, 7T, 8K and 7K wiring systems

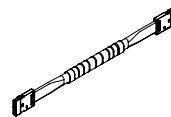

Storage Power Harness (EWBH)

- Carries power along the base of the cabinet to power and data box in the storage unit
- Available in lengths of 24", 48", 72", 120" and 144"
- 24" length is mesh, other sizes are a hybrid of mesh and metal conduit



Storage Chicago Base Feed (EWBFCH)

- Same as the Base Feed (EWBF) except for Chicago electrics application
- Only the conduit is provided
- All wiring and connections must be supplied and connected by a certified electrician



I-Connector (EWIC)

- Used to join two harnesses when a single harness length is **not** long enough

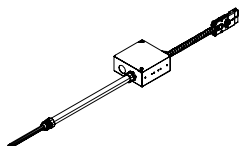

Storage Split Base Feed (EWBFS)

- Same as the Base Feed (EWBF) except it is hard wired to the building power supply in two places in New York wiring restrictions

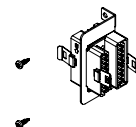

Four-Way Splitter (EWDB)

- Attaches to a harness to split power in four different directions

storage electrics basics (continued)

Power can be brought into the storage unit from the floor via a Base Feed or from the ceiling via a Power Pole Ceiling Feed. Build in feeds always route power and data to the underside of the elevated storage.

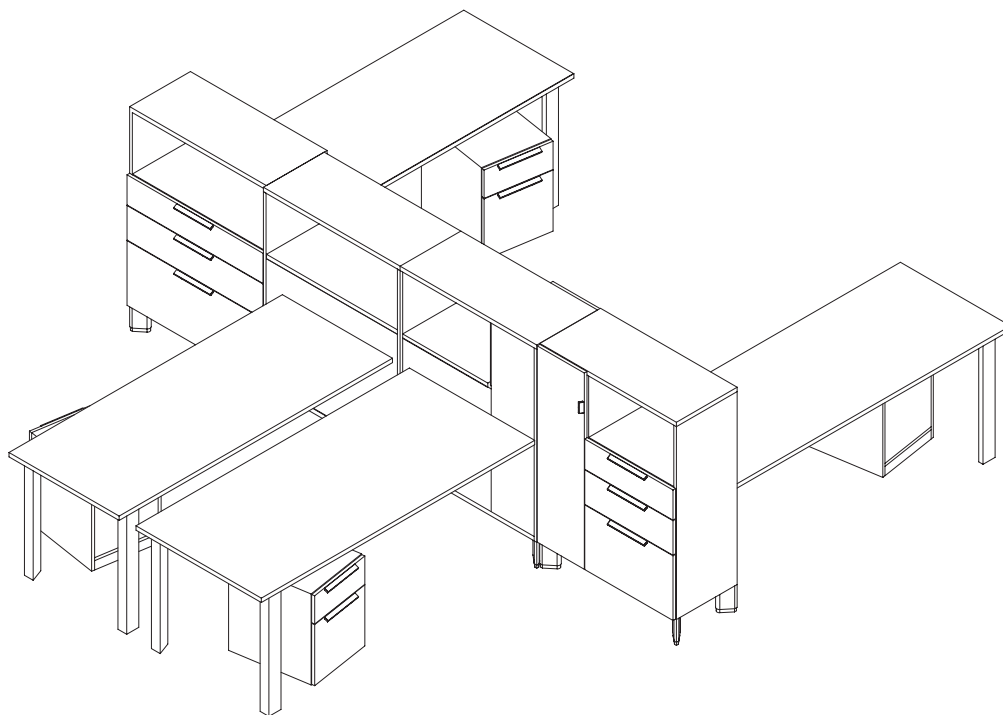

Storage Ceiling Feed (EWCF)

- Routes power to the underside of the storage cabinet from the ceiling through the storage power pole
- Can be directly connected to the Flush Mounted Power and Data (EWQP) unit once I-connector is removed

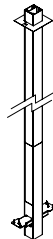

Storage Power Pole (EWEP)

- The Storage Power Pole (EWEP) can route power and data to two storage units.
- Houses the Storage Ceiling Feed and divides the ceiling feed from communication and data cables
- It is used to feed power and data to the underside of the storage units

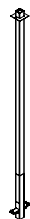

Storage Chicago Ceiling Feed (EWCFCF)

- Same as Storage Ceiling Feed (EWCF) except for Chicago electrics application
- The Storage Chicago Ceiling Feed (EWCFCF) comes with a 3-wire. No connector is found on the bottom end due to Chicago electrics wiring restrictions
- Chicago electrics wiring restrictions require that all wiring and connections be supplied and connected by a licensed electrician

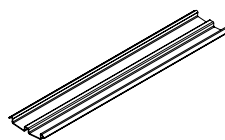

Under Cabinet Wire Tray (EWWT)

- A tray for managing wires below the storage cabinet
- Available in lengths of 12", 24", 36", 48", 60", 72" and 84"
- Tray **cannot** span across two storage units. Specify at least 12" less than the width of the cabinet onto which it is being mounted

storage electrics basics (continued)

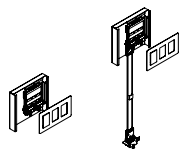
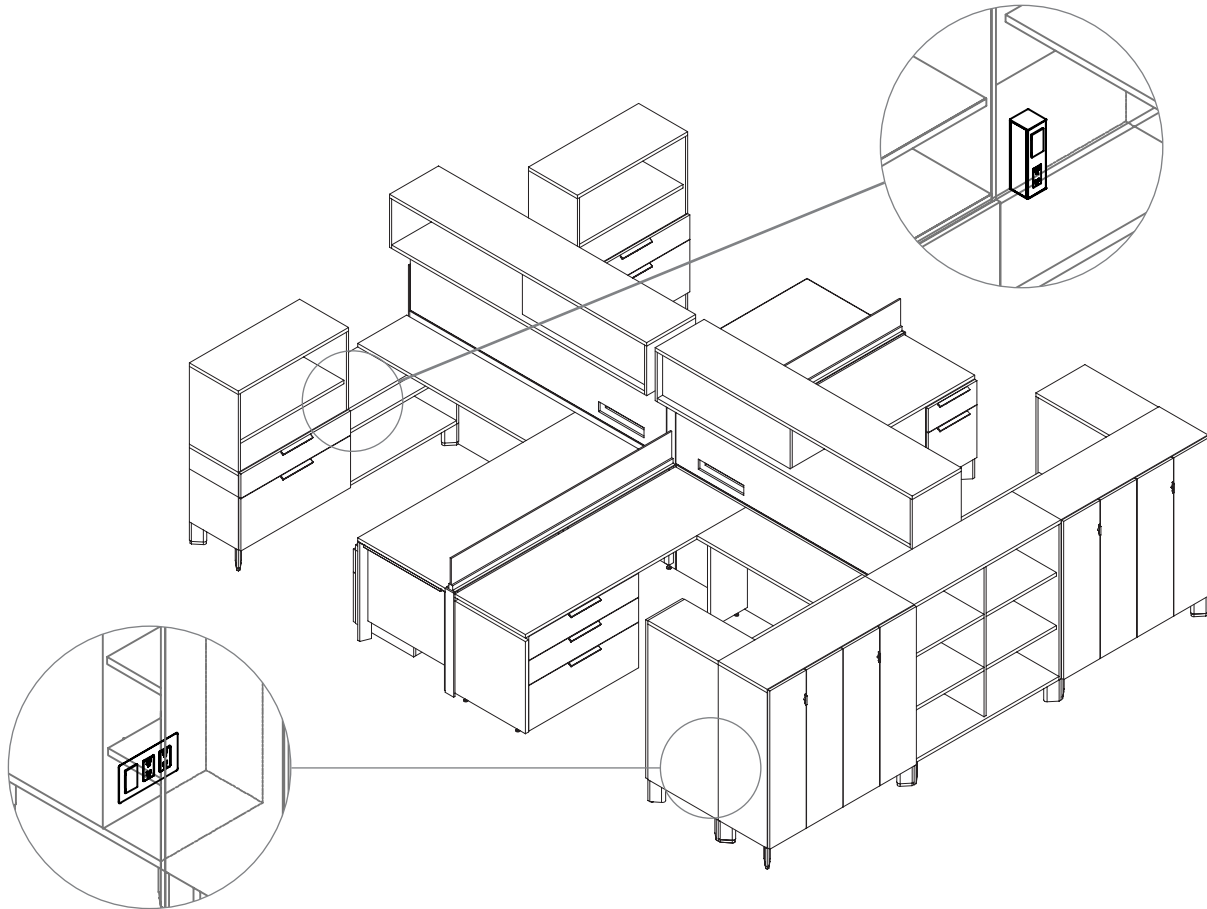

Flush Mount Power & Data (EWQP)

- A module for mounting receptacles (specified separately) to storage
- Mounts to the back of a storage cabinet at either base height or belt-line height
- Each unit supplies power and data access to user on opposite (backside) of cabinet



Chicago Flush-Mounted Power Box (EWQPCH)

- Same as Flush Mount Power and Data (EWQP) except for Chicago electrics application
- Data and communications must be sourced separately
- Chicago electrics wiring restrictions require that all wiring and connections be supplied and connected by a licensed electrician



Storage Receptacles Outlet (EWRO)

- A single duplex receptacle that mounts into the Flush Mount Power and Data (EWQP) unit to provide power
- Specified individually for maximum circuit flexibility
- Styles include Standard 15 amp, T-Slot 20 amp, USB, Controlled 15 and 20 amp
- Outlet configurations consist of Circuit 1, Circuit 2, Circuit 3 (use 8T only), Circuit 5 (8T and 8K only), Circuit 6 (use 8K only), Circuit A (7T and 7K only), Circuit B (7K only) and USB

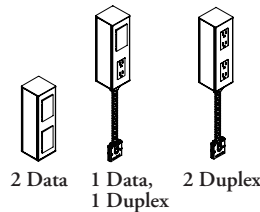

Cubby Power Monument (EWQPM)

- Provides access to power and data in open cubby sections of credenzas or the back cubby sections of pedestals and pedestal towers
- Cubby Power Monument must plug directly into a Four-Way Splitter (EWDB) or an I-Connector (EWIC). It plugs directly into a Storage Power Harness (EWBH).
- T-Slot 20 amp receptacle style is finished in Ebony

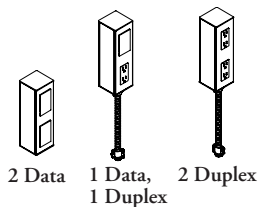

Chicago Cubby Power Monument (EWQPMCH)

- Same as Cubby Power Monument (EWQPM) except for Chicago electrics application
- T-Slot 20 amp receptacle style is finished in Ebony

planning with storage

The following should be taken into consideration when planning with spine storage electrics.

electrical capability

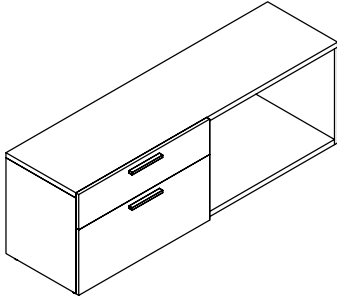

Standard, No Feet

- Standard storage has no electrics or cable management capabilities

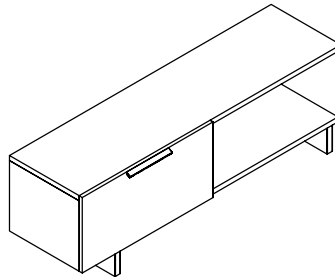

Elevated, District Feet

- Elevated storage with District feet has no electrics or cable management capabilities

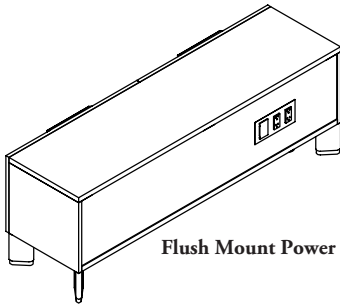

Flush Mount Power and Data (EWQP)

Elevated, Angled Feet

- Angled feet allow for a full electrified system by providing undersurface wire troughs and harnesses for routing power to Flush-Mounted Power and Data Boxes or the Cubby Power Monument
- Also grommets may be specified in the open cubby section for light cable management

planning with storage (continued)

power locations

credenzas

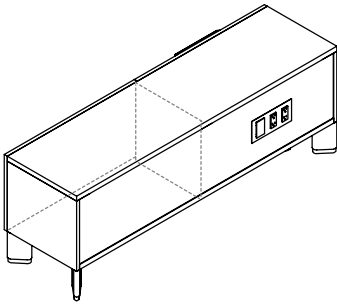

- Flush-Mounted Power and Data modules are always at base height, located behind the drawer when added to credenzas
- Base cut out must be specified when ordering the credenza

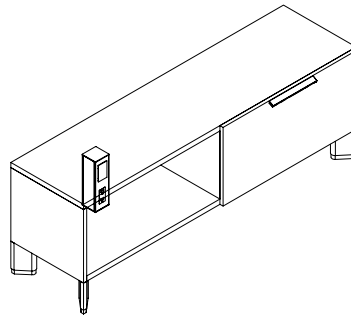

- **Cubby Power Monument (EWQPM)** can be located in the open cubby section of a credenza. It will fit into the grommet hole, therefore grommet must be selected when specifying the storage unit

towers and lockers

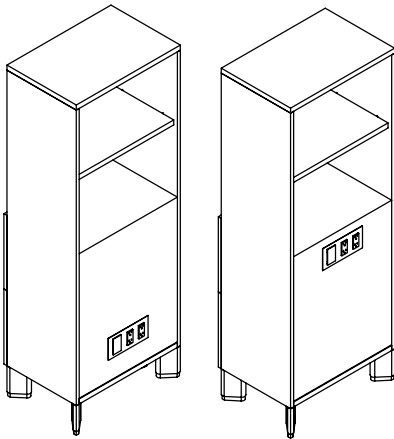

- For Lateral File, Lateral Tower or Combo Tower application, Flush Mounted Power and Data modules can be mounted at base or belt-line height
- Base or Belt-line back cut out must be specified when ordering the storage unit

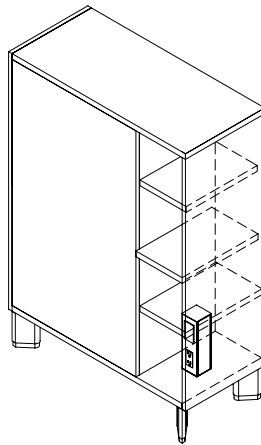

Cubby Power Monument can be mounted in grommet hole.

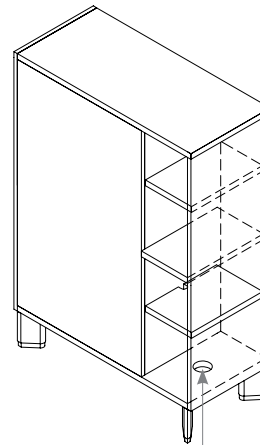

Flush-Mounted Power and Data unit can be mounted into base or belt back cut outs.

- For Single Lockers, Pedestal Towers or Pedestals with Cubby back, several options are available. Grommets can be used for casual power, or Flush-Mounted Power and Data units or Cubby Power Monuments may be used for multi-circuit power and data application

planning with storage (continued)

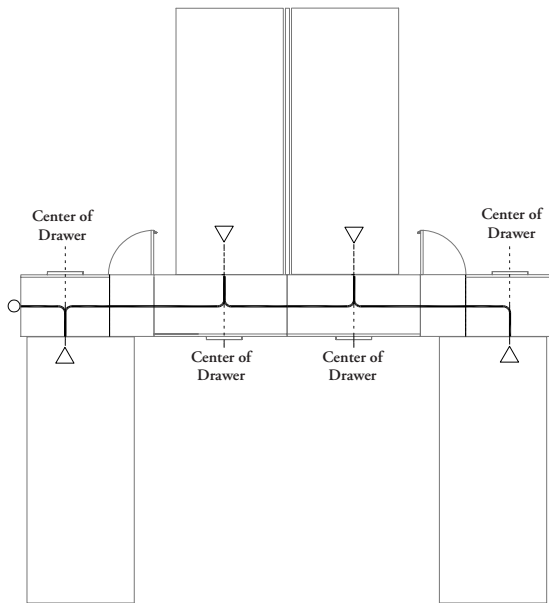

- Power does **not** have to be on one side only of a storage run – storage can be alternated to allow for maximum planning flexibility
- Flush-Mounted Power and Data (EWQP) module unit is always centered on the back of the drawer section of the unit
- To specify the correct lengths of power harness, determine the distance from the center of one cut out to the center of the next cut out, then add 24"
- Power outlets will be centered behind the filing section of a combo tower

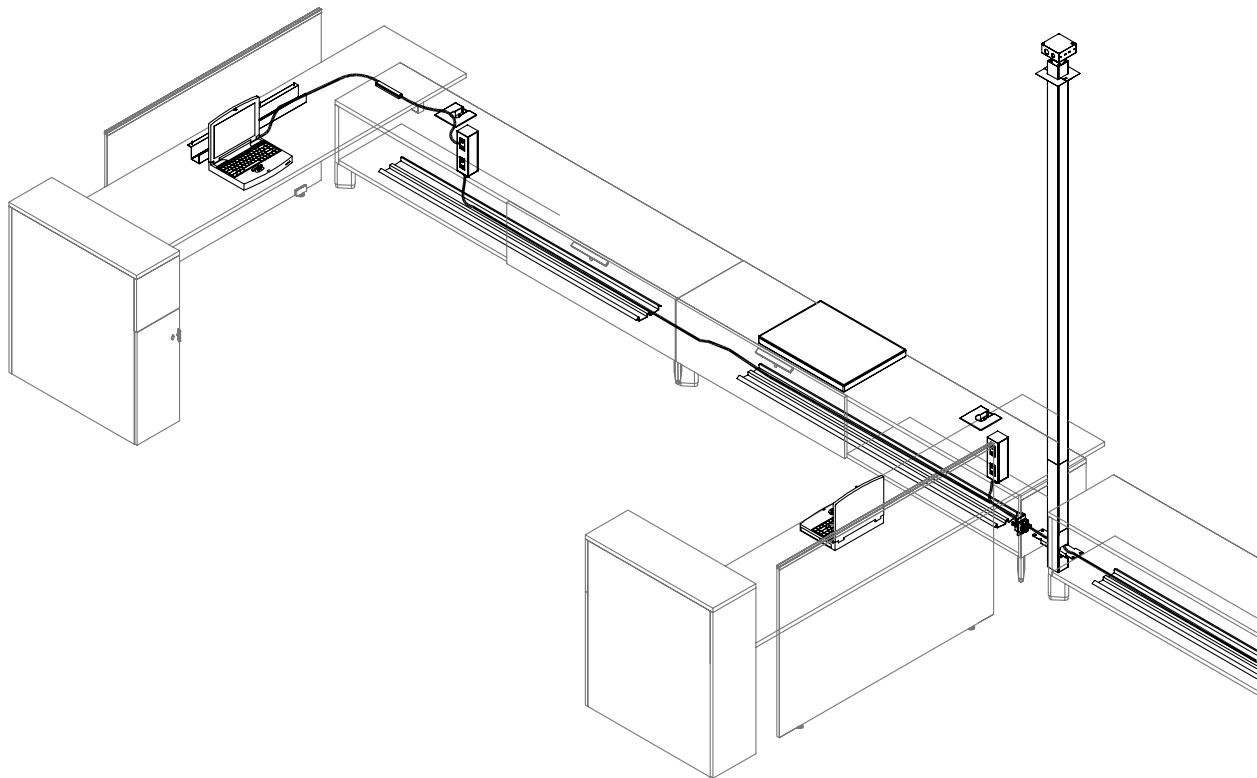

- When planning with a low storage unit in a freestanding environment, Cubby Power Monuments can be mounted into credenzas to provide multi-circuit power and data to the workstation
- Power can be routed from the building to the storage unit through Base or Ceiling Feeds then horizontally routed under the storage units along Under Cabinet Wire Trays
- Cubby Power Monuments must plug directly into a Four-Way Splitter (EWDB) or an I-Connector (EWIC). It **cannot** plug directly into a Storage Power Harness (EWBH).
- Power Poles can feed two storage units

power conservation system basics

Furniture based solution for the controlling function that addresses the ASHRAE/Title 24 electrical requirements.

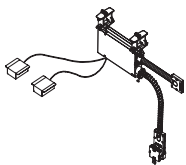
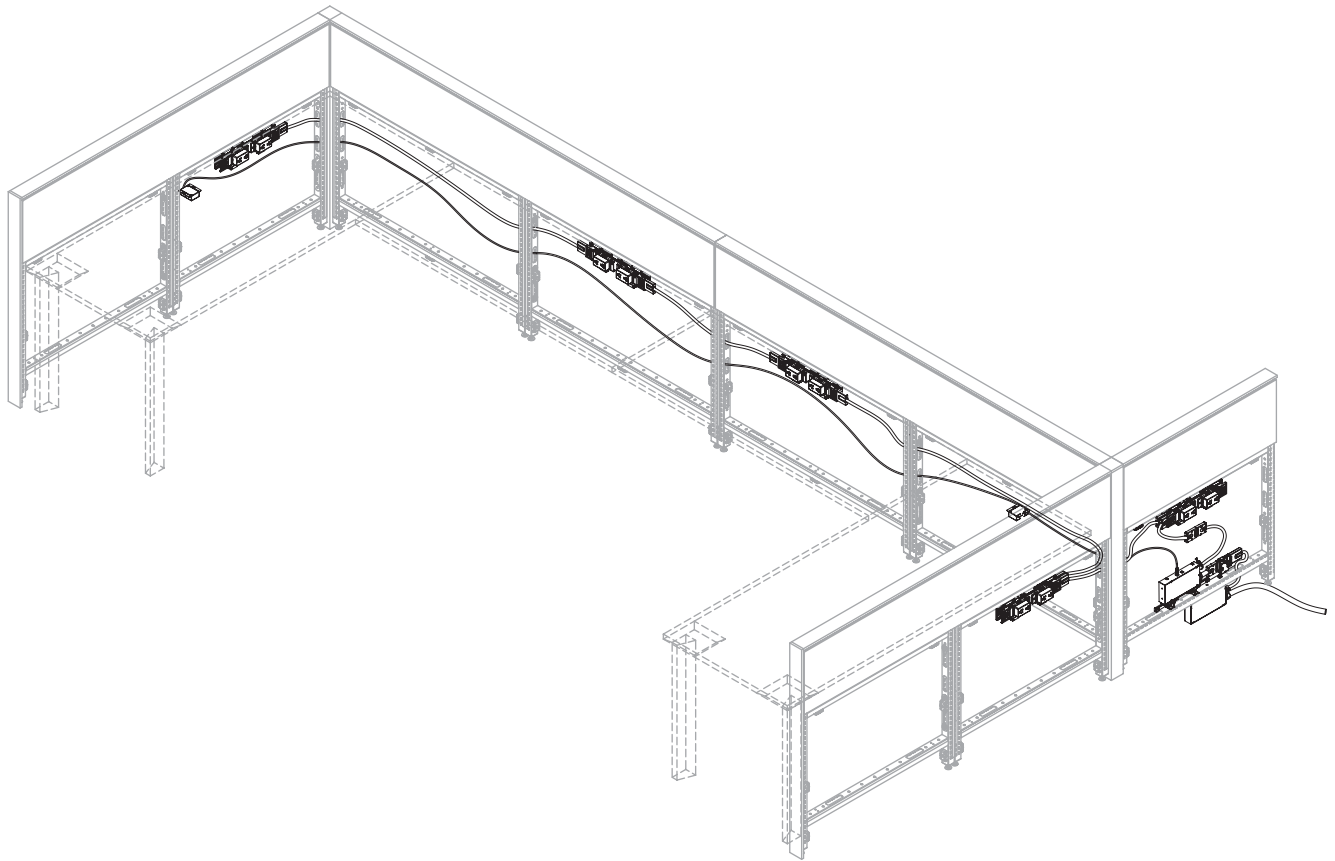

Power Conservation System (UNQPC)

- Up to two circuits can be controlled by occupancy sensors (included)
- Maximum of 4 sensors can be connected to each individual controlled circuit
- When using the Power Conservation System, circuits 3, 5, 6, A and B will always stay powered on (uncontrolled)
- To get individually controlled stations, specify the Power Conservation System with 2 sensors
- Available with option of 2, 4 or 8 sensors (Maximum of 4 sensors per run)
- Sensors mount to the underside of the work surface
- A hard wired connection supplies power into a panel from the building power source

planning with power conservation system

The following should be considered when planning with the Power Conservation System.

The following are two ways of planning with the Power Conservation System.

scenario A: Multiple sensor planning

The connection between two power modules only applies on the installation for 4 sensors and 8 sensors.

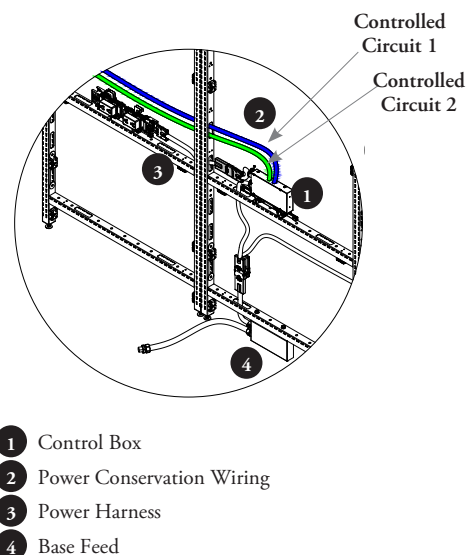
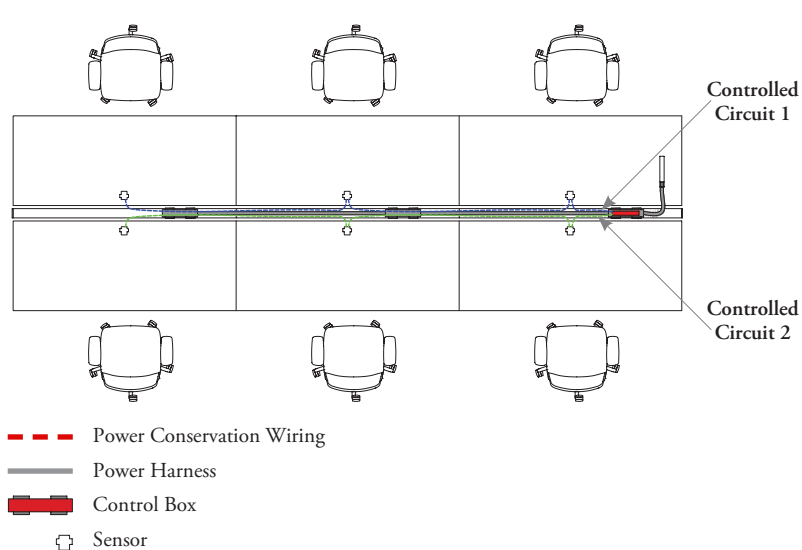

scenario B: Single Sensor planning

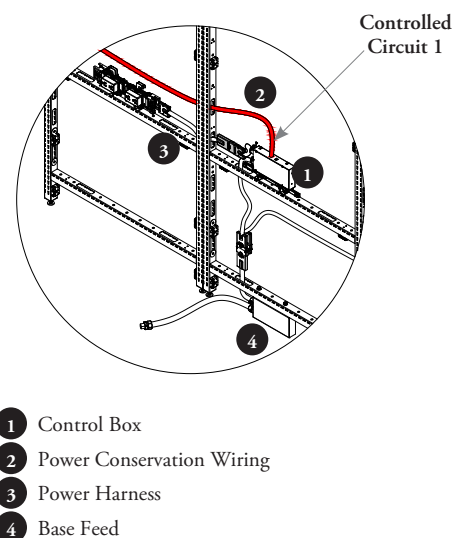
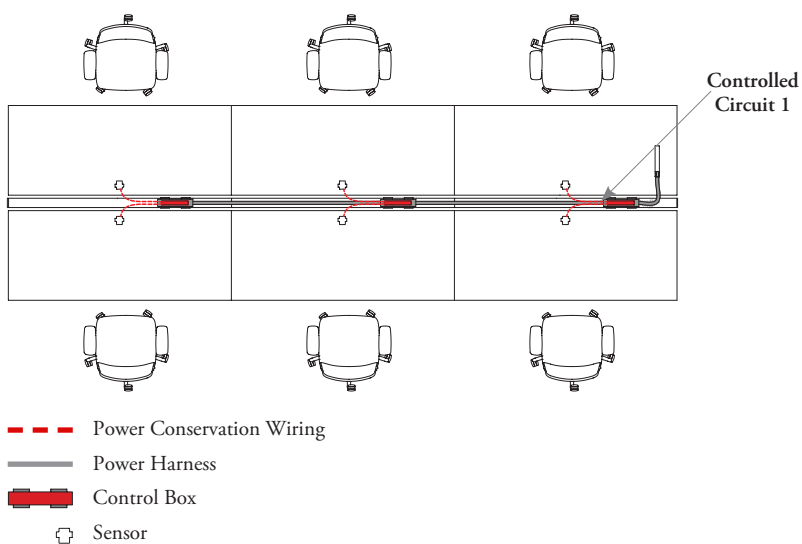

- Always specify one sensor per workstation
- Only one controlled circuit per workstation (do not specify two controlled circuits in one single workstation)
- Do not specify mix receptacles for both circuit 1 and 2 in a single workstation
- If the control box and power module are in the same panel, the output arm from the control box can directly connect to the power module, no extra jumper required

international electricians

international electrics

INTERNATIONAL ELECTRICS BASICS 353

PLANNING WITH INTERNATIONAL ELECTRICS 357

international electrics basics

District is available with electrical components specific to District, including CALA electrics.

- International Electrics are a single circuit, 3 wire directional system
- Power outlet types are available for different regions and have options for fuses and switches

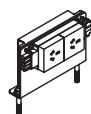
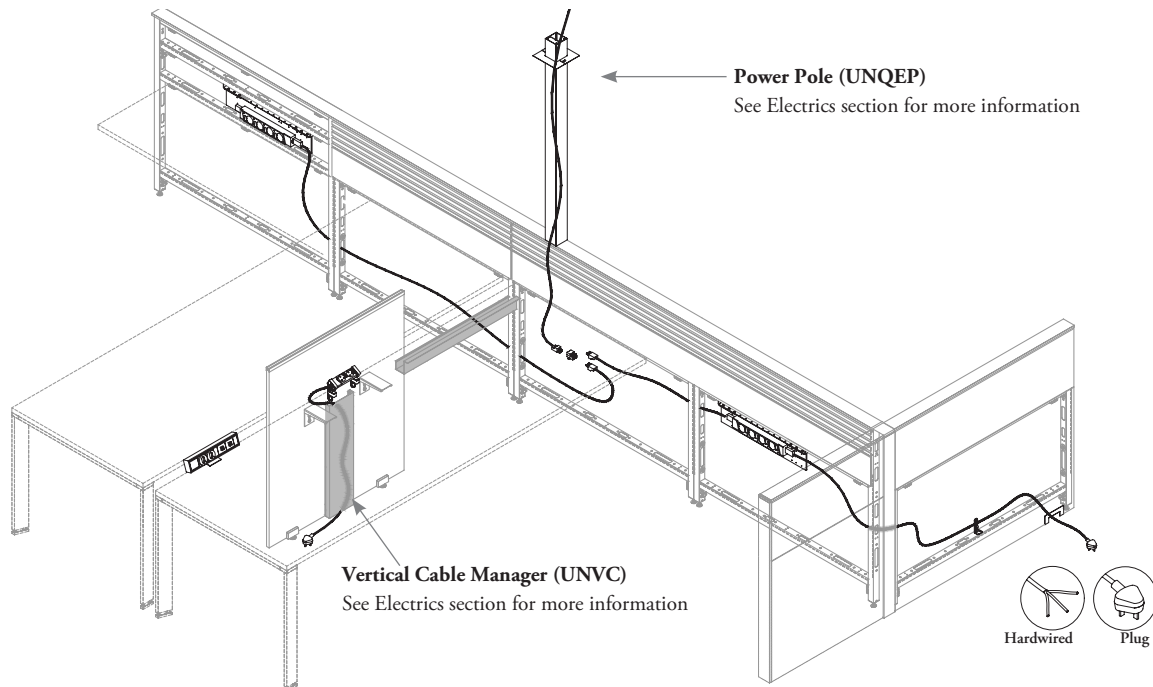

CALA Power Module (VBCD)

Provides access to power in CALA applications

-Includes the attachment bracket

Applications:

- DA Double Duplex, One Sided
- DB Double Duplex, Back to Back
- SA Single Duplex, One Sided
- SB Single Duplex, Back to Back

Outlet Configurations

- Single Duplex
 - 003 Three Data
 - 200 Two Power
 - 120 One Power and One USB
- Double Duplex
 - 203 Two Power and Three Data
 - 400 Four Power
 - 320 Three Power and One USB

Country of Installation:

- R Argentina
- N Brazil
- L Chile

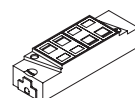

Four Shutters

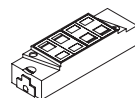

Four Blank Fascias

Voice & Data Box (VVD) and Voice & Data Box Outlets (VDO)

- The voice data box provides the user with access to communications and data cable
- Comes complete with blanks and shutters
- The data box outlets are inserted into the voice and data box
- Mounts to a Power Mounting Bracket (UNXB)

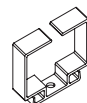
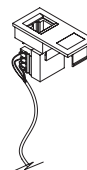

Screen Mounted Outlet Box Bracket (UNXSE)

- Used to casually mount an outlet box to a screen, a modesty panel, storage or underside of worksurface
- Used in combination with an Input Power Cable (VEP)



District CALA Jumper Power Harness (VBPH)

Routes power between CALA power modules

Length

200 mm

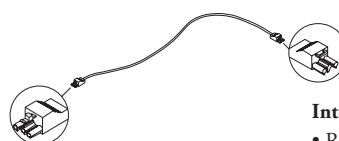

Interconnecting Power Cable (VCC)

- Routes power between outlet boxes or distribution block in panel and carries to next panel wall

international electrics basics (continued)

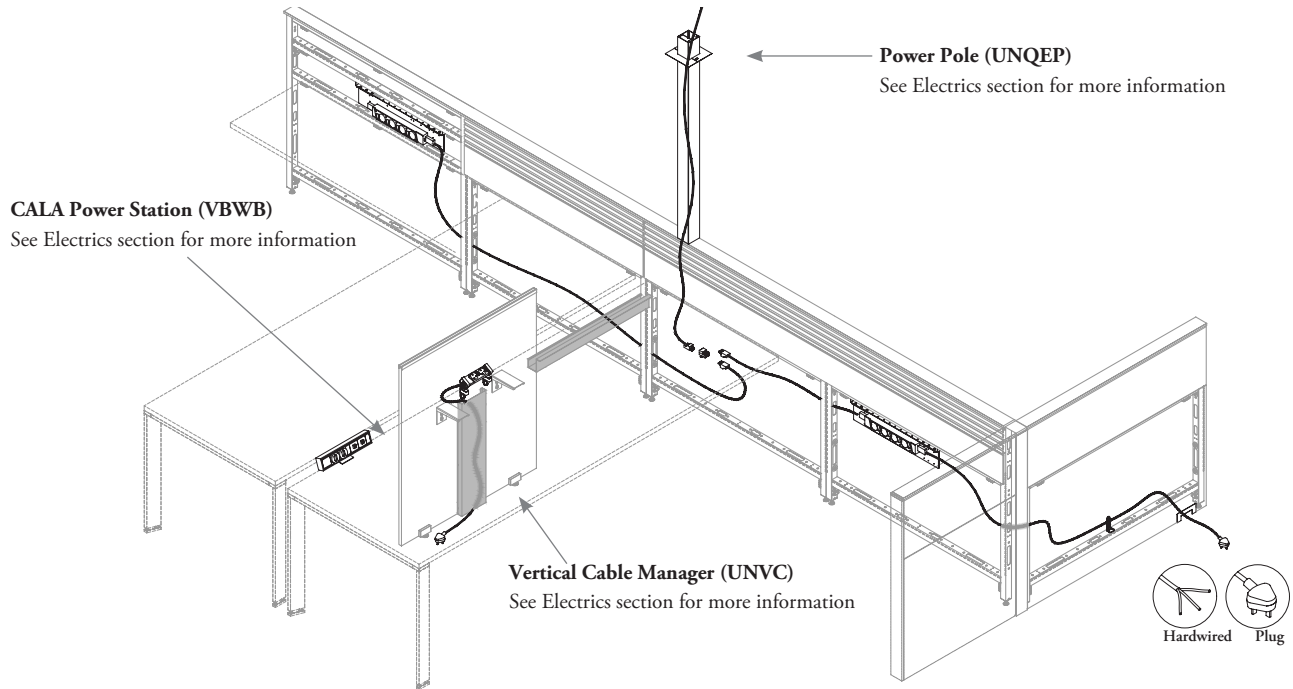

CALA Power Station (VBWB)
See Electrics section for more information

Power Pole (UNQEP)
See Electrics section for more information

Vertical Cable Manager (UNVC)
See Electrics section for more information

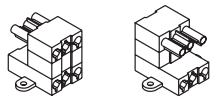
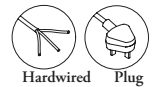

Distribution Block



Cover Cap

Distribution Block (VACEB) and Cover Cap (VACEC)

- The distribution box redirects power distribution in up to three directions
- Complete with one male connector (in) and three female connectors (out)
- Is placed inside panel wall without fasteners
- The Cover Cap is a safety cover for non utilized female terminals on an Outlet Box (VED) or Distribution Block (VACEB)

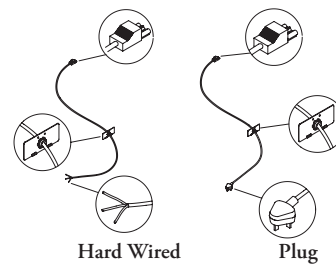

Hard Wired

Plug

Input Power Cable (VEP)

- Brings power from the building or ceiling to either a panel wall where it is routed to an outlet box or to a desk where it is routed through wire managers to casually mounted power
- Available with 2 cable ends, hardwire or plug

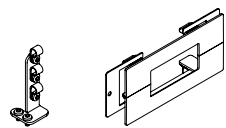

Base Feed Mounting Kit (UNXPFR)

- Includes a strain relief bracket and a cover plate that is attached to the panel and conceals the opening where an Input Power Cable (VEP) or voice/data enters the panel wall

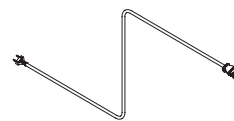

CALA Power In Feed (VBPD)

- Routes power from the building or ceiling in CALA applications

Length:
1800 mm

Country of Installation:
R Argentina
N Brazil
L Chile

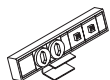

CALA Power Station (VBWB)

Mounts to a worksurface to provide power

Outlet Configurations:

- Double duplex
- (202) Two Power and Two Data
- (400) Four Power
- (320) Three Power and One USB

Country of Installation:

- R Argentina
- N Brazil
- L Chile

Cord Length:
1800 mm

Finishes

Receptacle Finish:
Ebony Coordinate
Very White Coordinate

Clamp Finish:
Clear Anodized Aluminum

international electrics basics (continued)

District utilizes standard International Electric components, as well as District specific components

- International Electrics are a single circuit, 3 wire directional system
- Power outlet types are available for different regions and have options for fuses and switches

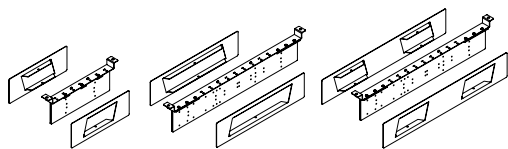
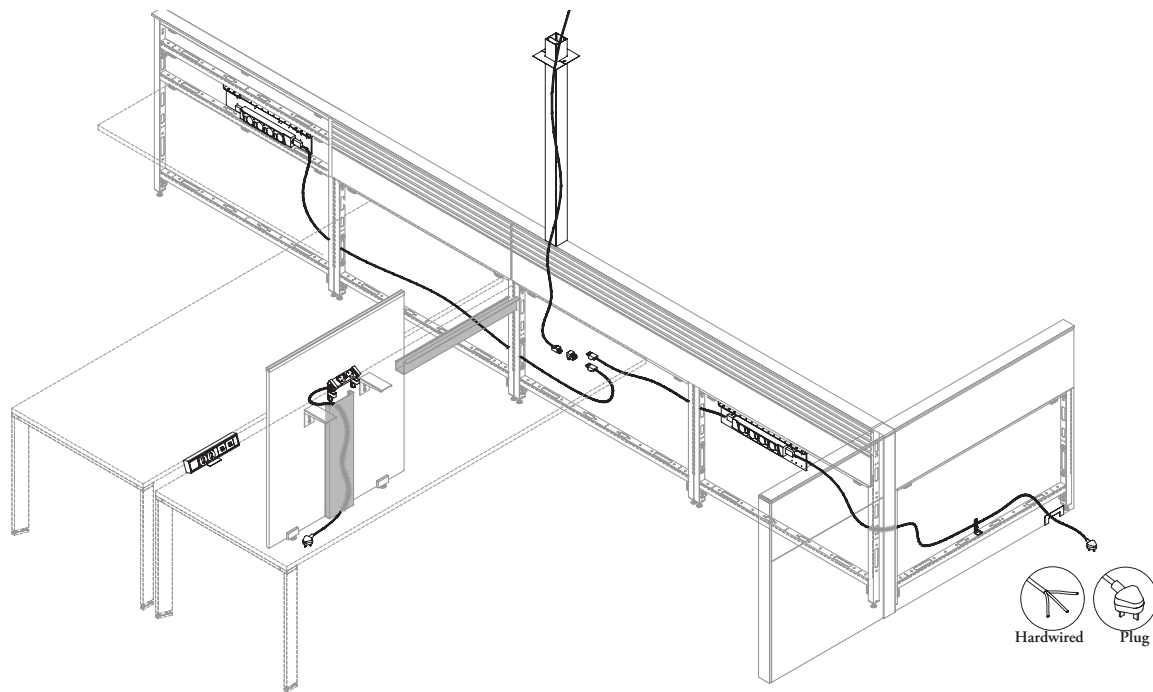

Panel Mount Outlet Box Bracket (UNXBR)

- Used to attach an Outlet Box (VED) and Voice & Data Box (VVD) to a panel wall
- Available in above and below worksurface versions
- Available for two outlets, for four outlets or for two outlets and a data box
- The same bracket allows for single or double-sided mounting of outlet brackets (specify fascias accordingly)
- Compatible with a standard or elevated panel
- A 1" gap along the worksurface and grommets permit component wire passage to outlets below the worksurface

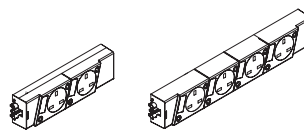

Two Outlets Four Outlets

Outlet Box (VED)

- Provides access to power above and below worksurface
- Can be mounted onto a panel with a Power Mounting Bracket (UNXB) or to the edge of a worksurface, see Desk Mounting Clips (VACB6)
- Power outlets have a socket angle of 15°
- Panel mounted access is below worksurface height at 25", flush with the panel wall face
- Faceplates are included with outlets and voice/data boxes
- The bottom of the faceplate aligns with the top of a low credenza
- Outlets are available; 2 x power, 4 x data or 4 x power

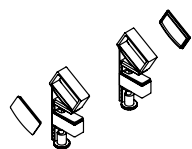

Desk-Mounted Clips for Outlet Box

Desk Mounting Clips (VACB6)







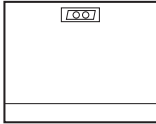
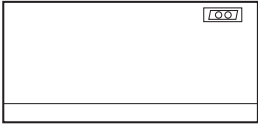
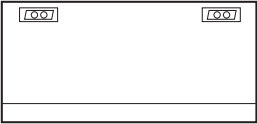

- Used to attach an Outlet Box (VED) or Voice & Data Box (VVD) to the edge of a worksurface
- Fits all sizes of Outlet Boxes (VED) or Voice & Data Boxes (VVD)

planning with international electrics

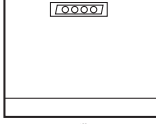
International power and data has some unique features that are not found in North American electrics. The examples below demonstrate this.

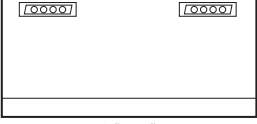
panel wall

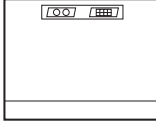
- Outlet locations are located in panel wall centers or at panel edges according to size and fascia specifications

Outlet type:	Outlet location:		
	Center	Left or Right Side	Left and Right Side
 2 x Power	 24" - 36"	 42" - 96"	 66" - 96"
 4 x Power	 36"	 42" - 96"	 66" - 96"
 2 x Power + 4x Data/Com	 36"	 42" - 96"	 66" - 96"

mounting to floor screens

- When outlets are mounted to floor screens, they are below worksurface height
- Should be installed 2" below the surface, centered on the floor screen width where possible and **not** wider than a 4 x power outlet box
- They are attached with the Screen Mount Outlet Box Brackets (UNXSE) or with screws

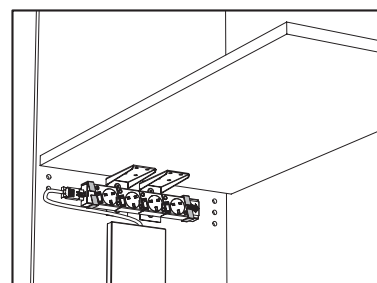
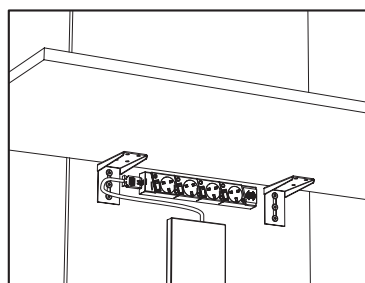
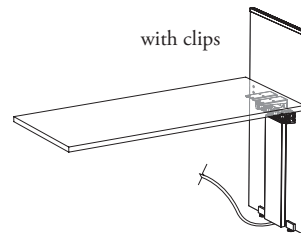
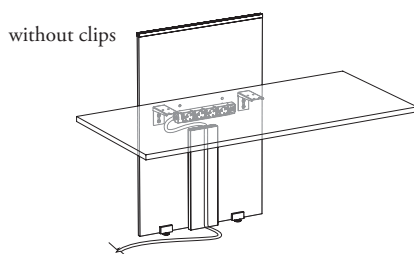

planning with international electricians (continued)

International power and data has some unique features that are not found in North American electricians. The examples below demonstrate this.

base feed

- The Input Power Cable (VEP) enters and is secured to a Base Feed Bracket (UNXPF) fastened to the panel wall rail (either standard or elevated)
- On flush panel walls entry is through a cut out to the fascia made on site and finished with the supplied cover plate
- On elevated panel walls the cable enters through an opening in the bottom of the panel wall frame
- Accepts one circuit per cable

Flush Panel Wall

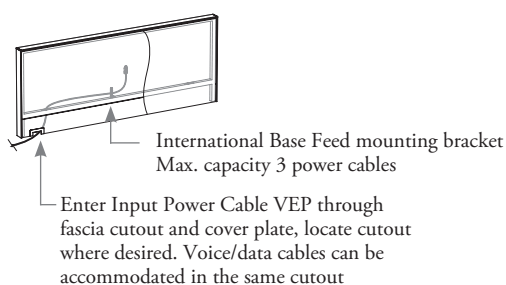

Elevated Panel Wall

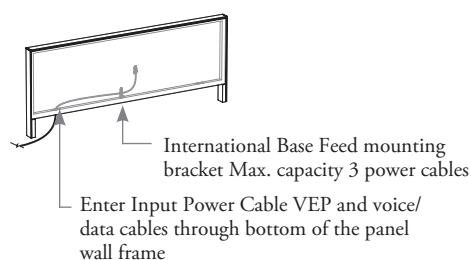

ceiling feed

- Is available hard wired or with a plug for building connection
- The other end is a female connection
- Compatible with the Off-Module Power Pole and End of Run Power Pole (See Electricians section for more details)

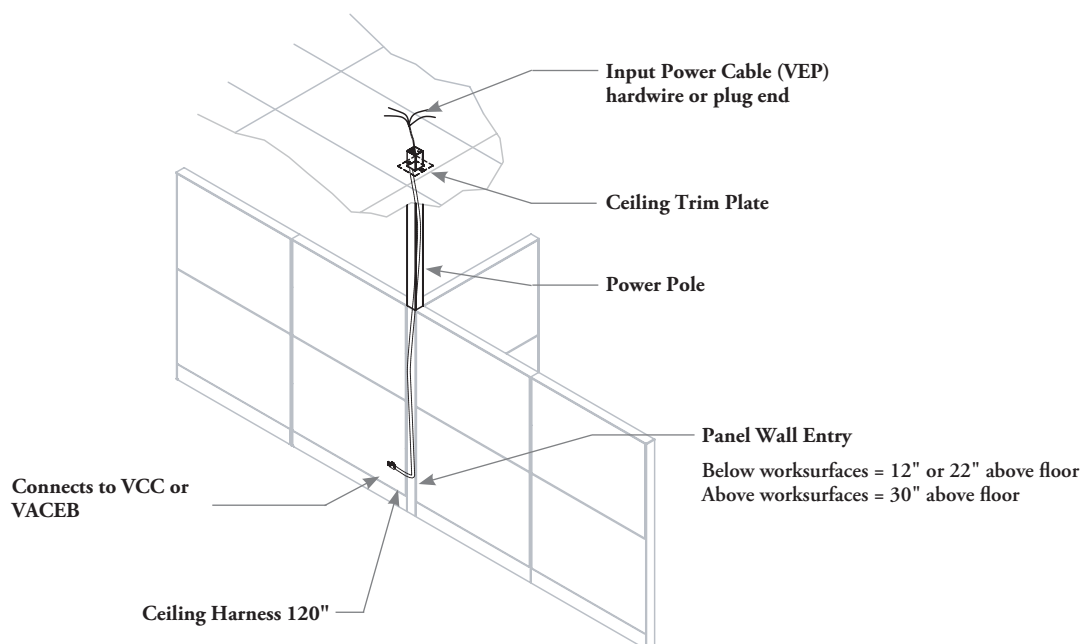

price & product guide

price & product guide

PANEL WALLS	362
FASCIAS	385
POWER SPINE	487
SCREENS	541
CONNECTIONS & TRIMS	631
WORKSURFACES	655
HEIGHT-ADJUSTABILITY	663
STORAGE	703
SUPPORTS	809
ACCESSORIES	839
ELECTRICS	875
INTERNATIONAL ELECTRICS	911

panel walls product map

UNPFR Flush Panel Wall

Page 364

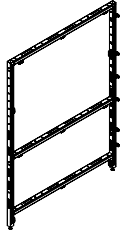

UYPFR Flush Panel Wall with Inset Glass

Page 365

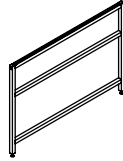

UNPER Elevated Panel Wall

Page 366

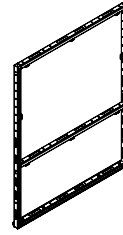

UYPER Elevated Panel Wall

Page 367

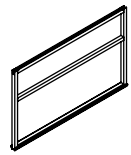

UNPC Convertible Panel Wall

Page 368

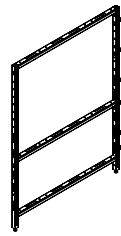

UYPCR Convertible Panel Wall with Inset Glass

Page 369

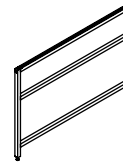

UNPWSR Add-On Window (D-Style) – Single Glass

Page 370

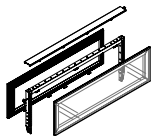

UNPWDR Add-On Window (D-Style) – Double Glass

Page 372

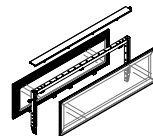

UNPFWSR Flush Full-Height Window (D-Style) – Single Glass

Page 374

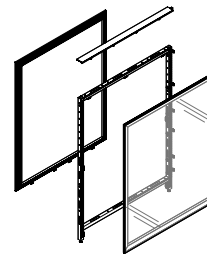

UNPFWDR Flush Full-Height Window (D-Style) – Double Glass

Page 375

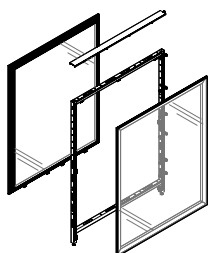

UNPEWSR Elevated Full-Height Window (D-Style) – Single Glass

Page 376

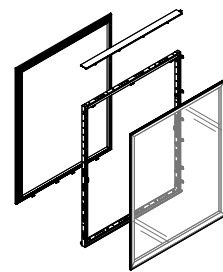

UNPEWDR Elevated Full-Height Window (D-Style) – Double Glass

Page 377

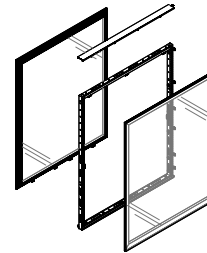

panel walls product map

**UNPCF Convertible Panel Wall
Base and Foot Trim**

Page 378



UNPEFR Elevated Panel Wall Foot

Page 379



**UAFFN Support Foot
for Freestanding District**

Page 380

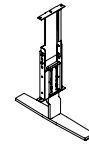

UNPHN Panel Wall Rail

Page 381

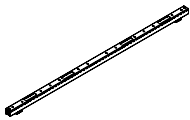

UNEX Light Block Rail

Page 382

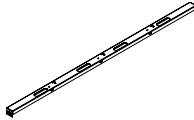

panel walls

UNPFR

Flush Panel Wall

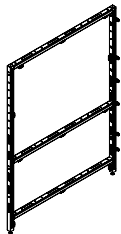

The Flush Panel Wall is flush to the floor when finished.

WHAT'S INCLUDED

1 frame (widths 24"-60") or 2 frames (widths over 60"), hardware for straight connections, levelers.

WHAT'S EXCLUDED

Fascia applied to base must be specified separately.

NOTES

Top trim is optional (not needed when window is applied to top of panel or requires unique trim when center mount storage is specified).

Panel wall frame has a Black finish.

PRODUCT OPTIONS

Height	Width (6" increments)	Fascia & Top Trim
29, 42, 51, 66	24 - 96	To order finished panel walls, a Panel Matrix is available to identify placement of specific fascias and top trim.

SAMPLE ORDER CODE

UNPFR 51	60	PANEL MATRIX
----------	----	--------------

DIMENSIONS INCHES / MM

H	W
29 / 737	24 / 610
29 / 737	30 / 762
29 / 737	36 / 914
29 / 737	42 / 1067
29 / 737	48 / 1219
29 / 737	54 / 1372
29 / 737	60 / 1524
29 / 737	66 / 1676
29 / 737	72 / 1829
29 / 737	78 / 1981
29 / 737	84 / 2134
29 / 737	90 / 2286
29 / 737	96 / 2438
42 / 1067	24 / 610
42 / 1067	30 / 762
42 / 1067	36 / 914
42 / 1067	42 / 1067
42 / 1067	48 / 1219
42 / 1067	54 / 1372
42 / 1067	60 / 1524
42 / 1067	66 / 1676
42 / 1067	72 / 1829
42 / 1067	78 / 1981
42 / 1067	84 / 2134
42 / 1067	90 / 2286
42 / 1067	96 / 2438

PRICING

189
202
212
227
237
251
258
391
406
424
433
443
453
238
255
271
284
304
324
333
499
517
534
552
569
585

DIMENSIONS INCHES / MM

H	W
51 / 1295	24 / 610
51 / 1295	30 / 762
51 / 1295	36 / 914
51 / 1295	42 / 1067
51 / 1295	48 / 1219
51 / 1295	54 / 1372
51 / 1295	60 / 1524
51 / 1295	66 / 1676
51 / 1295	72 / 1829
51 / 1295	78 / 1981
51 / 1295	84 / 2134
51 / 1295	90 / 2286
51 / 1295	96 / 2438
66 / 1676	24 / 610
66 / 1676	30 / 762
66 / 1676	36 / 914
66 / 1676	42 / 1067
66 / 1676	48 / 1219
66 / 1676	54 / 1372
66 / 1676	60 / 1524
66 / 1676	66 / 1676
66 / 1676	72 / 1829
66 / 1676	78 / 1981
66 / 1676	84 / 2134
66 / 1676	90 / 2286
66 / 1676	96 / 2438

PRICING

268
283
299
319
334
352
362
548
565
585
607
623
635
302
318
332
353
369
385
398
611
627
658
670
686
699

The Flush Panel Wall designed to be used in conjunction with the Inset Glass is flush to the floor when finished.

UYPFR

Flush Panel Wall with Inset Glass

WHAT'S INCLUDED

1 frame (widths 24" - 60") or 2 frames (widths over 60"), hardware for straight connections, levelers.

WHAT'S EXCLUDED

Fascia applied to base must be specified separately.

NOTES

Top trim must be specified (needed when window is applied to top of panel or requires a top trim cover when mounted storage or off-module glass is specified).

Panel wall frame has a Black finish.

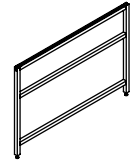

PRODUCT OPTIONS

Height	Width (6" increments)	Fascia & Top Trim
29, 42, 51	24 - 96	To order finished panel walls, a Panel Matrix is available to identify placement of specific fascias and top trim.

SAMPLE ORDER CODE

UYPFR 51	60	PANEL MATRIX
-----------------	-----------	---------------------

**DIMENSIONS
INCHES / MM**

PRICING

H	W	
29 / 737	24 / 610	253
29 / 737	30 / 762	270
29 / 737	36 / 914	282
29 / 737	42 / 1067	305
29 / 737	48 / 1219	324
29 / 737	54 / 1372	344
29 / 737	60 / 1524	357
29 / 737	66 / 1676	533
29 / 737	72 / 1829	553
29 / 737	78 / 1981	570
29 / 737	84 / 2134	589
29 / 737	90 / 2286	609
29 / 737	96 / 2438	629
42 / 1067	24 / 610	286
42 / 1067	30 / 762	309
42 / 1067	36 / 914	331
42 / 1067	42 / 1067	349
42 / 1067	48 / 1219	370
42 / 1067	54 / 1372	393
42 / 1067	60 / 1524	416
42 / 1067	66 / 1676	605
42 / 1067	72 / 1829	628
42 / 1067	78 / 1981	650
42 / 1067	84 / 2134	672
42 / 1067	90 / 2286	695
42 / 1067	96 / 2438	723

**DIMENSIONS
INCHES / MM**

PRICING

H	W	
51 / 1295	24 / 610	315
51 / 1295	30 / 762	337
51 / 1295	36 / 914	360
51 / 1295	42 / 1067	381
51 / 1295	48 / 1219	405
51 / 1295	54 / 1372	429
51 / 1295	60 / 1524	448
51 / 1295	66 / 1676	655
51 / 1295	72 / 1829	680
51 / 1295	78 / 1981	704
51 / 1295	84 / 2134	727
51 / 1295	90 / 2286	752
51 / 1295	96 / 2438	773

panel walls

UNPER

Elevated Panel Wall

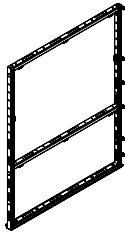

The Elevated Panel Wall provides a 6" high opening from floor level at the base when finished with legs.

WHAT'S INCLUDED

1 frame (widths 24"-60") or 2 frames (widths over 60"), hardware for straight connections, base trim with hardware for attachment.

WHAT'S EXCLUDED

Elevated Panel Wall Foot (UNPEFR) must be ordered separately. Can be found in this section.

NOTES

Top trim is optional (not needed when window is applied to top of panel or requires unique trim when center mount storage is specified).

Panel wall frame has a Black finish.

PRODUCT OPTIONS

Height	Width (6" increments)	Base Trim Finish	Fascia & Top Trim
29, 42, 51, 66	24 - 96	AC Clear Anodized Foundation Mica	To order finished panel walls, a Panel Matrix is available to identify placement of specific fascias and top trim.

SAMPLE ORDER CODE

UNPER 66	96	7	PANEL MATRIX
-----------------	-----------	----------	---------------------

DIMENSIONS INCHES / MM

H	W
29 / 737	24 / 610
29 / 737	30 / 762
29 / 737	36 / 914
29 / 737	42 / 1067
29 / 737	48 / 1219
29 / 737	54 / 1372
29 / 737	60 / 1524
29 / 737	66 / 1676
29 / 737	72 / 1829
29 / 737	78 / 1981
29 / 737	84 / 2134
29 / 737	90 / 2286
29 / 737	96 / 2438
42 / 1067	24 / 610
42 / 1067	30 / 762
42 / 1067	36 / 914
42 / 1067	42 / 1067
42 / 1067	48 / 1219
42 / 1067	54 / 1372
42 / 1067	60 / 1524
42 / 1067	66 / 1676
42 / 1067	72 / 1829
42 / 1067	78 / 1981
42 / 1067	84 / 2134
42 / 1067	90 / 2286
42 / 1067	96 / 2438

PRICING

202
220
235
259
282
305
328
437
450
461
474
485
499
247
274
299
319
346
373
399
536
556
574
593
612
621

DIMENSIONS INCHES / MM

H	W
51 / 1295	24 / 610
51 / 1295	30 / 762
51 / 1295	36 / 914
51 / 1295	42 / 1067
51 / 1295	48 / 1219
51 / 1295	54 / 1372
51 / 1295	60 / 1524
51 / 1295	66 / 1676
51 / 1295	72 / 1829
51 / 1295	78 / 1981
51 / 1295	84 / 2134
51 / 1295	90 / 2286
51 / 1295	96 / 2438
66 / 1676	24 / 610
66 / 1676	30 / 762
66 / 1676	36 / 914
66 / 1676	42 / 1067
66 / 1676	48 / 1219
66 / 1676	54 / 1372
66 / 1676	60 / 1524
66 / 1676	66 / 1676
66 / 1676	72 / 1829
66 / 1676	78 / 1981
66 / 1676	84 / 2134
66 / 1676	90 / 2286
66 / 1676	96 / 2438

PRICING

274
298
319
347
374
401
428
584
603
621
640
660
670
305
329
351
378
404
432
458
641
657
672
687
704
713

The Elevated Panel Wall designed to used in conjunction with the Inset Glass provides a 6" high opening from floor level at the base when finished with legs.

WHAT'S INCLUDED

1 frame (widths 24" - 60") or 2 frames (widths over 60"), hardware for straight connections, levelers.

WHAT'S EXCLUDED

Elevated Panel Wall Foot (UNPEFR) must be ordered separately. Fascia applied must be specified separately.

NOTES

Top trim must be specified (needed when window is applied to top of panel or requires a top trim cover when mounted storage or off-module glass is specified).

Panel wall frame has a Black finish.

U Y P E R
Elevated Panel Wall with Inset Glass

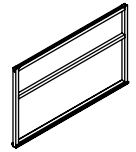

PRODUCT OPTIONS

Height	Width (6" increments)	Base Trim Finish	Fascia & Top Trim
29, 42, 51	24 - 96	AC Clear Anodized Foundation Mica	To order finished panel walls, a Panel Matrix is available to identify placement of specific fascias and top trim.

SAMPLE ORDER CODE

U Y P E R 51	96	7	PANEL MATRIX
---------------------	-----------	----------	---------------------

**DIMENSIONS
INCHES / MM**

H	W
29 / 737	24 / 610
29 / 737	30 / 762
29 / 737	36 / 914
29 / 737	42 / 1067
29 / 737	48 / 1219
29 / 737	54 / 1372
29 / 737	60 / 1524
29 / 737	66 / 1676
29 / 737	72 / 1829
29 / 737	78 / 1981
29 / 737	84 / 2134
29 / 737	90 / 2286
29 / 737	96 / 2438
42 / 1067	24 / 610
42 / 1067	30 / 762
42 / 1067	36 / 914
42 / 1067	42 / 1067
42 / 1067	48 / 1219
42 / 1067	54 / 1372
42 / 1067	60 / 1524
42 / 1067	66 / 1676
42 / 1067	72 / 1829
42 / 1067	78 / 1981
42 / 1067	84 / 2134
42 / 1067	90 / 2286
42 / 1067	96 / 2438

PRICING

263
286
308
336
356
404
426
574
593
611
631
650
670
297
327
355
383
406
454
483
648
669
691
714
744
769

**DIMENSIONS
INCHES / MM**

H	W
51 / 1295	24 / 610
51 / 1295	30 / 762
51 / 1295	36 / 914
51 / 1295	42 / 1067
51 / 1295	48 / 1219
51 / 1295	54 / 1372
51 / 1295	60 / 1524
51 / 1295	66 / 1676
51 / 1295	72 / 1829
51 / 1295	78 / 1981
51 / 1295	84 / 2134
51 / 1295	90 / 2286
51 / 1295	96 / 2438

PRICING

324
354
383
410
434
483
511
694
720
746
772
798
816

UNPC Convertible Panel Wall

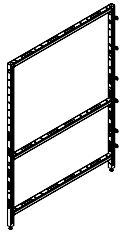

The Convertible Panel Wall frame can be used in flush-to-the-floor applications or in elevated applications by adding the Convertible Panel Wall Base and Foot Trim (UNPCF).

WHAT'S INCLUDED

1 frame (widths 24"-60") or 2 frames (widths over 60"), hardware for straight connections, levelers.

WHAT'S EXCLUDED

Wall Base and Foot Trim (UNPCF) must be specified separately. Can be found in this section.

NOTES

Top trim is optional (not needed when window is applied to top of panel or requires unique trim when center mount storage is specified).

Panel wall frame has a Black finish.

PRODUCT OPTIONS

Height	Width (6" increments)	Fascia & Top Trim
29, 42, 51, 66	24 - 96	To order finished panel walls, a Panel Matrix is available to identify placement of specific fascias and top trim.

SAMPLE ORDER CODE

UNPC 51	60	PANEL MATRIX
---------	----	--------------

DIMENSIONS INCHES / MM

H	W	PRICING
29 / 737	24 / 610	184
29 / 737	30 / 762	196
29 / 737	36 / 914	205
29 / 737	42 / 1067	218
29 / 737	48 / 1219	228
29 / 737	54 / 1372	240
29 / 737	60 / 1524	249
29 / 737	66 / 1676	381
29 / 737	72 / 1829	391
29 / 737	78 / 1981	402
29 / 737	84 / 2134	411
29 / 737	90 / 2286	423
29 / 737	96 / 2438	433
42 / 1067	24 / 610	226
42 / 1067	30 / 762	236
42 / 1067	36 / 914	249
42 / 1067	42 / 1067	268
42 / 1067	48 / 1219	282
42 / 1067	54 / 1372	299
42 / 1067	60 / 1524	310
42 / 1067	66 / 1676	471
42 / 1067	72 / 1829	485
42 / 1067	78 / 1981	502
42 / 1067	84 / 2134	515
42 / 1067	90 / 2286	532
42 / 1067	96 / 2438	556

DIMENSIONS INCHES / MM

H	W	PRICING
51 / 1295	24 / 610	250
51 / 1295	30 / 762	266
51 / 1295	36 / 914	281
51 / 1295	42 / 1067	293
51 / 1295	48 / 1219	308
51 / 1295	54 / 1372	326
51 / 1295	60 / 1524	337
51 / 1295	66 / 1676	512
51 / 1295	72 / 1829	529
51 / 1295	78 / 1981	543
51 / 1295	84 / 2134	559
51 / 1295	90 / 2286	576
51 / 1295	96 / 2438	584
66 / 1676	24 / 610	277
66 / 1676	30 / 762	295
66 / 1676	36 / 914	307
66 / 1676	42 / 1067	322
66 / 1676	48 / 1219	336
66 / 1676	54 / 1372	354
66 / 1676	60 / 1524	367
66 / 1676	66 / 1676	562
66 / 1676	72 / 1829	579
66 / 1676	78 / 1981	593
66 / 1676	84 / 2134	609
66 / 1676	90 / 2286	624
66 / 1676	96 / 2438	637

UYPCR

Convertible Panel Wall with Inset Glass

The Convertible Panel Wall designed to used in conjunction with the Inset Glass and can be used in flush-to-the-floor applications or in elevated applications by adding the Convertible Panel Wall Base and Foot Trim (UNPCF).

WHAT'S INCLUDED

1 frame (widths 24" - 60") or 2 frames (widths over 60"), hardware for straight connections, levelers.

WHAT'S EXCLUDED

Wall Base and Foot Trim (UNPCF) must be specified separately. Fascia applied must be specified separately.

NOTES

Top trim must be specified (needed when window is applied to top of panel or requires a top trim cover when mounted storage or off-module glass is specified).

Panel wall frame has a Black finish.

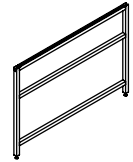

PRODUCT OPTIONS

Height	Width (6" increments)	Fascia & Top Trim
29, 42, 51	24 - 96	To order finished panel walls, a Panel Matrix is available to identify placement of specific fascias and top trim.

SAMPLE ORDER CODE

UYPCR 51	60	PANEL MATRIX
-----------------	-----------	---------------------

**DIMENSIONS
INCHES / MM**

PRICING

H	W	
29 / 737	24 / 610	251
29 / 737	30 / 762	266
29 / 737	36 / 914	281
29 / 737	42 / 1067	299
29 / 737	48 / 1219	315
29 / 737	54 / 1372	333
29 / 737	60 / 1524	351
29 / 737	66 / 1676	525
29 / 737	72 / 1829	543
29 / 737	78 / 1981	561
29 / 737	84 / 2134	581
29 / 737	90 / 2286	601
29 / 737	96 / 2438	613
42 / 1067	24 / 610	276
42 / 1067	30 / 762	296
42 / 1067	36 / 914	312
42 / 1067	42 / 1067	333
42 / 1067	48 / 1219	356
42 / 1067	54 / 1372	380
42 / 1067	60 / 1524	399
42 / 1067	66 / 1676	582
42 / 1067	72 / 1829	605
42 / 1067	78 / 1981	628
42 / 1067	84 / 2134	650
42 / 1067	90 / 2286	672
42 / 1067	96 / 2438	691

**DIMENSIONS
INCHES / MM**

PRICING

H	W	
51 / 1295	24 / 610	301
51 / 1295	30 / 762	321
51 / 1295	36 / 914	337
51 / 1295	42 / 1067	359
51 / 1295	48 / 1219	382
51 / 1295	54 / 1372	406
51 / 1295	60 / 1524	425
51 / 1295	66 / 1676	625
51 / 1295	72 / 1829	648
51 / 1295	78 / 1981	670
51 / 1295	84 / 2134	692
51 / 1295	90 / 2286	714
51 / 1295	96 / 2438	735

panel walls

UNPWSR

Add-On Window (D-Style) – Single Glass

The Add-On Window (D-Style) – Single Glass is applied on top of panel walls as an add-on providing uninterrupted glass spans of up to 8' in width.

WHAT'S INCLUDED

Structural frame, framed window insert, hardware for attachment, top trim (if specified).

NOTES

Standard Glass, Clear is a clear tempered glass.

Specialty Glass Vanceva is a laminated glass.

Glass is oriented to one side of the frame.

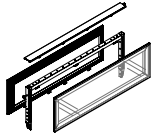

PRODUCT OPTIONS

Height	Width (6" increments)	Glass Finish	Frame Finish	Top Trim	Top Trim Finish (If applicable)
09, 13, 15, 22, 24, 37	24 - 96	5 Clear Standard Glass Specialty Glass Frost	AC Clear Anodized BP Espresso Painted BH Storm White Painted	0 No Top Trim 1 With Top Trim	AC Clear Anodized Foundation Mica

SAMPLE ORDER CODE

UNPWSR 22	48	5	AC	1	AC
-----------	----	---	----	---	----

DIMENSIONS INCHES / MM

H	W
9 / 229	24 / 610
9 / 229	30 / 762
9 / 229	36 / 914
9 / 229	42 / 1067
9 / 229	48 / 1219
9 / 229	54 / 1372
9 / 229	60 / 1524
9 / 229	66 / 1676
9 / 229	72 / 1829
9 / 229	78 / 1981
9 / 229	84 / 2134
9 / 229	90 / 2286
9 / 229	96 / 2438
13 / 330	24 / 610
13 / 330	30 / 762
13 / 330	36 / 914
13 / 330	42 / 1067
13 / 330	48 / 1219
13 / 330	54 / 1372
13 / 330	60 / 1524
13 / 330	66 / 1676
13 / 330	72 / 1829
13 / 330	78 / 1981
13 / 330	84 / 2134
13 / 330	90 / 2286
13 / 330	96 / 2438

PRICING

NO TOP TRIM (0)

Standard Glass Clear	Specialty Glass Frost	Gr. 7
602	732	748
659	802	826
716	871	904
775	943	979
846	1024	1065
900	1095	1139
961	1168	1218
1022	1241	1297
1078	1312	1371
1141	1387	1452
1210	1470	1538
1271	1543	1618
1329	1614	1694
650	802	829
711	880	915
773	961	1002
847	1056	1103
923	1148	1207
981	1224	1287
1052	1317	1387
1144	1428	1506
1210	1513	1597
1268	1588	1680
1363	1697	1799
1427	1782	1890
1492	1870	1982

WITH TOP TRIM (1)

Standard Glass Clear	Specialty Glass Frost	Gr. 7
662	792	808
725	868	892
789	944	977
855	1023	1059
931	1109	1150
997	1192	1236
1064	1271	1321
1132	1351	1407
1197	1431	1490
1268	1514	1579
1343	1603	1671
1415	1687	1762
1477	1762	1842
710	862	889
777	946	981
846	1034	1075
927	1136	1183
1008	1233	1292
1078	1321	1384
1155	1420	1490
1254	1538	1616
1329	1632	1716
1395	1715	1807
1496	1830	1932
1571	1926	2034
1640	2018	2130

UNPWSR
Add-On Window (D-Style) –
Single Glass (Continued)

DIMENSIONS
INCHES / MM

PRICING

DIMENSIONS		NO TOP TRIM (0)			WITH TOP TRIM (1)		
H	W	Standard Glass Clear	Specialty Glass Frost	Gr. 7	Standard Glass Clear	Specialty Glass Frost	Gr. 7
15 / 381	24 / 610	661	826	859	721	886	919
15 / 381	30 / 762	723	910	950	789	976	1016
15 / 381	36 / 914	785	992	1042	858	1065	1115
15 / 381	42 / 1067	863	1092	1146	943	1172	1226
15 / 381	48 / 1219	939	1187	1253	1024	1272	1338
15 / 381	54 / 1372	993	1267	1340	1090	1364	1437
15 / 381	60 / 1524	1064	1357	1440	1167	1460	1543
15 / 381	66 / 1676	1161	1477	1565	1271	1587	1675
15 / 381	72 / 1829	1224	1562	1658	1343	1681	1777
15 / 381	78 / 1981	1284	1643	1748	1411	1770	1875
15 / 381	84 / 2134	1376	1758	1871	1509	1891	2004
15 / 381	90 / 2286	1441	1844	1966	1585	1988	2110
15 / 381	96 / 2438	1506	1932	2061	1654	2080	2209
22 / 559	24 / 610	763	957	1001	823	1017	1061
22 / 559	30 / 762	831	1059	1112	897	1125	1178
22 / 559	36 / 914	899	1159	1224	972	1232	1297
22 / 559	42 / 1067	1001	1289	1368	1081	1369	1448
22 / 559	48 / 1219	1083	1400	1488	1168	1485	1573
22 / 559	54 / 1372	1156	1506	1606	1253	1603	1703
22 / 559	60 / 1524	1226	1607	1719	1329	1710	1822
22 / 559	66 / 1676	1304	1718	1842	1414	1828	1952
22 / 559	72 / 1829	1376	1818	1955	1495	1937	2074
22 / 559	78 / 1981	1444	1918	2062	1571	2045	2189
22 / 559	84 / 2134	1573	2076	2232	1706	2209	2365
22 / 559	90 / 2286	1644	2177	2345	1788	2321	2489
22 / 559	96 / 2438	1713	2276	2456	1861	2424	2604
24 / 610	24 / 610	775	982	1030	835	1042	1090
24 / 610	30 / 762	842	1087	1145	908	1153	1211
24 / 610	36 / 914	912	1187	1261	985	1260	1334
24 / 610	42 / 1067	1015	1322	1407	1095	1402	1487
24 / 610	48 / 1219	1091	1436	1531	1176	1521	1616
24 / 610	54 / 1372	1169	1546	1655	1266	1643	1752
24 / 610	60 / 1524	1238	1650	1769	1341	1753	1872
24 / 610	66 / 1676	1320	1764	1897	1430	1874	2007
24 / 610	72 / 1829	1387	1867	2013	1506	1986	2132
24 / 610	78 / 1981	1456	1970	2127	1583	2097	2254
24 / 610	84 / 2134	1584	2128	2302	1717	2261	2435
24 / 610	90 / 2286	1658	2236	2420	1802	2380	2564
24 / 610	96 / 2438	1728	2341	2537	1876	2489	2685
37 / 940	24 / 610	940	1226	1304	1000	1286	1364
37 / 940	30 / 762	1021	1363	1459	1087	1429	1525
37 / 940	36 / 914	1102	1501	1615	1175	1574	1688
37 / 940	42 / 1067	1237	1685	1820	1317	1765	1900
37 / 940	48 / 1219	1332	1840	1994	1417	1925	2079
37 / 940	54 / 1372	1418	1980	2152	1515	2077	2249
37 / 940	60 / 1524	1505	2119	2313	1608	2222	2416
37 / 940	66 / 1676	1600	2270	2481	1710	2380	2591
37 / 940	72 / 1829	1683	2411	2641	1802	2530	2760
37 / 940	78 / 1981	1764	2547	2797	1891	2674	2924
37 / 940	84 / 2134	1909	2740	3010	2042	2873	3143
37 / 940	90 / 2286	1997	2887	3175	2141	3031	3319
37 / 940	96 / 2438	2083	3025	3333	2231	3173	3481

panel walls

UNPWDR

Add-On Window (D-Style) – Double Glass

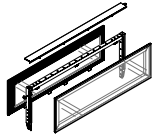

The Add-On Window (D-Style) – Double Glass is applied on top of panel walls as an add-on providing uninterrupted glass spans of up to 8' in width.

WHAT'S INCLUDED

Structural frame, framed window insert, hardware for attachment, top trim (if specified).

NOTES

Standard Glass, Clear is a clear tempered glass.

Standard Glass, Frost is a sandblasted tempered glass that is applied to one side of the window. Clear tempered glass will be applied on the opposite side of the window.

Specialty Glass Vanceva is a laminated glass that is applied to one side of the window. Clear tempered glass will be applied on the opposite side of the window.

PRODUCT OPTIONS

Height	Width (6" increments)	Glass Finish	Frame Finish	Top Trim	Top Trim Finish (If applicable)
09, 13, 15, 22, 24, 37	24 - 96	5 Clear Standard Glass 6 Frost Standard Glass Specialty Glass Frost	AC Clear Anodized BP Espresso Painted BH Storm White Painted	0 No Top Trim 1 With Top Trim	AC Clear Anodized Foundation Mica

SAMPLE ORDER CODE

UNPWDR 15	60	5	AC	1	AC
-----------	----	---	----	---	----

DIMENSIONS INCHES / MM

H	W
9 / 229	24 / 610
9 / 229	30 / 762
9 / 229	36 / 914
9 / 229	42 / 1067
9 / 229	48 / 1219
9 / 229	54 / 1372
9 / 229	60 / 1524
9 / 229	66 / 1676
9 / 229	72 / 1829
9 / 229	78 / 1981
9 / 229	84 / 2134
9 / 229	90 / 2286
9 / 229	96 / 2438
13 / 330	24 / 610
13 / 330	30 / 762
13 / 330	36 / 914
13 / 330	42 / 1067
13 / 330	48 / 1219
13 / 330	54 / 1372
13 / 330	60 / 1524
13 / 330	66 / 1676
13 / 330	72 / 1829
13 / 330	78 / 1981
13 / 330	84 / 2134
13 / 330	90 / 2286
13 / 330	96 / 2438

PRICING

NO TOP TRIM (0)

Standard Glass		Specialty Glass	
Clear	Frost	Frost	Gr. 7
723	742	840	859
799	820	925	949
872	897	1011	1037
947	976	1095	1131
1030	1064	1190	1228
1105	1143	1279	1322
1179	1221	1364	1413
1255	1303	1452	1505
1329	1380	1537	1597
1408	1463	1627	1691
1492	1552	1721	1792
1569	1634	1811	1885
1644	1713	1897	1975
783	808	917	947
863	892	1016	1051
941	977	1110	1151
1035	1074	1223	1269
1133	1178	1334	1389
1203	1255	1423	1488
1296	1354	1532	1602
1419	1482	1672	1746
1502	1569	1769	1852
1577	1653	1863	1952
1694	1778	1998	2092
1779	1867	2096	2200
1861	1956	2198	2308

WITH TOP TRIM (1)

Standard Glass		Specialty Glass	
Clear	Frost	Frost	Gr. 7
783	802	900	919
865	886	991	1015
945	970	1084	1110
1027	1056	1175	1211
1115	1149	1275	1313
1202	1240	1376	1419
1282	1324	1467	1516
1365	1413	1562	1615
1448	1499	1656	1716
1535	1590	1754	1818
1625	1685	1854	1925
1713	1778	1955	2029
1792	1861	2045	2123
843	868	977	1007
929	958	1082	1117
1014	1050	1183	1224
1115	1154	1303	1349
1218	1263	1419	1474
1300	1352	1520	1585
1399	1457	1635	1705
1529	1592	1782	1856
1621	1688	1888	1971
1704	1780	1990	2079
1827	1911	2131	2225
1923	2011	2240	2344
2009	2104	2346	2456

UNPWR
Add-On Window (D-Style) –
Double Glass (Continued)

DIMENSIONS
INCHES / MM

PRICING

DIMENSIONS		NO TOP TRIM (0)				WITH TOP TRIM (1)			
H	W	Standard Glass Clear	Frost	Specialty Glass Frost	Gr. 7	Standard Glass Clear	Frost	Specialty Glass Frost	Gr. 7
15 / 381	24 / 610	797	822	942	976	857	882	1002	1036
15 / 381	30 / 762	874	909	1042	1084	940	975	1108	1150
15 / 381	36 / 914	954	992	1141	1187	1027	1065	1214	1260
15 / 381	42 / 1067	1052	1097	1258	1311	1132	1177	1338	1391
15 / 381	48 / 1219	1144	1200	1371	1436	1229	1285	1456	1521
15 / 381	54 / 1372	1217	1278	1463	1534	1314	1375	1560	1631
15 / 381	60 / 1524	1309	1377	1576	1655	1412	1480	1679	1758
15 / 381	66 / 1676	1434	1506	1719	1804	1544	1616	1829	1914
15 / 381	72 / 1829	1515	1593	1818	1912	1634	1712	1937	2031
15 / 381	78 / 1981	1591	1678	1916	2016	1718	1805	2043	2143
15 / 381	84 / 2134	1709	1803	2050	2160	1842	1936	2183	2293
15 / 381	90 / 2286	1792	1891	2156	2274	1936	2035	2300	2418
15 / 381	96 / 2438	1873	1980	2258	2384	2021	2128	2406	2532
22 / 559	24 / 610	922	959	1100	1143	982	1019	1160	1203
22 / 559	30 / 762	1014	1061	1217	1269	1080	1127	1283	1335
22 / 559	36 / 914	1101	1156	1332	1400	1174	1229	1405	1473
22 / 559	42 / 1067	1235	1302	1495	1569	1315	1382	1575	1649
22 / 559	48 / 1219	1335	1408	1624	1710	1420	1493	1709	1795
22 / 559	54 / 1372	1434	1516	1754	1846	1531	1613	1851	1943
22 / 559	60 / 1524	1524	1615	1871	1976	1627	1718	1974	2079
22 / 559	66 / 1676	1629	1729	2004	2119	1739	1839	2114	2229
22 / 559	72 / 1829	1718	1830	2119	2248	1837	1949	2238	2367
22 / 559	78 / 1981	1805	1923	2237	2375	1932	2050	2364	2502
22 / 559	84 / 2134	1972	2100	2430	2579	2105	2233	2563	2712
22 / 559	90 / 2286	2064	2202	2551	2713	2208	2346	2695	2857
22 / 559	96 / 2438	2155	2303	2670	2840	2303	2451	2818	2988
24 / 610	24 / 610	936	976	1125	1169	996	1036	1185	1229
24 / 610	30 / 762	1023	1072	1243	1302	1089	1138	1309	1368
24 / 610	36 / 914	1110	1173	1364	1436	1183	1246	1437	1509
24 / 610	42 / 1067	1244	1317	1527	1608	1324	1397	1607	1688
24 / 610	48 / 1219	1345	1423	1657	1750	1430	1508	1742	1835
24 / 610	54 / 1372	1444	1534	1788	1894	1541	1631	1885	1991
24 / 610	60 / 1524	1532	1634	1909	2027	1635	1737	2012	2130
24 / 610	66 / 1676	1640	1750	2047	2174	1750	1860	2157	2284
24 / 610	72 / 1829	1729	1850	2167	2310	1848	1969	2286	2429
24 / 610	78 / 1981	1816	1945	2284	2440	1943	2072	2411	2567
24 / 610	84 / 2134	1983	2124	2479	2646	2116	2257	2612	2779
24 / 610	90 / 2286	2082	2231	2607	2788	2226	2375	2751	2932
24 / 610	96 / 2438	2167	2328	2728	2917	2315	2476	2876	3065
37 / 940	24 / 610	1169	1232	1429	1505	1229	1292	1489	1565
37 / 940	30 / 762	1278	1356	1588	1682	1344	1422	1654	1748
37 / 940	36 / 914	1389	1482	1754	1862	1462	1555	1827	1935
37 / 940	42 / 1067	1570	1683	1984	2115	1650	1763	2064	2195
37 / 940	48 / 1219	1700	1830	2162	2310	1785	1915	2247	2395
37 / 940	54 / 1372	1818	1961	2329	2498	1915	2058	2426	2595
37 / 940	60 / 1524	1934	2090	2497	2681	2037	2193	2600	2784
37 / 940	66 / 1676	2062	2236	2676	2879	2172	2346	2786	2989
37 / 940	72 / 1829	2174	2367	2841	3066	2293	2486	2960	3185
37 / 940	78 / 1981	2284	2493	3003	3245	2411	2620	3130	3372
37 / 940	84 / 2134	2475	2698	3245	3500	2608	2831	3378	3633
37 / 940	90 / 2286	2595	2833	3412	3688	2739	2977	3556	3832
37 / 940	96 / 2438	2707	2961	3576	3873	2855	3109	3724	4021

UNPFSR

Flush Full-Height Window (D-Style) – Single Glass

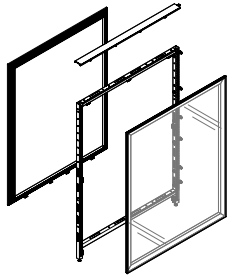

The Flush Full-Height Window (D-Style) – Single Glass provides uninterrupted vertical glass spans above the base rail.

WHAT'S INCLUDED

Structural frame, framed window insert, hardware for straight connections, levelers, top trim (if specified).

WHAT'S EXCLUDED

Fascia applied to base must be specified separately.

NOTES

The 66" height is available up to 48" in width only.

Standard Glass, Clear is a clear tempered glass.

Specialty Glass Vanceva is a laminated glass.

Glass is oriented to one side of the frame.

PRODUCT OPTIONS

Height	Width (6" increments)	Glass Finish	Frame Finish	Top Trim	Top Trim Finish (If applicable)
29, 42, 51, 66	24 - 60	5 Clear Standard Glass Specialty Glass Frost	AC Clear Anodized BP Espresso Painted BH Storm White Painted	0 No Top Trim 1 With Top Trim	AC Clear Anodized Foundation Mica

SAMPLE ORDER CODE

UNPFSR 51	60	5	AC	1	AC
-----------	----	---	----	---	----

DIMENSIONS INCHES / MM

H	W
29 / 737	24 / 610
29 / 737	30 / 762
29 / 737	36 / 914
29 / 737	42 / 1067
29 / 737	48 / 1219
29 / 737	54 / 1372
29 / 737	60 / 1524
42 / 1067	24 / 610
42 / 1067	30 / 762
42 / 1067	36 / 914
42 / 1067	42 / 1067
42 / 1067	48 / 1219
42 / 1067	54 / 1372
42 / 1067	60 / 1524
51 / 1295	24 / 610
51 / 1295	30 / 762
51 / 1295	36 / 914
51 / 1295	42 / 1067
51 / 1295	48 / 1219
51 / 1295	54 / 1372
51 / 1295	60 / 1524
66 / 1676	24 / 610
66 / 1676	30 / 762
66 / 1676	36 / 914
66 / 1676	42 / 1067
66 / 1676	48 / 1219

PRICING

NO TOP TRIM (0)

Standard Glass Clear	Specialty Glass Frost	Gr. 7
1200	1473	1537
1288	1583	1654
1379	1694	1769
1471	1806	1885
1562	1916	2002
1679	2062	2153
1796	2203	2303
1370	1770	1865
1475	1906	2006
1576	2037	2144
1677	2166	2279
1778	2297	2417
1725	2228	2345
1944	2513	2645
1615	2161	2286
1735	2321	2456
1858	2486	2630
1977	2647	2800
2098	2809	2972
2203	2951	3121
2310	3092	3286
1710	2320	2487
1852	2514	2696
1995	2707	2903
2135	2900	3109
2276	3091	3311

WITH TOP TRIM (1)

Standard Glass Clear	Specialty Glass Frost	Gr. 7
1260	1533	1597
1354	1649	1720
1452	1767	1842
1551	1886	1965
1647	2001	2087
1776	2159	2250
1899	2306	2406
1430	1830	1925
1541	1972	2072
1649	2110	2217
1757	2246	2359
1863	2382	2502
1822	2325	2442
2047	2616	2748
1675	2221	2346
1801	2387	2522
1931	2559	2703
2057	2727	2880
2183	2894	3057
2300	3048	3218
2413	3195	3389
1770	2380	2547
1918	2580	2762
2068	2780	2976
2215	2980	3189
2361	3176	3396

The Flush Full-Height Window (D-Style) – Double Glass provides uninterrupted vertical glass spans above the base rail.

WHAT'S INCLUDED

Structural frame, framed window insert, hardware for straight connections, levelers, top trim (if specified).

WHAT'S EXCLUDED

Fascia applied to base must be specified separately.

NOTES

The 66" height is available up to 48" in width only.

Standard Glass, Clear is a clear tempered glass.

Standard Glass, Frost is a sandblasted tempered glass that is applied to one side of the window. Clear tempered glass will be applied on the opposite side of the window.

Specialty Glass Vanceva is a laminated glass that is applied to one side of the window. Clear tempered glass will be applied on the opposite side of the window.

UNPFWDR
Flush Full-Height Window
(D-Style) – Double Glass

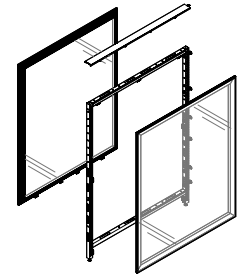

PRODUCT OPTIONS

Height	Width (6" increments)	Glass Finish	Frame Finish	Top Trim	Top Trim Finish (If applicable)
29, 42, 51, 66	24 - 60	5 Clear Standard Glass	AC Clear Anodized	0 No Top Trim	AC Clear Anodized
		6 Frost Standard Glass	BP Espresso Painted	1 With Top Trim	Foundation
		Specialty Glass Frost	BH Storm White Painted		Mica

SAMPLE ORDER CODE

UNPFWDR 42	60	5	AC	1	AC
-------------------	-----------	----------	-----------	----------	-----------

DIMENSIONS
INCHES / MM

H	W
29 / 737	24 / 610
29 / 737	30 / 762
29 / 737	36 / 914
29 / 737	42 / 1067
29 / 737	48 / 1219
29 / 737	54 / 1372
29 / 737	60 / 1524
42 / 1067	24 / 610
42 / 1067	30 / 762
42 / 1067	36 / 914
42 / 1067	42 / 1067
42 / 1067	48 / 1219
42 / 1067	54 / 1372
42 / 1067	60 / 1524
51 / 1295	24 / 610
51 / 1295	30 / 762
51 / 1295	36 / 914
51 / 1295	42 / 1067
51 / 1295	48 / 1219
51 / 1295	54 / 1372
51 / 1295	60 / 1524
66 / 1676	24 / 610
66 / 1676	30 / 762
66 / 1676	36 / 914
66 / 1676	42 / 1067
66 / 1676	48 / 1219

PRICING

NO TOP TRIM (0)				WITH TOP TRIM (1)			
Standard Glass Clear	Standard Glass Frost	Specialty Glass Frost	Specialty Glass Gr. 7	Standard Glass Clear	Standard Glass Frost	Specialty Glass Frost	Specialty Glass Gr. 7
1359	1428	1633	1696	1419	1488	1693	1756
1470	1543	1763	1833	1536	1609	1829	1899
1580	1658	1894	1970	1653	1731	1967	2043
1699	1785	2037	2115	1779	1865	2117	2195
1810	1900	2166	2250	1895	1985	2251	2335
1950	2048	2335	2424	2047	2145	2432	2521
2087	2192	2497	2593	2190	2295	2600	2696
1617	1731	2017	2113	1677	1791	2077	2173
1750	1872	2184	2280	1816	1938	2250	2346
1881	2013	2342	2448	1954	2086	2415	2521
2029	2169	2519	2632	2109	2249	2599	2712
2161	2312	2680	2800	2246	2397	2765	2885
2146	2292	2647	2763	2243	2389	2744	2860
2392	2560	2960	3092	2495	2663	3063	3195
1936	2090	2481	2607	1996	2150	2541	2667
2093	2264	2681	2816	2159	2330	2747	2882
2258	2436	2887	3029	2331	2509	2960	3102
2437	2631	3106	3259	2517	2711	3186	3339
2598	2807	3306	3474	2683	2892	3391	3559
2749	2968	3495	3666	2846	3065	3592	3763
2893	3124	3675	3867	2996	3227	3778	3970
2167	2342	2779	2945	2227	2402	2839	3005
2366	2554	3028	3210	2432	2620	3094	3276
2563	2768	3276	3474	2636	2841	3349	3547
2791	3016	3554	3763	2871	3096	3634	3843
2992	3227	3805	4028	3077	3312	3890	4113

UNPEWSR

Elevated Full-Height Window (D-Style) – Single Glass

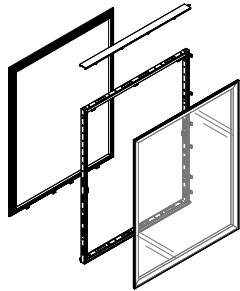

The Elevated Full-Height Window – Single Glass provides uninterrupted vertical glass spans above the base rail.

WHAT'S INCLUDED

Structural frame, framed window insert, hardware for straight connections, base trim with hardware for attachment, top trim (if specified).

WHAT'S EXCLUDED

Elevated Panel Wall Foot (UNPEFR) must be ordered separately. Can be found in this section.

NOTES

The 66" height is available up to 48" in width only.

Standard Glass is a clear tempered glass finish.

Specialty Glass Vanceva is a laminated glass.

Glass is oriented to one side of the frame.

PRODUCT OPTIONS

Height	Width (6" increments)	Glass Finish	Frame Finish	Base Trim Finish	Top Trim	Top Trim Finish (If applicable)
29, 42, 51, 66	24 - 60	5 Clear Standard Glass Specialty Glass Frost	AC Clear Anodized	AC Clear Anodized	0 No Top Trim	AC Clear Anodized
			BP Espresso Painted	Foundation	1 With Top Trim	Foundation
			BH Storm White Painted	Mica		Mica

SAMPLE ORDER CODE

UNPEWSR 29	48	5	AC	AC	1	AC
-------------------	-----------	----------	-----------	-----------	----------	-----------

DIMENSIONS INCHES / MM

H	W
29 / 737	24 / 610
29 / 737	30 / 762
29 / 737	36 / 914
29 / 737	42 / 1067
29 / 737	48 / 1219
29 / 737	54 / 1372
29 / 737	60 / 1524
42 / 1067	24 / 610
42 / 1067	30 / 762
42 / 1067	36 / 914
42 / 1067	42 / 1067
42 / 1067	48 / 1219
42 / 1067	54 / 1372
42 / 1067	60 / 1524
51 / 1295	24 / 610
51 / 1295	30 / 762
51 / 1295	36 / 914
51 / 1295	42 / 1067
51 / 1295	48 / 1219
51 / 1295	54 / 1372
51 / 1295	60 / 1524
66 / 1676	24 / 610
66 / 1676	30 / 762
66 / 1676	36 / 914
66 / 1676	42 / 1067
66 / 1676	48 / 1219

PRICING

NO TOP TRIM (0)

Standard Glass Clear	Specialty Glass Frost	Gr. 7
1232	1505	1568
1325	1618	1690
1423	1737	1813
1522	1856	1936
1618	1974	2060
1744	2127	2220
1868	2276	2375
1404	1805	1897
1508	1939	2041
1618	2080	2188
1728	2219	2330
1834	2353	2474
1791	2294	2411
2015	2585	2716
1648	2194	2319
1770	2357	2493
1900	2531	2675
2029	2698	2852
2157	2867	3030
2270	3017	3188
2383	3162	3357
1742	2353	2521
1888	2549	2732
2040	2752	2948
2189	2951	3159
2335	3148	3371

WITH TOP TRIM (1)

Standard Glass Clear	Specialty Glass Frost	Gr. 7
1292	1565	1628
1391	1684	1756
1496	1810	1886
1602	1936	2016
1703	2059	2145
1841	2224	2317
1971	2379	2478
1464	1865	1957
1574	2005	2107
1691	2153	2261
1808	2299	2410
1919	2438	2559
1888	2391	2508
2118	2688	2819
1708	2254	2379
1836	2423	2559
1973	2604	2748
2109	2778	2932
2242	2952	3115
2367	3114	3285
2486	3265	3460
1802	2413	2581
1954	2615	2798
2113	2825	3021
2269	3031	3239
2420	3233	3456

The Elevated Full-Height Window – Double Glass provides uninterrupted vertical glass spans above the base rail.

WHAT'S INCLUDED

Structural frame, framed window insert, hardware for straight connections, base trim with hardware for attachment, top trim (if specified).

WHAT'S EXCLUDED

Elevated Panel Wall Foot (UNPEFR) must be ordered separately. Can be found in this section.

NOTES

The 66" height is available up to 48" in width only.

Standard Glass is a clear tempered glass finish.

Standard Glass, Frost is a sandblasted tempered glass that is applied to one side of the window. Clear tempered glass will be applied on the opposite side of the window.

Specialty Glass Vanceva is a laminated glass that is applied to one side of the window. Clear tempered glass will be applied on the opposite side of the window.

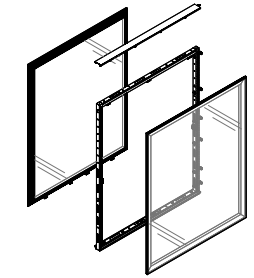

UNPEWDR
Elevated Full-Height Window
(D-Style) – Double Glass

PRODUCT OPTIONS

Height	Width (6" increments)	Glass Finish	Frame Finish	Base Trim Finish	Top Trim	Top Trim Finish (If applicable)
29, 42, 51, 66	24 - 60	5 Clear Standard Glass	AC Clear Anodized	AC Clear Anodized	0 No Top Trim	AC Clear Anodized
		6 Frost Standard Glass Specialty Glass Frost	BP Espresso Painted BH Storm White Painted	Foundation Mica	1 With Top Trim	Foundation Mica

SAMPLE ORDER CODE

UNPEWDR 42	60	5	AC	AC	1	AC
-------------------	-----------	----------	-----------	-----------	----------	-----------

DIMENSIONS
INCHES / MM

H	W
29 / 737	24 / 610
29 / 737	30 / 762
29 / 737	36 / 914
29 / 737	42 / 1067
29 / 737	48 / 1219
29 / 737	54 / 1372
29 / 737	60 / 1524
42 / 1067	24 / 610
42 / 1067	30 / 762
42 / 1067	36 / 914
42 / 1067	42 / 1067
42 / 1067	48 / 1219
42 / 1067	54 / 1372
42 / 1067	60 / 1524
51 / 1295	24 / 610
51 / 1295	30 / 762
51 / 1295	36 / 914
51 / 1295	42 / 1067
51 / 1295	48 / 1219
51 / 1295	54 / 1372
51 / 1295	60 / 1524
66 / 1676	24 / 610
66 / 1676	30 / 762
66 / 1676	36 / 914
66 / 1676	42 / 1067
66 / 1676	48 / 1219

PRICING

NO TOP TRIM (0)				WITH TOP TRIM (1)			
Standard Glass Clear	Standard Glass Frost	Specialty Glass Frost	Specialty Glass Gr. 7	Standard Glass Clear	Standard Glass Frost	Specialty Glass Frost	Specialty Glass Gr. 7
1391	1461	1665	1731	1451	1521	1725	1791
1505	1580	1798	1869	1571	1646	1864	1935
1623	1702	1937	2013	1696	1775	2010	2086
1750	1835	2086	2164	1830	1915	2166	2244
1869	1960	2225	2309	1954	2045	2310	2394
2016	2115	2400	2489	2113	2212	2497	2586
2159	2264	2568	2664	2262	2367	2671	2767
1652	1763	2050	2147	1712	1823	2110	2207
1787	1909	2219	2316	1853	1975	2285	2382
1924	2055	2385	2493	1997	2128	2458	2566
2082	2223	2571	2683	2162	2303	2651	2763
2220	2370	2738	2858	2305	2455	2823	2943
2207	2358	2714	2829	2304	2455	2811	2926
2463	2630	3031	3162	2566	2733	3134	3265
1970	2124	2516	2640	2030	2184	2576	2700
2130	2300	2717	2852	2196	2366	2783	2918
2301	2479	2929	3072	2374	2552	3002	3145
2487	2682	3155	3309	2567	2762	3235	3389
2657	2865	3368	3529	2742	2950	3453	3614
2815	3033	3560	3730	2912	3130	3657	3827
2965	3195	3746	3938	3068	3298	3849	4041
2200	2375	2812	2979	2260	2435	2872	3039
2401	2590	3065	3246	2467	2656	3131	3312
2607	2812	3322	3518	2680	2885	3395	3591
2842	3067	3605	3814	2922	3147	3685	3894
3047	3287	3860	4085	3132	3372	3945	4170

UNPCF

Convertible Panel Wall Base and Foot Trim

The Convertible Panel Wall Base and Foot Trim is used with Convertible Panel Walls to finish elevated applications.

WHAT'S INCLUDED

1 base trim and trim for 2 feet (60" and less)

2 base trims and trims for 4 feet (66" and wider)

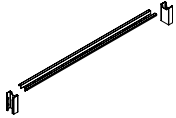

PRODUCT OPTIONS

Width (6" increments)	Foot Finish
24 - 96	Foundation Mica

SAMPLE ORDER CODE

UNPCF 60	N
----------	---

DIMENSIONS INCHES / MM

W
24 / 610
30 / 762
36 / 914
42 / 1067
48 / 1219
54 / 1372
60 / 1524
66 / 1676
72 / 1829
78 / 1981
84 / 2134
90 / 2286
96 / 2438

PRICING

78
80
83
86
95
103
106
169
171
176
179
183
189

The Elevated Panel Wall Foot provides support with leveling capability to Elevated Panel Walls and Elevated Full-Height Windows.

WHAT'S INCLUDED

1 foot, leveler, hardware for connection.

NOTES

The Elevated Panel Wall Foot is used in two-way 180° (no spacer), end of panel wall run applications or when added support is required for 66"-96" panels.

UNPEFR
Elevated Panel Wall Foot

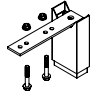

PRODUCT OPTIONS

Foot Finish

AC Clear Anodized

Foundation

Mica

SAMPLE ORDER CODE

UNPEFR AC

PRICING

78

U A F F N

Support Foot for Freestanding District

The Support Foot is added to flush or convertible District panels to allow them to become freestanding.

WHAT'S INCLUDED

1 double-sided metal freestanding foot and panel attachment brackets.

NOTES

Freestanding Foot can be applied to both the Flush or Convertible Panels either with or without Accessory Beam.

The unique element program required when foot is added. See Application Guide for more details.

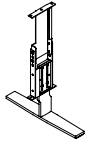

PRODUCT OPTIONS

Orientation	Foot Finish
D Double	Foundation Mica

SAMPLE ORDER CODE

UAFFN D	60
---------	----

PRICING

411

The Panel Wall Rail provides horizontal support when additional segmentation is required above worksurface level.

WHAT'S INCLUDED

Panel wall rail, fascia clips and attachment hardware.

NOTES

Finished in Black to match the panel wall frame.

**UNPHN
Panel Wall Rail**

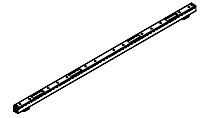

PRODUCT OPTIONS

Width (6" increments)
24 - 60

SAMPLE ORDER CODE

UNPHN 60

**DIMENSIONS
INCHES / MM**

W
24 / 610
30 / 762
33 / 838
36 / 914
39 / 991
42 / 1067
45 / 1143
48 / 1219
54 / 1372
60 / 1524

PRICING

47
61
69
75
80
84
92
101
111
127

UNEX Light Block Rail

The Light Block Rail provides light block above the worksurface for fascias without clips.

WHAT'S INCLUDED

Rail and attachment hardware.

NOTES

Finished in Black to match the panel wall frame.

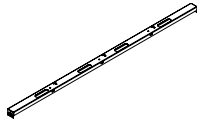

PRODUCT OPTIONS

Width (6" increments)
24 - 60

SAMPLE ORDER CODE

UNEX 60

DIMENSIONS INCHES / MM

W
24 / 610
30 / 762
33 / 838
36 / 914
39 / 991
42 / 1067
45 / 1143
48 / 1219
54 / 1372
60 / 1524

PRICING

41
48
53
65
68
72
75
80
94
105

fascias

fascias product map

UNESD Solid Fascia (Clip Mount)

Page 388

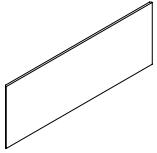

UAESD Solid Fascia for Freestanding District (Clip Mount)

Page 390

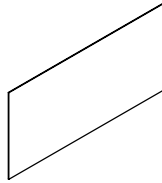

UNYSD Stretch Solid Fascia

Page 392

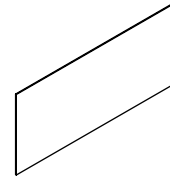

UAYSD Stretch Solid Fascia for Freestanding District

Page 394

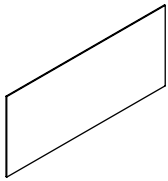

UNESF Solid Fascia – Full-Height

Page 396

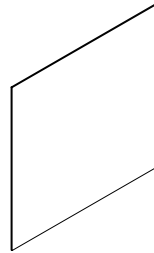

UNELM Metal Fascia (Slot Mount)

Page 398

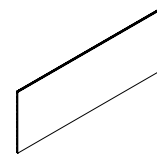

UAELM Metal Fascia for Freestanding District (Slot Mount)

Page 400

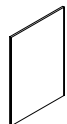

UNELF Tackable Fabric Fascia (Slot Mount)

Page 402

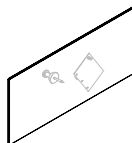

UAELF Tackable Fabric Fascia for Freestanding District (Slot Mount)

Page 406

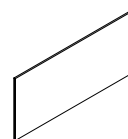

UNEMB Whiteboard Fascia (Slot Mount)

Page 408

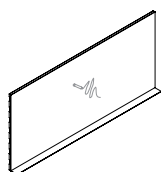

UNELA Accessory Fascia (Slot Mount)

Page 409

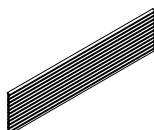

UNECL Solid Power/ Communications Fascia (Clip Mount)

Page 410

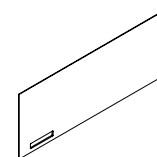

fascias product map

**UAECL Solid Power/
Communications Fascia
for Freestanding District
(Clip Mount)**

Page 414

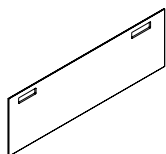

**UNEIL Solid International Power/
Communications Fascia
(Clip Mount)**

Page 416

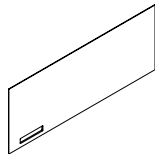

**UAEIL Solid International Power/
Communications Fascia for
Freestanding District (Clip
Mount)**

Page 426

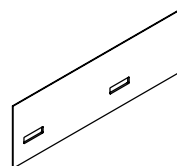

**UNELCM Metal Power/
Communications Fascia
(Slot Mount)**

Page 430

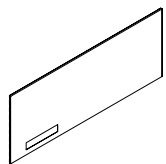

**UAELCM Metal Power/
Communications Fascia
for Freestanding District
(Slot Mount)**

Page 434

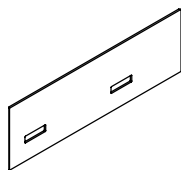

**UNELIM Metal International
Power/Communications
Fascia (Slot Mount)**

Page 436

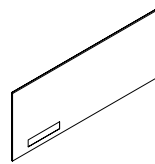

**UAELIM Metal International
Power/Communications
Fascia for Freestanding
District (Slot Mount)**

Page 444

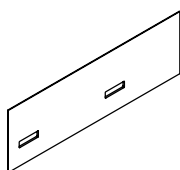

**UNELCF Tackable Fabric Power/
Communications Fascia
(Slot Mount)**

Page 448

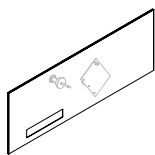

**UAELCF Tackable Fabric Power/
Communications Fascia
for Freestanding District
(Slot Mount)**

Page 454

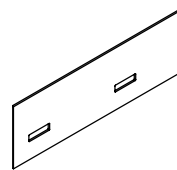

**UNELIF Tackable Fabric
International Power/
Communications Fascia
(Slot Mount)**

Page 456

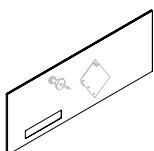

**UAELIF Tackable Fabric
International Power/
Communications Fascia
for Freestanding District
(Slot Mount)**

Page 474

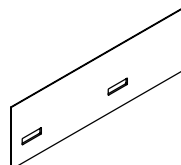

**UNELMB Metal Base Feed Fascia
(Slot Mount)**

Page 480

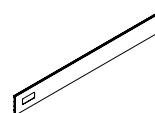

fascias product map

UAELMB Metal Base Feed Fascia for Freestanding District (Slot Mount)

Page 481

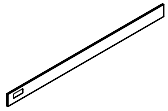

UNELFB Fabric Base Feed Fascia (Slot Mount)

Page 482

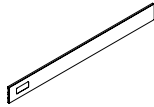

UAELFB Fabric Base Feed Fascia for Freestanding District (Slot Mount)

Page 483

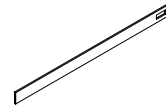

UNELK Fascia Clip Kit

Page 484

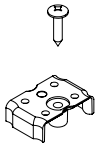

UNESD

Solid Fascia (Clip Mount)

The Solid Fascia provides a solid panel wall finish above worksurface height.

WHAT'S INCLUDED

1 fascia, fascia connectors.

WHAT'S EXCLUDED

Panel Wall Rail (UNPHN) is required for additional panel segmentation and must be specified separately. Can be found in the *Panel Walls* section.

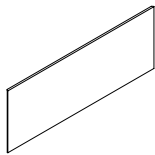

PRODUCT OPTIONS

Height	Width (6" increments)	Fascia Finish
06, 07, 09, 13, 15, 22, 24, 28, 30, 37	24 - 96	Element Source Laminate Flintwood (Standard) Natural Veneer

SAMPLE ORDER CODE

UNESD 28	60	FX
----------	----	----

DIMENSIONS INCHES / MM

H	W
6 / 152	24 / 610
6 / 152	30 / 762
6 / 152	36 / 914
6 / 152	42 / 1067
6 / 152	48 / 1219
6 / 152	54 / 1372
6 / 152	60 / 1524
6 / 152	66 / 1676
6 / 152	72 / 1829
6 / 152	78 / 1981
6 / 152	84 / 2134
6 / 152	90 / 2286
6 / 152	96 / 2438
7 / 178	24 / 610
7 / 178	30 / 762
7 / 178	36 / 914
7 / 178	42 / 1067
7 / 178	48 / 1219
7 / 178	54 / 1372
7 / 178	60 / 1524
7 / 178	66 / 1676
7 / 178	72 / 1829
7 / 178	78 / 1981
7 / 178	84 / 2134
7 / 178	90 / 2286
7 / 178	96 / 2438

PRICING

Element Source Laminate	Flintwood	Natural Veneer
71	148	155
78	162	172
83	174	181
93	184	195
104	201	209
111	218	227
119	226	236
128	238	251
133	249	260
147	270	281
152	278	291
158	287	302
164	298	311
72	155	161
78	167	174
84	177	184
94	189	199
107	211	223
116	223	233
122	233	245
132	252	263
139	262	276
150	277	290
156	287	302
167	305	321
173	315	331

DIMENSIONS INCHES / MM

H	W
9 / 229	24 / 610
9 / 229	30 / 762
9 / 229	36 / 914
9 / 229	42 / 1067
9 / 229	48 / 1219
9 / 229	54 / 1372
9 / 229	60 / 1524
9 / 229	66 / 1676
9 / 229	72 / 1829
9 / 229	78 / 1981
9 / 229	84 / 2134
9 / 229	90 / 2286
9 / 229	96 / 2438
13 / 330	24 / 610
13 / 330	30 / 762
13 / 330	36 / 914
13 / 330	42 / 1067
13 / 330	48 / 1219
13 / 330	54 / 1372
13 / 330	60 / 1524
13 / 330	66 / 1676
13 / 330	72 / 1829
13 / 330	78 / 1981
13 / 330	84 / 2134
13 / 330	90 / 2286
13 / 330	96 / 2438

PRICING

Element Source Laminate	Flintwood	Natural Veneer
79	168	175
86	179	187
98	200	208
107	214	224
123	232	245
132	252	263
142	265	278
151	280	293
160	300	312
173	316	331
181	329	346
189	342	358
199	355	373
95	195	203
105	210	222
121	235	248
132	255	268
152	285	300
162	303	318
175	322	335
187	340	356
204	372	388
220	392	410
230	410	430
242	428	449
254	446	465

UNESD
Solid Fascia (Clip Mount)
(Continued)

DIMENSIONS
INCHES / MM

PRICING

H	W	Element Source Laminate	Flintwood	Natural Veneer
15 / 381	24 / 610	100	203	211
15 / 381	30 / 762	116	229	240
15 / 381	36 / 914	128	250	260
15 / 381	42 / 1067	145	278	290
15 / 381	48 / 1219	162	304	318
15 / 381	54 / 1372	176	324	337
15 / 381	60 / 1524	194	356	374
15 / 381	66 / 1676	207	378	397
15 / 381	72 / 1829	221	398	416
15 / 381	78 / 1981	236	421	441
15 / 381	84 / 2134	250	441	461
15 / 381	90 / 2286	261	460	482
15 / 381	96 / 2438	276	481	504
22 / 559	24 / 610	129	249	259
22 / 559	30 / 762	149	283	297
22 / 559	36 / 914	169	311	326
22 / 559	42 / 1067	191	354	372
22 / 559	48 / 1219	215	387	406
22 / 559	54 / 1372	232	416	435
22 / 559	60 / 1524	251	443	463
22 / 559	66 / 1676	274	476	499
22 / 559	72 / 1829	300	530	555
22 / 559	78 / 1981	322	561	587
22 / 559	84 / 2134	338	589	616
22 / 559	90 / 2286	362	635	664
22 / 559	96 / 2438	381	662	694
24 / 610	24 / 610	134	258	272
24 / 610	30 / 762	156	296	309
24 / 610	36 / 914	177	326	341
24 / 610	42 / 1067	202	372	387
24 / 610	48 / 1219	227	407	427
24 / 610	54 / 1372	247	436	457
24 / 610	60 / 1524	265	467	488
24 / 610	66 / 1676	511	714	748
24 / 610	72 / 1829	552	762	798
24 / 610	78 / 1981	568	790	829
24 / 610	84 / 2134	611	854	895
24 / 610	90 / 2286	648	899	942
24 / 610	96 / 2438	655	917	962
28 / 710	24 / 610	149	283	298
28 / 710	30 / 762	172	319	333
28 / 710	36 / 914	199	366	383
28 / 710	42 / 1067	225	405	425
28 / 710	48 / 1219	247	438	460
28 / 710	54 / 1372	481	680	711
28 / 710	60 / 1524	527	734	769
28 / 710	66 / 1676	552	770	808
28 / 710	72 / 1829	599	840	882
28 / 710	78 / 1981	650	902	944
28 / 710	84 / 2134	666	943	989
28 / 710	90 / 2286	708	994	1042
28 / 710	96 / 2438	720	1007	1055

DIMENSIONS
INCHES / MM

PRICING

H	W	Element Source Laminate	Flintwood	Natural Veneer
30 / 762	24 / 610	156	296	309
30 / 762	30 / 762	184	346	361
30 / 762	36 / 914	208	382	401
30 / 762	42 / 1067	234	421	441
30 / 762	48 / 1219	263	463	485
30 / 762	54 / 1372	514	719	753
30 / 762	60 / 1524	563	777	814
30 / 762	66 / 1676	594	834	873
30 / 762	72 / 1829	640	890	933
30 / 762	78 / 1981	663	939	985
30 / 762	84 / 2134	708	993	1041
30 / 762	90 / 2286	720	1006	1053
30 / 762	96 / 2438	742	1057	1107
37 / 965	24 / 610	185	347	361
37 / 965	30 / 762	215	391	409
37 / 965	36 / 914	247	437	458
37 / 965	42 / 1067	496	695	729
37 / 965	48 / 1219	561	773	810
37 / 965	54 / 1372	601	839	879
37 / 965	60 / 1524	628	883	924
37 / 965	66 / 1676	689	969	1016
37 / 965	72 / 1829	695	994	1041
37 / 965	78 / 1981	748	1062	1112
37 / 965	84 / 2134	762	1101	1153
37 / 965	90 / 2286	776	1108	1160
37 / 965	96 / 2438	789	1164	1219

UAESD

Solid Fascia for Freestanding District (Clip Mount)

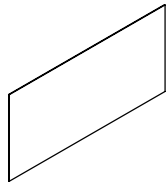

The Solid Fascia provides a solid panel wall finish on panel supported by the Freestanding Foot (UAFFN).

WHAT'S INCLUDED

1 fascia, fascia connectors.

NOTES

Fascia is to only be applied to District Panel that is supported by the Freestanding Foot (UAFFN).

The 22" fascia must be ordered with a 6" high fascia as Elevated panels are not applicable in a freestanding application.

PRODUCT OPTIONS

Height	Width (6" increments)	Fascia Finish
6, 22, 28, 35, 41	24 - 96	Element Source Laminate Flintwood (Standard) Natural Veneer

SAMPLE ORDER CODE

UAESD 28	60	FX
-----------------	-----------	-----------

DIMENSIONS INCHES / MM

H	W
6 / 152	24 / 610
6 / 152	30 / 762
6 / 152	36 / 914
6 / 152	42 / 1067
6 / 152	48 / 1219
6 / 152	54 / 1372
6 / 152	60 / 1524
6 / 152	66 / 1676
6 / 152	72 / 1829
6 / 152	78 / 1981
6 / 152	84 / 2134
6 / 152	90 / 2286
6 / 152	96 / 2438
22 / 559	24 / 610
22 / 559	30 / 762
22 / 559	36 / 914
22 / 559	42 / 1067
22 / 559	48 / 1219
22 / 559	54 / 1372
22 / 559	60 / 1524
22 / 559	66 / 1676
22 / 559	72 / 1829
22 / 559	78 / 1981
22 / 559	84 / 2134
22 / 559	90 / 2286
22 / 559	96 / 2438

PRICING

Element Source Laminate	Flintwood	Natural Veneer
61	139	147
71	154	161
76	164	172
83	175	182
91	183	193
96	194	202
102	207	219
111	222	231
119	230	240
127	244	254
134	258	271
142	268	280
147	277	288
123	244	254
144	277	290
160	305	321
191	354	372
208	381	400
227	409	429
246	437	458
260	462	484
286	517	540
308	550	576
333	583	610
356	629	658
376	657	687

DIMENSIONS INCHES / MM

H	W
28 / 711	24 / 610
28 / 711	30 / 762
28 / 711	36 / 914
28 / 711	42 / 1067
28 / 711	48 / 1219
28 / 711	54 / 1372
28 / 711	60 / 1524
28 / 711	66 / 1676
28 / 711	72 / 1829
28 / 711	78 / 1981
28 / 711	84 / 2134
28 / 711	90 / 2286
28 / 711	96 / 2438
35 / 889	24 / 610
35 / 889	30 / 762
35 / 889	36 / 914
35 / 889	42 / 1067
35 / 889	48 / 1219
35 / 889	54 / 1372
35 / 889	60 / 1524
35 / 889	66 / 1676
35 / 889	72 / 1829
35 / 889	78 / 1981
35 / 889	84 / 2134
35 / 889	90 / 2286
35 / 889	96 / 2438

PRICING

Element Source Laminate	Flintwood	Natural Veneer
144	278	290
167	311	327
194	359	377
219	398	416
238	431	452
471	666	699
514	721	756
562	777	814
585	824	864
635	885	926
646	910	953
691	976	1023
705	989	1036
174	322	335
206	378	397
234	423	441
479	674	706
535	741	777
565	787	824
627	871	912
650	911	954
707	991	1038
712	1015	1063
725	1036	1084
763	1118	1170
777	1131	1184

Pricing is continued on the following page.

U A E S D
Solid Fascia for Freestanding
District (Clip Mount) (Continued)

DIMENSIONS
INCHES / MM

PRICING

H	W	Element Source Laminate	Flintwood	Natural Veneer
41 / 1041	24 / 610	200	364	382
41 / 1041	30 / 762	232	414	434
41 / 1041	36 / 914	265	465	487
41 / 1041	42 / 1067	540	748	784
41 / 1041	48 / 1219	585	821	861
41 / 1041	54 / 1372	649	898	941
41 / 1041	60 / 1524	685	964	1010
41 / 1041	66 / 1676	701	1000	1047
41 / 1041	72 / 1829	715	1024	1072
41 / 1041	78 / 1981	769	1123	1175
41 / 1041	84 / 2134	784	1134	1187
41 / 1041	90 / 2286	798	1149	1202
41 / 1041	96 / 2438	813	1196	1252

UNYSD

Stretch Solid Fascia

The Stretch Solid Fascia provides a extended solid panel wall finish on panel.

WHAT'S INCLUDED

1 fascia, fascia connectors.

NOTES

Stretch Solid Fascia is only designed for in line applications.

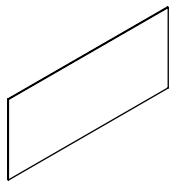

PRODUCT OPTIONS

Height	Width (6" increments)	Orientation	Fascia Finish
6, 22, 28, 35, 41	24 - 96	L Left R Right B Both	Element Source Laminate Flintwood (Standard) Natural Veneer

SAMPLE ORDER CODE

UNYSD 28	60	B	FX
-----------------	-----------	----------	-----------

DIMENSIONS INCHES / MM

H	W
6 / 152	24 / 610
6 / 152	30 / 762
6 / 152	36 / 914
6 / 152	42 / 1067
6 / 152	48 / 1219
6 / 152	54 / 1372
6 / 152	60 / 1524
6 / 152	66 / 1676
6 / 152	72 / 1829
6 / 152	78 / 1981
6 / 152	84 / 2134
6 / 152	90 / 2286
6 / 152	96 / 2438
22 / 559	24 / 610
22 / 559	30 / 762
22 / 559	36 / 914
22 / 559	42 / 1067
22 / 559	48 / 1219
22 / 559	54 / 1372
22 / 559	60 / 1524
22 / 559	66 / 1676
22 / 559	72 / 1829
22 / 559	78 / 1981
22 / 559	84 / 2134
22 / 559	90 / 2286
22 / 559	96 / 2438

PRICING

Element Source Laminate	Flintwood	Natural Veneer
69	153	159
75	161	171
80	172	180
88	182	193
97	199	208
102	208	219
108	219	228
119	231	242
125	240	252
135	260	274
144	271	282
149	280	293
155	288	303
139	270	281
157	297	310
176	325	340
200	367	384
224	402	421
242	429	450
259	457	479
288	514	538
307	543	568
329	576	602
353	620	649
372	649	679
388	676	708

DIMENSIONS INCHES / MM

H	W
28 / 711	24 / 610
28 / 711	30 / 762
28 / 711	36 / 914
28 / 711	42 / 1067
28 / 711	48 / 1219
28 / 711	54 / 1372
28 / 711	60 / 1524
28 / 711	66 / 1676
28 / 711	72 / 1829
28 / 711	78 / 1981
28 / 711	84 / 2134
28 / 711	90 / 2286
28 / 711	96 / 2438
35 / 889	24 / 610
35 / 889	30 / 762
35 / 889	36 / 914
35 / 889	42 / 1067
35 / 889	48 / 1219
35 / 889	54 / 1372
35 / 889	60 / 1524
35 / 889	66 / 1676
35 / 889	72 / 1829
35 / 889	78 / 1981
35 / 889	84 / 2134
35 / 889	90 / 2286
35 / 889	96 / 2438

PRICING

Element Source Laminate	Flintwood	Natural Veneer
155	297	310
181	346	360
205	380	399
230	418	437
253	453	475
501	704	736
545	758	794
572	809	847
614	862	903
635	895	938
682	963	1010
694	975	1022
713	1022	1069
198	360	378
226	405	424
254	450	469
506	707	740
569	782	818
605	843	884
629	884	925
691	972	1017
706	993	1040
742	1053	1103
757	1065	1115
787	1148	1202
801	1161	1216

Pricing is continued on the following page.

UNYSD
Stretch Solid Fascia (Continued)

DIMENSIONS
INCHES / MM

PRICING

DIMENSIONS		PRICING		
H	W	Element Source Laminate	Flintwood	Natural Veneer
41 / 1041	24 / 610	215	391	409
41 / 1041	30 / 762	249	442	462
41 / 1041	36 / 914	508	711	744
41 / 1041	42 / 1067	554	772	809
41 / 1041	48 / 1219	623	866	908
41 / 1041	54 / 1372	660	934	977
41 / 1041	60 / 1524	674	967	1013
41 / 1041	66 / 1676	735	1043	1092
41 / 1041	72 / 1829	742	1091	1142
41 / 1041	78 / 1981	757	1112	1164
41 / 1041	84 / 2134	787	1175	1229
41 / 1041	90 / 2286	802	1189	1244
41 / 1041	96 / 2438	816	1203	1258

UAYS D

Stretch Solid Fascia for Freestanding District

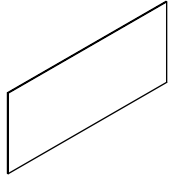

The Stretch Solid Fascia provides a extended solid panel wall finish on panel supported by the Freestanding Foot (UAFFN).

WHAT'S INCLUDED

1 fascia, fascia connectors.

WHAT'S EXCLUDED

Fascia is to only be applied to District Panel that is supported by the Freestanding Foot (UAFFN).

The 22" fascia must be ordered with a 6" high fascia as Elevated panels are not applicable in a freestanding application.

NOTES

Stretch Solid Fascia is only designed for in line applications.

PRODUCT OPTIONS

Height	Width (6" increments)	Orientation	Fascia Finish
6, 22, 28, 35, 41	24 - 96	L Left R Right B Both	Element Source Laminate Flintwood (Standard) Natural Veneer

SAMPLE ORDER CODE

UAYS D 28	60	B	FX
------------------	-----------	----------	-----------

DIMENSIONS INCHES / MM

H	W
6 / 152	24 / 610
6 / 152	30 / 762
6 / 152	36 / 914
6 / 152	42 / 1067
6 / 152	48 / 1219
6 / 152	54 / 1372
6 / 152	60 / 1524
6 / 152	66 / 1676
6 / 152	72 / 1829
6 / 152	78 / 1981
6 / 152	84 / 2134
6 / 152	90 / 2286
6 / 152	96 / 2438
22 / 559	24 / 610
22 / 559	30 / 762
22 / 559	36 / 914
22 / 559	42 / 1067
22 / 559	48 / 1219
22 / 559	54 / 1372
22 / 559	60 / 1524
22 / 559	66 / 1676
22 / 559	72 / 1829
22 / 559	78 / 1981
22 / 559	84 / 2134
22 / 559	90 / 2286
22 / 559	96 / 2438

PRICING

Element Source Laminate	Flintwood	Natural Veneer
66	145	151
73	158	168
78	169	176
85	179	186
93	187	197
100	203	212
105	211	223
116	225	235
121	233	246
130	248	258
136	261	275
145	272	283
150	280	295
139	270	281
157	297	310
176	325	340
200	367	384
224	402	421
242	429	450
259	457	479
288	514	538
307	543	568
329	576	602
353	620	649
372	649	679
388	676	708

DIMENSIONS INCHES / MM

H	W
28 / 711	24 / 610
28 / 711	30 / 762
28 / 711	36 / 914
28 / 711	42 / 1067
28 / 711	48 / 1219
28 / 711	54 / 1372
28 / 711	60 / 1524
28 / 711	66 / 1676
28 / 711	72 / 1829
28 / 711	78 / 1981
28 / 711	84 / 2134
28 / 711	90 / 2286
28 / 711	96 / 2438
35 / 889	24 / 610
35 / 889	30 / 762
35 / 889	36 / 914
35 / 889	42 / 1067
35 / 889	48 / 1219
35 / 889	54 / 1372
35 / 889	60 / 1524
35 / 889	66 / 1676
35 / 889	72 / 1829
35 / 889	78 / 1981
35 / 889	84 / 2134
35 / 889	90 / 2286
35 / 889	96 / 2438

PRICING

Element Source Laminate	Flintwood	Natural Veneer
153	295	307
179	341	357
203	377	393
228	413	433
250	449	468
492	694	727
537	747	784
563	798	837
606	850	891
627	884	925
671	951	997
684	961	1007
704	1008	1056
198	360	378
226	405	424
254	450	469
506	707	740
569	782	818
605	843	884
629	884	925
691	972	1017
706	993	1040
742	1053	1103
757	1065	1115
787	1148	1202
801	1161	1216

Pricing is continued on the following page.

U A Y S D
Stretch Solid Fascia for
Freestanding District (Continued)

DIMENSIONS
INCHES / MM

H	W
41 / 1041	24 / 610
41 / 1041	30 / 762
41 / 1041	36 / 914
41 / 1041	42 / 1067
41 / 1041	48 / 1219
41 / 1041	54 / 1372
41 / 1041	60 / 1524
41 / 1041	66 / 1676
41 / 1041	72 / 1829
41 / 1041	78 / 1981
41 / 1041	84 / 2134
41 / 1041	90 / 2286
41 / 1041	96 / 2438

PRICING

Element Source	Flintwood	Natural Veneer
Laminate		
214	388	407
248	438	459
504	705	738
548	765	802
615	859	899
648	909	951
666	960	1004
729	1035	1083
741	1056	1105
757	1102	1154
781	1165	1219
795	1178	1233
809	1193	1248

UNESF

Solid Fascia – Full-Height

The Solid Fascia – Full-Height provides a solid monolithic look from the base of the panel to a height of 42".

WHAT'S INCLUDED

1 fascia with connectors.

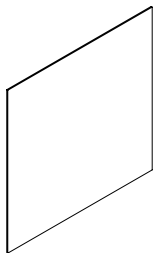

PRODUCT OPTIONS

Height	Width (6" increments)	Fascia Finish
35, 41	24 - 96	Element Source Laminate Flintwood (Standard) Natural Veneer

SAMPLE ORDER CODE

UNESF 35	60	FX
----------	----	----

DIMENSIONS INCHES / MM

H	W
35 / 889	24 / 610
35 / 889	30 / 762
35 / 889	36 / 914
35 / 889	42 / 1067
35 / 889	48 / 1219
35 / 889	54 / 1372
35 / 889	60 / 1524
35 / 889	66 / 1676
35 / 889	72 / 1829
35 / 889	78 / 1981
35 / 889	84 / 2134
35 / 889	90 / 2286
35 / 889	96 / 2438

PRICING

Element Source Laminate	Flintwood	Natural Veneer
180	328	342
211	384	402
242	428	449
480	675	707
543	750	785
576	795	834
634	879	921
662	923	966
719	1004	1051
729	1031	1080
741	1044	1094
773	1127	1180
787	1141	1194

DIMENSIONS INCHES / MM

H	W
41 / 1041	24 / 610
41 / 1041	30 / 762
41 / 1041	36 / 914
41 / 1041	42 / 1067
41 / 1041	48 / 1219
41 / 1041	54 / 1372
41 / 1041	60 / 1524
41 / 1041	66 / 1676
41 / 1041	72 / 1829
41 / 1041	78 / 1981
41 / 1041	84 / 2134
41 / 1041	90 / 2286
41 / 1041	96 / 2438

PRICING

Element Source Laminate	Flintwood	Natural Veneer
204	372	388
236	423	441
480	675	707
553	760	796
596	834	873
631	886	928
697	977	1024
713	1015	1063
729	1038	1087
786	1142	1195
801	1153	1208
815	1168	1221
829	1216	1272

UNELM

Metal Fascia (Slot Mount)

The Metal Fascia provides a metal panel wall finish.

WHAT'S INCLUDED

1 fascia and attachment hardware.

NOTES

30" and 37" heights can be specified to a maximum of 60" width only.

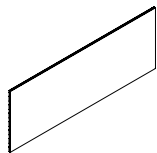

PRODUCT OPTIONS

Height	Width (6" increments)	Fascia Finish
06, 07, 09, 13, 15, 22, 24, 26, 28, 30, 37	24 - 96	Foundation Mica

SAMPLE ORDER CODE

UNELM 28	60	E
----------	----	---

DIMENSIONS INCHES / MM

H	W
6 / 152	24 / 610
6 / 152	30 / 762
6 / 152	36 / 914
6 / 152	42 / 1067
6 / 152	48 / 1219
6 / 152	54 / 1372
6 / 152	60 / 1524
6 / 152	66 / 1676
6 / 152	72 / 1829
6 / 152	78 / 1981
6 / 152	84 / 2134
6 / 152	90 / 2286
6 / 152	96 / 2438
7 / 178	24 / 610
7 / 178	30 / 762
7 / 178	36 / 914
7 / 178	42 / 1067
7 / 178	48 / 1219
7 / 178	54 / 1372
7 / 178	60 / 1524
7 / 178	66 / 1676
7 / 178	72 / 1829
7 / 178	78 / 1981
7 / 178	84 / 2134
7 / 178	90 / 2286
7 / 178	96 / 2438

PRICING

75
79
83
88
93
97
101
109
119
127
135
146
154
76
80
85
92
96
99
103
113
123
131
142
150
158

DIMENSIONS INCHES / MM

H	W
9 / 229	24 / 610
9 / 229	30 / 762
9 / 229	36 / 914
9 / 229	42 / 1067
9 / 229	48 / 1219
9 / 229	54 / 1372
9 / 229	60 / 1524
9 / 229	66 / 1676
9 / 229	72 / 1829
9 / 229	78 / 1981
9 / 229	84 / 2134
9 / 229	90 / 2286
9 / 229	96 / 2438
13 / 330	24 / 610
13 / 330	30 / 762
13 / 330	36 / 914
13 / 330	42 / 1067
13 / 330	48 / 1219
13 / 330	54 / 1372
13 / 330	60 / 1524
13 / 330	66 / 1676
13 / 330	72 / 1829
13 / 330	78 / 1981
13 / 330	84 / 2134
13 / 330	90 / 2286
13 / 330	96 / 2438

PRICING

80
85
93
98
102
107
113
123
132
144
153
162
174
96
103
109
118
124
130
137
151
164
178
191
204
219

Pricing is continued on the following page.

U N E L M
Metal Fascia (Slot Mount)
(Continued)

DIMENSIONS INCHES / MM		PRICING
H	W	
15 / 381	24 / 610	102
15 / 381	30 / 762	109
15 / 381	36 / 914	119
15 / 381	42 / 1067	126
15 / 381	48 / 1219	133
15 / 381	54 / 1372	143
15 / 381	60 / 1524	150
15 / 381	66 / 1676	164
15 / 381	72 / 1829	179
15 / 381	78 / 1981	195
15 / 381	84 / 2134	209
15 / 381	90 / 2286	225
15 / 381	96 / 2438	238
22 / 559	24 / 610	122
22 / 559	30 / 762	132
22 / 559	36 / 914	145
22 / 559	42 / 1067	154
22 / 559	48 / 1219	164
22 / 559	54 / 1372	175
22 / 559	60 / 1524	184
22 / 559	66 / 1676	204
22 / 559	72 / 1829	224
22 / 559	78 / 1981	244
22 / 559	84 / 2134	261
22 / 559	90 / 2286	281
22 / 559	96 / 2438	301
24 / 610	24 / 610	129
24 / 610	30 / 762	142
24 / 610	36 / 914	153
24 / 610	42 / 1067	164
24 / 610	48 / 1219	176
24 / 610	54 / 1372	186
24 / 610	60 / 1524	199
24 / 610	66 / 1676	220
24 / 610	72 / 1829	238
24 / 610	78 / 1981	259
24 / 610	84 / 2134	281
24 / 610	90 / 2286	302
24 / 610	96 / 2438	323
26 / 660	24 / 610	144
26 / 660	30 / 762	156
26 / 660	36 / 914	171
26 / 660	42 / 1067	182
26 / 660	48 / 1219	196
26 / 660	54 / 1372	207
26 / 660	60 / 1524	222
26 / 660	66 / 1676	246
26 / 660	72 / 1829	270
26 / 660	78 / 1981	293
26 / 660	84 / 2134	316
26 / 660	90 / 2286	340
26 / 660	96 / 2438	363

DIMENSIONS INCHES / MM		PRICING
H	W	
28 / 711	24 / 610	144
28 / 711	30 / 762	156
28 / 711	36 / 914	171
28 / 711	42 / 1067	182
28 / 711	48 / 1219	196
28 / 711	54 / 1372	207
28 / 711	60 / 1524	222
28 / 711	66 / 1676	246
28 / 711	72 / 1829	270
28 / 711	78 / 1981	293
28 / 711	84 / 2134	316
28 / 711	90 / 2286	340
28 / 711	96 / 2438	363
30 / 762	24 / 610	148
30 / 762	30 / 762	161
30 / 762	36 / 914	176
30 / 762	42 / 1067	189
30 / 762	48 / 1219	203
30 / 762	54 / 1372	218
30 / 762	60 / 1524	230
37 / 965	24 / 610	179
37 / 965	30 / 762	197
37 / 965	36 / 914	214
37 / 965	42 / 1067	230
37 / 965	48 / 1219	248
37 / 965	54 / 1372	263
37 / 965	60 / 1524	282

U A E L M

Metal Fascia for Freestanding District (Slot Mount)

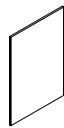

The Metal Fascia provides a metal panel wall finish.

WHAT'S INCLUDED

1 fascia and attachment hardware.

NOTES

Not all height/width combinations are available, 35" heights can be specified to a maximum of 60" width only. See pricing for exact offering.

Fascia is to only be applied to District Panel that is supported by the freestanding Foot (UAFFN).

The 22" fascia must be ordered with a 6" high fascia as Elevated panels are not applicable in a freestanding application.

PRODUCT OPTIONS

Height	Width (6" increments)	Fascia Finish
06, 22, 28, 35	24 - 96	Foundation Mica

SAMPLE ORDER CODE

UAELM 28	60	E
----------	----	---

DIMENSIONS INCHES / MM

H	W
6 / 152	24 / 610
6 / 152	30 / 762
6 / 152	36 / 914
6 / 152	42 / 1067
6 / 152	48 / 1219
6 / 152	54 / 1372
6 / 152	60 / 1524
6 / 152	66 / 1676
6 / 152	72 / 1829
6 / 152	78 / 1981
6 / 152	84 / 2134
6 / 152	90 / 2286
6 / 152	96 / 2438
22 / 559	24 / 610
22 / 559	30 / 762
22 / 559	36 / 914
22 / 559	42 / 1067
22 / 559	48 / 1219
22 / 559	54 / 1372
22 / 559	60 / 1524
22 / 559	66 / 1676
22 / 559	72 / 1829
22 / 559	78 / 1981
22 / 559	84 / 2134
22 / 559	90 / 2286
22 / 559	96 / 2438

PRICING

86
94
99
104
108
116
121
160
167
171
175
179
183
122
132
145
154
164
175
184
238
252
263
276
287
301

DIMENSIONS INCHES / MM

H	W
28 / 711	24 / 610
28 / 711	30 / 762
28 / 711	36 / 914
28 / 711	42 / 1067
28 / 711	48 / 1219
28 / 711	54 / 1372
28 / 711	60 / 1524
28 / 711	66 / 1676
28 / 711	72 / 1829
28 / 711	78 / 1981
28 / 711	84 / 2134
28 / 711	90 / 2286
28 / 711	96 / 2438
35 / 889	24 / 610
35 / 889	30 / 762
35 / 889	36 / 914
35 / 889	42 / 1067
35 / 889	48 / 1219
35 / 889	54 / 1372
35 / 889	60 / 1524

PRICING

142
154
169
181
195
206
220
299
310
324
335
348
360
160
177
195
209
226
244
258

UNELF

Tackable Fabric Fascia (Slot Mount)

The Tackable Fabric Fascia provides a tackable panel wall finish.

WHAT'S INCLUDED

1 fascia.

WHAT'S EXCLUDED

Fascia Light Block (UNEX) is required for additional segmentation and must be specified separately. Can be found in the *Panel Walls* section.

NOTES

6" and 7" height fascias are not tackable.

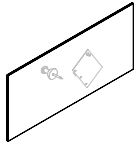

PRODUCT OPTIONS

Height	Width (6" increments)	Fascia Finish
06, 07, 09, 13, 15, 21, 24, 26, 28, 30, 37	24 - 96	Panel Fabric

SAMPLE ORDER CODE

UNELF 21	72	L341
----------	----	------

DIMENSIONS INCHES / MM

H	W
6 / 152	24 / 610
6 / 152	30 / 762
6 / 152	36 / 914
6 / 152	42 / 1067
6 / 152	48 / 1219
6 / 152	54 / 1372
6 / 152	60 / 1524
6 / 152	66 / 1676
6 / 152	72 / 1829
6 / 152	78 / 1981
6 / 152	84 / 2134
6 / 152	90 / 2286
6 / 152	96 / 2438
7 / 178	24 / 610
7 / 178	30 / 762
7 / 178	36 / 914
7 / 178	42 / 1067
7 / 178	48 / 1219
7 / 178	54 / 1372
7 / 178	60 / 1524
7 / 178	66 / 1676
7 / 178	72 / 1829
7 / 178	78 / 1981
7 / 178	84 / 2134
7 / 178	90 / 2286
7 / 178	96 / 2438

PRICING

Fabric A/COM	Gr. 1	Gr. 2	Gr. 3	Gr. 4	Gr. 5	Gr. 6	Gr. 7
100	103	106	110	116	119	123	126
109	113	127	131	136	143	149	154
121	125	135	142	147	151	157	162
130	134	145	149	155	161	170	176
139	146	152	159	168	175	182	189
150	154	161	171	179	185	195	202
159	164	174	182	191	200	208	218
171	176	184	196	205	212	224	232
180	185	197	207	219	227	237	249
191	197	207	221	232	242	253	263
201	207	220	232	245	255	268	279
210	219	230	246	258	270	282	296
222	229	244	257	272	283	298	310
104	107	110	118	123	125	129	133
117	120	133	137	145	151	157	164
127	132	144	149	154	159	169	175
136	144	152	158	167	174	182	189
149	154	160	172	181	187	198	205
158	164	175	183	194	202	210	221
171	176	186	197	207	218	227	236
181	187	200	210	222	232	245	254
194	200	212	225	236	249	260	273
204	211	226	237	251	262	277	290
215	224	237	252	265	279	295	307
227	234	252	266	282	296	310	326
237	248	263	280	297	310	328	342

Pricing is continued on the following page.

UNELF

Tackable Fabric Fascia (Slot Mount)
(Continued)DIMENSIONS
INCHES / MM

PRICING

H	W	Fabric A/COM	Gr. 1	Gr. 2	Gr. 3	Gr. 4	Gr. 5	Gr. 6	Gr. 7
9 / 229	24 / 610	73	76	80	86	94	98	103	107
9 / 229	30 / 762	80	84	103	108	117	124	131	139
9 / 229	36 / 914	91	97	109	117	124	130	137	147
9 / 229	42 / 1067	98	104	117	124	132	143	152	160
9 / 229	48 / 1219	105	111	122	133	145	153	164	175
9 / 229	54 / 1372	113	122	133	144	154	164	177	186
9 / 229	60 / 1524	123	129	145	154	167	178	191	203
9 / 229	66 / 1676	131	142	156	169	181	195	207	221
9 / 229	72 / 1829	143	151	170	180	194	208	225	237
9 / 229	78 / 1981	152	161	180	195	209	225	240	256
9 / 229	84 / 2134	161	173	194	206	222	238	257	274
9 / 229	90 / 2286	173	182	205	221	237	255	274	291
9 / 229	96 / 2438	182	195	219	232	250	271	290	308
13 / 330	24 / 610	82	86	95	101	108	116	123	128
13 / 330	30 / 762	94	100	125	132	142	151	161	174
13 / 330	36 / 914	104	113	132	142	151	159	172	182
13 / 330	42 / 1067	116	124	142	149	159	172	183	197
13 / 330	48 / 1219	125	134	149	160	174	186	201	212
13 / 330	54 / 1372	134	146	164	174	185	200	214	228
13 / 330	60 / 1524	146	155	178	187	201	218	232	248
13 / 330	66 / 1676	157	170	194	205	220	235	253	271
13 / 330	72 / 1829	171	181	208	222	236	254	274	291
13 / 330	78 / 1981	182	196	225	236	253	274	296	312
13 / 330	84 / 2134	196	208	238	254	273	293	315	335
13 / 330	90 / 2286	207	222	255	271	289	311	335	357
13 / 330	96 / 2438	220	234	271	286	307	331	356	380
15 / 381	24 / 610	92	96	99	111	123	129	137	147
15 / 381	30 / 762	103	108	132	143	152	161	176	186
15 / 381	36 / 914	117	125	143	152	163	178	193	205
15 / 381	42 / 1067	127	135	150	168	183	197	210	226
15 / 381	48 / 1219	139	149	158	182	201	212	231	247
15 / 381	54 / 1372	152	159	170	198	220	232	252	270
15 / 381	60 / 1524	162	173	183	214	238	253	274	293
15 / 381	66 / 1676	178	187	200	234	260	277	300	322
15 / 381	72 / 1829	193	204	215	253	281	300	325	348
15 / 381	78 / 1981	205	220	231	273	303	323	349	374
15 / 381	84 / 2134	221	233	248	291	325	346	374	401
15 / 381	90 / 2286	233	249	262	309	346	367	399	427
15 / 381	96 / 2438	249	263	279	329	365	389	424	453
21 / 531	24 / 610	111	120	125	146	160	170	182	196
21 / 531	30 / 762	129	136	171	181	196	210	229	246
21 / 531	36 / 914	148	159	181	201	221	237	258	278
21 / 531	42 / 1067	162	176	193	222	246	263	286	307
21 / 531	48 / 1219	180	194	203	244	273	288	313	337
21 / 531	54 / 1372	198	209	225	266	299	318	347	373
21 / 531	60 / 1524	214	227	245	288	324	347	378	406
21 / 531	66 / 1676	233	250	265	318	357	381	414	448
21 / 531	72 / 1829	252	271	287	346	387	412	451	485
21 / 531	78 / 1981	272	290	309	372	416	445	485	523
21 / 531	84 / 2134	290	310	331	398	446	478	521	560
21 / 531	90 / 2286	309	331	354	425	477	509	556	598
21 / 531	96 / 2438	329	353	376	451	506	540	589	635

Pricing is continued on the following page.

UNELF

Tackable Fabric Fascia (Slot Mount) (Continued)

DIMENSIONS INCHES / MM

PRICING

H	W	Fabric A/COM	Gr. 1	Gr. 2	Gr. 3	Gr. 4	Gr. 5	Gr. 6	Gr. 7
24 / 610	24 / 610	117	123	128	149	163	174	186	200
24 / 610	30 / 762	133	143	179	193	207	224	244	260
24 / 610	36 / 914	151	164	193	206	225	246	266	285
24 / 610	42 / 1067	170	182	203	229	252	272	296	316
24 / 610	48 / 1219	185	200	214	251	279	298	324	348
24 / 610	54 / 1372	203	218	230	274	306	326	354	380
24 / 610	60 / 1524	222	234	251	298	332	354	385	413
24 / 610	66 / 1676	240	257	274	326	364	388	424	455
24 / 610	72 / 1829	259	278	297	353	395	421	458	493
24 / 610	78 / 1981	280	300	319	379	425	454	494	531
24 / 610	84 / 2134	300	321	340	406	455	486	530	569
24 / 610	90 / 2286	319	341	362	433	485	518	564	608
24 / 610	96 / 2438	338	361	385	460	515	552	601	645
26 / 660	24 / 610	124	136	149	167	181	194	207	223
26 / 660	30 / 762	144	159	199	212	230	249	271	288
26 / 660	36 / 914	161	186	223	237	256	278	302	325
26 / 660	42 / 1067	181	206	236	255	278	303	330	354
26 / 660	48 / 1219	200	226	251	279	306	332	361	387
26 / 660	54 / 1372	220	246	305	328	355	384	420	452
26 / 660	60 / 1524	236	265	335	361	391	427	465	503
26 / 660	66 / 1676	258	290	370	400	433	471	514	556
26 / 660	72 / 1829	279	313	404	435	472	514	563	608
26 / 660	78 / 1981	301	337	430	462	502	545	598	644
26 / 660	84 / 2134	323	361	463	501	542	590	646	697
26 / 660	90 / 2286	344	385	497	536	583	635	695	750
26 / 660	96 / 2438	363	409	531	574	624	680	744	803
28 / 711	24 / 610	124	136	149	167	181	194	207	223
28 / 711	30 / 762	144	159	199	212	230	249	271	288
28 / 711	36 / 914	161	186	223	237	256	278	302	325
28 / 711	42 / 1067	181	206	236	255	278	303	330	354
28 / 711	48 / 1219	200	226	251	279	306	332	361	387
28 / 711	54 / 1372	220	246	305	328	355	384	420	452
28 / 711	60 / 1524	236	265	335	361	391	427	465	503
28 / 711	66 / 1676	258	290	370	400	433	471	514	556
28 / 711	72 / 1829	279	313	404	435	472	514	563	608
28 / 711	78 / 1981	301	337	430	462	502	545	598	644
28 / 711	84 / 2134	323	361	463	501	542	590	646	697
28 / 711	90 / 2286	344	385	497	536	583	635	695	750
28 / 711	96 / 2438	363	409	531	574	624	680	744	803
30 / 762	24 / 610	127	143	155	171	185	199	212	228
30 / 762	30 / 762	148	167	208	224	240	260	283	305
30 / 762	36 / 914	169	194	233	250	270	291	316	340
30 / 762	42 / 1067	186	212	249	265	287	311	338	362
30 / 762	48 / 1219	206	233	262	287	314	341	372	399
30 / 762	54 / 1372	226	253	311	334	361	391	427	459
30 / 762	60 / 1524	246	275	344	370	401	434	475	510
30 / 762	66 / 1676	266	299	379	407	440	480	523	563
30 / 762	72 / 1829	288	324	412	446	484	525	573	616
30 / 762	78 / 1981	310	349	438	474	512	556	607	655
30 / 762	84 / 2134	332	373	475	510	553	602	657	708
30 / 762	90 / 2286	354	398	508	548	594	645	706	761
30 / 762	96 / 2438	377	423	543	585	634	690	756	815

Pricing is continued on the following page.

U N E L F
Tackable Fabric Fascia (Slot Mount)
(Continued)

DIMENSIONS
INCHES / MM
PRICING

DIMENSIONS		PRICING							
H	W	Fabric A/COM	Gr. 1	Gr. 2	Gr. 3	Gr. 4	Gr. 5	Gr. 6	Gr. 7
37 / 940	24 / 610	175	183	196	233	261	280	306	329
37 / 940	30 / 762	204	218	255	285	316	348	380	409
37 / 940	36 / 914	234	254	275	331	375	403	442	479
37 / 940	42 / 1067	263	282	302	370	420	451	493	534
37 / 940	48 / 1219	295	311	332	407	462	497	545	589
37 / 940	54 / 1372	324	344	378	458	518	560	615	666
37 / 940	60 / 1524	353	376	412	501	567	613	675	731
37 / 940	66 / 1676	384	418	451	555	632	682	750	813
37 / 940	72 / 1829	417	453	487	602	686	739	813	883
37 / 940	78 / 1981	450	487	527	648	738	796	878	951
37 / 940	84 / 2134	481	523	563	695	793	854	941	1021
37 / 940	90 / 2286	512	558	602	741	845	912	1005	1090
37 / 940	96 / 2438	545	591	638	788	898	969	1068	1159

U A E L F

Tackable Fabric Fascia for Freestanding District (Slot Mount)

The Tackable Fabric Fascia provides a tackable panel wall finish.

WHAT'S INCLUDED

1 fascia with cut out as specified, fascia connectors.

NOTES

Not all height/width combinations are available. See pricing for exact offering.

Fascia is to only be applied to District Panel that is supported by the Freestanding Foot (UAFFN).

The 22" and 35" fascias must be ordered with a 6" high fascia as Elevated panels are not applicable in a freestanding application.

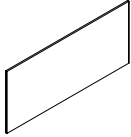

PRODUCT OPTIONS

Height	Width (6" increments)	Fascia Finish
6, 22, 35	24 - 96	Panel Fabric

SAMPLE ORDER CODE

UAELF 22	60	L341
----------	----	------

DIMENSIONS INCHES / MM

H	W
6 / 152	24 / 610
6 / 152	30 / 762
6 / 152	36 / 914
6 / 152	42 / 1067
6 / 152	48 / 1219
6 / 152	54 / 1372
6 / 152	60 / 1524
6 / 152	66 / 1676
6 / 152	72 / 1829
6 / 152	78 / 1981
6 / 152	84 / 2134
6 / 152	90 / 2286
6 / 152	96 / 2438

PRICING

Fabric A/COM	Gr. 1	Gr. 2	Gr. 3	Gr. 4	Gr. 5	Gr. 6	Gr. 7
105	107	110	117	121	123	127	130
116	119	131	135	142	147	152	158
124	128	139	145	150	154	160	168
132	137	147	152	158	164	172	178
143	148	154	161	170	177	183	193
151	156	162	173	181	186	197	203
160	167	174	183	193	200	208	219
172	177	185	197	206	214	225	233
182	187	199	209	221	229	240	250
194	200	209	223	234	245	255	266
204	210	223	234	247	258	272	282
214	223	234	249	261	274	286	300
226	233	247	260	275	287	302	315

Pricing is continued on the following page.

U A E L F
Tackable Fabric Fascia for
Freestanding District (Slot Mount)
(Continued)

DIMENSIONS
INCHES / MM

H	W
22 / 559	24 / 610
22 / 559	30 / 762
22 / 559	36 / 914
22 / 559	42 / 1067
22 / 559	48 / 1219
22 / 559	54 / 1372
22 / 559	60 / 1524
22 / 559	66 / 1676
22 / 559	72 / 1829
22 / 559	78 / 1981
22 / 559	84 / 2134
22 / 559	90 / 2286
22 / 559	96 / 2438
35 / 889	24 / 610
35 / 889	30 / 762
35 / 889	36 / 914
35 / 889	42 / 1067
35 / 889	48 / 1219
35 / 889	54 / 1372
35 / 889	60 / 1524
35 / 889	66 / 1676
35 / 889	72 / 1829
35 / 889	78 / 1981
35 / 889	84 / 2134
35 / 889	90 / 2286
35 / 889	96 / 2438

PRICING

Fabric A/COM	Gr. 1	Gr. 2	Gr. 3	Gr. 4	Gr. 5	Gr. 6	Gr. 7
111	120	125	146	160	170	182	196
129	136	171	181	196	210	229	246
148	159	181	201	221	237	258	278
162	176	193	222	246	263	286	307
180	194	203	244	273	288	313	337
198	209	225	266	299	318	347	373
214	227	245	288	324	347	378	406
233	250	265	318	357	381	414	448
252	271	287	346	387	412	451	485
272	290	309	372	416	445	485	523
290	310	331	398	446	478	521	560
309	331	354	425	477	509	556	598
329	353	376	451	506	540	589	635
171	179	191	228	256	275	301	324
199	210	246	279	310	338	373	402
229	248	262	324	367	395	433	468
257	275	295	360	410	441	484	525
285	304	325	399	453	486	535	580
315	335	370	450	510	552	607	658
346	366	404	490	558	604	664	721
376	408	441	545	623	671	740	804
407	442	478	590	674	729	803	872
437	477	514	637	729	786	866	940
469	511	553	683	780	842	929	1010
501	545	588	730	834	899	992	1077
532	580	627	775	886	956	1055	1146

UNEMB Whiteboard Fascia (Slot Mount)

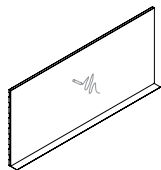

The Whiteboard Fascia provides an erasable message board surface.

WHAT'S INCLUDED

1 fascia.

WHAT'S EXCLUDED

Fascia Light Block (UNEX) is required for additional segmentation and must be specified separately. Can be found in the *Panel Walls* section.

NOTES

The width of the tray equals the width of the fascia.

Please note that two trays **cannot** be used side-by-side in a 90° configuration.

PRODUCT OPTIONS

Tray	Height	Width	Tray Finish (If applicable)
N No Tray	22, 24, 30, 37	36, 42, 48	Foundation
T With Tray			Mica

SAMPLE ORDER CODE

UNEMB T	22	48	P
---------	----	----	---

DIMENSIONS INCHES / MM

H	W
22 / 559	36 / 914
22 / 559	42 / 1067
22 / 559	48 / 1219
24 / 610	36 / 914
24 / 610	42 / 1067
24 / 610	48 / 1219
30 / 762	36 / 914
30 / 762	42 / 1067
30 / 762	48 / 1219
37 / 940	36 / 914
37 / 940	42 / 1067
37 / 940	48 / 1219

PRICING

NO TRAY (N)	WITH TRAY (T)
291	352
311	374
502	561
358	418
379	438
914	974
363	425
385	446
919	981
527	586
550	609
954	1014

The Accessory Fascia provides support for Personal Organizers (PAX) and fx Accessories to facilitate organization of the workspace.

WHAT'S INCLUDED

1 fascia and attachment hardware.

WHAT'S EXCLUDED

Fascia Light Block (UNEX) is required for additional segmentation and must be specified separately. Can be found in the *Panel Walls* section.

NOTES

Personal Organizers (PAX) and fx Accessories can be found in Complements: *Teknion's Ergonomics & Accessories Program*.

**UNELA
Accessory Fascia
(Slot Mount)**

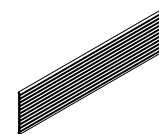

PRODUCT OPTIONS

Height	Width (6" increments)	Fascia Finish
06, 13, 15	24 - 96	Foundation Mica

SAMPLE ORDER CODE

UNELA 15	24	E
-----------------	-----------	----------

**DIMENSIONS
INCHES / MM**

PRICING

H	W
6 / 152	24 / 610
6 / 152	30 / 762
6 / 152	36 / 914
6 / 152	42 / 1067
6 / 152	48 / 1219
6 / 152	54 / 1372
6 / 152	60 / 1524
6 / 152	66 / 1676
6 / 152	72 / 1829
6 / 152	78 / 1981
6 / 152	84 / 2134
6 / 152	90 / 2286
6 / 152	96 / 2438
13 / 330	24 / 610
13 / 330	30 / 762
13 / 330	36 / 914
13 / 330	42 / 1067
13 / 330	48 / 1219
13 / 330	54 / 1372
13 / 330	60 / 1524
13 / 330	66 / 1676
13 / 330	72 / 1829
13 / 330	78 / 1981
13 / 330	84 / 2134
13 / 330	90 / 2286
13 / 330	96 / 2438

198
223
252
274
295
312
332
361
395
428
429
430
431
261
296
357
393
403
526
527
557
582
661
662
663
665

**DIMENSIONS
INCHES / MM**

PRICING

H	W
15 / 381	24 / 610
15 / 381	30 / 762
15 / 381	36 / 914
15 / 381	42 / 1067
15 / 381	48 / 1219
15 / 381	54 / 1372
15 / 381	60 / 1524
15 / 381	66 / 1676
15 / 381	72 / 1829
15 / 381	78 / 1981
15 / 381	84 / 2134
15 / 381	90 / 2286
15 / 381	96 / 2438

283
324
391
433
442
590
591
623
644
735
737
738
740

UNECL

Solid Power/Communications Fascia (Clip Mount)

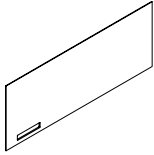

The Solid Power/Communications Fascia provides face-mounted access to power/communications above or below worksurface height.

WHAT'S INCLUDED

1 fascia with cut out as specified, fascia connectors.

WHAT'S EXCLUDED

Panel Wall Rail (UNPHN) is required for additional panel segmentation and must be specified separately. Can be found in the *Panel Walls* section.

NOTES

Not all height/width combinations are available. See pricing for exact offering.

Panel Wall Rail (UNPHN) required for application to Panel Frame for Wood and/or Framed Fascias, ordered separately.

PRODUCT OPTIONS

Outlet Configuration	Horizontal Power/Communications Orientation	Vertical Power/Communications Orientation	Height	Width (6" increments)	Fascia Finish
2 One duplex outlet plus VDM (available on 24" and 30" widths)	B Left and Right (available on 66" width and wider for one and two duplex outlets)	B Bottom or lower section of Fascia (available on 7", 13", 22", 37" heights)	07, 13, 22, 28, 37	24 - 96	Element Source Laminate Flintwood Natural Veneer
	C Centered (available on 36" width for two duplex outlets and on 24", 30", 36" widths for one duplex outlet)	F Flush (applies to 28" height only for base fascias flush to floor. Cut Out will be at bottom)			
4 Two duplex outlets plus VDM (available on 36" widths and wider)	L Left (not available on widths below 42")	T Top or upper section of Fascia (available on 13", 22", 28" heights)			
	R Right (not available on widths below 42")				

SAMPLE ORDER CODE

UNECL 2	B	B	22	72	FX
---------	---	---	----	----	----

DIMENSIONS INCHES / MM

H	W
7 / 178	66 / 1676
7 / 178	72 / 1829
7 / 178	78 / 1981
7 / 178	84 / 2134
7 / 178	90 / 2286
7 / 178	96 / 2438
13 / 330	66 / 1676
13 / 330	72 / 1829
13 / 330	78 / 1981
13 / 330	84 / 2134
13 / 330	90 / 2286
13 / 330	96 / 2438
22 / 559	66 / 1676
22 / 559	72 / 1829
22 / 559	78 / 1981
22 / 559	84 / 2134
22 / 559	90 / 2286
22 / 559	96 / 2438

PRICING

HORIZONTAL (B) & VERTICAL (B)

Element Source Laminater	Flintwood	Natural Veneer
196	315	330
202	326	341
211	340	356
220	351	367
228	367	385
234	379	397
251	403	423
266	433	455
281	455	477
293	474	496
305	490	513
316	508	532
335	537	563
361	591	620
383	624	654
402	653	683
426	697	731
443	726	760

DIMENSIONS INCHES / MM

H	W
37 / 940	66 / 1676
37 / 940	72 / 1829
37 / 940	78 / 1981
37 / 940	84 / 2134
37 / 940	90 / 2286
37 / 940	96 / 2438
28 / 711	66 / 1676
28 / 711	72 / 1829
28 / 711	78 / 1981
28 / 711	84 / 2134
28 / 711	90 / 2286
28 / 711	96 / 2438

PRICING

HORIZONTAL (B) & VERTICAL (B) (CONTINUED)

Element Source Laminate	Flintwood	Natural Veneer
752	1032	1082
758	1057	1107
811	1124	1177
824	1164	1219
838	1177	1233
852	1227	1285

HORIZONTAL (B) & VERTICAL (F)

Element Source Laminate	Flintwood	Natural Veneer
613	834	873
662	904	947
712	964	1011
730	1006	1055
770	1057	1108
783	1069	1120

Pricing is continued on the following page.

UN ECL

Solid Power/Communications Fascia
(Clip Mount) (Continued)

DIMENSIONS
INCHES / MM

H	W
13 / 330	66 / 1676
13 / 330	72 / 1829
13 / 330	78 / 1981
13 / 330	84 / 2134
13 / 330	90 / 2286
13 / 330	96 / 2438
22 / 559	66 / 1676
22 / 559	72 / 1829
22 / 559	78 / 1981
22 / 559	84 / 2134
22 / 559	90 / 2286
22 / 559	96 / 2438
28 / 711	66 / 1676
28 / 711	72 / 1829
28 / 711	78 / 1981
28 / 711	84 / 2134
28 / 711	90 / 2286
28 / 711	96 / 2438

PRICING

HORIZONTAL (B) & VERTICAL (T)

Element Source Laminate	Flintwood	Natural Veneer
251	403	423
266	433	455
281	455	477
293	474	496
305	490	513
316	508	532
335	537	563
361	591	620
383	624	654
402	653	683
426	697	731
443	726	760
613	834	873
662	904	947
712	964	1011
730	1006	1055
770	1057	1108
783	1069	1120

HORIZONTAL (C) & VERTICAL (B)

H	W
7 / 178	24 / 610
7 / 178	30 / 762
7 / 178	36 / 914
13 / 330	24 / 610
13 / 330	30 / 762
13 / 330	36 / 914
22 / 559	24 / 610
22 / 559	30 / 762
22 / 559	36 / 914
37 / 940	24 / 610
37 / 940	30 / 762
37 / 940	36 / 914

Element Source Laminate	Flintwood	Natural Veneer
133	219	228
142	228	238
148	238	251
156	256	270
170	275	286
182	299	312
193	310	326
210	347	361
230	375	391
249	408	428
278	455	476
308	501	525

HORIZONTAL (C) & VERTICAL (F)

H	W
28 / 711	24 / 610
28 / 711	30 / 762
28 / 711	36 / 914

Element Source Laminate	Flintwood	Natural Veneer
210	347	362
233	381	400
260	429	450

DIMENSIONS
INCHES / MM

H	W
13 / 330	24 / 610
13 / 330	30 / 762
13 / 330	36 / 914
22 / 559	24 / 610
22 / 559	30 / 762
22 / 559	36 / 914
28 / 711	24 / 610
28 / 711	30 / 762
28 / 711	36 / 914

H	W
7 / 178	42 / 1067
7 / 178	48 / 1219
7 / 178	54 / 1372
7 / 178	60 / 1524
7 / 178	66 / 1676
7 / 178	72 / 1829
7 / 178	78 / 1981
7 / 178	84 / 2134
7 / 178	90 / 2286
7 / 178	96 / 2438

13 / 330	42 / 1067
13 / 330	48 / 1219
13 / 330	54 / 1372
13 / 330	60 / 1524
13 / 330	66 / 1676
13 / 330	72 / 1829
13 / 330	78 / 1981
13 / 330	84 / 2134
13 / 330	90 / 2286
13 / 330	96 / 2438

22 / 559	42 / 1067
22 / 559	48 / 1219
22 / 559	54 / 1372
22 / 559	60 / 1524
22 / 559	66 / 1676
22 / 559	72 / 1829
22 / 559	78 / 1981
22 / 559	84 / 2134
22 / 559	90 / 2286
22 / 559	96 / 2438

37 / 940	42 / 1067
37 / 940	48 / 1219
37 / 940	54 / 1372
37 / 940	60 / 1524
37 / 940	66 / 1676
37 / 940	72 / 1829
37 / 940	78 / 1981
37 / 940	84 / 2134
37 / 940	90 / 2286
37 / 940	96 / 2438

PRICING

HORIZONTAL (C) & VERTICAL (T)

Element Source Laminate	Flintwood	Natural Veneer
156	256	270
170	275	286
182	299	312
193	310	326
210	347	361
230	375	391
210	347	362
233	381	400
260	429	450

HORIZONTAL (L or R) & VERTICAL (B)

Element Source Laminate	Flintwood	Natural Veneer
155	252	262
172	275	287
177	285	300
183	297	309
196	315	330
202	326	341
211	340	356
220	351	367
228	367	385
234	379	397

196	318	333
215	349	364
227	366	383
237	383	402
251	403	423
266	433	455
281	455	477
293	474	496
305	490	513
316	508	532

254	416	436
278	451	472
297	479	502
312	506	530
335	537	563
361	591	620
383	624	654
402	653	683
426	697	731
443	726	760

558	758	794
624	836	875
662	902	944
689	944	990
752	1032	1082
758	1057	1107
811	1124	1177
824	1164	1219
838	1177	1233
852	1227	1285

Pricing is continued on the following page.

UN E C L

**Solid Power/Communications Fascia
(Clip Mount) (Continued)**

**DIMENSIONS
INCHES / MM**

H	W
28 / 711	42 / 1067
28 / 711	48 / 1219
28 / 711	54 / 1372
28 / 711	60 / 1524
28 / 711	66 / 1676
28 / 711	72 / 1829
28 / 711	78 / 1981
28 / 711	84 / 2134
28 / 711	90 / 2286
28 / 711	96 / 2438

H	W
13 / 330	42 / 1067
13 / 330	48 / 1219
13 / 330	54 / 1372
13 / 330	60 / 1524
13 / 330	66 / 1676
13 / 330	72 / 1829
13 / 330	78 / 1981
13 / 330	84 / 2134
13 / 330	90 / 2286
13 / 330	96 / 2438

22 / 559	42 / 1067
22 / 559	48 / 1219
22 / 559	54 / 1372
22 / 559	60 / 1524
22 / 559	66 / 1676
22 / 559	72 / 1829
22 / 559	78 / 1981
22 / 559	84 / 2134
22 / 559	90 / 2286
22 / 559	96 / 2438

28 / 711	42 / 1067
28 / 711	48 / 1219
28 / 711	54 / 1372
28 / 711	60 / 1524
28 / 711	66 / 1676
28 / 711	72 / 1829
28 / 711	78 / 1981
28 / 711	84 / 2134
28 / 711	90 / 2286
28 / 711	96 / 2438

PRICING

HORIZONTAL (L or R) & VERTICAL (F)

Element Source Laminate	Flintwood	Natural Veneer
286	467	489
308	503	527
544	741	777
588	796	835
613	834	873
662	904	947
712	964	1011
730	1006	1055
770	1057	1108
783	1069	1120

HORIZONTAL (L or R) & VERTICAL (T)

Element Source Laminate	Flintwood	Natural Veneer
196	318	333
215	349	364
227	366	383
237	383	402
251	403	423
266	433	455
281	455	477
293	474	496
305	490	513
316	508	532

254	416	436
278	451	472
297	479	502
312	506	530
335	537	563
361	591	620
383	624	654
402	653	683
426	697	731
443	726	760

286	467	489
308	503	527
544	741	777
588	796	835
613	834	873
662	904	947
712	964	1011
730	1006	1055
770	1057	1108
783	1069	1120

UAECL

Solid Power/Communications Fascia for Freestanding District (Clip Mount)

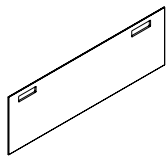

The Solid Power/Communications Fascia provides face-mounted access to power/communications.

WHAT'S INCLUDED

1 fascia with cut out as specified, fascia connectors.

NOTES

Not all height/width combinations are available. See pricing for exact offering.

Fascia is to only be applied to District Panel that is supported by the Freestanding Foot (UAFFN).

The 22" fascia must be ordered with a 6" high fascia as Elevated panels are not applicable in a freestanding application.

For 36" to 60" wide fascias only Left (LL) or Right (RR) power and data locations can be specified.

PRODUCT OPTIONS

Outlet Configuration	Horizontal Power/Communication Orientation	Vertical Power/Communication Orientation	Height	Width (6" increments)	Fascia Finish
2 Cut Out for two outlets (available on 24" and 30" widths)	LL Left	T Top	22, 28	36 - 96	Element Source Laminate Flintwood (Standard) Natural Veneer
	LC Left Centre	B Bottom			
4 Cut Out for four outlets (available on 36" widths and wider)	RC Right Centre				
	RR Right				
	LR Left & Right				
	CR Left Centre and Right				
	CL Right Centre and Left				

SAMPLE ORDER CODE

UAECL 2	CR	B	22	72	FX
---------	----	---	----	----	----

DIMENSIONS INCHES / MM

H	W
22 / 559	66 / 1676
22 / 559	72 / 1829
22 / 559	78 / 1981
22 / 559	84 / 2134
22 / 559	90 / 2286
22 / 559	96 / 2438
28 / 711	66 / 1676
28 / 711	72 / 1829
28 / 711	78 / 1981
28 / 711	84 / 2134
28 / 711	90 / 2286
28 / 711	96 / 2438

PRICING

HORIZONTAL (LC, RC, LR, CR or CL) & VERTICAL (B or T)

Element Source Laminate	Flintwood	Natural Veneer
324	526	551
350	580	607
372	611	639
397	645	676
420	690	723
437	719	753
625	839	880
648	888	930
697	947	992
709	972	1018
756	1039	1089
767	1051	1101

DIMENSIONS INCHES / MM

H	W
22 / 559	36 / 914
22 / 559	42 / 1067
22 / 559	48 / 1219
22 / 559	54 / 1372
22 / 559	60 / 1524
22 / 559	66 / 1676
22 / 559	72 / 1829
22 / 559	78 / 1981
22 / 559	84 / 2134
22 / 559	90 / 2286
22 / 559	96 / 2438
28 / 711	36 / 914
28 / 711	42 / 1067
28 / 711	48 / 1219
28 / 711	54 / 1372
28 / 711	60 / 1524
28 / 711	66 / 1676
28 / 711	72 / 1829
28 / 711	78 / 1981
28 / 711	84 / 2134
28 / 711	90 / 2286
28 / 711	96 / 2438

PRICING

HORIZONTAL (LL or RR) & VERTICAL (B or T)

Element Source Laminate	Flintwood	Natural Veneer
224	367	385
254	416	436
272	445	464
288	472	494
307	501	525
324	526	551
350	580	607
372	611	639
397	645	676
420	690	723
437	719	753
255	423	442
280	459	482
303	493	517
533	730	764
579	784	821
625	839	880
648	888	930
697	947	992
709	972	1018
756	1039	1089
767	1051	1101

UNEIL

Solid International Power/ Communications Fascia (Clip Mount)

The Solid International Power/Communications Fascia provides face mounted access to power/communications above or below worksurface height.

WHAT'S INCLUDED

1 fascia with cut out as specified, fascia connectors.

WHAT'S EXCLUDED

Panel Wall Rail (UNPHN) is required for additional panel segmentation and must be specified separately. Can be found in the *Panel Walls* section.

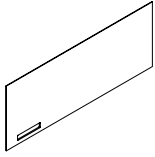

PRODUCT OPTIONS

Outlet Configuration	Horizontal Power/Communications Orientation	Vertical Power/Communications Orientation	Height	Width (6" increments)	Fascia Finish	Bezel Finish
2 Cut Out for two outlets (available on 24" and 30" widths)	B Left and Right (available on 66" width and wider)	B Bottom or lower section of Fascia (available on 7", 13", 22", 37" heights)	07, 13, 21, 22, 27, 28, 37	24 - 96	Element Source Laminate Flintwood Natural Veneer	Black 74 Storm White
3 Cut Out for two outlets and one data/communications box (available on 36" widths and wider)	C Centered (available on 36" width for config. 3 and 4 (available on 24", 30", 36" widths for config. 2)	F Flush (applies to 28" height only for base fascias flush to floor. Cut Out will be at bottom)				
4 Cut Out for four outlets (available on 36" widths and wider)	L Left (not available on widths below 42")	T Top or upper section of Fascia (available on 13", 22", 28" heights)				
5 Call Cut Out for two outlets	R Right (not available on widths below 42")					
6 Call Cut Out for four outlets						

SAMPLE ORDER CODE

UNEIL 3	R	T	22	60	FX	74
----------------	----------	----------	-----------	-----------	-----------	-----------

DIMENSIONS INCHES / MM

H	W
7 / 178	66 / 1676
7 / 178	72 / 1829
7 / 178	78 / 1981
7 / 178	84 / 2134
7 / 178	90 / 2286
7 / 178	96 / 2438
13 / 330	66 / 1676
13 / 330	72 / 1829
13 / 330	78 / 1981
13 / 330	84 / 2134
13 / 330	90 / 2286
13 / 330	96 / 2438
21 / 533	66 / 1676
21 / 533	72 / 1829
21 / 533	78 / 1981
21 / 533	84 / 2134
21 / 533	90 / 2286
21 / 533	96 / 2438

PRICING

CUT OUT OUTLET (2, 3, 4)		
HORIZONTAL (B) & VERTICAL (B)		
Element Source Laminate	Flintwood	Natural Veneer
196	315	330
202	326	341
211	340	356
220	351	367
228	367	385
234	379	397
251	403	423
266	433	455
281	455	477
293	474	496
305	490	513
316	508	532
328	527	551
354	579	606
375	609	638
392	636	666
409	663	695
433	708	741

DIMENSIONS INCHES / MM

H	W
22 / 559	66 / 1676
22 / 559	72 / 1829
22 / 559	78 / 1981
22 / 559	84 / 2134
22 / 559	90 / 2286
22 / 559	96 / 2438
37 / 940	66 / 1676
37 / 940	72 / 1829
37 / 940	78 / 1981
37 / 940	84 / 2134
37 / 940	90 / 2286
37 / 940	96 / 2438

PRICING

CUT OUT OUTLET (2, 3, 4)		
HORIZONTAL (B) & VERTICAL (B) (CONTINUED)		
Element Source Laminate	Flintwood	Natural Veneer
335	537	563
361	591	620
383	624	654
402	653	683
426	697	731
443	726	760
752	1032	1082
758	1057	1107
811	1124	1177
824	1164	1219
838	1177	1233
852	1227	1285

Pricing is continued on the following page.

UN E I L
Solid International
Power/Communications Fascia
(Clip Mount) (Continued)

DIMENSIONS
INCHES / MM

H	W
27 / 686	66 / 1676
27 / 686	72 / 1829
27 / 686	78 / 1981
27 / 686	84 / 2134
27 / 686	90 / 2286
27 / 686	96 / 2438
28 / 711	66 / 1676
28 / 711	72 / 1829
28 / 711	78 / 1981
28 / 711	84 / 2134
28 / 711	90 / 2286
28 / 711	96 / 2438
13 / 330	66 / 1676
13 / 330	72 / 1829
13 / 330	78 / 1981
13 / 330	84 / 2134
13 / 330	90 / 2286
13 / 330	96 / 2438
21 / 533	66 / 1676
21 / 533	72 / 1829
21 / 533	78 / 1981
21 / 533	84 / 2134
21 / 533	90 / 2286
21 / 533	96 / 2438
22 / 559	66 / 1676
22 / 559	72 / 1829
22 / 559	78 / 1981
22 / 559	84 / 2134
22 / 559	90 / 2286
22 / 559	96 / 2438
27 / 686	66 / 1676
27 / 686	72 / 1829
27 / 686	78 / 1981
27 / 686	84 / 2134
27 / 686	90 / 2286
27 / 686	96 / 2438
28 / 711	66 / 1676
28 / 711	72 / 1829
28 / 711	78 / 1981
28 / 711	84 / 2134
28 / 711	90 / 2286
28 / 711	96 / 2438

PRICING

CUT OUT OUTLET (2, 3, 4)		
HORIZONTAL (B) & VERTICAL (F)		
Element Source Laminate	Flintwood	Natural Veneer
621	835	875
645	883	924
694	941	987
706	965	1012
751	1032	1082
763	1044	1094
613	834	873
662	904	947
712	964	1011
730	1006	1055
770	1057	1108
783	1069	1120
HORIZONTAL (B) & VERTICAL (T)		
Element Source Laminate	Flintwood	Natural Veneer
251	403	423
266	433	455
281	455	477
293	474	496
305	490	513
316	508	532
328	527	551
354	579	606
375	609	638
392	636	666
409	663	695
433	708	741
335	537	563
361	591	620
383	624	654
402	653	683
426	697	731
443	726	760
621	835	875
645	883	924
694	941	987
706	965	1012
751	1032	1082
763	1044	1094
613	834	873
662	904	947
712	964	1011
730	1006	1055
770	1057	1108
783	1069	1120

DIMENSIONS
INCHES / MM

H	W
7 / 178	24 / 610
7 / 178	30 / 762
7 / 178	36 / 914
13 / 330	24 / 610
13 / 330	30 / 762
13 / 330	36 / 914
21 / 533	24 / 610
21 / 533	30 / 762
21 / 533	36 / 914
22 / 559	24 / 610
22 / 559	30 / 762
22 / 559	36 / 914
37 / 940	24 / 610
37 / 940	30 / 762
37 / 940	36 / 914
27 / 686	24 / 610
27 / 686	30 / 762
27 / 686	36 / 914
28 / 711	24 / 610
28 / 711	30 / 762
28 / 711	36 / 914
13 / 330	24 / 610
13 / 330	30 / 762
13 / 330	36 / 914
21 / 533	24 / 610
21 / 533	30 / 762
21 / 533	36 / 914
22 / 559	24 / 610
22 / 559	30 / 762
22 / 559	36 / 914
27 / 686	24 / 610
27 / 686	30 / 762
27 / 686	36 / 914
28 / 711	24 / 610
28 / 711	30 / 762
28 / 711	36 / 914

PRICING

CUT OUT OUTLET (2, 3, 4)		
HORIZONTAL (C) & VERTICAL (B)		
Element Source Laminate	Flintwood	Natural Veneer
133	219	228
142	228	238
148	238	251
156	256	270
170	275	286
182	299	312
187	306	322
207	340	356
226	367	384
193	310	326
210	347	361
230	375	391
249	408	428
278	455	476
308	501	525
HORIZONTAL (C) & VERTICAL (F)		
Element Source Laminate	Flintwood	Natural Veneer
207	341	357
230	376	392
256	423	442
210	347	362
233	381	400
260	429	450
HORIZONTAL (C) & VERTICAL (T)		
Element Source Laminate	Flintwood	Natural Veneer
156	256	270
170	275	286
182	299	312
187	306	322
207	340	356
226	367	384
193	310	326
210	347	361
230	375	391
207	341	357
230	376	392
256	423	442
210	347	362
233	381	400
260	429	450

Pricing is continued on the following page.

UNEIL

Solid International Power/Communications Fascia (Clip Mount) (Continued)

DIMENSIONS INCHES / MM

H	W
7 / 178	42 / 1067
7 / 178	48 / 1219
7 / 178	54 / 1372
7 / 178	60 / 1524
7 / 178	66 / 1676
7 / 178	72 / 1829
7 / 178	78 / 1981
7 / 178	84 / 2134
7 / 178	90 / 2286
7 / 178	96 / 2438
13 / 330	42 / 1067
13 / 330	48 / 1219
13 / 330	54 / 1372
13 / 330	60 / 1524
13 / 330	66 / 1676
13 / 330	72 / 1829
13 / 330	78 / 1981
13 / 330	84 / 2134
13 / 330	90 / 2286
13 / 330	96 / 2438
21 / 533	42 / 1067
21 / 533	48 / 1219
21 / 533	54 / 1372
21 / 533	60 / 1524
21 / 533	66 / 1676
21 / 533	72 / 1829
21 / 533	78 / 1981
21 / 533	84 / 2134
21 / 533	90 / 2286
21 / 533	96 / 2438
22 / 559	42 / 1067
22 / 559	48 / 1219
22 / 559	54 / 1372
22 / 559	60 / 1524
22 / 559	66 / 1676
22 / 559	72 / 1829
22 / 559	78 / 1981
22 / 559	84 / 2134
22 / 559	90 / 2286
22 / 559	96 / 2438
37 / 940	42 / 1067
37 / 940	48 / 1219
37 / 940	54 / 1372
37 / 940	60 / 1524
37 / 940	66 / 1676
37 / 940	72 / 1829
37 / 940	78 / 1981
37 / 940	84 / 2134
37 / 940	90 / 2286
37 / 940	96 / 2438

PRICING

CUT OUT OUTLET (2, 3, 4)		
HORIZONTAL (L or R) & VERTICAL (B)		
Element Source Laminate	Flintwood	Natural Veneer
155	252	262
172	275	287
177	285	300
183	297	309
196	315	330
202	326	341
211	340	356
220	351	367
228	367	385
234	379	397
196	318	333
215	349	364
227	366	383
237	383	402
251	403	423
266	433	455
281	455	477
293	474	496
305	490	513
316	508	532
246	397	413
273	441	462
288	468	489
306	494	518
328	527	551
354	579	606
375	609	638
392	636	666
409	663	695
433	708	741
254	416	436
278	451	472
297	479	502
312	506	530
335	537	563
361	591	620
383	624	654
402	653	683
426	697	731
443	726	760
558	758	794
624	836	875
662	902	944
689	944	990
752	1032	1082
758	1057	1107
811	1124	1177
824	1164	1219
838	1177	1233
852	1227	1285

DIMENSIONS INCHES / MM

H	W
27 / 686	42 / 1067
27 / 686	48 / 1219
27 / 686	54 / 1372
27 / 686	60 / 1524
27 / 686	66 / 1676
27 / 686	72 / 1829
27 / 686	78 / 1981
27 / 686	84 / 2134
27 / 686	90 / 2286
27 / 686	96 / 2438
28 / 711	42 / 1067
28 / 711	48 / 1219
28 / 711	54 / 1372
28 / 711	60 / 1524
28 / 711	66 / 1676
28 / 711	72 / 1829
28 / 711	78 / 1981
28 / 711	84 / 2134
28 / 711	90 / 2286
28 / 711	96 / 2438
13 / 330	42 / 1067
13 / 330	48 / 1219
13 / 330	54 / 1372
13 / 330	60 / 1524
13 / 330	66 / 1676
13 / 330	72 / 1829
13 / 330	78 / 1981
13 / 330	84 / 2134
13 / 330	90 / 2286
13 / 330	96 / 2438
21 / 533	42 / 1067
21 / 533	48 / 1219
21 / 533	54 / 1372
21 / 533	60 / 1524
21 / 533	66 / 1676
21 / 533	72 / 1829
21 / 533	78 / 1981
21 / 533	84 / 2134
21 / 533	90 / 2286
21 / 533	96 / 2438

PRICING

CUT OUT OUTLET (2, 3, 4)		
HORIZONTAL (L or R) & VERTICAL (F)		
Element Source Laminate	Flintwood	Natural Veneer
281	459	481
303	493	515
325	527	552
574	778	815
621	835	875
645	883	924
694	941	987
706	965	1012
751	1032	1082
763	1044	1094
286	467	489
308	503	527
544	741	777
588	796	835
613	834	873
662	904	947
712	964	1011
730	1006	1055
770	1057	1108
783	1069	1120
HORIZONTAL (L or R) & VERTICAL (T)		
Element Source Laminate	Flintwood	Natural Veneer
196	318	333
215	349	364
227	366	383
237	383	402
251	403	423
266	433	455
281	455	477
293	474	496
305	490	513
316	508	532
246	397	413
273	441	462
288	468	489
306	494	518
328	527	551
354	579	606
375	609	638
392	636	666
409	663	695
433	708	741

Pricing is continued on the following page.

U N E I L
Solid International
Power/Communications Fascia
(Clip Mount) (Continued)

DIMENSIONS
INCHES / MM

H	W
22 / 559	42 / 1067
22 / 559	48 / 1219
22 / 559	54 / 1372
22 / 559	60 / 1524
22 / 559	66 / 1676
22 / 559	72 / 1829
22 / 559	78 / 1981
22 / 559	84 / 2134
22 / 559	90 / 2286
22 / 559	96 / 2438
27 / 686	42 / 1067
27 / 686	48 / 1219
27 / 686	54 / 1372
27 / 686	60 / 1524
27 / 686	66 / 1676
27 / 686	72 / 1829
27 / 686	78 / 1981
27 / 686	84 / 2134
27 / 686	90 / 2286
27 / 686	96 / 2438
28 / 711	42 / 1067
28 / 711	48 / 1219
28 / 711	54 / 1372
28 / 711	60 / 1524
28 / 711	66 / 1676
28 / 711	72 / 1829
28 / 711	78 / 1981
28 / 711	84 / 2134
28 / 711	90 / 2286
28 / 711	96 / 2438

PRICING

CUT OUT OUTLET (2, 3, 4)		
HORIZONTAL (L or R) & VERTICAL (T) (CONTINUED)		
Element Source Laminate	Flintwood	Natural Veneer
254	416	436
278	451	472
297	479	502
312	506	530
335	537	563
361	591	620
383	624	654
402	653	683
426	697	731
443	726	760
281	459	481
303	493	515
325	527	552
574	778	815
621	835	875
645	883	924
694	941	987
706	965	1012
751	1032	1082
763	1044	1094
286	467	489
308	503	527
544	741	777
588	796	835
613	834	873
662	904	947
712	964	1011
730	1006	1055
770	1057	1108
783	1069	1120

DIMENSIONS
INCHES / MM

H	W
7 / 178	66 / 1676
7 / 178	72 / 1829
7 / 178	78 / 1981
7 / 178	84 / 2134
7 / 178	90 / 2286
7 / 178	96 / 2438
13 / 330	66 / 1676
13 / 330	72 / 1829
13 / 330	78 / 1981
13 / 330	84 / 2134
13 / 330	90 / 2286
13 / 330	96 / 2438
21 / 533	66 / 1676
21 / 533	72 / 1829
21 / 533	78 / 1981
21 / 533	84 / 2134
21 / 533	90 / 2286
21 / 533	96 / 2438
22 / 559	66 / 1676
22 / 559	72 / 1829
22 / 559	78 / 1981
22 / 559	84 / 2134
22 / 559	90 / 2286
22 / 559	96 / 2438
37 / 940	66 / 1676
37 / 940	72 / 1829
37 / 940	78 / 1981
37 / 940	84 / 2134
37 / 940	90 / 2286
37 / 940	96 / 2438

27 / 686	66 / 1676
27 / 686	72 / 1829
27 / 686	78 / 1981
27 / 686	84 / 2134
27 / 686	90 / 2286
27 / 686	96 / 2438
28 / 711	66 / 1676
28 / 711	72 / 1829
28 / 711	78 / 1981
28 / 711	84 / 2134
28 / 711	90 / 2286
28 / 711	96 / 2438

PRICING

CALA CUT OUT FOR TWO OUTLETS (5)		
HORIZONTAL (B) & VERTICAL (B)		
Element Source Laminate	Flintwood	Natural Veneer
223	342	357
229	353	369
238	367	383
247	378	395
255	395	412
261	406	424
278	430	450
295	460	482
308	482	504
321	501	523
332	518	540
344	535	559
355	554	578
381	606	633
402	636	665
420	663	694
436	690	722
460	735	769
362	564	590
388	619	648
410	652	681
429	680	710
453	725	758
471	753	787
780	1059	1109
785	1084	1134
838	1151	1204
852	1191	1246
865	1204	1260
879	1254	1312

HORIZONTAL (B) & VERTICAL (F)		
Element Source Laminate	Flintwood	Natural Veneer
649	862	903
672	910	951
721	968	1014
733	992	1039
778	1059	1109
790	1072	1122
640	861	900
689	931	974
739	991	1038
757	1033	1082
797	1084	1135
810	1097	1148

Pricing is continued on the following page.

UNEIL

Solid International Power/Communications Fascia (Clip Mount) (Continued)

DIMENSIONS INCHES / MM

H	W
13 / 330	66 / 1676
13 / 330	72 / 1829
13 / 330	78 / 1981
13 / 330	84 / 2134
13 / 330	90 / 2286
13 / 330	96 / 2438
21 / 533	66 / 1676
21 / 533	72 / 1829
21 / 533	78 / 1981
21 / 533	84 / 2134
21 / 533	90 / 2286
21 / 533	96 / 2438
22 / 559	66 / 1676
22 / 559	72 / 1829
22 / 559	78 / 1981
22 / 559	84 / 2134
22 / 559	90 / 2286
22 / 559	96 / 2438
27 / 686	66 / 1676
27 / 686	72 / 1829
27 / 686	78 / 1981
27 / 686	84 / 2134
27 / 686	90 / 2286
27 / 686	96 / 2438
28 / 711	66 / 1676
28 / 711	72 / 1829
28 / 711	78 / 1981
28 / 711	84 / 2134
28 / 711	90 / 2286
28 / 711	96 / 2438
7 / 178	24 / 610
7 / 178	30 / 762
7 / 178	36 / 914
13 / 330	24 / 610
13 / 330	30 / 762
13 / 330	36 / 914
21 / 533	24 / 610
21 / 533	30 / 762
21 / 533	36 / 914
22 / 559	24 / 610
22 / 559	30 / 762
22 / 559	36 / 914
37 / 940	24 / 610
37 / 940	30 / 762
37 / 940	36 / 914

PRICING

CALA CUT OUT FOR TWO OUTLETS (5)

HORIZONTAL (B) & VERTICAL (T)

Element Source Laminate	Flintwood	Natural Veneer
278	430	450
295	460	482
308	482	504
321	501	523
332	518	540
344	535	559
355	554	578
381	606	633
402	636	665
420	663	694
436	690	722
460	735	769
362	564	590
388	619	648
410	652	681
429	680	710
453	725	758
471	753	787
649	862	903
672	910	951
721	968	1014
733	992	1039
778	1059	1109
790	1072	1122
640	861	900
689	931	974
739	991	1038
757	1033	1082
797	1084	1135
810	1097	1148

HORIZONTAL (C) & VERTICAL (B)

Element Source Laminate	Flintwood	Natural Veneer
160	246	255
169	255	266
175	266	278
183	283	297
197	302	313
209	326	340
215	333	349
234	367	383
253	395	411
220	337	353
237	374	388
257	402	418
276	435	455
305	482	503
335	528	552

DIMENSIONS INCHES / MM

H	W
27 / 686	24 / 610
27 / 686	30 / 762
27 / 686	36 / 914
28 / 711	24 / 610
28 / 711	30 / 762
28 / 711	36 / 914
13 / 330	24 / 610
13 / 330	30 / 762
13 / 330	36 / 914
21 / 533	24 / 610
21 / 533	30 / 762
21 / 533	36 / 914
22 / 559	24 / 610
22 / 559	30 / 762
22 / 559	36 / 914
27 / 686	24 / 610
27 / 686	30 / 762
27 / 686	36 / 914
28 / 711	24 / 610
28 / 711	30 / 762
28 / 711	36 / 914

7 / 178	42 / 1067
7 / 178	48 / 1219
7 / 178	54 / 1372
7 / 178	60 / 1524
7 / 178	66 / 1676
7 / 178	72 / 1829
7 / 178	78 / 1981
7 / 178	84 / 2134
7 / 178	90 / 2286
7 / 178	96 / 2438

PRICING

CALA CUT OUT FOR TWO OUTLETS (5)

HORIZONTAL (C) & VERTICAL (F)

Element Source Laminate	Flintwood	Natural Veneer
234	369	384
257	403	420
283	450	469
237	374	389
260	408	427
287	456	477
183	283	297
197	302	313
209	326	340
215	333	349
234	367	383
253	395	411
220	337	353
237	374	388
257	402	418
234	369	384
257	403	420
283	450	469
237	374	389
260	408	427
287	456	477

HORIZONTAL (L or R) & VERTICAL (B)

Element Source Laminate	Flintwood	Natural Veneer
182	279	290
199	302	315
204	312	327
210	324	336
223	342	357
229	353	369
238	367	383
247	378	395
255	395	412
261	406	424

Pricing is continued on the following page.

UN EIL
Solid International
Power/Communications Fascia
(Clip Mount) (Continued)

DIMENSIONS
INCHES / MM

H	W
13 / 330	42 / 1067
13 / 330	48 / 1219
13 / 330	54 / 1372
13 / 330	60 / 1524
13 / 330	66 / 1676
13 / 330	72 / 1829
13 / 330	78 / 1981
13 / 330	84 / 2134
13 / 330	90 / 2286
13 / 330	96 / 2438
21 / 533	42 / 1067
21 / 533	48 / 1219
21 / 533	54 / 1372
21 / 533	60 / 1524
21 / 533	66 / 1676
21 / 533	72 / 1829
21 / 533	78 / 1981
21 / 533	84 / 2134
21 / 533	90 / 2286
21 / 533	96 / 2438
22 / 559	42 / 1067
22 / 559	48 / 1219
22 / 559	54 / 1372
22 / 559	60 / 1524
22 / 559	66 / 1676
22 / 559	72 / 1829
22 / 559	78 / 1981
22 / 559	84 / 2134
22 / 559	90 / 2286
22 / 559	96 / 2438
37 / 940	42 / 1067
37 / 940	48 / 1219
37 / 940	54 / 1372
37 / 940	60 / 1524
37 / 940	66 / 1676
37 / 940	72 / 1829
37 / 940	78 / 1981
37 / 940	84 / 2134
37 / 940	90 / 2286
37 / 940	96 / 2438

PRICING

CALA CUT OUT FOR TWO OUTLETS (5)
HORIZONTAL (L or R) & VERTICAL (B)
(CONTINUED)

Element Source Laminate	Flintwood	Natural Veneer
223	346	360
244	376	392
254	393	410
265	410	429
278	430	450
295	460	482
308	482	504
321	501	523
332	518	540
344	535	559
273	424	441
300	468	489
316	496	517
333	522	545
355	554	578
381	606	633
402	636	665
420	663	694
436	690	722
460	735	769
281	443	463
305	478	500
324	506	529
340	533	557
362	564	590
388	619	648
410	652	681
429	680	710
453	725	758
471	753	787
585	785	821
652	863	903
689	929	972
716	972	1017
780	1059	1109
785	1084	1134
838	1151	1204
852	1191	1246
865	1204	1260
879	1254	1312

DIMENSIONS
INCHES / MM

H	W
27 / 686	42 / 1067
27 / 686	48 / 1219
27 / 686	54 / 1372
27 / 686	60 / 1524
27 / 686	66 / 1676
27 / 686	72 / 1829
27 / 686	78 / 1981
27 / 686	84 / 2134
27 / 686	90 / 2286
27 / 686	96 / 2438
28 / 711	42 / 1067
28 / 711	48 / 1219
28 / 711	54 / 1372
28 / 711	60 / 1524
28 / 711	66 / 1676
28 / 711	72 / 1829
28 / 711	78 / 1981
28 / 711	84 / 2134
28 / 711	90 / 2286
28 / 711	96 / 2438
13 / 330	42 / 1067
13 / 330	48 / 1219
13 / 330	54 / 1372
13 / 330	60 / 1524
13 / 330	66 / 1676
13 / 330	72 / 1829
13 / 330	78 / 1981
13 / 330	84 / 2134
13 / 330	90 / 2286
13 / 330	96 / 2438
21 / 533	42 / 1067
21 / 533	48 / 1219
21 / 533	54 / 1372
21 / 533	60 / 1524
21 / 533	66 / 1676
21 / 533	72 / 1829
21 / 533	78 / 1981
21 / 533	84 / 2134
21 / 533	90 / 2286
21 / 533	96 / 2438
22 / 559	42 / 1067

PRICING

CALA CUT OUT FOR TWO OUTLETS (5)
HORIZONTAL (L or R) & VERTICAL (F)

Element Source Laminate	Flintwood	Natural Veneer
308	486	508
330	521	543
352	554	579
602	806	842
649	862	903
672	910	951
721	968	1014
733	992	1039
778	1059	1109
790	1072	1122
313	494	517
335	530	554
572	769	804
615	823	862
640	861	900
689	931	974
739	991	1038
757	1033	1082
797	1084	1135
810	1097	1148
223	346	360
244	376	392
254	393	410
265	410	429
278	430	450
295	460	482
308	482	504
321	501	523
332	518	540
344	535	559
273	424	441
300	468	489
316	496	517
333	522	545
355	554	578
381	606	633
402	636	665
420	663	694
436	690	722
460	735	769
281	443	463

Pricing is continued on the following page.

U N E I L

Solid International Power/Communications Fascia (Clip Mount) (Continued)

DIMENSIONS INCHES / MM

H	W
22 / 559	48 / 1219
22 / 559	54 / 1372
22 / 559	60 / 1524
22 / 559	66 / 1676
22 / 559	72 / 1829
22 / 559	78 / 1981
22 / 559	84 / 2134
22 / 559	90 / 2286
22 / 559	96 / 2438
27 / 686	42 / 1067
27 / 686	48 / 1219
27 / 686	54 / 1372
27 / 686	60 / 1524
27 / 686	66 / 1676
27 / 686	72 / 1829
27 / 686	78 / 1981
27 / 686	84 / 2134
27 / 686	90 / 2286
27 / 686	96 / 2438
28 / 711	42 / 1067
28 / 711	48 / 1219
28 / 711	54 / 1372
28 / 711	60 / 1524
28 / 711	66 / 1676
28 / 711	72 / 1829
28 / 711	78 / 1981
28 / 711	84 / 2134
28 / 711	90 / 2286
28 / 711	96 / 2438
13 / 330	66 / 1676
13 / 330	72 / 1829
13 / 330	78 / 1981
13 / 330	84 / 2134
13 / 330	90 / 2286
13 / 330	96 / 2438

PRICING

CALA CUT OUT FOR TWO OUTLETS (5)

HORIZONTAL (L or R) & VERTICAL (T) (CONTINUED)

Element Source Laminate	Flintwood	Natural Veneer
305	478	500
324	506	529
340	533	557
362	564	590
388	619	648
410	652	681
429	680	710
453	725	758
471	753	787
308	486	508
330	521	543
352	554	579
602	806	842
649	862	903
672	910	951
721	968	1014
733	992	1039
778	1059	1109
790	1072	1122
313	494	517
335	530	554
572	769	804
615	823	862
640	861	900
689	931	974
739	991	1038
757	1033	1082
797	1084	1135
810	1097	1148

CALA CUT OUT FOR FOUR OUTLETS (6)

HORIZONTAL (B) & VERTICAL (B)

Element Source Laminate	Flintwood	Natural Veneer
229	350	363
235	359	376
247	375	389
253	384	402
261	402	420
270	412	430
284	436	456
301	467	488
315	488	510
327	507	530
338	526	548
351	542	565

DIMENSIONS INCHES / MM

H	W
21 / 533	66 / 1676
21 / 533	72 / 1829
21 / 533	78 / 1981
21 / 533	84 / 2134
21 / 533	90 / 2286
21 / 533	96 / 2438
22 / 559	66 / 1676
22 / 559	72 / 1829
22 / 559	78 / 1981
22 / 559	84 / 2134
22 / 559	90 / 2286
22 / 559	96 / 2438
37 / 940	66 / 1676
37 / 940	72 / 1829
37 / 940	78 / 1981
37 / 940	84 / 2134
37 / 940	90 / 2286
37 / 940	96 / 2438
27 / 686	66 / 1676
27 / 686	72 / 1829
27 / 686	78 / 1981
27 / 686	84 / 2134
27 / 686	90 / 2286
27 / 686	96 / 2438
28 / 711	66 / 1676
28 / 711	72 / 1829
28 / 711	78 / 1981
28 / 711	84 / 2134
28 / 711	90 / 2286
28 / 711	96 / 2438
13 / 330	66 / 1676
13 / 330	72 / 1829
13 / 330	78 / 1981
13 / 330	84 / 2134
13 / 330	90 / 2286
13 / 330	96 / 2438
21 / 533	66 / 1676
21 / 533	72 / 1829
21 / 533	78 / 1981
21 / 533	84 / 2134
21 / 533	90 / 2286
21 / 533	96 / 2438

PRICING

CALA CUT OUT FOR FOUR OUTLETS (6)

HORIZONTAL (B) & VERTICAL (B) (CONTINUED)

Element Source Laminate	Flintwood	Natural Veneer
361	560	584
387	612	639
408	643	672
427	670	701
443	697	730
467	741	776
370	572	598
397	627	655
417	658	687
435	686	716
459	732	764
478	760	794
786	1066	1116
791	1091	1141
845	1158	1211
859	1198	1253
872	1211	1267
886	1261	1319

HORIZONTAL (B) & VERTICAL (F)

Element Source Laminate	Flintwood	Natural Veneer
656	868	910
680	916	959
729	975	1021
739	999	1045
785	1066	1116
797	1078	1128
648	867	908
696	938	981
746	998	1044
763	1040	1089
804	1091	1142
816	1103	1154
284	436	456
301	467	488
315	488	510
327	507	530
338	526	548
351	542	565
361	560	584
387	612	639
408	643	672
427	670	701
443	697	730
467	741	776

Pricing is continued on the following page.

U N E I L
**Solid International
 Power/Communications Fascia
 (Clip Mount) (Continued)**

**DIMENSIONS
 INCHES / MM**

H	W
22 / 559	66 / 1676
22 / 559	72 / 1829
22 / 559	78 / 1981
22 / 559	84 / 2134
22 / 559	90 / 2286
22 / 559	96 / 2438
27 / 686	66 / 1676
27 / 686	72 / 1829
27 / 686	78 / 1981
27 / 686	84 / 2134
27 / 686	90 / 2286
27 / 686	96 / 2438
28 / 711	66 / 1676
28 / 711	72 / 1829
28 / 711	78 / 1981
28 / 711	84 / 2134
28 / 711	90 / 2286
28 / 711	96 / 2438

PRICING

CALA CUT OUT FOR FOUR OUTLETS (6)

HORIZONTAL (B) & VERTICAL (T)

Element Source Laminate	Flintwood	Natural Veneer
370	572	598
397	627	655
417	658	687
435	686	716
459	732	764
478	760	794
656	868	910
680	916	959
729	975	1021
739	999	1045
785	1066	1116
797	1078	1128
648	867	908
696	938	981
746	998	1044
763	1040	1089
804	1091	1142
816	1103	1154

HORIZONTAL (C) & VERTICAL (B)

H	W	Element Source Laminate	Flintwood	Natural Veneer
7 / 178	36 / 914	181	274	284
13 / 330	36 / 914	218	332	348
21 / 533	36 / 914	259	402	418
22 / 559	36 / 914	263	408	426
37 / 940	36 / 914	342	534	558

HORIZONTAL (C) & VERTICAL (F)

H	W	Element Source Laminate	Flintwood	Natural Veneer
27 / 686	36 / 914	290	456	477
28 / 711	36 / 914	296	62	483

HORIZONTAL (C) & VERTICAL (T)

H	W	Element Source Laminate	Flintwood	Natural Veneer
13 / 330	36 / 914	218	332	348
21 / 533	36 / 914	259	402	418
22 / 559	36 / 914	263	408	426
27 / 686	36 / 914	290	456	477
28 / 711	36 / 914	296	462	483

**DIMENSIONS
 INCHES / MM**

H	W
7 / 178	42 / 1067
7 / 178	48 / 1219
7 / 178	54 / 1372
7 / 178	60 / 1524
7 / 178	66 / 1676
7 / 178	72 / 1829
7 / 178	78 / 1981
7 / 178	84 / 2134
7 / 178	90 / 2286
7 / 178	96 / 2438
13 / 330	42 / 1067
13 / 330	48 / 1219
13 / 330	54 / 1372
13 / 330	60 / 1524
13 / 330	66 / 1676
13 / 330	72 / 1829
13 / 330	78 / 1981
13 / 330	84 / 2134
13 / 330	90 / 2286
13 / 330	96 / 2438

21 / 533	42 / 1067
21 / 533	48 / 1219
21 / 533	54 / 1372
21 / 533	60 / 1524
21 / 533	66 / 1676
21 / 533	72 / 1829
21 / 533	78 / 1981
21 / 533	84 / 2134
21 / 533	90 / 2286
21 / 533	96 / 2438

22 / 559	42 / 1067
22 / 559	48 / 1219
22 / 559	54 / 1372
22 / 559	60 / 1524
22 / 559	66 / 1676
22 / 559	72 / 1829
22 / 559	78 / 1981
22 / 559	84 / 2134
22 / 559	90 / 2286
22 / 559	96 / 2438

37 / 940	42 / 1067
37 / 940	48 / 1219
37 / 940	54 / 1372
37 / 940	60 / 1524
37 / 940	66 / 1676
37 / 940	72 / 1829
37 / 940	78 / 1981
37 / 940	84 / 2134
37 / 940	90 / 2286
37 / 940	96 / 2438

PRICING

CALA CUT OUT FOR FOUR OUTLETS (6)

HORIZONTAL (L or R) & VERTICAL (B)

Element Source Laminate	Flintwood	Natural Veneer
189	285	298
205	308	323
210	321	333
219	330	344
229	350	363
235	359	376
247	375	389
253	384	402
261	402	420
270	412	430
229	352	367
250	382	400
260	401	417
273	417	435
284	436	456
301	467	488
315	488	510
327	507	530
338	526	548
351	542	565

279	430	449
306	476	497
324	503	525
340	529	553
361	560	584
387	612	639
408	643	672
427	670	701
443	697	730
467	741	776

287	451	471
311	484	506
330	512	535
348	539	563
370	572	598
397	627	655
417	658	687
435	686	716
459	732	764
478	760	794

591	791	828
658	870	910
696	936	979
723	979	1024
786	1066	1116
791	1091	1141
845	1158	1211
859	1198	1253
872	1211	1267
886	1261	1319

Pricing is continued on the following page.

U N E I L

Solid International Power/Communications Fascia (Clip Mount) (Continued)

DIMENSIONS INCHES / MM

H	W
27 / 686	42 / 1067
27 / 686	48 / 1219
27 / 686	54 / 1372
27 / 686	60 / 1524
27 / 686	66 / 1676
27 / 686	72 / 1829
27 / 686	78 / 1981
27 / 686	84 / 2134
27 / 686	90 / 2286
27 / 686	96 / 2438

28 / 711	42 / 1067
28 / 711	48 / 1219
28 / 711	54 / 1372
28 / 711	60 / 1524
28 / 711	66 / 1676
28 / 711	72 / 1829
28 / 711	78 / 1981
28 / 711	84 / 2134
28 / 711	90 / 2286
28 / 711	96 / 2438

13 / 330	42 / 1067
13 / 330	48 / 1219
13 / 330	54 / 1372
13 / 330	60 / 1524
13 / 330	66 / 1676
13 / 330	72 / 1829
13 / 330	78 / 1981
13 / 330	84 / 2134
13 / 330	90 / 2286
13 / 330	96 / 2438

21 / 533	42 / 1067
21 / 533	48 / 1219
21 / 533	54 / 1372
21 / 533	60 / 1524
21 / 533	66 / 1676
21 / 533	72 / 1829
21 / 533	78 / 1981
21 / 533	84 / 2134
21 / 533	90 / 2286
21 / 533	96 / 2438

PRICING

CALA CUT OUT FOR FOUR OUTLETS (6)

HORIZONTAL (L or R) & VERTICAL (F)

Element Source Laminate	Flintwood	Natural Veneer
315	493	514
336	528	551
358	560	585
608	812	849
656	868	910
680	916	959
729	975	1021
739	999	1045
785	1066	1116
797	1078	1128

322	502	525
342	536	560
579	776	811
623	831	868
648	867	908
696	938	981
746	998	1044
763	1040	1089
804	1091	1142
816	1103	1154

HORIZONTAL (L or R) & VERTICAL (T)

Element Source Laminate	Flintwood	Natural Veneer
229	352	367
250	382	400
260	401	417
273	417	435
284	436	456
301	467	488
315	488	510
327	507	530
338	526	548
351	542	565

279	430	449
306	476	497
324	503	525
340	529	553
361	560	584
387	612	639
408	643	672
427	670	701
443	697	730
467	741	776

DIMENSIONS INCHES / MM

H	W
22 / 559	42 / 1067
22 / 559	48 / 1219
22 / 559	54 / 1372
22 / 559	60 / 1524
22 / 559	66 / 1676
22 / 559	72 / 1829
22 / 559	78 / 1981
22 / 559	84 / 2134
22 / 559	90 / 2286
22 / 559	96 / 2438

27 / 686	42 / 1067
27 / 686	48 / 1219
27 / 686	54 / 1372
27 / 686	60 / 1524
27 / 686	66 / 1676
27 / 686	72 / 1829
27 / 686	78 / 1981
27 / 686	84 / 2134
27 / 686	90 / 2286
27 / 686	96 / 2438

28 / 711	42 / 1067
28 / 711	48 / 1219
28 / 711	54 / 1372
28 / 711	60 / 1524
28 / 711	66 / 1676
28 / 711	72 / 1829
28 / 711	78 / 1981
28 / 711	84 / 2134
28 / 711	90 / 2286
28 / 711	96 / 2438

PRICING

CALA CUT OUT FOR FOUR OUTLETS (6)

HORIZONTAL (L or R) & VERTICAL (T) (CONTINUED)

Element Source Laminate	Flintwood	Natural Veneer
287	451	471
311	484	506
330	512	535
348	539	563
370	572	598
397	627	655
417	658	687
435	686	716
459	732	764
478	760	794

315	493	514
336	528	551
358	560	585
608	812	849
656	868	910
680	916	959
729	975	1021
739	999	1045
785	1066	1116
797	1078	1128

322	502	525
342	536	560
579	776	811
623	831	868
648	867	908
696	938	981
746	998	1044
763	1040	1089
804	1091	1142
816	1103	1154

UAEIL

Solid International Power/ Communications Fascia for Freestanding District (Clip Mount)

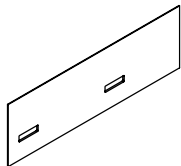

The Solid International Power/Communications Fascia provides face-mounted access to power/communications.

WHAT'S INCLUDED

1 fascia with cut out as specified, fascia connectors.

NOTES

Not all height/width combinations are available. See pricing for exact offering.

Fascia is to only be applied to District Panel that is supported by the Freestanding Foot (UAFFN).

The 21" and 22" fascias must be ordered with a 6" high fascia as Elevated panels are not applicable in a freestanding application.

For 36" to 60" wide fascias only Left (LL) or Right (RR) power and data locations can be specified.

PRODUCT OPTIONS

Outlet Configuration	Horizontal Power/ Communication Orientation	Vertical Power/ Communication Orientation	Height	Width (6" increments)	Fascia Finish	Bezel Finish
2 Cut Out for two outlets (available on 24" and 30" widths)	LL Left	T Top	21, 22, 27, 28, 35	36 - 96	Element Source Laminate Flintwood Natural Veneer	~ Black
	LC Left Centre	B Bottom				74 Storm White
3 Cut Out for two outlets and one data/communications box (available on 36" widths and wider)	RC Right Centre					
	RR Right					
	LR Left & Right					
4 Cut Out for four outlets (available on 36" widths and wider)	CR Left Centre and Right					
	CL Right Centre and Left					
5 Cala Cut Out for two outlets						
6 Cala Cut Out for four outlets						

SAMPLE ORDER CODE

UAEIL 3	CR	T	22	60	FX	74
----------------	-----------	----------	-----------	-----------	-----------	-----------

DIMENSIONS INCHES / MM

H	W
21 / 533	66 / 1676
21 / 533	72 / 1829
21 / 533	78 / 1981
21 / 533	84 / 2134
21 / 533	90 / 2286
21 / 533	96 / 2438
22 / 559	66 / 1676
22 / 559	72 / 1829
22 / 559	78 / 1981
22 / 559	84 / 2134
22 / 559	90 / 2286
22 / 559	96 / 2438
27 / 686	66 / 1676
27 / 686	72 / 1829
27 / 686	78 / 1981
27 / 686	84 / 2134
27 / 686	90 / 2286
27 / 686	96 / 2438

PRICING

CUT OUT OUTLET (2, 3, 4)		
HORIZONTAL (LC, RC, LR, CR or CL) & VERTICAL (B or T)		
Element Source Laminate	Flintwood	Natural Veneer
315	513	537
341	565	593
361	596	625
385	631	660
404	658	688
427	702	735
324	526	551
350	580	607
372	611	639
397	645	676
420	690	723
437	719	753
608	820	859
631	866	909
680	924	968
690	948	993
735	1014	1063
773	1063	1114

DIMENSIONS INCHES / MM

H	W
28 / 711	66 / 1676
28 / 711	72 / 1829
28 / 711	78 / 1981
28 / 711	84 / 2134
28 / 711	90 / 2286
28 / 711	96 / 2438
35 / 889	66 / 1676
35 / 889	72 / 1829
35 / 889	78 / 1981
35 / 889	84 / 2134
35 / 889	90 / 2286
35 / 889	96 / 2438

PRICING

CUT OUT OUTLET (2, 3, 4)		
HORIZONTAL (LC, RC, LR, CR or CL) & VERTICAL (B or T) (Continued)		
Element Source Laminate	Flintwood	Natural Veneer
625	839	880
648	888	930
697	947	992
709	972	1018
756	1039	1089
767	1051	1101
712	973	1019
769	1053	1103
775	1077	1128
788	1091	1142
827	1180	1236
839	1194	1250

Pricing is continued on the following page.

UAEIL

**Solid International Power/
Communications Fascia for
Freestanding District (Clip Mount)
(Continued)**

**DIMENSIONS
INCHES / MM**

H	W
21 / 533	36 / 914
21 / 533	42 / 1067
21 / 533	48 / 1219
21 / 533	54 / 1372
21 / 533	60 / 1524
21 / 533	66 / 1676
21 / 533	72 / 1829
21 / 533	78 / 1981
21 / 533	84 / 2134
21 / 533	90 / 2286
21 / 533	96 / 2438
22 / 559	36 / 914
22 / 559	42 / 1067
22 / 559	48 / 1219
22 / 559	54 / 1372
22 / 559	60 / 1524
22 / 559	66 / 1676
22 / 559	72 / 1829
22 / 559	78 / 1981
22 / 559	84 / 2134
22 / 559	90 / 2286
22 / 559	96 / 2438
27 / 686	36 / 914
27 / 686	42 / 1067
27 / 686	48 / 1219
27 / 686	54 / 1372
27 / 686	60 / 1524
27 / 686	66 / 1676
27 / 686	72 / 1829
27 / 686	78 / 1981
27 / 686	84 / 2134
27 / 686	90 / 2286
27 / 686	96 / 2438
28 / 711	36 / 914
28 / 711	42 / 1067
28 / 711	48 / 1219
28 / 711	54 / 1372
28 / 711	60 / 1524
28 / 711	66 / 1676
28 / 711	72 / 1829
28 / 711	78 / 1981
28 / 711	84 / 2134
28 / 711	90 / 2286
28 / 711	96 / 2438

PRICING

CUT OUT OUTLET (2, 3, 4)		
HORIZONTAL (LL or RR) & VERTICAL (B or T)		
Element Source Laminate	Flintwood	Natural Veneer
221	360	378
246	397	413
265	435	456
283	461	484
301	488	511
315	513	537
341	565	593
361	596	625
385	631	660
404	658	688
427	702	735
224	367	385
254	416	436
272	445	464
288	472	494
307	501	525
324	526	551
350	580	607
372	611	639
397	645	676
420	690	723
437	719	753
251	414	435
276	453	474
298	485	508
318	518	542
562	765	802
608	820	859
631	866	909
680	924	968
690	948	993
735	1014	1063
773	1063	1114
255	423	442
280	459	482
303	493	517
533	730	764
579	784	821
625	839	880
648	888	930
697	947	992
709	972	1018
756	1039	1089
767	1051	1101

**DIMENSIONS
INCHES / MM**

H	W
35 / 889	36 / 914
35 / 889	42 / 1067
35 / 889	48 / 1219
35 / 889	54 / 1372
35 / 889	60 / 1524
35 / 889	66 / 1676
35 / 889	72 / 1829
35 / 889	78 / 1981
35 / 889	84 / 2134
35 / 889	90 / 2286
35 / 889	96 / 2438
21 / 533	66 / 1676
21 / 533	72 / 1829
21 / 533	78 / 1981
21 / 533	84 / 2134
21 / 533	90 / 2286
21 / 533	96 / 2438
22 / 559	66 / 1676
22 / 559	72 / 1829
22 / 559	78 / 1981
22 / 559	84 / 2134
22 / 559	90 / 2286
22 / 559	96 / 2438
27 / 686	66 / 1676
27 / 686	72 / 1829
27 / 686	78 / 1981
27 / 686	84 / 2134
27 / 686	90 / 2286
27 / 686	96 / 2438
28 / 711	66 / 1676
28 / 711	72 / 1829
28 / 711	78 / 1981
28 / 711	84 / 2134
28 / 711	90 / 2286
28 / 711	96 / 2438
35 / 889	66 / 1676
35 / 889	72 / 1829
35 / 889	78 / 1981
35 / 889	84 / 2134
35 / 889	90 / 2286
35 / 889	96 / 2438

PRICING

CUT OUT OUTLET (2, 3, 4)		
HORIZONTAL (LL or RR) & VERTICAL (B or T) (Continued)		
Element Source Laminate	Flintwood	Natural Veneer
298	484	507
540	736	771
598	804	842
630	850	890
688	934	977
712	973	1019
769	1053	1103
775	1077	1128
788	1091	1142
827	1180	1236
839	1194	1250
342	540	564
369	593	620
388	624	653
412	658	687
431	685	715
454	730	762
351	553	578
377	607	634
399	638	666
424	672	704
448	717	751
464	746	781
635	847	886
658	893	936
707	951	996
717	975	1021
762	1041	1090
801	1090	1141
653	866	908
675	915	957
725	974	1019
736	999	1045
783	1066	1116
795	1078	1128
739	1000	1047
796	1081	1131
802	1105	1156
815	1118	1169
854	1208	1263
866	1221	1277

CALA CUT OUT FOR TWO OUTLETS (5)
HORIZONTAL (LC, RC, LR, CR or CL) & VERTICAL (B or T)

Pricing is continued on the following page.

U A E I L

**Solid International Power/
Communications Fascia for
Freestanding District (Clip Mount)
(Continued)**

**DIMENSIONS
INCHES / MM**

H	W
21 / 533	36 / 914
21 / 533	42 / 1067
21 / 533	48 / 1219
21 / 533	54 / 1372
21 / 533	60 / 1524
21 / 533	66 / 1676
21 / 533	72 / 1829
21 / 533	78 / 1981
21 / 533	84 / 2134
21 / 533	90 / 2286
21 / 533	96 / 2438
22 / 559	36 / 914
22 / 559	42 / 1067
22 / 559	48 / 1219
22 / 559	54 / 1372
22 / 559	60 / 1524
22 / 559	66 / 1676
22 / 559	72 / 1829
22 / 559	78 / 1981
22 / 559	84 / 2134
22 / 559	90 / 2286
22 / 559	96 / 2438
27 / 686	36 / 914
27 / 686	42 / 1067
27 / 686	48 / 1219
27 / 686	54 / 1372
27 / 686	60 / 1524
27 / 686	66 / 1676
27 / 686	72 / 1829
27 / 686	78 / 1981
27 / 686	84 / 2134
27 / 686	90 / 2286
27 / 686	96 / 2438
28 / 711	36 / 914
28 / 711	42 / 1067
28 / 711	48 / 1219
28 / 711	54 / 1372
28 / 711	60 / 1524
28 / 711	66 / 1676
28 / 711	72 / 1829
28 / 711	78 / 1981
28 / 711	84 / 2134
28 / 711	90 / 2286
28 / 711	96 / 2438

PRICING

CALA CUT OUT FOR TWO OUTLETS (5)		
HORIZONTAL (LL or RR) & VERTICAL (B or T)		
Element Source Laminate	Flintwood	Natural Veneer
248	387	405
273	424	441
293	462	483
310	488	511
328	515	538
342	540	564
369	593	620
388	624	653
412	658	687
431	685	715
454	730	762
251	395	412
281	443	463
299	472	492
316	500	522
334	528	552
351	553	578
377	607	634
399	638	666
424	672	704
448	717	751
464	746	781
278	442	462
303	480	501
325	512	535
346	545	569
589	792	829
635	847	886
658	893	936
707	951	996
717	975	1021
762	1041	1090
801	1090	1141
282	450	469
307	486	509
330	521	544
560	757	791
606	811	848
653	866	908
675	915	957
725	974	1019
736	999	1045
783	1066	1116
795	1078	1128

**DIMENSIONS
INCHES / MM**

H	W
35 / 889	36 / 914
35 / 889	42 / 1067
35 / 889	48 / 1219
35 / 889	54 / 1372
35 / 889	60 / 1524
35 / 889	66 / 1676
35 / 889	72 / 1829
35 / 889	78 / 1981
35 / 889	84 / 2134
35 / 889	90 / 2286
35 / 889	96 / 2438
21 / 533	66 / 1676
21 / 533	72 / 1829
21 / 533	78 / 1981
21 / 533	84 / 2134
21 / 533	90 / 2286
21 / 533	96 / 2438
22 / 559	66 / 1676
22 / 559	72 / 1829
22 / 559	78 / 1981
22 / 559	84 / 2134
22 / 559	90 / 2286
22 / 559	96 / 2438
27 / 686	66 / 1676
27 / 686	72 / 1829
27 / 686	78 / 1981
27 / 686	84 / 2134
27 / 686	90 / 2286
27 / 686	96 / 2438
28 / 711	66 / 1676
28 / 711	72 / 1829
28 / 711	78 / 1981
28 / 711	84 / 2134
28 / 711	90 / 2286
28 / 711	96 / 2438
35 / 889	66 / 1676
35 / 889	72 / 1829
35 / 889	78 / 1981
35 / 889	84 / 2134
35 / 889	90 / 2286
35 / 889	96 / 2438

PRICING

CALA CUT OUT FOR TWO OUTLETS (5)		
HORIZONTAL (LL or RR) & VERTICAL (B or T) (Continued)		
Element Source Laminate	Flintwood	Natural Veneer
325	511	534
568	763	798
625	832	870
657	878	917
715	961	1005
739	1000	1047
796	1081	1131
802	1105	1156
815	1118	1169
854	1208	1263
866	1221	1277
CALA CUT OUT FOR FOUR OUTLETS (6)		
HORIZONTAL (LC, RC, LR, CR or CL) & VERTICAL (B or T)		
Element Source Laminate	Flintwood	Natural Veneer
350	548	572
376	601	628
397	631	659
420	664	694
437	691	722
460	736	769
357	559	584
383	613	640
405	645	674
430	680	710
454	725	758
472	753	787
641	854	892
664	900	942
713	959	1002
725	982	1027
769	1048	1097
808	1097	1148
659	873	914
682	922	964
732	981	1026
742	1006	1052
789	1073	1123
802	1086	1135
746	1007	1053
803	1088	1138
809	1112	1163
822	1125	1176
861	1215	1270
873	1228	1284

Pricing is continued on the following page.

UAEIL

**Solid International Power/
Communications Fascia for
Freestanding District (Clip Mount)
(Continued)**

**DIMENSIONS
INCHES / MM**

H	W
21 / 533	36 / 914
21 / 533	42 / 1067
21 / 533	48 / 1219
21 / 533	54 / 1372
21 / 533	60 / 1524
21 / 533	66 / 1676
21 / 533	72 / 1829
21 / 533	78 / 1981
21 / 533	84 / 2134
21 / 533	90 / 2286
21 / 533	96 / 2438
22 / 559	36 / 914
22 / 559	42 / 1067
22 / 559	48 / 1219
22 / 559	54 / 1372
22 / 559	60 / 1524
22 / 559	66 / 1676
22 / 559	72 / 1829
22 / 559	78 / 1981
22 / 559	84 / 2134
22 / 559	90 / 2286
22 / 559	96 / 2438
27 / 686	36 / 914
27 / 686	42 / 1067
27 / 686	48 / 1219
27 / 686	54 / 1372
27 / 686	60 / 1524
27 / 686	66 / 1676
27 / 686	72 / 1829
27 / 686	78 / 1981
27 / 686	84 / 2134
27 / 686	90 / 2286
27 / 686	96 / 2438
28 / 711	36 / 914
28 / 711	42 / 1067
28 / 711	48 / 1219
28 / 711	54 / 1372
28 / 711	60 / 1524
28 / 711	66 / 1676
28 / 711	72 / 1829
28 / 711	78 / 1981
28 / 711	84 / 2134
28 / 711	90 / 2286
28 / 711	96 / 2438

PRICING

CALA CUT OUT FOR FOUR OUTLETS (6)		
HORIZONTAL (LL or RR) & VERTICAL (B or T)		
Element Source Laminate	Flintwood	Natural Veneer
254	395	411
279	430	449
300	469	489
318	496	518
334	523	545
350	548	572
376	601	628
397	631	659
420	664	694
437	691	722
460	736	769
257	402	420
287	451	471
305	479	500
324	506	529
341	534	558
357	559	584
383	613	640
405	645	674
430	680	710
454	725	758
472	753	787
284	450	469
309	486	507
331	519	542
352	553	577
596	799	836
641	854	892
664	900	942
713	959	1002
725	982	1027
769	1048	1097
808	1097	1148
288	456	477
313	493	515
336	528	552
567	763	798
612	817	855
659	873	914
682	922	964
732	981	1026
742	1006	1052
789	1073	1123
802	1086	1135

**DIMENSIONS
INCHES / MM**

H	W
35 / 889	36 / 914
35 / 889	42 / 1067
35 / 889	48 / 1219
35 / 889	54 / 1372
35 / 889	60 / 1524
35 / 889	66 / 1676
35 / 889	72 / 1829
35 / 889	78 / 1981
35 / 889	84 / 2134
35 / 889	90 / 2286
35 / 889	96 / 2438

PRICING

CALA CUT OUT FOR FOUR OUTLETS (6)		
HORIZONTAL (LL or RR) & VERTICAL (B or T) (Continued)		
Element Source Laminate	Flintwood	Natural Veneer
331	518	540
576	770	806
632	838	877
663	885	924
722	967	1012
746	1007	1053
803	1088	1138
809	1112	1163
822	1125	1176
861	1215	1270
873	1228	1284

UNELCM

Metal Power/Communications Fascia (Slot Mount)

The Metal Power/Communications Fascia provides face-mounted access to power/communications above or below worksurface height.

WHAT'S INCLUDED

1 fascia with cut out as specified.

WHAT'S EXCLUDED

Fascia Light Block (UNEX) is required for additional segmentation and must be specified separately. Can be found in the *Panel Walls* section.

NOTES

37" high fascia can be specified to a maximum of 60" width only.

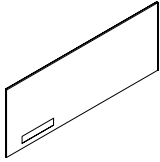

PRODUCT OPTIONS

Outlet Configuration	Horizontal Power/Communications Orientation	Vertical Power/Communications Orientation	Height	Width (6" increments)	Fascia Finish
2 One duplex outlet plus VDM (available on 24" and 30" widths)	B Left and Right (available on 66" width and wider for one and two duplex outlets)	B Bottom or Lower section of Fascia (available on 7", 13", 22", 26", 37" heights)	07, 13, 22, 26, 28, 37	24 - 96	Foundation Mica
4 Two duplex outlets plus VDM (available on 36" widths and wider)	C Centered (available on 36" width for two duplex outlets and on 24", 30", 36" widths for one duplex outlet)	F Flush (applies to 27", 28" height only for base fascias flush to floor. Cut out will be at bottom)			
	L Left (not available on widths below 42")	T Top or Upper section of Fascia (available on 13", 22", 28" heights)			
	R Right (not available on widths below 42")				

SAMPLE ORDER CODE

UNELCM 2	B	B	22	72	E
----------	---	---	----	----	---

DIMENSIONS INCHES / MM

H	W
7 / 178	66 / 1676
7 / 178	72 / 1829
7 / 178	78 / 1981
7 / 178	84 / 2134
7 / 178	90 / 2286
7 / 178	96 / 2438
13 / 330	66 / 1676
13 / 330	72 / 1829
13 / 330	78 / 1981
13 / 330	84 / 2134
13 / 330	90 / 2286
13 / 330	96 / 2438
22 / 559	66 / 1676
22 / 559	72 / 1829
22 / 559	78 / 1981
22 / 559	84 / 2134
22 / 559	90 / 2286
22 / 559	96 / 2438
26 / 660	66 / 1676
26 / 660	72 / 1829
26 / 660	78 / 1981
26 / 660	84 / 2134
26 / 660	90 / 2286
26 / 660	96 / 2438

PRICING

HORIZONTAL (B) & VERTICAL (B)
142
146
149
152
155
158
186
194
200
205
210
219
252
260
272
281
290
301
296
306
319
331
342
355

DIMENSIONS INCHES / MM

H	W
28 / 711	66 / 1676
28 / 711	72 / 1829
28 / 711	78 / 1981
28 / 711	84 / 2134
28 / 711	90 / 2286
28 / 711	96 / 2438
13 / 330	66 / 1676
13 / 330	72 / 1829
13 / 330	78 / 1981
13 / 330	84 / 2134
13 / 330	90 / 2286
13 / 330	96 / 2438
22 / 559	66 / 1676
22 / 559	72 / 1829
22 / 559	78 / 1981
22 / 559	84 / 2134
22 / 559	90 / 2286
22 / 559	96 / 2438
28 / 711	66 / 1676
28 / 711	72 / 1829
28 / 711	78 / 1981
28 / 711	84 / 2134
28 / 711	90 / 2286
28 / 711	96 / 2438

PRICING

HORIZONTAL (B) & VERTICAL (F)
296
306
319
331
342
355
HORIZONTAL (B) & VERTICAL (T)
186
194
200
205
210
219
252
260
272
281
290
301
296
306
319
331
342
355

Pricing is continued on the following page.

UNELCM
Metal Power/Communications
Fascia (Slot Mount) (Continued)

DIMENSIONS INCHES / MM	
H	W
7 / 178	24 / 610
7 / 178	30 / 762
7 / 178	36 / 914
13 / 330	24 / 610
13 / 330	30 / 762
13 / 330	36 / 914
22 / 559	24 / 610
22 / 559	30 / 762
22 / 559	36 / 914
26 / 660	24 / 610
26 / 660	30 / 762
26 / 660	36 / 914
37 / 940	24 / 610
37 / 940	30 / 762
37 / 940	36 / 914
28 / 711	24 / 610
28 / 711	30 / 762
28 / 711	36 / 914
13 / 330	24 / 610
13 / 330	30 / 762
13 / 330	36 / 914
22 / 559	24 / 610
22 / 559	30 / 762
22 / 559	36 / 914
28 / 711	24 / 610
28 / 711	30 / 762
28 / 711	36 / 914

PRICING
HORIZONTAL (C) & VERTICAL (B)
76
80
84
96
103
109
122
132
145
137
152
167
172
186
204
HORIZONTAL (C) & VERTICAL (F)
137
152
167
HORIZONTAL (C) & VERTICAL (T)
96
103
109
122
132
145
137
152
167

DIMENSIONS INCHES / MM		PRICING
H	W	HORIZONTAL (L or R) & VERTICAL (B)
7 / 178	42 / 1067	91
7 / 178	48 / 1219	95
7 / 178	54 / 1372	99
7 / 178	60 / 1524	103
7 / 178	66 / 1676	142
7 / 178	72 / 1829	146
7 / 178	78 / 1981	149
7 / 178	84 / 2134	152
7 / 178	90 / 2286	155
7 / 178	96 / 2438	158
13 / 330	42 / 1067	118
13 / 330	48 / 1219	124
13 / 330	54 / 1372	131
13 / 330	60 / 1524	137
13 / 330	66 / 1676	186
13 / 330	72 / 1829	194
13 / 330	78 / 1981	200
13 / 330	84 / 2134	205
13 / 330	90 / 2286	210
13 / 330	96 / 2438	219
22 / 559	42 / 1067	154
22 / 559	48 / 1219	164
22 / 559	54 / 1372	175
22 / 559	60 / 1524	184
22 / 559	66 / 1676	252
22 / 559	72 / 1829	260
22 / 559	78 / 1981	272
22 / 559	84 / 2134	281
22 / 559	90 / 2286	290
22 / 559	96 / 2438	301
26 / 660	42 / 1067	178
26 / 660	48 / 1219	191
26 / 660	54 / 1372	203
26 / 660	60 / 1524	215
26 / 660	66 / 1676	296
26 / 660	72 / 1829	306
26 / 660	78 / 1981	319
26 / 660	84 / 2134	331
26 / 660	90 / 2286	342
26 / 660	96 / 2438	355
37 / 940	42 / 1067	222
37 / 940	48 / 1219	236
37 / 940	54 / 1372	254
37 / 940	60 / 1524	272

Pricing is continued on the following page.

U N E L C M

**Metal Power/Communications
Fascia (Slot Mount) (Continued)**

**DIMENSIONS
INCHES / MM**

PRICING

H	W
28 / 711	42 / 1067
28 / 711	48 / 1219
28 / 711	54 / 1372
28 / 711	60 / 1524
28 / 711	66 / 1676
28 / 711	72 / 1829
28 / 711	78 / 1981
28 / 711	84 / 2134
28 / 711	90 / 2286
28 / 711	96 / 2438

HORIZONTAL (L or R) & VERTICAL (F)
178
191
203
215
296
306
319
331
342
355

13 / 330	42 / 1067
13 / 330	48 / 1219
13 / 330	54 / 1372
13 / 330	60 / 1524
13 / 330	66 / 1676
13 / 330	72 / 1829
13 / 330	78 / 1981
13 / 330	84 / 2134
13 / 330	90 / 2286
13 / 330	96 / 2438

HORIZONTAL (L or R) & VERTICAL (T)
118
124
131
137
186
194
200
205
210
219

22 / 559	42 / 1067
22 / 559	48 / 1219
22 / 559	54 / 1372
22 / 559	60 / 1524
22 / 559	66 / 1676
22 / 559	72 / 1829
22 / 559	78 / 1981
22 / 559	84 / 2134
22 / 559	90 / 2286
22 / 559	96 / 2438

154
164
175
184
252
260
272
281
290
301

28 / 711	42 / 1067
28 / 711	48 / 1219
28 / 711	54 / 1372
28 / 711	60 / 1524
28 / 711	66 / 1676
28 / 711	72 / 1829
28 / 711	78 / 1981
28 / 711	84 / 2134
28 / 711	90 / 2286
28 / 711	96 / 2438

178
191
203
215
296
306
319
331
342
355

U A E L C M

Metal Power/Communications Fascia for Freestanding District (Slot Mount)

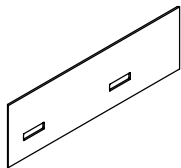

The Metal Power/Communications Fascia (Slot Mount) provides face-mounted access to power/communications.

WHAT'S INCLUDED

1 fascia with cut out as specified, fascia connectors.

NOTES

Not all height/width combinations are available. 35" high fascia can be specified to a maximum of 60" width only. See pricing for exact offering.

Fascia is to only be applied to District Panel that is supported by the Freestanding Foot (UAFFN).

The 22" fascia must be ordered with a 6" high fascia as Elevated panels are not applicable in a freestanding application.

For 36" to 60" wide fascias only Left (LL) or Right (RR) power and data locations can be specified.

PRODUCT OPTIONS

Outlet Configuration	Horizontal Power/ Communication Orientation	Vertical Power/ Communication Orientation	Height	Width (6" increments)	Fascia Finish
2 One duplex outlet plus VDM	LL Left	T Top	22, 28, 35	36 - 96	Foundation Mica
4 Two duplex outlets plus VDM	LC Left Centre	B Bottom			
	RC Right Centre				
	RR Right				
	LR Left and Right				
	CR Left Centre and Right				
	CL Right Centre and Left				

SAMPLE ORDER CODE

UAELCM 2	LC	B	22	66	E
-----------------	-----------	----------	-----------	-----------	----------

DIMENSIONS INCHES / MM

H	W
22 / 559	66 / 1676
22 / 559	72 / 1829
22 / 559	78 / 1981
22 / 559	84 / 2134
22 / 559	90 / 2286
22 / 559	96 / 2438
28 / 711	66 / 1676
28 / 711	72 / 1829
28 / 711	78 / 1981
28 / 711	84 / 2134
28 / 711	90 / 2286
28 / 711	96 / 2438

PRICING

HORIZONTAL (LC, RC, LR, CR or CL) & VERTICAL (B or T)

256
265
277
285
296
305
288
301
313
326
337
350

Pricing is continued on the following page.

U A E L C M
Metal Power/Communications
Fascia for Freestanding District
(Slot Mount) (Continued)

DIMENSIONS
INCHES / MM

H	W
22 / 559	36 / 914
22 / 559	42 / 1067
22 / 559	48 / 1219
22 / 559	54 / 1372
22 / 559	60 / 1524
22 / 559	66 / 1676
22 / 559	72 / 1829
22 / 559	78 / 1981
22 / 559	84 / 2134
22 / 559	90 / 2286
22 / 559	96 / 2438
28 / 711	36 / 914
28 / 711	42 / 1067
28 / 711	48 / 1219
28 / 711	54 / 1372
28 / 711	60 / 1524
28 / 711	66 / 1676
28 / 711	72 / 1829
28 / 711	78 / 1981
28 / 711	84 / 2134
28 / 711	90 / 2286
28 / 711	96 / 2438
35 / 889	36 / 914
35 / 889	42 / 1067
35 / 889	48 / 1219
35 / 889	54 / 1372
35 / 889	60 / 1524

PRICING

HORIZONTAL (LL or RR) & VERTICAL (B or T)
153
161
172
180
189
256
265
277
285
296
305
170
180
193
203
214
288
301
313
326
337
350
197
210
226
240
255

UNELIM

Metal International Power/ Communications Fascia (Slot Mount)

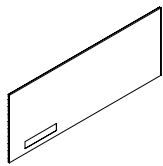

The Metal International Power/Communications Fascia provides face-mounted access to power/communications above or below worksurface height.

WHAT'S INCLUDED

1 fascia with cut out as specified.

WHAT'S EXCLUDED

Fascia Light Block (UNEX) is required for additional segmentation and must be specified separately. Can be found in the *Panel Walls* section.

NOTES

37" high fascia can be specified to a maximum of 60" width only.

PRODUCT OPTIONS

Outlet Configuration	Horizontal Power/Communications Orientation	Vertical Power/Communications Orientation	Height	Width (6" increments)	Fascia Finish	Bezel Finish
2 Cut Out for two outlets (available on 24" and 30" widths)	B Left and Right (available on 66" width and wider)	B Bottom or lower section of fascia (available on 7", 13", 22", 37" heights)	07, 13, 21, 22, 27, 28, 37	24 - 96	Foundation Mica	~ Black YF Storm White Coordinate
3 Cut Out for two outlets and one data/communications box (available on 36" widths and wider)	C Centered (available on 36" width for config. 3 and 4 (available on 24", 30", 36" widths for config. 2)	F Flush (applies to 28" height only for base fascias flush to floor. Cut Out will be at bottom)				
4 Cut Out for four outlets (available on 36" widths and wider)	L Left (not available on widths below 42")	T Top or upper section of fascia (available on 13", 22", 28" heights)				
5 Cala Cut Out for two outlets	R Right (not available on widths below 42")					
6 Cala Cut Out for four outlets						

SAMPLE ORDER CODE

UNELIM 3	R	T	22	60	E	74
----------	---	---	----	----	---	----

DIMENSIONS INCHES / MM

H	W
7 / 178	66 / 1676
7 / 178	72 / 1829
7 / 178	78 / 1981
7 / 178	84 / 2134
7 / 178	90 / 2286
7 / 178	96 / 2438
13 / 330	66 / 1676
13 / 330	72 / 1829
13 / 330	78 / 1981
13 / 330	84 / 2134
13 / 330	90 / 2286
13 / 330	96 / 2438
21 / 533	66 / 1676
21 / 533	72 / 1829
21 / 533	78 / 1981
21 / 533	84 / 2134
21 / 533	90 / 2286
21 / 533	96 / 2438

PRICING

CUT OUT OUTLET (2, 3, 4)	
HORIZONTAL (B) & VERTICAL (B)	
142	
146	
149	
152	
155	
158	
186	
194	
200	
205	
210	
219	
249	
257	
268	
277	
285	
297	

DIMENSIONS INCHES / MM

H	W
22 / 559	66 / 1676
22 / 559	72 / 1829
22 / 559	78 / 1981
22 / 559	84 / 2134
22 / 559	90 / 2286
22 / 559	96 / 2438
27 / 686	66 / 1676
27 / 686	72 / 1829
27 / 686	78 / 1981
27 / 686	84 / 2134
27 / 686	90 / 2286
27 / 686	96 / 2438
28 / 711	66 / 1676
28 / 711	72 / 1829
28 / 711	78 / 1981
28 / 711	84 / 2134
28 / 711	90 / 2286
28 / 711	96 / 2438

PRICING

CUT OUT OUTLET (2, 3, 4)	
HORIZONTAL (B) & VERTICAL (B) (Continued)	
252	
260	
272	
281	
290	
301	
HORIZONTAL (B) & VERTICAL (F)	
291	
303	
313	
327	
337	
351	
296	
306	
319	
331	
342	
355	

Pricing is continued on the following page.

UNELIM
**Metal International Power/
 Communications Fascia
 (Slot Mount) (Continued)**

DIMENSIONS
INCHES / MM

H	W
13 / 330	66 / 1676
13 / 330	72 / 1829
13 / 330	78 / 1981
13 / 330	84 / 2134
13 / 330	90 / 2286
13 / 330	96 / 2438
21 / 533	66 / 1676
21 / 533	72 / 1829
21 / 533	78 / 1981
21 / 533	84 / 2134
21 / 533	90 / 2286
21 / 533	96 / 2438
22 / 559	66 / 1676
22 / 559	72 / 1829
22 / 559	78 / 1981
22 / 559	84 / 2134
22 / 559	90 / 2286
22 / 559	96 / 2438
27 / 686	66 / 1676
27 / 686	72 / 1829
27 / 686	78 / 1981
27 / 686	84 / 2134
27 / 686	90 / 2286
27 / 686	96 / 2438
28 / 711	66 / 1676
28 / 711	72 / 1829
28 / 711	78 / 1981
28 / 711	84 / 2134
28 / 711	90 / 2286
28 / 711	96 / 2438
7 / 178	24 / 610
7 / 178	30 / 762
7 / 178	36 / 914
13 / 330	24 / 610
13 / 330	30 / 762
13 / 330	36 / 914
21 / 533	24 / 610
21 / 533	30 / 762
21 / 533	36 / 914
22 / 559	24 / 610
22 / 559	30 / 762
22 / 559	36 / 914
37 / 940	24 / 610
37 / 940	30 / 762
37 / 940	36 / 914

PRICING

CUT OUT OUTLET (2, 3, 4)	
HORIZONTAL (B) & VERTICAL (T)	
186	
194	
200	
205	
210	
219	
249	
257	
268	
277	
285	
297	
252	
260	
272	
281	
290	
301	
291	
303	
313	
327	
337	
351	
296	
306	
319	
331	
342	
355	
HORIZONTAL (C) & VERTICAL (B)	
76	
80	
84	
96	
103	
109	
121	
130	
143	
122	
132	
145	
172	
186	
204	

DIMENSIONS
INCHES / MM

H	W
27 / 686	24 / 610
27 / 686	30 / 762
27 / 686	36 / 914
28 / 711	24 / 610
28 / 711	30 / 762
28 / 711	36 / 914
13 / 330	24 / 610
13 / 330	30 / 762
13 / 330	36 / 914
21 / 533	24 / 610
21 / 533	30 / 762
21 / 533	36 / 914
22 / 559	24 / 610
22 / 559	30 / 762
22 / 559	36 / 914
27 / 686	24 / 610
27 / 686	30 / 762
27 / 686	36 / 914
28 / 711	24 / 610
28 / 711	30 / 762
28 / 711	36 / 914
7 / 178	42 / 1067
7 / 178	48 / 1219
7 / 178	54 / 1372
7 / 178	60 / 1524
7 / 178	66 / 1676
7 / 178	72 / 1829
7 / 178	78 / 1981
7 / 178	84 / 2134
7 / 178	90 / 2286
7 / 178	96 / 2438
13 / 330	42 / 1067
13 / 330	48 / 1219
13 / 330	54 / 1372
13 / 330	60 / 1524
13 / 330	66 / 1676
13 / 330	72 / 1829
13 / 330	78 / 1981
13 / 330	84 / 2134
13 / 330	90 / 2286
13 / 330	96 / 2438

PRICING

CUT OUT OUTLET (2, 3, 4)	
HORIZONTAL (C) & VERTICAL (F)	
136	
150	
162	
137	
152	
167	
HORIZONTAL (C) & VERTICAL (T)	
96	
103	
109	
121	
130	
143	
122	
132	
145	
136	
150	
162	
137	
152	
167	
HORIZONTAL (L or R) & VERTICAL (B)	
91	
95	
99	
103	
142	
146	
149	
152	
155	
158	
118	
124	
131	
137	
186	
194	
200	
205	
210	
219	

Pricing is continued on the following page.

U N E L I M

**Metal International Power/
Communications Fascia
(Slot Mount) (Continued)**

**DIMENSIONS
INCHES / MM**

H	W
21 / 533	42 / 1067
21 / 533	48 / 1219
21 / 533	54 / 1372
21 / 533	60 / 1524
21 / 533	66 / 1676
21 / 533	72 / 1829
21 / 533	78 / 1981
21 / 533	84 / 2134
21 / 533	90 / 2286
21 / 533	96 / 2438
22 / 559	42 / 1067
22 / 559	48 / 1219
22 / 559	54 / 1372
22 / 559	60 / 1524
22 / 559	66 / 1676
22 / 559	72 / 1829
22 / 559	78 / 1981
22 / 559	84 / 2134
22 / 559	90 / 2286
22 / 559	96 / 2438
37 / 940	42 / 1067
37 / 940	48 / 1219
37 / 940	54 / 1372
37 / 940	60 / 1524
27 / 686	42 / 1067
27 / 686	48 / 1219
27 / 686	54 / 1372
27 / 686	60 / 1524
27 / 686	66 / 1676
27 / 686	72 / 1829
27 / 686	78 / 1981
27 / 686	84 / 2134
27 / 686	90 / 2286
27 / 686	96 / 2438
28 / 711	42 / 1067
28 / 711	48 / 1219
28 / 711	54 / 1372
28 / 711	60 / 1524
28 / 711	66 / 1676
28 / 711	72 / 1829
28 / 711	78 / 1981
28 / 711	84 / 2134
28 / 711	90 / 2286
28 / 711	96 / 2438

PRICING

CUT OUT OUTLET (2, 3, 4)	
HORIZONTAL (L or R) & VERTICAL (B) (Continued)	
152	
161	
173	
182	
249	
257	
268	
277	
285	
297	
154	
164	
175	
184	
252	
260	
272	
281	
290	
301	
222	
236	
254	
272	
HORIZONTAL (L or R) & VERTICAL (F)	
176	
187	
200	
211	
291	
303	
313	
327	
337	
351	
178	
191	
203	
215	
296	
306	
319	
331	
342	
355	

**DIMENSIONS
INCHES / MM**

H	W
13 / 330	42 / 1067
13 / 330	48 / 1219
13 / 330	54 / 1372
13 / 330	60 / 1524
13 / 330	66 / 1676
13 / 330	72 / 1829
13 / 330	78 / 1981
13 / 330	84 / 2134
13 / 330	90 / 2286
13 / 330	96 / 2438
21 / 533	42 / 1067
21 / 533	48 / 1219
21 / 533	54 / 1372
21 / 533	60 / 1524
21 / 533	66 / 1676
21 / 533	72 / 1829
21 / 533	78 / 1981
21 / 533	84 / 2134
21 / 533	90 / 2286
21 / 533	96 / 2438
22 / 559	42 / 1067
22 / 559	48 / 1219
22 / 559	54 / 1372
22 / 559	60 / 1524
22 / 559	66 / 1676
22 / 559	72 / 1829
22 / 559	78 / 1981
22 / 559	84 / 2134
22 / 559	90 / 2286
22 / 559	96 / 2438
27 / 686	42 / 1067
27 / 686	48 / 1219
27 / 686	54 / 1372
27 / 686	60 / 1524
27 / 686	66 / 1676
27 / 686	72 / 1829
27 / 686	78 / 1981
27 / 686	84 / 2134
27 / 686	90 / 2286
27 / 686	96 / 2438
28 / 711	42 / 1067
28 / 711	48 / 1219
28 / 711	54 / 1372
28 / 711	60 / 1524
28 / 711	66 / 1676
28 / 711	72 / 1829
28 / 711	78 / 1981
28 / 711	84 / 2134
28 / 711	90 / 2286
28 / 711	96 / 2438

PRICING

CUT OUT OUTLET (2, 3, 4)	
HORIZONTAL (L or R) & VERTICAL (T)	
118	
124	
131	
137	
186	
194	
200	
205	
210	
219	
152	
161	
173	
182	
249	
257	
268	
277	
285	
297	
154	
164	
175	
184	
252	
260	
272	
281	
290	
301	
176	
187	
200	
211	
291	
303	
313	
327	
337	
351	
178	
191	
203	
215	
296	
306	
319	
331	
342	
355	

UNELIM

**Metal International Power/
Communications Fascia
(Slot Mount) (Continued)**

**DIMENSIONS
INCHES / MM**

H	W
7 / 178	66 / 1676
7 / 178	72 / 1829
7 / 178	78 / 1981
7 / 178	84 / 2134
7 / 178	90 / 2286
7 / 178	96 / 2438
13 / 330	66 / 1676
13 / 330	72 / 1829
13 / 330	78 / 1981
13 / 330	84 / 2134
13 / 330	90 / 2286
13 / 330	96 / 2438
21 / 533	66 / 1676
21 / 533	72 / 1829
21 / 533	78 / 1981
21 / 533	84 / 2134
21 / 533	90 / 2286
21 / 533	96 / 2438
22 / 559	66 / 1676
22 / 559	72 / 1829
22 / 559	78 / 1981
22 / 559	84 / 2134
22 / 559	90 / 2286
22 / 559	96 / 2438
27 / 686	66 / 1676
27 / 686	72 / 1829
27 / 686	78 / 1981
27 / 686	84 / 2134
27 / 686	90 / 2286
27 / 686	96 / 2438
28 / 711	66 / 1676
28 / 711	72 / 1829
28 / 711	78 / 1981
28 / 711	84 / 2134
28 / 711	90 / 2286
28 / 711	96 / 2438
13 / 330	66 / 1676
13 / 330	72 / 1829
13 / 330	78 / 1981
13 / 330	84 / 2134
13 / 330	90 / 2286
13 / 330	96 / 2438

PRICING

CALA CUT OUT FOR TWO OUTLETS (5)	
HORIZONTAL (B) & VERTICAL (B)	
169	
173	
176	
179	
182	
185	
214	
221	
227	
232	
237	
246	
276	
284	
296	
304	
312	
324	
279	
287	
299	
308	
318	
328	
HORIZONTAL (B) & VERTICAL (F)	
319	
330	
341	
354	
364	
378	
323	
333	
347	
358	
370	
382	
HORIZONTAL (B) & VERTICAL (T)	
214	
221	
227	
232	
237	
246	

**DIMENSIONS
INCHES / MM**

H	W
21 / 533	66 / 1676
21 / 533	72 / 1829
21 / 533	78 / 1981
21 / 533	84 / 2134
21 / 533	90 / 2286
21 / 533	96 / 2438
22 / 559	66 / 1676
22 / 559	72 / 1829
22 / 559	78 / 1981
22 / 559	84 / 2134
22 / 559	90 / 2286
22 / 559	96 / 2438
27 / 686	66 / 1676
27 / 686	72 / 1829
27 / 686	78 / 1981
27 / 686	84 / 2134
27 / 686	90 / 2286
27 / 686	96 / 2438
28 / 711	66 / 1676
28 / 711	72 / 1829
28 / 711	78 / 1981
28 / 711	84 / 2134
28 / 711	90 / 2286
28 / 711	96 / 2438
7 / 178	24 / 610
7 / 178	30 / 762
7 / 178	36 / 914
13 / 330	24 / 610
13 / 330	30 / 762
13 / 330	36 / 914
21 / 533	24 / 610
21 / 533	30 / 762
21 / 533	36 / 914
22 / 559	24 / 610
22 / 559	30 / 762
22 / 559	36 / 914
37 / 940	24 / 610
37 / 940	30 / 762
37 / 940	36 / 914

PRICING

CALA CUT OUT FOR TWO OUTLETS (5)	
HORIZONTAL (B) & VERTICAL (T)	
(Continued)	
276	
284	
296	
304	
312	
324	
279	
287	
299	
308	
318	
328	
319	
330	
341	
354	
364	
378	
323	
333	
347	
358	
370	
382	
HORIZONTAL (C) & VERTICAL (B)	
103	
107	
111	
123	
130	
136	
148	
157	
170	
149	
159	
172	
199	
214	
231	

Pricing is continued on the following page.

UNELIM

Metal International Power/ Communications Fascia (Slot Mount) (Continued)

DIMENSIONS INCHES / MM

H	W
27 / 686	24 / 610
27 / 686	30 / 762
27 / 686	36 / 914
28 / 711	24 / 610
28 / 711	30 / 762
28 / 711	36 / 914
13 / 330	24 / 610
13 / 330	30 / 762
13 / 330	36 / 914
21 / 533	24 / 610
21 / 533	30 / 762
21 / 533	36 / 914
22 / 559	24 / 610
22 / 559	30 / 762
22 / 559	36 / 914
27 / 686	24 / 610
27 / 686	30 / 762
27 / 686	36 / 914
28 / 711	24 / 610
28 / 711	30 / 762
28 / 711	36 / 914
7 / 178	42 / 1067
7 / 178	48 / 1219
7 / 178	54 / 1372
7 / 178	60 / 1524
7 / 178	66 / 1676
7 / 178	72 / 1829
7 / 178	78 / 1981
7 / 178	84 / 2134
7 / 178	90 / 2286
7 / 178	96 / 2438
13 / 330	42 / 1067
13 / 330	48 / 1219
13 / 330	54 / 1372
13 / 330	60 / 1524
13 / 330	66 / 1676
13 / 330	72 / 1829
13 / 330	78 / 1981
13 / 330	84 / 2134
13 / 330	90 / 2286
13 / 330	96 / 2438

PRICING

CALA CUT OUT FOR TWO OUTLETS (5)	
HORIZONTAL (C) & VERTICAL (F)	
164	
177	
191	
167	
179	
194	
123	
130	
136	
148	
157	
170	
149	
159	
172	
164	
177	
191	
167	
179	
194	
118	
122	
126	
130	
169	
173	
176	
179	
182	
185	
145	
151	
158	
167	
214	
221	
227	
232	
237	
246	

HORIZONTAL (L or R) & VERTICAL (B)

DIMENSIONS INCHES / MM

H	W
21 / 533	42 / 1067
21 / 533	48 / 1219
21 / 533	54 / 1372
21 / 533	60 / 1524
21 / 533	66 / 1676
21 / 533	72 / 1829
21 / 533	78 / 1981
21 / 533	84 / 2134
21 / 533	90 / 2286
21 / 533	96 / 2438
22 / 559	42 / 1067
22 / 559	48 / 1219
22 / 559	54 / 1372
22 / 559	60 / 1524
22 / 559	66 / 1676
22 / 559	72 / 1829
22 / 559	78 / 1981
22 / 559	84 / 2134
22 / 559	90 / 2286
22 / 559	96 / 2438
37 / 940	42 / 1067
37 / 940	48 / 1219
37 / 940	54 / 1372
37 / 940	60 / 1524
27 / 686	42 / 1067
27 / 686	48 / 1219
27 / 686	54 / 1372
27 / 686	60 / 1524
27 / 686	66 / 1676
27 / 686	72 / 1829
27 / 686	78 / 1981
27 / 686	84 / 2134
27 / 686	90 / 2286
27 / 686	96 / 2438
28 / 711	42 / 1067
28 / 711	48 / 1219
28 / 711	54 / 1372
28 / 711	60 / 1524
28 / 711	66 / 1676
28 / 711	72 / 1829
28 / 711	78 / 1981
28 / 711	84 / 2134
28 / 711	90 / 2286
28 / 711	96 / 2438

PRICING

CALA CUT OUT FOR TWO OUTLETS (5)	
HORIZONTAL (L or R) & VERTICAL (B) (Continued)	
179	
189	
200	
209	
276	
284	
296	
304	
312	
324	
181	
193	
202	
211	
279	
287	
299	
308	
318	
328	
249	
263	
281	
299	
203	
215	
227	
238	
319	
330	
341	
354	
364	
378	
205	
219	
230	
244	
323	
333	
347	
358	
370	
382	

HORIZONTAL (L or R) & VERTICAL (F)

Pricing is continued on the following page.

UNELIM
**Metal International Power/
 Communications Fascia
 (Slot Mount) (Continued)**

DIMENSIONS
INCHES / MM

H	W
13 / 330	42 / 1067
13 / 330	48 / 1219
13 / 330	54 / 1372
13 / 330	60 / 1524
13 / 330	66 / 1676
13 / 330	72 / 1829
13 / 330	78 / 1981
13 / 330	84 / 2134
13 / 330	90 / 2286
13 / 330	96 / 2438
21 / 533	42 / 1067
21 / 533	48 / 1219
21 / 533	54 / 1372
21 / 533	60 / 1524
21 / 533	66 / 1676
21 / 533	72 / 1829
21 / 533	78 / 1981
21 / 533	84 / 2134
21 / 533	90 / 2286
21 / 533	96 / 2438
22 / 559	42 / 1067
22 / 559	48 / 1219
22 / 559	54 / 1372
22 / 559	60 / 1524
22 / 559	66 / 1676
22 / 559	72 / 1829
22 / 559	78 / 1981
22 / 559	84 / 2134
22 / 559	90 / 2286
22 / 559	96 / 2438
27 / 686	42 / 1067
27 / 686	48 / 1219
27 / 686	54 / 1372
27 / 686	60 / 1524
27 / 686	66 / 1676
27 / 686	72 / 1829
27 / 686	78 / 1981
27 / 686	84 / 2134
27 / 686	90 / 2286
27 / 686	96 / 2438
28 / 711	42 / 1067
28 / 711	48 / 1219
28 / 711	54 / 1372
28 / 711	60 / 1524
28 / 711	66 / 1676
28 / 711	72 / 1829
28 / 711	78 / 1981
28 / 711	84 / 2134
28 / 711	90 / 2286
28 / 711	96 / 2438

PRICING

CALA CUT OUT FOR TWO OUTLETS (5)	
HORIZONTAL (L or R) & VERTICAL (T)	
145	
151	
158	
167	
214	
221	
227	
232	
237	
246	
179	
189	
200	
209	
276	
284	
296	
304	
312	
324	
181	
193	
202	
211	
279	
287	
299	
308	
318	
328	
203	
215	
227	
238	
319	
330	
341	
354	
364	
378	
205	
219	
230	
244	
323	
333	
347	
358	
370	
382	

DIMENSIONS
INCHES / MM

H	W
7 / 178	66 / 1676
7 / 178	72 / 1829
7 / 178	78 / 1981
7 / 178	84 / 2134
7 / 178	90 / 2286
7 / 178	96 / 2438
13 / 330	66 / 1676
13 / 330	72 / 1829
13 / 330	78 / 1981
13 / 330	84 / 2134
13 / 330	90 / 2286
13 / 330	96 / 2438
21 / 533	66 / 1676
21 / 533	72 / 1829
21 / 533	78 / 1981
21 / 533	84 / 2134
21 / 533	90 / 2286
21 / 533	96 / 2438
22 / 559	66 / 1676
22 / 559	72 / 1829
22 / 559	78 / 1981
22 / 559	84 / 2134
22 / 559	90 / 2286
22 / 559	96 / 2438
27 / 686	66 / 1676
27 / 686	72 / 1829
27 / 686	78 / 1981
27 / 686	84 / 2134
27 / 686	90 / 2286
27 / 686	96 / 2438
28 / 711	66 / 1676
28 / 711	72 / 1829
28 / 711	78 / 1981
28 / 711	84 / 2134
28 / 711	90 / 2286
28 / 711	96 / 2438
13 / 330	66 / 1676
13 / 330	72 / 1829
13 / 330	78 / 1981
13 / 330	84 / 2134
13 / 330	90 / 2286
13 / 330	96 / 2438

PRICING

CALA CUT OUT FOR FOUR OUTLETS (6)	
HORIZONTAL (B) & VERTICAL (B)	
175	
179	
182	
185	
189	
194	
222	
227	
233	
238	
246	
252	
282	
291	
302	
310	
321	
330	
285	
296	
305	
315	
325	
334	
HORIZONTAL (B) & VERTICAL (F)	
326	
336	
349	
360	
373	
384	
329	
340	
353	
364	
377	
388	
HORIZONTAL (B) & VERTICAL (T)	
222	
227	
233	
238	
246	
252	

Pricing is continued on the following page.

U N E L I M

Metal International Power/ Communications Fascia (Slot Mount) (Continued)

DIMENSIONS INCHES / MM

H	W
21 / 533	66 / 1676
21 / 533	72 / 1829
21 / 533	78 / 1981
21 / 533	84 / 2134
21 / 533	90 / 2286
21 / 533	96 / 2438
22 / 559	66 / 1676
22 / 559	72 / 1829
22 / 559	78 / 1981
22 / 559	84 / 2134
22 / 559	90 / 2286
22 / 559	96 / 2438
27 / 686	66 / 1676
27 / 686	72 / 1829
27 / 686	78 / 1981
27 / 686	84 / 2134
27 / 686	90 / 2286
27 / 686	96 / 2438
28 / 711	66 / 1676
28 / 711	72 / 1829
28 / 711	78 / 1981
28 / 711	84 / 2134
28 / 711	90 / 2286
28 / 711	96 / 2438
7 / 178	36 / 914
13 / 330	36 / 914
21 / 533	36 / 914
22 / 559	36 / 914
37 / 940	36 / 914
13 / 330	36 / 914
21 / 533	36 / 914
22 / 559	36 / 914
27 / 686	36 / 914
28 / 711	36 / 914

PRICING

CALA CUT OUT FOR FOUR OUTLETS (6)	
HORIZONTAL (B) & VERTICAL (T) (Continued)	
282	
291	
302	
310	
321	
330	
285	
296	
305	
315	
325	
334	
326	
336	
349	
360	
373	
384	
329	
340	
353	
364	
377	
388	
HORIZONTAL (C) & VERTICAL (B)	
120	
145	
176	
178	
237	
HORIZONTAL (C) & VERTICAL (T)	
145	
176	
178	
198	
200	

DIMENSIONS INCHES / MM

H	W
7 / 178	42 / 1067
7 / 178	48 / 1219
7 / 178	54 / 1372
7 / 178	60 / 1524
7 / 178	66 / 1676
7 / 178	72 / 1829
7 / 178	78 / 1981
7 / 178	84 / 2134
7 / 178	90 / 2286
7 / 178	96 / 2438
13 / 330	42 / 1067
13 / 330	48 / 1219
13 / 330	54 / 1372
13 / 330	60 / 1524
13 / 330	66 / 1676
13 / 330	72 / 1829
13 / 330	78 / 1981
13 / 330	84 / 2134
13 / 330	90 / 2286
13 / 330	96 / 2438
21 / 533	42 / 1067
21 / 533	48 / 1219
21 / 533	54 / 1372
21 / 533	60 / 1524
21 / 533	66 / 1676
21 / 533	72 / 1829
21 / 533	78 / 1981
21 / 533	84 / 2134
21 / 533	90 / 2286
21 / 533	96 / 2438
22 / 559	42 / 1067
22 / 559	48 / 1219
22 / 559	54 / 1372
22 / 559	60 / 1524
22 / 559	66 / 1676
22 / 559	72 / 1829
22 / 559	78 / 1981
22 / 559	84 / 2134
22 / 559	90 / 2286
22 / 559	96 / 2438
37 / 940	42 / 1067
37 / 940	48 / 1219
37 / 940	54 / 1372
37 / 940	60 / 1524

PRICING

CALA CUT OUT FOR FOUR OUTLETS (6)	
HORIZONTAL (L or R) & VERTICAL (B)	
124	
128	
132	
136	
175	
179	
182	
185	
189	
194	
151	
157	
167	
173	
222	
227	
233	
238	
246	
252	
185	
197	
206	
218	
282	
291	
302	
310	
321	
330	
187	
199	
208	
220	
285	
296	
305	
315	
325	
334	
255	
272	
287	
305	

Pricing is continued on the following page.

UNELIM
**Metal International Power/
 Communications Fascia
 (Slot Mount) (Continued)**

DIMENSIONS
INCHES / MM

H	W
27 / 686	42 / 1067
27 / 686	48 / 1219
27 / 686	54 / 1372
27 / 686	60 / 1524
27 / 686	66 / 1676
27 / 686	72 / 1829
27 / 686	78 / 1981
27 / 686	84 / 2134
27 / 686	90 / 2286
27 / 686	96 / 2438
28 / 711	42 / 1067
28 / 711	48 / 1219
28 / 711	54 / 1372
28 / 711	60 / 1524
28 / 711	66 / 1676
28 / 711	72 / 1829
28 / 711	78 / 1981
28 / 711	84 / 2134
28 / 711	90 / 2286
28 / 711	96 / 2438
13 / 330	42 / 1067
13 / 330	48 / 1219
13 / 330	54 / 1372
13 / 330	60 / 1524
13 / 330	66 / 1676
13 / 330	72 / 1829
13 / 330	78 / 1981
13 / 330	84 / 2134
13 / 330	90 / 2286
13 / 330	96 / 2438
21 / 533	42 / 1067
21 / 533	48 / 1219
21 / 533	54 / 1372
21 / 533	60 / 1524
21 / 533	66 / 1676
21 / 533	72 / 1829
21 / 533	78 / 1981
21 / 533	84 / 2134
21 / 533	90 / 2286
21 / 533	96 / 2438

PRICING

CALA CUT OUT FOR FOUR OUTLETS (6)	
HORIZONTAL (L or R) & VERTICAL (F)	
209	
223	
233	
247	
326	
336	
349	
360	
373	
384	
211	
225	
236	
250	
329	
340	
353	
364	
377	
388	
HORIZONTAL (L or R) & VERTICAL (T)	
151	
157	
167	
173	
222	
227	
233	
238	
246	
252	
185	
197	
206	
218	
282	
291	
302	
310	
321	
330	

DIMENSIONS
INCHES / MM

H	W
22 / 559	42 / 1067
22 / 559	48 / 1219
22 / 559	54 / 1372
22 / 559	60 / 1524
22 / 559	66 / 1676
22 / 559	72 / 1829
22 / 559	78 / 1981
22 / 559	84 / 2134
22 / 559	90 / 2286
22 / 559	96 / 2438
27 / 686	42 / 1067
27 / 686	48 / 1219
27 / 686	54 / 1372
27 / 686	60 / 1524
27 / 686	66 / 1676
27 / 686	72 / 1829
27 / 686	78 / 1981
27 / 686	84 / 2134
27 / 686	90 / 2286
27 / 686	96 / 2438
28 / 711	42 / 1067
28 / 711	48 / 1219
28 / 711	54 / 1372
28 / 711	60 / 1524
28 / 711	66 / 1676
28 / 711	72 / 1829
28 / 711	78 / 1981
28 / 711	84 / 2134
28 / 711	90 / 2286
28 / 711	96 / 2438

PRICING

CALA CUT OUT FOR FOUR OUTLETS (6)	
HORIZONTAL (L or R) & VERTICAL (T)	
(Continued)	
187	
199	
208	
220	
285	
296	
305	
315	
325	
334	
209	
223	
233	
247	
326	
336	
349	
360	
373	
384	
211	
225	
236	
250	
329	
340	
353	
364	
377	
388	

U A E L I M

Metal International Power/ Communications Fascia for Freestanding District (Slot Mount)

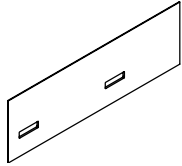

The Metal International Power/Communications Fascia provides face-mounted access to power/communications.

WHAT'S INCLUDED

1 fascia with Cut Out as specified, fascia connectors.

NOTES

Not all height/width combinations are available. 35" high fascia can be specified to a maximum of 60" width only. See pricing for exact offering.

Fascia is to only be applied to District Panel that is supported by the Freestanding Foot (UAFFN).

The 21" and 22" fascias must be ordered with a 6" high fascia as Elevated panels are not applicable in a freestanding application.

For 36" to 60" wide fascias only Left (LL) or Right (RR) power and data locations can be specified.

PRODUCT OPTIONS

Outlet Configuration	Horizontal Power/ Communication Orientation	Vertical Power/ Communication Orientation	Height	Width (6" increments)	Fascia Finish	Bezel Finish		
2 Cut Out for two outlets (available on 24" and 30" widths)	LL Left	T Top	21, 22, 27, 28, 35	36 - 96	Foundation Mica	Black		
	LC Left Centre	B Bottom				74 Storm White		
3 Cut Out for two outlets and one data/communications box (available on 36" widths and wider)	RC Right Centre							
	RR Right							
	LR Left & Right							
	CR Left Centre & Right							
4 Cut Out for four outlets (available on 36" widths and wider)	CL Right Centre & Left							
5 Cala Cut Out for two outlets								
6 Cala Cut Out for four outlets								

SAMPLE ORDER CODE

UAELIM 2	LC	B	22	66	E	74
----------	----	---	----	----	---	----

DIMENSIONS INCHES / MM

H	W
21 / 533	66 / 1676
21 / 533	72 / 1829
21 / 533	78 / 1981
21 / 533	84 / 2134
21 / 533	90 / 2286
21 / 533	96 / 2438
22 / 559	66 / 1676
22 / 559	72 / 1829
22 / 559	78 / 1981
22 / 559	84 / 2134
22 / 559	90 / 2286
22 / 559	96 / 2438

PRICING

CUT OUT OUTLET (2, 3, 4)	
HORIZONTAL (LC, RC, LR, CR or CL) & VERTICAL (B or T)	
253	
261	
273	
281	
290	
301	
256	
265	
277	
285	
296	
305	

DIMENSIONS INCHES / MM

H	W
27 / 686	66 / 1676
27 / 686	72 / 1829
27 / 686	78 / 1981
27 / 686	84 / 2134
27 / 686	90 / 2286
27 / 686	96 / 2438
28 / 711	66 / 1676
28 / 711	72 / 1829
28 / 711	78 / 1981
28 / 711	84 / 2134
28 / 711	90 / 2286
28 / 711	96 / 2438

PRICING

CUT OUT OUTLET (2, 3, 4)	
HORIZONTAL (LC, RC, LR, CR or CL) & VERTICAL (B or T) (Continued)	
285	
298	
310	
323	
333	
346	
288	
301	
313	
326	
337	
350	

Pricing is continued on the following page.

U A E L I M
**Metal International Power/
Communications Fascia for
Freestanding District (Slot Mount)
(Continued)**

DIMENSIONS
INCHES / MM

H	W
21 / 533	36 / 914
21 / 533	42 / 1067
21 / 533	48 / 1219
21 / 533	54 / 1372
21 / 533	60 / 1524
21 / 533	66 / 1676
21 / 533	72 / 1829
21 / 533	78 / 1981
21 / 533	84 / 2134
21 / 533	90 / 2286
21 / 533	96 / 2438
22 / 559	36 / 914
22 / 559	42 / 1067
22 / 559	48 / 1219
22 / 559	54 / 1372
22 / 559	60 / 1524
22 / 559	66 / 1676
22 / 559	72 / 1829
22 / 559	78 / 1981
22 / 559	84 / 2134
22 / 559	90 / 2286
22 / 559	96 / 2438
27 / 686	36 / 914
27 / 686	42 / 1067
27 / 686	48 / 1219
27 / 686	54 / 1372
27 / 686	60 / 1524
27 / 686	66 / 1676
27 / 686	72 / 1829
27 / 686	78 / 1981
27 / 686	84 / 2134
27 / 686	90 / 2286
27 / 686	96 / 2438
28 / 711	36 / 914
28 / 711	42 / 1067
28 / 711	48 / 1219
28 / 711	54 / 1372
28 / 711	60 / 1524
28 / 711	66 / 1676
28 / 711	72 / 1829
28 / 711	78 / 1981
28 / 711	84 / 2134
28 / 711	90 / 2286
28 / 711	96 / 2438
35 / 889	36 / 914
35 / 889	42 / 1067
35 / 889	48 / 1219
35 / 889	54 / 1372
35 / 889	60 / 1524

PRICING

CUT OUT OUTLET (2, 3, 4)	
HORIZONTAL (LL or RR) & VERTICAL (B or T)	
151	
159	
170	
178	
186	
253	
261	
273	
281	
290	
301	
153	
161	
172	
180	
189	
256	
265	
277	
285	
296	
305	
168	
178	
187	
200	
210	
285	
298	
310	
323	
333	
346	
170	
180	
193	
203	
214	
288	
301	
313	
326	
337	
350	
197	
210	
226	
240	
255	

DIMENSIONS
INCHES / MM

H	W
21 / 533	66 / 1676
21 / 533	72 / 1829
21 / 533	78 / 1981
21 / 533	84 / 2134
21 / 533	90 / 2286
21 / 533	96 / 2438
22 / 559	66 / 1676
22 / 559	72 / 1829
22 / 559	78 / 1981
22 / 559	84 / 2134
22 / 559	90 / 2286
22 / 559	96 / 2438
27 / 686	66 / 1676
27 / 686	72 / 1829
27 / 686	78 / 1981
27 / 686	84 / 2134
27 / 686	90 / 2286
27 / 686	96 / 2438
28 / 711	66 / 1676
28 / 711	72 / 1829
28 / 711	78 / 1981
28 / 711	84 / 2134
28 / 711	90 / 2286
28 / 711	96 / 2438
21 / 533	36 / 914
21 / 533	42 / 1067
21 / 533	48 / 1219
21 / 533	54 / 1372
21 / 533	60 / 1524
21 / 533	66 / 1676
21 / 533	72 / 1829
21 / 533	78 / 1981
21 / 533	84 / 2134
21 / 533	90 / 2286
21 / 533	96 / 2438

PRICING

CALA CUT OUT FOR TWO OUTLETS (5)	
HORIZONTAL (LC, RC, LR, CR or CL) & VERTICAL (B or T)	
280	
288	
300	
308	
318	
328	
283	
293	
304	
312	
323	
332	
312	
325	
337	
350	
360	
373	
316	
328	
341	
353	
364	
377	
178	
186	
197	
205	
214	
280	
288	
300	
308	
318	
328	

**HORIZONTAL (LL or RR) &
VERTICAL (B or T)**

Pricing is continued on the following page.

U A E L I M

**Metal International Power/
Communications Fascia for
Freestanding District (Slot Mount)
(Continued)**

DIMENSIONS INCHES / MM		PRICING
H	W	
CALA CUT OUT FOR TWO OUTLETS (5)		
HORIZONTAL (LL or RR) & VERTICAL (B or T) (Continued)		
22 / 559	36 / 914	180
22 / 559	42 / 1067	189
22 / 559	48 / 1219	199
22 / 559	54 / 1372	207
22 / 559	60 / 1524	218
22 / 559	66 / 1676	283
22 / 559	72 / 1829	293
22 / 559	78 / 1981	304
22 / 559	84 / 2134	312
22 / 559	90 / 2286	323
22 / 559	96 / 2438	332
27 / 686	36 / 914	195
27 / 686	42 / 1067	205
27 / 686	48 / 1219	215
27 / 686	54 / 1372	227
27 / 686	60 / 1524	237
27 / 686	66 / 1676	312
27 / 686	72 / 1829	325
27 / 686	78 / 1981	337
27 / 686	84 / 2134	350
27 / 686	90 / 2286	360
27 / 686	96 / 2438	373
28 / 711	36 / 914	197
28 / 711	42 / 1067	207
28 / 711	48 / 1219	220
28 / 711	54 / 1372	230
28 / 711	60 / 1524	242
28 / 711	66 / 1676	316
28 / 711	72 / 1829	328
28 / 711	78 / 1981	341
28 / 711	84 / 2134	353
28 / 711	90 / 2286	364
28 / 711	96 / 2438	377
35 / 889	36 / 914	224
35 / 889	42 / 1067	237
35 / 889	48 / 1219	253
35 / 889	54 / 1372	268
35 / 889	60 / 1524	282

DIMENSIONS INCHES / MM		PRICING
H	W	
CALA CUT OUT FOR FOUR OUTLETS (6)		
HORIZONTAL (LC, RC, LR, CR or CL) & VERTICAL (B or T)		
21 / 533	66 / 1676	286
21 / 533	72 / 1829	297
21 / 533	78 / 1981	306
21 / 533	84 / 2134	315
21 / 533	90 / 2286	325
21 / 533	96 / 2438	334
22 / 559	66 / 1676	290
22 / 559	72 / 1829	300
22 / 559	78 / 1981	310
22 / 559	84 / 2134	321
22 / 559	90 / 2286	329
22 / 559	96 / 2438	338
27 / 686	66 / 1676	321
27 / 686	72 / 1829	331
27 / 686	78 / 1981	346
27 / 686	84 / 2134	356
27 / 686	90 / 2286	367
27 / 686	96 / 2438	379
28 / 711	66 / 1676	324
28 / 711	72 / 1829	334
28 / 711	78 / 1981	349
28 / 711	84 / 2134	359
28 / 711	90 / 2286	373
28 / 711	96 / 2438	383
HORIZONTAL (LL or RR) & VERTICAL (B or T)		
21 / 533	36 / 914	184
21 / 533	42 / 1067	195
21 / 533	48 / 1219	203
21 / 533	54 / 1372	211
21 / 533	60 / 1524	222
21 / 533	66 / 1676	286
21 / 533	72 / 1829	297
21 / 533	78 / 1981	306
21 / 533	84 / 2134	315
21 / 533	90 / 2286	325
21 / 533	96 / 2438	334

Pricing is continued on the following page.

U A E L I M
**Metal International Power/
 Communications Fascia for
 Freestanding District (Slot Mount)
 (Continued)**

DIMENSIONS INCHES / MM		PRICING
H	W	CALA CUT OUT FOR FOUR OUTLETS (6) HORIZONTAL (LL or RR) & VERTICAL (B or T) (Continued)
22 / 559	36 / 914	186
22 / 559	42 / 1067	197
22 / 559	48 / 1219	205
22 / 559	54 / 1372	214
22 / 559	60 / 1524	224
22 / 559	66 / 1676	290
22 / 559	72 / 1829	300
22 / 559	78 / 1981	310
22 / 559	84 / 2134	321
22 / 559	90 / 2286	329
22 / 559	96 / 2438	338
27 / 686	36 / 914	201
27 / 686	42 / 1067	211
27 / 686	48 / 1219	223
27 / 686	54 / 1372	233
27 / 686	60 / 1524	246
27 / 686	66 / 1676	321
27 / 686	72 / 1829	331
27 / 686	78 / 1981	346
27 / 686	84 / 2134	356
27 / 686	90 / 2286	367
27 / 686	96 / 2438	379

DIMENSIONS INCHES / MM		PRICING
H	W	CALA CUT OUT FOR FOUR OUTLETS (6) HORIZONTAL (LL or RR) & VERTICAL (B or T) (Continued)
28 / 711	36 / 914	203
28 / 711	42 / 1067	214
28 / 711	48 / 1219	226
28 / 711	54 / 1372	236
28 / 711	60 / 1524	249
28 / 711	66 / 1676	324
28 / 711	72 / 1829	334
28 / 711	78 / 1981	349
28 / 711	84 / 2134	359
28 / 711	90 / 2286	373
28 / 711	96 / 2438	383
35 / 889	36 / 914	230
35 / 889	42 / 1067	246
35 / 889	48 / 1219	259
35 / 889	54 / 1372	275
35 / 889	60 / 1524	288

UNELCF

Tackable Fabric Power/ Communications Fascia (Slot Mount)

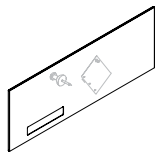

The Tackable Fabric Power/Communications Fascia provides face-mounted access to power/communications above or below worksurface height.

WHAT'S INCLUDED

1 fascia.

WHAT'S EXCLUDED

Fascia Light Block (UNEX) is required for additional segmentation and must be specified separately. Can be found in the *Panel Walls* section.

NOTES

7" high fascia is **not** tackable.

PRODUCT OPTIONS

Outlet Configuration	Horizontal Power/Communications Orientation	Vertical Power/Communications Orientation	Height	Width (6" increments)	Fascia Finish
2 One duplex outlet plus VDM (available on 24" and 30" widths)	L Left (not available on widths below 42")	B Bottom or Lower section of Fascia (available on 7", 13", 22", 26", 37" heights)	07, 13, 22, 26, 28, 37	24 - 96	Panel Fabric
	R Right (not available on widths below 42")				
4 Two duplex outlets plus VDM (available on 36" widths and wider)	B Both Left and Right (available on 66" width and wider for one and two duplex outlets)	F Flush (applies to 28" height only for base fascias flush to floor. Cut out will be at bottom)			
	C Centered (available on 36" width for two duplex outlets and on 24", 30", 36" widths for one duplex outlet)	T Top or Upper section of Fascia (available on 13", 22", 28" heights)			

SAMPLE ORDER CODE

UNELCF 2	B	B	13	72	L341
----------	---	---	----	----	------

DIMENSIONS INCHES / MM

H	W
7 / 178	66 / 1676
7 / 178	72 / 1829
7 / 178	78 / 1981
7 / 178	84 / 2134
7 / 178	90 / 2286
7 / 178	96 / 2438
13 / 330	66 / 1676
13 / 330	72 / 1829
13 / 330	78 / 1981
13 / 330	84 / 2134
13 / 330	90 / 2286
13 / 330	96 / 2438
22 / 559	66 / 1676
22 / 559	72 / 1829
22 / 559	78 / 1981
22 / 559	84 / 2134
22 / 559	90 / 2286
22 / 559	96 / 2438
26 / 660	66 / 1676
26 / 660	72 / 1829
26 / 660	78 / 1981
26 / 660	84 / 2134
26 / 660	90 / 2286
26 / 660	96 / 2438

PRICING

HORIZONTAL BOTH LEFT AND RIGHT (B) & VERTICAL BOTTOM OR LOWER (B)

Fabric A/COM	Gr. 1	Gr. 2	Gr. 3	Gr. 4	Gr. 5	Gr. 6	Gr. 7
195	201	212	224	234	246	257	268
205	212	226	236	249	260	274	285
218	225	238	252	264	277	290	303
228	236	252	265	280	293	307	322
238	249	263	279	295	308	324	337
251	259	278	293	308	324	340	356
172	181	206	219	232	249	266	282
183	196	223	233	249	268	286	305
196	208	236	251	268	286	307	327
207	222	253	266	285	306	328	349
221	234	268	283	303	325	349	372
232	249	283	300	321	344	370	392
247	262	279	331	370	395	429	460
265	283	301	357	400	427	463	499
284	304	324	383	429	458	500	535
304	325	346	410	459	489	533	574
323	346	366	436	488	522	568	611
341	364	388	462	517	554	604	649
272	303	383	411	445	484	528	568
293	327	417	450	486	529	577	621
313	351	442	477	515	559	610	658
334	376	477	512	555	604	659	710
356	400	510	551	596	648	708	763
378	424	544	586	635	691	757	816

Pricing is continued on the following page.

UNELCF
**Tackable Fabric Power/
Communications Fascia
(Slot Mount) (Continued)**

**DIMENSIONS
INCHES / MM**

H	W
37 / 940	66 / 1676
37 / 940	72 / 1829
37 / 940	78 / 1981
37 / 940	84 / 2134
37 / 940	90 / 2286
37 / 940	96 / 2438

28 / 711	66 / 1676
28 / 711	72 / 1829
28 / 711	78 / 1981
28 / 711	84 / 2134
28 / 711	90 / 2286
28 / 711	96 / 2438

13 / 330	66 / 1676
13 / 330	72 / 1829
13 / 330	78 / 1981
13 / 330	84 / 2134
13 / 330	90 / 2286
13 / 330	96 / 2438

22 / 559	66 / 1676
22 / 559	72 / 1829
22 / 559	78 / 1981
22 / 559	84 / 2134
22 / 559	90 / 2286
22 / 559	96 / 2438

28 / 711	66 / 1676
28 / 711	72 / 1829
28 / 711	78 / 1981
28 / 711	84 / 2134
28 / 711	90 / 2286
28 / 711	96 / 2438

7 / 178	24 / 610
7 / 178	30 / 762
7 / 178	36 / 914

13 / 330	24 / 610
13 / 330	30 / 762
13 / 330	36 / 914

22 / 559	24 / 610
22 / 559	30 / 762
22 / 559	36 / 914

26 / 660	24 / 610
26 / 660	30 / 762
26 / 660	36 / 914

37 / 940	24 / 610
37 / 940	30 / 762
37 / 940	36 / 914

PRICING
HORIZONTAL BOTH LEFT AND RIGHT (B) & VERTICAL BOTTOM OR LOWER (B) (CONTINUED)

Fabric A/COM	Gr. 1	Gr. 2	Gr. 3	Gr. 4	Gr. 5	Gr. 6	Gr. 7
399	431	463	568	645	694	763	827
430	465	502	614	697	752	827	896
461	502	538	661	752	810	890	965
494	535	577	708	806	867	954	1035
527	570	614	755	859	925	1018	1103
558	606	653	802	913	984	1082	1173

HORIZONTAL BOTH LEFT AND RIGHT (B) & VERTICAL FLUSH (F)

Fabric A/COM	Gr. 1	Gr. 2	Gr. 3	Gr. 4	Gr. 5	Gr. 6	Gr. 7
272	303	383	411	445	484	528	568
293	327	417	450	486	529	577	621
313	351	442	477	515	559	610	658
334	376	477	512	555	604	659	710
356	400	510	551	596	648	708	763
378	424	544	586	635	691	757	816

HORIZONTAL BOTH LEFT AND RIGHT (B) & VERTICAL TOP OR UPPER (T)

Fabric A/COM	Gr. 1	Gr. 2	Gr. 3	Gr. 4	Gr. 5	Gr. 6	Gr. 7
172	181	206	219	232	249	266	282
183	196	223	233	249	268	286	305
196	208	236	251	268	286	307	327
207	222	253	266	285	306	328	349
221	234	268	283	303	325	349	372
232	249	283	300	321	344	370	392
247	262	279	331	370	395	429	460
265	283	301	357	400	427	463	499
284	304	324	383	429	458	500	535
304	325	346	410	459	489	533	574
323	346	366	436	488	522	568	611
341	364	388	462	517	554	604	649
272	303	383	411	445	484	528	568
293	327	417	450	486	529	577	621
313	351	442	477	515	559	610	658
334	376	477	512	555	604	659	710
356	400	510	551	596	648	708	763
378	424	544	586	635	691	757	816

HORIZONTAL CENTERED (C) & VERTICAL BOTTOM OR LOWER (B)

Fabric A/COM	Gr. 1	Gr. 2	Gr. 3	Gr. 4	Gr. 5	Gr. 6	Gr. 7
119	121	124	129	134	137	144	148
128	132	148	152	157	162	172	178
139	146	156	160	168	174	180	186
96	101	106	116	123	128	134	143
106	113	136	146	155	164	176	185
118	127	147	153	161	173	184	196
126	131	136	157	173	182	196	207
144	151	182	196	209	224	242	258
159	173	195	212	232	252	273	290
136	151	160	178	194	206	222	234
156	174	211	226	242	260	282	303
176	200	235	252	271	290	315	336
186	198	207	247	276	295	319	342
218	229	270	299	329	359	392	424
248	266	286	346	388	416	455	490

Pricing is continued on the following page.

UNELCF

Tackable Fabric Power/ Communications Fascia (Slot Mount) (Continued)

DIMENSIONS INCHES / MM

H	W
28 / 711	24 / 610
28 / 711	30 / 762
28 / 711	36 / 914

H	W
13 / 330	24 / 610
13 / 330	30 / 762
13 / 330	36 / 914

22 / 559	24 / 610
22 / 559	30 / 762
22 / 559	36 / 914

28 / 711	24 / 610
28 / 711	30 / 762
28 / 711	36 / 914

H	W
7 / 178	42 / 1067
7 / 178	48 / 1219
7 / 178	54 / 1372
7 / 178	60 / 1524
7 / 178	66 / 1676
7 / 178	72 / 1829
7 / 178	78 / 1981
7 / 178	84 / 2134
7 / 178	90 / 2286
7 / 178	96 / 2438

13 / 330	42 / 1067
13 / 330	48 / 1219
13 / 330	54 / 1372
13 / 330	60 / 1524
13 / 330	66 / 1676
13 / 330	72 / 1829
13 / 330	78 / 1981
13 / 330	84 / 2134
13 / 330	90 / 2286
13 / 330	96 / 2438

22 / 559	42 / 1067
22 / 559	48 / 1219
22 / 559	54 / 1372
22 / 559	60 / 1524
22 / 559	66 / 1676
22 / 559	72 / 1829
22 / 559	78 / 1981
22 / 559	84 / 2134
22 / 559	90 / 2286
22 / 559	96 / 2438

PRICING

HORIZONTAL CENTERED (C) & VERTICAL FLUSH (F)

Fabric A/COM	Gr. 1	Gr. 2	Gr. 3	Gr. 4	Gr. 5	Gr. 6	Gr. 7
136	151	160	178	194	206	222	234
156	174	211	226	242	260	282	303
176	200	235	252	271	290	315	336

HORIZONTAL CENTERED (C) & VERTICAL TOP OR UPPER (T)

Fabric A/COM	Gr. 1	Gr. 2	Gr. 3	Gr. 4	Gr. 5	Gr. 6	Gr. 7
96	101	106	116	123	128	134	143
106	113	136	146	155	164	176	185
118	127	147	153	161	173	184	196
126	131	136	157	173	182	196	207
144	151	182	196	209	224	242	258
159	173	195	212	232	252	273	290
136	151	160	178	194	206	222	234
156	174	211	226	242	260	282	303
176	200	235	252	271	290	315	336

HORIZONTAL LEFT OR RIGHT (L or R) & VERTICAL BOTTOM OR LOWER (B)

Fabric A/COM	Gr. 1	Gr. 2	Gr. 3	Gr. 4	Gr. 5	Gr. 6	Gr. 7
151	156	167	173	180	186	196	203
160	168	175	184	194	201	209	219
173	178	186	197	206	214	225	233
183	189	200	209	220	229	240	250
195	201	212	224	234	246	257	268
205	212	226	236	249	260	274	285
218	225	238	252	264	277	290	303
228	236	252	265	280	293	307	322
238	249	263	279	295	308	324	337
251	259	278	293	308	324	340	356
127	136	153	161	173	184	198	208
137	148	160	175	187	200	212	226
149	157	178	186	199	212	228	242
158	170	191	202	214	230	247	260
172	181	206	219	232	249	266	282
183	196	223	233	249	268	286	305
196	208	236	251	268	286	307	327
207	222	253	266	285	306	328	349
221	234	268	283	303	325	349	372
232	249	283	300	321	344	370	392
177	189	205	234	258	277	300	322
195	205	218	255	284	303	328	351
210	223	236	279	310	331	359	385
227	238	257	303	337	359	389	418
247	262	279	331	370	395	429	460
265	283	301	357	400	427	463	499
284	304	324	383	429	458	500	535
304	325	346	410	459	489	533	574
323	346	366	436	488	522	568	611
341	364	388	462	517	554	604	649

Pricing is continued on the following page.

UNELCF
**Tackable Fabric Power/
Communications Fascia
(Slot Mount) (Continued)**

**DIMENSIONS
INCHES / MM**

H	W
26 / 660	42 / 1067
26 / 660	48 / 1219
26 / 660	54 / 1372
26 / 660	60 / 1524
26 / 660	66 / 1676
26 / 660	72 / 1829
26 / 660	78 / 1981
26 / 660	84 / 2134
26 / 660	90 / 2286
26 / 660	96 / 2438
37 / 940	42 / 1067
37 / 940	48 / 1219
37 / 940	54 / 1372
37 / 940	60 / 1524
37 / 940	66 / 1676
37 / 940	72 / 1829
37 / 940	78 / 1981
37 / 940	84 / 2134
37 / 940	90 / 2286
37 / 940	96 / 2438

PRICING
HORIZONTAL LEFT OR RIGHT (L or R) & VERTICAL BOTTOM OR LOWER (B) (CONTINUED)

Fabric A/COM	Gr. 1	Gr. 2	Gr. 3	Gr. 4	Gr. 5	Gr. 6	Gr. 7
195	221	250	268	290	316	342	366
212	238	263	293	322	347	375	402
231	258	318	340	367	399	432	464
251	279	350	376	406	439	479	514
272	303	383	411	445	484	528	568
293	327	417	450	486	529	577	621
313	351	442	477	515	559	610	658
334	376	477	512	555	604	659	710
356	400	510	551	596	648	708	763
378	424	544	586	635	691	757	816
277	297	313	382	432	462	507	548
306	325	347	421	477	510	559	604
336	357	389	471	533	574	630	681
366	387	427	513	581	627	687	744
399	431	463	568	645	694	763	827
430	465	502	614	697	752	827	896
461	502	538	661	752	810	890	965
494	535	577	708	806	867	954	1035
527	570	614	755	859	925	1018	1103
558	606	653	802	913	984	1082	1173

HORIZONTAL LEFT OR RIGHT (L or R) & VERTICAL FLUSH (F)

Fabric A/COM	Gr. 1	Gr. 2	Gr. 3	Gr. 4	Gr. 5	Gr. 6	Gr. 7
195	221	250	268	290	316	342	366
212	238	263	293	322	347	375	402
231	258	318	340	367	399	432	464
251	279	350	376	406	439	479	514
272	303	383	411	445	484	528	568
293	327	417	450	486	529	577	621
313	351	442	477	515	559	610	658
334	376	477	512	555	604	659	710
356	400	510	551	596	648	708	763
378	424	544	586	635	691	757	816
28 / 711	42 / 1067						
28 / 711	48 / 1219						
28 / 711	54 / 1372						
28 / 711	60 / 1524						
28 / 711	66 / 1676						
28 / 711	72 / 1829						
28 / 711	78 / 1981						
28 / 711	84 / 2134						
28 / 711	90 / 2286						
28 / 711	96 / 2438						

HORIZONTAL LEFT OR RIGHT (L or R) & VERTICAL TOP OR UPPER (T)

Fabric A/COM	Gr. 1	Gr. 2	Gr. 3	Gr. 4	Gr. 5	Gr. 6	Gr. 7
127	136	153	161	173	184	198	208
137	148	160	175	187	200	212	226
149	157	178	186	199	212	228	242
158	170	191	202	214	230	247	260
172	181	206	219	232	249	266	282
183	196	223	233	249	268	286	305
196	208	236	251	268	286	307	327
207	222	253	266	285	306	328	349
221	234	268	283	303	325	349	372
232	249	283	300	321	344	370	392
13 / 330	42 / 1067						
13 / 330	48 / 1219						
13 / 330	54 / 1372						
13 / 330	60 / 1524						
13 / 330	66 / 1676						
13 / 330	72 / 1829						
13 / 330	78 / 1981						
13 / 330	84 / 2134						
13 / 330	90 / 2286						
13 / 330	96 / 2438						

Pricing is continued on the following page.

UNELCF

**Tackable Fabric Power/
Communications Fascia
(Slot Mount) (Continued)**

**DIMENSIONS
INCHES / MM**

PRICING

DIMENSIONS		PRICING							
INCHES / MM		HORIZONTAL LEFT OR RIGHT (L or R) & VERTICAL TOP OR UPPER (T) (CONTINUED)							
H	W	Fabric A/COM	Gr. 1	Gr. 2	Gr. 3	Gr. 4	Gr. 5	Gr. 6	Gr. 7
22 / 559	42 / 1067	177	189	205	234	258	277	300	322
22 / 559	48 / 1219	195	205	218	255	284	303	328	351
22 / 559	54 / 1372	210	223	236	279	310	331	359	385
22 / 559	60 / 1524	227	238	257	303	337	359	389	418
22 / 559	66 / 1676	247	262	279	331	370	395	429	460
22 / 559	72 / 1829	265	283	301	357	400	427	463	499
22 / 559	78 / 1981	284	304	324	383	429	458	500	535
22 / 559	84 / 2134	304	325	346	410	459	489	533	574
22 / 559	90 / 2286	323	346	366	436	488	522	568	611
22 / 559	96 / 2438	341	364	388	462	517	554	604	649
28 / 711	42 / 1067	195	221	250	268	290	316	342	366
28 / 711	48 / 1219	212	238	263	293	322	347	375	402
28 / 711	54 / 1372	231	258	318	340	367	399	432	464
28 / 711	60 / 1524	251	279	350	376	406	439	479	514
28 / 711	66 / 1676	272	303	383	411	445	484	528	568
28 / 711	72 / 1829	293	327	417	450	486	529	577	621
28 / 711	78 / 1981	313	351	442	477	515	559	610	658
28 / 711	84 / 2134	334	376	477	512	555	604	659	710
28 / 711	90 / 2286	356	400	510	551	596	648	708	763
28 / 711	96 / 2438	378	424	544	586	635	691	757	816

U A E L C F

Tackable Fabric Power/ Communications Fascia for Freestanding District (Slot Mount)

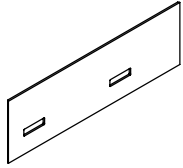

The Tackable Fabric Power/Communications Fascia provides a tackable panel wall finish.

WHAT'S INCLUDED

1 fascia.

NOTES

Fascia is to only be applied to District Panel that is supported by the Freestanding Foot (UAFFN).

The 22" fascia must be ordered with a 6" high fascia as Elevated panels are not applicable in a freestanding application.

For 36" to 60" wide fascias only Left (LL) or Right (RR) power and data locations can be specified.

PRODUCT OPTIONS

Outlet Configuration	Horizontal Power/ Communication Orientation	Vertical Power/ Communication Orientation	Height	Width (6" increments)	Fascia Finish
2 Cut Out for two outlets (available on 24" and 30" widths)	LL Left	T Top	22, 35	36 - 96	Panel Fabric
	LC Left Centre	B Bottom			
4 Cut Out for four outlets (available on 36" widths and wider)	RC Right Centre				
	RR Right				
	LR Left & Right				
	CR Left Centre and Right				
	CL Right Centre and Left				

SAMPLE ORDER CODE

UAELCF 2	RR	B	22	60	C503
----------	----	---	----	----	------

DIMENSIONS

INCHES / MM

H	W
22 / 559	66 / 1676
22 / 559	72 / 1829
22 / 559	78 / 1981
22 / 559	84 / 2134
22 / 559	90 / 2286
22 / 559	96 / 2438
35 / 889	66 / 1676
35 / 889	72 / 1829
35 / 889	78 / 1981
35 / 889	84 / 2134
35 / 889	90 / 2286
35 / 889	96 / 2438

PRICING

HORIZONTAL (LC, RC, LR, CR or CL) & VERTICAL (T or B)

Fabric A/COM	Gr. 1	Gr. 2	Gr. 3	Gr. 4	Gr. 5	Gr. 6	Gr. 7
247	262	279	331	370	395	429	460
265	283	301	357	400	427	463	499
284	304	324	383	429	458	500	535
304	325	346	410	459	489	533	574
323	346	366	436	488	522	568	611
341	364	388	462	517	554	604	649
388	423	454	558	635	685	753	816
420	456	490	605	688	741	816	886
452	489	529	650	740	798	879	954
482	525	564	696	794	857	942	1022
513	558	603	741	845	913	1006	1091
544	591	638	788	898	969	1068	1159

Pricing is continued on the following page.

U A E L C F
**Tackable Fabric Power/
Communications Fascia for
Freestanding District (Slot Mount)**
(Continued)

DIMENSIONS
INCHES / MM

H	W
22 / 559	36 / 914
22 / 559	42 / 1067
22 / 559	48 / 1219
22 / 559	54 / 1372
22 / 559	60 / 1524
22 / 559	66 / 1676
22 / 559	72 / 1829
22 / 559	78 / 1981
22 / 559	84 / 2134
22 / 559	90 / 2286
22 / 559	96 / 2438
35 / 889	36 / 914
35 / 889	42 / 1067
35 / 889	48 / 1219
35 / 889	54 / 1372
35 / 889	60 / 1524
35 / 889	66 / 1676
35 / 889	72 / 1829
35 / 889	78 / 1981
35 / 889	84 / 2134
35 / 889	90 / 2286
35 / 889	96 / 2438

PRICING
HORIZONTAL (LL or RR) & VERTICAL (B or T)

Fabric A/COM	Gr. 1	Gr. 2	Gr. 3	Gr. 4	Gr. 5	Gr. 6	Gr. 7
159	173	195	212	232	252	273	290
177	189	205	234	258	277	300	322
195	205	218	255	284	303	328	351
210	223	236	279	310	331	359	385
227	238	257	303	337	359	389	418
247	262	279	331	370	395	429	460
265	283	301	357	400	427	463	499
284	304	324	383	429	458	500	535
304	325	346	410	459	489	533	574
323	346	366	436	488	522	568	611
341	364	388	462	517	554	604	649
242	259	277	336	380	407	448	482
271	287	306	375	425	454	497	537
300	318	337	411	465	501	548	591
328	349	382	462	523	564	620	671
357	380	417	505	570	616	679	734
388	423	454	558	635	685	753	816
420	456	490	605	688	741	816	886
452	489	529	650	740	798	879	954
482	525	564	696	794	857	942	1022
513	558	603	741	845	913	1006	1091
544	591	638	788	898	969	1068	1159

UNELIF

Tackable Fabric International Power/Communications Fascia (Slot Mount)

The Tackable Fabric International Power/Communications Fascia provides face mounted access to power/communications above or below worksurface height.

WHAT'S INCLUDED

1 fascia.

WHAT'S EXCLUDED

Fascia Light Block (UNEX) is required for additional segmentation and must be specified separately. Can be found in the *Panel Walls* section.

NOTES

7" high fascia is **not** tackable.

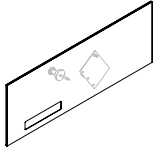

PRODUCT OPTIONS

Outlet Configuration	Horizontal Power/Communications Orientation	Vertical Power/Communications Orientation	Height	Width (6" increments)	Fascia Finish	Bezel Finish
2 Cut Out for two outlets (available on 24" and 30" widths)	B Left and Right (available on 66" width and wider)	B Bottom or lower section of Fascia (available on 7", 13", 22", 37" heights)	07, 13, 21, 22, 27, 28, 37	24 - 96	Foundation Mica	~ Black 74 Storm White
3 Cut Out for two outlets and one data/communications box (available on 36" widths and wider)	C Centered (available on 36" width for config. 3 and 4 (available on 24", 30", 36" widths for config. 2)	F Flush (applies to 28" height only for base fascias flush to floor. Cut Out will be at bottom)				
4 Cut Out for four outlets (available on 36" widths and wider)	L Left (not available on widths below 42")	T Top or upper section of Fascia (available on 13", 22", 28" heights)				
5 Cala Cut Out for two outlets	R Right (not available on widths below 42")					
6 Cala Cut Out for four outlets						

SAMPLE ORDER CODE

UNELIF 2	LC	B	22	66	E	74
----------	----	---	----	----	---	----

DIMENSIONS INCHES / MM

H	W
7 / 178	66 / 1676
7 / 178	72 / 1829
7 / 178	78 / 1981
7 / 178	84 / 2134
7 / 178	90 / 2286
7 / 178	96 / 2438
13 / 330	66 / 1676
13 / 330	72 / 1829
13 / 330	78 / 1981
13 / 330	84 / 2134
13 / 330	90 / 2286
13 / 330	96 / 2438
21 / 533	66 / 1676
21 / 533	72 / 1829
21 / 533	78 / 1981
21 / 533	84 / 2134
21 / 533	90 / 2286
21 / 533	96 / 2438

PRICING

CUT OUT OUTLET (2, 3, 4)

HORIZONTAL LEFT AND RIGHT (B) & VERTICAL BOTTOM OR LOWER (B)

Fabric A/COM	Gr. 1	Gr. 2	Gr. 3	Gr. 4	Gr. 5	Gr. 6	Gr. 7
195	201	212	224	234	246	257	268
205	212	226	236	249	260	274	285
218	225	238	252	264	277	290	303
228	236	252	265	280	293	307	322
238	249	263	279	295	308	324	337
251	259	278	293	308	324	340	356
172	181	206	219	232	249	266	282
183	196	223	233	249	268	286	305
196	208	236	251	268	286	307	327
207	222	253	266	285	306	328	349
221	234	268	283	303	325	349	372
232	249	283	300	321	344	370	392
245	259	276	328	366	391	427	457
261	280	299	354	397	424	460	494
281	301	321	381	427	455	496	532
300	322	341	407	456	486	530	569
319	341	362	433	485	518	564	607
336	360	384	459	514	551	599	644

Pricing is continued on the following page.

UNELIF
**Tackable Fabric International Power/
 Communications Fascia
 (Slot Mount) (Continued)**

**DIMENSIONS
 INCHES / MM**

H	W
22 / 559	66 / 1676
22 / 559	72 / 1829
22 / 559	78 / 1981
22 / 559	84 / 2134
22 / 559	90 / 2286
22 / 559	96 / 2438
37 / 940	66 / 1676
37 / 940	72 / 1829
37 / 940	78 / 1981
37 / 940	84 / 2134
37 / 940	90 / 2286
37 / 940	96 / 2438
27 / 686	66 / 1676
27 / 686	72 / 1829
27 / 686	78 / 1981
27 / 686	84 / 2134
27 / 686	90 / 2286
27 / 686	96 / 2438
28 / 711	66 / 1676
28 / 711	72 / 1829
28 / 711	78 / 1981
28 / 711	84 / 2134
28 / 711	90 / 2286
28 / 711	96 / 2438
13 / 330	66 / 1676
13 / 330	72 / 1829
13 / 330	78 / 1981
13 / 330	84 / 2134
13 / 330	90 / 2286
13 / 330	96 / 2438
21 / 533	66 / 1676
21 / 533	72 / 1829
21 / 533	78 / 1981
21 / 533	84 / 2134
21 / 533	90 / 2286
21 / 533	96 / 2438
22 / 559	66 / 1676
22 / 559	72 / 1829
22 / 559	78 / 1981
22 / 559	84 / 2134
22 / 559	90 / 2286
22 / 559	96 / 2438
27 / 686	66 / 1676

PRICING
CUT OUT OUTLET (2, 3, 4)
HORIZONTAL LEFT AND RIGHT (B) & VERTICAL BOTTOM OR LOWER (B) (Continued)

Fabric A/COM	Gr. 1	Gr. 2	Gr. 3	Gr. 4	Gr. 5	Gr. 6	Gr. 7
247	262	279	331	370	395	429	460
265	283	301	357	400	427	463	499
284	304	324	383	429	458	500	535
304	325	346	410	459	489	533	574
323	346	366	436	488	522	568	611
341	364	388	462	517	554	604	649
399	431	463	568	645	694	763	827
430	465	502	614	697	752	827	896
461	502	538	661	752	810	890	965
494	535	577	708	806	867	954	1035
527	570	614	755	859	925	1018	1103
558	606	653	802	913	984	1082	1173

HORIZONTAL LEFT AND RIGHT (B) & VERTICAL FLUSH (F)

Fabric A/COM	Gr. 1	Gr. 2	Gr. 3	Gr. 4	Gr. 5	Gr. 6	Gr. 7
270	301	380	409	442	481	526	565
288	325	413	446	484	526	574	618
310	348	438	474	512	556	607	655
331	372	474	509	552	601	656	707
353	395	507	547	593	644	705	760
374	418	539	583	633	688	753	812
272	303	383	411	445	484	528	568
293	327	417	450	486	529	577	621
313	351	442	477	515	559	610	658
334	376	477	512	555	604	659	710
356	400	510	551	596	648	708	763
378	424	544	586	635	691	757	816

HORIZONTAL LEFT AND RIGHT (B) & VERTICAL TOP OR UPPER (T)

Fabric A/COM	Gr. 1	Gr. 2	Gr. 3	Gr. 4	Gr. 5	Gr. 6	Gr. 7
172	181	206	219	232	249	266	282
183	196	223	233	249	268	286	305
196	208	236	251	268	286	307	327
207	222	253	266	285	306	328	349
221	234	268	283	303	325	349	372
232	249	283	300	321	344	370	392
245	259	276	328	366	391	427	457
261	280	299	354	397	424	460	494
281	301	321	381	427	455	496	532
300	322	341	407	456	486	530	569
319	341	362	433	485	518	564	607
336	360	384	459	514	551	599	644
247	262	279	331	370	395	429	460
265	283	301	357	400	427	463	499
284	304	324	383	429	458	500	535
304	325	346	410	459	489	533	574
323	346	366	436	488	522	568	611
341	364	388	462	517	554	604	649
270	301	380	409	442	481	526	565

Pricing is continued on the following page.

UNELIF

Tackable Fabric International Power/Communications Fascia (Slot Mount) (Continued)

DIMENSIONS INCHES / MM

H	W
27 / 686	72 / 1829
27 / 686	78 / 1981
27 / 686	84 / 2134
27 / 686	90 / 2286
27 / 686	96 / 2438
28 / 711	66 / 1676
28 / 711	72 / 1829
28 / 711	78 / 1981
28 / 711	84 / 2134
28 / 711	90 / 2286
28 / 711	96 / 2438

7 / 178	24 / 610
7 / 178	30 / 762
7 / 178	36 / 914
13 / 330	24 / 610
13 / 330	30 / 762
13 / 330	36 / 914
21 / 533	24 / 610
21 / 533	30 / 762
21 / 533	36 / 914
22 / 559	24 / 610
22 / 559	30 / 762
22 / 559	36 / 914
37 / 940	24 / 610
37 / 940	30 / 762
37 / 940	36 / 914

27 / 686	24 / 610
27 / 686	30 / 762
27 / 686	36 / 914
28 / 711	24 / 610
28 / 711	30 / 762
28 / 711	36 / 914

PRICING

CUT OUT OUTLET (2, 3, 4)

HORIZONTAL LEFT AND RIGHT (B) & VERTICAL TOP OR UPPER (T) (Continued)

Fabric A/COM	Gr. 1	Gr. 2	Gr. 3	Gr. 4	Gr. 5	Gr. 6	Gr. 7
288	325	413	446	484	526	574	618
310	348	438	474	512	556	607	655
331	372	474	509	552	601	656	707
353	395	507	547	593	644	705	760
374	418	539	583	633	688	753	812
272	303	383	411	445	484	528	568
293	327	417	450	486	529	577	621
313	351	442	477	515	559	610	658
334	376	477	512	555	604	659	710
356	400	510	551	596	648	708	763
378	424	544	586	635	691	757	816

HORIZONTAL CENTERED (C) & VERTICAL BOTTOM OR LOWER (B)

Fabric A/COM	Gr. 1	Gr. 2	Gr. 3	Gr. 4	Gr. 5	Gr. 6	Gr. 7
119	121	124	129	134	137	144	148
128	132	148	152	157	162	172	178
139	146	156	160	168	174	180	186
96	101	106	116	123	128	134	143
106	113	136	146	155	164	176	185
118	127	147	153	161	173	184	196
125	130	135	156	172	180	195	206
143	150	179	191	205	220	235	252
158	171	189	210	230	249	270	287
126	131	136	157	173	182	196	207
144	151	182	196	209	224	242	258
159	173	195	212	232	252	273	290
186	198	207	247	276	295	319	342
218	229	270	299	329	359	392	424
248	266	286	346	388	416	455	490

HORIZONTAL CENTERED (C) & VERTICAL FLUSH (F)

Fabric A/COM	Gr. 1	Gr. 2	Gr. 3	Gr. 4	Gr. 5	Gr. 6	Gr. 7
135	149	158	177	193	204	220	233
154	173	207	222	237	255	277	297
174	198	231	247	264	284	308	330
136	151	160	178	194	206	222	234
156	174	211	226	242	260	282	303
176	200	235	252	271	290	315	336

Pricing is continued on the following page.

UNELIF
Tackable Fabric International
Power/Communications Fascia
(Slot Mount) (Continued)

DIMENSIONS
INCHES / MM

H	W
13 / 330	24 / 610
13 / 330	30 / 762
13 / 330	36 / 914
21 / 533	24 / 610
21 / 533	30 / 762
21 / 533	36 / 914
22 / 559	24 / 610
22 / 559	30 / 762
22 / 559	36 / 914
27 / 686	24 / 610
27 / 686	30 / 762
27 / 686	36 / 914
28 / 711	24 / 610
28 / 711	30 / 762
28 / 711	36 / 914

7 / 178	42 / 1067
7 / 178	48 / 1219
7 / 178	54 / 1372
7 / 178	60 / 1524
7 / 178	66 / 1676
7 / 178	72 / 1829
7 / 178	78 / 1981
7 / 178	84 / 2134
7 / 178	90 / 2286
7 / 178	96 / 2438
13 / 330	42 / 1067
13 / 330	48 / 1219
13 / 330	54 / 1372
13 / 330	60 / 1524
13 / 330	66 / 1676
13 / 330	72 / 1829
13 / 330	78 / 1981
13 / 330	84 / 2134
13 / 330	90 / 2286
13 / 330	96 / 2438
21 / 533	42 / 1067
21 / 533	48 / 1219
21 / 533	54 / 1372
21 / 533	60 / 1524
21 / 533	66 / 1676
21 / 533	72 / 1829
21 / 533	78 / 1981
21 / 533	84 / 2134
21 / 533	90 / 2286
21 / 533	96 / 2438

PRICING
CUT OUT OUTLET (2, 3, 4)
HORIZONTAL CENTERED (C) & VERTICAL TOP OR UPPER (T)

Fabric A/COM	Gr. 1	Gr. 2	Gr. 3	Gr. 4	Gr. 5	Gr. 6	Gr. 7
96	101	106	116	123	128	134	143
106	113	136	146	155	164	176	185
118	127	147	153	161	173	184	196
125	130	135	156	172	180	195	206
143	150	179	191	205	220	235	252
158	171	189	210	230	249	270	287
126	131	136	157	173	182	196	207
144	151	182	196	209	224	242	258
159	173	195	212	232	252	273	290
135	149	158	177	193	204	220	233
154	173	207	222	237	255	277	297
174	198	231	247	264	284	308	330
136	151	160	178	194	206	222	234
156	174	211	226	242	260	282	303
176	200	235	252	271	290	315	336

HORIZONTAL LEFT OR RIGHT (L or R) & VERTICAL BOTTOM OR LOWER (B)

Fabric A/COM	Gr. 1	Gr. 2	Gr. 3	Gr. 4	Gr. 5	Gr. 6	Gr. 7
151	156	167	173	180	186	196	203
160	168	175	184	194	201	209	219
173	178	186	197	206	214	225	233
183	189	200	209	220	229	240	250
195	201	212	224	234	246	257	268
205	212	226	236	249	260	274	285
218	225	238	252	264	277	290	303
228	236	252	265	280	293	307	322
238	249	263	279	295	308	324	337
251	259	278	293	308	324	340	356
127	136	153	161	173	184	198	208
137	148	160	175	187	200	212	226
149	157	178	186	199	212	228	242
158	170	191	202	214	230	247	260
172	181	206	219	232	249	266	282
183	196	223	233	249	268	286	305
196	208	236	251	268	286	307	327
207	222	253	266	285	306	328	349
221	234	268	283	303	325	349	372
232	249	283	300	321	344	370	392
175	186	201	231	256	274	297	318
193	203	212	253	282	300	325	348
207	221	234	277	308	329	356	382
225	236	254	300	334	356	387	416
245	259	276	328	366	391	427	457
261	280	299	354	397	424	460	494
281	301	321	381	427	455	496	532
300	322	341	407	456	486	530	569
319	341	362	433	485	518	564	607
336	360	384	459	514	551	599	644

Pricing is continued on the following page.

UNELIF

Tackable Fabric International Power/ Communications Fascia (Slot Mount) (Continued)

DIMENSIONS INCHES / MM

22 / 559	42 / 1067
22 / 559	48 / 1219
22 / 559	54 / 1372
22 / 559	60 / 1524
22 / 559	66 / 1676
22 / 559	72 / 1829
22 / 559	78 / 1981
22 / 559	84 / 2134
22 / 559	90 / 2286
22 / 559	96 / 2438
37 / 940	42 / 1067
37 / 940	48 / 1219
37 / 940	54 / 1372
37 / 940	60 / 1524
37 / 940	66 / 1676
37 / 940	72 / 1829
37 / 940	78 / 1981
37 / 940	84 / 2134
37 / 940	90 / 2286
37 / 940	96 / 2438

27 / 686	42 / 1067
27 / 686	48 / 1219
27 / 686	54 / 1372
27 / 686	60 / 1524
27 / 686	66 / 1676
27 / 686	72 / 1829
27 / 686	78 / 1981
27 / 686	84 / 2134
27 / 686	90 / 2286
27 / 686	96 / 2438

28 / 711	42 / 1067
28 / 711	48 / 1219
28 / 711	54 / 1372
28 / 711	60 / 1524
28 / 711	66 / 1676
28 / 711	72 / 1829
28 / 711	78 / 1981
28 / 711	84 / 2134
28 / 711	90 / 2286
28 / 711	96 / 2438

PRICING

CUT OUT OUTLET (2, 3, 4)

HORIZONTAL LEFT OR RIGHT (L or R) & VERTICAL BOTTOM OR LOWER (B) (Continued)

Fabric	A/COM	Gr. 1	Gr. 2	Gr. 3	Gr. 4	Gr. 5	Gr. 6	Gr. 7
	177	189	205	234	258	277	300	322
	195	205	218	255	284	303	328	351
	210	223	236	279	310	331	359	385
	227	238	257	303	337	359	389	418
	247	262	279	331	370	395	429	460
	265	283	301	357	400	427	463	499
	284	304	324	383	429	458	500	535
	304	325	346	410	459	489	533	574
	323	346	366	436	488	522	568	611
	341	364	388	462	517	554	604	649
	277	297	313	382	432	462	507	548
	306	325	347	421	477	510	559	604
	336	357	389	471	533	574	630	681
	366	387	427	513	581	627	687	744
	399	431	463	568	645	694	763	827
	430	465	502	614	697	752	827	896
	461	502	538	661	752	810	890	965
	494	535	577	708	806	867	954	1035
	527	570	614	755	859	925	1018	1103
	558	606	653	802	913	984	1082	1173

HORIZONTAL LEFT OR RIGHT (L or R) & VERTICAL FLUSH (F)

Fabric	A/COM	Gr. 1	Gr. 2	Gr. 3	Gr. 4	Gr. 5	Gr. 6	Gr. 7
	194	219	246	265	288	312	338	362
	210	236	258	288	316	342	372	398
	229	256	315	337	364	397	430	462
	248	276	348	374	404	436	477	512
	270	301	380	409	442	481	526	565
	288	325	413	446	484	526	574	618
	310	348	438	474	512	556	607	655
	331	372	474	509	552	601	656	707
	353	395	507	547	593	644	705	760
	374	418	539	583	633	688	753	812
	195	221	250	268	290	316	342	366
	212	238	263	293	322	347	375	402
	231	258	318	340	367	399	432	464
	251	279	350	376	406	439	479	514
	272	303	383	411	445	484	528	568
	293	327	417	450	486	529	577	621
	313	351	442	477	515	559	610	658
	334	376	477	512	555	604	659	710
	356	400	510	551	596	648	708	763
	378	424	544	586	635	691	757	816

Pricing is continued on the following page.

UNELIF

Tackable Fabric International Power/ Communications Fascia (Slot Mount) (Continued)

DIMENSIONS
INCHES / MM

H	W
13 / 330	42 / 1067
13 / 330	48 / 1219
13 / 330	54 / 1372
13 / 330	60 / 1524
13 / 330	66 / 1676
13 / 330	72 / 1829
13 / 330	78 / 1981
13 / 330	84 / 2134
13 / 330	90 / 2286
13 / 330	96 / 2438
21 / 533	42 / 1067
21 / 533	48 / 1219
21 / 533	54 / 1372
21 / 533	60 / 1524
21 / 533	66 / 1676
21 / 533	72 / 1829
21 / 533	78 / 1981
21 / 533	84 / 2134
21 / 533	90 / 2286
21 / 533	96 / 2438
22 / 559	42 / 1067
22 / 559	48 / 1219
22 / 559	54 / 1372
22 / 559	60 / 1524
22 / 559	66 / 1676
22 / 559	72 / 1829
22 / 559	78 / 1981
22 / 559	84 / 2134
22 / 559	90 / 2286
22 / 559	96 / 2438
27 / 686	42 / 1067
27 / 686	48 / 1219
27 / 686	54 / 1372
27 / 686	60 / 1524
27 / 686	66 / 1676
27 / 686	72 / 1829
27 / 686	78 / 1981
27 / 686	84 / 2134
27 / 686	90 / 2286
27 / 686	96 / 2438

PRICING
CUT OUT OUTLET (2, 3, 4)
HORIZONTAL LEFT OR RIGHT (L or R) & VERTICAL TOP OR UPPER (T)

Fabric A/COM	Gr. 1	Gr. 2	Gr. 3	Gr. 4	Gr. 5	Gr. 6	Gr. 7
127	136	153	161	173	184	198	208
137	148	160	175	187	200	212	226
149	157	178	186	199	212	228	242
158	170	191	202	214	230	247	260
172	181	206	219	232	249	266	282
183	196	223	233	249	268	286	305
196	208	236	251	268	286	307	327
207	222	253	266	285	306	328	349
221	234	268	283	303	325	349	372
232	249	283	300	321	344	370	392
175	186	201	231	256	274	297	318
193	203	212	253	282	300	325	348
207	221	234	277	308	329	356	382
225	236	254	300	334	356	387	416
245	259	276	328	366	391	427	457
261	280	299	354	397	424	460	494
281	301	321	381	427	455	496	532
300	322	341	407	456	486	530	569
319	341	362	433	485	518	564	607
336	360	384	459	514	551	599	644
177	189	205	234	258	277	300	322
195	205	218	255	284	303	328	351
210	223	236	279	310	331	359	385
227	238	257	303	337	359	389	418
247	262	279	331	370	395	429	460
265	283	301	357	400	427	463	499
284	304	324	383	429	458	500	535
304	325	346	410	459	489	533	574
323	346	366	436	488	522	568	611
341	364	388	462	517	554	604	649
194	219	246	265	288	312	338	362
210	236	258	288	316	342	372	398
229	256	315	337	364	397	430	462
248	276	348	374	404	436	477	512
270	301	380	409	442	481	526	565
288	325	413	446	484	526	574	618
310	348	438	474	512	556	607	655
331	372	474	509	552	601	656	707
353	395	507	547	593	644	705	760
374	418	539	583	633	688	753	812

Pricing is continued on the following page.

UNELIF

Tackable Fabric International Power/ Communications Fascia (Slot Mount) (Continued)

DIMENSIONS INCHES / MM

H	W
28 / 711	42 / 1067
28 / 711	48 / 1219
28 / 711	54 / 1372
28 / 711	60 / 1524
28 / 711	66 / 1676
28 / 711	72 / 1829
28 / 711	78 / 1981
28 / 711	84 / 2134
28 / 711	90 / 2286
28 / 711	96 / 2438

7 / 178	66 / 1676
7 / 178	72 / 1829
7 / 178	78 / 1981
7 / 178	84 / 2134
7 / 178	90 / 2286
7 / 178	96 / 2438

13 / 330	66 / 1676
13 / 330	72 / 1829
13 / 330	78 / 1981
13 / 330	84 / 2134
13 / 330	90 / 2286
13 / 330	96 / 2438

21 / 533	66 / 1676
21 / 533	72 / 1829
21 / 533	78 / 1981
21 / 533	84 / 2134
21 / 533	90 / 2286
21 / 533	96 / 2438

22 / 559	66 / 1676
22 / 559	72 / 1829
22 / 559	78 / 1981
22 / 559	84 / 2134
22 / 559	90 / 2286
22 / 559	96 / 2438

37 / 940	66 / 1676
37 / 940	72 / 1829
37 / 940	78 / 1981
37 / 940	84 / 2134
37 / 940	90 / 2286
37 / 940	96 / 2438

PRICING

CUT OUT OUTLET (2, 3, 4)

HORIZONTAL LEFT OR RIGHT (L or R) & VERTICAL TOP OR UPPER (T) (Continued)

Fabric	Gr. 1	Gr. 2	Gr. 3	Gr. 4	Gr. 5	Gr. 6	Gr. 7
A/COM							
195	221	250	268	290	316	342	366
212	238	263	293	322	347	375	402
231	258	318	340	367	399	432	464
251	279	350	376	406	439	479	514
272	303	383	411	445	484	528	568
293	327	417	450	486	529	577	621
313	351	442	477	515	559	610	658
334	376	477	512	555	604	659	710
356	400	510	551	596	648	708	763
378	424	544	586	635	691	757	816

CALA CUT OUT FOR TWO OUTLETS (5)

HORIZONTAL LEFT AND RIGHT (B) & VERTICAL BOTTOM OR LOWER (B)

Fabric	Gr. 1	Gr. 2	Gr. 3	Gr. 4	Gr. 5	Gr. 6	Gr. 7
A/COM							
222	228	240	251	261	273	284	296
232	240	253	263	276	287	301	312
245	252	266	279	291	304	318	330
255	263	279	293	307	321	334	349
266	276	291	306	322	335	351	364
278	286	305	321	335	351	367	383
199	208	233	246	259	276	295	309
210	223	250	260	276	296	313	332
223	235	263	278	296	313	334	354
234	249	280	295	312	333	355	376
248	261	296	310	330	352	376	399
259	276	310	327	348	372	398	420
272	286	303	355	393	418	454	484
288	307	326	381	424	451	487	522
308	328	348	408	454	482	523	559
327	349	369	434	483	513	557	596
347	369	389	460	512	545	591	634
363	387	411	486	541	578	627	671
274	290	306	358	398	423	456	487
293	310	328	384	427	454	490	526
311	331	351	410	456	485	527	562
331	352	373	437	486	517	560	602
350	373	393	463	515	550	595	638
369	392	416	489	544	581	631	676
426	458	490	595	672	721	790	854
457	493	529	641	725	780	854	923
488	529	565	688	780	837	917	992
522	562	604	735	833	895	981	1062
554	598	641	782	886	953	1045	1131
585	633	680	829	940	1011	1109	1200

Pricing is continued on the following page.

UNELIF
**Tackable Fabric International Power/
 Communications Fascia
 (Slot Mount) (Continued)**

DIMENSIONS
INCHES / MM

H	W
27 / 686	66 / 1676
27 / 686	72 / 1829
27 / 686	78 / 1981
27 / 686	84 / 2134
27 / 686	90 / 2286
27 / 686	96 / 2438
28 / 711	66 / 1676
28 / 711	72 / 1829
28 / 711	78 / 1981
28 / 711	84 / 2134
28 / 711	90 / 2286
28 / 711	96 / 2438

13 / 330	66 / 1676
13 / 330	72 / 1829
13 / 330	78 / 1981
13 / 330	84 / 2134
13 / 330	90 / 2286
13 / 330	96 / 2438
21 / 533	66 / 1676
21 / 533	72 / 1829
21 / 533	78 / 1981
21 / 533	84 / 2134
21 / 533	90 / 2286
21 / 533	96 / 2438

22 / 559	66 / 1676
22 / 559	72 / 1829
22 / 559	78 / 1981
22 / 559	84 / 2134
22 / 559	90 / 2286
22 / 559	96 / 2438

27 / 686	66 / 1676
27 / 686	72 / 1829
27 / 686	78 / 1981
27 / 686	84 / 2134
27 / 686	90 / 2286
27 / 686	96 / 2438

28 / 711	66 / 1676
28 / 711	72 / 1829
28 / 711	78 / 1981
28 / 711	84 / 2134
28 / 711	90 / 2286
28 / 711	96 / 2438

PRICING
CALA CUT OUT FOR TWO OUTLETS (5)
HORIZONTAL LEFT AND RIGHT (B) & VERTICAL FLUSH (F)

Fabric A/COM	Gr. 1	Gr. 2	Gr. 3	Gr. 4	Gr. 5	Gr. 6	Gr. 7
297	328	407	436	469	508	553	593
316	352	441	474	510	553	602	645
337	375	465	501	539	583	634	682
358	399	501	536	579	628	683	734
380	423	534	574	620	671	732	787
401	446	567	610	660	715	781	839
299	330	410	438	472	511	555	595
321	354	445	477	513	556	604	649
341	378	469	504	542	586	637	685
361	403	504	539	582	631	686	737
383	427	537	578	624	675	735	790
405	451	572	613	663	719	784	843

HORIZONTAL LEFT AND RIGHT (B) & VERTICAL TOP OR UPPER (T)

Fabric A/COM	Gr. 1	Gr. 2	Gr. 3	Gr. 4	Gr. 5	Gr. 6	Gr. 7
199	208	233	246	259	276	295	309
210	223	250	260	276	296	313	332
223	235	263	278	296	313	334	354
234	249	280	295	312	333	355	376
248	261	296	310	330	352	376	399
259	276	310	327	348	372	398	420
272	286	303	355	393	418	454	484
288	307	326	381	424	451	487	522
308	328	348	408	454	482	523	559
327	349	369	434	483	513	557	596
347	369	389	460	512	545	591	634
363	387	411	486	541	578	627	671
274	290	306	358	398	423	456	487
293	310	328	384	427	454	490	526
311	331	351	410	456	485	527	562
331	352	373	437	486	517	560	602
350	373	393	463	515	550	595	638
369	392	416	489	544	581	631	676
297	328	407	436	469	508	553	593
316	352	441	474	510	553	602	645
337	375	465	501	539	583	634	682
358	399	501	536	579	628	683	734
380	423	534	574	620	671	732	787
401	446	567	610	660	715	781	839
299	330	410	438	472	511	555	595
321	354	445	477	513	556	604	649
341	378	469	504	542	586	637	685
361	403	504	539	582	631	686	737
383	427	537	578	624	675	735	790
405	451	572	613	663	719	784	843

Pricing is continued on the following page.

UNELIF

Tackable Fabric International Power/ Communications Fascia (Slot Mount) (Continued)

DIMENSIONS INCHES / MM

H	W
7 / 178	24 / 610
7 / 178	30 / 762
7 / 178	36 / 914
13 / 330	24 / 610
13 / 330	30 / 762
13 / 330	36 / 914
21 / 533	24 / 610
21 / 533	30 / 762
21 / 533	36 / 914
22 / 559	24 / 610
22 / 559	30 / 762
22 / 559	36 / 914
37 / 940	24 / 610
37 / 940	30 / 762
37 / 940	36 / 914
27 / 686	24 / 610
27 / 686	30 / 762
27 / 686	36 / 914
28 / 711	24 / 610
28 / 711	30 / 762
28 / 711	36 / 914
13 / 330	24 / 610
13 / 330	30 / 762
13 / 330	36 / 914
21 / 533	24 / 610
21 / 533	30 / 762
21 / 533	36 / 914
22 / 559	24 / 610
22 / 559	30 / 762
22 / 559	36 / 914
27 / 686	24 / 610
27 / 686	30 / 762
27 / 686	36 / 914
28 / 711	24 / 610
28 / 711	30 / 762
28 / 711	36 / 914

PRICING

CALA CUT OUT FOR TWO OUTLETS (5)

HORIZONTAL CENTERED (C) & VERTICAL BOTTOM OR LOWER (B)

Fabric	Gr. 1	Gr. 2	Gr. 3	Gr. 4	Gr. 5	Gr. 6	Gr. 7
A/COM							
146	148	151	156	161	167	171	175
155	159	175	179	184	191	199	205
168	173	183	187	195	201	207	214
123	128	133	143	150	155	161	170
133	142	164	173	182	193	203	212
145	154	174	180	188	200	211	223
152	157	162	183	199	207	222	233
170	177	206	219	232	247	262	279
185	198	218	237	257	276	297	315
153	158	164	184	200	209	223	234
171	178	209	223	236	251	270	285
186	200	222	240	260	279	300	318
214	225	234	274	303	322	347	370
245	256	297	326	356	386	420	451
275	295	313	373	415	443	482	518

HORIZONTAL CENTERED (C) & VERTICAL FLUSH (F)

Fabric	Gr. 1	Gr. 2	Gr. 3	Gr. 4	Gr. 5	Gr. 6	Gr. 7
A/COM							
162	176	185	204	220	231	247	260
181	200	234	249	264	282	304	324
201	225	258	274	291	311	335	357
164	178	187	205	221	233	249	261
183	201	238	253	270	287	309	330
203	227	262	279	298	318	342	363

HORIZONTAL CENTERED (C) & VERTICAL TOP OR UPPER (T)

Fabric	Gr. 1	Gr. 2	Gr. 3	Gr. 4	Gr. 5	Gr. 6	Gr. 7
A/COM							
123	128	133	143	150	155	161	170
133	142	164	173	182	193	203	212
145	154	174	180	188	200	211	223
152	157	162	183	199	207	222	233
170	177	206	219	232	247	262	279
185	198	218	237	257	276	297	315
153	158	164	184	200	209	223	234
171	178	209	223	236	251	270	285
186	200	222	240	260	279	300	318
162	176	185	204	220	231	247	260
181	200	234	249	264	282	304	324
201	225	258	274	291	311	335	357
164	178	187	205	221	233	249	261
183	201	238	253	270	287	309	330
203	227	262	279	298	318	342	363

Pricing is continued on the following page.

UNELIF
**Tackable Fabric International Power/
Communications Fascia
(Slot Mount) (Continued)**

**DIMENSIONS
INCHES / MM**

H	W
7 / 178	42 / 1067
7 / 178	48 / 1219
7 / 178	54 / 1372
7 / 178	60 / 1524
7 / 178	66 / 1676
7 / 178	72 / 1829
7 / 178	78 / 1981
7 / 178	84 / 2134
7 / 178	90 / 2286
7 / 178	96 / 2438
13 / 330	42 / 1067
13 / 330	48 / 1219
13 / 330	54 / 1372
13 / 330	60 / 1524
13 / 330	66 / 1676
13 / 330	72 / 1829
13 / 330	78 / 1981
13 / 330	84 / 2134
13 / 330	90 / 2286
13 / 330	96 / 2438
21 / 533	42 / 1067
21 / 533	48 / 1219
21 / 533	54 / 1372
21 / 533	60 / 1524
21 / 533	66 / 1676
21 / 533	72 / 1829
21 / 533	78 / 1981
21 / 533	84 / 2134
21 / 533	90 / 2286
21 / 533	96 / 2438
22 / 559	42 / 1067
22 / 559	48 / 1219
22 / 559	54 / 1372
22 / 559	60 / 1524
22 / 559	66 / 1676
22 / 559	72 / 1829
22 / 559	78 / 1981
22 / 559	84 / 2134
22 / 559	90 / 2286
22 / 559	96 / 2438
37 / 940	42 / 1067
37 / 940	48 / 1219
37 / 940	54 / 1372
37 / 940	60 / 1524
37 / 940	66 / 1676
37 / 940	72 / 1829
37 / 940	78 / 1981
37 / 940	84 / 2134
37 / 940	90 / 2286
37 / 940	96 / 2438

PRICING
CALA CUT OUT FOR TWO OUTLETS (5)
HORIZONTAL LEFT OR RIGHT (L or R) & VERTICAL BOTTOM OR LOWER (B)

Fabric A/COM	Gr. 1	Gr. 2	Gr. 3	Gr. 4	Gr. 5	Gr. 6	Gr. 7
178	183	194	200	207	214	223	230
187	195	202	211	221	228	236	246
200	205	214	224	233	242	252	260
210	218	227	236	247	256	268	277
222	228	240	251	261	273	284	296
232	240	253	263	276	287	301	312
245	252	266	279	291	304	318	330
255	263	279	293	307	321	334	349
266	276	291	306	322	335	351	364
278	286	305	321	335	351	367	383
154	164	180	189	201	211	225	235
167	175	187	202	214	227	240	253
176	184	205	214	227	240	255	270
185	197	219	229	242	257	274	287
199	208	233	246	259	276	295	309
210	223	250	260	276	296	313	332
223	235	263	278	296	313	334	354
234	249	280	295	312	a333	355	376
248	261	296	310	330	352	376	399
259	276	310	327	348	372	398	420
202	214	228	258	283	301	324	346
220	230	240	280	309	327	352	375
234	248	261	304	335	356	383	409
252	263	281	327	361	383	414	443
272	286	303	355	393	418	454	484
288	307	326	381	424	451	487	522
308	328	348	408	454	482	523	559
327	349	369	434	483	513	557	596
347	369	389	460	512	545	591	634
363	387	411	486	541	578	627	671
204	218	232	261	285	304	327	349
222	232	245	282	311	330	355	378
237	250	263	306	337	358	386	412
254	266	284	330	364	386	417	446
274	290	306	358	398	423	456	487
293	310	328	384	427	454	490	526
311	331	351	410	456	485	527	562
331	352	373	437	486	517	560	602
350	373	393	463	515	550	595	638
369	392	416	489	544	581	631	676
304	324	341	409	459	489	534	576
333	352	374	449	504	537	586	631
363	384	417	499	560	602	657	708
393	414	454	540	608	654	714	771
426	458	490	595	672	721	790	854
457	493	529	641	725	780	854	923
488	529	565	688	780	837	917	992
522	562	604	735	833	895	981	1062
554	598	641	782	886	953	1045	1131
585	633	680	829	940	1011	1109	1200

Pricing is continued on the following page.

UNELIF

Tackable Fabric International Power/ Communications Fascia (Slot Mount) (Continued)

DIMENSIONS INCHES / MM

H	W
27 / 686	42 / 1067
27 / 686	48 / 1219
27 / 686	54 / 1372
27 / 686	60 / 1524
27 / 686	66 / 1676
27 / 686	72 / 1829
27 / 686	78 / 1981
27 / 686	84 / 2134
27 / 686	90 / 2286
27 / 686	96 / 2438
28 / 711	42 / 1067
28 / 711	48 / 1219
28 / 711	54 / 1372
28 / 711	60 / 1524
28 / 711	66 / 1676
28 / 711	72 / 1829
28 / 711	78 / 1981
28 / 711	84 / 2134
28 / 711	90 / 2286
28 / 711	96 / 2438

13 / 330	42 / 1067
13 / 330	48 / 1219
13 / 330	54 / 1372
13 / 330	60 / 1524
13 / 330	66 / 1676
13 / 330	72 / 1829
13 / 330	78 / 1981
13 / 330	84 / 2134
13 / 330	90 / 2286
13 / 330	96 / 2438
21 / 533	42 / 1067
21 / 533	48 / 1219
21 / 533	54 / 1372
21 / 533	60 / 1524
21 / 533	66 / 1676
21 / 533	72 / 1829
21 / 533	78 / 1981
21 / 533	84 / 2134
21 / 533	90 / 2286
21 / 533	96 / 2438

PRICING

CALA CUT OUT FOR TWO OUTLETS (5)

HORIZONTAL LEFT OR RIGHT (L or R) & VERTICAL FLUSH (F)

Fabric	A/COM	Gr. 1	Gr. 2	Gr. 3	Gr. 4	Gr. 5	Gr. 6	Gr. 7
221	246	273	293	315	340	366	389	
237	263	285	316	346	370	399	425	
256	283	342	364	391	424	457	489	
275	303	375	401	431	463	504	539	
297	328	407	436	469	508	553	593	
316	352	441	474	510	553	602	645	
337	375	465	501	539	583	634	682	
358	399	501	536	579	628	683	734	
380	423	534	574	620	671	732	787	
401	446	567	610	660	715	781	839	
222	248	277	296	318	344	370	393	
240	266	291	321	348	374	402	429	
258	285	346	367	395	426	459	492	
278	306	377	403	433	467	506	542	
299	330	410	438	472	511	555	595	
321	354	445	477	513	556	604	649	
341	378	469	504	542	586	637	685	
361	403	504	539	582	631	686	737	
383	427	537	578	624	675	735	790	
405	451	572	613	663	719	784	843	

HORIZONTAL LEFT OR RIGHT (L or R) & VERTICAL TOP OR UPPER (T)

Fabric	A/COM	Gr. 1	Gr. 2	Gr. 3	Gr. 4	Gr. 5	Gr. 6	Gr. 7
154	164	180	189	201	211	225	235	
167	175	187	202	214	227	240	253	
176	184	205	214	227	240	255	270	
185	197	219	229	242	257	274	287	
199	208	233	246	259	276	295	309	
210	223	250	260	276	296	313	332	
223	235	263	278	296	313	334	354	
234	249	280	295	312	333	355	376	
248	261	296	310	330	352	376	399	
259	276	310	327	348	372	398	420	
202	214	228	258	283	301	324	346	
220	230	240	280	309	327	352	375	
234	248	261	304	335	356	383	409	
252	263	281	327	361	383	414	443	
272	286	303	355	393	418	454	484	
288	307	326	381	424	451	487	522	
308	328	348	408	454	482	523	559	
327	349	369	434	483	513	557	596	
347	369	389	460	512	545	591	634	
363	387	411	486	541	578	627	671	

Pricing is continued on the following page.

UNELIF
**Tackable Fabric International Power/
Communications Fascia
(Slot Mount) (Continued)**

DIMENSIONS
INCHES / MM

H	W
22 / 559	42 / 1067
22 / 559	48 / 1219
22 / 559	54 / 1372
22 / 559	60 / 1524
22 / 559	66 / 1676
22 / 559	72 / 1829
22 / 559	78 / 1981
22 / 559	84 / 2134
22 / 559	90 / 2286
22 / 559	96 / 2438
27 / 686	42 / 1067
27 / 686	48 / 1219
27 / 686	54 / 1372
27 / 686	60 / 1524
27 / 686	66 / 1676
27 / 686	72 / 1829
27 / 686	78 / 1981
27 / 686	84 / 2134
27 / 686	90 / 2286
27 / 686	96 / 2438
28 / 711	42 / 1067
28 / 711	48 / 1219
28 / 711	54 / 1372
28 / 711	60 / 1524
28 / 711	66 / 1676
28 / 711	72 / 1829
28 / 711	78 / 1981
28 / 711	84 / 2134
28 / 711	90 / 2286
28 / 711	96 / 2438

PRICING
CALA CUT OUT FOR TWO OUTLETS (5)
HORIZONTAL LEFT OR RIGHT (L or R) & VERTICAL TOP OR UPPER (T) (Continued)

Fabric A/COM	Gr. 1	Gr. 2	Gr. 3	Gr. 4	Gr. 5	Gr. 6	Gr. 7
204	218	232	261	285	304	327	349
222	232	245	282	311	330	355	378
237	250	263	306	337	358	386	412
254	266	284	330	364	386	417	446
274	290	306	358	398	423	456	487
293	310	328	384	427	454	490	526
311	331	351	410	456	485	527	562
331	352	373	437	486	517	560	602
350	373	393	463	515	550	595	638
369	392	416	489	544	581	631	676
221	246	273	293	315	340	366	389
237	263	285	316	346	370	399	425
256	283	342	364	391	424	457	489
275	303	375	401	431	463	504	539
297	328	407	436	469	508	553	593
316	352	441	474	510	553	602	645
337	375	465	501	539	583	634	682
358	399	501	536	579	628	683	734
380	423	534	574	620	671	732	787
401	446	567	610	660	715	781	839
222	248	277	296	318	344	370	393
240	266	291	321	348	374	402	429
258	285	346	367	395	426	459	492
278	306	377	403	433	467	506	542
299	330	410	438	472	511	555	595
321	354	445	477	513	556	604	649
341	378	469	504	542	586	637	685
361	403	504	539	582	631	686	737
383	427	537	578	624	675	735	790
405	451	572	613	663	719	784	843

CALA CUT OUT FOR FOUR OUTLETS (6)
HORIZONTAL LEFT AND RIGHT (B) & VERTICAL BOTTOM OR LOWER (B)

Fabric A/COM	Gr. 1	Gr. 2	Gr. 3	Gr. 4	Gr. 5	Gr. 6	Gr. 7
228	234	248	257	268	279	291	302
238	248	259	272	283	296	307	321
251	258	274	285	299	310	325	336
261	272	285	300	313	327	341	355
274	282	299	312	328	342	357	373
284	295	311	327	341	357	375	389
205	215	240	252	265	282	301	316
219	229	256	268	283	302	322	338
229	244	272	284	302	322	341	360
242	255	286	301	319	340	361	382
254	270	302	318	337	358	382	405
266	282	318	333	354	378	404	427

Pricing is continued on the following page.

UNELIF

**Tackable Fabric International Power/
Communications Fascia
(Slot Mount) (Continued)**

**DIMENSIONS
INCHES / MM**

H	W
21 / 533	66 / 1676
21 / 533	72 / 1829
21 / 533	78 / 1981
21 / 533	84 / 2134
21 / 533	90 / 2286
21 / 533	96 / 2438
22 / 559	66 / 1676
22 / 559	72 / 1829
22 / 559	78 / 1981
22 / 559	84 / 2134
22 / 559	90 / 2286
22 / 559	96 / 2438
37 / 940	66 / 1676
37 / 940	72 / 1829
37 / 940	78 / 1981
37 / 940	84 / 2134
37 / 940	90 / 2286
37 / 940	96 / 2438

27 / 686	66 / 1676
27 / 686	72 / 1829
27 / 686	78 / 1981
27 / 686	84 / 2134
27 / 686	90 / 2286
27 / 686	96 / 2438
28 / 711	66 / 1676
28 / 711	72 / 1829
28 / 711	78 / 1981
28 / 711	84 / 2134
28 / 711	90 / 2286
28 / 711	96 / 2438

13 / 330	66 / 1676
13 / 330	72 / 1829
13 / 330	78 / 1981
13 / 330	84 / 2134
13 / 330	90 / 2286
13 / 330	96 / 2438
21 / 533	66 / 1676
21 / 533	72 / 1829
21 / 533	78 / 1981
21 / 533	84 / 2134
21 / 533	90 / 2286
21 / 533	96 / 2438

PRICING

CALA CUT OUT FOR FOUR OUTLETS (6)

HORIZONTAL LEFT AND RIGHT (B) & VERTICAL BOTTOM OR LOWER (B) (Continued)

Fabric A/COM	Gr. 1	Gr. 2	Gr. 3	Gr. 4	Gr. 5	Gr. 6	Gr. 7
278	295	309	361	401	426	460	490
297	313	332	387	430	457	494	529
315	334	354	414	460	488	530	565
333	355	376	441	490	521	563	604
353	376	398	467	519	553	599	640
372	395	418	493	550	584	633	679
280	298	312	364	404	429	462	494
300	318	334	391	434	460	499	532
319	337	357	417	463	492	533	569
337	358	379	445	493	525	567	608
356	379	401	471	523	556	603	645
376	400	424	497	553	587	637	683
432	464	499	603	680	729	797	861
463	501	535	649	733	786	861	930
496	535	573	695	786	843	924	999
529	569	610	741	839	902	988	1068
560	605	649	788	892	960	1052	1138
591	639	686	836	946	1017	1116	1207

HORIZONTAL LEFT AND RIGHT (B) & VERTICAL FLUSH (F)

Fabric A/COM	Gr. 1	Gr. 2	Gr. 3	Gr. 4	Gr. 5	Gr. 6	Gr. 7
303	334	413	443	478	514	559	601
324	358	449	480	516	559	608	653
346	381	474	507	545	589	640	688
364	405	507	543	586	634	689	740
386	429	540	581	628	679	738	794
407	453	574	616	666	722	787	846
305	336	417	446	480	518	561	603
327	360	452	483	519	562	610	656
349	384	477	510	550	593	644	691
369	409	510	547	589	637	692	744
389	433	544	584	630	682	741	797
411	457	579	620	670	726	790	850

HORIZONTAL LEFT AND RIGHT (B) & VERTICAL TOP OR UPPER (T)

Fabric A/COM	Gr. 1	Gr. 2	Gr. 3	Gr. 4	Gr. 5	Gr. 6	Gr. 7
205	215	240	252	265	282	301	316
219	229	256	268	283	302	322	338
229	244	272	284	302	322	341	360
242	255	286	301	319	340	361	382
254	270	302	318	337	358	382	405
266	282	318	333	354	378	404	427
278	295	309	361	401	426	460	490
297	313	332	387	430	457	494	529
315	334	354	414	460	488	530	565
333	355	376	441	490	521	563	604
353	376	398	467	519	553	599	640
372	395	418	493	550	584	633	679

Pricing is continued on the following page.

UNELIF

Tackable Fabric International Power/ Communications Fascia (Slot Mount) (Continued)

DIMENSIONS
INCHES / MM

H	W
22 / 559	66 / 1676
22 / 559	72 / 1829
22 / 559	78 / 1981
22 / 559	84 / 2134
22 / 559	90 / 2286
22 / 559	96 / 2438
27 / 686	66 / 1676
27 / 686	72 / 1829
27 / 686	78 / 1981
27 / 686	84 / 2134
27 / 686	90 / 2286
27 / 686	96 / 2438
28 / 711	66 / 1676
28 / 711	72 / 1829
28 / 711	78 / 1981
28 / 711	84 / 2134
28 / 711	90 / 2286
28 / 711	96 / 2438

PRICING
CALA CUT OUT FOR FOUR OUTLETS (6)
HORIZONTAL LEFT AND RIGHT (B) & VERTICAL TOP OR UPPER (T) (Continued)

Fabric A/COM	Gr. 1	Gr. 2	Gr. 3	Gr. 4	Gr. 5	Gr. 6	Gr. 7
280	298	312	364	404	429	462	494
300	318	334	391	434	460	499	532
319	337	357	417	463	492	533	569
337	358	379	445	493	525	567	608
356	379	401	471	523	556	603	645
376	400	424	497	553	587	637	683
303	334	413	443	478	514	559	601
324	358	449	480	516	559	608	653
346	381	474	507	545	589	640	688
364	405	507	543	586	634	689	740
386	429	540	581	628	679	738	794
407	453	574	616	666	722	787	846
305	336	417	446	480	518	561	603
327	360	452	483	519	562	610	656
349	384	477	510	550	593	644	691
369	409	510	547	589	637	692	744
389	433	544	584	630	682	741	797
411	457	579	620	670	726	790	850

HORIZONTAL CENTERED (C) & VERTICAL BOTTOM OR LOWER (B)

Fabric A/COM	Gr. 1	Gr. 2	Gr. 3	Gr. 4	Gr. 5	Gr. 6	Gr. 7
129	134	147	151	156	161	171	177
151	160	180	186	196	206	220	229
194	204	224	246	264	282	303	323
195	206	228	248	266	285	306	325
281	301	322	379	423	451	488	526

HORIZONTAL CENTERED (C) & VERTICAL FLUSH (F)

Fabric A/COM	Gr. 1	Gr. 2	Gr. 3	Gr. 4	Gr. 5	Gr. 6	Gr. 7
207	231	265	280	299	319	342	363
209	233	271	285	304	325	350	372

HORIZONTAL CENTERED (C) & VERTICAL TOP OR UPPER (T)

Fabric A/COM	Gr. 1	Gr. 2	Gr. 3	Gr. 4	Gr. 5	Gr. 6	Gr. 7
151	160	180	186	196	206	220	229
194	204	224	246	264	282	303	323
195	206	228	248	266	285	306	325
207	231	265	280	299	319	342	363
209	233	271	285	304	325	350	372

Pricing is continued on the following page.

U N E L I F

**Tackable Fabric International Power/
Communications Fascia
(Slot Mount) (Continued)**

**DIMENSIONS
INCHES / MM**

H	W
7 / 178	42 / 1067
7 / 178	48 / 1219
7 / 178	54 / 1372
7 / 178	60 / 1524
7 / 178	66 / 1676
7 / 178	72 / 1829
7 / 178	78 / 1981
7 / 178	84 / 2134
7 / 178	90 / 2286
7 / 178	96 / 2438
13 / 330	42 / 1067
13 / 330	48 / 1219
13 / 330	54 / 1372
13 / 330	60 / 1524
13 / 330	66 / 1676
13 / 330	72 / 1829
13 / 330	78 / 1981
13 / 330	84 / 2134
13 / 330	90 / 2286
13 / 330	96 / 2438
21 / 533	42 / 1067
21 / 533	48 / 1219
21 / 533	54 / 1372
21 / 533	60 / 1524
21 / 533	66 / 1676
21 / 533	72 / 1829
21 / 533	78 / 1981
21 / 533	84 / 2134
21 / 533	90 / 2286
21 / 533	96 / 2438
22 / 559	42 / 1067
22 / 559	48 / 1219
22 / 559	54 / 1372
22 / 559	60 / 1524
22 / 559	66 / 1676
22 / 559	72 / 1829
22 / 559	78 / 1981
22 / 559	84 / 2134
22 / 559	90 / 2286
22 / 559	96 / 2438
37 / 940	42 / 1067
37 / 940	48 / 1219
37 / 940	54 / 1372
37 / 940	60 / 1524
37 / 940	66 / 1676
37 / 940	72 / 1829
37 / 940	78 / 1981
37 / 940	84 / 2134
37 / 940	90 / 2286
37 / 940	96 / 2438

PRICING

CALA CUT OUT FOR FOUR OUTLETS (6)

HORIZONTAL LEFT OR RIGHT (L or R) & VERTICAL BOTTOM OR LOWER (B)

Fabric A/COM	Gr. 1	Gr. 2	Gr. 3	Gr. 4	Gr. 5	Gr. 6	Gr. 7
184	191	200	206	213	222	229	236
196	201	208	220	228	234	245	252
206	211	222	230	239	249	258	268
219	224	233	245	254	262	275	283
228	234	248	257	268	279	291	302
238	248	259	272	283	296	307	321
251	258	274	285	299	310	325	336
261	272	285	300	313	327	341	355
274	282	299	312	328	342	357	373
284	295	311	327	341	357	375	389
160	172	186	197	207	220	231	244
173	181	196	208	222	233	248	259
182	193	211	222	233	248	261	276
194	203	225	235	249	263	280	296
205	215	240	252	265	282	301	316
219	229	256	268	283	302	322	338
229	244	272	284	302	322	341	360
242	255	286	301	319	340	361	382
254	270	302	318	337	358	382	405
266	282	318	333	354	378	404	427
208	222	234	265	290	307	330	352
226	236	248	286	315	333	358	381
242	254	270	310	341	362	389	416
258	272	287	333	367	389	423	451
278	295	309	361	401	426	460	490
297	313	332	387	430	457	494	529
315	334	354	414	460	488	530	565
333	355	376	441	490	521	563	604
353	376	398	467	519	553	599	640
372	395	418	493	550	584	633	679
210	224	238	270	293	310	333	355
228	238	251	288	318	336	361	384
246	256	272	312	344	364	393	420
260	274	291	336	372	393	425	453
280	298	312	364	404	429	462	494
300	318	334	391	434	460	499	532
319	337	357	417	463	492	533	569
337	358	379	445	493	525	567	608
356	379	401	471	523	556	603	645
376	400	424	497	553	587	637	683
310	330	349	416	466	497	540	582
340	358	380	455	510	544	593	637
372	391	425	505	566	608	663	714
401	423	460	548	615	660	721	778
432	464	499	603	680	729	797	861
463	501	535	649	733	786	861	930
496	535	573	695	786	843	924	999
529	569	610	741	839	902	988	1068
560	605	649	788	892	960	1052	1138
591	639	686	836	946	1017	1116	1207

Pricing is continued on the following page.

UNELIF
Tackable Fabric International Power/
Communications Fascia
(Slot Mount) (Continued)

DIMENSIONS
INCHES / MM

H	W
27 / 686	42 / 1067
27 / 686	48 / 1219
27 / 686	54 / 1372
27 / 686	60 / 1524
27 / 686	66 / 1676
27 / 686	72 / 1829
27 / 686	78 / 1981
27 / 686	84 / 2134
27 / 686	90 / 2286
27 / 686	96 / 2438
28 / 711	42 / 1067
28 / 711	48 / 1219
28 / 711	54 / 1372
28 / 711	60 / 1524
28 / 711	66 / 1676
28 / 711	72 / 1829
28 / 711	78 / 1981
28 / 711	84 / 2134
28 / 711	90 / 2286
28 / 711	96 / 2438
13 / 330	42 / 1067
13 / 330	48 / 1219
13 / 330	54 / 1372
13 / 330	60 / 1524
13 / 330	66 / 1676
13 / 330	72 / 1829
13 / 330	78 / 1981
13 / 330	84 / 2134
13 / 330	90 / 2286
13 / 330	96 / 2438
21 / 533	42 / 1067
21 / 533	48 / 1219
21 / 533	54 / 1372
21 / 533	60 / 1524
21 / 533	66 / 1676
21 / 533	72 / 1829
21 / 533	78 / 1981
21 / 533	84 / 2134
21 / 533	90 / 2286
21 / 533	96 / 2438

PRICING

CALA CUT OUT FOR FOUR OUTLETS (6)

HORIZONTAL LEFT OR RIGHT (L or R) & VERTICAL FLUSH (F)

Fabric A/COM	Gr. 1	Gr. 2	Gr. 3	Gr. 4	Gr. 5	Gr. 6	Gr. 7
227	252	279	300	323	348	374	398
246	272	293	324	352	377	405	431
262	290	350	373	400	430	463	497
281	309	381	407	437	471	510	547
303	334	413	443	478	514	559	601
324	358	449	480	516	559	608	653
346	381	474	507	545	589	640	688
364	405	507	543	586	634	689	740
386	429	540	581	628	679	738	794
407	453	574	616	666	722	787	846
228	254	283	302	325	351	377	401
248	274	299	327	354	380	408	435
265	293	352	375	402	432	465	500
284	312	383	409	439	475	512	550
305	336	417	446	480	518	561	603
327	360	452	483	519	562	610	656
349	384	477	510	550	593	644	691
369	409	510	547	589	637	692	744
389	433	544	584	630	682	741	797
411	457	579	620	670	726	790	850

HORIZONTAL LEFT OR RIGHT (L or R) & VERTICAL TOP OR UPPER (T)

Fabric A/COM	Gr. 1	Gr. 2	Gr. 3	Gr. 4	Gr. 5	Gr. 6	Gr. 7
160	172	186	197	207	220	231	244
173	181	196	208	222	233	248	259
182	193	211	222	233	248	261	276
194	203	225	235	249	263	280	296
205	215	240	252	265	282	301	316
219	229	256	268	283	302	322	338
229	244	272	284	302	322	341	360
242	255	286	301	319	340	361	382
254	270	302	318	337	358	382	405
266	282	318	333	354	378	404	427
208	222	234	265	290	307	330	352
226	236	248	286	315	333	358	381
242	254	270	310	341	362	389	416
258	272	287	333	367	389	423	451
278	295	309	361	401	426	460	490
297	313	332	387	430	457	494	529
315	334	354	414	460	488	530	565
333	355	376	441	490	521	563	604
353	376	398	467	519	553	599	640
372	395	418	493	550	584	633	679

Pricing is continued on the following page.

U N E L I F

**Tackable Fabric International Power/
Communications Fascia
(Slot Mount) (Continued)**

**DIMENSIONS
INCHES / MM**

PRICING

DIMENSIONS		PRICING							
INCHES / MM		CALA CUT OUT FOR FOUR OUTLETS (6)							
		HORIZONTAL LEFT OR RIGHT (L or R) & VERTICAL TOP OR UPPER (T) (Continued)							
H	W	Fabric A/COM	Gr. 1	Gr. 2	Gr. 3	Gr. 4	Gr. 5	Gr. 6	Gr. 7
22 / 559	42 / 1067	210	224	238	270	293	310	333	355
22 / 559	48 / 1219	228	238	251	288	318	336	361	384
22 / 559	54 / 1372	246	256	272	312	344	364	393	420
22 / 559	60 / 1524	260	274	291	336	372	393	425	453
22 / 559	66 / 1676	280	298	312	364	404	429	462	494
22 / 559	72 / 1829	300	318	334	391	434	460	499	532
22 / 559	78 / 1981	319	337	357	417	463	492	533	569
22 / 559	84 / 2134	337	358	379	445	493	525	567	608
22 / 559	90 / 2286	356	379	401	471	523	556	603	645
22 / 559	96 / 2438	376	400	424	497	553	587	637	683
27 / 686	42 / 1067	227	252	279	300	323	348	374	398
27 / 686	48 / 1219	246	272	293	324	352	377	405	431
27 / 686	54 / 1372	262	290	350	373	400	430	463	497
27 / 686	60 / 1524	281	309	381	407	437	471	510	547
27 / 686	66 / 1676	303	334	413	443	478	514	559	601
27 / 686	72 / 1829	324	358	449	480	516	559	608	653
27 / 686	78 / 1981	346	381	474	507	545	589	640	688
27 / 686	84 / 2134	364	405	507	543	586	634	689	740
27 / 686	90 / 2286	386	429	540	581	628	679	738	794
27 / 686	96 / 2438	407	453	574	616	666	722	787	846
28 / 711	42 / 1067	228	254	283	302	325	351	377	401
28 / 711	48 / 1219	248	274	299	327	354	380	408	435
28 / 711	54 / 1372	265	293	352	375	402	432	465	500
28 / 711	60 / 1524	284	312	383	409	439	475	512	550
28 / 711	66 / 1676	305	336	417	446	480	518	561	603
28 / 711	72 / 1829	327	360	452	483	519	562	610	656
28 / 711	78 / 1981	349	384	477	510	550	593	644	691
28 / 711	84 / 2134	369	409	510	547	589	637	692	744
28 / 711	90 / 2286	389	433	544	584	630	682	741	797
28 / 711	96 / 2438	411	457	579	620	670	726	790	850

U A E L I F

Tackable Fabric International Power/Communications Fascia for Freestanding District (Slot Mount)

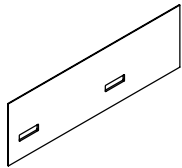

The Tackable International Fabric Power/Communications Fascia provides a tackable panel wall finish.

WHAT'S INCLUDED

1 fascia.

NOTES

7" height fascias are not tackable.

Fascia is to only be applied to District Panel that is supported by the Freestanding Foot (UAFFN).

The 21" and 22" fascias must be ordered with a 6" high fascia as Elevated panels are not applicable in a freestanding application.

For 24" to 60" wide fascias only Left (LL) or Right (RR) power and data locations can be specified.

PRODUCT OPTIONS

Outlet Configuration	Horizontal Power/Communication Orientation	Vertical Power/Communication Orientation	Height	Width (6" increments)	Fascia Finish	Bezel Finish
2 Cut Out for two outlets (available on 24" and 30" widths)	LL Left	T Top	21, 22, 35	24 - 96	Panel Fabric	~ Black
	LC Left Centre	B Bottom				74 Storm White
3 Cut Out for two outlets and one data/communications box (available on 36" widths and wider)	RC Right Centre					
	RR Right					
	LR Left and Right					
4 Cut Out for four outlets (available on 36" widths and wider)	CR Left Centre and Right					
	CL Right Centre and Left					
5 Cala Cut Out for two outlets						
6 Cala Cut Out for four outlets						

SAMPLE ORDER CODE

UAELIF 3	LR	T	22	66	C503	74
----------	----	---	----	----	------	----

DIMENSIONS INCHES / MM

H	W
21 / 533	66 / 1676
21 / 533	72 / 1829
21 / 533	78 / 1981
21 / 533	84 / 2134
21 / 533	90 / 2286
21 / 533	96 / 2438
22 / 559	66 / 1676
22 / 559	72 / 1829
22 / 559	78 / 1981
22 / 559	84 / 2134
22 / 559	90 / 2286
22 / 559	96 / 2438
35 / 889	66 / 1676
35 / 889	72 / 1829
35 / 889	78 / 1981
35 / 889	84 / 2134
35 / 889	90 / 2286
35 / 889	96 / 2438

PRICING

CUT OUT OUTLET (2, 3, 4)

HORIZONTAL (LC, RC, LR, CR or CL) & VERTICAL (T or B)

Fabric A/COM	Gr. 1	Gr. 2	Gr. 3	Gr. 4	Gr. 5	Gr. 6	Gr. 7
245	259	276	328	366	391	427	457
261	280	299	354	397	424	460	494
281	301	321	381	427	455	496	532
300	322	341	407	456	486	530	569
319	341	362	433	485	518	564	607
336	360	384	459	514	551	599	644
247	262	279	331	370	395	429	460
265	283	301	357	400	427	463	499
284	304	324	383	429	458	500	535
304	325	346	410	459	489	533	574
323	346	366	436	488	522	568	611
341	364	388	462	517	554	604	649
388	423	454	558	635	685	753	816
420	456	490	605	688	741	816	886
452	489	529	650	740	798	879	954
482	525	564	696	794	857	942	1022
513	558	603	741	845	913	1006	1091
544	591	638	788	898	969	1068	1159

Pricing is continued on the following page.

U A E L I F
Tackable Fabric International
Power/Communications Fascia
for Freestanding District
(Slot Mount) (Continued)

DIMENSIONS
INCHES / MM

H	W
21 / 533	36 / 914
21 / 533	42 / 1067
21 / 533	48 / 1219
21 / 533	54 / 1372
21 / 533	60 / 1524
21 / 533	66 / 1676
21 / 533	72 / 1829
21 / 533	78 / 1981
21 / 533	84 / 2134
21 / 533	90 / 2286
21 / 533	96 / 2438
22 / 559	36 / 914
22 / 559	42 / 1067
22 / 559	48 / 1219
22 / 559	54 / 1372
22 / 559	60 / 1524
22 / 559	66 / 1676
22 / 559	72 / 1829
22 / 559	78 / 1981
22 / 559	84 / 2134
22 / 559	90 / 2286
22 / 559	96 / 2438
35 / 889	36 / 914
35 / 889	42 / 1067
35 / 889	48 / 1219
35 / 889	54 / 1372
35 / 889	60 / 1524
35 / 889	66 / 1676
35 / 889	72 / 1829
35 / 889	78 / 1981
35 / 889	84 / 2134
35 / 889	90 / 2286
35 / 889	96 / 2438

PRICING

CUT OUT OUTLET (2, 3, 4)

HORIZONTAL (LL or RR) & VERTICAL (B or T)

Fabric A/COM	Gr. 1	Gr. 2	Gr. 3	Gr. 4	Gr. 5	Gr. 6	Gr. 7
158	171	189	210	230	249	270	287
175	186	201	231	256	274	297	318
193	203	212	253	282	300	325	348
207	221	234	277	308	329	356	382
225	236	254	300	334	356	387	416
245	259	276	328	366	391	427	457
261	280	299	354	397	424	460	494
281	301	321	381	427	455	496	532
300	322	341	407	456	486	530	569
319	341	362	433	485	518	564	607
336	360	384	459	514	551	599	644
159	173	195	212	232	252	273	290
177	189	205	234	258	277	300	322
195	205	218	255	284	303	328	351
210	223	236	279	310	331	359	385
227	238	257	303	337	359	389	418
247	262	279	331	370	395	429	460
265	283	301	357	400	427	463	499
284	304	324	383	429	458	500	535
304	325	346	410	459	489	533	574
323	346	366	436	488	522	568	611
341	364	388	462	517	554	604	649
242	259	277	336	380	407	448	482
271	287	306	375	425	454	497	537
300	318	337	411	465	501	548	591
328	349	382	462	523	564	620	671
357	380	417	505	570	616	679	734
388	423	454	558	635	685	753	816
420	456	490	605	688	741	816	886
452	489	529	650	740	798	879	954
482	525	564	696	794	857	942	1022
513	558	603	741	845	913	1006	1091
544	591	638	788	898	969	1068	1159

Pricing is continued on the following page.

U A E L I F

**Tackable Fabric International
Power/Communications Fascia
for Freestanding District
(Slot Mount) (Continued)**

**DIMENSIONS
INCHES / MM**

H	W
21 / 533	66 / 1676
21 / 533	72 / 1829
21 / 533	78 / 1981
21 / 533	84 / 2134
21 / 533	90 / 2286
21 / 533	96 / 2438
22 / 559	66 / 1676
22 / 559	72 / 1829
22 / 559	78 / 1981
22 / 559	84 / 2134
22 / 559	90 / 2286
22 / 559	96 / 2438
35 / 889	66 / 1676
35 / 889	72 / 1829
35 / 889	78 / 1981
35 / 889	84 / 2134
35 / 889	90 / 2286
35 / 889	96 / 2438

21 / 533	36 / 914
21 / 533	42 / 1067
21 / 533	48 / 1219
21 / 533	54 / 1372
21 / 533	60 / 1524
21 / 533	66 / 1676
21 / 533	72 / 1829
21 / 533	78 / 1981
21 / 533	84 / 2134
21 / 533	90 / 2286
21 / 533	96 / 2438
22 / 559	36 / 914
22 / 559	42 / 1067
22 / 559	48 / 1219
22 / 559	54 / 1372
22 / 559	60 / 1524
22 / 559	66 / 1676
22 / 559	72 / 1829
22 / 559	78 / 1981
22 / 559	84 / 2134
22 / 559	90 / 2286
22 / 559	96 / 2438

PRICING

CALA CUT OUT FOR TWO OUTLETS (5)

HORIZONTAL (LC, RC, LR, CR or CL) & VERTICAL (T or B)

Fabric A/COM	Gr. 1	Gr. 2	Gr. 3	Gr. 4	Gr. 5	Gr. 6	Gr. 7
272	286	303	355	393	418	454	484
288	307	326	381	424	451	487	522
308	328	348	408	454	482	523	559
327	349	369	434	483	513	557	596
347	369	389	460	512	545	591	634
363	387	411	486	541	578	627	671
274	290	306	358	398	423	456	487
293	310	328	384	427	454	490	526
311	331	351	410	456	485	527	562
331	352	373	437	486	517	560	602
350	373	393	463	515	550	595	638
369	392	416	489	544	581	631	676
416	450	481	585	662	712	781	843
448	483	518	632	715	769	843	913
479	517	556	678	767	826	906	981
509	552	591	723	821	884	969	1049
540	585	630	769	873	940	1033	1118
572	619	665	815	925	997	1095	1186

HORIZONTAL (LL or RR) & VERTICAL (B or T)

Fabric A/COM	Gr. 1	Gr. 2	Gr. 3	Gr. 4	Gr. 5	Gr. 6	Gr. 7
185	198	218	237	257	276	297	315
202	214	228	258	283	301	324	346
220	230	240	280	309	327	352	375
234	248	261	304	335	356	383	409
252	263	281	327	361	383	414	443
272	286	303	355	393	418	454	484
288	307	326	381	424	451	487	522
308	328	348	408	454	482	523	559
327	349	369	434	483	513	557	596
347	369	389	460	512	545	591	634
363	387	411	486	541	578	627	671
186	200	222	240	260	279	300	318
204	218	232	261	285	304	327	349
222	232	245	282	311	330	355	378
237	250	263	306	337	358	386	412
254	266	284	330	364	386	417	446
274	290	306	358	398	423	456	487
293	310	328	384	427	454	490	526
311	331	351	410	456	485	527	562
331	352	373	437	486	517	560	602
350	373	393	463	515	550	595	638
369	392	416	489	544	581	631	676

Pricing is continued on the following page.

U A E L I F
Tackable Fabric International
Power/Communications Fascia
for Freestanding District
(Slot Mount) (Continued)

DIMENSIONS
INCHES / MM

H	W
35 / 889	36 / 914
35 / 889	42 / 1067
35 / 889	48 / 1219
35 / 889	54 / 1372
35 / 889	60 / 1524
35 / 889	66 / 1676
35 / 889	72 / 1829
35 / 889	78 / 1981
35 / 889	84 / 2134
35 / 889	90 / 2286
35 / 889	96 / 2438

21 / 533	66 / 1676
21 / 533	72 / 1829
21 / 533	78 / 1981
21 / 533	84 / 2134
21 / 533	90 / 2286
21 / 533	96 / 2438
22 / 559	66 / 1676
22 / 559	72 / 1829
22 / 559	78 / 1981
22 / 559	84 / 2134
22 / 559	90 / 2286
22 / 559	96 / 2438
35 / 889	66 / 1676
35 / 889	72 / 1829
35 / 889	78 / 1981
35 / 889	84 / 2134
35 / 889	90 / 2286
35 / 889	96 / 2438

PRICING

CALA CUT OUT FOR TWO OUTLETS (5)

HORIZONTAL (LL or RR) & VERTICAL (B or T) (CONTINUED)

Fabric A/COM	Gr. 1	Gr. 2	Gr. 3	Gr. 4	Gr. 5	Gr. 6	Gr. 7
270	286	304	363	407	434	475	509
298	315	333	402	452	481	525	564
327	346	364	438	492	528	576	619
355	376	409	489	551	591	648	699
384	407	445	532	599	644	706	761
416	450	481	585	662	712	781	843
448	483	518	632	715	769	843	913
479	517	556	678	767	826	906	981
509	552	591	723	821	884	969	1049
540	585	630	769	873	940	1033	1118
572	619	665	815	925	997	1095	1186

CALA CUT OUT FOR FOUR OUTLETS (6)

HORIZONTAL (LC, RC, LR, CR or CL) & VERTICAL (T or B)

Fabric A/COM	Gr. 1	Gr. 2	Gr. 3	Gr. 4	Gr. 5	Gr. 6	Gr. 7
278	295	309	361	401	426	460	490
297	313	332	387	430	457	494	529
315	334	354	414	460	488	530	565
333	355	376	441	490	521	563	604
353	376	398	467	519	553	599	640
372	395	418	493	550	584	633	679
280	298	312	364	404	429	462	494
300	318	334	391	434	460	499	532
319	337	357	417	463	492	533	569
337	358	379	445	493	525	567	608
356	379	401	471	523	556	603	645
376	400	424	497	553	587	637	683
424	456	487	591	669	719	787	850
454	489	526	638	721	776	850	919
485	525	562	684	773	833	913	988
515	558	599	731	828	890	976	1056
548	591	636	776	880	947	1040	1125
579	627	672	822	934	1004	1102	1193

Pricing is continued on the following page.

U A E L I F

**Tackable Fabric International
Power/Communications Fascia
for Freestanding District
(Slot Mount) (Continued)**

**DIMENSIONS
INCHES / MM**

PRICING

CALA CUT OUT FOR FOUR OUTLETS (6)

HORIZONTAL (LL or RR) & VERTICAL (B or T)

H	W	Fabric A/COM	Gr. 1	Gr. 2	Gr. 3	Gr. 4	Gr. 5	Gr. 6	Gr. 7
21 / 533	36 / 914	194	204	224	246	264	282	303	323
21 / 533	42 / 1067	208	222	234	265	290	307	330	352
21 / 533	48 / 1219	226	236	248	286	315	333	358	381
21 / 533	54 / 1372	242	254	270	310	341	362	389	416
21 / 533	60 / 1524	258	272	287	333	367	389	423	451
21 / 533	66 / 1676	278	295	309	361	401	426	460	490
21 / 533	72 / 1829	297	313	332	387	430	457	494	529
21 / 533	78 / 1981	315	334	354	414	460	488	530	565
21 / 533	84 / 2134	333	355	376	441	490	521	563	604
21 / 533	90 / 2286	353	376	398	467	519	553	599	640
21 / 533	96 / 2438	372	395	418	493	550	584	633	679
22 / 559	36 / 914	195	206	228	248	266	285	306	325
22 / 559	42 / 1067	210	224	238	270	293	310	333	355
22 / 559	48 / 1219	228	238	251	288	318	336	361	384
22 / 559	54 / 1372	246	256	272	312	344	364	393	420
22 / 559	60 / 1524	260	274	291	336	372	393	425	453
22 / 559	66 / 1676	280	298	312	364	404	429	462	494
22 / 559	72 / 1829	300	318	334	391	434	460	499	532
22 / 559	78 / 1981	319	337	357	417	463	492	533	569
22 / 559	84 / 2134	337	358	379	445	493	525	567	608
22 / 559	90 / 2286	356	379	401	471	523	556	603	645
22 / 559	96 / 2438	376	400	424	497	553	587	637	683
35 / 889	36 / 914	276	295	310	372	415	441	481	515
35 / 889	42 / 1067	304	323	340	408	457	487	531	572
35 / 889	48 / 1219	333	352	373	446	501	534	582	627
35 / 889	54 / 1372	361	382	416	497	558	599	655	706
35 / 889	60 / 1524	391	413	452	538	606	652	712	767
35 / 889	66 / 1676	424	456	487	591	669	719	787	850
35 / 889	72 / 1829	454	489	526	638	721	776	850	919
35 / 889	78 / 1981	485	525	562	684	773	833	913	988
35 / 889	84 / 2134	515	558	599	731	828	890	976	1056
35 / 889	90 / 2286	548	591	636	776	880	947	1040	1125
35 / 889	96 / 2438	579	627	672	822	934	1004	1102	1193

U N E L M B Metal Base Feed Fascia (Slot Mount)

The Metal Base Feed Fascia provides an opening for mounting of the base feed.

WHAT'S INCLUDED

1 fascia with cut out, as specified.

NOTES

The Center (C) Cut Out Location is available from 42" to 60" widths only.

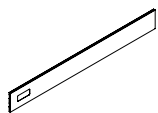

PRODUCT OPTIONS

Cut Out Location (If applicable)	Height	Width (6" increments)	Fascia Finish
L Left Side	6	24 - 96	Foundation
R Right Side			Mica
C Center			

SAMPLE ORDER CODE

UNELMB L	6	72	E
----------	---	----	---

DIMENSIONS INCHES / MM

H	W
6 / 152	24 / 610
6 / 152	30 / 762
6 / 152	36 / 914
6 / 152	42 / 1067
6 / 152	48 / 1219
6 / 152	54 / 1372
6 / 152	60 / 1524
6 / 152	66 / 1676
6 / 152	72 / 1829
6 / 152	78 / 1981
6 / 152	84 / 2134
6 / 152	90 / 2286
6 / 152	96 / 2438

PRICING

109
113
118
121
123
126
129
132
135
139
144
147
150

The Metal Base Feed Fascia provides an opening for mounting of the base feed.

WHAT'S INCLUDED

1 fascia with cut out, as specified.

NOTES

Fascia is to only be applied to District Panel that is supported by the Freestanding Foot (UAFFN).

On fascias 36" - 60" wide, cut out will be to the outer end of the side selected. For fascias 66" - 96" wide the cut out will be justified to the center of the fascia on the side selected.

U A E L M B
Metal Base Feed Fascia
for Freestanding District
(Slot Mount)

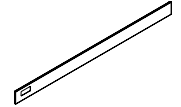

PRODUCT OPTIONS

Cut Out Location	Height	Width (6" increments)	Frame Finish
L Left Side R Right Side	6	36 - 96	Foundation Mica

SAMPLE ORDER CODE

UAELMB L	6	72	60
-----------------	----------	-----------	-----------

DIMENSIONS
INCHES / MM

H	W
6 / 152	36 / 914
6 / 152	42 / 1067
6 / 152	48 / 1219
6 / 152	54 / 1372
6 / 152	60 / 1524
6 / 152	66 / 1676
6 / 152	72 / 1829
6 / 152	78 / 1981
6 / 152	84 / 2134
6 / 152	90 / 2286
6 / 152	96 / 2438

PRICING

96
99
103
107
110
117
120
123
126
129
132

UNELFB

Fabric Base Feed Fascia (Slot Mount)

The Fabric Base Feed Fascia provides an opening for mounting of the base feed.

WHAT'S INCLUDED

1 fascia with cut out, as specified.

NOTES

Fabric Base Feed Fascia is not tackable.

The Center (C) Cut Out Location is available from 42" to 60" widths only.

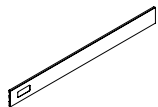

PRODUCT OPTIONS

Cut Out Location (If applicable)	Height	Width (6" increments)	Fascia Finish
L Left Side R Right Side C Center (available on 42", 60" widths)	6	24 - 96	Panel Fabric

SAMPLE ORDER CODE

UNELFB L	6	72	L341
-----------------	----------	-----------	-------------

DIMENSIONS INCHES / MM

H	W
6 / 152	24 / 610
6 / 152	30 / 762
6 / 152	36 / 914
6 / 152	42 / 1067
6 / 152	48 / 1219
6 / 152	54 / 1372
6 / 152	60 / 1524
6 / 152	66 / 1676
6 / 152	72 / 1829
6 / 152	78 / 1981
6 / 152	84 / 2134
6 / 152	90 / 2286
6 / 152	96 / 2438

PRICING

Fabric A/COM	Gr. 1	Gr. 2	Gr. 3	Gr. 4	Gr. 5	Gr. 6	Gr. 7
113	117	120	124	128	131	134	139
124	127	142	146	151	155	161	169
133	137	149	153	158	162	171	177
144	149	157	161	169	175	182	187
153	157	167	174	181	186	196	202
162	169	175	183	193	199	207	215
173	178	185	196	204	211	222	230
182	187	198	207	218	227	235	246
194	200	209	221	231	240	251	260
203	209	222	232	244	254	266	277
212	221	232	246	258	270	281	293
224	231	245	257	271	282	297	308
233	242	255	271	284	297	310	325

The Fabric Base Feed Fascia provides an opening for mounting of the base feed.

WHAT'S INCLUDED

1 fascia with cut out, as specified.

NOTES

Fabric Base Feed Fascia is not tackable.

Fascia is to only be applied to District Panel that is supported by the Freestanding Foot (UAFFN).

On fascias 36" - 60" wide, cut out will be to the outer end of the side selected. For fascias 66" - 96" wide the cut out will be justified to the center of the fascia on the side selected.

U A E L F B
Fabric Base Feed Fascia
for Freestanding District
(Slot Mount)

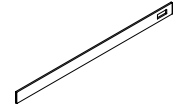

PRODUCT OPTIONS

Cut Out Location	Height	Width (6" increments)	Fascia Finish
L Left Side R Right Side	6	36 - 96	Panel Fabric

SAMPLE ORDER CODE

UAELFB L	6	72	L341
-----------------	----------	-----------	-------------

DIMENSIONS

INCHES / MM

H	W
6 / 152	36 / 914
6 / 152	42 / 1067
6 / 152	48 / 1219
6 / 152	54 / 1372
6 / 152	60 / 1524
6 / 152	66 / 1676
6 / 152	72 / 1829
6 / 152	78 / 1981
6 / 152	84 / 2134
6 / 152	90 / 2286
6 / 152	96 / 2438

PRICING

Fabric A/COM	Gr. 1	Gr. 2	Gr. 3	Gr. 4	Gr. 5	Gr. 6	Gr. 7
136	143	152	156	161	168	174	180
147	151	159	164	172	178	184	193
155	159	169	176	183	189	198	204
164	170	177	184	194	201	208	218
174	178	186	197	205	212	223	230
184	189	200	209	220	228	237	248
196	201	210	223	233	244	253	262
206	211	224	235	248	257	270	279
218	224	235	249	260	272	284	297
228	234	248	260	274	285	300	311
237	247	259	275	288	301	315	328

UNELK Fascia Clip Kit

The Fascia Clip Kit is required to attach clip-mounted fascias to a Convertible Wall Frame.

WHAT'S INCLUDED

Package of 25 or 100 clips, as specified.

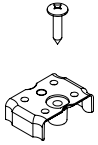

PRODUCT OPTIONS

Quantity	
25	25 clips
100	100 clips

SAMPLE ORDER CODE

UNELK 100

QUANTITY	PRICING
25	97
100	351

power spine

power spine product map

UNPZ Power Spine Panel

Page 490

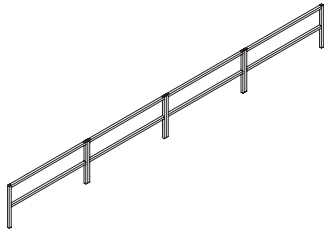

UYPZ Power Spine Inset Panel

Page 492

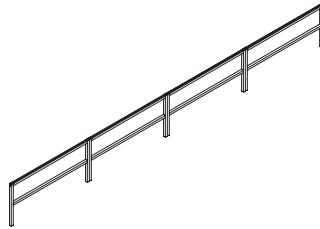

UZPK Power Spine Support Kit

Page 494

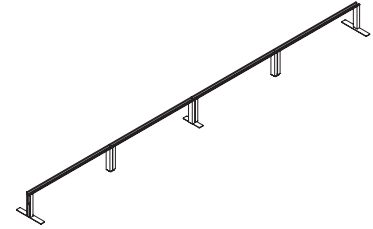

UNZZ Zig Zag Power Spine Panel

Page 496

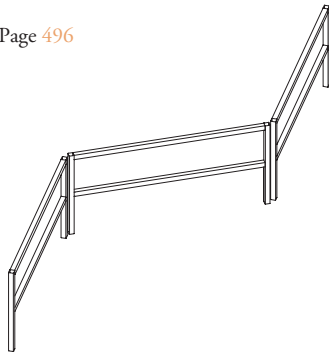

UYZZ Zig Zag Power Spine Inset Panel

Page 497

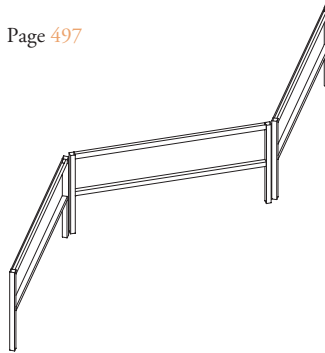

UZZK Zig Zag Support Kit

Page 498

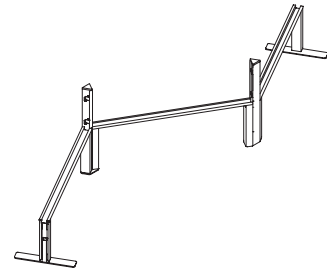

UNYH Power Spine 120 Hub Panel

Page 500

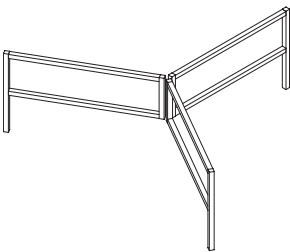

UZYH Power Spine 120 Hub Inset Panel

Page 501

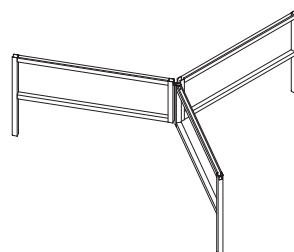

UZYK Power Spine 120 Hub Support Kit

Page 502

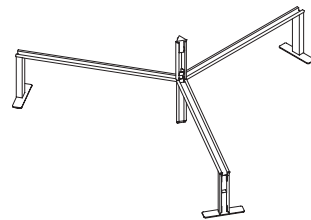

UZSS Power Spine Lateral Floor Screen Solid

Page 504

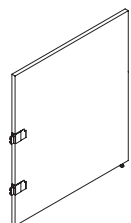

UZSG Power Spine Lateral Floor Screen with Glass

Page 508

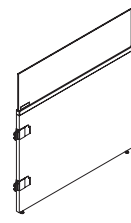

YSZ hiSpace Quick Connect Height-Adjustable Freestanding Table Mechanism for District Power Spine

Page 515

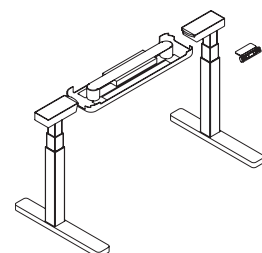

power spine product map (continued)

WBZ Rectangular Height-Adjustable Worksurface with Connection Kit for hiSpace Quick Connect with District Power Spine

Page 516

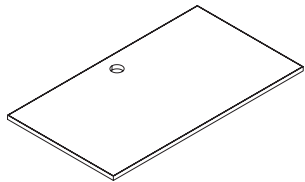

YSB hiSpace Quick Connect Parralelogram Height-Adjustable Freestanding Table Mechanism for District Power Spine

Page 518

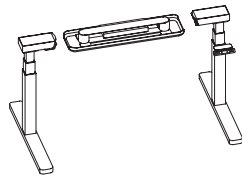

WBP Parallelogram Height-Adjustable Worksurface with Connection Kit for District Power Spine

Page 519

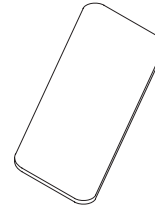

YST hiSpace Quick Connect 120 Hub Height-Adjustable Freestanding Table Mechanism for District Power Spine

Page 520

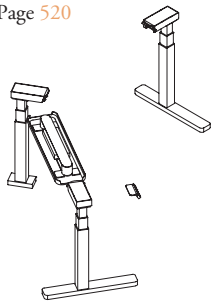

WBT 120Hub Height-Adjustable Worksurface for hiSpaceQuick Connect with District Power Spine

Page 522

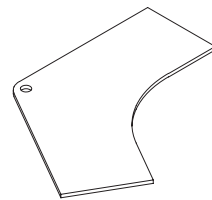

UZWE Power Spine Rectangle Worksurface

Page 524

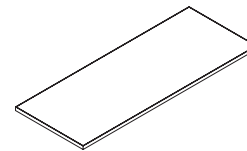

UZWC Power Spine Rectangle Worksurface Support Bundle

Page 526

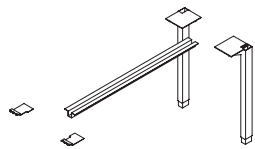

UZWP Power Spine Parallelogram Worksurface

Page 528

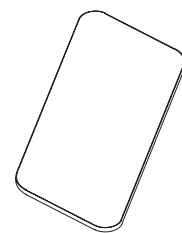

UZWK Power Spine Parallelogram Worksurface Support Bundle

Page 530

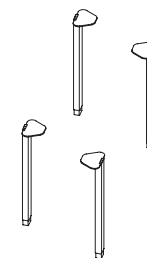

UZWA Power Spine Angled Worksurface

Page 532

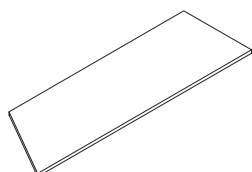

UZWB Power Spine Angled Worksurface Support Bundle

Page 534

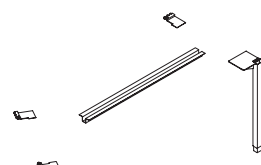

UZWD Power Spine Dual 120 Angled Worksurface

Page 535

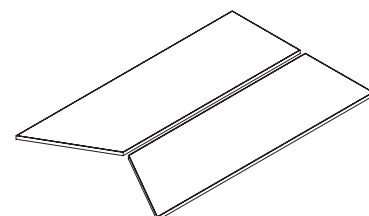

power spine product map (continued)

**UZDK Power Spine Dual Angled
Worksurface Support Bundle**

Page 536

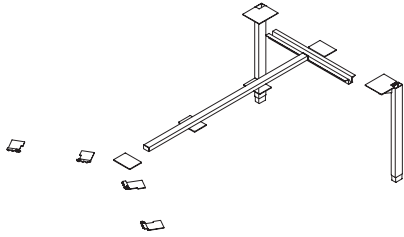

**UZWT Power Spine 120 Hub
Worksurface**

Page 537

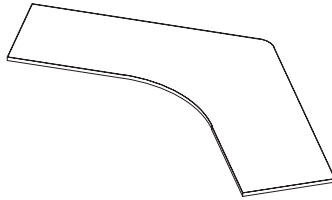

**UZWW Power Spine 120 HUB
Worksurface Support
Bundle**

Page 538

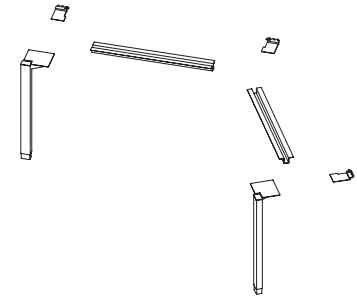

power spine

UNPZ

Power Spine Panel

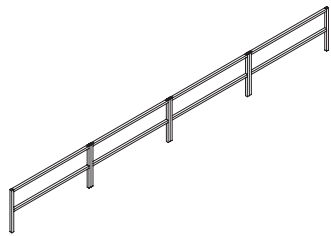

The Power Spine Panel Wall is elevated when finished with required Support Kit.

WHAT'S INCLUDED

2 frames (96", 120", 144", 168" widths), 3 frames (144"(A), 180", 216", 252" widths), 4 frames (192", 240", 288", 336" widths), hardware for straight connections and levelers.

WHAT'S EXCLUDED

Support Kit, Fascia, End Trim and Top Trim to panel must be specified separately.

NOTES

Panel wall frame has a Black finish.

PRODUCT OPTIONS

Height	Width	Support	Panel Type
29	096, 120, 144, 14A, 168, 180, 192, 216, 240, 252, 288, 336	C With Centre Support Post F With Offset Support Post N No Support Post	Bare Frame

SAMPLE ORDER CODE

UNPZ 29	120	N	
---------	-----	---	--

DIMENSIONS INCHES / MM

H	W	
29 / 737	96 / 2438	(two 48" panels)
29 / 737	120 / 3048	(two 60" panels)
29 / 737	120 / 3048	(120" span)
29 / 737	144 / 3658	(two 72" panels)
29 / 737	144 (A) / 3658	(for one 96" center open plus one 48" panels)
29 / 737	144 (A) / 3658	(three 48" panels)
29 / 737	168 / 4267	(two 84" panels)
29 / 737	180 / 4572	(three 60" panels)
29 / 737	192 / 4572	(four 48" panels)
29 / 737	192 / 4572	(for one 96" center open plus two 48" panels)
29 / 737	192 / 4572	(for two 96" open spans)
29 / 737	216 / 5486	(three 72" panels)
29 / 737	240 / 6096	(four 60" panels)
29 / 737	240 / 6096	(120" center span with two 60" panels)
29 / 737	240 / 6096	(two 120" spans)
29 / 737	252 / 6400	(three 84" panels)
29 / 737	288 / 7315	(four 72" panels)
29 / 737	366 / 8534	(four 72" panels)

PRICING

350
454
496
596
482
525
675
681
699
649
634
896
908
976
991
1013
1194
1328

UYPZ

Power Spine Inset Panel

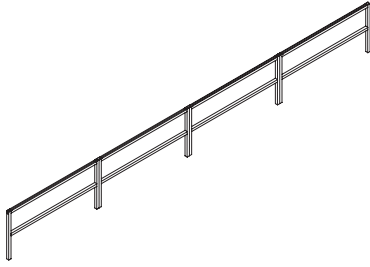

The Inset Panel Wall is designed to be used in conjunction with the Inset Glass or Smooth add-on is elevated when finished with required Support Kit.

WHAT'S INCLUDED

2 frames (96", 120", 144", 168" widths), 3 frames (144"(A), 180", 216", 252" widths), 4 frames (192", 240", 288", 336" widths), hardware for straight connections and levelers.

WHAT'S EXCLUDED

Support Kit, Fascia, End Trim and Top Trim to panel must be specified separately.

NOTES

Panel wall frame has a Black finish.

PRODUCT OPTIONS

Height	Width	Support	Panel Type
29, 42	096, 120, 144, 14A, 168, 180, 192, 216, 240, 252, 288, 336	C With Centre Support Post F With Offset Support Post N No Support Post	Bare Frame

SAMPLE ORDER CODE

UYPZ 29	120	N	
----------------	------------	----------	--

DIMENSIONS INCHES / MM

H	W	
29 / 737	96 / 2438	(two 48" panels)
29 / 737	120 / 3048	(two 60" panels)
29 / 737	120 / 3048	(for 120" open span)
29 / 737	144 / 3658	(two 72" panels)
29 / 737	144 (A) / 3658	(for one 96" center open plus one 48" panels)
29 / 737	144 (A) / 3658	(three 48" panels)
29 / 737	168 / 4267	(two 84" panels)
29 / 737	180 / 4572	(three 60" panels)
29 / 737	180 / 4572	(for one 120" center open span plus one 60" panel)
29 / 737	192 / 4572	(four 48" panels)
29 / 737	192 / 4572	(for one 96" center open plus 48" two panels)
29 / 737	192 / 4572	(for two 96" open spans)
29 / 737	216 / 5486	(three 72" panels)
29 / 737	240 / 6096	(four 60" panels)
29 / 737	240 / 6096	(for one 120" center open span plus two 60" panels)
29 / 737	240 / 6096	(for two 120" open spans)
29 / 737	252 / 6400	(three 84" panels)
29 / 737	288 / 7315	(four 72" panels)
29 / 737	366 / 8534	(four 84" panels)

PRICING

404
567
583
629
592
645
796
850
866
870
847
808
942
1134
1150
1166
1195
1256
1593

Pricing is continued on the following page.

UYPZ

Power Spine Inset Panel (Continued)

DIMENSIONS INCHES / MM

H	W	
42 / 1067	96 / 2438	(two 48" panels)
42 / 1067	120 / 3048	(two 60" panels)
42 / 1067	144 / 3658	(two 72" panels)
42 / 1067	144 (A) / 3658	(for one 96" center open plus one 48" panels)
42 / 1067	144 (A) / 3658	(three 48" panels)
42 / 1067	168 / 4267	(two 84" panels)
42 / 1067	180 / 4572	(three 60" panels)
42 / 1067	192 / 4572	(four 48" panels)
42 / 1067	192 / 4572	(for one 96" center open plus 48" two panels)
42 / 1067	192 / 4572	(for two 96" open spans)
42 / 1067	216 / 5486	(three 72" panels)
42 / 1067	240 / 6096	(four 60" panels)
42 / 1067	252 / 6400	(three 84" panels)
42 / 1067	288 / 7315	(four 72" panels)
42 / 1067	366 / 8534	(four 84" panels)

PRICING

443
624
691
653
711
875
936
957
933
888
1037
1248
1314
1382
1753

U Z P K

Power Spine Support Kit

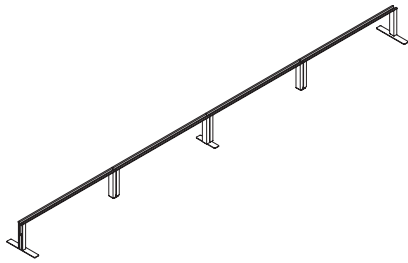

The Power Spine Support Kit is paired with the Power Spine or Power Spine Inset panel (UNPZ or UYPZ) to create a District Power Spine

WHAT'S INCLUDED

See below.

WHAT'S EXCLUDED

Power Spine or Power Spine Inset panel (UNPZ or UYPZ), Fascia, End Trim and Top Trim to panel must be specified separately.

NOTES

Support Kit only can be combined with the Power Spine specific panel type (UNPZ & UYPZ). Combined height with Power Spine panel (UNPZ or UYPZ) is 29" from the finished floor to the top of the finished worksurface with a leveling range of 3".

Height	Width	Support Type	WHAT'S INCLUDED				
			Medium Support Leg	Large Support Leg	Support Leg Cover	Support Post	Horizontal Support Rails
29	120	Support Post	1	2	4	-	2
29	144	Support Post	-	2	4	2	2
29	14A (144)	Support Post	-	2	4	2	3
29	168	Support Post	1	2	4	2	2
29	180	Support Post	2	2	6	-	3
29	180	Offset Support Post	1	2	4	-	3
29	192	Support Post	1	2	8	2	4
29	192	Offset Support Post	2	2	6	2	4
29	192	No Center Support Post	1	2	4	-	4
29	216	Support Post	2	2	4	-	3
29	240	No Support Post	1	2	4	-	4
29	240	Support Post	1	2	8	2	4
29	240	Offset Support Post	2	2	6	4	4
29	252	Support Post	2	2	4	-	3
29	288	Support Post	1	2	8	2	4
29	336	Support Post	2	2	8	1	4
42	96	No Support Post	-	2	2	-	2
42	120	Support Post	1	2	4	-	2
42	144	Support Post	1	2	4	-	2
42	14A (144)	Support Post	-	2	6	2	3
42	14A (144)	Offset Support Post	-	2	4	1	3
42	168	With Support Post	1	2	4	-	2
42	180	With Support Post	2	2	6	-	3
42	192	With Support Post	1	2	4	2	4
42	192	No Center Post	1	2	4	-	4
42	192	Offset Support Post	2	2	4	-	4
42	216	With Support Post	2	2	6	-	3
42	240	With Support Post	1	2	8	2	8
42	252	With Support Post	2	2	4	-	3
42	288	With Support Post	3	2	10	-	4
42	336	With Support Post	3	2	10	-	4

See Options and Pricing on the following page.

U Z P K
Power Spine Support Kit
(Continued)

PRODUCT OPTIONS

Height	Width	Support	Top Trim Finish
29, 42	096, 120, 144, 14A, 168, 180, 192, 216, 240, 252, 288, 336	C With Centre Support Post F With Offset Support Post N No Support Post	Foundation Mica Accent

SAMPLE ORDER CODE

UZPK 29	120	N	74
----------------	------------	----------	-----------

DIMENSIONS
INCHES / MM

H	W	
29 / 737	96 / 2438	(two 48" panels)
29 / 737	120 / 3048	(two 60" panels)
29 / 737	120 / 3048	(for 120" open span)
29 / 737	144 / 3658	(two 72" panels)
29 / 737	144 (A) / 3658	(for one 96" center open plus one 48" panels)
29 / 737	144 (A) / 3658	(three 48" panels)
29 / 737	168 / 4267	(two 84" panels)
29 / 737	180 / 4572	(three 60" panels)
29 / 737	180 / 4572	(for one 120" center open span plus one 60" panel)
29 / 737	192 / 4572	(four 48" panels)
29 / 737	192 / 4572	(for one 96" center open plus 48" two panels)
29 / 737	192 / 4572	(for two 96" open spans)
29 / 737	216 / 5486	(three 72" panels)
29 / 737	240 / 6096	(four 60" panels)
29 / 737	240 / 6096	(for one 120" center open span plus two 60" panels)
29 / 737	240 / 6096	(for two 120" open spans)
29 / 737	252 / 6400	(three 84" panels)
29 / 737	288 / 7315	(four 72" panels)
29 / 737	336 / 8534	(four 84" panels)
42 / 1067	96 / 2438	(two 48" panels)
42 / 1067	120 / 3048	(two 60" panels)
42 / 1067	144 / 3658	(two 72" panels)
42 / 1067	144 (A) / 3658	(for one 96" center open plus one 48" panels)
42 / 1067	144 (A) / 3658	(three 48" panels)
42 / 1067	168 / 4267	(two 84" panels)
42 / 1067	180 / 4572	(three 60" panels)
42 / 1067	192 / 4572	(four 48" panels)
42 / 1067	192 / 4572	(for one 96" center open plus 48" two panels)
42 / 1067	192 / 4572	(for two 96" open spans)
42 / 1067	216 / 5486	(three 72" panels)
42 / 1067	240 / 6096	(four 60" panels)
42 / 1067	252 / 6400	(three 84" panels)
42 / 1067	288 / 7315	(four 72" panels)
42 / 1067	336 / 8534	(four 84" panels)

PRICING

244
341
270
350
331
480
374
472
416
621
521
389
484
627
579
475
544
643
686
266
412
430
374
503
420
485
621
521
389
521
638
544
675
705

UNZZ

Zig Zag Power Spine Panel

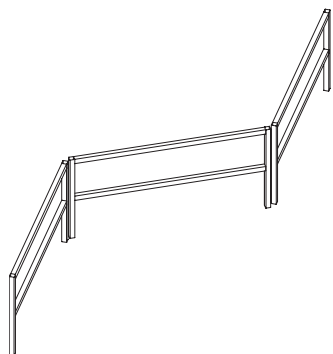

The Power Spine Panel Wall is elevated when finished with required Support Kit.

WHAT'S INCLUDED

3 frames (144 (A), 180", 216", 252" widths), 4 frames (192", 240", 288", 336" widths), 5 frames (240 (A)", 300", 360", 420" widths), hardware for straight connections and levelers.

WHAT'S EXCLUDED

Support Kit, Fascia, End Trim and Top Trim to panel must be specified separately.

NOTES

Panel wall frame has a Black finish.

PRODUCT OPTIONS

Height	Width	Support	Panel Type
29	14 A, 180, 192, 216, 240, 24 A, 252, 288, 300, 336, 360, 420	Z Zig Zag	Bare Frame

SAMPLE ORDER CODE

UNZZ 29	120	Z	~
---------	-----	---	---

DIMENSIONS INCHES / MM

H	W
29 / 737	14 (A) / 356
29 / 737	180 / 4572
29 / 737	192 / 4877
29 / 737	216 / 5486
29 / 737	240 / 6096
29 / 737	24 (A) / 610
29 / 737	252 / 6400
29 / 737	288 / 7315
29 / 737	300 / 7620
29 / 737	336 / 8534
29 / 737	360 / 9144
29 / 737	420 / 10668

PRICING

482
681
699
896
908
873
1013
1194
1135
1328
1493
1660

The Zig Zag Inset Panel Wall is designed to be used in conjunction with the Inset Glass or Smooth add-on is elevated when finished with required Support Kit.

WHAT'S INCLUDED

3 frames (144 (A), 180", 216", 252" widths), 4 frames (192", 240", 288", 336" widths), 5 frames (240 (A)", 300", 360", 420" widths), hardware for straight connections and levelers.

WHAT'S EXCLUDED

Support Kit, Fascia, End Trim and Top Trim to panel must be specified separately.

NOTES

Panel wall frame has a Black finish.

U Y Z Z
Zig Zag Power Spine Inset Panel

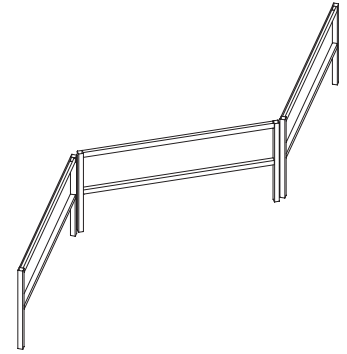

PRODUCT OPTIONS

Height	Width	Support	Panel Type
29, 42	14 A, 180, 192, 216, 240, 24A, 252, 288, 300, 336, 360, 420	Z Zig Zag	Bare Frame

SAMPLE ORDER CODE

UYZZ 29	120	Z	~
----------------	------------	----------	----------

DIMENSIONS
INCHES / MM

H	W
29 / 737	14 (A) / 356
29 / 737	180 / 4572
29 / 737	192 / 4877
29 / 737	216 / 5486
29 / 737	240 / 6096
29 / 737	24 (A) / 610
29 / 737	252 / 6400
29 / 737	288 / 7315
29 / 737	300 / 7620
29 / 737	336 / 8534
29 / 737	360 / 9144
29 / 737	420 / 10668
42 / 1067	14 (A) / 356
42 / 1067	180 / 4572
42 / 1067	192 / 4877
42 / 1067	216 / 5486
42 / 1067	240 / 6096
42 / 1067	24 (A) / 610
42 / 1067	252 / 6400
42 / 1067	288 / 7315
42 / 1067	300 / 7620
42 / 1067	336 / 8534
42 / 1067	360 / 9144
42 / 1067	420 / 10668

PRICING

592
850
870
942
1134
1088
1195
1256
1417
1593
1571
1990
653
936
957
1037
1248
1196
1314
1382
1560
1753
1728
2191

UZZK Zig Zag Support Kit

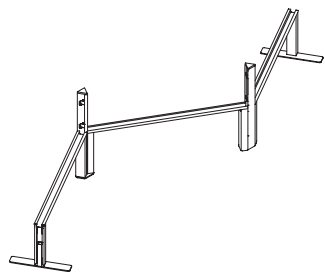

The Zig Zag Power Spine Support Kit is paired with the Zig Zag Power Spine or the Zig Zag Power Spine Inset panel (UNZZ or UYZZ) to create a Zig Zag District Power Spine.

WHAT'S INCLUDED

See chart below.

WHAT'S EXCLUDED

Zig Zag Power Spine or Zig Zag Power Spine Inset panel (UNZZ or UYZZ), Fascia, End Trim and Top Trim to panel must be specified separately.

Height	Width	Support Type	WHAT'S INCLUDED				
			Medium Support Leg	Large Support Leg	Support Leg Cover	Support Post	Horizontal Support Rails
29	120	Support Post	1	2	4	-	2
29	144	Support Post	-	2	4	2	2
29	14A (144)	Support Post	-	2	4	2	3
29	168	Support Post	1	2	4	2	2
29	180	Support Post	2	2	6	-	3
29	180	Offset Support Post	1	2	4	-	3
29	192	Support Post	1	2	8	2	4
29	192	Offset Support Post	2	2	6	2	4
29	192	No Center Support Post	1	2	4	-	4
29	216	Support Post	2	2	4	-	3
29	240	No Support Post	1	2	4	-	4
29	240	Support Post	1	2	8	2	4
29	240	Offset Support Post	2	2	6	4	4
29	252	Support Post	2	2	4	-	3
29	288	Support Post	1	2	8	2	4
29	336	Support Post	2	2	8	1	4
42	96	No Support Post	-	2	2	-	2
42	120	Support Post	1	2	4	-	2
42	144	Support Post	1	2	4	-	2
42	14A (144)	Support Post	-	2	6	2	3
42	14A (144)	Offset Support Post	-	2	4	1	3
42	168	With Support Post	1	2	4	-	2
42	180	With Support Post	2	2	6	-	3
42	192	With Support Post	1	2	4	2	4
42	192	No Center Post	1	2	4	-	4
42	192	Offset Support Post	2	2	4	-	4
42	216	With Support Post	2	2	6	-	3
42	240	With Support Post	1	2	8	2	8
42	252	With Support Post	2	2	4	-	3
42	288	With Support Post	3	2	10	-	4
42	336	With Support Post	3	2	10	-	4

See Options and Pricing on the following page.

UZZK
Zig Zag Support Kit (Continued)

PRODUCT OPTIONS

Height	Width	Support	Trim Finish
29	14 A, 180, 192, 216, 240, 24 A, 252, 288, 300, 336, 360, 420	Z Zig Zag	Foundation Mica Accent

SAMPLE ORDER CODE

UZZK 29	120	Z	~
----------------	------------	----------	----------

DIMENSIONS
INCHES / MM

H	W
29 / 737	14 (A) / 356
29 / 737	180 / 4572
29 / 737	192 / 4877
29 / 737	216 / 5486
29 / 737	240 / 6096
29 / 737	24 (A) / 610
29 / 737	252 / 6400
29 / 737	288 / 7315
29 / 737	300 / 7620
29 / 737	336 / 8534
29 / 737	360 / 9144
29 / 737	420 / 10668
42 / 1067	14 (A) / 356
42 / 1067	180 / 4572
42 / 1067	192 / 4877
42 / 1067	216 / 5486
42 / 1067	240 / 6096
42 / 1067	24 (A) / 610
42 / 1067	252 / 6400
42 / 1067	288 / 7315
42 / 1067	300 / 7620
42 / 1067	336 / 8534
42 / 1067	360 / 9144
42 / 1067	420 / 10668

PRICING

880
885
1413
890
1393
1712
895
1414
1744
1512
1768
1889
959
969
1554
980
1532
1884
990
1555
2000
1702
2011
2140

UNYH

Power Spine 120 Hub Panel

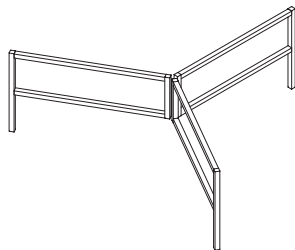

The Power Spine 120 Hub Panel is elevated when finished with required Support Kit.

WHAT'S INCLUDED

3 frames in (48" or 60" widths), hardware for 120° connections and levelers.

WHAT'S EXCLUDED

Support Kit, Fascia, End Trim and Top Trim to panel must be specified separately.

NOTES

Panel wall frame has a Black finish.

PRODUCT OPTIONS

Height	Width	Support	Panel Type
29	48, 60	P 120 Power Spine	Bare Frame

SAMPLE ORDER CODE

UNYH 29	60	N	~
---------	----	---	---

DIMENSIONS INCHES / MM

H	W
29 / 737	48 / 1219
29 / 737	60 / 1524

PRICING

525
681

The Inset 120 Hub Panel Wall is designed to be used in conjunction with the Inset Glass or Smooth add-on is elevated when finished with required Support Kit.

WHAT'S INCLUDED

3 frames in (48" or 60" widths), hardware for 120° connections and levelsers.

WHAT'S EXCLUDED

Support Kit, Fascia, End Trim and Top Trim to panel must be specified separately.

NOTES

Panel wall frame has a Black finish.

UZYH

Power Spine 120 Hub Inset Panel

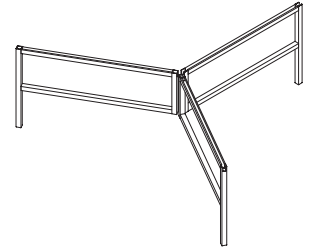

PRODUCT OPTIONS

Height	Width	Support	Panel Type
29, 42	48, 60	P 120 Power Spine	Bare Frame

SAMPLE ORDER CODE

UZYH 29	60	P	~
----------------	-----------	----------	---

**DIMENSIONS
INCHES / MM**

H	W
29 / 737	48 / 1219
29 / 737	60 / 1524
42 / 1067	48 / 1219
42 / 1067	60 / 1524

PRICING

645
850
711
936

power spine

UZYK

Power Spine 120 Hub Support Kit

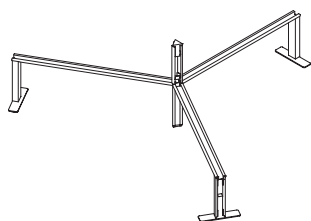

The Power Spine 120 Hub Support Kit is paired with the Power Spine 120 Hub Panel or the Power Spine 120 Hub Inset Panel (UNYH or UZYH) to create a Zig Zag District Power Spine.

WHAT'S INCLUDED

See chart below

WHAT'S EXCLUDED

Power Spine 120 Hub Panel or Power Spine 120 Hub Inset Panel (UNYH or UZYH), Fascia, End Trim and Top Trim to panel must be specified separately.

PRODUCT OPTIONS

Height	Width	Support	Top Trim Finish
29, 42	48, 60	P 120 Power Spine	Foundation Mica Accent

SAMPLE ORDER CODE

UZYK 29	60	P	74
----------------	-----------	----------	-----------

			WHAT'S INCLUDED		
Height	Width	Support Type	Support Leg Cover	Support Feet	Horizontal Support Rails
29	48	120 Junction Support	3	3	3
29	60	120 Junction Support	3	3	3
42	48	120 Junction Support	3	3	3 (for Inset 120 Hub only)
42	60	120 Junction Support	3	3	3 (for Inset 120 Hub only)

DIMENSIONS INCHES / MM

H	W
29 / 737	48 / 1219
29 / 737	60 / 1524
42 / 1067	48 / 1219
42 / 1067	60 / 1524

PRICING

650
716
727
790

U Z S S

Power Spine Lateral Floor Screen Solid

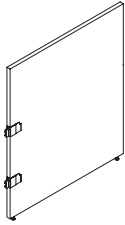

Solid Lateral Floor Screen attaches to Power Spine to provide casual lateral space division

WHAT'S INCLUDED

1 lateral solid screen, attachment brackets, support foot (48" width and above).

NOTES

Screens 48" in width and above will include a support foot. Support foot finish will automatically default to the bracket finish. The Bracket location is determined by the location of the bracket in relation to the screen. Worksurface Connection is not panel supporting. The left handed orientation will have the visible mounting brackets on the right and the support foot (if required) will be on the left. The right handed orientation will have the visible mounting brackets on the left and the support foot (if required) will be on the right.

PRODUCT OPTIONS

Bracket Attachment	Height	Depth	Handedness	Screen Support	Screen Finish	Hardware Finish
ES End Mounted Single	42 42" total	24, 30 ,36, 42, 48, 60, 72	L Left	N None	Source Laminate	Foundation
EB End Mounted Double	51 51" total		R Right	F Foot	Flintwood	Mica
ED End Mounted Shared			N Not Applicable	W Worksurface Connection	Natural Veneer	Accent
MS Mid Spine						

SAMPLE ORDER CODE

UZSS ES	51	30	R	N	AG	74
----------------	-----------	-----------	----------	----------	-----------	-----------

DIMENSIONS INCHES / MM

H	D
42 / 1067	24 / 610
42 / 1067	30 / 762
42 / 1067	36 / 914
42 / 1067	42 / 1067
51 / 1295	24 / 610
51 / 1295	30 / 762
51 / 1295	36 / 914
51 / 1295	42 / 1067

42 / 1067	48 / 1219
42 / 1067	60 / 1524
42 / 1067	72 / 1829
51 / 1295	48 / 1219
51 / 1295	60 / 1524
51 / 1295	72 / 1829

PRICING

END MOUNTED SINGLE (ES)

NO SUPPORT (N)

Source Laminate	Flintwood	Natural Veneer
402	687	687
423	764	764
465	848	848
494	928	928
418	762	762
472	858	858
525	954	954
578	1050	1050

FOOT (F)

Source Laminate	Flintwood	Natural Veneer
632	1146	1146
770	1404	1404
859	1566	1566
708	n/a	n/a
862	n/a	n/a
967	n/a	n/a

Pricing is continued on the following page.

Power Spine Lateral Floor Screen Solid (Continued)

DIMENSIONS INCHES / MM

H	D
42 / 1067	24 / 610
42 / 1067	30 / 762
42 / 1067	36 / 914
42 / 1067	42 / 1067
42 / 1067	48 / 1219
42 / 1067	60 / 1524
42 / 1067	72 / 1829
51 / 1295	24 / 610
51 / 1295	30 / 762
51 / 1295	36 / 914
51 / 1295	42 / 1067
51 / 1295	48 / 1219
51 / 1295	60 / 1524
51 / 1295	72 / 1829

H	D
42 / 1067	24 / 610
42 / 1067	30 / 762
42 / 1067	36 / 914
42 / 1067	42 / 1067
51 / 1295	24 / 610
51 / 1295	30 / 762
51 / 1295	36 / 914
51 / 1295	42 / 1067

42 / 1067	48 / 1219
42 / 1067	60 / 1524
42 / 1067	72 / 1829
51 / 1295	48 / 1219
51 / 1295	60 / 1524
51 / 1295	72 / 1829

42 / 1067	24 / 610
42 / 1067	30 / 762
42 / 1067	36 / 914
42 / 1067	42 / 1067
42 / 1067	48 / 1219
42 / 1067	60 / 1524
42 / 1067	72 / 1829
51 / 1295	24 / 610
51 / 1295	30 / 762
51 / 1295	36 / 914
51 / 1295	42 / 1067
51 / 1295	48 / 1219
51 / 1295	60 / 1524
51 / 1295	72 / 1829

PRICING

END MOUNTED SINGLE (ES) (CONTINUED)

WORKSURFACE CONNECTION (W)

Source Laminate	Flintwood	Natural Veneer
429	714	714
450	791	791
493	875	875
522	955	955
580	1094	1094
717	1352	1352
807	1514	1514
446	789	789
500	885	885
552	981	981
605	1077	1077
656	n/a	n/a
810	n/a	n/a
915	n/a	n/a

END MOUNTED DOUBLE (EB)

NO SUPPORT (N)

Source Laminate	Flintwood	Natural Veneer
402	687	687
423	764	764
465	848	848
494	928	928
418	762	762
472	858	858
525	954	954
578	1050	1050

FOOT (F)

Source Laminate	Flintwood	Natural Veneer
632	1146	1146
770	1404	1404
859	1566	1566
708	n/a	n/a
862	n/a	n/a
967	n/a	n/a

WORKSURFACE CONNECTION (W)

Source Laminate	Flintwood	Natural Veneer
429	714	714
450	791	791
493	875	875
522	955	955
580	1094	1094
717	1352	1352
807	1514	1514
446	789	789
500	885	885
552	981	981
605	1077	1077
656	n/a	n/a
810	n/a	n/a
915	n/a	n/a

Pricing is continued on the following page.

U Z S S

Power Spine Lateral Floor Screen Solid (Continued)

DIMENSIONS INCHES / MM

H	D
42 / 1067	24 / 610
42 / 1067	30 / 762
42 / 1067	36 / 914
42 / 1067	42 / 1067
42 / 1067	48 / 1219
42 / 1067	60 / 1524
42 / 1067	72 / 1829
51 / 1295	24 / 610
51 / 1295	30 / 762
51 / 1295	36 / 914
51 / 1295	42 / 1067
51 / 1295	48 / 1219
51 / 1295	60 / 1524
51 / 1295	72 / 1829

H	D
42 / 1067	24 / 610
42 / 1067	30 / 762
42 / 1067	36 / 914
42 / 1067	42 / 1067
51 / 1295	24 / 610
51 / 1295	30 / 762
51 / 1295	36 / 914
51 / 1295	42 / 1067

42 / 1067	48 / 1219
42 / 1067	60 / 1524
42 / 1067	72 / 1829
51 / 1295	48 / 1219
51 / 1295	60 / 1524
51 / 1295	72 / 1829

42 / 1067	24 / 610
42 / 1067	30 / 762
42 / 1067	36 / 914
42 / 1067	42 / 1067
42 / 1067	48 / 1219
42 / 1067	60 / 1524
42 / 1067	72 / 1829
51 / 1295	24 / 610
51 / 1295	30 / 762
51 / 1295	36 / 914
51 / 1295	42 / 1067
51 / 1295	48 / 1219
51 / 1295	60 / 1524
51 / 1295	72 / 1829

PRICING

END MOUNTED SHARED (EB)

NO SUPPORT (N)

Source Laminate	Flintwood	Natural Veneer
402	687	687
423	764	764
423	764	764
494	928	928
580	1094	1094
717	1352	1352
807	1514	1514
418	762	762
472	858	858
525	954	954
578	1050	1050
656	n/a	n/a
810	n/a	n/a
915	n/a	n/a

MID SPINE (MS)

NO SUPPORT (N)

Source Laminate	Flintwood	Natural Veneer
402	687	687
423	764	764
465	848	848
494	928	928
418	762	762
472	858	858
525	954	954
578	1050	1050

FOOT (F)

Source Laminate	Flintwood	Natural Veneer
632	1146	1146
770	1404	1404
859	1566	1566
708	n/a	n/a
862	n/a	n/a
967	n/a	n/a

WORKSURFACE CONNECTION (W)

Source Laminate	Flintwood	Natural Veneer
429	714	714
450	791	791
493	875	875
522	955	955
580	1094	1094
717	1352	1352
807	1514	1514
446	789	789
500	885	885
552	981	981
605	1077	1077
656	n/a	n/
810	n/a	n/
915	n/a	n/

UZSG

Power Spine Lateral Floor Screen with Glass

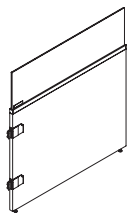

Solid Lateral Screen and Glass top attaches to a Power Spine to provide casual lateral space division

WHAT'S INCLUDED

1 lateral solid screen, attachment brackets, support foot (48" width and above).

NOTES

Screens 48" in width and above will include a support foot.

Support foot finish will automatically default to the bracket finish.

The Bracket location is determined by the location of the bracket in relation to the screen.

Worksurface Connection is not panel supporting. The left handed orientation will have the visible mounting brackets on the right and the support foot (if required) will be on the left. The right handed orientation will have the visible mounting brackets on the left and the support foot (if required) will be on the right.

Inset specific option (D) are designed to line up with the glass add-on in a complete Inset panel

PRODUCT OPTIONS

Bracket Attachment	Height	Depth	Handedness
ES End Mounted Single	G 42" total (31" plus 11" glass)	24, 30 ,36, 42, 48, 60, 72	L Left
EB End Mounted Double	D Inset 42" total (29" plus 13" glass)		R Right
ED End Mounted Shared	E Inset 51" total (42" plus 9" glass)		N Not Applicable
MS Mid Spine	F Inset 51" total (29" plus 22" glass)		

SAMPLE ORDER CODE

UZSG ES	G	30	R
----------------	----------	-----------	----------

PRODUCT OPTIONS CONTINUED

Screen Support	Screen Finish	Glass Finish	Hardware Finish
N None	Source Laminate	CL Clear	Foundation
F Foot	Flintwood	FT Frost	Mica
W Worksurface Connection	Natural Veneer		Accent

SAMPLE ORDER CODE CONTINUED

N	AG	CL	74
----------	-----------	-----------	-----------

See Pricing on the following page.

Power Spine Lateral Floor Screen
with Glass (Continued)

DIMENSIONS
INCHES / MM

PRICING

END MOUNTED SINGLE (ES)

INSET 42" TOTAL (29" PLUS 13" GLASS) (D)

NO SUPORT (N)

D	Source Laminate		Flintwood		Natural Veneer	
	Clear	Frost	Clear	Frost	Clear	Frost
24 / 610	537	654	898	940	898	1044
30 / 762	594	729	996	1045	996	1161
36 / 914	653	804	1093	1153	1093	1280
42 / 1067	709	879	1191	1260	1191	1398

FOOT (F)

	Source Laminate		Flintwood		Natural Veneer	
	Clear	Frost	Clear	Frost	Clear	Frost
48 / 1219	766	951	1283	1361	1283	1513
60 / 1524	1002	1232	1680	1766	1680	1961
72 / 1829	1270	1496	2156	2197	2269	2441

WORKSURFACE CONNECTION (W)

	Source Laminate		Flintwood		Natural Veneer	
	Clear	Frost	Clear	Frost	Clear	Frost
24 / 610	564	681	925	967	925	1072
30 / 762	621	756	1023	1073	1023	1189
36 / 914	680	832	1120	1180	1120	1307
42 / 1067	736	906	1218	1287	1218	1426
48 / 1219	714	899	1230	1309	1230	1461
60 / 1524	950	1179	1628	1713	1628	1909
72 / 1829	1218	1444	2103	2144	2217	2389

INSET 51" TOTAL (42" PLUS 9" GLASS) (E)

NO SUPORT (N)

D	Source Laminate		Flintwood		Natural Veneer	
	Clear	Frost	Clear	Frost	Clear	Frost
24 / 610	573	674	972	988	1023	1098
30 / 762	637	753	1082	1103	1138	1226
36 / 914	704	833	1193	1221	1255	1355
42 / 1067	762	906	1303	1338	1371	1483

FOOT (F)

	Source Laminate		Flintwood		Natural Veneer	
	Clear	Frost	Clear	Frost	Clear	Frost
48 / 1219	845	1002	1430	1466	1506	1631
60 / 1524	1123	1320	1906	1939	2006	2155
72 / 1829	1270	1496	2156	2197	2269	2441

WORKSURFACE CONNECTION (W)

	Source Laminate		Flintwood		Natural Veneer	
	Clear	Frost	Clear	Frost	Clear	Frost
24 / 610	601	701	999	1015	1050	1125
30 / 762	664	781	1109	1131	1165	1253
36 / 914	731	860	1220	1249	1283	1382
42 / 1067	789	934	1330	1365	1398	1510
48 / 1219	792	950	1378	1414	1454	1579
60 / 1524	1070	1268	1854	1887	1952	2102
72 / 1829	1218	1444	2103	2144	2217	2389

Pricing is continued on the following page.

U Z S G

Power Spine Lateral Floor Screen with Glass (Continued)

DIMENSIONS INCHES / MM

PRICING

END MOUNTED SINGLE (ES) (CONTINUED)

INSET 51" TOTAL (29" PLUS 22" GLASS) (F)

NO SUPPORT (N)

D	Source Laminate		Flintwood		Natural Veneer	
	Clear	Frost	Clear	Frost	Clear	Frost
24 / 610	586	745	965	1045	1017	1161
30 / 762	652	836	1073	1170	1131	1301
36 / 914	715	923	1182	1293	1244	1437
42 / 1067	781	1013	1289	1416	1357	1576

FOOT (F)

	Source Laminate		Flintwood		Natural Veneer	
	Clear	Frost	Clear	Frost	Clear	Frost
48 / 1219	872	1133	1438	1581	1514	1757
60 / 1524	1153	1471	1905	2063	2004	2292
72 / 1829	1307	1691	2156	2363	2269	2624

WORKSURFACE CONNECTION (W)

	Source Laminate		Flintwood		Natural Veneer	
	Clear	Frost	Clear	Frost	Clear	Frost
24 / 610	613	772	992	1073	1044	1189
30 / 762	679	863	1100	1198	1158	1328
36 / 914	742	950	1209	1320	1271	1464
42 / 1067	781	1013	1289	1416	1357	1576
48 / 1219	820	1081	1386	1529	1462	1705
60 / 1524	1101	1419	1852	2011	1951	2240
72 / 1829	1255	1639	2103	2310	2217	2572

END MOUNTED DOUBLE (EB)

42" TOTAL (31" PLUS 11" GLASS) (G)

NO SUPPORT (N)

D	Source Laminate		Flintwood		Natural Veneer	
	Clear	Frost	Clear	Frost	Clear	Frost
24 / 610	537	654	898	940	898	1044
30 / 762	594	729	996	1045	996	1161
36 / 914	653	804	1093	1153	1093	1280
42 / 1067	709	879	1191	1260	1191	1398

FOOT (F)

	Source Laminate		Flintwood		Natural Veneer	
	Clear	Frost	Clear	Frost	Clear	Frost
48 / 1219	766	951	1283	1361	1283	1513
60 / 1524	1002	1232	1680	1766	1680	1961
72 / 1829	1270	1496	2156	2197	2269	2441

WORKSURFACE CONNECTION (W)

	Source Laminate		Flintwood		Natural Veneer	
	Clear	Frost	Clear	Frost	Clear	Frost
24 / 610	564	681	925	967	925	1072
30 / 762	621	756	1023	1073	1023	1189
36 / 914	680	832	1120	1180	1120	1307
42 / 1067	736	906	1218	1287	1218	1426
48 / 1219	714	899	1230	1309	1230	1461
60 / 1524	950	1179	1628	1713	1628	1909
72 / 1829	1218	1444	2103	2144	2217	2389

Pricing is continued on the following page.

Power Spine Lateral Floor Screen
with Glass (Continued)

DIMENSIONS
INCHES / MM

PRICING

END MOUNTED DOUBLE (EB) (CONTINUED)

INSET 42" TOTAL (29" PLUS 13" GLASS) (D)

NO SUPORT (N)

D	Source Laminate		Flintwood		Natural Veneer	
	Clear	Frost	Clear	Frost	Clear	Frost
24 / 610	537	654	898	940	898	1044
30 / 762	594	729	996	1045	996	1161
36 / 914	653	804	1093	1153	1093	1280
42 / 1067	709	879	1191	1260	1191	1398

FOOT (F)

	Source Laminate		Flintwood		Natural Veneer	
	Clear	Frost	Clear	Frost	Clear	Frost
48 / 1219	766	951	1283	1361	1283	1513
60 / 1524	1002	1232	1680	1766	1680	1961
72 / 1829	1270	1496	2156	2197	2269	2441

WORKSURFACE CONNECTION (W)

	Source Laminate		Flintwood		Natural Veneer	
	Clear	Frost	Clear	Frost	Clear	Frost
24 / 610	564	681	925	967	925	1072
30 / 762	621	756	1023	1073	1023	1189
36 / 914	680	832	1120	1180	1120	1307
42 / 1067	736	906	1218	1287	1218	1426
48 / 1219	714	899	1230	1309	1230	1461
60 / 1524	950	1179	1628	1713	1628	1909
72 / 1829	1218	1444	2103	2144	2217	2389

INSET 51" TOTAL (42" PLUS 9" GLASS) (E)

NO SUPORT (N)

D	Source Laminate		Flintwood		Natural Veneer	
	Clear	Frost	Clear	Frost	Clear	Frost
24 / 610	573	674	972	988	1023	1098
30 / 762	637	753	1082	1103	1138	1226
36 / 914	704	833	1193	1221	1255	1355
42 / 1067	762	906	1303	1338	1371	1483

FOOT (F)

	Source Laminate		Flintwood		Natural Veneer	
	Clear	Frost	Clear	Frost	Clear	Frost
48 / 1219	845	1002	1430	1466	1506	1631
60 / 1524	1123	1320	1906	1939	2006	2155
72 / 1829	1270	1496	2156	2197	2269	2441

WORKSURFACE CONNECTION (W)

	Source Laminate		Flintwood		Natural Veneer	
	Clear	Frost	Clear	Frost	Clear	Frost
24 / 610	601	701	999	1015	1050	1125
30 / 762	664	781	1109	1131	1165	1253
36 / 914	731	860	1220	1249	1283	1382
42 / 1067	789	934	1330	1365	1398	1510
48 / 1219	792	950	1378	1414	1454	1579
60 / 1524	1070	1268	1854	1887	1952	2102
72 / 1829	1218	1444	2103	2144	2217	2389

Pricing is continued on the following page.

U Z S G

Power Spine Lateral Floor Screen with Glass (Continued)

DIMENSIONS
INCHES / MM

PRICING

END MOUNTED DOUBLE (EB) (CONTINUED)

INSET 51" TOTAL (29" PLUS 22" GLASS) (F)

NO SUPPORT (N)

D	Source Laminate		Flintwood		Natural Veneer	
	Clear	Frost	Clear	Frost	Clear	Frost
24 / 610	586	745	965	1045	1017	1161
30 / 762	652	836	1073	1170	1131	1301
36 / 914	715	923	1182	1293	1244	1437
42 / 1067	781	1013	1289	1416	1357	1576

FOOT (F)

	Source Laminate		Flintwood		Natural Veneer	
	Clear	Frost	Clear	Frost	Clear	Frost
48 / 1219	872	1133	1438	1581	1514	1757
60 / 1524	1153	1471	1905	2063	2004	2292
72 / 1829	1307	1691	2156	2363	2269	2624

WORKSURFACE CONNECTION (W)

	Source Laminate		Flintwood		Natural Veneer	
	Clear	Frost	Clear	Frost	Clear	Frost
24 / 610	613	772	992	1073	1044	1189
30 / 762	679	863	1100	1198	1158	1328
36 / 914	742	950	1209	1320	1271	1464
42 / 1067	781	1013	1289	1416	1357	1576
48 / 1219	820	1081	1386	1529	1462	1705
60 / 1524	1101	1419	1852	2011	1951	2240
72 / 1829	1255	1639	2103	2310	2217	2572

END MOUNTED SHARED (ED)

42" TOTAL (31" PLUS 11" GLASS) (G)

NO SUPPORT (N)

D	Source Laminate		Flintwood		Natural Veneer	
	Clear	Frost	Clear	Frost	Clear	Frost
24 / 610	537	654	898	940	898	1044
30 / 762	594	729	996	1045	996	1161
36 / 914	653	804	1093	1153	1093	1280
42 / 1067	709	879	1191	1260	1191	1398
48 / 1219	714	899	1230	1309	1230	1461
60 / 1524	950	1179	1628	1713	1628	1909
72 / 1829	1218	1444	2103	2144	2217	2389

INSET 42" TOTAL (29" PLUS 13" GLASS) (D)

NO SUPPORT (N)

	Source Laminate		Flintwood		Natural Veneer	
	Clear	Frost	Clear	Frost	Clear	Frost
24 / 610	537	654	898	940	898	1044
30 / 762	594	729	996	1045	996	1161
36 / 914	653	804	1093	1153	1093	1280
42 / 1067	709	879	1191	1260	1191	1398
48 / 1219	714	899	1230	1309	1230	1461
60 / 1524	950	1179	1628	1713	1628	1909
72 / 1829	1218	1444	2103	2144	2217	2389

Pricing is continued on the following page.

Power Spine Lateral Floor Screen with Glass (Continued)

DIMENSIONS INCHES / MM

PRICING

END MOUNTED SHARED (ED) (CONTINUED)

INSET 51" TOTAL (42" PLUS 9" GLASS) (E)

NO SUPPORT (N)

D	Source Laminate		Flintwood		Natural Veneer	
	Clear	Frost	Clear	Frost	Clear	Frost
24 / 610	573	674	972	988	1023	1098
30 / 762	637	753	1082	1103	1138	1226
36 / 914	704	833	1193	1221	1255	1355
42 / 1067	762	906	1303	1338	1371	1483
48 / 1219	792	950	1378	1414	1454	1579
60 / 1524	1070	1268	1854	1887	1952	2102
72 / 1829	1218	1444	2103	2144	2217	2389

INSET 51" TOTAL (29" PLUS 22" GLASS) (F)

NO SUPPORT (N)

D	Source Laminate		Flintwood		Natural Veneer	
	Clear	Frost	Clear	Frost	Clear	Frost
24 / 610	586	745	965	1045	1017	1161
30 / 762	652	836	1073	1170	1131	1301
36 / 914	715	923	1182	1293	1244	1437
42 / 1067	781	1013	1289	1416	1357	1576
48 / 1219	872	1133	1438	1581	1514	1757
60 / 1524	1153	1471	1905	2063	2004	2292
72 / 1829	1307	1691	2156	2363	2269	2624

MID SPINE (MS)

INSET 42" TOTAL (29" PLUS 13" GLASS) (D)

NO SUPPORT (N)

D	Source Laminate		Flintwood		Natural Veneer	
	Clear	Frost	Clear	Frost	Clear	Frost
24 / 610	537	654	898	940	898	1044
30 / 762	594	729	996	1045	996	1161
36 / 914	653	804	1093	1153	1093	1280
42 / 1067	709	879	1191	1260	1191	1398

FOOT (F)

	Source Laminate		Flintwood		Natural Veneer	
	Clear	Frost	Clear	Frost	Clear	Frost
48 / 1219	766	951	1283	1361	1283	1513
60 / 1524	1002	1232	1680	1766	1680	1961
72 / 1829	1270	1496	2156	2197	2269	2441

WORKSURFACE CONNECTION (W)

	Source Laminate		Flintwood		Natural Veneer	
	Clear	Frost	Clear	Frost	Clear	Frost
24 / 610	564	681	925	967	925	1072
30 / 762	621	756	1023	1073	1023	1189
36 / 914	680	832	1120	1180	1120	1307
42 / 1067	736	906	1218	1287	1218	1426
48 / 1219	714	899	1230	1309	1230	1461
60 / 1524	950	1179	1628	1713	1628	1909
72 / 1829	1218	1444	2103	2144	2217	2389

Pricing is continued on the following page.

U Z S G

Power Spine Lateral Floor Screen with Glass (Continued)

DIMENSIONS INCHES / MM

PRICING

MID SPINE (MS) (CONTINUED)

INSET 51" TOTAL (42" PLUS 9" GLASS) (E)

NO SUPPORT (N)

D	Source Laminate		Flintwood		Natural Veneer	
	Clear	Frost	Clear	Frost	Clear	Frost
24 / 610	573	674	972	988	1023	1098
30 / 762	637	753	1082	1103	1138	1226
36 / 914	704	833	1193	1221	1255	1355
42 / 1067	762	906	1303	1338	1371	1483

FOOT (F)

	Source Laminate		Flintwood		Natural Veneer	
	Clear	Frost	Clear	Frost	Clear	Frost
48 / 1219	845	1002	1430	1466	1506	1631
60 / 1524	1123	1320	1906	1939	2006	2155
72 / 1829	1270	1496	2156	2197	2269	2441

WORKSURFACE CONNECTION (W)

	Source Laminate		Flintwood		Natural Veneer	
	Clear	Frost	Clear	Frost	Clear	Frost
24 / 610	601	701	999	1015	1050	1125
30 / 762	664	781	1109	1131	1165	1253
36 / 914	731	860	1220	1249	1283	1382
42 / 1067	789	934	1330	1365	1398	1510
48 / 1219	792	950	1378	1414	1454	1579
60 / 1524	1070	1268	1854	1887	1952	2102
72 / 1829	1218	1444	2103	2144	2217	2389

INSET 51" TOTAL (29" PLUS 22" GLASS) (F)

NO SUPPORT (N)

D	Source Laminate		Flintwood		Natural Veneer	
	Clear	Frost	Clear	Frost	Clear	Frost
24 / 610	586	745	965	1045	1017	1161
30 / 762	652	836	1073	1170	1131	1301
36 / 914	715	923	1182	1293	1244	1437
42 / 1067	781	1013	1289	1416	1357	1576

FOOT (F)

	Source Laminate		Flintwood		Natural Veneer	
	Clear	Frost	Clear	Frost	Clear	Frost
48 / 1219	872	1133	1438	1581	1514	1757
60 / 1524	1153	1471	1905	2063	2004	2292
72 / 1829	1307	1691	2156	2363	2269	2624

WORKSURFACE CONNECTION (W)

	Source Laminate		Flintwood		Natural Veneer	
	Clear	Frost	Clear	Frost	Clear	Frost
24 / 610	613	772	992	1073	1044	1189
30 / 762	679	863	1100	1198	1158	1328
36 / 914	742	950	1209	1320	1271	1464
42 / 1067	781	1013	1289	1416	1357	1576
48 / 1219	820	1081	1386	1529	1462	1705
60 / 1524	1101	1419	1852	2011	1951	2240
72 / 1829	1255	1639	2103	2310	2217	2572

Y S Z

hiSpace Quick Connect Height-Adjustable Freestanding Table Mechanism for District Power Spine

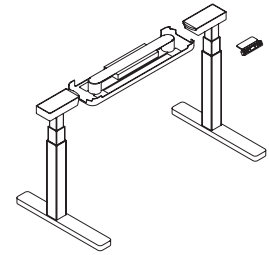

hiSpace Quick Connect Height-Adjustable Freestanding Table Mechanism must be paired with Rectangular Height-Adjustable Worksurface with Connection Kit for District Power Spine(WBZ) to create a complete table solution.

WHAT'S INCLUDED

1 pair of feet, 1 pair of leg columns, 1 power pak (includes 1 cable organizer with felt cover, pre-installed control box, 1 switch, 1 15' power cord, 2 motor cables)

WHAT'S EXCLUDED

This is not a complete Base Only product. The Connection Kit top frame is required and included on WBZ.

NOTES

Meets ANSI/BIFMA testing requirements.

BIFMA compliant height-adjustment range from 22.6" to 48.7" from the top of a 1" thick worksurface.

Includes a 240V universal control box.

Standby power consumption of 0.2W.

Power cord is 15' long.

PRODUCT OPTIONS

Base Mechanism	Surface Depth	Surface Width	Power Spine Orientation	Base Finish
9E Extended Electric (22.6" - 48.7")	23, 29	52, 58, 64, 70	C Spine Front & Centered for Parallel L Spine Left for Perpendicular R Spine Right for Perpendicular	52 Ebony 60 Platinum 83 Very White

SAMPLE ORDER CODE

YSZ 9E	29	58	R	52
---------------	-----------	-----------	----------	-----------

PRODUCT OPTIONS (CONTINUED)

Switch	Power Pack	Wire Management	Wire Management Finish
D Display with Up/Down Memory	I Cable Organizer with Felt Cover N None	N None C With Vertical Wire Carrier	E Ebony Coordinate 7 Platinum Coordinate V Very White Coordinate

SAMPLE ORDER CODE (CONTINUED)

D	I	C	E
----------	----------	----------	----------

PRICING

1700

If Vertical Wire Carrier is specified, add 276

W B Z

Rectangular Height-Adjustable Worksurface with Connection Kit for hiSpace Quick Connect with District Power Spine

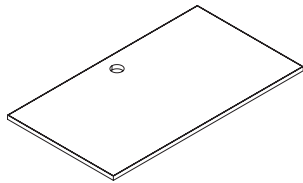

Rectangular Height-Adjustable Worksurface with Connection Kit for hiSpace Quick Connect must be paired with hiSpace Quick Connect Height-Adjustable Freestanding Table Mechanism for District Power Spine (YSZ) to create a complete table solution.

WHAT'S INCLUDED

1 worksurface with factory installed connection kit.

NOTES

Dimensions are actual width and actual depth.

Power Spine provision will reduce the distance between leg columns for the selected width by 6".

PRODUCT OPTIONS

Base Mechanism	Actual Depth	Actual Width	Power Spine Orientation	Cut Out Style
9E Extended Electric (22.6" - 48.7")	23, 29	52, 58, 64, 70	C Spine Front & Centered for Parallel L Spine Left for Perpendicular R Spine Right for Perpendicular	N None R Rectangular (Diamond Shaped Cutout) G Round (2.75" Diameter)

SAMPLE ORDER CODE

WBZ 9	29	58	C	G
--------------	-----------	-----------	----------	----------

PRODUCT OPTIONS (CONTINUED)

Cut Out Location	Worksurface Finish	Edge Trim	Edge Trim Finish	Connection Kit Finish
N None C Center	Foundation Laminate	2 Bullnose (with Foundation) 6 Straight (with Foundation) 8 Flat (with Foundation)	Edge Trim Colors	52 Ebony 60 Platinum 83 Very White

SAMPLE ORDER CODE (CONTINUED)

C	LW	8	ST	52
----------	-----------	----------	-----------	-----------

See Pricing on the following page.

W B Z

**Rectangular Height-Adjustable
Worksurface with Connection Kit for
hiSpace Quick Connect with District
Power Spine (Continued)**

**DIMENSIONS
INCHES / MM**

D	W
23 / 584	52 / 1321
23 / 584	58 / 1473
23 / 584	64 / 1626
23 / 584	70 / 1778
29 / 737	52 / 1321
29 / 737	58 / 1473
29 / 737	64 / 1626
29 / 737	70 / 1778

PRICING

Flat Trim	Straight Trim	Bullnose Trim
628	635	707
635	645	721
644	655	736
654	664	752
643	653	730
654	663	745
664	674	761
674	686	778

If one Cut Out is specified, add 35

power spine

Y S B

hiSpace Quick Connect Parallelogram Height-Adjustable Freestanding Table Mechanism for District Power Spine

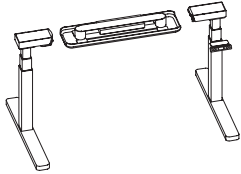

hiSpace Quick Connect Height-Adjustable Freestanding Parallelogram Table Mechanism must be paired with Parallelogram Height-Adjustable Worksurface with Connection Kit for District Power Spine(WBP) to create a complete table solution.

WHAT'S INCLUDED

1 pair of feet, 1 pair of leg columns, 1 power pak (includes 1 cable organizer with felt cover, pre-installed control box, 1 switch, 1 15' power cord, 2 motor cables).

WHAT'S EXCLUDED

This is not a complete Base Only product. The Connection Kit top frame is required and included on WBP.

NOTES

Meets ANSI/BIFMA testing requirements.

BIFMA compliant height-adjustment range from 22.6" to 48.7" from the top of a 1" thick worksurface.

Includes a 240V universal control box. Standby power consumption of 0.2W.

Power cord is 15' long.

PRODUCT OPTIONS

Base Mechanism	Surface Depth	Surface Width	Handedness	Base Finish
9E Extended Electric (22.6" - 48.7")	23, 29	60, 72	C Spine Front & Centered for Parallel L Left Hand R Right Hand	52 Ebony 60 Platinum 83 Very White

SAMPLE ORDER CODE

YSB 9E	29	72	R	52
---------------	-----------	-----------	----------	-----------

PRODUCT OPTIONS (CONTINUED)

Switch	Power Pak	Undersurface Cable Management	Vertical Wire Carrier	Vertical Wire Carrier Finish
D Display with Up/Down Memory	N None 1 Cable Organizer with Felt Cover	N None 4 Dual Plastic Tray	N None 7 With Vertical Wire Carrier	E Ebony Coordinate 7 Platinum Coordinate V Very White Coordinate

SAMPLE ORDER CODE (CONTINUED)

D	1	4	N	7
----------	----------	----------	----------	----------

PRICING

No Power Pak	Power Pak Cable Organizer with Felt Cover
1700	1941

If Cable Management, Dual Plastic Tray (4) is specified, add 48

If Vertical Wire Carrier is specified, add 277

W B P

**Parallelogram Height-Adjustable
Worksurface with Connection Kit
for District Power Spine**

Parallelogram Height-Adjustable Worksurface with Connection Kit for hiSpace Quick Connect must be paired with hiSpace Quick Connect Height-Adjustable Parallelogram Freestanding Table Mechanism for District Power Spine (YSB) to create a complete table solution.

WHAT'S INCLUDED

1 worksurface with factory installed connection kit.

NOTES

Dimension are actual width and actual depth. Power Spine provision will reduce the distance between leg columns for the selected width by 6".

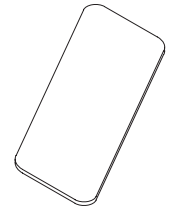

PRODUCT OPTIONS

Base Mechanism	Actual Depth	Surface Width	Power Spine Orientation	Handedness	Cut Out Style
9E Extended Electric (22.6" - 48.7")	23, 29	60, 72	C Spine Front & Centered for Parallel	LH Left Hand RH Right Hand	N None G Round (2.75" Diameter)

SAMPLE ORDER CODE

WBP 9E	29	60	C	LH	G
---------------	-----------	-----------	----------	-----------	----------

PRODUCT OPTIONS (CONTINUED)

Cut Out Location	Corner Condition	Surface Finish	Edge Trim Styles	Edge Trim Finish	Connection Kit Finish
N None C Center	A Four RadiusCorners	Foundation Laminate	8 Flat Trim 6 Straight Trim 2 Bullnose Trim H Full Knife Trim	Edge Trim Colors	52 Ebony 60 Platinum 83 VeryWhite

SAMPLE ORDER CODE (CONTINUED)

C	R	LW	8	ST	52
----------	----------	-----------	----------	-----------	-----------

**DIMENSIONS
INCHES / MM**

D	W
23 / 584	60 / 1524
23 / 584	72 / 1829
29 / 737	60 / 1524
29 / 737	72 / 1829

PRICING

NO CUT OUT (N)				ROUND CUT OUT (G) / CENTER CUT OUT (C)			
Flat Trim	Straight Trim	Bullnose Trim	Full Knife Trim	Flat Trim	Straight Trim	Bullnose Trim	Full Knife Trim
442	452	491	576	478	487	527	611
463	473	514	603	499	508	550	638
660	674	733	858	695	709	768	893
670	684	744	871	706	719	780	907

Y S T

hiSpace Quick Connect 120 Hub Height-Adjustable Freestanding Table Mechanism for District Power Spine

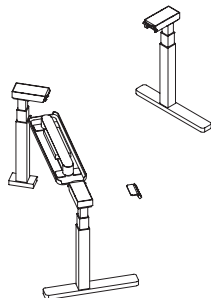

hiSpace Quick Connect Height-Adjustable Freestanding 120 Table Mechanism must be paired with 120 Height-Adjustable Worksurface with Connection Kit for District Power Spine (WBT) to create a complete table solution.

WHAT'S INCLUDED

1 3-point extended corner electric height-adjustable mechanism, quick connect kit, all assembly hardware, shipped knocked down.

WHAT'S EXCLUDED

This is not a complete Base Only product. Paired with WBT 120 Hub Height -Adjustable with Connection Kit.

NOTES

Always uses a C-Leg Application. Table frame and surface orientation are field reversible. Orientation Left (L) and Right (R) refers to placement of the primary surface. Surface dimensions are actual width and actual depth.

PRODUCT OPTIONS

Base Mechanism	Surface Depth	Surface Width	Base Finish
9E Extended Electric (22.6" - 48.7")	23, 29	46, 58	52 Ebony 60 Platinum 83 Very White

SAMPLE ORDER CODE

YST 9E	29	70	52
---------------	-----------	-----------	-----------

PRODUCT OPTIONS CONTINUED

Switch	Power Pak	Undersurface Cable Management	Vertical Wire Carrier	Vertical Wire Carrier Finish
D Display with Up/Down Memory	N None 1 Cable Organizer with Felt Cover	N None 4 Dual PlasticTray	N None - With Vertical Wire Carrier	E Ebony Coordinate 7 Platinum Coordinate V Very White Coordinate

SAMPLE ORDER CODE CONTINUED

D	1	4	N	E
----------	----------	----------	----------	----------

PRICING

No Vertical Wire Carrier	With Vertical Wire Carrier
2277	2554

W B T

hiSpace Quick Connect 120 Hub Height-Adjustable Freestanding Table Mechanism for District Power Spine

120 Hub Height-Adjustable Worksurface with Connection Kit for hiSpace Quick Connect must be paired with hiSpace Quick Connect Height-Adjustable 120 Table Mechanism for District Power Spine (YST) to create a complete table solution.

WHAT'S INCLUDED

1 worksurface.

WHAT'S EXCLUDED

The proper grommet for each cut out style must be ordered separately

NOTES

Worksurface includes only specified cut outs.

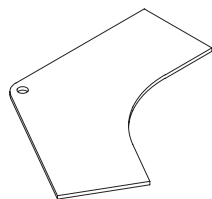

PRODUCT OPTIONS

Base Mechanism	Actual Depth	Actual Width	Cut Out Style
9E Extended Electric (22.6" - 48.7")	23, 29	46, 58	N None G Round (2.75" Diameter)

SAMPLE ORDER CODE

WBT 9E	29	60	G
---------------	-----------	-----------	----------

PRODUCT OPTIONS CONTINUED

Cut Out Location	Surface Finish	Edge Trim Styles	Edge Trim Finish
N None C Center L Left R Right B Left & Right A Center & Left D Center & Right E Center, Left & Right	Foundation Laminate	8 Flat Trim 6 Straight Trim 2 Bullnose Trim H Full Knife Trim	Edge Trim Colors

SAMPLE ORDER CODE CONTINUED

N	LW	LW	ST
----------	-----------	-----------	-----------

See Pricing on the following page.

W B T

hiSpace Quick Connect 120 Hub Height-Adjustable Freestanding Table Mechanism for District Power Spine (Continued)

**DIMENSIONS
INCHES / MM**

D	W
23 / 584	46 / 1168
23 / 584	58 / 1473
29 / 737	46 / 1168
29 / 737	58 / 1473

D	W
23 / 584	46 / 1168
23 / 584	58 / 1473
29 / 737	46 / 1168
29 / 737	58 / 1473

23 / 584	46 / 1168
23 / 584	58 / 1473
29 / 737	46 / 1168
29 / 737	58 / 1473

23 / 584	46 / 1168
23 / 584	58 / 1473
29 / 737	46 / 1168
29 / 737	58 / 1473

PRICING**NO CUT OUT (N)****NONE (N)**

Flat Trim	Straight Trim	Bullnose Trim	Full Knife Trim
694	708	770	903
1220	1244	1354	1586
705	719	782	916
1230	1255	1366	1600

ROUND CUT OUT (G)**LEFT (L), RIGHT (R)**

Flat Trim	Straight Trim	Bullnose Trim	Full Knife Trim
730	743	806	938
1255	1279	1390	1622
740	755	817	951
1266	1291	1401	1635

CENTER (C), CENTER & LEFT (A), LEFT & RIGHT (B), CENTER & RIGHT (D)

Flat Trim	Straight Trim	Bullnose Trim	Full Knife Trim
765	779	841	973
1291	1315	1425	1657
776	790	853	987
1301	1326	1437	1671

CENTER, LEFT & RIGHT (E)

Flat Trim	Straight Trim	Bullnose Trim	Full Knife Trim
801	814	877	1009
1326	1350	1461	1693
811	826	888	1022
1337	1362	1472	1706

U Z W E

Power Spine Rectangle Worksurface

The Rectangle Worksurface provides a range of depths to support both primary and secondary worksurface applications.

WHAT'S INCLUDED

1 worksurface.

WHAT'S EXCLUDED

The proper grommet for each cut out style must be ordered separately.

NOTES

Actual depth is 1" less than nominal depth to allow for a cable management gap at the back and to align with storage. Actual width equals nominal width, allowance for gaps at side edges must be specified.

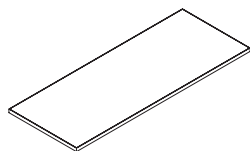

PRODUCT OPTIONS

Depth	Width	Application	Worsurface Finish
24, 30	48, 54, 60, 66, 72	A Freestanding - 4 Legs B Perpendicular - 2 Legs	Foundation Laminate Flintwood Natural Veneer

SAMPLE ORDER CODE

UZWE 24	48	A	LW
---------	----	---	----

PRODUCT OPTIONS CONTINUED

Edge Trim Profile	Edge Trim Finish	Grommet (optional)	Grommet Finish
8 Flat H Full Knife	PVC Acrylic	N No Grommet 2 Centered Grommet	Foundation Mica P Storm White Q Espresso 7 Platinum V Very White

SAMPLE ORDER CODE CONTINUED

8	ST	2	7
---	----	---	---

See Pricing on the following page.

U Z W E
Power Spine Rectangle
Worksurface(Continued)

DIMENSIONS
INCHES / MM**PRICING**

D	W	Foundation Flat Trim	Foundation Full Knife	Flintwood Flat Trim	Flintwood Full Knife	Veneer Flat Trim	Veneer Full Knife
24 / 610	48 / 1219	411	530	1021	1177	1069	1234
24 / 610	54 / 1372	542	702	1090	1252	1141	1312
24 / 610	60 / 1524	551	715	1177	1352	1234	1416
24 / 610	66 / 1676	559	729	1245	1427	1305	1496
24 / 610	72 / 1829	568	741	1314	1502	1377	1573
30 / 762	48 / 1219	451	578	1139	1313	1194	1377
30 / 762	54 / 1372	558	723	1216	1397	1275	1464
30 / 762	60 / 1524	568	738	1292	1482	1354	1553
30 / 762	66 / 1676	580	755	1407	1616	1475	1694
30 / 762	72 / 1829	588	767	1483	1700	1554	1782

If Grommet is specified, add 35

U Z W C

Power Spine Rectangle Worksurface Support Bundle

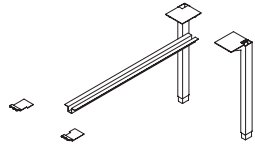

The Rectangle Worksurface Support Bundle provides a support to both primary and secondary worksurface applications. Included with the kit is the Worksurface Panel Wall Bracket connects a worksurface to a panel wall providing support. The Table Leg is available with a Fixed option that provides an Intermediate fixed to worksurface support.

WHAT'S INCLUDED

2 worksurface panel wall brackets (one left oriented, one right oriented), 2 legs with attachment hardware.

WHAT'S EXCLUDED

Support Kit, Fascia, End Trim and Top Trim to panel must be specified separately.

NOTES

Panel wall frame has a Black finish.

PRODUCT OPTIONS

Depth	Width	Leg Type	Application	Support Finish
24, 30	48, 54, 60, 66, 72	L Standard Leg	A Freestanding - 4 Legs B Perpendicular - 2 Legs	Foundation Mica Accent

SAMPLE ORDER CODE

UZWC 24	48	L	A	74
---------	----	---	---	----

DIMENSIONS INCHES / MM

D	W
24 / 610	48 / 1219
24 / 610	54 / 1372
24 / 610	60 / 1524
24 / 610	66 / 1676
24 / 610	72 / 1829
30 / 762	48 / 1219
30 / 762	54 / 1372
30 / 762	60 / 1524
30 / 762	66 / 1676
30 / 762	72 / 1829

PRICING

PERPENDICULAR - 2 LEGS (B)		FREESTANDING - 4 LEGS (A)	
Foundation	Mica/Accent	Foundation	Mica/Accent
422	455	775	808
453	486	820	854
484	517	831	864
515	549	841	874
547	580	852	885
422	455	775	808
453	486	820	854
484	517	831	864
515	549	841	874
547	580	852	885

U Z W P

Power Spine Parallelogram Worksurface

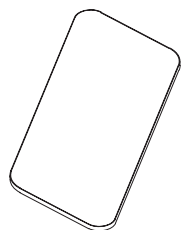

The Parallel Worksurface provides a range of depths to support both primary and secondary worksurface applications.

WHAT'S INCLUDED

1 worksurface.

WHAT'S EXCLUDED

The proper grommet for each cut out style must be ordered separately

NOTES

Actual depth is 1" less than nominal depth to allow for a cable management gap at the back and to align with storage. Actual width equals nominal width, allowance for gaps at side edges must be specified.

PRODUCT OPTIONS

Depth	Width	Handedness	Application
24, 30	48, 54, 60, 66, 72	LH Left Hand RH Right Hand	A Freestanding - 4 Legs C Parrallel - 2 Legs D Parrallel - 1 Leg

SAMPLE ORDER CODE

UZWP 24	48	LH	A
----------------	-----------	-----------	----------

PRODUCT OPTIONS CONTINUED

Worksurface Finish	Edge Trim Styles	Edge Trim Finishes	Grommet (Optional)	Grommet Finish
Foundation Laminate Flintwood Natural Veneer	8 Flat (Foundation Laminate) 9 Flat (Flintwood / Veneer) H Full Knife	PVC Acrylic	N No Grommet 2 Centered	Foundation Mica P Storm White Q Espresso 7 Platinum V Very White

SAMPLE ORDER CODE CONTINUED

LW	8	ST	2	7
-----------	----------	-----------	----------	----------

See Pricing on the following page.

U Z W P

Power Spine Parallelogram Worksurface (Continued)

DIMENSIONS INCHES / MM

D	W
24 / 610	48 / 1219
24 / 610	54 / 1372
24 / 610	60 / 1524
24 / 610	66 / 1676
24 / 610	72 / 1829
30 / 762	48 / 1219
30 / 762	54 / 1372
30 / 762	60 / 1524
30 / 762	66 / 1676
30 / 762	72 / 1829

PRICING

Foundation Flat Trim	Foundation Full Knife	Flintwood Flat Trim	Flintwood Full Knife	Veneer Flat Trim	Veneer Full Knife
422	549	1055	1160	1108	1218
432	562	1081	1189	1135	1248
442	576	1107	1217	1162	1277
453	589	1133	1246	1189	1309
463	603	1238	1362	1299	1429
474	616	1185	1303	1244	1369
484	630	1211	1331	1271	1398
660	858	1650	1816	1732	1906
665	865	1664	1830	1747	1922
670	871	1676	1844	1760	1936

If Grommet is specified, add 35

U Z W K

Power Spine Parallelogram Worksurface Support Bundle

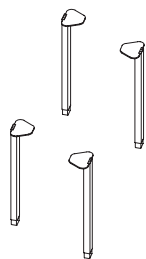

The Parallel Worksurface Support Bundle provides support to both primary and secondary worksurface applications. Included with the kit is the Worksurface Panel Wall Bracket connects a worksurface to a panel wall providing support. The Table Leg is available with a Fixed option that provides an Intermediate fixed to worksurface support.

WHAT'S INCLUDED

Included with the kit is the Worksurface Panel Wall Bracket connects a worksurface to a panel wall providing support. The Table Leg is available with a Fixed option that provides an Intermediate fixed to worksurface support.

WHAT'S EXCLUDED

Parallel Worksurface (UZWP)

PRODUCT OPTIONS

Depth	Width	Leg Type	Application	Handedness	Support Finish
24, 30	48, 54, 60, 66, 72	C Standard Leg for Curved Radius	A Freestanding - 4 Legs C Parallel - 2 Legs D Parallel - 1 Leg	LH Left RH Right	Foundation Mica Accent

SAMPLE ORDER CODE

UZWK 24	48	L	A	LH	74
---------	----	---	---	----	----

DIMENSIONS INCHES / MM

D	W
24 / 610	48 / 1219
24 / 610	54 / 1372
24 / 610	60 / 1524
24 / 610	66 / 1676
24 / 610	72 / 1829
30 / 762	48 / 1219
30 / 762	54 / 1372
30 / 762	60 / 1524
30 / 762	66 / 1676
30 / 762	72 / 1829

PRICING

PARRALEL - 1 LEG (D)		PARRALEL - 2 LEG (C)		FREESTANDING - 4 LEGS (A)	
Foundation	Mica/Accent	Foundation	Mica/Accent	Foundation	Mica/Accent
221	254	392	426	723	757
221	254	392	426	723	757
231	264	403	436	734	767
231	264	403	436	734	767
252	285	424	457	755	788
221	254	392	426	723	757
221	254	392	426	723	757
231	264	403	436	734	767
231	264	403	436	734	767
252	285	424	457	755	788

U Z W A Power Spine Angled Worksurface

The Angled Worksurface provides a range of depths to support both primary and secondary worksurface applications.

WHAT'S INCLUDED

1 worksurface.

WHAT'S EXCLUDED

120 Angled Worksurface Support Bundle (UZWB)

NOTES

Actual depth is 1" less than nominal depth to allow for a cable management gap at the back and to align with storage. Actual width equals nominal width, allowance for gaps at side edges must be specified.

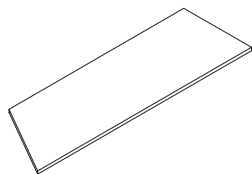

PRODUCT OPTIONS

Depth	Width	Handedness	Application
24, 30	48, 54, 60, 66, 72	LH Left Hand RH Right Hand	B Perpendicular - 2 Legs D Parallel - 1 Leg

SAMPLE ORDER CODE

UZWA 24	48	LH	B
----------------	-----------	-----------	----------

PRODUCT OPTIONS CONTINUED

Worksurface Finish	Edge Trim Styles	Edge Trim Finishes	Grommet (Optional)	Grommet Finish
Foundation Laminate Flintwood Natural Veneer	8 Flat (Foundation Laminate) 9 Flat (Flintwood / Veneer) H Full Knife	PVC Acrylic	N No Grommet 2 Centered	Foundation Mica P Storm White Q Espresso 7 Platinum V Very White

SAMPLE ORDER CODE CONTINUED

LW	8	ST	2	7
-----------	----------	-----------	----------	----------

See Pricing on the following page.

U Z W A

Power Spine Angled Worksurface (Continued)

DIMENSIONS INCHES / MM

D	W
24 / 610	48 / 1219
24 / 610	54 / 1372
24 / 610	60 / 1524
24 / 610	66 / 1676
24 / 610	72 / 1829
30 / 762	48 / 1219
30 / 762	54 / 1372
30 / 762	60 / 1524
30 / 762	66 / 1676
30 / 762	72 / 1829

PRICING

Foundation Flat Trim	Foundation Full Knife	Flintwood Flat Trim	Flintwood Full Knife	Veneer Flat Trim	Veneer Full Knife
421	564	967	1298	1015	1363
429	573	987	1317	1036	1382
437	581	1006	1336	1056	1402
446	589	1024	1355	1075	1423
454	595	1044	1370	1096	1439
462	620	1063	1427	1116	1499
472	630	1085	1449	1139	1522
618	838	1422	1928	1493	2025
627	846	1442	1947	1514	2045
635	855	1461	1965	1533	2063

If Grommet is specified, add 35

U Z W B

Power Spine Angled Worksurface Support Bundle

The 120 Angled Worksurface Support bundle mounts to the underside of a worksurface and to the 120 Power Spine Hub to provide support for the worksurface.

WHAT'S INCLUDED

Brackets, as specified and attachment hardware. This support kit is designed to accompany 120 Angled Worksurface

WHAT'S EXCLUDED

120 Angled Worksurface (UZWA)

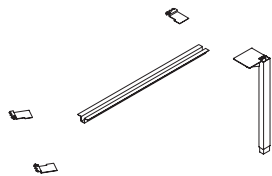

PRODUCT OPTIONS

Depth	Width	Leg Type	Application	Handedness	Support Finish
24, 30	48, 54, 60, 66, 72	L Standard Leg	B Perpendicular - 2 Legs D Parallel - 1 Leg	LH Left RH Right	Foundation Mica Accent

SAMPLE ORDER CODE

UZWB 24	48	L	B	LH	74
---------	----	---	---	----	----

DIMENSIONS INCHES / MM

D	W
24 / 610	48 / 1219
24 / 610	54 / 1372
24 / 610	60 / 1524
24 / 610	66 / 1676
24 / 610	72 / 1829
30 / 762	48 / 1219
30 / 762	54 / 1372
30 / 762	60 / 1524
30 / 762	66 / 1676
30 / 762	72 / 1829

PRICING

PARRALEL - 1 LEG (D)		PERPENDICULAR - 2 LEG (B)	
Foundation	Mica/Accent	Foundation	Mica/Accent
234	268	422	455
276	309	463	497
318	351	505	538
359	392	526	559
401	434	536	569
257	290	463	497
303	336	509	542
349	382	555	588
395	428	578	611
440	474	589	623

Dual 120 Angled Worksurface provides two face to face worksurfaces in a range of depths to support both primary worksurface applications.

WHAT'S INCLUDED

2 worksurfaces with connection supports.

WHAT'S EXCLUDED

Dual 120 Angled Worksurface Support Bundle (UZDK).

NOTES

Actual depth is 1" less than nominal depth to allow for a cable management gap at the back and to align with storage. Actual width equals nominal width, allowance for gaps at side edges must be specified.

U Z W D
Power Spine Dual 120 Angled Worksurface

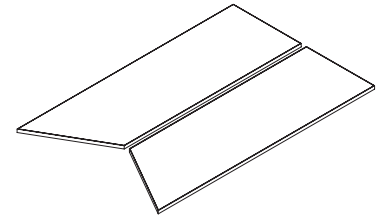

PRODUCT OPTIONS

Depth	Width	Application	Worksurface Finish	Edge Trim		Grommet (Optional)		Grommet Finish	
				Styles	Finish				
48, 60	48, 54, 60, 66, 72	B Perpendicular - 2 Legs	Foundation Flintwood Natural Veneer	8	Flat (Foundation Laminate)	PVC Acrylic	N	No Grommet	Foundation
				9	Flat (Natural Veneer)		2	Centered	Mica P Storm White Q Espresso 7 Platinum V Very White

SAMPLE ORDER CODE

UZWD 24	48	B	LW	8	ST	2	7
----------------	-----------	----------	-----------	----------	-----------	----------	----------

DIMENSIONS INCHES / MM

D	W
48 / 1219	48 / 1219
48 / 1219	54 / 1372
48 / 1219	60 / 1524
48 / 1219	66 / 1676
48 / 1219	72 / 1829
60 / 1524	48 / 1219
60 / 1524	54 / 1372
60 / 1524	60 / 1524
60 / 1524	66 / 1676
60 / 1524	72 / 1829

PRICING

	Foundation	Flintwood	Veneer
	841	1934	2031
	858	2059	2162
	874	2099	2204
	891	2138	2245
	908	2269	2383
	924	2311	2427
	943	2358	2475
	1237	2844	2987
	1253	2883	3026
	1270	2921	3067

If Grommet is specified, add 71

UZDK

Power Spine Dual Angled Worksurface Support Bundle

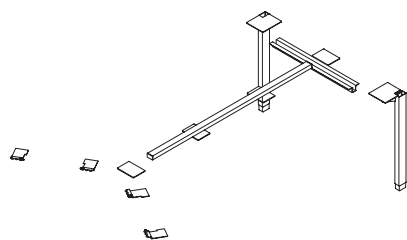

The Dual 120 Angled Worksurface Support bundle mounts to the underside of a worksurface and to the Zig Zag Power Spine Hub to provide support for the worksurface

WHAT'S INCLUDED

Included with the kit is the Worksurface Panel Wall Bracket connects a worksurface to a panel wall providing support. The Table Leg is available with a Fixed option that provides a Intermediate fixed to worksurface support.

WHAT'S EXCLUDED

Dual 120 Angled Worksurface (UZWD).

PRODUCT OPTIONS

Depth	Width	Leg Type	Application	Support Finish
48, 60	48, 54, 60, 66, 72	L Standard Leg	B Perpendicular - 2 legs	Foundation Mica Accent

SAMPLE ORDER CODE

UZDK 48	48	L	B	LW
----------------	-----------	----------	----------	-----------

DIMENSIONS INCHES / MM

D	W
48 / 1219	48 / 1219
48 / 1219	54 / 1372
48 / 1219	60 / 1524
48 / 1219	66 / 1676
48 / 1219	72 / 1829
60 / 1524	48 / 1219
48 / 1524	54 / 1372
48 / 1524	60 / 1524
48 / 1524	66 / 1676
48 / 1524	72 / 1829

PRICING

Foundation	Mica/Accent
620	644
705	729
789	813
805	829
819	843
683	707
776	799
868	892
885	909
902	925

U Z W T

Power Spine 120 Hub Worksurface

The 120 Hub Worksurface provides a range of depths to support both primary and secondary worksurface applications.

WHAT'S INCLUDED

1 worksurface.

WHAT'S EXCLUDED

The proper grommet for each cut out style must be ordered separately.

NOTES

Actual depth is 1" less than nominal depth to allow for a cable management gap at the back and to align with storage. Actual width equals nominal width, allowance for gaps at side edges must be specified.

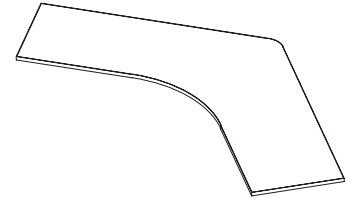

PRODUCT OPTIONS

Depth	Width	Application	Worksurface Finish	Edge Trim Styles	Edge Trim Finish	Grommet (Optional)
24, 30	48, 60	E Semi Supported - 2 Legs	Foundation Flintwood Natural Veneer	8 Flat (Foundation Laminate) 9 Flat (Natural Veneer)	PVC Acrylic	N No Grommet C Centered L Left R Right B Left & Right A Center & Left D Center & Right E Center, Left & Right

SAMPLE ORDER CODE

UZWT 24	48	E	LW	8	ST	C
----------------	-----------	----------	-----------	----------	-----------	----------

**DIMENSIONS
INCHES / MM**

D	W
24 / 610	48 / 1219
24 / 610	60 / 1524
30 / 762	48 / 1219
30 / 762	60 / 1524

PRICING

Foundation Flat Trim	Foundation Full Knife	Flintwood Flat Trim	Flintwood Full Knife	Veneer Flat Trim	Veneer Full Knife
694	903	2057	2256	2160	2368
1220	1586	2807	3088	2947	3242
705	916	2161	2360	2269	2478
1230	1600	2830	3114	2972	3270

If Grommet (C), (L), (R) is specified, add 35

If Grommet (A), (B), (D) is specified, add 71

If Grommet (E) is specified, add 106

U Z W W

Power Spine 120 HUB Worksurface Support Bundle

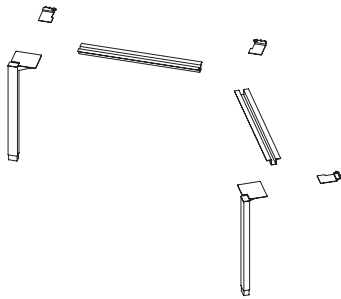

The 120 Hub Worksurface Support Bundle provides support to both primary and secondary worksurface applications. Included with the kit is the Worksurface Panel Wall Bracket connects a worksurface to a panel wall providing support. The Table Leg is available with a Fixed option that provides an Intermediate fixed to worksurface support.

WHAT'S INCLUDED

Included with the kit is the Worksurface Panel Wall Bracket connects a worksurface to a panel wall providing support. The Table Leg is available with a Fixed option that provides an Intermediate fixed to worksurface support.

WHAT'S EXCLUDED

120 Hub Worksurface (UZWT)

PRODUCT OPTIONS

Depth	Width	Leg Type	Application	Support Finish
24, 30	48, 60	L Standard Leg	E Semi Supported - 2 Legss	Foundation Mica Accent

SAMPLE ORDER CODE

UZWW 24	48	L	E	74
---------	----	---	---	----

DIMENSIONS INCHES / MM

D	W
24 / 610	48 / 1219
24 / 610	60 / 1524
30 / 762	48 / 1219
30 / 762	60 / 1524

PRICING

Foundation	Mica/Accent
507	540
507	540
507	540
507	540

screens

screens product map

UNSDT Desk Top Casual Screen

Page 546

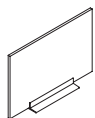

UNSEDE Desk Edge Screen

Page 547

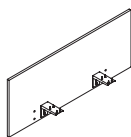

**UNSDEG Desk Edge Screen
– Glass**

Page 548

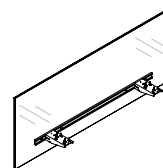

**UNSFDE Desk Edge Screen
– Full-Height**

Page 550

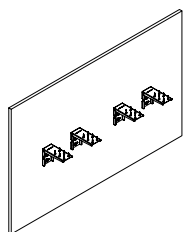

**UNSFDG Desk Edge Screen
– Full-Height Glass**

Page 552

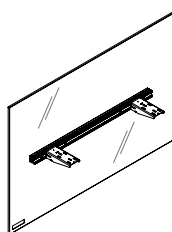

**GXCD Infinity Curved Desk Edge
Screen**

Page 554

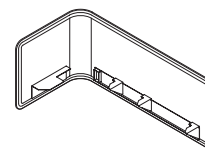

GXDD Infinity Desk Edge Screen

Page 558

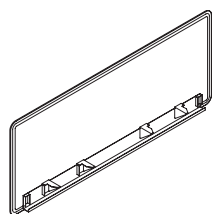

**GQDD Quilted Infinity Desk
Edge Screen**

Page 564

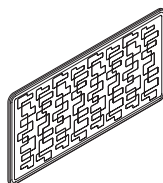

**GXSD Infinity Side Desk Edge
Screen**

Page 568

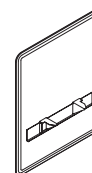

**GXFD Infinity Desk Edge Floor
Screen**

Page 570

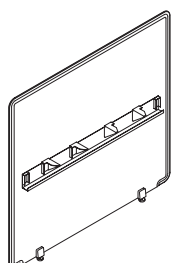

**GXED Infinity Side Desk Edge
Floor Screen**

Page 572

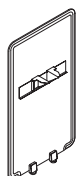

**GXCC Infinity Screen Alignment
Clip**

Page 573



screens product map

GYDD Framed Fabric Desk Edge Screen

Page 574

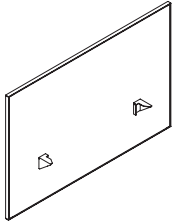

GYSD Framed Fabric Side Desk Edge Screen

Page 578

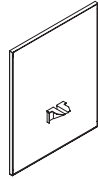

GYFD Framed Fabric Desk Edge Floor Screen

Page 582

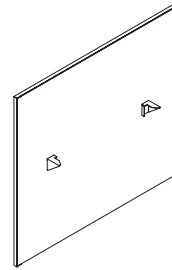

GYED Framed Fabric Side Desk Edge Floor Screen

Page 584

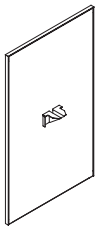

GVG D Desk Edge Screen with Glass

Page 586

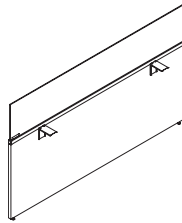

GNGD Glass 6mm Lateral Screen

Page 588

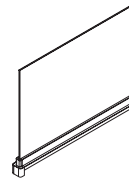

GNTD Glass 10mm Lateral Screen

Page 589

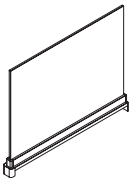

GNWD Writable Glass Lateral Screen

Page 590

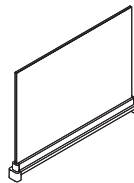

GNSD Solid Lateral Screen

Page 591

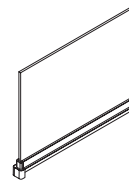

GNLD Writable Laminate Lateral Screen

Page 592



GNXD Infinity Lateral Screen

Page 593

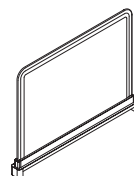

GNZD Smooth Felt Lateral Screen

Page 594

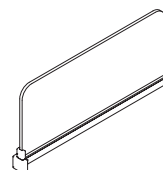

screens product map

GNYD Framed Fabric Lateral Screen

Page 595

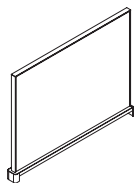

GNMD Metal Lateral Screen

Page 596

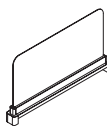

UNSM Modesty Screen

Page 597

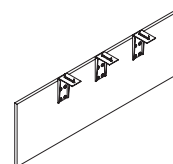

UNSF Floor Screen

Page 598

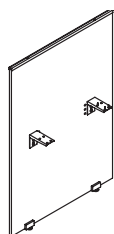

UNSFXL Floor Screen Extended Leveling Kit

Page 600



UNSSS Storage Screen

Page 602

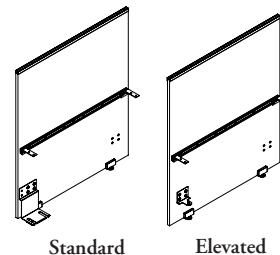

UALSG Solid Lateral Screen with Glass

Page 604

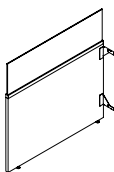

UALSS Solid Lateral Floor Screen

Page 610

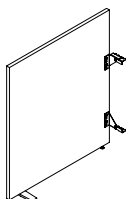

UNLTG End Mount Lateral Screen Solid with Glass

Page 614

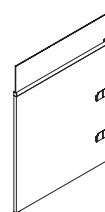

UNLTS End Mount Lateral Screen Solid

Page 618

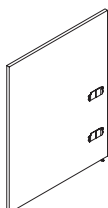

UNSPS Panel Wall Add-On Screen – Solid

Page 620

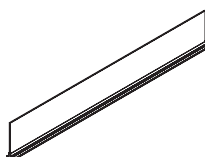

UNSPG Panel Wall 10mm Add-On Screen – Glass

Page 621

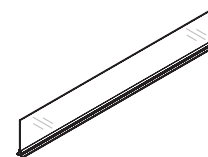

screens product map

**UNSPF Panel Wall Add-On Screen
– 6mm Glass**

Page 622

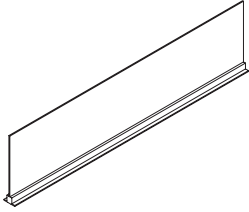

**UYSPG Panel Glass Blade for
Panels with 10mm Inset
Glass**

Page 623

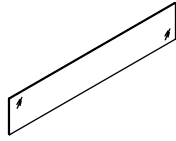

**UYSPF Panel Glass Blade for
Panels with 6mm Inset
Glass**

Page 624

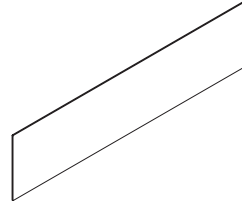

**UYSCG Bridged Glass Blade for
Panels with 10mm Inset
Glass**

Page 625

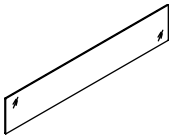

**UYSCF Bridged Glass Blade for
Panels with 6mm Inset
Glass**

Page 626

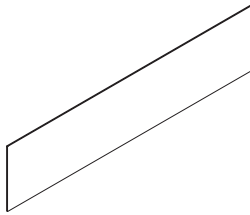

UNSPZ Smooth Felt Add-On

Page 627

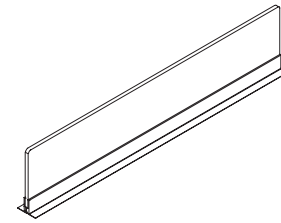

**UYSPZ Smooth Felt Blade for
Panels with Inset**

Page 628

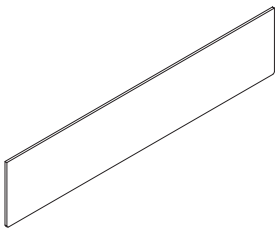

UNSDT
Desk Top Casual Screen

The Desk Top Screen is freestanding, providing space division and territorial desktop privacy.

WHAT'S INCLUDED

1 desk top screen with base support.

NOTES

Edge trim will be finished to match the screen when Flintwood and Natural Veneer finishes have been specified.

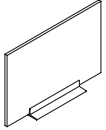

PRODUCT OPTIONS

Height	Width	Screen Finish	Edge Trim Finish (Applies to Fascia Laminate)	Base Finish
13	24	Source Laminate Flintwood (Standard) Natural Veneer	SM Aluminum Acrylic Self Edge	AC Clear Anodized Foundation Mica

SAMPLE ORDER CODE

UNSDT 13	24	FX		AC
-----------------	-----------	-----------	--	-----------

DIMENSIONS
INCHES / MM

H	W
13 / 330	24 / 610

PRICING

Source Laminate	Flintwood	Natural Veneer
174	198	353

The Desk Edge Screen attaches to the worksurface to provide space division and territorial desktop privacy.

WHAT'S INCLUDED

1 desk edge screen, attachment brackets.

NOTES

Edge trim will be finished to match the screen when Flintwood and Natural Veneer finishes have been specified.

Actual width is nominal (specified) width.

UNSD E
Desk Edge Screen

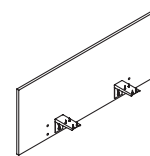

PRODUCT OPTIONS

Height	Width (1" increments)	Screen Finish	Edge Trim Finish (Applies to Fascia Laminate)	Bracket Finish
13 (42" datum height)	23 - 96	Source Laminate Flintwood (Standard) Natural Veneer	SM Aluminum Acrylic Self Edge	Foundation Mica

SAMPLE ORDER CODE

UNSD E 13	24	FX		E
------------------	-----------	-----------	--	----------

**DIMENSIONS
FOR MM X BY 25.4**

PRICING

H	W	Source Laminate	Flintwood	Natural Veneer
13	23 - 24	221	279	288
13	25 - 27	226	285	299
13	28 - 30	231	291	305
13	31 - 33	236	300	312
13	34 - 36	244	305	319
13	37 - 39	249	312	326
13	40 - 42	254	322	332
13	43 - 45	307	385	401
13	46 - 48	359	453	472
13	49 - 51	364	460	480
13	52 - 54	370	468	486
13	55 - 57	377	475	493
13	58 - 60	382	480	501
13	61 - 63	388	485	506
13	64 - 66	392	492	512
13	67 - 69	399	501	521
13	70 - 72	402	505	526
13	73 - 75	408	514	536
13	76 - 78	412	521	542
13	79 - 81	463	587	612
13	82 - 84	517	654	681
13	85 - 87	522	662	691
13	88 - 90	526	668	696
13	91 - 93	532	674	702
13	94 - 96	537	679	706

UNSD E G

Desk Edge Screen – Glass

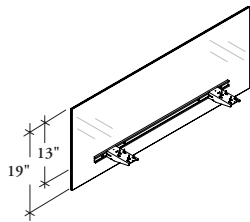

The Desk Edge Screen – Glass attaches to the worksurface to provide space division and territorial desktop privacy.

WHAT’S INCLUDED

1 screen, attachment brackets.

NOTES

This Desk Edge Screen can only be applied to 30" and 36" deep worksurfaces in freestanding applications.

Actual screen height is 19" in total; 6" below the worksurface and 13" above the worksurface.

Standard Glass, Frost is a 10mm etched tempered glass.

PRODUCT OPTIONS

Height	Width (1" increments)	Screen Finish	Bracket Finish
13	23 - 96	FT Frost Standard Glass	Foundation Mica

SAMPLE ORDER CODE

UNSD E G 13	24	FT	Q
-------------	----	----	---

**DIMENSIONS
FOR MM X BY 25.4**

H	W
13	23 - 24
13	25 - 27
13	28 - 30
13	31 - 33
13	34 - 36
13	37 - 39
13	40 - 42
13	43 - 45
13	46 - 48
13	49 - 51
13	52 - 54
13	55 - 57
13	58 - 60
13	61 - 63
13	64 - 66
13	67 - 69
13	70 - 72
13	73 - 75
13	76 - 78
13	79 - 81
13	82 - 84
13	85 - 87
13	88 - 90
13	91 - 93
13	94 - 96

PRICING

503
556
607
659
710
762
812
867
951
1005
1061
1123
1180
1243
1305
1367
1428
1489
1551
1613
1674
1734
1796
1858
1918

UNSFDE

Desk Edge Screen – Full-Height

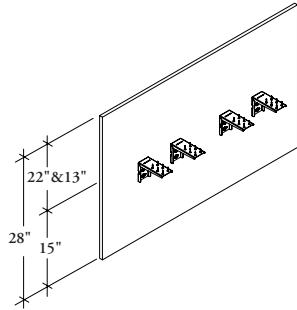

The Desk Edge Screen – Full-Height attaches to the worksurface to provide space division and privacy. Particularly suited for height-adjustable tables.

WHAT'S INCLUDED

1 screen, attachment brackets.

NOTES

Actual screen height are 28" and 37" in total; 15" below the worksurface and 13" and 22" above the worksurface.

Edge trim will be finished to match the screen when Flintwood and Natural Veneer finishes have been specified.

PRODUCT OPTIONS

Height	Width (1" increments)	Screen Finish	Edge Trim Finish	Bracket Finish
13, 22, 28	23 - 96	Source Laminate Flintwood (Standard) Natural Veneer	SM Aluminum Acrylic Self Edge	Foundation Mica

SAMPLE ORDER CODE

UNSFDE 13	48	AV	SM	7
------------------	-----------	-----------	-----------	----------

**DIMENSIONS
FOR MM X BY 25.4**

H	W
13	23 - 24
13	25 - 27
13	28 - 30
13	31 - 33
13	34 - 36
13	37 - 39
13	40 - 42
13	43 - 45
13	46 - 48
13	49 - 51
13	52 - 54
13	55 - 57
13	58 - 60
13	61 - 63
13	64 - 66
13	67 - 69
13	70 - 72
13	73 - 75
13	76 - 78
13	79 - 81
13	82 - 84
13	85 - 87
13	88 - 90
13	91 - 93
13	94 - 96

PRICING

Source Laminate	Flintwood	Natural Veneer
369	684	713
382	723	755
393	763	790
406	803	831
417	842	872
432	877	909
448	911	944
485	974	1007
525	1030	1066
540	1068	1106
559	1107	1144
576	1149	1189
594	1192	1232
612	1235	1275
632	1277	1317
652	1319	1363
671	1364	1407
692	1408	1454
713	1455	1501
759	1528	1577
807	1600	1653
829	1654	1707
854	1704	1759
880	1758	1816
908	1813	1871

Pricing is continued on the following page.

UNSFDE
Desk Edge Screen – Full-Height
(Continued)

DIMENSIONS
FOR MM X BY 25.4
PRICING

H	W	Source Laminate	Flintwood	Natural Veneer
22	23 - 24	443	753	785
22	25 - 27	459	798	829
22	28 - 30	472	840	871
22	31 - 33	486	884	914
22	34 - 36	502	926	959
22	37 - 39	518	963	998
22	40 - 42	536	1000	1039
22	43 - 45	583	1069	1108
22	46 - 48	630	1133	1173
22	49 - 51	649	1175	1216
22	52 - 54	670	1217	1259
22	55 - 57	691	1266	1307
22	58 - 60	713	1310	1353
22	61 - 63	736	1356	1401
22	64 - 66	759	1405	1450
22	67 - 69	782	1452	1498
22	70 - 72	807	1499	1548
22	73 - 75	831	1549	1598
22	76 - 78	855	1602	1652
22	79 - 81	911	1680	1734
22	82 - 84	966	1760	1818
22	85 - 87	994	1819	1876
22	88 - 90	1025	1873	1935
22	91 - 93	1057	1934	1998
22	94 - 96	1088	1995	2059
28	23 - 24	487	828	863
28	25 - 27	506	878	912
28	28 - 30	519	924	959
28	31 - 33	535	972	1006
28	34 - 36	552	1019	1055
28	37 - 39	570	1059	1098
28	40 - 42	589	1100	1143
28	43 - 45	640	1176	1219
28	46 - 48	692	1246	1289
28	49 - 51	713	1293	1337
28	52 - 54	737	1338	1385
28	55 - 57	761	1393	1438
28	58 - 60	785	1441	1488
28	61 - 63	810	1492	1541
28	64 - 66	835	1546	1594
28	67 - 69	860	1597	1648
28	70 - 72	887	1649	1704
28	73 - 75	913	1705	1758
28	76 - 78	940	1761	1817
28	79 - 81	1001	1847	1908
28	82 - 84	1063	1936	1999
28	85 - 87	1094	2000	2065
28	88 - 90	1127	2061	2128
28	91 - 93	1163	2127	2198
28	94 - 96	1196	2194	2265

UNSF DG

Desk Edge Screen – Full-Height Glass

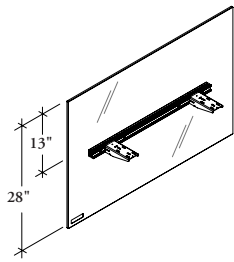

The Desk Edge Screen – Full-Height Glass attaches to the work surface to provide space division and territorial desktop privacy.

WHAT'S INCLUDED

1 screen, attachment brackets.

NOTES

This Desk Edge Screen can only be applied to 30" and 36" wide work surfaces in freestanding applications.

Actual screen height is 28" in total; 15" below the work surface and 13" above the work surface.

Standard Glass, Frost is a 10mm etched tempered glass.

PRODUCT OPTIONS

Height	Width (1" increments)	Screen Finish	Bracket Finish
13, 22, 28	23 - 72	FT Frost Standard Glass	Foundation Mica

SAMPLE ORDER CODE

UNSF DG 13	23	FT	Q
-------------------	-----------	-----------	----------

DIMENSIONS FOR MM X BY 25.4

H	W
22	23
22	24
22	25
22	26
22	27
22	28
22	29
22	30
22	31
22	32
22	33
22	34
22	35
22	36
22	37
22	38
22	39
22	40
22	41
22	42
22	43
22	44
22	45
22	46
22	47

PRICING

654
654
720
720
720
787
787
787
857
857
857
857
922
922
922
991
991
991
1057
1057
1057
1126
1126
1126
1237
1237

DIMENSIONS FOR MM X BY 25.4

H	W
22	48
22	49
22	50
22	51
22	52
22	53
22	54
22	55
22	56
22	57
22	58
22	59
22	60
22	61
22	62
22	63
22	64
22	65
22	66
22	67
22	68
22	69
22	70
22	71
22	72

PRICING

1237
1309
1309
1309
1377
1377
1377
1457
1457
1457
1537
1537
1537
1617
1617
1617
1697
1697
1697
1776
1776
1776
1858
1858
1858

Pricing is continued on the following page.

UNSDG
Desk Edge Screen – Full-Height
Glass (Continued)

DIMENSIONS FOR MM X BY 25.4		PRICING	DIMENSIONS FOR MM X BY 25.4		PRICING
H	W		H	W	
28	23	760	28	23	832
22	24	764	28	24	839
22	25	836	28	25	913
22	26	840	28	26	921
22	27	843	28	27	926
22	28	915	28	28	1001
22	29	919	28	29	1008
22	30	924	28	30	1016
22	31	997	28	31	1091
22	32	1001	28	32	1099
22	33	1006	28	33	1106
22	34	1076	28	34	1179
22	35	1080	28	35	1185
22	36	1084	28	36	1193
22	37	1158	28	37	1269
22	38	1163	28	38	1277
22	39	1166	28	39	1283
22	40	1236	28	40	1355
22	41	1241	28	41	1363
22	42	1244	28	42	1369
22	43	1318	28	43	1446
22	44	1322	28	44	1453
22	45	1327	28	45	1461
22	46	1441	28	46	1578
22	47	1446	28	47	1585
22	48	1451	28	48	1592
22	49	1527	28	49	1671
22	50	1530	28	50	1678
22	51	1534	28	51	1685
22	52	1607	28	52	1760
22	53	1611	28	53	1768
22	54	1615	28	54	1773
22	55	1700	28	55	1862
22	56	1705	28	56	1869
22	57	1708	28	57	1875
22	58	1792	28	58	1962
22	59	1796	28	59	1970
22	60	1801	28	60	1976
22	61	1885	28	61	2064
22	62	1889	28	62	2071
22	63	1894	28	63	2078
22	64	1980	28	64	2166
22	65	1983	28	65	2173
22	66	1987	28	66	2179
22	67	2070	28	67	2266
22	68	2074	28	68	2273
22	69	2077	28	69	2279
22	70	2164	28	70	2368
22	71	2168	28	71	2376
22	72	2172	28	72	2382

G X C D

Infinity Curved Desk Edge Screen

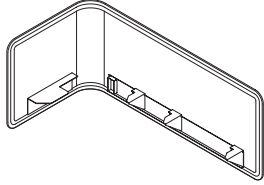

The Infinity Curved Desk Edge Screen attaches to the worksurface on both on the back and lateral edge to provide a lightweight, thin, upholstered fabric screen that is expressed in a softer curvilinear aesthetic that creates space division and local desktop privacy in varying levels.

WHAT'S INCLUDED

1 infinity fabric desk edge screen, attachment brackets, wire manger (if specified).

NOTES

The screen depth is 20" with a 1/2" wire gap around the screen.

Screen is designed to accompany the District Rectangle with Radius Corners Worksurface (UNWC).

Wire manger is designed to be accompanied by the Power Bar (YEPD) or Compact Power Bar (YEPS).

Fabric will be applied in the railroad direction in select Panel and Upholstery fabrics, please refer to the *Teknion Textiles Program Guide*.

PRODUCT OPTIONS

Modesty Base Height		Height	Depth	Width	Orientation	Screen Finish	Hardware Finish
S	Partial Modesty Height (23")	42 for 42" datum height	20	24, 30, 36, 42, 48, 54, 60	NL Left	Panel Fabrics	Foundation
M	Modesty Height (15")	51 for 51" datum height 57 for 57" datum height			NR Right WL Left with Wire Manager WR Right with Wire Manager	Upholstery Fabrics	Mica Accent

SAMPLE ORDER CODE

GXCD S	42	20	54	WL	B204	74
---------------	-----------	-----------	-----------	-----------	-------------	-----------

DIMENSIONS
INCHES / MM

H	W
42 / 1067	24 / 610
42 / 1067	30 / 762
42 / 1067	36 / 914
42 / 1067	42 / 1067
42 / 1067	48 / 1219
42 / 1067	54 / 1372
42 / 1067	60 / 1524
51 / 1295	24 / 610
51 / 1295	30 / 762
51 / 1295	36 / 914
51 / 1295	42 / 1067
51 / 1295	48 / 1219
51 / 1295	54 / 1372
51 / 1295	60 / 1524
57 / 1448	24 / 610
57 / 1448	30 / 762
57 / 1448	36 / 914
57 / 1448	42 / 1067
57 / 1448	48 / 1219
57 / 1448	54 / 1372
57 / 1448	60 / 1524

PRICING

PARTIAL MODESTY HEIGHT (S)																
LEFT/RIGHT (NL/NR)																
PANEL FABRIC							UPHOLSTERY FABRIC									
COM/	Gr. 1	Gr. 2	Gr. 3	Gr. 4	Gr. 5	COM/	Gr. 1	Gr. 2	Gr. 3	Gr. 4	Gr. 5	Gr. 6	Gr. 7	Gr. 8	Gr. 9	Gr. 10
885	895	911	967	1007	1047	888	934	954	982	1025	1050	1075	1127	1179	1202	
937	950	967	1031	1075	1119	941	993	1016	1047	1094	1124	1151	1210	1268	1293	
989	1004	1023	1093	1143	1191	994	1051	1075	1112	1165	1195	1226	1291	1355	1383	
1100	1115	1136	1214	1267	1320	1105	1167	1194	1233	1291	1325	1359	1430	1501	1530	
1146	1163	1187	1269	1328	1386	1151	1219	1249	1291	1353	1390	1428	1505	1582	1615	
1207	1225	1250	1340	1404	1465	1214	1286	1318	1363	1431	1472	1510	1594	1678	1713	
1246	1266	1293	1389	1457	1524	1253	1331	1365	1414	1487	1530	1573	1661	1753	1789	
1215	1235	1262	1359	1428	1496	1221	1301	1335	1385	1457	1502	1544	1634	1723	1762	
1270	1293	1324	1433	1508	1584	1278	1368	1406	1459	1542	1591	1639	1740	1840	1884	
1352	1377	1411	1531	1615	1699	1361	1458	1501	1562	1653	1706	1760	1871	1982	2029	
1668	1695	1733	1864	1957	2047	1678	1784	1831	1897	1997	2055	2114	2237	2357	2410	
1740	1769	1809	1952	2051	2152	1748	1867	1916	1988	2097	2161	2224	2357	2489	2546	
1816	1848	1891	2046	2153	2262	1827	1952	2008	2086	2202	2270	2341	2483	2626	2688	
1885	1919	1964	2133	2246	2364	1895	2032	2090	2174	2299	2372	2446	2600	2754	2820	
1349	1372	1406	1526	1607	1690	1356	1454	1495	1555	1645	1697	1751	1860	1970	2016	
1427	1456	1491	1625	1718	1811	1437	1546	1593	1659	1760	1819	1879	2001	2124	2177	
1515	1547	1586	1735	1836	1939	1527	1645	1696	1770	1882	1948	2014	2150	2287	2343	
1861	1895	1940	2101	2214	2326	1872	2004	2061	2142	2264	2335	2406	2556	2705	2768	
1947	1985	2034	2208	2330	2453	1960	2102	2165	2252	2385	2463	2540	2702	2866	2935	
2066	2106	2160	2348	2481	2614	2078	2233	2301	2396	2540	2625	2711	2887	3061	3137	
2147	2190	2246	2449	2594	2736	2161	2327	2400	2503	2656	2748	2839	3028	3217	3297	

If Accent/Mica Hardware Finish is specified for 24" - 36", add 11
If Accent/Mica Hardware Finish is specified for 42" - 60", add 24

Pricing is continued on the following page.

G X C D

Infinity Curved Desk Edge Screen
(Continued)

DIMENSIONS
INCHES / MM

PRICING

DIMENSIONS		PARTIAL MODESTY HEIGHT (S) (CONTINUED)															
INCHES / MM		LEFT/RIGHT WITH WIRE MANAGER (WL/WR)															
		PANEL FABRIC						UPHOLSTERY FABRIC									
H	W	COM/ Gr. A	Gr. 1	Gr. 2	Gr. 3	Gr. 4	Gr. 5	COM/ Gr. 1	Gr. 2	Gr. 3	Gr. 4	Gr. 5	Gr. 6	Gr. 7	Gr. 8	Gr. 9	Gr. 10
42 / 1067	24 / 610	891	902	917	975	1015	1053	895	940	961	989	1032	1058	1083	1134	1187	1210
42 / 1067	30 / 762	943	957	975	1039	1083	1127	949	1000	1023	1053	1102	1131	1158	1217	1276	1301
42 / 1067	36 / 914	997	1011	1030	1101	1150	1198	1001	1059	1083	1118	1171	1202	1234	1299	1363	1390
42 / 1067	42 / 1067	1107	1123	1144	1220	1275	1327	1112	1174	1201	1240	1299	1331	1367	1437	1507	1538
42 / 1067	48 / 1219	1153	1170	1194	1277	1335	1393	1158	1226	1256	1299	1361	1397	1434	1513	1589	1623
42 / 1067	54 / 1372	1215	1233	1258	1347	1411	1473	1220	1293	1325	1370	1438	1479	1518	1603	1684	1720
42 / 1067	60 / 1524	1254	1274	1301	1396	1464	1531	1260	1339	1372	1421	1495	1538	1581	1669	1759	1797
51 / 1295	24 / 610	1221	1242	1269	1367	1434	1503	1228	1307	1343	1391	1464	1508	1552	1641	1732	1769
51 / 1295	30 / 762	1278	1301	1330	1440	1516	1591	1285	1375	1413	1466	1549	1598	1646	1746	1847	1890
51 / 1295	36 / 914	1359	1385	1418	1539	1623	1706	1368	1465	1507	1568	1659	1713	1767	1879	1988	2037
51 / 1295	42 / 1067	1675	1703	1740	1871	1963	2053	1684	1791	1837	1906	2004	2063	2122	2243	2365	2417
51 / 1295	48 / 1219	1746	1778	1816	1960	2060	2160	1757	1873	1923	1996	2105	2168	2232	2365	2497	2553
51 / 1295	54 / 1372	1823	1856	1898	2052	2161	2268	1834	1960	2015	2092	2211	2278	2347	2489	2633	2695
51 / 1295	60 / 1524	1891	1926	1972	2139	2254	2370	1901	2039	2097	2181	2305	2379	2454	2607	2762	2827
57 / 1448	24 / 610	1355	1381	1413	1532	1615	1696	1364	1461	1502	1562	1653	1706	1758	1867	1977	2024
57 / 1448	30 / 762	1434	1463	1499	1632	1725	1819	1444	1552	1599	1666	1767	1825	1885	2009	2131	2185
57 / 1448	36 / 914	1523	1554	1594	1742	1844	1946	1533	1653	1705	1779	1889	1957	2021	2157	2292	2351
57 / 1448	42 / 1067	1869	1901	1947	2109	2220	2333	1880	2011	2067	2149	2270	2342	2414	2563	2713	2775
57 / 1448	48 / 1219	1958	1994	2042	2218	2340	2462	1969	2112	2174	2263	2394	2472	2549	2713	2875	2944
57 / 1448	54 / 1372	2073	2113	2166	2355	2488	2621	2087	2240	2308	2404	2548	2632	2717	2894	3068	3145
57 / 1448	60 / 1524	2155	2195	2253	2458	2600	2742	2167	2334	2408	2510	2664	2754	2846	3035	3223	3304
		MODESTY HEIGHT (M)															
		LEFT/RIGHT (NL/NR)															
		PANEL FABRIC						UPHOLSTERY FABRIC									
H	W	COM/ Gr. A	Gr. 1	Gr. 2	Gr. 3	Gr. 4	Gr. 5	COM/ Gr. 1	Gr. 2	Gr. 3	Gr. 4	Gr. 5	Gr. 6	Gr. 7	Gr. 8	Gr. 9	Gr. 10
42 / 1067	24 / 610	1095	1115	1143	1240	1306	1373	1102	1180	1215	1263	1336	1379	1422	1513	1603	1640
42 / 1067	30 / 762	1190	1211	1241	1350	1426	1501	1195	1284	1322	1377	1458	1506	1554	1655	1755	1797
42 / 1067	36 / 914	1269	1293	1327	1446	1529	1613	1277	1375	1416	1477	1567	1619	1674	1784	1894	1941
42 / 1067	42 / 1067	1418	1444	1480	1611	1703	1793	1427	1532	1579	1645	1743	1803	1861	1982	2102	2153
42 / 1067	48 / 1219	1488	1517	1557	1699	1798	1897	1497	1613	1662	1735	1843	1907	1970	2101	2233	2289
42 / 1067	54 / 1372	1564	1594	1637	1791	1898	2006	1573	1699	1754	1831	1946	2015	2084	2225	2368	2428
42 / 1067	60 / 1524	1631	1665	1710	1874	1989	2105	1641	1776	1834	1916	2041	2115	2189	2342	2494	2560
51 / 1295	24 / 610	1286	1309	1340	1454	1532	1611	1293	1386	1426	1482	1568	1618	1669	1773	1879	1922
51 / 1295	30 / 762	1357	1385	1419	1546	1634	1722	1367	1470	1515	1579	1674	1731	1786	1905	2021	2071
51 / 1295	36 / 914	1441	1471	1508	1650	1746	1844	1452	1565	1614	1684	1789	1854	1915	2045	2174	2228
51 / 1295	42 / 1067	1769	1801	1844	1997	2103	2211	1780	1905	1959	2036	2151	2219	2288	2429	2571	2631
51 / 1295	48 / 1219	1850	1886	1933	2098	2215	2330	1862	1998	2058	2140	2266	2341	2415	2569	2723	2789
51 / 1295	54 / 1372	1955	1991	2041	2220	2346	2471	1965	2112	2175	2266	2402	2483	2563	2728	2894	2966
51 / 1295	60 / 1524	2029	2068	2123	2315	2451	2585	2041	2199	2267	2365	2510	2596	2682	2862	3040	3116
57 / 1448	24 / 610	1378	1402	1432	1542	1620	1697	1386	1477	1515	1572	1654	1705	1754	1855	1957	1999
57 / 1448	30 / 762	1447	1473	1508	1634	1719	1806	1456	1558	1603	1664	1758	1813	1868	1983	2098	2147
57 / 1448	36 / 914	1534	1563	1603	1738	1834	1930	1546	1656	1704	1772	1875	1937	1998	2124	2249	2303
57 / 1448	42 / 1067	1991	2024	2070	2226	2337	2444	2002	2130	2186	2266	2385	2454	2524	2671	2814	2877
57 / 1448	48 / 1219	2075	2112	2159	2330	2448	2569	2087	2227	2288	2372	2502	2578	2654	2812	2970	3039
57 / 1448	54 / 1372	2246	2288	2341	2532	2665	2799	2262	2417	2485	2581	2725	2811	2896	3072	3250	3326
57 / 1448	60 / 1524	2339	2382	2437	2646	2788	2932	2352	2521	2594	2698	2852	2944	3036	3226	3419	3500

If Accent/Mica Hardware Finish is specified for 24" - 36", add 11
If Accent/Mica Hardware Finish is specified for 42" - 60", add 24

Pricing is continued on the following page.

G X C D

**Infinity Curved Desk Edge Screen
(Continued)**

**DIMENSIONS
INCHES / MM**

PRICING

		MODESTY HEIGHT (M) (CONTINUED)															
		LEFT/RIGHT WITH WIRE MANAGER (WL/WR)															
42 / 1067	24 / 610	1103	1123	1150	1246	1313	1380	1109	1189	1221	1270	1344	1387	1430	1520	1609	1648
42 / 1067	30 / 762	1196	1218	1248	1356	1432	1507	1202	1291	1329	1385	1465	1514	1562	1661	1761	1805
42 / 1067	36 / 914	1277	1301	1334	1454	1537	1619	1284	1382	1423	1483	1574	1628	1681	1791	1900	1949
42 / 1067	42 / 1067	1426	1452	1487	1618	1710	1801	1433	1540	1585	1653	1750	1809	1868	1988	2110	2161
42 / 1067	48 / 1219	1496	1524	1564	1706	1806	1906	1504	1619	1670	1742	1849	1913	1976	2109	2240	2296
42 / 1067	54 / 1372	1570	1603	1645	1798	1907	2013	1581	1706	1760	1837	1955	2022	2090	2233	2375	2435
42 / 1067	60 / 1524	1637	1671	1717	1883	1997	2112	1649	1783	1842	1923	2048	2123	2195	2348	2500	2567
51 / 1295	24 / 610	1293	1317	1347	1461	1540	1618	1301	1393	1432	1489	1576	1627	1677	1781	1886	1931
51 / 1295	30 / 762	1365	1391	1427	1553	1641	1731	1373	1477	1522	1585	1681	1737	1793	1911	2027	2078
51 / 1295	36 / 914	1450	1478	1516	1657	1755	1850	1458	1572	1621	1692	1797	1861	1922	2051	2181	2237
51 / 1295	42 / 1067	1778	1808	1850	2004	2111	2217	1786	1911	1965	2042	2159	2226	2294	2436	2579	2638
51 / 1295	48 / 1219	1861	1895	1941	2109	2224	2341	1871	2008	2066	2150	2276	2350	2423	2579	2733	2799
51 / 1295	54 / 1372	1961	1998	2048	2227	2353	2478	1973	2118	2182	2274	2410	2489	2570	2737	2901	2973
51 / 1295	60 / 1524	2037	2075	2130	2322	2458	2591	2048	2206	2275	2371	2518	2604	2690	2868	3046	3123
57 / 1448	24 / 610	1385	1408	1439	1551	1628	1705	1393	1483	1523	1579	1660	1710	1759	1861	1964	2007
57 / 1448	30 / 762	1455	1481	1515	1640	1728	1812	1463	1565	1609	1669	1764	1820	1874	1989	2103	2152
57 / 1448	36 / 914	1541	1572	1608	1746	1842	1936	1553	1662	1710	1780	1883	1945	2006	2131	2256	2312
57 / 1448	42 / 1067	1998	2032	2075	2233	2343	2451	2010	2137	2192	2274	2391	2461	2532	2676	2822	2884
57 / 1448	48 / 1219	2083	2119	2165	2338	2456	2574	2094	2235	2293	2380	2510	2586	2662	2819	2978	3044
57 / 1448	54 / 1372	2254	2294	2347	2538	2672	2804	2268	2423	2492	2588	2733	2817	2903	3078	3256	3331
57 / 1448	60 / 1524	2345	2390	2446	2652	2795	2940	2359	2529	2600	2705	2859	2951	3043	3233	3424	3505

If Accent/Mica Hardware Finish is specified for 24" - 36", add 11
 If Accent/Mica Hardware Finish is specified for 42" - 60", add 24

G X D D

Infinity Desk Edge Screen

The Infinity Desk Edge Screen attaches to a worksurface to provide a lightweight, thin, upholstered fabric screen that is expressed in a softer curvilinear aesthetic that creates space division and local desktop privacy in varying levels.

WHAT'S INCLUDED

1 infinity fabric desk edge screen, attachment brackets, wire manger (if specified).

NOTES

Infinity screen is 1/2" less than specified size. The worksurface wire gap is 1/2", to allow for mounting of select desk edge accessories.

Wire manger is designed to be accompanied by the Power Bar (YEPD) or Compact Power Bar (YEPS).

Fabric will be applied in the railroad direction in select Panel and Upholstery fabrics, please refer to the *Teknion Textiles Program Guide*.

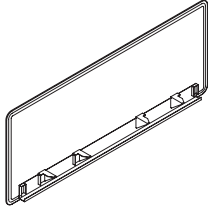

PRODUCT OPTIONS

Modesty Base Height		Height	Width (1" increments)	Wire Manager		Screen Finish	Hardware Finish
S	Partial Modesty Height (23")	42 for 42" datum height	36 - 72	Y	Yes	Panel Fabrics	Foundation Mica Accent
M	Modesty Height (15")	51 for 51" datum height		N	No		
E	Elevated Height (6")	57 for 57" datum height					

SAMPLE ORDER CODE

GXDD S	42	60	Y	B204	74
---------------	-----------	-----------	----------	-------------	-----------

DIMENSIONS CODE / INCHES FOR MM X BY 25.4

H	W
42	36 - 38
42	39 - 41
42	42 - 44
42	45 - 47
42	48 - 50
42	51 - 53
42	54 - 56
42	57 - 59
42	60 - 62
42	63 - 65
42	66 - 68
42	69
42	70 - 72

PRICING

PARTIAL MODESTY HEIGHT (S)																	
WITHOUT WIRE MANAGER (N)																	
PANEL FABRIC								UPHOLSTERY FABRIC									
COM/ Gr. A	Gr. 1	Gr. 2	Gr. 3	Gr. 4	Gr. 5	Gr. 6	Gr. 7	COM/ Gr. 1	Gr. 2	Gr. 3	Gr. 4	Gr. 5	Gr. 6	Gr. 7	Gr. 8	Gr. 9	Gr. 10
738	747	761	808	840	872			741	781	796	820	854	875	896	939	982	1001
771	782	796	846	880	915			775	816	833	858	896	917	940	987	1032	1052
803	813	829	883	918	956			807	849	868	896	936	960	984	1032	1082	1103
838	848	864	921	961	1000			841	887	908	936	979	1004	1029	1081	1133	1156
871	884	899	960	1001	1043			874	923	944	975	1021	1047	1074	1129	1184	1209
898	912	930	993	1038	1082			904	955	977	1008	1057	1086	1113	1171	1230	1255
926	939	959	1025	1070	1117			930	985	1007	1042	1092	1122	1151	1214	1275	1301
977	992	1011	1082	1131	1178			982	1040	1064	1100	1152	1183	1215	1279	1344	1371
1029	1043	1064	1138	1189	1240			1035	1093	1118	1156	1211	1244	1277	1344	1412	1440
1049	1065	1087	1163	1217	1269			1053	1116	1144	1182	1241	1275	1309	1379	1451	1480
1070	1087	1109	1190	1244	1301			1075	1140	1169	1210	1269	1305	1342	1414	1488	1520
1091	1108	1131	1212	1268	1325			1097	1163	1192	1233	1293	1329	1367	1440	1516	1548
1112	1128	1152	1236	1296	1354			1116	1186	1216	1258	1321	1359	1396	1476	1553	1586

If Accent/Mica Hardware Finish is specified for 36" - 43", add 11

If Accent/Mica Hardware Finish is specified for 42" - 72", add 24

Pricing is continued on the following page.

G X D D

Infinity Desk Edge Screen (Continued)

**DIMENSIONS
CODE / INCHES
FOR MM X BY 25.4**

H	W
51	36 - 38
51	39 - 41
51	42 - 44
51	45 - 47
51	48 - 50
51	51 - 53
51	54 - 56
51	57 - 59
51	60 - 62
51	63 - 65
51	66 - 68
51	69
51	70 - 72
57	36 - 38
57	39 - 41
57	42 - 44
57	45 - 47
57	48 - 50
57	51 - 53
57	54 - 56
57	57 - 59
57	60 - 62
57	63 - 65
57	66 - 68
57	69
57	70 - 72

PRICING

PARTIAL MODESTY HEIGHT (S) (CONTINUED)
WITHOUT WIRE MANAGER (N) (CONTINUED)

PANEL FABRIC							UPHOLSTERY FABRIC									
COM/ Gr. A	Gr. 1	Gr. 2	Gr. 3	Gr. 4	Gr. 5	COM/ Gr. 1	Gr. 2	Gr. 3	Gr. 4	Gr. 5	Gr. 6	Gr. 7	Gr. 8	Gr. 9	Gr. 10	
937	954	976	1057	1113	1168	942	1007	1037	1077	1138	1173	1209	1283	1356	1389	
980	998	1022	1108	1168	1227	986	1057	1087	1129	1194	1233	1270	1351	1430	1464	
1023	1042	1067	1159	1223	1287	1029	1105	1136	1183	1252	1293	1334	1418	1503	1540	
1078	1098	1126	1223	1291	1359	1086	1165	1199	1248	1321	1365	1408	1498	1588	1627	
1132	1153	1182	1285	1356	1429	1139	1223	1260	1311	1389	1436	1481	1577	1671	1712	
1169	1192	1221	1331	1407	1482	1176	1266	1304	1357	1440	1489	1538	1637	1738	1782	
1204	1228	1261	1376	1455	1535	1214	1306	1346	1405	1491	1542	1592	1699	1805	1849	
1276	1301	1334	1455	1539	1623	1284	1382	1423	1484	1576	1630	1683	1795	1906	1952	
1346	1372	1407	1534	1621	1709	1354	1457	1502	1565	1660	1717	1773	1889	2006	2055	
1389	1416	1454	1585	1678	1768	1398	1505	1552	1618	1718	1778	1835	1958	2078	2131	
1431	1459	1498	1635	1732	1827	1440	1553	1602	1670	1774	1835	1896	2023	2151	2204	
1463	1492	1530	1670	1767	1864	1473	1586	1635	1705	1810	1872	1935	2064	2193	2248	
1493	1523	1564	1709	1810	1911	1503	1621	1672	1745	1855	1919	1985	2118	2253	2310	
933	948	971	1049	1106	1160	937	1001	1030	1069	1131	1166	1201	1275	1349	1379	
975	992	1016	1102	1160	1220	980	1049	1081	1123	1187	1225	1263	1343	1421	1455	
1017	1036	1061	1152	1216	1278	1023	1097	1128	1175	1243	1284	1325	1408	1493	1529	
1072	1091	1118	1216	1283	1350	1078	1157	1191	1240	1312	1355	1398	1488	1579	1616	
1127	1148	1176	1279	1350	1421	1133	1217	1253	1304	1382	1428	1473	1567	1662	1703	
1161	1183	1214	1322	1397	1473	1168	1256	1295	1350	1431	1479	1527	1628	1726	1769	
1195	1218	1250	1364	1442	1522	1202	1295	1335	1393	1479	1529	1581	1684	1789	1835	
1266	1289	1324	1442	1526	1609	1274	1371	1413	1473	1564	1616	1670	1781	1890	1938	
1335	1361	1395	1521	1608	1695	1343	1445	1489	1552	1646	1703	1759	1873	1989	2040	
1378	1405	1440	1572	1662	1755	1387	1493	1539	1606	1704	1762	1821	1941	2063	2114	
1420	1448	1486	1623	1718	1812	1429	1540	1588	1657	1760	1821	1883	2008	2135	2189	
1451	1479	1517	1656	1754	1848	1459	1572	1621	1691	1796	1857	1919	2047	2175	2231	
1480	1509	1549	1694	1795	1895	1489	1607	1658	1732	1840	1905	1967	2101	2236	2291	

WITH WIRE MANAGER (Y)

PANEL FABRIC							UPHOLSTERY FABRIC									
COM/ Gr. A	Gr. 1	Gr. 2	Gr. 3	Gr. 4	Gr. 5	COM/ Gr. 1	Gr. 2	Gr. 3	Gr. 4	Gr. 5	Gr. 6	Gr. 7	Gr. 8	Gr. 9	Gr. 10	
745	756	767	814	847	879	748	787	803	827	862	884	904	947	989	1008	
780	788	803	853	888	922	782	823	840	865	904	925	948	994	1040	1061	
810	821	836	889	926	963	813	857	875	904	942	966	991	1040	1089	1110	
845	855	871	929	967	1007	848	893	914	942	986	1011	1037	1088	1140	1163	
878	890	908	966	1008	1050	883	931	953	982	1027	1053	1082	1136	1192	1216	
906	918	937	1000	1044	1089	911	962	985	1016	1064	1092	1119	1178	1237	1262	
934	947	965	1032	1078	1125	937	992	1015	1049	1100	1128	1158	1220	1281	1307	
985	999	1018	1089	1138	1186	989	1047	1070	1107	1159	1191	1221	1286	1351	1378	
1037	1050	1070	1145	1195	1246	1041	1101	1126	1163	1218	1252	1284	1351	1419	1448	
1057	1072	1093	1170	1224	1277	1062	1124	1151	1190	1248	1281	1317	1387	1457	1487	
1078	1093	1116	1196	1252	1307	1083	1148	1176	1217	1277	1312	1349	1421	1496	1527	
1098	1115	1138	1219	1276	1331	1105	1170	1199	1240	1301	1336	1373	1448	1523	1556	
1118	1135	1159	1243	1303	1362	1124	1193	1223	1265	1328	1367	1404	1482	1560	1593	

If Accent/Mica Hardware Finish is specified for 36" - 43", add 11
If Accent/Mica Hardware Finish is specified for 42" - 72", add 24

Pricing is continued on the following page.

G X D D

Infinity Desk Edge Screen
(Continued)

DIMENSIONS
CODE / INCHES
FOR MM X BY 25.4

PRICING

PARTIAL MODESTY HEIGHT (S) (CONTINUED)

WITH WIRE MANAGER (Y) (CONTINUED)

PANEL FABRIC		UPHOLSTERY FABRIC															
COM/ Gr. A	Gr. 1	Gr. 2	Gr. 3	Gr. 4	Gr. 5	COM/ Gr. 1	Gr. 2	Gr. 3	Gr. 4	Gr. 5	Gr. 6	Gr. 7	Gr. 8	Gr. 9	Gr. 10		
51	36 - 38	943	961	984	1064	1119	1175	950	1015	1043	1084	1145	1179	1216	1289	1364	1396
51	39 - 41	987	1005	1029	1115	1175	1235	993	1064	1093	1136	1201	1240	1278	1357	1437	1472
51	42 - 44	1030	1049	1074	1167	1230	1295	1037	1112	1144	1191	1259	1301	1342	1426	1509	1547
51	45 - 47	1086	1106	1133	1230	1299	1367	1092	1171	1205	1255	1328	1372	1415	1505	1594	1633
51	48 - 50	1139	1160	1190	1292	1364	1436	1146	1230	1267	1319	1396	1442	1488	1584	1679	1719
51	51 - 53	1176	1199	1228	1339	1414	1489	1183	1274	1311	1365	1448	1497	1544	1645	1745	1788
51	54 - 56	1212	1236	1268	1383	1462	1542	1220	1313	1353	1412	1498	1549	1600	1706	1811	1857
51	57 - 59	1283	1307	1342	1462	1546	1630	1291	1389	1431	1492	1583	1636	1691	1803	1912	1960
51	60 - 62	1353	1379	1414	1541	1629	1716	1362	1464	1508	1572	1668	1723	1781	1896	2013	2063
51	63 - 65	1396	1423	1461	1592	1684	1776	1406	1513	1559	1627	1725	1784	1843	1964	2086	2138
51	66 - 68	1438	1466	1505	1643	1738	1834	1448	1560	1608	1678	1782	1843	1905	2031	2159	2213
51	69	1471	1499	1538	1678	1774	1871	1480	1593	1643	1712	1818	1880	1941	2071	2200	2256
51	70 - 72	1501	1530	1570	1716	1818	1918	1509	1629	1680	1754	1862	1926	1992	2126	2261	2318
57	36 - 38	939	955	977	1057	1113	1168	943	1008	1038	1077	1138	1173	1209	1281	1355	1387
57	39 - 41	982	999	1023	1109	1168	1227	987	1057	1088	1129	1194	1233	1270	1350	1429	1462
57	42 - 44	1024	1042	1067	1159	1223	1285	1030	1105	1135	1182	1250	1291	1331	1415	1501	1537
57	45 - 47	1080	1098	1126	1223	1289	1356	1086	1165	1198	1246	1320	1363	1406	1496	1585	1624
57	48 - 50	1134	1154	1183	1286	1356	1429	1140	1224	1260	1311	1389	1434	1480	1574	1670	1710
57	51 - 53	1169	1191	1220	1329	1405	1480	1175	1263	1302	1356	1438	1486	1534	1634	1734	1778
57	54 - 56	1202	1225	1258	1371	1451	1529	1210	1302	1343	1400	1486	1537	1588	1692	1797	1843
57	57 - 59	1274	1297	1330	1451	1532	1616	1280	1378	1420	1480	1570	1624	1678	1787	1897	1945
57	60 - 62	1343	1368	1402	1528	1615	1703	1350	1453	1497	1559	1654	1710	1766	1881	1997	2047
57	63 - 65	1386	1412	1448	1580	1670	1761	1394	1501	1546	1613	1711	1769	1829	1949	2070	2122
57	66 - 68	1428	1455	1493	1630	1725	1820	1436	1547	1594	1665	1767	1829	1889	2015	2141	2195
57	69	1457	1486	1524	1662	1760	1856	1466	1580	1629	1697	1804	1864	1926	2053	2182	2238
57	70 - 72	1487	1517	1557	1702	1803	1901	1497	1614	1666	1738	1847	1911	1975	2109	2242	2299

MODESTY HEIGHT (M)

WITHOUT WIRE MANAGER (N)

PANEL FABRIC		UPHOLSTERY FABRIC															
COM/ Gr. A	Gr. 1	Gr. 2	Gr. 3	Gr. 4	Gr. 5	COM/ Gr. 1	Gr. 2	Gr. 3	Gr. 4	Gr. 5	Gr. 6	Gr. 7	Gr. 8	Gr. 9	Gr. 10		
42	36 - 38	933	948	971	1049	1106	1160	937	1001	1030	1069	1131	1166	1201	1275	1349	1379
42	39 - 41	975	992	1016	1102	1160	1220	980	1049	1081	1123	1187	1225	1263	1343	1421	1455
42	42 - 44	1017	1036	1061	1152	1216	1278	1023	1097	1128	1175	1243	1284	1325	1408	1493	1529
42	45 - 47	1072	1091	1118	1216	1283	1350	1078	1157	1191	1240	1312	1355	1398	1488	1579	1616
42	48 - 50	1127	1148	1176	1279	1350	1421	1133	1217	1253	1304	1382	1428	1473	1567	1662	1703
42	51 - 53	1161	1183	1214	1322	1397	1473	1168	1256	1295	1350	1431	1479	1527	1628	1726	1769
42	54 - 56	1195	1218	1250	1364	1442	1522	1202	1295	1335	1393	1479	1529	1581	1684	1789	1835
42	57 - 59	1266	1289	1324	1442	1526	1609	1274	1371	1413	1473	1564	1616	1670	1781	1890	1938
42	60 - 62	1335	1361	1395	1521	1608	1695	1343	1445	1489	1552	1646	1703	1759	1873	1989	2040
42	63 - 65	1378	1405	1440	1572	1662	1755	1387	1493	1539	1606	1704	1762	1821	1941	2063	2114
42	66 - 68	1420	1448	1486	1623	1718	1812	1429	1540	1588	1657	1760	1821	1883	2008	2135	2189
42	69	1451	1479	1517	1656	1754	1848	1459	1572	1621	1691	1796	1857	1919	2047	2175	2231
42	70 - 72	1480	1509	1549	1694	1795	1895	1489	1607	1658	1732	1840	1905	1967	2101	2236	2291

If Accent/Mica Hardware Finish is specified for 36" - 43", add 11
If Accent/Mica Hardware Finish is specified for 42" - 72", add 24

Pricing is continued on the following page

G X D D
Infinity Desk Edge Screen
(Continued)

DIMENSIONS
CODE / INCHES
FOR MM X BY 25.4

PRICING

		MODESTY HEIGHT (M) (CONTINUED)															
		WITHOUT WIRE MANAGER (N) (CONTINUED)															
		PANEL FABRIC						UPHOLSTERY FABRIC									
H	W	COM/ Gr. A	Gr. 1	Gr. 2	Gr. 3	Gr. 4	Gr. 5	COM/ Gr. 1	Gr. 2	Gr. 3	Gr. 4	Gr. 5	Gr. 6	Gr. 7	Gr. 8	Gr. 9	Gr. 10
51	36 - 38	1116	1135	1161	1255	1320	1385	1123	1199	1232	1279	1349	1390	1432	1518	1605	1641
51	39 - 41	1163	1183	1211	1311	1380	1451	1169	1252	1286	1336	1412	1456	1502	1593	1685	1725
51	42 - 44	1210	1232	1261	1368	1441	1516	1217	1303	1342	1395	1476	1523	1569	1669	1767	1809
51	45 - 47	1259	1281	1312	1427	1505	1584	1266	1357	1397	1455	1541	1591	1641	1745	1850	1895
51	48 - 50	1306	1330	1364	1483	1567	1652	1313	1412	1454	1515	1605	1658	1712	1822	1934	1981
51	51 - 53	1346	1372	1407	1534	1623	1711	1354	1457	1503	1566	1661	1718	1774	1891	2009	2060
51	54 - 56	1386	1413	1451	1584	1677	1768	1394	1503	1549	1617	1718	1778	1836	1960	2084	2136
51	57 - 59	1553	1582	1619	1761	1858	1956	1563	1677	1725	1796	1900	1964	2026	2156	2286	2341
51	60 - 62	1720	1750	1791	1938	2040	2141	1731	1849	1900	1975	2086	2151	2216	2351	2487	2545
51	63 - 65	1764	1796	1839	1992	2098	2204	1774	1898	1955	2031	2147	2215	2283	2423	2567	2626
51	66 - 68	1809	1842	1886	2046	2157	2268	1819	1949	2006	2087	2207	2278	2350	2497	2646	2707
51	69	1845	1879	1923	2086	2199	2312	1856	1987	2045	2126	2249	2321	2394	2544	2693	2758
51	70 - 72	1880	1914	1961	2130	2248	2366	1890	2027	2088	2173	2300	2375	2451	2607	2763	2829
57	36 - 38	1176	1195	1221	1314	1379	1444	1182	1259	1291	1339	1408	1451	1492	1579	1665	1702
57	39 - 41	1240	1260	1287	1388	1457	1527	1245	1328	1363	1413	1488	1532	1579	1670	1762	1803
57	42 - 44	1302	1324	1353	1459	1534	1608	1309	1395	1433	1487	1567	1615	1661	1761	1859	1900
57	45 - 47	1346	1369	1400	1514	1592	1671	1353	1445	1484	1542	1629	1679	1729	1833	1938	1983
57	48 - 50	1390	1414	1448	1567	1652	1735	1397	1496	1538	1598	1689	1742	1796	1907	2017	2064
57	51 - 53	1440	1466	1502	1629	1717	1806	1450	1552	1597	1660	1757	1812	1869	1986	2103	2153
57	54 - 56	1492	1520	1557	1691	1783	1874	1501	1609	1656	1723	1824	1884	1943	2066	2190	2242
57	57 - 59	1669	1697	1736	1876	1974	2071	1679	1792	1842	1912	2017	2082	2143	2271	2401	2456
57	60 - 62	1846	1875	1916	2064	2166	2267	1856	1975	2026	2101	2212	2277	2342	2477	2613	2671
57	63 - 65	1890	1921	1964	2117	2224	2330	1899	2024	2080	2156	2271	2341	2409	2549	2692	2752
57	66 - 68	1934	1965	2010	2170	2282	2393	1943	2073	2130	2212	2332	2402	2474	2622	2769	2832
57	69	1973	2007	2051	2214	2327	2440	1984	2115	2173	2254	2377	2449	2522	2672	2822	2887
57	70 - 72	2011	2046	2092	2262	2379	2497	2022	2160	2219	2304	2431	2506	2582	2739	2894	2961
		WITH WIRE MANAGER (Y)															
		PANEL FABRIC						UPHOLSTERY FABRIC									
		COM/ Gr. A	Gr. 1	Gr. 2	Gr. 3	Gr. 4	Gr. 5	COM/ Gr. 1	Gr. 2	Gr. 3	Gr. 4	Gr. 5	Gr. 6	Gr. 7	Gr. 8	Gr. 9	Gr. 10
42	36 - 38	939	955	977	1057	1113	1168	943	1008	1038	1077	1138	1173	1209	1281	1355	1387
42	39 - 41	982	999	1023	1109	1168	1227	987	1057	1088	1129	1194	1233	1270	1350	1429	1462
42	42 - 44	1024	1042	1067	1159	1223	1285	1030	1105	1135	1182	1250	1291	1331	1415	1501	1537
42	45 - 47	1080	1098	1126	1223	1289	1356	1086	1165	1198	1246	1320	1363	1406	1496	1585	1624
42	48 - 50	1134	1154	1183	1286	1356	1429	1140	1224	1260	1311	1389	1434	1480	1574	1670	1710
42	51 - 53	1169	1191	1220	1329	1405	1480	1175	1263	1302	1356	1438	1486	1534	1634	1734	1778
42	54 - 56	1202	1225	1258	1371	1451	1529	1210	1302	1343	1400	1486	1537	1588	1692	1797	1843
42	57 - 59	1274	1297	1330	1451	1532	1616	1280	1378	1420	1480	1570	1624	1678	1787	1897	1945
42	60 - 62	1343	1368	1402	1528	1615	1703	1350	1453	1497	1559	1654	1710	1766	1881	1997	2047
42	63 - 65	1386	1412	1448	1580	1670	1761	1394	1501	1546	1613	1711	1769	1829	1949	2070	2122
42	66 - 68	1428	1455	1493	1630	1725	1820	1436	1547	1594	1665	1767	1829	1889	2015	2141	2195
42	69	1457	1486	1524	1662	1760	1856	1466	1580	1629	1697	1804	1864	1926	2053	2182	2238
42	70 - 72	1487	1517	1557	1702	1803	1901	1497	1614	1666	1738	1847	1911	1975	2109	2242	2299

If Accent/Mica Hardware Finish is specified for 36" - 43", add 11
 If Accent/Mica Hardware Finish is specified for 42" - 72", add 24

Pricing is continued on the following page.

G X D D

Infinity Desk Edge Screen
(Continued)

DIMENSIONS
CODE / INCHES
FOR MM X BY 25.4

PRICING

		MODESTY HEIGHT (M) (CONTINUED)															
		WITH WIRE MANAGER (Y) (CONTINUED)															
		PANEL FABRIC					UPHOLSTERY FABRIC										
H	W	COM/ Gr. A	Gr. 1	Gr. 2	Gr. 3	Gr. 4	Gr. 5	COM/ Gr. 1	Gr. 2	Gr. 3	Gr. 4	Gr. 5	Gr. 6	Gr. 7	Gr. 8	Gr. 9	Gr. 10
51	36 - 38	1124	1143	1169	1262	1327	1391	1129	1205	1238	1286	1355	1397	1439	1526	1611	1649
51	39 - 41	1170	1191	1218	1319	1388	1457	1176	1259	1293	1344	1419	1463	1508	1602	1693	1733
51	42 - 44	1217	1238	1268	1375	1450	1523	1224	1310	1349	1402	1482	1530	1577	1677	1774	1816
51	45 - 47	1266	1288	1320	1433	1513	1591	1274	1365	1405	1462	1548	1598	1649	1754	1858	1901
51	48 - 50	1313	1337	1371	1491	1574	1658	1321	1419	1461	1522	1611	1666	1719	1830	1940	1987
51	51 - 53	1353	1379	1414	1541	1630	1718	1362	1464	1509	1573	1669	1725	1782	1898	2016	2066
51	54 - 56	1393	1420	1457	1591	1683	1776	1401	1509	1557	1625	1725	1784	1844	1966	2090	2143
51	57 - 59	1560	1589	1628	1768	1865	1962	1569	1683	1733	1804	1909	1972	2035	2163	2292	2347
51	60 - 62	1728	1758	1798	1945	2047	2149	1737	1857	1909	1983	2092	2159	2223	2358	2495	2551
51	63 - 65	1771	1804	1846	1999	2106	2213	1782	1907	1961	2038	2153	2221	2290	2431	2573	2633
51	66 - 68	1816	1848	1893	2052	2164	2276	1825	1957	2013	2093	2215	2286	2357	2504	2652	2715
51	69	1852	1886	1932	2092	2206	2319	1863	1995	2051	2134	2257	2328	2401	2550	2700	2765
51	70 - 72	1887	1921	1967	2137	2256	2372	1897	2036	2094	2179	2307	2383	2458	2614	2769	2837
57	36 - 38	1183	1202	1228	1322	1387	1452	1190	1266	1299	1346	1415	1457	1499	1585	1671	1709
57	39 - 41	1246	1267	1295	1395	1464	1534	1253	1335	1370	1420	1496	1540	1585	1678	1769	1809
57	42 - 44	1309	1330	1361	1466	1541	1615	1317	1402	1440	1495	1574	1623	1669	1768	1867	1909
57	45 - 47	1353	1376	1407	1521	1600	1679	1361	1453	1492	1549	1635	1685	1736	1840	1945	1989
57	48 - 50	1397	1421	1455	1574	1658	1742	1405	1503	1544	1606	1695	1748	1804	1913	2024	2071
57	51 - 53	1448	1475	1508	1635	1723	1812	1456	1559	1605	1668	1763	1820	1875	1994	2111	2161
57	54 - 56	1499	1527	1564	1697	1789	1883	1507	1616	1662	1732	1832	1890	1950	2073	2197	2249
57	57 - 59	1677	1705	1743	1885	1982	2078	1685	1799	1848	1919	2024	2088	2150	2279	2409	2463
57	60 - 62	1854	1884	1923	2071	2173	2275	1863	1983	2035	2109	2218	2284	2348	2484	2620	2677
57	63 - 65	1897	1930	1972	2125	2232	2338	1908	2032	2087	2163	2279	2347	2416	2557	2699	2759
57	66 - 68	1940	1973	2017	2177	2289	2400	1950	2082	2137	2218	2340	2410	2481	2629	2777	2840
57	69	1981	2014	2060	2220	2334	2446	1991	2123	2179	2262	2385	2456	2529	2678	2828	2893
57	70 - 72	2018	2052	2100	2268	2388	2504	2029	2167	2226	2312	2438	2514	2589	2746	2901	2968
		ELEVATED HEIGHT (E)															
		WITHOUT WIRE MANAGER (N)															
		PANEL FABRIC					UPHOLSTERY FABRIC										
H	W	COM/ Gr. A	Gr. 1	Gr. 2	Gr. 3	Gr. 4	Gr. 5	COM/ Gr. 1	Gr. 2	Gr. 3	Gr. 4	Gr. 5	Gr. 6	Gr. 7	Gr. 8	Gr. 9	Gr. 10
42	36 - 38	1116	1135	1161	1255	1320	1385	1123	1199	1232	1279	1349	1390	1432	1518	1605	1641
42	39 - 41	1165	1184	1212	1312	1382	1452	1170	1253	1287	1337	1413	1457	1503	1594	1687	1726
42	42 - 44	1212	1234	1263	1370	1444	1518	1219	1305	1344	1397	1478	1526	1572	1671	1769	1811
42	45 - 47	1260	1283	1313	1428	1506	1585	1267	1359	1398	1456	1542	1592	1643	1746	1852	1896
42	48 - 50	1306	1330	1364	1483	1567	1652	1313	1412	1454	1515	1605	1658	1712	1822	1934	1981
42	51 - 53	1345	1371	1406	1532	1621	1710	1353	1456	1502	1565	1660	1717	1773	1890	2008	2059
42	54 - 56	1383	1411	1448	1582	1674	1766	1391	1501	1547	1615	1716	1774	1834	1958	2082	2134
42	57 - 59	1552	1581	1618	1760	1857	1955	1562	1675	1723	1795	1899	1963	2025	2155	2284	2340
42	60 - 62	1720	1750	1791	1938	2040	2141	1731	1849	1900	1975	2086	2151	2216	2351	2487	2545
42	63 - 65	1764	1796	1839	1992	2098	2204	1774	1898	1955	2031	2147	2215	2283	2423	2567	2626
42	66 - 68	1809	1842	1886	2046	2157	2268	1819	1949	2006	2087	2207	2278	2350	2497	2646	2707
42	69	1845	1879	1923	2086	2199	2312	1856	1987	2045	2126	2249	2321	2394	2544	2693	2758
42	70 - 72	1880	1914	1961	2130	2248	2366	1890	2027	2088	2173	2300	2375	2451	2607	2763	2829

If Accent/Mica Hardware Finish is specified for 36" - 43", add 11
If Accent/Mica Hardware Finish is specified for 42" - 72", add 24

Pricing is continued on the following page.

G X D D
Infinity Desk Edge Screen
(Continued)

DIMENSIONS
CODE / INCHES
FOR MM X BY 25.4

PRICING

		ELEVATED HEIGHT (E) (CONTINUED)															
		WITHOUT WIRE MANAGER (N) (CONTINUED)															
		PANEL FABRIC						UPHOLSTERY FABRIC									
H	W	COM/ Gr. A	Gr. 1	Gr. 2	Gr. 3	Gr. 4	Gr. 5	COM/ Gr. 1	Gr. 2	Gr. 3	Gr. 4	Gr. 5	Gr. 6	Gr. 7	Gr. 8	Gr. 9	Gr. 10
51	36 - 38	1176	1195	1221	1314	1379	1444	1182	1259	1291	1339	1408	1451	1492	1579	1665	1702
51	39 - 41	1240	1260	1287	1388	1457	1527	1245	1328	1363	1413	1488	1532	1579	1670	1762	1803
51	42 - 44	1302	1324	1353	1459	1534	1608	1309	1395	1433	1487	1567	1615	1661	1761	1859	1900
51	45 - 47	1346	1369	1400	1514	1592	1671	1353	1445	1484	1542	1629	1679	1729	1833	1938	1983
51	48 - 50	1390	1414	1448	1567	1652	1735	1397	1496	1538	1598	1689	1742	1796	1907	2017	2064
51	51 - 53	1440	1466	1502	1629	1717	1806	1450	1552	1597	1660	1757	1812	1869	1986	2103	2153
51	54 - 56	1492	1520	1557	1691	1783	1874	1501	1609	1656	1723	1824	1884	1943	2066	2190	2242
51	57 - 59	1669	1697	1736	1876	1974	2071	1679	1792	1842	1912	2017	2082	2143	2271	2401	2456
51	60 - 62	1846	1875	1916	2064	2166	2267	1856	1975	2026	2101	2212	2277	2342	2477	2613	2671
51	63 - 65	1890	1921	1964	2117	2224	2330	1899	2024	2080	2156	2271	2341	2409	2549	2692	2752
51	66 - 68	1934	1965	2010	2170	2282	2393	1943	2073	2130	2212	2332	2402	2474	2622	2769	2832
51	69	1973	2007	2051	2214	2327	2440	1984	2115	2173	2254	2377	2449	2522	2672	2822	2887
51	70 - 72	2011	2046	2092	2262	2379	2497	2022	2160	2219	2304	2431	2506	2582	2739	2894	2961
		WITH WIRE MANAGER (Y)															
		PANEL FABRIC						UPHOLSTERY FABRIC									
H	W	COM/ Gr. A	Gr. 1	Gr. 2	Gr. 3	Gr. 4	Gr. 5	COM/ Gr. 1	Gr. 2	Gr. 3	Gr. 4	Gr. 5	Gr. 6	Gr. 7	Gr. 8	Gr. 9	Gr. 10
42	36 - 38	1124	1143	1169	1262	1327	1391	1129	1205	1238	1286	1355	1397	1439	1526	1611	1649
42	39 - 41	1171	1192	1219	1320	1389	1458	1177	1260	1295	1345	1420	1464	1509	1603	1694	1734
42	42 - 44	1219	1241	1270	1377	1452	1526	1226	1312	1351	1405	1484	1532	1580	1679	1778	1819
42	45 - 47	1267	1289	1321	1434	1514	1592	1275	1367	1406	1463	1549	1600	1650	1755	1859	1905
42	48 - 50	1313	1337	1371	1491	1574	1658	1321	1419	1461	1522	1611	1666	1719	1830	1940	1987
42	51 - 53	1352	1378	1413	1540	1629	1717	1361	1463	1508	1572	1668	1723	1781	1897	2015	2065
42	54 - 56	1390	1418	1455	1589	1681	1773	1398	1507	1554	1623	1722	1782	1842	1964	2088	2140
42	57 - 59	1559	1588	1627	1767	1864	1961	1568	1682	1732	1803	1908	1971	2033	2162	2291	2346
42	60 - 62	1728	1758	1798	1945	2047	2149	1737	1857	1909	1983	2092	2159	2223	2358	2495	2551
42	63 - 65	1771	1804	1846	1999	2106	2213	1782	1907	1961	2038	2153	2221	2290	2431	2573	2633
42	66 - 68	1816	1848	1893	2052	2164	2276	1825	1957	2013	2093	2215	2286	2357	2504	2652	2715
42	69	1852	1886	1932	2092	2206	2319	1863	1995	2051	2134	2257	2328	2401	2550	2700	2765
42	70 - 72	1887	1921	1967	2137	2256	2372	1897	2036	2094	2179	2307	2383	2458	2614	2769	2837
51	36 - 38	1183	1202	1228	1322	1387	1452	1190	1266	1299	1346	1415	1457	1499	1585	1671	1709
51	39 - 41	1246	1267	1295	1395	1464	1534	1253	1335	1370	1420	1496	1540	1585	1678	1769	1809
51	42 - 44	1309	1330	1361	1466	1541	1615	1317	1402	1440	1495	1574	1623	1669	1768	1867	1909
51	45 - 47	1353	1376	1407	1521	1600	1679	1361	1453	1492	1549	1635	1685	1736	1840	1945	1989
51	48 - 50	1397	1421	1455	1574	1658	1742	1405	1503	1544	1606	1695	1748	1804	1913	2024	2071
51	51 - 53	1448	1475	1508	1635	1723	1812	1456	1559	1605	1668	1763	1820	1875	1994	2111	2161
51	54 - 56	1499	1527	1564	1697	1789	1883	1507	1616	1662	1732	1832	1890	1950	2073	2197	2249
51	57 - 59	1677	1705	1743	1885	1982	2078	1685	1799	1848	1919	2024	2088	2150	2279	2409	2463
51	60 - 62	1854	1884	1923	2071	2173	2275	1863	1983	2035	2109	2218	2284	2348	2484	2620	2677
51	63 - 65	1897	1930	1972	2125	2232	2338	1908	2032	2087	2163	2279	2347	2416	2557	2699	2759
51	66 - 68	1940	1973	2017	2177	2289	2400	1950	2082	2137	2218	2340	2410	2481	2629	2777	2840
51	69	1981	2014	2060	2220	2334	2446	1991	2123	2179	2262	2385	2456	2529	2678	2828	2893
51	70 - 72	2018	2052	2100	2268	2388	2504	2029	2167	2226	2312	2438	2514	2589	2746	2901	2968

If Accent/Mica Hardware Finish is specified for 36" - 43", add 11

If Accent/Mica Hardware Finish is specified for 42" - 72", add 24

G Q D D

Quilted Infinity Desk Edge Screen

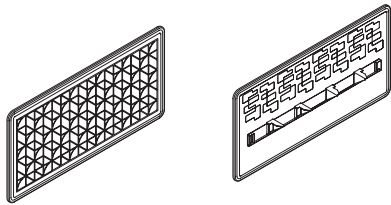

Pico Pattern, Front

Diode Pattern, Back

The Quilted fabrics provide a textured aesthetic, elevating the overall feel of an area creating a tactile user experience. Both the Teknion Quilted patterns Pico and Diode, designed by Suzanne Tick, soften the surface of textiles and elevate the user experience in the workplace with textured, quilted designs that add depth and perspective to a space. The Quilted Infinity Desk Edge Screen attaches to a worksurface to provide a lightweight, thin, upholstered fabric screen that is expressed in a softer curvilinear aesthetic that creates space division and local desktop privacy in varying levels.

WHAT'S INCLUDED

1 quilted infinity fabric desk edge screen, attachment brackets, wire manger (if specified).

NOTES

Infinity screen is 1/2" less than specified size. The worksurface wire gap is 1/2", to allow for mounting of select desk edge accessories.

Wire manger is designed to be accompanied by the Power Bar (YEPD) or Compact Power Bar (YEPS).

Fabric will be applied in the railroad direction in select Panel and Upholstery fabrics, please refer to the *Teknion Textiles Program Guide*. The pattern thread is designed to accompany the color way of the fabric selected.

PRODUCT OPTIONS

Quilted Pattern		Modesty Base Height		Height		Width (6" increments)		Wire Manager		Quilted Screen Finish		Hardware Finish	
D	Diode	S	Partial Modesty Height (23")	42	for 42" datum height	36, 42, 48, 54, 60, 66, 72	Y	Yes	P	Panel Fabrics		Foundation	
	P		Pico		M			Modesty Height (15")		51	for 51" datum height	N	No

SAMPLE ORDER CODE

GQDD P	S	42	60	Y	B204	74
---------------	----------	-----------	-----------	----------	-------------	-----------

DIMENSIONS INCHES / MM

H	D
42 / 1067	36 / 914
42 / 1067	42 / 1067
42 / 1067	48 / 1219
42 / 1067	54 / 1372
42 / 1067	60 / 1524
42 / 1067	66 / 1676
42 / 1067	72 / 1829
51 / 1295	36 / 914
51 / 1295	42 / 1067
51 / 1295	48 / 1219
51 / 1295	54 / 1372
51 / 1295	60 / 1524
51 / 1295	66 / 1676
51 / 1295	72 / 1829

PRICING

PARTIAL MODESTY HEIGHT (S)															
WITHOUT WIRE MANAGER (N)															
PANEL FABRIC						UPHOLSTERY FABRIC									
COM/						COM/									
Gr. A	Gr. 1	Gr. 2	Gr. 3	Gr. 4	Gr. 5	Gr. 1	Gr. 2	Gr. 3	Gr. 4	Gr. 5	Gr. 6	Gr. 7	Gr. 8	Gr. 9	Gr. 10
911	918	933	976	1007	1038	913	949	964	988	1021	1041	1061	1102	1143	1160
994	1004	1018	1069	1106	1141	997	1039	1057	1083	1122	1144	1167	1214	1261	1281
1082	1094	1110	1168	1209	1249	1087	1133	1153	1183	1227	1252	1278	1330	1385	1407
1161	1174	1192	1256	1302	1346	1166	1218	1241	1274	1321	1350	1379	1438	1498	1523
1295	1310	1330	1401	1451	1501	1301	1357	1382	1419	1472	1505	1535	1602	1667	1695
1356	1372	1394	1472	1527	1581	1361	1425	1453	1491	1551	1585	1619	1692	1763	1793
1429	1446	1470	1553	1610	1668	1433	1502	1532	1574	1636	1672	1710	1788	1864	1898
1175	1191	1212	1288	1342	1395	1179	1242	1269	1307	1365	1400	1433	1504	1574	1605
1297	1316	1340	1428	1489	1551	1303	1376	1406	1451	1516	1556	1595	1675	1757	1792
1437	1457	1484	1584	1654	1722	1444	1524	1559	1609	1684	1730	1773	1865	1957	1996
1542	1565	1597	1708	1785	1861	1551	1641	1680	1735	1819	1868	1918	2020	2122	2166
1728	1753	1786	1909	1994	2078	1735	1835	1879	1940	2033	2086	2141	2253	2366	2416
1844	1871	1909	2042	2136	2227	1852	1961	2009	2076	2177	2237	2296	2419	2543	2596
1944	1973	2013	2156	2256	2357	1952	2070	2121	2192	2301	2365	2428	2561	2693	2750

If Accent/Mica Hardware Finish is specified for widths 36" - 42", add 11
 If Accent/Mica Hardware Finish is specified for widths 48" - 72", add 24

Pricing is continued on the following page.

G Q D D
Quilted Infinity Desk Edge Screen
(Continued)

DIMENSIONS
INCHES / MM

PRICING

H		D		PARTIAL MODESTY HEIGHT (S)													
				WITH WIRE MANAGER (Y)													
		PANEL FABRIC					UPHOLSTERY FABRIC										
		COM/					COM/										
		Gr. A	Gr. 1	Gr. 2	Gr. 3	Gr. 4	Gr. 5	Gr. 1	Gr. 2	Gr. 3	Gr. 4	Gr. 5	Gr. 6	Gr. 7	Gr. 8	Gr. 9	Gr. 10
42 / 1067	36 / 914	917	925	939	984	1014	1044	919	956	971	994	1027	1048	1067	1109	1150	1167
42 / 1067	42 / 1067	1001	1011	1025	1076	1113	1148	1004	1045	1064	1090	1128	1151	1174	1220	1268	1288
42 / 1067	48 / 1219	1089	1101	1117	1175	1216	1255	1093	1140	1160	1190	1234	1259	1285	1337	1391	1414
42 / 1067	54 / 1372	1168	1180	1199	1263	1309	1353	1173	1225	1248	1280	1328	1356	1386	1445	1505	1530
42 / 1067	60 / 1524	1302	1317	1337	1407	1457	1507	1307	1364	1389	1426	1479	1512	1542	1608	1674	1703
42 / 1067	66 / 1676	1363	1379	1401	1479	1533	1588	1368	1431	1459	1498	1557	1592	1627	1699	1770	1799
42 / 1067	72 / 1829	1436	1453	1477	1559	1617	1675	1440	1508	1539	1581	1643	1680	1717	1795	1871	1906
51 / 1295	36 / 914	1182	1198	1219	1295	1349	1402	1186	1249	1276	1314	1372	1406	1440	1510	1581	1611
51 / 1295	42 / 1067	1304	1322	1347	1434	1496	1557	1310	1382	1413	1457	1523	1563	1603	1682	1763	1798
51 / 1295	48 / 1219	1444	1464	1491	1591	1660	1730	1451	1531	1566	1616	1691	1736	1781	1872	1963	2002
51 / 1295	54 / 1372	1549	1572	1604	1715	1792	1868	1557	1648	1686	1742	1825	1874	1924	2026	2128	2173
51 / 1295	60 / 1524	1734	1759	1793	1915	2000	2086	1742	1842	1885	1947	2039	2092	2148	2261	2372	2422
51 / 1295	66 / 1676	1850	1879	1915	2049	2142	2235	1859	1967	2015	2084	2185	2243	2303	2426	2549	2603
51 / 1295	72 / 1829	1950	1981	2020	2163	2263	2364	1960	2076	2127	2199	2308	2371	2435	2568	2700	2757
		MODESTY HEIGHT (M)															
		WITHOUT WIRE MANAGER (N)															
		PANEL FABRIC					UPHOLSTERY FABRIC										
		COM/					COM/										
		Gr. A	Gr. 1	Gr. 2	Gr. 3	Gr. 4	Gr. 5	Gr. 1	Gr. 2	Gr. 3	Gr. 4	Gr. 5	Gr. 6	Gr. 7	Gr. 8	Gr. 9	Gr. 10
42 / 1067	36 / 914	1169	1185	1207	1281	1335	1388	1174	1236	1262	1301	1359	1393	1427	1496	1566	1595
42 / 1067	42 / 1067	1292	1310	1334	1422	1481	1542	1297	1368	1400	1444	1509	1549	1586	1667	1748	1783
42 / 1067	48 / 1219	1437	1457	1484	1584	1653	1720	1444	1524	1558	1608	1683	1726	1770	1861	1955	1991
42 / 1067	54 / 1372	1542	1565	1595	1706	1783	1860	1549	1639	1679	1734	1817	1865	1914	2016	2117	2162
42 / 1067	60 / 1524	1726	1753	1785	1908	1992	2075	1735	1834	1875	1938	2029	2084	2138	2249	2363	2410
42 / 1067	66 / 1676	1848	1876	1913	2046	2139	2232	1859	1966	2013	2080	2181	2239	2299	2421	2544	2597
42 / 1067	72 / 1829	1950	1980	2018	2162	2261	2360	1959	2075	2125	2197	2304	2368	2431	2563	2695	2751
51 / 1295	36 / 914	1530	1548	1573	1661	1723	1785	1537	1608	1639	1684	1753	1791	1831	1913	1995	2031
51 / 1295	42 / 1067	1686	1707	1735	1837	1909	1980	1692	1776	1811	1863	1939	1985	2033	2125	2219	2261
51 / 1295	48 / 1219	1847	1871	1905	2020	2100	2179	1856	1949	1990	2048	2136	2188	2239	2345	2452	2497
51 / 1295	54 / 1372	1987	2013	2049	2178	2268	2358	1995	2100	2146	2211	2307	2365	2422	2542	2661	2712
51 / 1295	60 / 1524	2388	2416	2455	2598	2697	2795	2396	2512	2562	2633	2741	2804	2868	2998	3130	3187
51 / 1295	66 / 1676	2536	2569	2612	2767	2876	2984	2547	2673	2727	2807	2923	2993	3063	3206	3350	3410
51 / 1295	72 / 1829	2675	2711	2757	2923	3040	3155	2687	2823	2881	2966	3091	3166	3240	3394	3549	3614

If Accent/Mica Hardware Finish is specified for widths 36" - 42", add 11

If Accent/Mica Hardware Finish is specified for widths 48" - 72", add 24

Pricing is continued on the following page.

G Q D D

**Quilted Infinity Desk Edge Screen
(Continued)**

**DIMENSIONS
INCHES / MM**

H	D
42 / 1067	36 / 914
42 / 1067	42 / 1067
42 / 1067	48 / 1219
42 / 1067	54 / 1372
42 / 1067	60 / 1524
42 / 1067	66 / 1676
42 / 1067	72 / 1829
51 / 1295	36 / 914
51 / 1295	42 / 1067
51 / 1295	48 / 1219
51 / 1295	54 / 1372
51 / 1295	60 / 1524
51 / 1295	66 / 1676
51 / 1295	72 / 1829

PRICING

MODESTY HEIGHT (M)															
WITH WIRE MANAGER (Y)															
PANEL FABRIC							UPHOLSTERY FABRIC								
COM/ Gr. A	Gr. 1	Gr. 2	Gr. 3	Gr. 4	Gr. 5	COM/ Gr. 1	Gr. 2	Gr. 3	Gr. 4	Gr. 5	Gr. 6	Gr. 7	Gr. 8	Gr. 9	Gr. 10
1176	1192	1214	1288	1342	1395	1180	1243	1269	1307	1365	1400	1433	1503	1573	1603
1299	1317	1340	1429	1488	1549	1304	1375	1406	1451	1516	1556	1593	1674	1756	1789
1444	1464	1491	1591	1659	1728	1451	1531	1565	1615	1690	1733	1778	1868	1961	1998
1549	1572	1603	1712	1789	1867	1556	1645	1685	1741	1823	1872	1921	2023	2124	2168
1733	1759	1792	1914	1999	2083	1742	1840	1883	1945	2036	2090	2144	2256	2369	2417
1856	1884	1920	2052	2146	2239	1865	1973	2020	2087	2188	2245	2305	2428	2550	2604
1958	1986	2025	2168	2267	2367	1965	2083	2133	2203	2312	2375	2438	2570	2701	2758
1537	1555	1580	1668	1731	1792	1543	1615	1645	1691	1759	1797	1837	1920	2001	2037
1693	1713	1742	1844	1915	1986	1699	1783	1818	1870	1946	1991	2039	2133	2226	2267
1855	1879	1911	2026	2108	2187	1862	1957	1997	2055	2142	2194	2245	2352	2459	2504
1994	2020	2057	2186	2275	2365	2001	2108	2152	2217	2314	2371	2429	2548	2667	2718
2394	2422	2462	2605	2703	2802	2403	2519	2569	2640	2748	2812	2875	3005	3137	3194
2543	2575	2619	2774	2883	2991	2554	2680	2734	2814	2930	2999	3069	3213	3356	3418
2682	2717	2764	2930	3046	3162	2693	2829	2889	2972	3097	3172	3246	3400	3555	3622

If Accent/Mica Hardware Finish is specified for widths 36" - 42", add 11
 If Accent/Mica Hardware Finish is specified for widths 48" - 72", add 24

G X S D

Infinity Side Desk Edge Screen

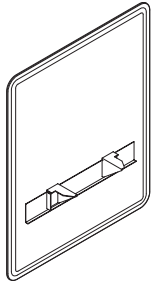

The Infinity Side Desk Edge Screen attaches to a worksurface to provide a lightweight, thin, upholstered fabric screen that is expressed in a softer curvilinear aesthetic that creates space division and lateral desktop privacy in varying levels.

WHAT'S INCLUDED

1 infinity side desk edge screen, attachment brackets.

NOTES

Infinity side screen is 1/2" less than specified size. Screen is designed to have no gap between worksurface and Side Screen.

Fabric will be applied in the railroad direction in select Panel and Upholstery fabrics, please refer to the *Teknion Textiles Program Guide*.

PRODUCT OPTIONS

Modesty Base Height		Height	Depth	Screen Finish	Hardware Finish
S	Partial Modesty Height	42 for 42" datum height	18, 24, 30, 36	Panel Fabrics	Foundation
M	Modesty Height (15")	51 for 51" datum height		Upholstery Fabrics	Mica
E	Elevated Height (6")	57 for 57" datum height			Accent

SAMPLE ORDER CODE

GXSD S	42	24	B204	74
---------------	-----------	-----------	-------------	-----------

DIMENSIONS INCHES / MM

H	D
42 / 1067	18 / 457
42 / 1067	24 / 610
42 / 1067	30 / 762
42 / 1067	36 / 914
51 / 1295	18 / 457
51 / 1295	24 / 610
51 / 1295	30 / 762
51 / 1295	36 / 914
57 / 1448	18 / 457
57 / 1448	24 / 610
57 / 1448	30 / 762
57 / 1448	36 / 914

PRICING

PARTIAL MODESTY HEIGHT															
PANEL FABRIC							UPHOLSTERY FABRIC								
COM/ Gr. A	Gr. 1	Gr. 2	Gr. 3	Gr. 4	Gr. 5	COM/ Gr. 1	Gr. 2	Gr. 3	Gr. 4	Gr. 5	Gr. 6	Gr. 7	Gr. 8	Gr. 9	Gr. 10
552	557	563	588	606	623	554	573	582	594	612	624	634	657	680	689
614	621	631	661	683	705	616	643	654	669	692	706	720	748	778	789
679	686	696	735	761	787	681	712	725	744	773	789	807	841	875	890
739	747	761	806	836	866	741	778	792	816	849	870	889	931	972	989
664	672	684	726	757	785	666	701	715	737	769	787	807	845	885	900
757	766	783	835	873	911	760	803	822	849	890	913	937	987	1037	1058
847	861	878	943	988	1035	852	905	928	960	1008	1039	1067	1127	1187	1212
938	954	975	1051	1105	1158	942	1005	1032	1070	1128	1163	1196	1267	1337	1368
689	699	710	753	785	813	692	729	744	764	797	815	836	874	915	933
797	809	824	879	918	957	802	846	866	893	937	960	985	1036	1088	1110
913	928	947	1018	1067	1115	917	975	1000	1036	1089	1119	1151	1215	1280	1307
933	948	971	1049	1106	1160	937	1001	1030	1069	1131	1166	1201	1275	1349	1379

If Accent/Mica Hardware Finish is specified, add 11

Pricing is continued on the following page.

G X S D
Infinity Side Desk Edge Screen
(Continued)

DIMENSIONS
INCHES / MM

H	D
42 / 1067	18 / 457
42 / 1067	24 / 610
42 / 1067	30 / 762
42 / 1067	36 / 914
51 / 1295	18 / 457
51 / 1295	24 / 610
51 / 1295	30 / 762
51 / 1295	36 / 914
57 / 1448	18 / 457
57 / 1448	24 / 610
57 / 1448	30 / 762
57 / 1448	36 / 914

PRICING

MODESTY HEIGHT															
PANEL FABRIC							UPHOLSTERY FABRIC								
COM/ Gr. A	Gr. 1	Gr. 2	Gr. 3	Gr. 4	Gr. 5	COM/ Gr. 1	Gr. 2	Gr. 3	Gr. 4	Gr. 5	Gr. 6	Gr. 7	Gr. 8	Gr. 9	Gr. 10
662	671	683	725	755	784	665	700	714	736	766	786	804	842	883	898
753	763	780	832	868	906	757	799	818	845	886	910	933	981	1030	1051
843	857	874	939	985	1029	848	900	923	956	1005	1035	1063	1122	1180	1207
933	948	969	1044	1098	1151	937	999	1025	1064	1122	1156	1190	1259	1329	1359
848	858	872	921	955	988	852	891	909	934	971	992	1014	1059	1105	1124
939	951	969	1031	1074	1117	942	993	1016	1047	1093	1122	1149	1205	1263	1288
1029	1044	1066	1141	1194	1246	1035	1095	1123	1160	1218	1252	1285	1354	1423	1454
1117	1135	1160	1249	1311	1372	1124	1195	1226	1271	1339	1378	1418	1501	1582	1617
873	884	898	948	984	1016	878	918	937	961	999	1021	1043	1089	1135	1156
980	993	1012	1075	1119	1164	985	1037	1061	1091	1140	1168	1196	1254	1314	1340
1094	1112	1134	1216	1272	1329	1101	1166	1195	1237	1297	1334	1370	1445	1520	1551
1199	1218	1244	1337	1403	1467	1207	1281	1313	1361	1432	1473	1515	1603	1687	1725

ELEVATED MODESTY HEIGHT															
PANEL FABRIC							UPHOLSTERY FABRIC								
COM/ Gr. A	Gr. 1	Gr. 2	Gr. 3	Gr. 4	Gr. 5	COM/ Gr. 1	Gr. 2	Gr. 3	Gr. 4	Gr. 5	Gr. 6	Gr. 7	Gr. 8	Gr. 9	Gr. 10
853	863	877	926	960	993	857	896	913	938	975	997	1018	1064	1109	1128
942	955	973	1036	1078	1122	947	997	1019	1050	1097	1125	1152	1210	1267	1292
1031	1047	1068	1144	1196	1249	1037	1098	1125	1163	1220	1254	1287	1356	1427	1456
1117	1135	1160	1249	1311	1372	1124	1195	1226	1271	1339	1378	1418	1501	1582	1617
874	885	898	948	981	1015	878	917	935	960	997	1018	1040	1086	1131	1150
979	991	1008	1070	1114	1157	982	1032	1056	1087	1133	1160	1189	1245	1303	1328
1082	1097	1118	1194	1246	1300	1087	1149	1175	1214	1270	1304	1337	1407	1477	1506
1177	1195	1220	1309	1371	1432	1183	1255	1286	1331	1398	1438	1478	1560	1641	1678

If Accent/Mica Hardware Finish is specified, add 11

G X F D

Infinity Desk Edge Floor Screen

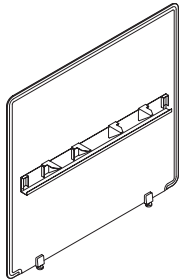

The Infinity Desk Edge Floor Screen attaches to a worksurface to provide a lightweight, thin, upholstered fabric screen that is expressed in a softer curvilinear aesthetic that creates space division and local desktop privacy down to the floor level.

WHAT'S INCLUDED

1 infinity desk edge floor screen, attachment brackets, wire manger (if specified).

NOTES

Infinity Floor screen is 1/2" less than specified size. The worksurface wire gap is 1/2", to allow for mounting of select desk edge accessories.

Wire manger is designed to be accompanied by the Power Bar (YEPD) or Compact Power Bar (YEPS).

The screen is available in select Panel and Upholstery fabrics, please refer to the *Teknion Textiles Program Guide*.

PRODUCT OPTIONS

Modesty Base Height	Height	Width (1" increments)	Screen Finish	Hardware Finish
F Floor Height (1")	42 for 42" datum height 51 for 51" datum height	36 - 72	Panel Fabrics Upholstery Fabrics	Foundation Mica Accent

SAMPLE ORDER CODE

GXFD F	42	60	B204	74
---------------	-----------	-----------	-------------	-----------

DIMENSIONS CODE / INCHES FOR MM X BY 25.4

H	W
42	36 - 38
42	39 - 41
42	42 - 44
42	45 - 47
42	48 - 50
42	51 - 53
42	54 - 56
42	57 - 59
42	60 - 62
42	63 - 65
42	66 - 68
42	69
42	70 - 72

PRICING

PANEL FABRIC

COM/ Gr. A	Gr. 1	Gr. 2	Gr. 3	Gr. 4	Gr. 5
1286	1305	1331	1426	1489	1554
1336	1356	1385	1484	1554	1624
1387	1408	1438	1544	1618	1693
1436	1458	1489	1604	1682	1761
1484	1508	1542	1661	1745	1830
1527	1553	1588	1715	1804	1891
1569	1597	1634	1768	1861	1952
1766	1795	1833	1974	2071	2168
1961	1991	2032	2178	2280	2383
2009	2040	2084	2237	2343	2449
2055	2088	2133	2292	2403	2516
2092	2126	2172	2333	2446	2560
2130	2164	2212	2379	2498	2615

UPHOLSTERY FABRIC

COM/ Gr. 1	Gr. 2	Gr. 3	Gr. 4	Gr. 5	Gr. 6	Gr. 7	Gr. 8	Gr. 9	Gr. 10
1292	1369	1401	1450	1518	1560	1603	1689	1774	1811
1343	1426	1459	1509	1585	1630	1675	1767	1859	1898
1394	1480	1518	1572	1653	1700	1746	1846	1944	1986
1442	1535	1574	1632	1718	1768	1819	1922	2027	2072
1492	1590	1632	1693	1783	1836	1890	2000	2112	2159
1535	1637	1683	1746	1843	1898	1956	2072	2190	2240
1579	1687	1734	1803	1901	1961	2021	2144	2267	2320
1776	1889	1938	2009	2114	2177	2240	2369	2498	2553
1971	2090	2141	2216	2326	2392	2456	2591	2727	2786
2018	2143	2198	2275	2391	2459	2527	2669	2811	2870
2065	2195	2252	2333	2454	2524	2596	2743	2892	2954
2103	2236	2292	2373	2497	2569	2641	2791	2941	3005
2140	2278	2338	2422	2549	2625	2700	2857	3013	3080

If Accent/Mica Hardware Finish is specified for 36" - 43", add 11
If Accent/Mica Hardware Finish is specified for 44" - 72", add 24

Pricing is continued on the following page.

G X F D
Infinity Desk Edge Floor Screen
(Continued)

DIMENSIONS
CODE / INCHES
FOR MM X BY 25.4

H	W
51	36 - 38
51	39 - 41
51	42 - 44
51	45 - 47
51	48 - 50
51	51 - 53
51	54 - 56
51	57 - 59
51	60 - 62
51	63 - 65
51	66 - 68
51	69
51	70 - 72

PRICING

PANEL FABRIC

COM/ Gr. A	Gr. 1	Gr. 2	Gr. 3	Gr. 4	Gr.5
1354	1373	1400	1493	1558	1623
1419	1439	1466	1567	1636	1706
1483	1505	1535	1641	1716	1789
1530	1553	1584	1697	1778	1856
1576	1600	1633	1754	1836	1920
1630	1656	1691	1818	1907	1995
1684	1712	1748	1884	1975	2067
1890	1919	1958	2098	2195	2292
2096	2126	2167	2314	2416	2518
2141	2173	2216	2369	2475	2582
2188	2219	2264	2423	2536	2647
2231	2264	2309	2471	2585	2697
2274	2308	2354	2523	2641	2759

UPHOLSTERY FABRIC

COM/ Gr. 1	Gr. 2	Gr. 3	Gr. 4	Gr. 5	Gr. 6	Gr. 7	Gr. 8	Gr. 9	Gr. 10
1361	1437	1470	1517	1586	1629	1670	1757	1843	1880
1426	1507	1542	1592	1668	1712	1758	1849	1941	1982
1491	1577	1615	1669	1748	1797	1844	1943	2041	2084
1538	1630	1669	1726	1812	1863	1913	2017	2123	2167
1583	1681	1722	1784	1873	1929	1982	2091	2202	2249
1637	1741	1786	1849	1945	2001	2059	2175	2292	2343
1693	1803	1848	1916	2017	2075	2136	2259	2383	2435
1899	2014	2063	2134	2239	2302	2365	2494	2623	2677
2106	2225	2277	2351	2461	2527	2591	2726	2864	2920
2151	2276	2330	2408	2523	2591	2660	2801	2943	3003
2197	2327	2384	2465	2586	2656	2727	2875	3023	3086
2241	2372	2430	2511	2635	2706	2779	2929	3079	3143
2284	2421	2481	2567	2693	2768	2844	3001	3156	3223

If Accent/Mica Hardware Finish is specified for 36" - 43", add 11
 If Accent/Mica Hardware Finish is specified for 44" - 72", add 24

G X E D

Infinity Side Desk Edge Floor Screen

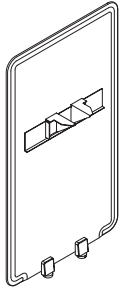

The Infinity Side Desk Edge Floor Screen attaches to a worksurface to provide a lightweight, thin, upholstered fabric screen that is expressed in a softer curvilinear aesthetic that creates space division and lateral desktop privacy down to the floor level.

WHAT'S INCLUDED

1 infinity fabric side desk edge floor screen, attachment brackets.

NOTES

Infinity side floor screen is 1/2" less than specified size. Screen is designed to have no gap between worksurface and Side Screen.

Fabric will be applied in the railroad direction in select Panel and Upholstery fabrics, please refer to the *Teknion Textiles Program Guide*.

PRODUCT OPTIONS

Modesty Base Height	Height	Depth	Screen Finish	Hardware Finish
F Floor Height (1")	42 for 42" datum height 51 for 51" datum height	24, 30, 36	Panel Fabrics Upholstery Fabrics	Foundation Mica Accent

SAMPLE ORDER CODE

GXED F	42	24	B204	74
---------------	-----------	-----------	-------------	-----------

DIMENSIONS INCHES / MM

H	D
42 / 1067	24 / 610
42 / 1067	30 / 762
42 / 1067	36 / 914
51 / 1295	24 / 610
51 / 1295	30 / 762
51 / 1295	36 / 914

PRICING

PANEL FABRIC

COM/ Gr. A	Gr. 1	Gr. 2	Gr. 3	Gr. 4	Gr. 5
1101	1113	1131	1193	1236	1279
1195	1211	1233	1307	1361	1413
1287	1305	1330	1419	1481	1542
1148	1159	1177	1240	1283	1326
1255	1270	1292	1368	1420	1473
1355	1373	1398	1487	1549	1610

UPHOLSTERY FABRIC

COM/ Gr. 1	Gr. 2	Gr. 3	Gr. 4	Gr. 5	Gr. 6	Gr. 7	Gr. 8	Gr. 9	Gr. 10
1105	1154	1177	1209	1255	1283	1310	1368	1426	1451
1200	1262	1288	1327	1385	1418	1452	1521	1590	1619
1293	1365	1396	1441	1508	1548	1588	1670	1753	1787
1151	1201	1224	1255	1302	1329	1356	1414	1472	1497
1260	1322	1349	1387	1444	1478	1510	1581	1650	1680
1362	1433	1464	1509	1577	1616	1656	1738	1820	1856

If Accent/Mica Hardware Finish is specified, add 11

The Infinity Screen Alignment Clip can be placed to align two Infinity screens.

WHAT'S INCLUDED

1 alignment clip.

G X C C
Infinity Screen Alignment Clip



PRODUCT OPTIONS

Finish
Foundation
Mica
Accent

SAMPLE ORDER CODE

GXCC 74

PRICING

Foundation	Mica/Accent
35	41

GYDD

Framed Fabric Desk Edge Screen

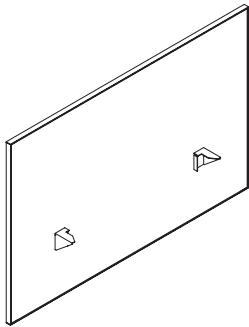

The Framed Fabric Desk Edge Screen attaches to the worksurface on to provide an upholstered fabric screen that is outlined by frame that creates space division and local desktop privacy in at various heights both above and below the worksurface.

WHAT'S INCLUDED

1 fabric desk edge screen, attachment brackets.

NOTES

Framed screens match the width of the worksurface for tight fit applications. Recommended to have 1/2" wire gap between screen and worksurface.

Fabric will be applied in the railroad direction in select Panel and Upholstery fabrics, please refer to the *Teknion Textiles Program Guide*.

PRODUCT OPTIONS

Modesty Base Height		Height	Width (1" increments)	Screen Finish	Hardware Finish
S	Partial Modesty Height (23")	42 for 42" datum height	36 - 72	Panel Fabrics	Foundation
M	Modesty Height (15")	51 for 51" datum height		Upholstery Fabrics	Mica
E	Elevated Height (6")	57 for 57" datum height			Accent

SAMPLE ORDER CODE

GYDD S	42	60	B204	74
---------------	-----------	-----------	-------------	-----------

DIMENSIONS CODE / INCHES FOR MM X BY 25.4

H	W
42	36 - 38
42	39 - 41
42	42 - 44
42	45 - 47
42	48 - 50
42	51 - 53
42	54 - 56
42	57 - 59
42	60 - 62
42	63 - 65
42	66 - 68
42	69
42	70 - 72

PRICING

PARTIAL MODESTY HEIGHT (S)

PANEL FABRIC

COM/ Gr. A	Gr. 1	Gr. 2	Gr. 3	Gr. 4	Gr. 5
660	670	683	731	762	795
701	711	725	776	810	845
739	750	765	818	855	892
752	762	778	835	874	914
761	773	789	849	891	934
816	829	847	911	955	999
872	886	905	972	1017	1064
879	893	913	984	1032	1081
887	900	921	996	1045	1097
917	934	955	1031	1086	1138
950	965	988	1068	1124	1179
959	975	998	1080	1135	1192
966	984	1007	1091	1151	1210

UPHOLSTERY FABRIC

COM/ Gr. 1	Gr. 2	Gr. 3	Gr. 4	Gr. 5	Gr. 6	Gr. 7	Gr. 8	Gr. 9	Gr. 10
664	702	717	741	777	798	818	862	905	923
704	745	762	787	826	847	870	916	962	982
742	786	806	833	872	896	919	969	1018	1040
756	801	821	849	892	917	942	994	1047	1069
764	813	835	865	911	937	964	1019	1074	1098
821	872	895	926	974	1002	1030	1089	1148	1173
875	931	954	988	1039	1067	1097	1159	1220	1246
885	941	965	1001	1053	1086	1116	1180	1245	1274
891	951	976	1014	1068	1102	1134	1201	1269	1299
922	985	1013	1050	1109	1143	1177	1248	1319	1349
955	1019	1048	1089	1149	1184	1220	1293	1368	1398
964	1030	1059	1100	1160	1196	1234	1307	1383	1415
972	1041	1070	1113	1176	1215	1252	1330	1408	1441

If Accent/Mica Hardware Finish is specified for 36" - 43", add 11

If Accent/Mica Hardware Finish is specified for 44" - 72", add 24

Pricing is continued on the following page.

GYDD

Framed Fabric Desk Edge Screen (Continued)

**DIMENSIONS
CODE / INCHES
FOR MM X BY 25.4**

PRICING

		PARTIAL MODESTY HEIGHT (S) (CONTINUED)															
		PANEL FABRIC					UPHOLSTERY FABRIC										
H	W	COM/ Gr. A	Gr. 1	Gr. 2	Gr. 3	Gr. 4	Gr. 5	COM/ Gr. 1	Gr. 2	Gr. 3	Gr. 4	Gr. 5	Gr. 6	Gr. 7	Gr. 8	Gr. 9	Gr. 10
51	36 - 38	816	833	855	936	992	1047	822	887	915	956	1017	1051	1088	1161	1236	1268
51	39 - 41	880	898	922	1008	1068	1128	887	957	987	1030	1094	1133	1171	1252	1330	1365
51	42 - 44	943	963	988	1081	1144	1209	950	1025	1058	1105	1173	1215	1255	1339	1423	1461
51	45 - 47	962	982	1010	1107	1175	1243	969	1048	1083	1132	1204	1249	1292	1382	1472	1509
51	48 - 50	979	1000	1029	1132	1203	1276	986	1069	1107	1158	1236	1283	1328	1423	1518	1559
51	51 - 53	1037	1059	1089	1199	1275	1350	1043	1133	1171	1225	1307	1356	1405	1505	1606	1649
51	54 - 56	1093	1117	1150	1265	1344	1423	1102	1195	1235	1293	1379	1431	1481	1588	1693	1738
51	57 - 59	1108	1133	1167	1287	1371	1455	1116	1215	1256	1318	1408	1462	1516	1628	1737	1785
51	60 - 62	1122	1148	1182	1309	1396	1483	1129	1233	1277	1340	1436	1492	1548	1665	1781	1831
51	63 - 65	1167	1194	1232	1363	1455	1546	1176	1283	1329	1396	1496	1554	1613	1735	1856	1909
51	66 - 68	1211	1240	1278	1415	1510	1607	1220	1332	1380	1451	1554	1615	1677	1804	1932	1985
51	69	1226	1255	1293	1433	1530	1628	1236	1350	1398	1467	1573	1635	1697	1827	1957	2011
51	70 - 72	1240	1269	1310	1455	1557	1657	1249	1368	1419	1492	1602	1666	1732	1865	1999	2058
57	36 - 38	817	833	855	935	991	1045	822	887	915	955	1016	1050	1087	1159	1234	1265
57	39 - 41	883	898	922	1008	1067	1127	887	956	987	1029	1093	1132	1170	1249	1328	1362
57	42 - 44	944	963	988	1081	1144	1205	951	1025	1057	1103	1171	1212	1253	1336	1421	1457
57	45 - 47	963	982	1010	1107	1174	1241	969	1048	1082	1131	1203	1246	1289	1379	1470	1507
57	48 - 50	980	1000	1029	1132	1202	1275	986	1069	1106	1157	1235	1280	1326	1420	1516	1556
57	51 - 53	1038	1059	1089	1198	1274	1349	1043	1132	1170	1225	1306	1354	1402	1503	1603	1645
57	54 - 56	1094	1117	1150	1263	1343	1421	1102	1194	1235	1292	1378	1429	1480	1584	1690	1735
57	57 - 59	1109	1133	1167	1286	1369	1453	1116	1215	1256	1317	1407	1459	1514	1624	1734	1782
57	60 - 62	1123	1148	1182	1307	1395	1482	1129	1233	1277	1339	1433	1489	1546	1660	1778	1827
57	63 - 65	1168	1194	1230	1362	1453	1543	1176	1283	1328	1395	1493	1552	1610	1732	1852	1905
57	66 - 68	1212	1240	1278	1414	1509	1605	1220	1331	1379	1450	1552	1613	1674	1799	1926	1981
57	69	1226	1255	1293	1432	1529	1625	1236	1349	1397	1466	1572	1633	1695	1823	1951	2007
57	70 - 72	1240	1269	1309	1454	1554	1655	1249	1367	1418	1491	1600	1662	1728	1861	1995	2050
		MODESTY HEIGHT (M)															
		PANEL FABRIC					UPHOLSTERY FABRIC										
H	W	COM/ Gr. A	Gr. 1	Gr. 2	Gr. 3	Gr. 4	Gr. 5	COM/ Gr. 1	Gr. 2	Gr. 3	Gr. 4	Gr. 5	Gr. 6	Gr. 7	Gr. 8	Gr. 9	Gr. 10
42	36 - 38	817	833	855	935	991	1045	822	887	915	955	1016	1050	1087	1159	1234	1265
42	39 - 41	883	898	922	1008	1067	1127	887	956	987	1029	1093	1132	1170	1249	1328	1362
42	42 - 44	944	963	988	1081	1144	1205	951	1025	1057	1103	1171	1212	1253	1336	1421	1457
42	45 - 47	963	982	1010	1107	1174	1241	969	1048	1082	1131	1203	1246	1289	1379	1470	1507
42	48 - 50	980	1000	1029	1132	1202	1275	986	1069	1106	1157	1235	1280	1326	1420	1516	1556
42	51 - 53	1038	1059	1089	1198	1274	1349	1043	1132	1170	1225	1306	1354	1402	1503	1603	1645
42	54 - 56	1094	1117	1150	1263	1343	1421	1102	1194	1235	1292	1378	1429	1480	1584	1690	1735
42	57 - 59	1109	1133	1167	1286	1369	1453	1116	1215	1256	1317	1407	1459	1514	1624	1734	1782
42	60 - 62	1123	1148	1182	1307	1395	1482	1129	1233	1277	1339	1433	1489	1546	1660	1778	1827
42	63 - 65	1168	1194	1230	1362	1453	1543	1176	1283	1328	1395	1493	1552	1610	1732	1852	1905
42	66 - 68	1212	1240	1278	1414	1509	1605	1220	1331	1379	1450	1552	1613	1674	1799	1926	1981
42	69	1226	1255	1293	1432	1529	1625	1236	1349	1397	1466	1572	1633	1695	1823	1951	2007
42	70 - 72	1240	1269	1309	1454	1554	1655	1249	1367	1418	1491	1600	1662	1728	1861	1995	2050

If Accent/Mica Hardware Finish is specified for 36" - 43", add 11
 If Accent/Mica Hardware Finish is specified for 44" - 72", add 24

Pricing is continued on the following page

GYDD

**Framed Fabric Desk Edge Screen
(Continued)**

**DIMENSIONS
CODE / INCHES
FOR MM X BY 25.4**

PRICING

		MODESTY HEIGHT (M) (CONTINUED)															
		PANEL FABRIC					UPHOLSTERY FABRIC										
H	W	COM/ Gr. A	Gr. 1	Gr. 2	Gr. 3	Gr. 4	Gr. 5	COM/ Gr. 1	Gr. 2	Gr. 3	Gr. 4	Gr. 5	Gr. 6	Gr. 7	Gr. 8	Gr. 9	Gr. 10
51	36 - 38	909	928	954	1047	1112	1176	914	991	1023	1070	1140	1182	1224	1310	1396	1433
51	39 - 41	972	992	1019	1119	1190	1259	977	1061	1094	1145	1220	1265	1310	1402	1495	1534
51	42 - 44	1035	1056	1086	1192	1266	1340	1041	1127	1166	1219	1300	1347	1394	1493	1591	1633
51	45 - 47	1051	1074	1106	1219	1299	1377	1059	1151	1191	1248	1334	1385	1434	1539	1644	1689
51	48 - 50	1068	1092	1126	1245	1329	1413	1075	1174	1216	1277	1367	1420	1475	1584	1695	1742
51	51 - 53	1145	1171	1205	1332	1421	1509	1153	1256	1302	1365	1461	1517	1573	1691	1808	1858
51	54 - 56	1221	1249	1286	1420	1513	1605	1230	1339	1386	1454	1554	1613	1672	1796	1919	1972
51	57 - 59	1235	1263	1302	1442	1540	1636	1244	1357	1407	1478	1583	1646	1709	1837	1966	2022
51	60 - 62	1248	1278	1319	1465	1567	1669	1258	1377	1429	1503	1613	1679	1743	1879	2015	2072
51	63 - 65	1302	1332	1376	1529	1635	1742	1311	1436	1491	1567	1683	1753	1820	1961	2103	2163
51	66 - 68	1355	1388	1432	1592	1704	1814	1365	1496	1552	1633	1755	1824	1896	2043	2192	2254
51	69	1370	1404	1450	1610	1723	1836	1380	1513	1569	1652	1774	1846	1919	2068	2218	2283
51	70 - 72	1383	1418	1464	1633	1753	1869	1394	1531	1591	1677	1804	1879	1955	2111	2266	2333
57	36 - 38	1006	1025	1051	1145	1210	1275	1013	1089	1122	1169	1238	1280	1322	1408	1495	1531
57	39 - 41	1089	1109	1136	1237	1306	1376	1094	1177	1212	1262	1337	1382	1428	1520	1611	1652
57	42 - 44	1170	1192	1221	1328	1402	1477	1177	1263	1302	1355	1436	1483	1530	1630	1728	1769
57	45 - 47	1189	1211	1242	1355	1434	1514	1195	1287	1327	1385	1471	1521	1570	1675	1781	1824
57	48 - 50	1205	1230	1263	1383	1466	1551	1214	1311	1353	1414	1504	1558	1611	1721	1833	1880
57	51 - 53	1283	1309	1344	1471	1559	1648	1291	1394	1439	1503	1598	1655	1711	1829	1945	1996
57	54 - 56	1361	1388	1426	1559	1652	1743	1369	1478	1524	1592	1693	1753	1811	1935	2059	2111
57	57 - 59	1373	1402	1440	1582	1679	1776	1383	1497	1546	1616	1721	1785	1847	1976	2106	2161
57	60 - 62	1387	1416	1457	1605	1706	1808	1396	1516	1567	1641	1753	1818	1883	2017	2153	2212
57	63 - 65	1451	1481	1524	1678	1784	1890	1459	1584	1639	1716	1832	1899	1967	2110	2252	2312
57	66 - 68	1513	1544	1589	1748	1861	1972	1522	1653	1709	1789	1911	1982	2052	2200	2348	2411
57	69	1527	1560	1606	1767	1881	1994	1538	1669	1726	1808	1932	2002	2075	2225	2375	2440
57	70 - 72	1540	1574	1621	1789	1909	2025	1551	1689	1747	1833	1960	2036	2111	2267	2422	2489
		ELEVATED HEIGHT (E)															
		PANEL FABRIC					UPHOLSTERY FABRIC										
H	W	COM/ Gr. A	Gr. 1	Gr. 2	Gr. 3	Gr. 4	Gr. 5	COM/ Gr. 1	Gr. 2	Gr. 3	Gr. 4	Gr. 5	Gr. 6	Gr. 7	Gr. 8	Gr. 9	Gr. 10
42	36 - 38	912	931	957	1050	1115	1179	917	994	1026	1074	1144	1186	1227	1313	1400	1437
42	39 - 41	975	996	1023	1124	1193	1262	981	1064	1098	1149	1224	1268	1313	1406	1498	1538
42	42 - 44	1038	1059	1089	1195	1269	1344	1044	1131	1169	1223	1303	1351	1397	1497	1594	1636
42	45 - 47	1056	1078	1109	1223	1302	1380	1063	1154	1194	1252	1337	1388	1438	1542	1648	1692
42	48 - 50	1072	1095	1129	1249	1332	1416	1080	1177	1219	1280	1370	1423	1478	1588	1699	1745
42	51 - 53	1149	1175	1210	1336	1426	1514	1157	1260	1305	1369	1464	1521	1577	1694	1811	1862
42	54 - 56	1226	1254	1291	1426	1517	1609	1235	1344	1390	1458	1559	1617	1678	1801	1923	1976
42	57 - 59	1240	1268	1306	1448	1544	1641	1249	1363	1412	1482	1588	1652	1713	1843	1972	2026
42	60 - 62	1252	1281	1322	1470	1570	1672	1261	1380	1432	1506	1616	1682	1746	1883	2018	2075
42	63 - 65	1305	1336	1379	1532	1639	1745	1314	1439	1495	1570	1687	1756	1823	1964	2108	2167
42	66 - 68	1359	1391	1436	1595	1707	1819	1369	1499	1556	1636	1758	1829	1899	2047	2195	2258
42	69	1373	1407	1453	1614	1728	1840	1385	1516	1573	1655	1779	1849	1922	2072	2221	2287
42	70 - 72	1387	1421	1467	1636	1756	1872	1397	1535	1594	1680	1807	1883	1958	2114	2269	2337

If Accent/Mica Hardware Finish is specified for 36" - 43", add 11
If Accent/Mica Hardware Finish is specified for 44" - 72", add 24

Pricing is continued on the following page.

GYDD
Framed Fabric Desk Edge Screen
(Continued)

DIMENSIONS
CODE / INCHES
FOR MM X BY 25.4

H	W
51	36 - 38
51	39 - 41
51	42 - 44
51	45 - 47
51	48 - 50
51	51 - 53
51	54 - 56
51	57 - 59
51	60 - 62
51	63 - 65
51	66 - 68
51	69
51	70 - 72

PRICING

ELEVATED HEIGHT (E) (CONTINUED)																	
PANEL FABRIC							UPHOLSTERY FABRIC										
COM/							COM/										
Gr. A	Gr. 1	Gr. 2	Gr. 3	Gr. 4	Gr. 5		Gr. 1	Gr. 2	Gr. 3	Gr. 4	Gr. 5	Gr. 6	Gr. 7	Gr. 8	Gr. 9	Gr. 10	
1006	1025	1051	1145	1210	1275		1013	1089	1122	1169	1238	1280	1322	1408	1495	1531	
1089	1109	1136	1237	1306	1376		1094	1177	1212	1262	1337	1382	1428	1520	1611	1652	
1170	1192	1221	1328	1402	1477		1177	1263	1302	1355	1436	1483	1530	1630	1728	1769	
1189	1211	1242	1355	1434	1514		1195	1287	1327	1385	1471	1521	1570	1675	1781	1824	
1205	1230	1263	1383	1466	1551		1214	1311	1353	1414	1504	1558	1611	1721	1833	1880	
1283	1309	1344	1471	1559	1648		1291	1394	1439	1503	1598	1655	1711	1829	1945	1996	
1361	1388	1426	1559	1652	1743		1369	1478	1524	1592	1693	1753	1811	1935	2059	2111	
1373	1402	1440	1582	1679	1776		1383	1497	1546	1616	1721	1785	1847	1976	2106	2161	
1387	1416	1457	1605	1706	1808		1396	1516	1567	1641	1753	1818	1883	2017	2153	2212	
1451	1481	1524	1678	1784	1890		1459	1584	1639	1716	1832	1899	1967	2110	2252	2312	
1513	1544	1589	1748	1861	1972		1522	1653	1709	1789	1911	1982	2052	2200	2348	2411	
1527	1560	1606	1767	1881	1994		1538	1669	1726	1808	1932	2002	2075	2225	2375	2440	
1540	1574	1621	1789	1909	2025		1551	1689	1747	1833	1960	2036	2111	2267	2422	2489	

If Accent/Mica Hardware Finish is specified for 36" - 43", add 11

If Accent/Mica Hardware Finish is specified for 44" - 72", add 24

GYSD

Framed Fabric Side Desk Edge Screen

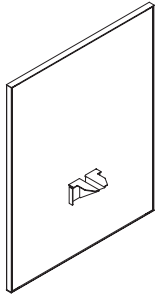

The Framed Fabric Side Desk Edge Screen attaches to the worksurface on to provide an upholstered fabric screen that is outlined by frame that creates space division and local desktop privacy in at various heights both above and below the worksurface.

WHAT'S INCLUDED

1 framed fabric side desk edge screen, attachment brackets, corner connection hardware (if specified).

NOTES

Framed screens match the width of the worksurface for tight fit applications.

Fabric will be applied in the railroad direction in select Panel and Upholstery fabrics, please refer to the *Teknion Textiles Program Guide*.

PRODUCT OPTIONS

Modesty Base Height		Height	Depth	Corner Connection	Screen Finish	Hardware Finish
S	Partial Modesty Height (23")	42 for 42" datum height	18, 24, 30, 36	N No	Panel Fabrics Upholstery Fabrics	Foundation
M	Modesty Height (15")	51 for 51" datum height		R Right		Mica
E	Elevated Height (6")	57 for 57" datum height		L Left		Accent

SAMPLE ORDER CODE

GYSD S	42	24	N	B204	74
---------------	-----------	-----------	----------	-------------	-----------

**DIMENSIONS
INCHES / MM**

H	D
42 / 1067	18 / 203
42 / 1067	24 / 610
42 / 1067	30 / 762
42 / 1067	36 / 914
51 / 1295	18 / 203
51 / 1295	24 / 610
51 / 1295	30 / 762
51 / 1295	36 / 914
57 / 1448	18 / 203
57 / 1448	24 / 610
57 / 1448	30 / 762
57 / 1448	36 / 914

PRICING

PARTIAL MODESTY HEIGHT (S)																
NO CORNER CONNECTION (N)																
PANEL FABRIC							UPHOLSTERY FABRIC									
COM/ Gr. A	Gr. 1	Gr. 2	Gr. 3	Gr. 4	Gr. 5		COM/ Gr. 1	Gr. 2	Gr. 3	Gr. 4	Gr. 5	Gr. 6	Gr. 7	Gr. 8	Gr. 9	Gr. 10
514	519	527	552	568	585		517	536	544	558	576	586	596	619	643	653
565	572	582	612	634	656		568	593	605	619	644	657	671	700	729	740
616	625	635	674	700	726		619	652	664	683	712	729	745	781	814	829
661	670	683	727	759	788		664	700	715	738	771	791	811	853	893	912
593	603	613	656	686	714		595	631	645	666	699	716	736	775	813	831
683	694	710	762	801	838		687	731	748	777	817	840	864	914	963	985
773	786	804	870	914	960		778	831	853	886	935	964	993	1052	1113	1138
817	833	854	931	984	1038		822	885	912	950	1007	1042	1075	1146	1217	1246
581	588	602	643	671	701		583	616	632	654	684	704	721	760	799	816
683	694	710	762	799	836		687	731	748	776	816	840	863	912	961	982
773	786	804	868	914	959		778	831	853	886	935	963	992	1050	1110	1136
817	833	854	930	984	1037		822	885	911	949	1006	1041	1074	1144	1215	1244

If Accent/Mica Hardware Finish is specified, add 11

Pricing is continued on the following page.

G Y S D
Framed Fabric Side Desk Edge
Screen (Continued)

DIMENSIONS
INCHES / MM

H	D
42 / 1067	18 / 203
42 / 1067	24 / 610
42 / 1067	30 / 762
42 / 1067	36 / 914
51 / 1295	18 / 203
51 / 1295	24 / 610
51 / 1295	30 / 762
51 / 1295	36 / 914
57 / 1448	18 / 203
57 / 1448	24 / 610
57 / 1448	30 / 762
57 / 1448	36 / 914

PRICING

PARTIAL MODESTY HEIGHT (S) (CONTINUED)															
RIGHT/LEFT CORNER CONNECTION (R/L)							UPHOLSTERY FABRIC								
PANEL FABRIC							PANEL FABRIC								
COM/ Gr. A	Gr. 1	Gr. 2	Gr. 3	Gr. 4	Gr. 5	COM/ Gr. 1	Gr. 2	Gr. 3	Gr. 4	Gr. 5	Gr. 6	Gr. 7	Gr. 8	Gr. 9	Gr. 10
525	529	536	561	579	594	527	545	554	567	585	595	607	630	653	661
576	582	590	623	644	665	579	604	613	630	654	666	681	710	738	750
628	634	645	683	710	736	630	660	674	692	721	738	756	789	824	839
671	680	692	737	767	798	674	710	725	747	782	802	821	863	904	921
607	614	628	669	699	727	609	644	658	680	712	731	748	787	827	843
696	708	722	776	813	850	700	742	762	789	831	853	877	928	976	998
786	799	817	884	928	973	790	843	866	898	948	977	1006	1066	1126	1151
831	846	867	943	997	1050	835	897	925	963	1021	1056	1089	1159	1230	1260
593	603	613	656	684	714	595	631	645	666	697	716	735	773	812	829
696	708	722	776	812	849	700	742	762	788	829	853	875	925	974	996
786	799	817	883	928	972	790	843	866	898	948	976	1005	1064	1124	1150
831	846	867	942	997	1049	835	897	923	962	1019	1053	1088	1157	1227	1258

MODESTY HEIGHT (M)															
NO CORNER CONNECTION (N)							UPHOLSTERY FABRIC								
PANEL FABRIC							PANEL FABRIC								
COM/ Gr. A	Gr. 1	Gr. 2	Gr. 3	Gr. 4	Gr. 5	COM/ Gr. 1	Gr. 2	Gr. 3	Gr. 4	Gr. 5	Gr. 6	Gr. 7	Gr. 8	Gr. 9	Gr. 10
581	588	602	643	671	701	583	616	632	654	684	704	721	760	799	816
683	694	710	762	799	836	687	731	748	776	816	840	863	912	961	982
773	786	804	868	914	959	778	831	853	886	935	963	992	1050	1110	1136
817	833	854	930	984	1037	822	885	911	949	1006	1041	1074	1144	1215	1244
708	716	732	781	813	847	711	750	766	791	829	850	872	917	963	982
760	771	789	852	895	938	763	813	836	867	914	941	969	1026	1084	1109
811	827	848	923	976	1029	816	878	905	942	1000	1035	1067	1136	1205	1236
910	928	953	1041	1103	1165	915	987	1018	1064	1131	1170	1210	1292	1373	1410
764	775	788	838	871	905	767	808	824	849	887	909	930	975	1021	1040
840	852	870	933	975	1018	843	893	916	948	994	1022	1049	1107	1165	1190
914	930	951	1026	1080	1132	918	981	1007	1045	1103	1136	1170	1240	1309	1339
1007	1025	1050	1139	1201	1262	1014	1086	1116	1161	1228	1268	1307	1390	1472	1507

RIGHT/LEFT CORNER CONNECTION (R/L)															
PANEL FABRIC							UPHOLSTERY FABRIC								
COM/ Gr. A	Gr. 1	Gr. 2	Gr. 3	Gr. 4	Gr. 5	COM/ Gr. 1	Gr. 2	Gr. 3	Gr. 4	Gr. 5	Gr. 6	Gr. 7	Gr. 8	Gr. 9	Gr. 10
593	603	613	656	684	714	595	631	645	666	697	716	735	773	812	829
696	708	722	776	812	849	700	742	762	788	829	853	875	925	974	996
786	799	817	883	928	972	790	843	866	898	948	976	1005	1064	1124	1150
831	846	867	942	997	1049	835	897	923	962	1019	1053	1088	1157	1227	1258
721	732	745	795	828	862	725	764	782	807	843	865	887	933	977	997
775	786	804	866	910	953	778	828	850	883	929	956	984	1041	1098	1124
826	841	863	938	991	1043	831	892	918	957	1015	1048	1082	1151	1220	1250
923	941	966	1056	1117	1178	930	1001	1032	1078	1145	1184	1224	1306	1388	1423
782	790	806	854	888	921	785	824	841	866	904	925	947	992	1038	1057
857	868	887	949	992	1036	861	911	934	964	1011	1039	1066	1124	1180	1205
930	944	966	1042	1094	1148	935	997	1023	1062	1118	1152	1186	1255	1325	1354
1024	1042	1067	1156	1218	1279	1030	1102	1133	1178	1245	1285	1325	1407	1488	1524

If Accent/Mica Hardware Finish is specified, add 11

Pricing is continued on the following page.

G Y S D

**Framed Fabric Side Desk Edge
Screen (Continued)**

**DIMENSIONS
INCHES / MM**

H	D
42 / 1067	18 / 203
42 / 1067	24 / 610
42 / 1067	30 / 762
42 / 1067	36 / 914
51 / 1295	18 / 203
51 / 1295	24 / 610
51 / 1295	30 / 762
51 / 1295	36 / 914

PRICING

ELEVATED HEIGHT (E)															
NO CORNER CONNECTION (N)															
PANEL FABRIC							UPHOLSTERY FABRIC								
COM/ Gr. A	Gr. 1	Gr. 2	Gr. 3	Gr. 4	Gr. 5	COM/ Gr. 1	Gr. 2	Gr. 3	Gr. 4	Gr. 5	Gr. 6	Gr. 7	Gr. 8	Gr. 9	Gr. 10
711	720	735	784	817	850	714	755	770	796	833	854	875	921	966	986
763	776	792	855	898	941	766	817	840	871	917	944	973	1030	1088	1113
814	831	852	928	980	1032	820	883	909	947	1004	1038	1070	1140	1210	1240
913	931	956	1044	1107	1168	918	991	1022	1067	1134	1174	1214	1296	1377	1413
764	775	788	838	871	905	767	808	824	849	887	909	930	975	1021	1040
840	852	870	933	975	1018	843	893	916	948	994	1022	1049	1107	1165	1190
914	930	951	1026	1080	1132	918	981	1007	1045	1103	1136	1170	1240	1309	1339
1007	1025	1050	1139	1201	1262	1014	1086	1116	1161	1228	1268	1307	1390	1472	1507
RIGHT/LEFT CORNER CONNECTION (R/L)															
PANEL FABRIC							UPHOLSTERY FABRIC								
COM/ Gr. A	Gr. 1	Gr. 2	Gr. 3	Gr. 4	Gr. 5	COM/ Gr. 1	Gr. 2	Gr. 3	Gr. 4	Gr. 5	Gr. 6	Gr. 7	Gr. 8	Gr. 9	Gr. 10
725	735	748	798	832	865	729	767	785	810	847	868	890	936	981	1000
778	789	808	870	913	956	782	832	854	886	933	960	987	1044	1102	1127
829	845	866	941	994	1047	834	896	922	961	1018	1051	1086	1154	1224	1254
928	944	971	1059	1122	1182	934	1005	1037	1082	1149	1189	1227	1310	1391	1428
782	790	806	854	888	921	785	824	841	866	904	925	947	992	1038	1057
857	868	887	949	992	1036	861	911	934	964	1011	1039	1066	1124	1180	1205
930	944	966	1042	1094	1148	935	997	1023	1062	1118	1152	1186	1255	1325	1354
1024	1042	1067	1156	1218	1279	1030	1102	1133	1178	1245	1285	1325	1407	1488	1524

If Accent/Mica Hardware Finish is specified, add 11

GYFD

Framed Fabric Desk Edge Floor Screen

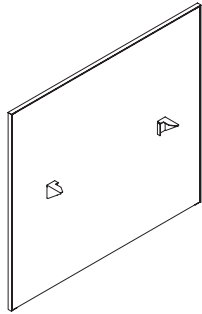

The Framed Fabric Desk Edge Floor Screen attaches to the worksurface on to provide an upholstered fabric screen that is outlined by frame that creates space division and local desktop privacy in at various heights both above and below the worksurface to the floor level.

WHAT'S INCLUDED

1 framed fabric desk edge floor screen, attachment brackets.

NOTES

Framed floor screens match the width of the worksurface for tight fit applications. Recommended to have 1/2" wire gap between screen and worksurface.

Fabric will be applied in the railroad direction in select Panel and Upholstery fabrics, please refer to the *Teknion Textiles Program Guide*.

PRODUCT OPTIONS

Modesty Base Height	Height	Width (1" increments)	Screen Finish	Hardware Finish
F Floor Height (1")	42 for 42" datum height 51 for 51" datum height	36 - 72	Panel Fabrics Upholstery Fabrics	Foundation Mica Accent

SAMPLE ORDER CODE

GYFD F	42	60	B204	74
---------------	-----------	-----------	-------------	-----------

**DIMENSIONS
CODE / INCHES
FOR MM X BY 25.4**

H	W
42	36 - 38
42	39 - 41
42	42 - 44
42	45 - 47
42	48 - 50
42	51 - 53
42	54 - 56
42	57 - 59
42	60 - 62
42	63 - 65
42	66 - 68
42	69
42	70 - 72

PRICING

PANEL FABRIC

COM/ Gr. A	Gr. 1	Gr. 2	Gr. 3	Gr. 4	Gr. 5
996	1015	1041	1134	1199	1263
1080	1100	1127	1227	1297	1367
1161	1183	1214	1320	1394	1467
1179	1202	1234	1347	1427	1505
1198	1221	1255	1375	1458	1542
1275	1301	1335	1462	1551	1639
1352	1379	1416	1551	1643	1735
1365	1394	1432	1573	1670	1767
1378	1408	1450	1595	1697	1799
1441	1473	1516	1669	1776	1883
1504	1537	1581	1741	1852	1963
1518	1552	1597	1759	1872	1985
1531	1566	1613	1782	1899	2017

UPHOLSTERY FABRIC

COM/ Gr. 1	Gr. 2	Gr. 3	Gr. 4	Gr. 5	Gr. 6	Gr. 7	Gr. 8	Gr. 9	Gr. 10
1001	1078	1110	1158	1227	1269	1311	1397	1483	1521
1086	1168	1202	1253	1328	1372	1418	1509	1603	1641
1169	1255	1293	1347	1428	1476	1522	1621	1719	1761
1187	1279	1319	1376	1462	1513	1563	1667	1771	1816
1204	1303	1345	1406	1496	1549	1604	1713	1824	1871
1283	1386	1431	1495	1590	1646	1703	1820	1937	1987
1361	1470	1516	1584	1684	1743	1804	1926	2049	2102
1375	1488	1538	1608	1713	1778	1839	1967	2097	2152
1388	1507	1559	1633	1743	1809	1873	2009	2146	2202
1452	1576	1631	1707	1823	1891	1960	2101	2243	2303
1514	1644	1700	1782	1901	1973	2045	2192	2341	2402
1529	1660	1718	1799	1922	1995	2067	2217	2367	2431
1542	1680	1740	1824	1951	2026	2102	2259	2415	2481

If Accent/Mica Hardware Finish is specified for 36" - 43", add 11
If Accent/Mica Hardware Finish is specified for 44" - 72", add 24

Pricing is continued on the following page.

GYFD
Framed Fabric Desk Edge Floor
Screen (Continued)

DIMENSIONS
CODE / INCHES
FOR MM X BY 25.4

PRICING

		PANEL FABRIC						UPHOLSTERY FABRIC									
		COM/ Gr. A	Gr. 1	Gr. 2	Gr. 3	Gr. 4	Gr.5	COM/ Gr. 1	Gr. 2	Gr. 3	Gr. 4	Gr. 5	Gr. 6	Gr. 7	Gr. 8	Gr. 9	Gr. 10
H	W	1023	1042	1068	1161	1226	1291	1029	1106	1138	1186	1255	1297	1339	1426	1510	1548
51	36 - 38	1106	1126	1153	1254	1324	1393	1112	1194	1228	1279	1354	1398	1444	1537	1629	1668
51	39 - 41	1187	1209	1238	1345	1419	1493	1194	1280	1319	1372	1453	1501	1547	1646	1744	1786
51	42 - 44	1204	1227	1259	1372	1452	1530	1212	1304	1344	1401	1487	1538	1588	1692	1797	1842
51	45 - 47	1223	1246	1280	1400	1483	1567	1230	1328	1370	1431	1521	1574	1629	1738	1849	1896
51	48 - 50	1300	1326	1361	1487	1576	1665	1307	1411	1456	1520	1615	1671	1728	1845	1962	2013
51	51 - 53	1377	1405	1441	1576	1668	1760	1386	1495	1541	1609	1710	1768	1829	1951	2074	2127
51	54 - 56	1390	1419	1457	1598	1695	1792	1400	1514	1563	1633	1738	1803	1864	1994	2123	2177
51	57 - 59	1404	1433	1475	1621	1722	1824	1413	1532	1584	1658	1768	1834	1898	2035	2170	2227
51	60 - 62	1466	1498	1541	1694	1801	1908	1477	1602	1656	1733	1848	1916	1985	2126	2268	2328
51	63 - 65	1529	1562	1606	1766	1876	1988	1539	1669	1725	1807	1929	1998	2070	2217	2366	2428
51	66 - 68	1543	1577	1623	1784	1897	2010	1554	1685	1743	1824	1948	2020	2092	2242	2392	2456
51	69	1557	1591	1637	1807	1924	2042	1567	1705	1764	1849	1976	2051	2127	2284	2440	2506
51	70 - 72																

If Accent/Mica Hardware Finish is specified for 36" - 43", add 11
If Accent/Mica Hardware Finish is specified for 44" - 72", add 24

GYED

Framed Fabric Side Desk Edge Floor Screen

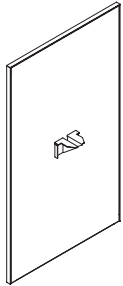

The Framed Fabric Side Desk Edge Floor Screen attaches to the worksurface to provide an upholstered fabric screen that is outlined by frame that creates space division and local desktop privacy in at various heights both above and below the worksurface to the floor level.

WHAT'S INCLUDED

1 framed fabric desk edge floor screen, attachment brackets, corner connection hardware (if specified).

NOTES

Framed screens match the depth of the worksurface for tight fit applications.

Fabric will be applied in the railroad direction in select Panel and Upholstery fabrics, please refer to the *Teknion Textiles Program Guide*.

PRODUCT OPTIONS

Modesty Base Height	Height	Depth	Corner Connection	Screen Finish	Hardware Finish
F Floor Height (1")	42 for 42" datum height 51 for 51" datum height	18, 24, 30, 36	N No R Right L Left	Panel Fabrics Upholstery Fabrics	Foundation Mica Accent

SAMPLE ORDER CODE

GYED F	42	24	L	B204	74
---------------	-----------	-----------	----------	-------------	-----------

**DIMENSIONS
INCHES / MM**

H	D
42 / 1067	18 / 203
42 / 1067	24 / 610
42 / 1067	30 / 762
42 / 1067	36 / 914
51 / 1295	18 / 203
51 / 1295	24 / 610
51 / 1295	30 / 762
51 / 1295	36 / 914

PRICING

NO CORNER CONNECTION (N)

PANEL FABRIC							UPHOLSTERY FABRIC									
COM/ Gr. A	Gr. 1	Gr. 2	Gr. 3	Gr. 4	Gr. 5	COM/ Gr. 1	Gr. 2	Gr. 3	Gr. 4	Gr. 5	Gr. 6	Gr. 7	Gr. 8	Gr. 9	Gr. 10	
741	752	765	814	848	883	745	785	802	827	864	886	908	953	998	1017	
829	841	859	921	964	1007	833	884	906	937	984	1011	1039	1095	1153	1178	
902	917	939	1015	1067	1119	908	969	996	1035	1091	1125	1158	1227	1297	1327	
997	1015	1040	1128	1191	1252	1002	1074	1106	1151	1218	1258	1297	1379	1461	1497	
804	813	828	877	911	943	808	847	864	889	926	948	969	1015	1061	1080	
878	890	909	971	1014	1057	883	933	955	986	1032	1061	1088	1145	1202	1227	
996	1011	1032	1108	1160	1214	1000	1063	1089	1127	1184	1218	1252	1321	1390	1420	
1047	1065	1090	1178	1241	1302	1052	1125	1156	1201	1268	1307	1347	1430	1510	1547	

RIGHT/LEFT CORNER CONNECTION (R/L)

759	767	783	832	865	898	762	802	818	843	880	902	923	969	1015	1035
846	858	875	938	981	1024	849	899	922	954	1000	1027	1056	1113	1170	1195
918	935	956	1031	1084	1136	923	986	1013	1050	1108	1141	1175	1244	1313	1344
1014	1031	1057	1145	1207	1268	1019	1091	1123	1168	1235	1275	1313	1396	1478	1514
804	813	828	877	911	943	808	847	864	889	926	948	969	1015	1061	1080
878	890	909	971	1014	1057	883	933	955	986	1032	1061	1088	1145	1202	1227
996	1011	1032	1108	1160	1214	1000	1063	1089	1127	1184	1218	1252	1321	1390	1420
1047	1065	1090	1178	1241	1302	1052	1125	1156	1201	1268	1307	1347	1430	1510	1547

If Accent/Mica Hardware Finish is specified, add 11

GVGD

Desk Edge Screen with Glass

The Desk Edge Screen with Glass Top Screen attaches to the worksurface to provide space division and local desktop privacy in various heights both above and below the worksurface to the floor level.

WHAT'S INCLUDED

1 Desk Edge Screen with Glass Top, attachment brackets, levelers

NOTES

Edge trim will be finished to match the screen when Flintwood and Natural Veneer finishes have been specified.

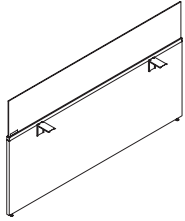

PRODUCT OPTIONS

Modesty Base Height	Height	Width	Screen Finish	Glass Finish	Hardware Finish
F Floor Height (1")	G 42"H Total (31" Solid, 11" Glass)	48, 54, 60, 66, 72, 78, 84, 90, 96	Source Laminate	CL Clear	Foundation Mica Accent
	K 51"H Total (44" Solid, 7" Glass)		Flintwood	FT Frost	
	M 51"H Total (31" Solid, 20" Glass)		Natural Veneer		
	D Inset 42"H Total (29" Solid, 13" Glass)				
	E Inset 51"H Total (42" Solid, 9" Glass)				
	F Inset 51"H Total (29" Solid, 22" Glass)				
	N 57"H Total (44" Solid, 13" Glass)				
	H Inset 57"H Total (42" Solid, 15" Glass)				

SAMPLE ORDER CODE

GVGD F	G	60	5N	CL	74
---------------	----------	-----------	-----------	-----------	-----------

DIMENSIONS INCHES / MM

H	W
42 / 1067	48 / 1219
42 / 1067	54 / 1372
42 / 1067	60 / 1524
42 / 1067	66 / 1676
42 / 1067	72 / 1829
42 / 1067	78 / 1981
42 / 1067	84 / 2134
42 / 1067	90 / 2286
42 / 1067	96 / 2438

PRICING

42"H TOTAL (31" SOLID, 11" GLASS) (G) & INSET 42"H TOTAL (29" SOLID, 13" GLASS) (D)					
Source Laminate		Flintwood		Natural Veneer	
Clear	Frost	Clear	Frost	Clear	Frost
714	899	1230	1309	1230	1461
915	1128	1570	1645	1570	1834
950	1179	1628	1713	1628	1909
1157	1411	1970	2053	1970	2288
1209	1478	2058	2149	2058	2393
1359	1651	2307	2401	2307	2672
1481	1795	2512	2609	2512	2904
1605	1939	2717	2818	2717	3137
1728	2083	2923	3027	2923	3368

If Accent/Mica Hardware Finish is specified, add 21

Pricing is continued on the following page.

G V G D
Desk Edge Screen with Glass
(Continued)

DIMENSIONS
INCHES / MM

H	W
51 / 1295	48 / 1219
51 / 1295	54 / 1372
51 / 1295	60 / 1524
51 / 1295	66 / 1676
51 / 1295	72 / 1829
51 / 1295	78 / 1981
51 / 1295	84 / 2134
51 / 1295	90 / 2286
51 / 1295	96 / 2438

51 / 1295	48 / 1219
51 / 1295	54 / 1372
51 / 1295	60 / 1524
51 / 1295	66 / 1676
51 / 1295	72 / 1829
51 / 1295	78 / 1981
51 / 1295	84 / 2134
51 / 1295	90 / 2286
51 / 1295	96 / 2438

57 / 1448	48 / 1219
57 / 1448	54 / 1372
57 / 1448	60 / 1524
57 / 1448	66 / 1676
57 / 1448	72 / 1829
57 / 1448	78 / 1981
57 / 1448	84 / 2134
57 / 1448	90 / 2286
57 / 1448	96 / 2438

PRICING

51"H TOTAL (44" SOLID, 7" GLASS) (K) & INSET 51"H TOTAL (42" SOLID, 9" GLASS) (E)

Source Laminate		Flintwood		Natural Veneer	
Clear	Frost	Clear	Frost	Clear	Frost
792	950	1378	1414	1454	1579
989	1171	1712	1744	1806	1943
1070	1268	1854	1887	1952	2102
1143	1353	1973	2010	2080	2239
1218	1444	2103	2144	2217	2389
1344	1588	2317	2358	2442	2625
1445	1704	2488	2531	2622	2816
1544	1821	2659	2703	2802	3008
1645	1938	2830	2876	2982	3199

51"H TOTAL (31" SOLID, 20" GLASS) (M) & INSET 51"H TOTAL (29" SOLID, 22" GLASS) (F)

Source Laminate		Flintwood		Natural Veneer	
Clear	Frost	Clear	Frost	Clear	Frost
820	1081	1386	1529	1462	1705
1025	1318	1723	1868	1817	2082
1101	1419	1852	2011	1951	2240
1179	1531	1976	2163	2084	2409
1255	1639	2103	2310	2217	2572
1383	1796	2315	2534	2440	2820
1487	1930	2483	2720	2618	3027
1589	2062	2652	2905	2794	3233
1691	2195	2820	3091	2972	3439

57"H TOTAL (44" SOLID, 13" GLASS) (N) & INSET 57"H TOTAL (42" SOLID, 15" GLASS) (H)

Source Laminate		Flintwood		Natural Veneer	
Clear	Frost	Clear	Frost	Clear	Frost
872	1045	1516	1556	1599	1736
1088	1288	2038	2075	2148	2313
1177	1395	2170	2211	2288	2462
1258	1488	2315	2359	2440	2627
1339	1588	2315	2359	2440	2627
1478	1746	2633	2680	2775	2982
1589	1874	2820	2868	2972	3192
1699	2003	3008	3057	3170	3401
1809	2131	3195	3246	3368	3611

If Accent/Mica Hardware Finish is specified, add 21

G N G D Glass 6mm Lateral Screen

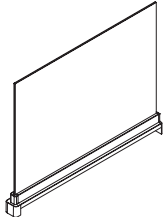

The Glass 6mm Lateral Screen attaches to the worksurface to provide user-adjustable lateral space division and privacy.

WHAT'S INCLUDED

Glass screen and attachment hardware.

NOTES

Designed for a full depth application. Specify depth of the screen that is same as worksurface depth only.

Screen datum heights are:

- 42" (13" height of screen from worksurface)
- 51" (22" height of screen from worksurface)
- 57" (28" height of screen from worksurface)

Can only be applied to both flat and knife edge District worksurface.

Glass finishes are 6mm tempered glass.

Includes a spacer that is required to mounted to a knife edge.

PRODUCT OPTIONS

Height	Depth	Screen Finish	Hardware Finish
42 for 42" datum height	23, 29, 35	CL Clear FT Frost	Foundation Mica Accent
51 for 51" datum height			
57 for 57" datum height			

SAMPLE ORDER CODE

GNGD 42	29	FT	74
----------------	-----------	-----------	-----------

DIMENSIONS INCHES / MM

H	D
42 / 1067	23 / 584
42 / 1067	29 / 737
42 / 1067	35 / 889
51 / 1295	23 / 584
51 / 1295	29 / 737
51 / 1295	35 / 889
57 / 1448	23 / 584
57 / 1448	29 / 737
57 / 1448	35 / 889

PRICING

Standard Glass, Clear	Standard Glass, Frost
341	408
373	453
414	512
384	492
421	554
475	632
408	543
451	616
508	707

If Accent/Mica Hardware Finish is specified, add 11

The Glass 10mm Lateral Screen attaches to the worksurface to provide user-adjustable lateral space division and privacy.

WHAT'S INCLUDED

Glass screen and attachment hardware.

NOTES

Designed for a full depth application. Specify depth of the screen that is same as worksurface depth only.

Screen datum heights are:

- 42" (13" height of screen from worksurface)
- 51" (22" height of screen from worksurface)
- 57" (28" height of screen from worksurface)

Can only be applied to both flat and knife edge District worksurface.

Glass finishes are 10mm tempered glass.

Includes a spacer that is required to mounted to a knife edge.

GNTD
Glass 10mm Lateral Screen

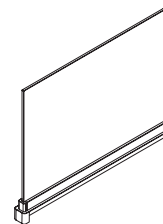

PRODUCT OPTIONS

Height	Depth	Screen Finish	Hardware Finish
42 for 42" datum height	23, 29, 35	CL Clear	Foundation Mica Accent
51 for 51" datum height		FT Frost	
57 for 57" datum height			

SAMPLE ORDER CODE

GNTD 42	30	FT	74
----------------	-----------	-----------	-----------

DIMENSIONS
INCHES / MM

H	D
42 / 1067	23 / 584
42 / 1067	29 / 737
42 / 1067	35 / 889
51 / 1295	23 / 584
51 / 1295	29 / 737
51 / 1295	35 / 889
57 / 1448	23 / 584
57 / 1448	29 / 737
57 / 1448	35 / 889

PRICING

Standard Glass, Clear	Standard Glass, Frost
354	464
397	523
452	594
426	583
479	664
548	761
461	646
523	744
601	855

If Accent/Mica Hardware Finish is specified, add 11

GNWD

Writable Glass Lateral Screen

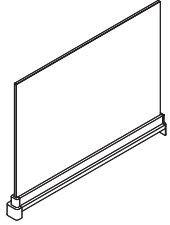

The Writable Glass Lateral Screen attaches to the worksurface to provide additional functionality, user-adjustable lateral space division and privacy.

WHAT'S INCLUDED

Writable glass screen and attachment hardware.

NOTES

Designed for a full depth application. Specify depth of the screen that is same as worksurface depth only.

Screen datum heights are:

- 42" (13" height of screen from worksurface)
- 51" (22" height of screen from worksurface)
- 57" (28" height of screen from worksurface)

Can only be applied to both flat and knife edge District worksurface.

Glass finishes are 10mm laminated glass.

Includes a spacer that is required to mounted to a knife edge.

PRODUCT OPTIONS

Height	Depth	Screen Finish	Hardware Finish
42 for 42" datum height	23, 29, 35	A6 Frost White	Foundation Mica Accent
51 for 51" datum height		H3 Polar White	
57 for 57" datum height			

SAMPLE ORDER CODE

GNWD 42	30	A6	74
----------------	-----------	-----------	-----------

**DIMENSIONS
INCHES / MM**

H	D
42 / 1067	23 / 584
42 / 1067	29 / 737
42 / 1067	35 / 889
51 / 1295	23 / 584
51 / 1295	29 / 737
51 / 1295	35 / 889
57 / 1448	23 / 584
57 / 1448	29 / 737
57 / 1448	35 / 889

PRICING

Frost White	Polar White
471	540
535	608
612	689
635	664
731	735
823	841
704	809
813	924
939	1058

If Accent/Mica Hardware Finish is specified, add 11

The Solid Lateral Screen attaches to the worksurface to provide user-adjustable lateral space division and privacy.

WHAT'S INCLUDED

Solid screen and attachment hardware.

NOTES

Designed for a full depth application. Specify depth of the screen that is same as worksurface depth only.

Screen datum heights are:

- 42" (13" height of screen from worksurface)
- 51" (22" height of screen from worksurface)
- 57" (28" height of screen from worksurface)

Can only be applied to both flat and knife edge District worksurface.

Includes a spacer that is required to mounted to a knife edge.

G N S D
Solid Lateral Screen

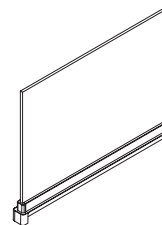

PRODUCT OPTIONS

Height	Depth	Screen Finish	Hardware Finish
42 for 42" datum height	23, 29, 35	Source Laminate	Foundation
51 for 51" datum height		Flintwood	Mica
57 for 57" datum height		Natural Veneer	Accent

SAMPLE ORDER CODE

GNSD 42	30	2V	74
----------------	-----------	-----------	-----------

DIMENSIONS
INCHES / MM

H	D
42 / 1067	23 / 584
42 / 1067	29 / 737
42 / 1067	35 / 889
51 / 1295	23 / 584
51 / 1295	29 / 737
51 / 1295	35 / 889
57 / 1448	23 / 584
57 / 1448	29 / 737
57 / 1448	35 / 889

PRICING

Source Laminate	Flintwood	Natural Veneer
312	513	526
340	562	578
387	614	631
350	596	612
385	659	678
451	737	758
384	657	674
425	726	745
496	811	834

If Accent/Mica Hardware Finish is specified, add 11

G N L D Writable Laminate Lateral Screen

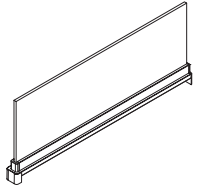

The Writable Laminate Lateral Screen attaches to the worksurface to provide additional functionality, user-adjustable lateral space division and privacy.

WHAT'S INCLUDED

Writable laminate screen and attachment hardware.

NOTES

Designed for a full depth application. Specify depth of the screen that is same as worksurface depth only.

Screen datum heights are:

- 42" (13" height of screen from worksurface)
- 51" (22" height of screen from worksurface)
- 57" (28" height of screen from worksurface)

Can only be applied to both flat and knife edge District worksurface.

Includes a spacer that is required to mounted to a knife edge.

PRODUCT OPTIONS

Height	Depth	Screen Finish	Hardware Finish
42 for 42" datum height	23, 29, 35	Writable Laminate 5D White	Foundation
51 for 51" datum height			Mica
57 for 57" datum height			Accent

SAMPLE ORDER CODE

G N L D 42	30	5D	74
-------------------	-----------	-----------	-----------

DIMENSIONS INCHES / MM

H	D
42 / 1067	23 / 584
42 / 1067	29 / 737
42 / 1067	35 / 889
51 / 1295	23 / 584
51 / 1295	29 / 737
51 / 1295	35 / 889
57 / 1448	23 / 584
57 / 1448	29 / 737
57 / 1448	35 / 889

PRICING

Foundation	Mica/Accent
478	489
525	536
744	757
563	577
632	644
758	770
620	633
695	708
834	846

The Infinity Lateral Screen attaches to the worksurface to provide a lightweight, thin, upholstered fabric screen that is expressed in a softer curvilinear aesthetic that creates space division and user-adjustable lateral desktop privacy.

GNXD Infinity Lateral Screen

WHAT'S INCLUDED

Infinity screen and attachment hardware.

NOTES

Designed for a full depth application. Specify depth of the screen that is same as worksurface depth only.

Screen datum heights are:

- 42" (13" height of screen from worksurface)
- 51" (22" height of screen from worksurface)
- 57" (28" height of screen from worksurface)

Can only be applied to both flat and knife edge District worksurface.

Includes a spacer that is required to mounted to a knife edge.

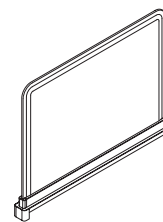

PRODUCT OPTIONS

Height	Depth	Screen Finish	Hardware Finish
42 for 42" datum height	23, 29, 35	Panel Fabrics Upholstery Fabrics	Foundation
51 for 51" datum height			Mica
57 for 57" datum height			Accent

SAMPLE ORDER CODE

GNXD 42	24	B204	74
----------------	-----------	-------------	-----------

**DIMENSIONS
INCHES / MM**

H	D
42 / 1067	23 / 584
42 / 1067	29 / 737
42 / 1067	35 / 889
51 / 1295	23 / 584
51 / 1295	29 / 737
51 / 1295	35 / 889
57 / 1448	23 / 584
57 / 1448	29 / 737
57 / 1448	35 / 889

PRICING

PANEL FABRIC							UPHOLSTERY FABRIC									
COM/ Gr. A	Gr. 1	Gr. 2	Gr. 3	Gr. 4	Gr. 5		COM/ Gr. 1	Gr. 2	Gr. 3	Gr. 4	Gr. 5	Gr. 6	Gr. 7	Gr. 8	Gr. 9	Gr. 10
623	627	632	654	668	682		624	639	648	658	674	683	691	711	731	738
676	681	688	713	732	748		678	699	708	720	739	750	761	785	808	817
721	727	736	765	786	807		723	747	759	773	796	809	822	849	877	889
691	697	708	738	760	782		694	719	731	745	769	783	797	826	854	866
739	746	758	796	822	848		741	773	786	806	834	850	867	902	937	951
804	812	826	870	900	931		807	842	858	880	914	935	954	996	1037	1053
733	739	750	783	806	828		736	762	775	789	815	829	845	874	905	918
806	813	826	867	896	924		809	842	857	878	909	926	946	982	1021	1037
886	895	910	959	992	1026		889	929	944	969	1007	1030	1051	1098	1142	1161

If Accent/Mica Hardware Finish is specified, add 11

GNZD Smooth Felt Lateral Screen

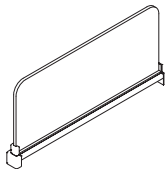

The Smooth Felt Lateral Screen attaches to the worksurface to provide lateral space division and privacy.

WHAT'S INCLUDED

Smooth Felt screen and attachment hardware.

NOTES

Designed for a full depth application. Specify depth of the screen that is same as worksurface depth only.

Screen datum heights are:

- 42" (13" height of screen from worksurface)

- 51" (22" height of screen from worksurface)

Can only be applied to both flat and knife edge District worksurface.

Includes a spacer that is required to mounted to a knife edge.

PRODUCT OPTIONS

Height	Depth	Smooth Felt Finish	Hardware Finish
42 for 42" datum height	23, 29, 35	R4 Strata	Foundation
51 for 51" datum height		R5 Pewter R6 Lunar	Mica Accent

SAMPLE ORDER CODE

GNZD 42	29	R4	74
---------	----	----	----

DIMENSIONS INCHES / MM

H	D
42 / 1067	23 / 584
42 / 1067	29 / 737
42 / 1067	35 / 889
51 / 1295	23 / 584
51 / 1295	29 / 737
51 / 1295	35 / 889

PRICING

Foundation	Mica/Accent
323	334
408	421
439	453
413	431
492	508
527	542

The Framed Fabric Lateral Screen attaches to the worksurface to provide user-adjustable lateral space division and privacy.

WHAT'S INCLUDED

Framed fabric screen and attachment hardware.

NOTES

Designed for a full depth application. Specify depth of the screen that is same as worksurface depth only.

Screen datum heights are:

- 42" (13" height of screen from worksurface)
- 51" (22" height of screen from worksurface)

Can only be applied to both flat and knife edge District worksurface.

Includes a spacer that is required to mounted to a knife edge.

**GNYD
Framed Fabric Lateral Screen**

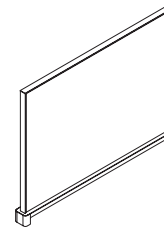

PRODUCT OPTIONS

Height	Depth	Screen Finish	Hardware Finish
42 for 42" datum height	23, 29, 35	Panel Fabrics Upholstery Fabrics	Foundation
51 for 51" datum height			Mica
57 for 57" datum height			Accent

SAMPLE ORDER CODE

GNYD 42	24	B204	74
----------------	-----------	-------------	-----------

**DIMENSIONS
INCHES / MM**

H	D
42 / 1067	23 / 584
42 / 1067	29 / 737
42 / 1067	35 / 889
51 / 1295	23 / 584
51 / 1295	29 / 737
51 / 1295	35 / 889
57 / 1448	23 / 584
57 / 1448	29 / 737
57 / 1448	35 / 889

PRICING

PANEL FABRIC

COM/ Gr. A	Gr. 1	Gr. 2	Gr. 3	Gr. 4	Gr. 5
591	595	603	624	637	653
644	649	656	681	699	716
687	692	701	732	752	771
658	664	674	705	726	747
704	711	721	760	786	812
765	775	787	832	863	892
682	689	699	731	753	775
730	738	748	788	815	842
794	804	816	863	896	926

UPHOLSTERY FABRIC

COM/ Gr. 1	Gr. 2	Gr. 3	Gr. 4	Gr. 5	Gr. 6	Gr. 7	Gr. 8	Gr. 9	Gr. 10
593	610	616	629	644	654	661	681	700	709
645	666	675	688	708	717	729	753	776	785
689	713	723	738	761	775	787	814	842	854
660	686	696	712	736	748	763	791	821	833
706	737	750	769	798	814	832	866	900	915
767	804	820	842	875	896	915	957	998	1016
685	711	722	738	763	776	791	821	852	863
733	765	778	798	829	845	863	899	935	949
797	835	850	874	909	930	949	993	1036	1055

If Accent/Mica Hardware Finish is specified, add 11

GNMD Metal Lateral Screen

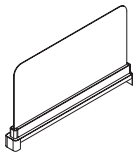

The Metal Lateral Screen attaches to the worksurface to provide a thin, metal screen that is expressed in a softer curvilinear aesthetic with an opportunity to add color that creates space division and user-adjustable lateral desktop privacy.

WHAT'S INCLUDED

Metal screen and attachment hardware.

NOTES

Designed for a full depth application. Specify depth of the screen that is same as worksurface depth only.

Screen datum heights are:

- 42" (13" height of screen from worksurface)
- 51" (22" height of screen from worksurface)
- 57" (28" height of screen from worksurface)

Can only be applied to both flat and knife edge District worksurface.

Includes a spacer that is required to mounted to a knife edge.

PRODUCT OPTIONS

Height	Depth	Finish	Hardware Finish
42 for 42" datum height	23, 29, 35	Foundation	Foundation
51 for 51" datum height		Mica	Mica
		Accent	Accent

SAMPLE ORDER CODE

GNMD 42	30	74	74
---------	----	----	----

DIMENSIONS INCHES / MM

H	D
42 / 1067	23 / 584
42 / 1067	29 / 737
42 / 1067	35 / 889
51 / 1295	23 / 584
51 / 1295	29 / 737
51 / 1295	35 / 889

PRICING

Foundation	Mica/Accent
322	335
352	370
392	411
346	360
379	400
424	445

The Modesty Screen provides visual privacy below worksurface.

WHAT'S INCLUDED

1 screen, attachment brackets.

NOTES

Edge trim will be finished to match the screen when Flintwood and Natural Veneer finishes have been specified.

**UNSM
Modesty Screen**

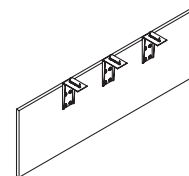

PRODUCT OPTIONS

Height	Width (6" increments)	Screen Finish	Edge Trim Finish (Applies to Fascia Laminate)	Bracket Finish
13	24 - 96	Source Laminate Flintwood (Standard) Natural Veneer	SM Aluminum Acrylic Self Edge	Foundation Mica

SAMPLE ORDER CODE

UNSM 13	48	XM		7
----------------	-----------	-----------	--	----------

**DIMENSIONS
INCHES / MM**

H	W
13 / 330	24 / 610
13 / 330	30 / 762
13 / 330	36 / 914
13 / 330	42 / 1067
13 / 330	48 / 1219
13 / 330	54 / 1372
13 / 330	60 / 1524
13 / 330	66 / 1676
13 / 330	72 / 1829
13 / 330	78 / 1981
13 / 330	84 / 2134
13 / 330	90 / 2286
13 / 330	96 / 2438

PRICING

Source Laminate	Flintwood	Natural Veneer
208	410	433
219	448	468
226	484	504
235	522	542
290	606	632
302	644	671
309	680	708
322	716	745
329	755	784
338	790	824
348	827	862
356	864	895
364	904	933

UNSF

Floor Screen

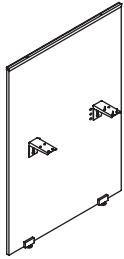

The Floor Screen attaches to the worksurface to provide space division. Its Top Rail supports selected Personal Organizers (PAX) (see the Screens Application Guide for details) It also accepts attachment of a Vertical Cable Manager (UNVC) (see electric section).

WHAT'S INCLUDED

1 floor screen, attachment brackets, levelers.

NOTES

Actual width is nominal (specified) width.

Grain direction is vertical on 51" heights and horizontal on 42" heights.

Edge trim will be finished to match the screen when Flintwood and Natural Veneer finishes have been specified.

Not all height/width combinations are available. See pricing for exact offering.

Extended levelers are available (UNSFXL). Can be found in the *Connections & Trims* section..

PRODUCT OPTIONS

Height	Width (1" increments)	Screen Finish	Edge Trim Finish (Applies to Fascia Laminate)	Bracket/Foot Cover Finish	Top Rail Finish
42, 51, 57	23 - 96	Source Laminate Flintwood (Standard) Natural Veneer	SM Aluminum Acrylic Self Edge	Foundation Mica	Foundation Mica

SAMPLE ORDER CODE

UNSF 42	30	MP		7	7
---------	----	----	--	---	---

**DIMENSIONS
FOR MM X BY 25.4**

H	W
42	23 - 24
42	25 - 27
42	28 - 30
42	31 - 33
42	34 - 36
42	37 - 39
42	40 - 42
42	43 - 45
42	46 - 48
42	49 - 51
42	52 - 54
42	55 - 57
42	58 - 60
42	61 - 63
42	64 - 66
42	67 - 69
42	70 - 72
42	73 - 75
42	76 - 78
42	79 - 81
42	82 - 84
42	85 - 87
42	88 - 90
42	91 - 93
42	94 - 96

PRICING

Source Laminate	Flintwood	Natural Veneer
501	806	923
519	853	980
538	897	1032
556	948	1089
572	994	1141
594	1032	1187
615	1073	1235
640	1118	1284
666	1160	1331
694	1205	1386
719	1253	1439
747	1304	1496
778	1353	1554
809	1408	1616
839	1461	1678
873	1521	1744
908	1579	1811
943	1640	1885
980	1705	1958
1018	1773	2038
1058	1842	2115
1100	1914	2199
1141	1987	2283
1187	2067	2376
1234	2148	2466

Pricing is continued on the following page.

UNSF
Floor Screen
(Continued)

DIMENSIONS
FOR MM X BY 25.4

PRICING

H	W	Source Laminate	Flintwood	Natural Veneer
51	23 - 24	424	1015	1049
51	25 - 27	436	1088	1125
51	28 - 30	452	1159	1200
51	31 - 33	464	1234	1275
51	34 - 36	480	1306	1350
51	37 - 39	499	1359	1404
51	40 - 42	519	1412	1456
51	43 - 45	538	1466	1516
51	46 - 48	559	1524	1573
57	23 - 24	464	1117	1154
57	25 - 27	481	1196	1237
57	28 - 30	497	1275	1320
57	31 - 33	511	1357	1402
57	34 - 36	528	1437	1484
57	37 - 39	548	1495	1544
57	40 - 42	572	1554	1602
57	43 - 45	593	1613	1668
57	46 - 48	614	1677	1731

UNSFXL

Floor Screen Extended Leveling Kit

Floor Screen Extended Levelers increase the Floor Screen leveling range by an additional 1".

WHAT'S INCLUDED
2 extended levelers.

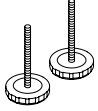

PRICING

UNSSS

Storage Screen

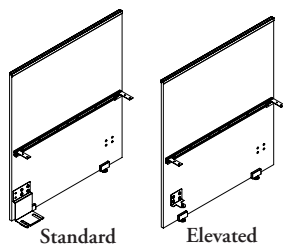

The Storage Screen attaches to District low and high credenzas to provide additional privacy.

WHAT'S INCLUDED

1 storage screen, attachment brackets, levelers.

NOTES

Actual width is nominal (specified) width.

Grain direction is vertical on 51" heights and horizontal on 48" heights.

Edge trim will be finished to match the screen when Flintwood and Natural Veneer finishes have been specified.

Not all height/width combinations are available. See pricing for exact offering.

PRODUCT OPTIONS

Height	Width (30 - 96 in 1" increments)	Screen Finish	Mid Rail/Bracket/ Foot Cover Finish	Top Rail Finish	Storage Type
42, 51, 57	24, 30 - 96	Source Laminate Flintwood (Standard) Natural Veneer	Foundation Mica	Foundation Mica	A Low Credenza Standard B Low Credenza Elevated C High Credenza Standard D High Credenza Elevated

SAMPLE ORDER CODE

UNSSS 42	30	MP	7	7	A
----------	----	----	---	---	---

DIMENSIONS FOR MM X BY 25.4

H	W
42	24
42	30
42	31 - 33
42	34 - 36
42	37 - 39
42	40 - 42
42	43 - 45
42	46 - 48
42	49 - 51
42	52 - 54
42	55 - 57
42	58 - 60
42	61 - 63
42	64 - 66
42	67 - 69
42	70 - 72
42	73 - 75
42	76 - 78
42	79 - 81
42	82 - 84
42	85 - 87
42	88 - 90
42	91 - 93
42	94 - 96

PRICING

Source Laminate	Flintwood	Natural Veneer
401	799	875
432	892	979
448	937	1027
459	987	1082
479	1026	1123
497	1064	1166
515	1107	1214
535	1152	1260
558	1196	1309
580	1243	1359
603	1295	1414
627	1343	1471
652	1395	1527
675	1450	1585
702	1507	1650
731	1565	1712
758	1628	1781
787	1692	1848
817	1760	1922
849	1829	2000
885	1899	2080
917	1971	2157
955	2050	2245
992	2130	2330

Pricing is continued on the following page.

UNSSS
Storage Screen
(Continued)

DIMENSIONS
FOR MM X BY 25.4

PRICING

H	W	Source Laminate	Flintwood	Natural Veneer
51	24	427	1064	1100
51	30	454	1215	1259
51	31 - 33	468	1295	1337
51	34 - 36	482	1372	1416
51	37 - 39	502	1428	1475
51	40 - 42	522	1481	1529
51	43 - 45	542	1541	1591
51	46 - 48	562	1602	1653
57	24	469	1170	1210
57	30	500	1336	1385
57	31 - 33	514	1425	1471
57	34 - 36	531	1509	1558
57	37 - 39	552	1570	1621
57	40 - 42	574	1630	1682
57	43 - 45	596	1695	1750
57	46 - 48	619	1761	1818

UALSG

Solid Lateral Screen with Glass

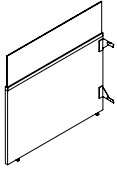

Solid Lateral Screen and Glass top attaches to a panel to provide casual lateral space division.

WHAT'S INCLUDED

1 lateral solid screen with glass top, attachment brackets, support foot (48" width and above).

NOTES

Screens 48" in width and above will include a support foot.

Support foot finish will automatically default to the bracket finish.

The Bracket location is determined by the location of the bracket in relation to the screen.

The left handed orientation will have the visible mounting brackets on the right and the support foot (if required) will be on the left.

The right handed orientation will have the visible mounting brackets on the left and the support foot (if required) will be on the right. Inset specific option (D, E, F) are designed to line up with the glass add-on in a complete Inset panel.

PRODUCT OPTIONS

Height	Width (6" increments)	Bracket Location	Screen Support	Bracket Attachment	Glass Finish	Screen Finish	Bracket Finish
A 42" total (29" Solid, 13" Glass)	24 - 72	L Left (Shown)	N None	D District	CL Clear	Source Laminate	Foundation
B 51" total (42" Solid, 9" Glass)			F Foot		FT Frost		
C 51" total (29" Solid, 22" Glass)		R Right	W Worksurface Connection			Flintwood	Natural Veneer
D Inset 42" total (29" Solid, 13" Glass)							
E Inset 51" total (42" Solid, 9" Glass)							
F Inset 51" total (29" Solid, 22" Glass)							
G 57" total (42" Solid, 15" Glass)							
H Inset 57" total (42" Solid, 15" Glass)							

SAMPLE ORDER CODE

UALSG B	30	R	N	D	FT	AG	C
----------------	-----------	----------	----------	----------	-----------	-----------	----------

**DIMENSIONS
INCHES / MM**

H	W
42 / 1067	24 / 610
42 / 1067	30 / 762
42 / 1067	36 / 914
42 / 1067	42 / 1067
42 / 1067	48 / 1219
42 / 1067	54 / 1372
42 / 1067	60 / 1524
42 / 1067	66 / 1676
42 / 1067	72 / 1829

PRICING

42" TOTAL (29" SOLID, 13" GLASS) (A)							
NO SUPPORT (N)							
Source Laminate		Flintwood		Natural Veneer			
Clear	Frost	Clear	Frost	Clear	Frost		
537	654	898	940	898	1044		
594	729	996	1045	996	1161		
653	804	1093	1153	1093	1280		
711	878	1190	1258	1190	1396		
WORKSURFACE CONNECTION (W)							
564	681	925	967	925	1072		
621	756	1023	1073	1023	1189		
680	832	1120	1180	1120	1307		
738	905	1217	1285	1217	1423		
714	899	1230	1309	1230	1461		
915	1128	1570	1645	1570	1834		
950	1179	1628	1713	1628	1909		
1157	1411	1970	2053	1970	2288		
1209	1478	2058	2149	2058	2393		

Pricing is continued on the following page.

U A L S G
Solid Lateral Screen with Glass
(Continued)

DIMENSIONS
INCHES / MM

H	W
42 / 1067	24 / 610
42 / 1067	30 / 762
42 / 1067	36 / 914
42 / 1067	42 / 1067
42 / 1067	48 / 1219
42 / 1067	54 / 1372
42 / 1067	60 / 1524
42 / 1067	66 / 1676
42 / 1067	72 / 1829

51 / 1295	24 / 610
51 / 1295	30 / 762
51 / 1295	36 / 914
51 / 1295	42 / 1067

42 / 1067	24 / 610
42 / 1067	30 / 762
42 / 1067	36 / 914
42 / 1067	42 / 1067
42 / 1067	48 / 1219
42 / 1067	54 / 1372
42 / 1067	60 / 1524
42 / 1067	66 / 1676
42 / 1067	72 / 1829

42 / 1067	24 / 610
42 / 1067	30 / 762
42 / 1067	36 / 914
42 / 1067	42 / 1067
42 / 1067	48 / 1219
42 / 1067	54 / 1372
42 / 1067	60 / 1524
42 / 1067	66 / 1676
42 / 1067	72 / 1829

51 / 1295	24 / 610
51 / 1295	30 / 762
51 / 1295	36 / 914
51 / 1295	42 / 1067

PRICING

42" TOTAL (29" SOLID, 13" GLASS) (A) (CONTINUED)

Source Laminate		Flintwood		Natural Veneer	
Clear	Frost	Clear	Frost	Clear	Frost
616	733	977	1019	977	1124
674	808	1075	1125	1075	1241
732	884	1173	1233	1173	1360
790	957	1269	1337	1269	1476
766	951	1283	1361	1283	1513
967	1180	1623	1697	1623	1886
1002	1232	1680	1766	1680	1961
1209	1463	2022	2106	2022	2340
1261	1530	2110	2201	2110	2445

51" TOTAL (42" SOLID, 9" GLASS) (B)

NO SUPPORT (N)					
573	674	972	988	1023	1098
637	753	1082	1103	1138	1226
704	833	1193	1221	1255	1355
766	911	1301	1332	1369	1481

WORKSURFACE CONNECTION (W)

601	701	999	1015	1050	1125
664	781	1109	1131	1165	1253
731	860	1220	1249	1283	1382
794	938	1328	1360	1396	1508
792	950	1378	1414	1454	1579
989	1171	1712	1744	1806	1943
1070	1268	1854	1887	1952	2102
1143	1353	1973	2010	2080	2239
1218	1444	2103	2144	2217	2389

FOOT (F)

653	753	1051	1067	1102	1177
716	833	1161	1183	1217	1305
783	912	1272	1301	1335	1434
846	990	1380	1412	1448	1560
845	1002	1430	1466	1506	1631
1041	1224	1764	1796	1858	1995
1123	1320	1906	1939	2006	2155
1195	1405	2025	2062	2133	2291
1270	1496	2156	2197	2269	2441

51" TOTAL (29" SOLID, 22" GLASS) (C)

NO SUPPORT (N)					
586	745	965	1045	1017	1161
652	836	1073	1170	1131	1301
715	923	1182	1293	1244	1437
781	1015	1286	1415	1354	1572

Pricing is continued on the following page.

U A L S G

**Solid Lateral Screen with Glass
(Continued)**

**DIMENSIONS
INCHES / MM**

H	W
51 / 1295	24 / 610
51 / 1295	30 / 762
51 / 1295	36 / 914
51 / 1295	42 / 1067
51 / 1295	48 / 1219
51 / 1295	54 / 1372
51 / 1295	60 / 1524
51 / 1295	66 / 1676
51 / 1295	72 / 1829

51 / 1295	24 / 610
51 / 1295	30 / 762
51 / 1295	36 / 914
51 / 1295	42 / 1067
51 / 1295	48 / 1219
51 / 1295	54 / 1372
51 / 1295	60 / 1524
51 / 1295	66 / 1676
51 / 1295	72 / 1829

57 / 1448	24 / 610
57 / 1448	30 / 762
57 / 1448	36 / 914
57 / 1448	42 / 1067

57 / 1448	24 / 610
57 / 1448	30 / 762
57 / 1448	36 / 914
57 / 1448	42 / 1067
57 / 1448	48 / 1219
57 / 1448	54 / 1372
57 / 1448	60 / 1524
57 / 1448	66 / 1676
57 / 1448	72 / 1829

51 / 1295	24 / 610
51 / 1295	30 / 762
51 / 1295	36 / 914
51 / 1295	42 / 1067
51 / 1295	48 / 1219
51 / 1295	54 / 1372
51 / 1295	60 / 1524
51 / 1295	66 / 1676
51 / 1295	72 / 1829

PRICING

51" TOTAL (29" SOLID, 22" GLASS) (C) (CONTINUED)

WORKSURFACE CONNECTION (W)

Source Laminate		Flintwood		Natural Veneer	
Clear	Frost	Clear	Frost	Clear	Frost
613	772	992	1073	1044	1189
679	863	1100	1198	1158	1328
742	950	1209	1320	1271	1464
808	1042	1313	1442	1381	1599
820	1081	1386	1529	1462	1705
1025	1318	1723	1868	1817	2082
1101	1419	1852	2011	1951	2240
1179	1531	1976	2163	2084	2409
1255	1639	2103	2310	2217	2572

FOOT (F)

665	824	1044	1125	1097	1241
731	915	1152	1250	1210	1380
795	1002	1261	1372	1324	1516
860	1094	1365	1495	1433	1652
872	1133	1438	1581	1514	1757
1077	1370	1776	1920	1869	2134
1153	1471	1905	2063	2004	2292
1232	1583	2029	2215	2136	2461
1307	1691	2156	2363	2269	2624

57" TOTAL (42" SOLID, 15" GLASS) (D)

NO SUPPORT (N)

537	654	898	940	898	1044
594	729	996	1045	996	1161
653	804	1093	1153	1093	1280
711	878	1190	1258	1190	1396

WORKSURFACE CONNECTION (W)

564	681	925	967	925	1072
621	756	1023	1073	1023	1189
680	832	1120	1180	1120	1307
738	905	1217	1285	1217	1423
714	899	1230	1309	1230	1461
915	1128	1570	1645	1570	1834
950	1179	1628	1713	1628	1909
1157	1411	1970	2053	1970	2288
1209	1478	2058	2149	2058	2393

FOOT (F)

616	733	977	1019	977	1124
674	808	1075	1125	1075	1241
732	884	1173	1233	1173	1360
790	957	1269	1337	1269	1476
766	951	1283	1361	1283	1513
967	1180	1623	1697	1623	1886
1002	1232	1680	1766	1680	1961
1209	1463	2022	2106	2022	2340
1261	1530	2110	2201	2110	2445

Pricing is continued on the following page.

U A L S G
Solid Lateral Screen with Glass
(Continued)

DIMENSIONS
INCHES / MM

H	W
57 / 1448	24 / 610
57 / 1448	30 / 762
57 / 1448	36 / 914
57 / 1448	42 / 1067

57 / 1448	24 / 610
57 / 1448	30 / 762
57 / 1448	36 / 914
57 / 1448	42 / 1067
57 / 1448	48 / 1219
57 / 1448	54 / 1372
57 / 1448	60 / 1524
57 / 1448	66 / 1676
57 / 1448	72 / 1829

51 / 1295	24 / 610
51 / 1295	30 / 762
51 / 1295	36 / 914
51 / 1295	42 / 1067
51 / 1295	48 / 1219
51 / 1295	54 / 1372
51 / 1295	60 / 1524
51 / 1295	66 / 1676
51 / 1295	72 / 1829

42 / 1067	24 / 610
42 / 1067	30 / 762
42 / 1067	36 / 914
42 / 1067	42 / 1067

42 / 1067	24 / 610
42 / 1067	30 / 762
42 / 1067	36 / 914
42 / 1067	42 / 1067
42 / 1067	48 / 1219
42 / 1067	54 / 1372
42 / 1067	60 / 1524
42 / 1067	66 / 1676
42 / 1067	72 / 1829

PRICING

INSET 51" TOTAL (42" SOLID, 9" GLASS) (E)

NO SUPPORT (N)

Source Laminate		Flintwood		Natural Veneer	
Clear	Frost	Clear	Frost	Clear	Frost
573	674	972	988	1023	1098
637	753	1082	1103	1138	1226
704	833	1193	1221	1255	1355
766	911	1301	1332	1369	1481

WORKSURFACE CONNECTION (W)

601	701	999	1015	1050	1125
664	781	1109	1131	1165	1253
731	860	1220	1249	1283	1382
794	938	1328	1360	1396	1508
792	950	1378	1414	1454	1579
989	1171	1712	1744	1806	1943
1070	1268	1854	1887	1952	2102
1143	1353	1973	2010	2080	2239
1218	1444	2103	2144	2217	2389

FOOT (F)

653	753	1051	1067	1102	1177
716	833	1161	1183	1217	1305
783	912	1272	1301	1335	1434
846	990	1380	1412	1448	1560
845	1002	1430	1466	1506	1631
1041	1224	1764	1796	1858	1995
1123	1320	1906	1939	2006	2155
1195	1405	2025	2062	2133	2291
1270	1496	2156	2197	2269	2441

INSET 51" TOTAL (29" SOLID, 22" GLASS) (F)

NO SUPPORT (N)

586	745	965	1045	1017	1161
652	836	1073	1170	1131	1301
715	923	1182	1293	1244	1437
781	1015	1286	1415	1354	1572

WORKSURFACE CONNECTION (W)

613	772	992	1073	1044	1189
679	863	1100	1198	1158	1328
742	950	1209	1320	1271	1464
808	1042	1313	1442	1381	1599
820	1081	1386	1529	1462	1705
1025	1318	1723	1868	1817	2082
1101	1419	1852	2011	1951	2240
1179	1531	1976	2163	2084	2409
1255	1639	2103	2310	2217	2572

Pricing is continued on the following page.

U A L S G

**Solid Lateral Screen with Glass
(Continued)**

**DIMENSIONS
INCHES / MM**

H	W
42 / 1067	24 / 610
42 / 1067	30 / 762
42 / 1067	36 / 914
42 / 1067	42 / 1067
42 / 1067	48 / 1219
42 / 1067	54 / 1372
42 / 1067	60 / 1524
42 / 1067	66 / 1676
42 / 1067	72 / 1829

51 / 1295	24 / 610
51 / 1295	30 / 762
51 / 1295	36 / 914
51 / 1295	42 / 1067

51 / 1295	24 / 610
51 / 1295	30 / 762
51 / 1295	36 / 914
51 / 1295	42 / 1067
51 / 1295	48 / 1219
51 / 1295	54 / 1372
51 / 1295	60 / 1524
51 / 1295	66 / 1676
51 / 1295	72 / 1829

51 / 1295	24 / 610
51 / 1295	30 / 762
51 / 1295	36 / 914
51 / 1295	42 / 1067
51 / 1295	48 / 1219
51 / 1295	54 / 1372
51 / 1295	60 / 1524
51 / 1295	66 / 1676
51 / 1295	72 / 1829

PRICING

INSET 51" TOTAL (29" SOLID, 22" GLASS) (F) (CONTINUED)

FOOT (F)							
Source Laminate		Flintwood		Natural Veneer			
Clear	Frost	Clear	Frost	Clear	Frost		
665	824	1044	1125	1097	1241		
731	915	1152	1250	1210	1380		
795	1002	1261	1372	1324	1516		
860	1094	1365	1495	1433	1652		
872	1133	1438	1581	1514	1757		
1077	1370	1776	1920	1869	2134		
1153	1471	1905	2063	2004	2292		
1232	1583	2029	2215	2136	2461		
1307	1691	2156	2363	2269	2624		

57" TOTAL (42" SOLID, 15" GLASS) (G)

NO SUPPORT (N)					
631	740	1069	1087	1125	1208
701	828	1190	1214	1251	1349
773	915	1312	1344	1381	1491
843	1001	1431	1466	1506	1630

WORKSURFACE CONNECTION (W)

660	771	1099	1117	1156	1237
732	859	1220	1244	1281	1379
803	946	1343	1373	1411	1521
873	1032	1461	1496	1535	1659
872	1045	1516	1556	1599	1736
1088	1288	1884	1919	1986	2137
1177	1395	2038	2075	2148	2313
1258	1488	2170	2211	2288	2462
1339	1588	2315	2359	2440	2627

FOOT (F)

717	828	1157	1174	1212	1295
788	915	1277	1301	1338	1436
861	1002	1400	1431	1469	1579
931	1089	1518	1554	1593	1717
930	1102	1573	1613	1657	1794
1145	1346	1941	1975	2043	2194
1235	1452	2096	2134	2206	2370
1314	1546	2228	2268	2345	2520
1397	1645	2371	2417	2496	2685

Pricing is continued on the following page.

U A L S G
Solid Lateral Screen with Glass
(Continued)

DIMENSIONS
INCHES / MM

H	W
51 / 1295	24 / 610
51 / 1295	30 / 762
51 / 1295	36 / 914
51 / 1295	42 / 1067
51 / 1295	24 / 610
51 / 1295	30 / 762
51 / 1295	36 / 914
51 / 1295	42 / 1067
51 / 1295	48 / 1219
51 / 1295	54 / 1372
51 / 1295	60 / 1524
51 / 1295	66 / 1676
51 / 1295	72 / 1829
51 / 1295	24 / 610
51 / 1295	30 / 762
51 / 1295	36 / 914
51 / 1295	42 / 1067
51 / 1295	48 / 1219
51 / 1295	54 / 1372
51 / 1295	60 / 1524
51 / 1295	66 / 1676
51 / 1295	72 / 1829

PRICING

INSET 57" TOTAL (42" SOLID, 15" GLASS) (H)					
NO SUPPORT (N)					
Source Laminate		Flintwood		Natural Veneer	
Clear	Frost	Clear	Frost	Clear	Frost
631	740	1069	1087	1125	1208
701	828	1190	1214	1251	1349
773	915	1312	1344	1381	1491
843	1001	1431	1466	1506	1630
WORKSURFACE CONNECTION (W)					
660	771	1099	1117	1156	1237
732	859	1220	1244	1281	1379
803	946	1343	1373	1411	1521
873	1032	1461	1496	1535	1659
872	1045	1516	1556	1599	1736
1088	1288	1884	1919	1986	2137
1177	1395	2038	2075	2148	2313
1258	1488	2170	2211	2288	2462
1339	1588	2315	2359	2440	2627
FOOT (F)					
717	828	1157	1174	1212	1295
788	915	1277	1301	1338	1436
861	1002	1400	1431	1469	1579
931	1089	1518	1554	1593	1717
930	1102	1573	1613	1657	1794
1145	1346	1941	1975	2043	2194
1235	1452	2096	2134	2206	2370
1314	1546	2228	2268	2345	2520
1397	1645	2371	2417	2496	2685

U A L S S

Solid Lateral Floor Screen

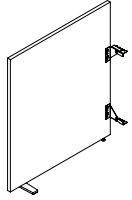

Solid Lateral Floor Screen attaches to a panel to provide casual lateral space division.

WHAT'S INCLUDED

1 lateral solid screen, attachment brackets, support foot (48" width and above).

NOTES

Screens 48" in width and above will include a support foot.

Support foot finish will automatically default to the bracket finish.

The Bracket location is determined by the location of the bracket in relation to the screen.

The left handed orientation will have the visible mounting brackets on the right and the support foot (if required) will be on the left.

The right handed orientation will have the visible mounting brackets on the left and the support foot (if required) will be on the right.

PRODUCT OPTIONS

Height	Width (6" increments)	Bracket Location	Screen Support	Bracket Attachment	Screen Finish	Bracket Finish
42, 51, 57	24 - 72	L Left (Shown) R Right	N None F Foot W Worksurface Connection	D District	Source Laminate Flintwood Natural Veneer	Foundation Mica

SAMPLE ORDER CODE

UALSS 42	30	R	N	D	AG	C
-----------------	-----------	----------	----------	----------	-----------	----------

**DIMENSIONS
INCHES / MM**

H	W
42 / 1067	24 / 610
42 / 1067	30 / 762
42 / 1067	36 / 914
42 / 1067	42 / 1067
51 / 1295	24 / 610
51 / 1295	30 / 762
51 / 1295	36 / 914
51 / 1295	42 / 1067
57 / 1448	24 / 610
57 / 1448	30 / 762
57 / 1448	36 / 914
57 / 1448	42 / 1067

PRICING

NO SUPPORT (N)		
Source Laminate	Flintwood	Natural Veneer
402	687	687
423	764	764
465	848	848
509	929	929
418	762	762
472	858	858
525	954	954
578	1049	1049
460	838	838
519	943	943
577	1049	1049
635	1154	1154

Pricing is continued on the following page.

U A L S S
Solid Lateral Floor Screen
(Continued)

DIMENSIONS
INCHES / MM

H	W
42 / 1067	24 / 610
42 / 1067	30 / 762
42 / 1067	36 / 914
42 / 1067	42 / 1067
42 / 1067	48 / 1219
42 / 1067	54 / 1372
42 / 1067	60 / 1524
42 / 1067	66 / 1676
42 / 1067	72 / 1829
51 / 1295	24 / 610
51 / 1295	30 / 762
51 / 1295	36 / 914
51 / 1295	42 / 1067
51 / 1295	48 / 1219
51 / 1295	54 / 1372
51 / 1295	60 / 1524
51 / 1295	66 / 1676
51 / 1295	72 / 1829
57 / 1448	24 / 610
57 / 1448	30 / 762
57 / 1448	36 / 914
57 / 1448	42 / 1067
57 / 1448	48 / 1219
57 / 1448	54 / 1372
57 / 1448	60 / 1524
57 / 1448	66 / 1676
57 / 1448	72 / 1829

PRICING

WORKSURFACE CONNECTION SUPPORT (W)		
Source Laminate	Flintwood	Natural Veneer
429	714	714
450	791	791
493	875	875
536	956	956
580	1094	1094
623	1176	1176
717	1352	1352
762	1429	1429
807	1514	1514
446	789	789
500	885	885
552	981	981
605	1076	1076
656	1235	1235
708	n/a	n/a
810	n/a	n/a
862	n/a	n/a
915	n/a	n/a
489	868	868
550	973	973
607	1080	1080
664	1184	1184
721	1359	1359
778	n/a	n/a
890	n/a	n/a
948	n/a	n/a
1007	n/a	n/a

Pricing is continued on the following page.

U A L S S

**Solid Lateral Floor Screen
(Continued)**

**DIMENSIONS
INCHES / MM**

H	W
42 / 1067	24 / 610
42 / 1067	30 / 762
42 / 1067	36 / 914
42 / 1067	42 / 1067
42 / 1067	48 / 1219
42 / 1067	54 / 1372
42 / 1067	60 / 1524
42 / 1067	66 / 1676
42 / 1067	72 / 1829
51 / 1295	24 / 610
51 / 1295	30 / 762
51 / 1295	36 / 914
51 / 1295	42 / 1067
51 / 1295	48 / 1219
51 / 1295	54 / 1372
51 / 1295	60 / 1524
51 / 1295	66 / 1676
51 / 1295	72 / 1829
57 / 1448	24 / 610
57 / 1448	30 / 762
57 / 1448	36 / 914
57 / 1448	42 / 1067
57 / 1448	48 / 1219
57 / 1448	54 / 1372
57 / 1448	60 / 1524
57 / 1448	66 / 1676
57 / 1448	72 / 1829

PRICING

FOOT SUPPORT (F)		
Source Laminate	Flintwood	Natural Veneer
481	766	766
502	843	843
545	928	928
588	1008	1008
632	1146	1146
675	1228	1228
770	1404	1404
814	1481	1481
859	1566	1566
499	841	841
552	937	937
604	1033	1033
657	1128	1128
708	1287	1287
760	n/a	n/a
862	n/a	n/a
914	n/a	n/a
967	n/a	n/a
548	925	925
607	1031	1031
663	1136	1136
722	1242	1242
778	1416	1416
836	n/a	n/a
948	n/a	n/a
1006	n/a	n/a
1064	n/a	n/a

UNLTG

End Mount Lateral Screen Solid with Glass

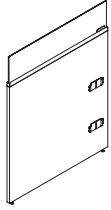

End Mount Lateral Screen Solid Glass top attaches to the end of a panel to provide casual lateral space division.

WHAT'S INCLUDED

1 lateral solid screen with, attachment brackets, support foot or worksurface connection (48" width and above).

NOTES

Screens 48" in width and above must include either a support foot or worksurface connection. Support foot and Worksurface Connection finish will automatically default to the bracket finish. The Bracket location is determined by the location of the bracket in relation to the screen. Worksurface Connection is not panel supporting. The left handed orientation will have the visible mounting brackets on the right and the support foot (if required) will be on the left. The right handed orientation will have the visible mounting brackets on the left and the support foot (if required) will be on the right. Inset specific option (D, E, F, K) are designed to line up with the glass add-on in a complete Inset panel.

PRODUCT OPTIONS

Bracket Attachment	Height	Depth	Handedness
ES End Mounted Single	G 42"H Total (31" Solid, 11" Glass)	24, 30 ,36, 48, 60, 72	L Left
EB End Mounted Double	K 51"H Total (44" Solid, 7" Glass)		R Right
ED End Mounted Shared	M 51"H Total (31" Solid, 20" Glass)		B Not Applicable
	D Inset 42"H Total (29" Solid, 13" Glass)		
	E Inset 51"H Total (42" Solid, 9" Glass)		
	F Inset 51"H Total (29" Solid, 22" Glass)		
	N 57"H Total (44" Solid, 13" Glass)		
	H Inset 57"H Total (42" Solid, 15" Glass)		

SAMPLE ORDER CODE

UNLTG ES	A	30	R
-----------------	----------	-----------	----------

PRODUCT OPTIONS (CONTINUED)

Screen Support	Screen Finish	Glass Finish	Hardware Finish
N None	Source Laminate	CL Clear	Foundation
F Foot	Flintwood	FT Frost	Mica
W Worksurface Connection	Natural Veneer		Accent

SAMPLE ORDER CODE (CONTINUED)

N	AG	CL	74
----------	-----------	-----------	-----------

See Pricing on the following page.

UNLTG
End Mount Lateral Screen Solid
with Glass (Continued)

DIMENSIONS
INCHES / MM

PRICING

END MOUNTED SINGLE/DOUBLE (ES/EB)

42" H TOTAL (31" SOLID, 11" GLASS) (G) & INSET 42" H TOTAL (29" SOLID, 13" GLASS) (D)

NO SUPPORT (N)

D	Source Laminate		Flintwood		Natural Veneer	
	Clear	Frost	Clear	Frost	Clear	Frost
24 / 610	537	654	898	940	898	1044
30 / 762	594	729	996	1045	996	1161
36 / 914	653	804	1093	1153	1093	1280
42 / 1067	709	879	1191	1260	1191	1398

WORKSURFACE CONNECTION (W)

	Source Laminate		Flintwood		Natural Veneer	
	Clear	Frost	Clear	Frost	Clear	Frost
24 / 610	564	681	925	967	925	1072
30 / 762	621	756	1023	1073	1023	1189
36 / 914	680	832	1120	1180	1120	1307
42 / 1067	736	906	1218	1287	1218	1426
48 / 1219	714	899	1230	1309	1230	1461
60 / 1524	950	1179	1628	1713	1628	1909
72 / 1829	1209	1478	2058	2149	2058	2393

FOOT (F)

	Source Laminate		Flintwood		Natural Veneer	
	Clear	Frost	Clear	Frost	Clear	Frost
48 / 1219	766	951	1283	1361	1283	1513
60 / 1524	1002	1232	1680	1766	1680	1961
72 / 1829	1261	1530	2110	2201	2110	2445

51" H TOTAL (44" SOLID, 7" GLASS) (K) & INSET 51" H TOTAL (42" SOLID, 9" GLASS) (E)

NO SUPPORT (N)

D	Source Laminate		Flintwood		Natural Veneer	
	Clear	Frost	Clear	Frost	Clear	Frost
24 / 610	573	674	972	988	1023	1098
30 / 762	637	753	1082	1103	1138	1226
36 / 914	704	833	1193	1221	1255	1355
42 / 1067	762	906	1303	1338	1371	1483

WORKSURFACE CONNECTION (W)

	Source Laminate		Flintwood		Natural Veneer	
	Clear	Frost	Clear	Frost	Clear	Frost
24 / 610	601	701	999	1015	1050	1125
30 / 762	664	781	1109	1131	1165	1253
36 / 914	731	860	1220	1249	1283	1382
42 / 1067	789	934	1330	1365	1398	1510
48 / 1219	792	950	1378	1414	1454	1579
60 / 1524	1070	1268	1854	1887	1952	2102
72 / 1829	1218	1444	2103	2144	2217	2389

FOOT (F)

	Source Laminate		Flintwood		Natural Veneer	
	Clear	Frost	Clear	Frost	Clear	Frost
48 / 1219	845	1002	1430	1466	1506	1631
60 / 1524	1123	1320	1906	1939	2006	2155
72 / 1829	1270	1496	2156	2197	2269	2441

Pricing is continued on the following page.

UNLTG

End Mount Lateral Screen Solid with Glass (Continued)

DIMENSIONS
INCHES / MM

PRICING

END MOUNTED SINGLE/DOUBLE (ES/EB) (CONTINUED)

51" H TOTAL (31" SOLID, 20" GLASS) (M) & INSET 51" H TOTAL (29" SOLID, 22" GLASS) (F)

NO SUPPORT (N)

D	Source Laminate		Flintwood		Natural Veneer	
	Clear	Frost	Clear	Frost	Clear	Frost
24 / 610	586	745	965	1045	1017	1161
30 / 762	652	836	1073	1170	1131	1301
36 / 914	715	923	1182	1293	1244	1437
42 / 1067	781	1013	1289	1416	1357	1576

WORKSURFACE CONNECTION (W)

	Source Laminate		Flintwood		Natural Veneer	
	Clear	Frost	Clear	Frost	Clear	Frost
24 / 610	613	772	992	1073	1044	1189
30 / 762	679	863	1100	1198	1158	1328
36 / 914	742	950	1209	1320	1271	1464
42 / 1067	781	1013	1289	1416	1357	1576
48 / 1219	820	1081	1386	1529	1462	1705
60 / 1524	1101	1419	1852	2011	1951	2240
72 / 1829	1255	1639	2103	2310	2217	2572

FOOT (F)

	Source Laminate		Flintwood		Natural Veneer	
	Clear	Frost	Clear	Frost	Clear	Frost
48 / 1219	872	1133	1438	1581	1514	1757
60 / 1524	1153	1471	1905	2063	2004	2292
72 / 1829	1307	1691	2156	2363	2269	2624

57" H TOTAL (44" SOLID, 13" GLASS) (N) & INSET 57" H TOTAL (42" SOLID, 15" GLASS) (H)

NO SUPPORT (N)

D	Source Laminate		Flintwood		Natural Veneer	
	Clear	Frost	Clear	Frost	Clear	Frost
24 / 610	631	740	1069	1087	1125	1208
30 / 762	701	828	1190	1214	1251	1349
36 / 914	773	915	1312	1344	1381	1491
42 / 1067	762	906	1303	1338	1371	1483

WORKSURFACE CONNECTION (W)

	Source Laminate		Flintwood		Natural Veneer	
	Clear	Frost	Clear	Frost	Clear	Frost
24 / 610	660	771	1099	1117	1156	1237
30 / 762	732	859	1220	1244	1281	1379
36 / 914	803	946	1343	1373	1411	1521
42 / 1067	762	906	1303	1338	1371	1483
48 / 1219	872	1045	1516	1556	1599	1736
60 / 1524	1177	1395	2038	2075	2148	2313
72 / 1829	1339	1588	2315	2359	2440	2627

FOOT (F)

	Source Laminate		Flintwood		Natural Veneer	
	Clear	Frost	Clear	Frost	Clear	Frost
48 / 1219	930	1102	1573	1613	1657	1794
60 / 1524	1235	1452	2096	2134	2206	2370
72 / 1829	1397	1645	2371	2417	2496	2685

Pricing is continued on the following page.

UNLTG
End Mount Lateral Screen Solid
with Glass (Continued)

DIMENSIONS
INCHES / MM

PRICING

END MOUNTED SHARED (ED)

INSET 42" H TOTAL (29" SOLID, 13" GLASS) (D)

NO SUPPORT (N)

D	Source Laminate		Flintwood		Natural Veneer	
	Clear	Frost	Clear	Frost	Clear	Frost
24 / 610	537	654	898	940	898	1044
30 / 762	594	729	996	1045	996	1161
36 / 914	653	804	1093	1153	1093	1280
42 / 1067	709	879	1191	1260	1191	1398
48 / 1219	714	899	1230	1309	1230	1461
60 / 1524	950	1179	1628	1713	1628	1909
72 / 1829	1261	1530	2110	2201	2110	2445

51" H TOTAL (44" SOLID, 7" GLASS) (K) & 42" H TOTAL (31" SOLID, 11" GLASS) (G) &

INSET 51" H TOTAL (42" SOLID, 9" GLASS) (E)

NO SUPPORT (N)

	Source Laminate		Flintwood		Natural Veneer	
	Clear	Frost	Clear	Frost	Clear	Frost
24 / 610	537	654	898	940	898	1044
30 / 762	594	729	996	1045	996	1161
36 / 914	653	804	1093	1153	1093	1280
42 / 1067	709	879	1191	1260	1191	1398

51" H TOTAL (31" SOLID, 20" GLASS) (M) & INSET 51" H TOTAL (29" SOLID, 22" GLASS) (F)

NO SUPPORT (N)

	Source Laminate		Flintwood		Natural Veneer	
	Clear	Frost	Clear	Frost	Clear	Frost
24 / 610	586	745	965	1045	1017	1161
30 / 762	652	836	1073	1170	1131	1301
36 / 914	715	923	1182	1293	1244	1437
42 / 1067	781	1013	1289	1416	1357	1576

57" H TOTAL (44" SOLID, 13" GLASS) (N) & INSET 57" H TOTAL (42" SOLID, 15" GLASS) (H)

NO SUPPORT (N)

	Source Laminate		Flintwood		Natural Veneer	
	Clear	Frost	Clear	Frost	Clear	Frost
24 / 610	631	740	1069	1087	1125	1208
30 / 762	701	828	1190	1214	1251	1349
36 / 914	773	915	1312	1344	1381	1491
42 / 1067	845	1002	1433	1472	1508	1633

UNLTS

End Mount Lateral Screen Solid

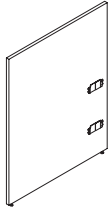

End Mount Lateral Screen attaches to the end of a panel to provide casual lateral space division.

WHAT'S INCLUDED

1 lateral solid screen, attachment brackets, support foot or worksurface connection (48" width and above).

NOTES

Screens 48" in width and above must include either a support foot or worksurface connection. Support foot and Worksurface Connection finish will automatically default to the bracket finish. The Bracket location is determined by the location of the bracket in relation to the screen. Worksurface Connection is not panel supporting. The left handed orientation will have the visible mounting brackets on the right and the support foot (if required) will be on the left. The right handed orientation will have the visible mounting brackets on the left and the support foot (if required) will be on the right.

PRODUCT OPTIONS

Bracket Attachment	Height	Depth	Handedness	Screen Support	Screen Finish	Hardware Finish
ES End Mounted Single	42 42" total	24, 30, 36, 42, 48, 60, 72	L Left	N None	Source Laminate	Foundation
EB End Mounted Double	51 51" total		R Right	F Foot	Flintwood	Mica
ED End Mounted Shared	57 57" total		N Not Applicable	W Worksurface Connection	Natural Veneer	Accent

SAMPLE ORDER CODE

UNLTS ES	42	30	R	N	AG	74
----------	----	----	---	---	----	----

DIMENSIONS
INCHES / MM

H	D
42 / 1067	24 / 610
42 / 1067	30 / 762
42 / 1067	36 / 914
42 / 1067	42 / 1067
51 / 1295	24 / 610
51 / 1295	30 / 762
51 / 1295	36 / 914
51 / 1295	42 / 1067
57 / 1448	24 / 610
57 / 1448	30 / 762
57 / 1448	36 / 914
57 / 1448	42 / 1067

PRICING

NO SUPPORT (N)		
Source Laminate	Flintwood	Natural Veneer
402	687	687
423	764	764
465	848	848
494	928	928
418	762	762
472	858	858
525	954	954
578	1050	1050
460	838	838
519	943	943
577	1049	1049
635	1154	1154

Pricing is continued on the following page.

UNITS
End Mount Lateral Screen Solid
(Continued)

DIMENSIONS
INCHES / MM

H	D
42 / 1067	24 / 610
42 / 1067	30 / 762
42 / 1067	36 / 914
42 / 1067	42 / 1067
42 / 1067	48 / 1219
42 / 1067	60 / 1524
42 / 1067	72 / 1829
51 / 1295	24 / 610
51 / 1295	30 / 762
51 / 1295	36 / 914
51 / 1295	42 / 1067
51 / 1295	48 / 1219
51 / 1295	60 / 1524
51 / 1295	72 / 1829
57 / 1448	24 / 610
57 / 1448	30 / 762
57 / 1448	36 / 914
57 / 1448	42 / 1067
57 / 1448	48 / 1219
57 / 1448	60 / 1524
57 / 1448	72 / 1829

PRICING

WORKSURFACE CONNECTION SUPPORT (W)		
Source Laminate	Flintwood	Natural Veneer
429	714	714
450	791	791
493	875	875
522	955	955
580	1094	1094
717	1352	1352
807	1514	1514
446	789	789
500	885	885
552	981	981
605	1077	1077
656	n/a	n/a
810	n/a	n/a
915	n/a	n/a
489	868	868
550	973	973
607	1080	1080
662	1182	1182
721	n/a	n/a
890	n/a	n/a
1007	n/a	n/a

FOOT SUPPORT (F)				
Source Laminate	Flintwood	Natural Veneer		
42 / 1067	48 / 1219	632	1146	1146
42 / 1067	60 / 1524	770	1404	1404
42 / 1067	72 / 1829	859	1566	1566
51 / 1295	48 / 1219	708	n/a	n/a
51 / 1295	60 / 1524	862	n/a	n/a
51 / 1295	72 / 1829	967	n/a	n/a
57 / 1448	48 / 1219	778	n/a	n/a
57 / 1448	60 / 1524	948	n/a	n/a
57 / 1448	72 / 1829	1064	n/a	n/a

UNSPS

Panel Wall Add-On Screen – Solid

The Panel Wall Add-On Screen – Solid is added on top of Panel Walls to provide space division as a flexible alternative to fixed-height Panel Walls.

WHAT'S INCLUDED

1 add-on screen, support frame, attachment hardware.

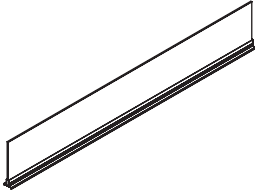

PRODUCT OPTIONS

Height	Width (6" increments)	Screen Finish	Support Frame Finish
09, 13, 15	24 - 96	Flintwood Natural Veneer	AC Clear Anodized Foundation Mica

SAMPLE ORDER CODE

UNSPS 15	48	FN	AC
-----------------	-----------	-----------	-----------

**DIMENSIONS
INCHES / MM**

PRICING

H	W	Flintwood	Natural Veneer
9 / 229	24 / 610	362	378
9 / 229	30 / 762	400	416
9 / 229	36 / 914	450	471
9 / 229	42 / 1067	492	515
9 / 229	48 / 1219	535	559
9 / 229	54 / 1372	579	602
9 / 229	60 / 1524	621	645
9 / 229	66 / 1676	664	691
9 / 229	72 / 1829	708	736
9 / 229	78 / 1981	747	780
9 / 229	84 / 2134	790	822
9 / 229	90 / 2286	836	870
9 / 229	96 / 2438	879	915
13 / 330	24 / 610	393	410
13 / 330	30 / 762	448	468
13 / 330	36 / 914	499	521
13 / 330	42 / 1067	553	578
13 / 330	48 / 1219	604	632
13 / 330	54 / 1372	657	682
13 / 330	60 / 1524	709	737
13 / 330	66 / 1676	762	790
13 / 330	72 / 1829	813	847
13 / 330	78 / 1981	867	900
13 / 330	84 / 2134	918	956
13 / 330	90 / 2286	972	1011
13 / 330	96 / 2438	1024	1065

**DIMENSIONS
INCHES / MM**

PRICING

H	W	Flintwood	Natural Veneer
15 / 381	24 / 610	409	429
15 / 381	30 / 762	464	485
15 / 381	36 / 914	522	544
15 / 381	42 / 1067	579	604
15 / 381	48 / 1219	634	661
15 / 381	54 / 1372	691	717
15 / 381	60 / 1524	745	776
15 / 381	66 / 1676	803	836
15 / 381	72 / 1829	859	893
15 / 381	78 / 1981	916	953
15 / 381	84 / 2134	972	1011
15 / 381	90 / 2286	1026	1067
15 / 381	96 / 2438	1086	1127

The Panel Wall Add-On Screen – Glass is added on top of Panel Walls to provide a lighter, frameless alternative to windows.

UNSPG

Panel Wall 10mm Add-On Screen – Glass

WHAT'S INCLUDED

1 10 mm add-on screen, support frame, attachment hardware.

NOTES

Standard Glass, Clear is a tempered glass finish.

Specialty Glass Vanceva is a laminated glass finish.

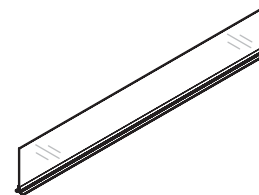

PRODUCT OPTIONS

Height	Width (6" increments)	Screen Finish	Support Frame Finish
09, 13, 15	24 - 96	5 Clear Standard Glass Specialty Glass Vanceva	AC Clear Anodized Foundation Mica

SAMPLE ORDER CODE

UNSPG 15	48	A5	AC
-----------------	-----------	-----------	-----------

**DIMENSIONS
INCHES / MM**

H	W
9 / 229	24 / 610
9 / 229	30 / 762
9 / 229	36 / 914
9 / 229	42 / 1067
9 / 229	48 / 1219
9 / 229	54 / 1372
9 / 229	60 / 1524
9 / 229	66 / 1676
9 / 229	72 / 1829
9 / 229	78 / 1981
9 / 229	84 / 2134
9 / 229	90 / 2286
9 / 229	96 / 2438
13 / 330	24 / 610
13 / 330	30 / 762
13 / 330	36 / 914
13 / 330	42 / 1067
13 / 330	48 / 1219
13 / 330	54 / 1372
13 / 330	60 / 1524
13 / 330	66 / 1676
13 / 330	72 / 1829
13 / 330	78 / 1981
13 / 330	84 / 2134
13 / 330	90 / 2286
13 / 330	96 / 2438

PRICING

Standard Glass		Specialty Glass Vanceva	
Clear	Frost	Gr. 7	
282	429	459	
326	480	518	
385	545	591	
436	610	661	
487	669	732	
538	731	799	
590	789	867	
643	853	935	
692	911	1001	
742	972	1068	
798	1030	1140	
848	1094	1207	
898	1152	1275	
306	464	508	
362	535	586	
417	603	668	
474	671	746	
527	737	822	
582	809	904	
637	874	982	
694	944	1062	
747	1014	1138	
806	1083	1217	
862	1148	1299	
914	1215	1376	
969	1285	1453	

**DIMENSIONS
INCHES / MM**

H	W
15 / 381	24 / 610
15 / 381	30 / 762
15 / 381	36 / 914
15 / 381	42 / 1067
15 / 381	48 / 1219
15 / 381	54 / 1372
15 / 381	60 / 1524
15 / 381	66 / 1676
15 / 381	72 / 1829
15 / 381	78 / 1981
15 / 381	84 / 2134
15 / 381	90 / 2286
15 / 381	96 / 2438

PRICING

Standard Glass		Specialty Glass Vanceva	
Clear	Frost	Gr. 7	
321	485	535	
376	558	616	
433	629	702	
488	702	785	
545	773	871	
607	847	956	
661	916	1038	
719	989	1125	
775	1059	1205	
835	1135	1292	
891	1205	1376	
948	1278	1457	
1007	1349	1543	

UNSPF

Panel Wall Add-On Screen - 6mm Glass

The Panel Wall Add-On Screen – Glass is added on top of Panel Walls to provide a lighter, frameless alternative to windows.

WHAT'S INCLUDED

1 6mm add-on screen, support frame, attachment hardware.

NOTES

Standard Glass, Clear and Frost is a tempered glass finish.

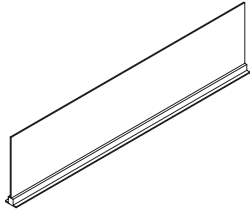

PRODUCT OPTIONS

Height	Width (6" increments)	Screen Finish	Hardware Finish
09, 13, 15	24 - 96	CL Clear FT Frost	Foundation Mica AC Clear Anodized

SAMPLE ORDER CODE

UNSPF 15	48	CL	AC
-----------------	-----------	-----------	-----------

**DIMENSIONS
INCHES / MM**

H	W
9 / 229	24 / 610
9 / 229	30 / 762
9 / 229	36 / 914
9 / 229	42 / 1067
9 / 229	48 / 1219
9 / 229	54 / 1372
9 / 229	60 / 1524
9 / 229	66 / 1676
9 / 229	72 / 1829
9 / 229	78 / 1981
9 / 229	84 / 2134
9 / 229	90 / 2286
9 / 229	96 / 2438
13 / 330	24 / 610
13 / 330	30 / 762
13 / 330	36 / 914
13 / 330	42 / 1067
13 / 330	48 / 1219
13 / 330	54 / 1372
13 / 330	60 / 1524
13 / 330	66 / 1676
13 / 330	72 / 1829
13 / 330	78 / 1981
13 / 330	84 / 2134
13 / 330	90 / 2286
13 / 330	96 / 2438

PRICING

Standard Glass Clear	Standard Glass Frost
226	342
260	383
308	436
350	487
389	535
431	584
474	632
514	683
555	729
594	778
638	823
679	875
719	922
246	373
290	429
333	482
379	537
421	589
464	646
510	700
556	756
598	811
644	866
689	918
732	972
776	1027

**DIMENSIONS
INCHES / MM**

H	W
15 / 381	24 / 610
15 / 381	30 / 762
15 / 381	36 / 914
15 / 381	42 / 1067
15 / 381	48 / 1219
15 / 381	54 / 1372
15 / 381	60 / 1524
15 / 381	66 / 1676
15 / 381	72 / 1829
15 / 381	78 / 1981
15 / 381	84 / 2134
15 / 381	90 / 2286
15 / 381	96 / 2438

PRICING

Standard Glass Clear	Standard Glass Frost
256	387
301	448
348	503
391	561
436	619
485	679
529	733
576	791
619	847
668	909
713	964
759	1023
806	1078

The Panel Wall with Inset Glass – Glass blade is embedded into the top of a UY Panel Walls to provide a frameless alternative to windows with a low amount of exposed trim.

WHAT'S INCLUDED

1 add-on 10mm Glass Blade.

WHAT'S EXCLUDED

Panel Top Trim for Panels with Inset Glass (UYTT) or Bridged Top Trim for Panels with Inset Glass (UYCT) required to connect to UY Panel wall.

NOTES

Standard Glass, Clear is a tempered glass finish.

Specialty Glass Vanceva is a laminated glass finish.

UYSPG
Panel Glass Blade for Panels with
10mm Inset Glass

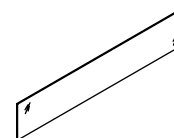

PRODUCT OPTIONS

Height	Width (6" increments)	Application		Screen Finish
09, 13, 15	24 - 96	N Both Notched	C Both Corner	5 Clear Standard Glass Specialty Glass Vanceva
		B Both Extended	D Corner & Extended	
		E One Side Extended	G One Side Corner	
		F Notched & Extended	H Corner & Notched	
		K One Side Notched		
		S Both Standard		

SAMPLE ORDER CODE

UYSPG 15	42	S	CL
-----------------	-----------	----------	-----------

**DIMENSIONS
INCHES / MM**

H	W
9 / 229	24 / 610
9 / 229	30 / 762
9 / 229	36 / 914
9 / 229	42 / 1067
9 / 229	48 / 1219
9 / 229	54 / 1372
9 / 229	60 / 1524
9 / 229	66 / 1676
9 / 229	72 / 1829
9 / 229	78 / 1981
9 / 229	84 / 2134
9 / 229	90 / 2286
9 / 229	96 / 2438
13 / 330	24 / 610
13 / 330	30 / 762
13 / 330	36 / 914
13 / 330	42 / 1067
13 / 330	48 / 1219
13 / 330	54 / 1372
13 / 330	60 / 1524
13 / 330	66 / 1676
13 / 330	72 / 1829
13 / 330	78 / 1981
13 / 330	84 / 2134
13 / 330	90 / 2286
13 / 330	96 / 2438

PRICING

Standard Glass Clear	Specialty Glass Frost	Gr. 7
178	307	329
205	346	374
244	393	428
277	438	477
307	482	527
340	526	576
373	569	625
405	614	674
435	656	720
468	700	770
503	741	821
535	788	870
565	829	917
199	350	378
235	401	436
272	453	499
307	504	556
342	553	610
378	607	669
414	657	729
452	709	786
486	760	843
523	811	904
560	862	960
593	912	1017
631	963	1073

**DIMENSIONS
INCHES / MM**

H	W
15 / 381	24 / 610
15 / 381	30 / 762
15 / 381	36 / 914
15 / 381	42 / 1067
15 / 381	48 / 1219
15 / 381	54 / 1372
15 / 381	60 / 1524
15 / 381	66 / 1676
15 / 381	72 / 1829
15 / 381	78 / 1981
15 / 381	84 / 2134
15 / 381	90 / 2286
15 / 381	96 / 2438

PRICING

Standard Glass Clear	Specialty Glass Frost	Gr. 7
208	363	398
245	417	459
282	472	522
319	527	583
355	580	645
393	635	709
430	687	767
468	741	831
504	795	891
542	852	955
580	906	1017
614	959	1075
656	1013	1138

U Y S P F

Panel Glass Blade for Panels with 6mm Inset Glass

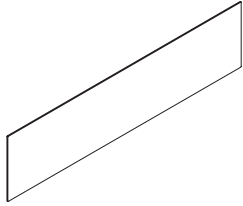

The Panel Wall with Inset Glass – Glass blade is embedded into the top of a UY Panel Walls to provide a frameless alternative to windows with a low amount of exposed trim.

WHAT'S INCLUDED

1 6mm add-on Glass Blade.

WHAT'S EXCLUDED

Panel Top Trim for Panels with Inset Glass (UYTT) or Bridged Top Trim for Panels with Inset Glass (UYCT) required to connect to UY Panel wall.

NOTES

Standard Glass, Clear and Frost is a tempered glass finish.

PRODUCT OPTIONS

Height	Width (6" increments)	Application		Screen Finish
09, 13, 15	24 - 96	N Both Notched	C Both Corner	CL Clear
		B Both Extended	D Corner & Extended	FT Frost
		E One Side Extended	G One Side Corner	
		F Notched & Extended	H Corner & Notched	
		K One Side Notched		
		S Both Standard		

SAMPLE ORDER CODE

UYSPF 15	42	S	CL
-----------------	-----------	----------	-----------

**DIMENSIONS
INCHES / MM**

H	W
9 / 229	24 / 610
9 / 229	30 / 762
9 / 229	36 / 914
9 / 229	42 / 1067
9 / 229	48 / 1219
9 / 229	54 / 1372
9 / 229	60 / 1524
9 / 229	66 / 1676
9 / 229	72 / 1829
9 / 229	78 / 1981
9 / 229	84 / 2134
9 / 229	90 / 2286
9 / 229	96 / 2438
13 / 330	24 / 610
13 / 330	30 / 762
13 / 330	36 / 914
13 / 330	42 / 1067
13 / 330	48 / 1219
13 / 330	54 / 1372
13 / 330	60 / 1524
13 / 330	66 / 1676
13 / 330	72 / 1829
13 / 330	78 / 1981
13 / 330	84 / 2134
13 / 330	90 / 2286
13 / 330	96 / 2438

PRICING

Standard Glass Clear	Specialty Glass Frost
125	215
145	242
171	276
195	307
215	337
237	367
260	399
283	430
305	459
328	489
352	519
375	553
397	581
139	246
167	280
189	316
215	353
238	386
263	426
290	459
316	497
340	532
366	568
392	604
414	638
441	674

**DIMENSIONS
INCHES / MM**

H	W
15 / 381	24 / 610
15 / 381	30 / 762
15 / 381	36 / 914
15 / 381	42 / 1067
15 / 381	48 / 1219
15 / 381	54 / 1372
15 / 381	60 / 1524
15 / 381	66 / 1676
15 / 381	72 / 1829
15 / 381	78 / 1981
15 / 381	84 / 2134
15 / 381	90 / 2286
15 / 381	96 / 2438

PRICING

Standard Glass Clear	Specialty Glass Frost
147	255
172	293
198	330
224	369
249	406
276	445
301	481
328	519
353	557
380	596
406	634
430	671
459	709

The Panel Wall with Inset Glass – Glass blade is embedded into the top of a UY Panel Walls and designed to cover a panel connection to provide a frameless alternative to windows with a low amount of exposed trim.

WHAT'S INCLUDED

1 add-on 10mm Glass Blade.

WHAT'S EXCLUDED

Panel Top Trim for Panels with Inset Glass (UYTT) or Bridged Top Trim for Panels with Inset Glass (UYCT) required to connect to UY Panel wall.

NOTES

Standard Glass, Clear is a tempered glass finish.

Specialty Glass Vanceva is a laminated glass finish.

UYSCG
Bridged Glass Blade for Panels with
10mm Inset Glass

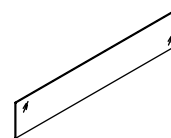

PRODUCT OPTIONS

Height	Width (6" increments)	Application		Screen Finish
09, 13, 15	48 - 96	N Both Notched	C Both Corner	5 Clear Standard Glass Specialty Glass Vanceva
		B Both Extended	D Corner & Extended	
		E One Side Extended	G One Side Corner	
		F Notched & Extended	H Corner & Notched	
		K One Side Notched		
		S Both Extended		

SAMPLE ORDER CODE

UYSCG 15	48	S	CL
-----------------	-----------	----------	-----------

DIMENSIONS
INCHES / MM

PRICING

H	W	Standard Glass Clear	Specialty Glass Frost	Gr. 7
9 / 229	48 / 1219	307	482	527
9 / 229	54 / 1372	340	526	576
9 / 229	60 / 1524	373	569	625
9 / 229	66 / 1676	405	614	674
9 / 229	72 / 1829	435	656	720
9 / 229	78 / 1981	468	700	770
9 / 229	84 / 2134	503	741	821
9 / 229	90 / 2286	535	788	870
9 / 229	96 / 2438	565	829	917
13 / 330	48 / 1219	342	553	610
13 / 330	54 / 1372	378	607	669
13 / 330	60 / 1524	414	657	729
13 / 330	66 / 1676	452	709	786
13 / 330	72 / 1829	486	760	843
13 / 330	78 / 1981	523	811	904
13 / 330	84 / 2134	560	862	960
13 / 330	90 / 2286	593	912	1017
13 / 330	96 / 2438	631	963	1073

DIMENSIONS
INCHES / MM

PRICING

H	W	Standard Glass Clear	Specialty Glass Frost	Gr. 7
15 / 381	48 / 1219	355	580	645
15 / 381	54 / 1372	393	635	709
15 / 381	60 / 1524	430	687	767
15 / 381	66 / 1676	468	741	831
15 / 381	72 / 1829	504	795	891
15 / 381	78 / 1981	542	852	955
15 / 381	84 / 2134	580	906	1017
15 / 381	90 / 2286	614	959	1075
15 / 381	96 / 2438	656	1013	1138

UYSCF

Bridged Glass Blade for Panels with 6mm Inset Glass

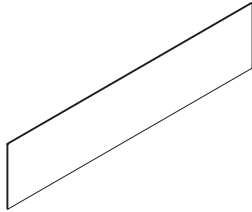

Bridged Glass Blade for Panels with Inset Glass is embedded into the top of a UY Panel Walls and designed to cover a panel connection to provide a frameless alternative to windows with a low amount of exposed trim.

WHAT'S INCLUDED

1 6mm add-on Glass Blade.

WHAT'S EXCLUDED

Panel Top Trim for Panels with Inset Glass (UYTT) or Bridged Top Trim for Panels with Inset Glass (UYCT) required to connect to UY Panel wall.

NOTES

Standard Glass, Clear and Frost is a tempered glass finish.

PRODUCT OPTIONS

Height	Width (6" increments)	Application		Screen Finish
09, 13, 15	48 - 96	N Both Notched	C Both Corner	CL Clear
		B Both Extended	D Corner & Extended	FT Frost
		E One Side Extended	G One Side Corner	
		F Notched & Extended	H Corner & Notched	
		K One Side Notched		
		S Both Extended		

SAMPLE ORDER CODE

UYSCF 15	48	S	CL
-----------------	-----------	----------	-----------

**DIMENSIONS
INCHES / MM**

H	W
9 / 229	48 / 1219
9 / 229	54 / 1372
9 / 229	60 / 1524
9 / 229	66 / 1676
9 / 229	72 / 1829
9 / 229	78 / 1981
9 / 229	84 / 2134
9 / 229	90 / 2286
9 / 229	96 / 2438
13 / 330	48 / 1219
13 / 330	54 / 1372
13 / 330	60 / 1524
13 / 330	66 / 1676
13 / 330	72 / 1829
13 / 330	78 / 1981
13 / 330	84 / 2134
13 / 330	90 / 2286
13 / 330	96 / 2438

PRICING

Standard Glass Clear	Standard Glass Frost
215	337
237	367
260	399
283	430
305	459
328	489
352	519
375	553
397	581
238	386
263	426
290	459
316	497
340	532
366	568
392	604
414	638
441	674

**DIMENSIONS
INCHES / MM**

H	W
15 / 381	48 / 1219
15 / 381	54 / 1372
15 / 381	60 / 1524
15 / 381	66 / 1676
15 / 381	72 / 1829
15 / 381	78 / 1981
15 / 381	84 / 2134
15 / 381	90 / 2286
15 / 381	96 / 2438

PRICING

Standard Glass Clear	Standard Glass Frost
249	406
276	445
301	481
328	519
353	557
380	596
406	634
430	671
459	709

The Smooth Felt Blade with Inset Glass is added on top of a UN Panel Walls to provide a lighter frameless appearance.

UNSPZ

Smooth Felt Add-On

WHAT'S INCLUDED

1 add-on Smooth Felt Add-On Blade, support frame, attachment hardware

NOTES

Smooth Felt Blade is 1/2" in thickness.

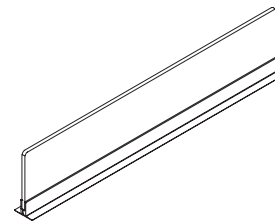

PRODUCT OPTIONS

Height	Width (6" increments)	Application	Corner Condition	Smooth Felt Finish	Support Frame Finish
09, 13, 15	24 - 96	B Both Extended E One Side Extended S Both Standard	R Radius End S Standard Square	R4 Strata R5 Pewter R6 Lunar QZ Warm Ash	Foundation Mica

SAMPLE ORDER CODE

UNSPZ 15	42	S	R	R5	AC
-----------------	-----------	----------	----------	-----------	-----------

DIMENSIONS INCHES / MM		PRICING	DIMENSIONS INCHES / MM		PRICING	DIMENSIONS INCHES / MM		PRICING
H	W		H	W		H	W	
9 / 229	24 / 610	196	13 / 330	24 / 610	211	15 / 381	24 / 610	220
9 / 229	30 / 762	238	13 / 330	30 / 762	266	15 / 381	30 / 762	279
9 / 229	36 / 914	283	13 / 330	36 / 914	311	15 / 381	36 / 914	324
9 / 229	42 / 1067	327	13 / 330	42 / 1067	388	15 / 381	42 / 1067	388
9 / 229	48 / 1219	337	13 / 330	48 / 1219	397	15 / 381	48 / 1219	397
9 / 229	54 / 1372	414	13 / 330	54 / 1372	529	15 / 381	54 / 1372	529
9 / 229	60 / 1524	492	13 / 330	60 / 1524	548	15 / 381	60 / 1524	570
9 / 229	66 / 1676	503	13 / 330	66 / 1676	559	15 / 381	66 / 1676	581
9 / 229	72 / 1829	509	13 / 330	72 / 1829	572	15 / 381	72 / 1829	590
9 / 229	78 / 1981	589	13 / 330	78 / 1981	704	15 / 381	78 / 1981	704
9 / 229	84 / 2134	634	13 / 330	84 / 2134	704	15 / 381	84 / 2134	704
9 / 229	90 / 2286	679	13 / 330	90 / 2286	713	15 / 381	90 / 2286	713
9 / 229	96 / 2438	721	13 / 330	96 / 2438	726	15 / 381	96 / 2438	726

U Y S P Z

Smooth Felt Blade for Panels with Inset

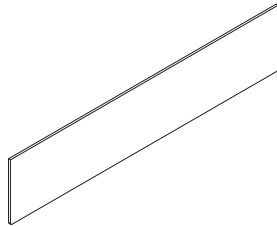

The Smooth Felt Blade with Inset Glass is embedded into the top of a UY Panel Walls to provide a frameless alternative to windows with a low amount of exposed trim

WHAT'S INCLUDED

1 add-on Smooth Felt Add-On Blade.

WHAT'S EXCLUDED

Panel Top Trim for Panels with Inset Smooth Felt (UZTT) required to connect to UY Panel wall.

NOTES

Smooth Felt Blade is 1/2" in thickness

PRODUCT OPTIONS

Height	Width (6" increments)	Application	Corner Condition	Smooth Felt Finish
09, 13, 15	24 - 96	N Both Notched B Both Extended E One Side Extended F Notched & Extended K One Side Notched S Both Standard C Both Corner D Corner & Extended G One Side Corner	R Radius End S Standard Square	R4 Strata R5 Pewter R6 Lunar QZ Warm Ash

SAMPLE ORDER CODE

UYSPZ 15	42	S	R	R5
-----------------	-----------	----------	----------	-----------

DIMENSIONS INCHES / MM		PRICING	DIMENSIONS INCHES / MM		PRICING	DIMENSIONS INCHES / MM		PRICING
H	W		H	W		H	W	
9 / 229	24 / 610	61	13 / 330	24 / 610	84	15 / 381	24 / 610	97
9 / 229	30 / 762	88	13 / 330	30 / 762	122	15 / 381	30 / 762	139
9 / 229	36 / 914	88	13 / 330	36 / 914	122	15 / 381	36 / 914	139
9 / 229	42 / 1067	139	13 / 330	42 / 1067	204	15 / 381	42 / 1067	204
9 / 229	48 / 1219	139	13 / 330	48 / 1219	204	15 / 381	48 / 1219	204
9 / 229	54 / 1372	139	13 / 330	54 / 1372	204	15 / 381	54 / 1372	204
9 / 229	60 / 1524	167	13 / 330	60 / 1524	232	15 / 381	60 / 1524	271
9 / 229	66 / 1676	167	13 / 330	66 / 1676	232	15 / 381	66 / 1676	271
9 / 229	72 / 1829	167	13 / 330	72 / 1829	232	15 / 381	72 / 1829	271
9 / 229	78 / 1981	271	13 / 330	78 / 1981	403	15 / 381	78 / 1981	413
9 / 229	84 / 2134	271	13 / 330	84 / 2134	403	15 / 381	84 / 2134	413
9 / 229	90 / 2286	271	13 / 330	90 / 2286	403	15 / 381	90 / 2286	413
9 / 229	96 / 2438	271	13 / 330	96 / 2438	403	15 / 381	96 / 2438	413

connections & trims

connections & trims product map

UNTT Top Trim

Page 634

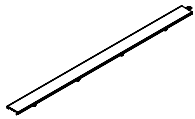

UYTT Panel Top Trim for Panels with Inset Glass for 6mm or 10mm

Page 635



UZTT Panel Top Trim for Panels with Inset Smooth Felt

Page 636

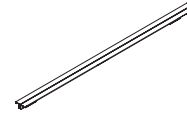

UNTTP Top Trim – Power Pole Access

Page 637

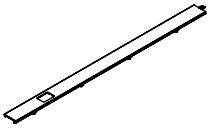

UYCT Bridged Top Trim for Panels with Inset Glass for 6mm or 10mm

Page 638

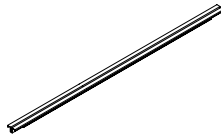

UNTE End Trim

Page 639



UATE End Trim for Freestanding District

Page 640



UNTM Intermediate End Trim

Page 641



UNPCR2 Two-Way 90°

Page 642



UNPCR3 Three-Way 90°

Page 643



UNPCR4 Four-Way 90°

Page 644



UNPCCR Two-Way 180° Spacer

Page 645



connections & trims product map

UNIC2 Two-Way Intermediate 90°

Page 646



UNIC3 Three-Way Intermediate 90°

Page 647

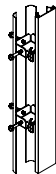

UNIC4 Four-Way Intermediate 90°

Page 648



UNICC Two-Way Intermediate 180°

Page 649

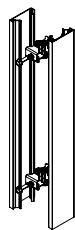

UYPC2 Two-Way 90° Corner Cap for Panels with Inset Glass for 6mm or 10mm

Page 650



UNTC Transition Cover

Page 651



UYTC Top Trim Cover for Panels with Inset Glass for 6mm or 10mm

Page 652

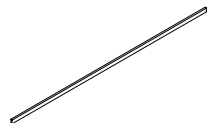

UNPCW Wall Start

Page 653



UNTT Top Trim

The Top Trim finishes the top of a panel wall, full-height window or add-on window.

WHAT'S INCLUDED

Top trim, attachment hardware, gasket.

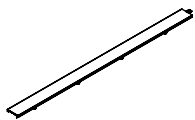

PRODUCT OPTIONS

Width (6" increments)	Finish
24 - 96	AC Clear Anodized Foundation Mica

SAMPLE ORDER CODE

UNTT 48	AC
---------	----

DIMENSIONS INCHES / MM

W
24 / 610
30 / 762
36 / 914
42 / 1067
48 / 1219
54 / 1372
60 / 1524
66 / 1676
72 / 1829
78 / 1981
84 / 2134
90 / 2286
96 / 2438

PRICING

60
66
73
80
85
97
103
110
119
127
133
144
148

The Top Trim designed to be inserted into UY panel wall to embed the related UY glass blade.

UYTT

Panel Top Trim for Panels with Inset Glass for 6mm or 10mm

WHAT'S INCLUDED

Top trim, attachment hardware, gasket.

NOTES

6mm option designed to work in conjunction with UYSPF and UYSCF.



PRODUCT OPTIONS

Width (6" increments)	Application	Finish
24 - 96	B Both 10mm Extended E One Side 10mm Extended S Both 10mm Standard A Both 6mm Extended D One Side 6mm Extended R Both 6mm Standard	AC Clear Anodized Foundation Mica

SAMPLE ORDER CODE

UYTT 48	B	AC
----------------	----------	-----------

**DIMENSIONS
INCHES / MM**

PRICING

W	
24 / 610	105
30 / 762	111
36 / 914	129
42 / 1067	142
48 / 1219	152
54 / 1372	170
60 / 1524	179
66 / 1676	195
72 / 1829	209
78 / 1981	222
84 / 2134	233
90 / 2286	249
96 / 2438	257

UZTT

Panel Top Trim for Panels with Inset Smooth Felt

The Top Trim designed to be inserted into UY panel wall to embed the related UY Smooth Felt blade

WHAT'S INCLUDED

Top trim, attachment hardware, gasket

NOTES

Designed to work in conjunction with UYSPZ.

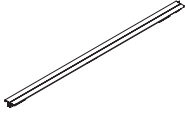

PRODUCT OPTIONS

Width (6" increments)	Application	Finish
24 - 96	B Both 10mm Extended E One Side 10mm Extended S Both 10mm Standard	AC Clear Anodized Foundation Mica

SAMPLE ORDER CODE

UZTT 48	B	AC
---------	---	----

DIMENSIONS INCHES / MM

W
24 / 610
30 / 762
36 / 914
42 / 1067
48 / 1219
54 / 1372
60 / 1524
66 / 1676
72 / 1829
78 / 1981
84 / 2134
90 / 2286
96 / 2438

PRICING

105
111
129
142
152
170
179
195
209
222
233
249
257

The Top Trim – Power Pole Access finishes the top of a panel wall with a cut out for off-module power pole applications.

UNTTP

Top Trim – Power Pole Access

WHAT'S INCLUDED

Top trim, attachment hardware, gasket.

NOTES

The cut out is located 9" from one end of the top trim.

Trim is non-handed.

Required for off-module Power Pole (UNQEP) applications.

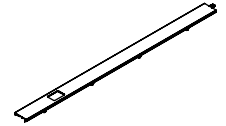

PRODUCT OPTIONS

Width (6" increments)	Finish
24 - 96	AC Clear Anodized Foundation Mica

SAMPLE ORDER CODE

UNTTP 96	AC
-----------------	-----------

**DIMENSIONS
INCHES / MM**

PRICING

W	
24 / 610	113
30 / 762	118
36 / 914	127
42 / 1067	135
48 / 1219	145
54 / 1372	151
60 / 1524	155
66 / 1676	168
72 / 1829	175
78 / 1981	182
84 / 2134	187
90 / 2286	197
96 / 2438	201

UYCT Bridged Top Trim for Panels with Inset Glass for 6mm or 10mm

The Top Trim designed to be inserted into the UY panel walls and designed to cover a panel connection to embed related UY glass blade.

WHAT'S INCLUDED

Top trim, attachment hardware, gasket.



PRODUCT OPTIONS

Width (6" increments)	Application	Bracket	Finish
48 - 96	B Both 10mm Extended	N No Bracket	AC Clear Anodized Foundation Mica
	E One Side 10mm Extended	1 One Bracket	
	S Both 10mm Standard	2 Two Bracket	
	A Both 6mm Extended		
	D One Side 6mm Extended		
	R Both 6mm Standard		

SAMPLE ORDER CODE

UYCT 48	S	N	AC
----------------	----------	----------	-----------

DIMENSIONS INCHES / MM

W
48 / 1219
54 / 1372
60 / 1524
66 / 1676
72 / 1829
78 / 1981
84 / 2134
90 / 2286
96 / 2438

PRICING

152
170
179
195
209
222
233
249
257

The End Trim finishes the end of a panel wall, full-height window or add-on window combination.

WHAT'S INCLUDED
End trim, attachment hardware.

UNTE
End Trim



PRODUCT OPTIONS

Height	Finish
29, 42, 51, 66	AC Clear Anodized Foundation Mica

SAMPLE ORDER CODE

UNTE 51	Q
---------	---

DIMENSIONS
INCHES / MM

H
29 / 737
42 / 1067
51 / 1295
66 / 1676

PRICING

75
95
109
129

U A T E End Trim for Freestanding District

The End Trim finishes the end of a panel wall.

WHAT'S INCLUDED

End trim, attachment hardware.

NOTES

End Trim is to only be applied to District Panel that is supported by the Free standing Foot (UAFFN).



PRODUCT OPTIONS

Height	End Trim Finish
29, 42, 51	AC Clear Anodized Foundation Mica

SAMPLE ORDER CODE

UATE 51	Q
---------	---

DIMENSIONS INCHES / MM

H
29 / 29
42 / 42
51 / 51

PRICING

75
95
109

The Intermediate End Trim finishes the end of a panel wall, full-height window or add-on window in a change of height location.

WHAT'S INCLUDED

Intermediate end trim, attachment hardware.

UNTM
Intermediate End Trim



PRODUCT OPTIONS

Height	Finish
09, 13, 15, 22, 24, 37	AC Clear Anodized Foundation Mica

SAMPLE ORDER CODE

UNTM 51	Q
---------	---

DIMENSIONS
INCHES / MM

H
9 / 229
13 / 330
15 / 381
22 / 559
24 / 610
37 / 940

PRICING

45
48
50
67
72
83

UNPCR2 Two-Way 90°



The Two-Way 90° connector provides a finished connection for two panel walls and windows at 90° in same-height or varying-height configurations.

WHAT'S INCLUDED

Corner trim, corner brackets, attachment hardware, top cap, elevated panel wall foot (as specified).

NOTES

Panel wall type indicates the panel wall mix at the 90° connection.

Internal (non-visible) brackets are painted in Ebony.

PRODUCT OPTIONS

Panel Type	Height	Finish
FF One Flush Panel/Flush Full-Height Window / Convertible Panel and One Flush Panel /Flush Full-Height Window/Convertible Panel Wall	29, 42, 51, 66	AC Clear Anodized Foundation Mica
EE One Elevated Panel/Elevated Full-Height Window and One Elevated Panel/Elevated Full-Height Window		
EA One Flush Panel/Flush Full-Height Window / Convertible Panel Wall and One Elevated Panel /Elevated Full-Height Window		

SAMPLE ORDER CODE

UNPCR2 FF	51	AC
------------------	-----------	-----------

DIMENSIONS INCHES / MM

H
29 / 737
42 / 1067
51 / 1295
66 / 1676

PRICING

Panel Type (FF)	All Other Panel Types
156	236
204	282
240	321
285	362

The Three-Way 90° connector provides a finished connection for three panel walls and windows at 90° in same-height or varying-height configurations.

WHAT'S INCLUDED

1 trim, corner brackets, attachment hardware, top cap, elevated panel wall foot (as specified).

WHAT'S EXCLUDED

Panel wall type indicates the panel wall mix at the 90° connection.

When Trim option (0) is selected, a Transition Cover (UNTC) must be ordered separately to cover the open side.

UNPCR3
Three-Way 90°



PRODUCT OPTIONS

Panel Type	Height	Trim	Finish
FF Flush Panels/Flush Full-Height Windows/Convertible Panel Wall	29, 42, 51, 66	0 No Vertical Cover (select when a two-way intermediate 180° connection is above a three-way 90° connection) 1 One Vertical Cover (completely finishes connection)	AC Clear Anodized Foundation Mica
EE Elevated Panels/Elevated Full-Height Windows			
EA One Elevated Panel/Elevated Full-Height Window and two Flush Panels/Flush Full-Height Windows/Convertible Panel Wall			
EB Two Elevated Panels/Elevated Full-Height Windows at 90° and One Panel/Flush Full-Height Window/Convertible Panel Wall			
EC Two Elevated Panels/Elevated Full-Height Windows at 180° and One Flush Panel/Flush Full-Height Window/Convertible Panel Wall			

SAMPLE ORDER CODE

UNPCR3 EA	66	1	7
------------------	-----------	----------	----------

DIMENSIONS
INCHES / MM

H
29 / 737
42 / 1067
51 / 1295
66 / 1676

PRICING

NO TRIM COVER (0)

Panel Type (FF)	All Other Panel Types
77	154
97	175
113	193
135	214

WITH TRIM COVER (1)

Panel Type (FF)	All Other Panel Types
153	231
195	274
231	309
274	352

UNPCR4 Four-Way 90°



The Four-Way 90° connector provides a finished connection for four panel walls and windows at 90° in same-height or varying-height configurations.

WHAT'S INCLUDED

Corner brackets, attachment hardware, top cap, gasket, elevated panel wall F-foot (as specified).

NOTES

Panel wall type indicates the panel wall mix at the 90° connection.

PRODUCT OPTIONS

Panel Type		Height	Finish
FF	Four Flush Panels/Flush Full-Height Windows/Convertible Panel Wall	29, 42, 51, 66	AC Clear Anodized Foundation Mica
EE	Four Elevated Panels/Elevated Full-Height Windows		
EA	One Elevated Panel/Elevated Full-Height Window and 3 Flush Panels/Flush Full-Height Windows/Convertible Panel Wall		
EB	Two Elevated Panels/Elevated Full-Height Windows at 90° and Two Flush Panels/Flush Full-Height Windows//Convertible Panel Wall at 90°		
EC	Two Elevated Panels/Elevated Full-Height Windows at 180° and Two Flush Panels/Flush Full-Height Windows/Convertible Panel Wall at 180°		
ED	Three Elevated Panels/Elevated Full-Height Windows and One Flush Panel/Flush Full-Height Window		

SAMPLE ORDER CODE

UNPCR4 EC	29	AC
------------------	-----------	-----------

DIMENSIONS INCHES / MM

H
29 / 737
42 / 1067
51 / 1295
66 / 1676

PRICING

Panel Type (FF)	All Other Panel Types
107	187
133	214
155	238
180	260

The Two-Way 180° Spacer connector provides finished spacer connection between two panel walls and windows joined at 180° equal to the thickness of one panel wall.

WHAT'S INCLUDED

2 trims, brackets, attachment hardware, top cap, elevated panel wall foot (as specified).

NOTES

Panel wall type indicates the panel wall mix at the 180° connection.

UNPCCR
Two-Way 180° Spacer



PRODUCT OPTIONS

Panel Type	Height	Finish
FF Flush Panels/Flush Full-Height Windows / Convertible Panel Wall	29, 42, 51, 66	AC Clear Anodized
EE Elevated Panels/Elevated Full-Height Windows		Foundation
EA One Flush Panel/Flush Full-Height Window /Convertible Panel Wall and One Elevated Panel/Elevated Full-Height Window		Mica

SAMPLE ORDER CODE

UNPCCR EE	51	AC
------------------	-----------	-----------

DIMENSIONS
INCHES / MM

H
29 / 737
42 / 1067
51 / 1295
66 / 1676

PRICING

Panel Type (FF)	All Other Panel Types
154	236
194	277
229	311
272	352

UNIC 2

Two-Way Intermediate 90°

The Two-Way Intermediate 90° connector provides finished connection to the exposed ends of panel walls and windows or add-on windows above a three- or four-way connector in change-of-height configuration.

WHAT'S INCLUDED

Corner trim, corner brackets, attachment hardware.

WHAT'S EXCLUDED

Top cap.



PRODUCT OPTIONS

Height	Finish
09, 13, 15, 22, 24, 37	AC Clear Anodized Foundation Mica

SAMPLE ORDER CODE

UNIC2 22	AC
----------	----

**DIMENSIONS
INCHES / MM**

H
9 / 229
13 / 330
15 / 381
22 / 559
24 / 610
37 / 940

PRICING

71
94
99
130
139
168

The Three-Way Intermediate 90° connector provides finished connection to the exposed ends of panel walls and windows above a four-way connector in change-of-height configuration.

WHAT'S INCLUDED

Trim, corner brackets, attachment hardware.

WHAT'S EXCLUDED

Top cap.

UNIC3
Three-Way Intermediate 90°



PRODUCT OPTIONS

Height	Finish
09, 13, 15, 22, 24, 37	AC Clear Anodized Foundation Mica

SAMPLE ORDER CODE

UNIC3 09	7
-----------------	----------

**DIMENSIONS
INCHES / MM**

H
9 / 229
13 / 330
15 / 381
22 / 559
24 / 610
37 / 940

PRICING

71
99
101
133
137
155

UNIC4

Four-Way Intermediate 90°

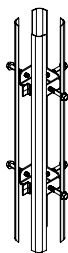

The Four-Way Intermediate 90° connector provides intermediate four-way connection when add-on windows are added above an existing four-way connection.

WHAT'S INCLUDED

Corner brackets, attachment hardware.

WHAT'S EXCLUDED

Top cap.

NOTES

Finished in Ebony.

PRODUCT OPTIONS

Height
09, 13, 15, 22, 24, 37

SAMPLE ORDER CODE

UNIC4 15

**DIMENSIONS
INCHES / MM**

H
9 / 229
13 / 330
15 / 381
22 / 559
24 / 610
37 / 940

PRICING

48
73
74
101
103
104

The Two-Way Intermediate 180° connector provides intermediate two-way spacer connection.

WHAT'S INCLUDED

2 trims, brackets, attachment hardware.

WHAT'S EXCLUDED

Top cap.

NOTES

When Trim option 1 is selected, a Transition Cover (UNTC) must be ordered separately to cover the open side.

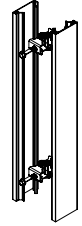

UNICC

Two-Way Intermediate 180°

PRODUCT OPTIONS

Height	Trim	Finish
09, 13, 15, 22, 24, 37	<ol style="list-style-type: none"> One Vertical Cover (select when a two-way intermediate 180° connection is above a three-way 90° connection) Two Vertical Covers (completely finishes both sides with equal length trim covers) 	AC Clear Anodized Foundation Mica

SAMPLE ORDER CODE

UNICC 37	2	AC
----------	---	----

**DIMENSIONS
INCHES / MM**

H
9 / 229
13 / 330
15 / 381
22 / 559
24 / 610
37 / 940

PRICING

	One Vertical Cover	Two Vertical Covers
	47	74
	60	91
	61	94
	79	122
	82	130
	99	150

UYPC 2

Two-Way 90° Corner Cap for Panels with Inset Glass for 6mm or 10mm

The Two-Way 90° Corner cap provides a finished connection for two corner application UY glass blades at 90° in same-height.

WHAT'S INCLUDED
Corner cap.



PRODUCT OPTIONS

Glass Thickness	Finish
6 6mm Thickness	AC Clear Anodized
10 10mm Thickness	Foundation
	Mica

SAMPLE ORDER CODE

UYPC2 6	AC
---------	----

PRICING

The Transition Cover provides a vertical trim cover when a two-way intermediate 180° panel wall connection occurs above a three-way connection.

UNTC

Transition Cover

WHAT'S INCLUDED

Transition cover, attachment hardware.

WHAT'S EXCLUDED

Top cap.

NOTES

Panel Wall Type indicates the panel wall mix at the 90° connection.



PRODUCT OPTIONS

Panel Type	Height	Finish
FF Three Flush Panels	42, 51, 66	AC Clear Anodized
EE Three Elevated Panels		Foundation
EA Two Flush Panels and One Elevated Panel		Mica
EB One Flush Panel and Two Elevated Panels at 90°		
EC One Flush Panel and Two Elevated Panels at 180°		

SAMPLE ORDER CODE

UNTC FF	2	AC
---------	---	----

**DIMENSIONS
INCHES / MM**

H
42 / 1067
51 / 1295
66 / 1676

PRICING

All Panel Types
102
117
137

UYTC

Top Trim Cover for Panels with Inset Glass 6mm or 10mm

The Top Trim Cover provides a horizontal cover on the inset panel cover when a opening occurs due to application of panel mounted products.

WHAT'S INCLUDED

Top Trim cover, attachment hardware.

NOTES

Top Trim is can be cut on site.

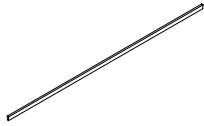

PRODUCT OPTIONS

Width (6" increments)	Glass Thickness	Finish
48 - 102	6 6mm Thickness 10 10mm Thickness	AC Clear Anodized Foundation Mica

SAMPLE ORDER CODE

UYTC 72	6	AC
---------	---	----

DIMENSIONS INCHES / MM

W
48 / 1219
54 / 1372
60 / 1524
66 / 1676
72 / 1829
78 / 1981
84 / 2134
90 / 2286
96 / 2438
102 / 2591

PRICING

42
46
50
57
61
68
72
77
81
85

The Wall Start connects panel walls to reinforced drywall.

UNPCW
Wall Start

WHAT'S INCLUDED

Wall start, connecting hardware.

NOTES

Finished in Ebony.



PRODUCT OPTIONS

Height
29, 42, 51, 66

SAMPLE ORDER CODE

UNPCW 51

DIMENSIONS INCHES / MM	PRICING
H	
29 / 737	134
42 / 1067	160
51 / 1295	220
66 / 1676	227

worksurfaces

worksurfaces product map

UNWR Rectangle Worksurface

Page 656

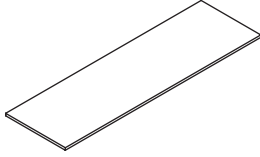

**UNWC Rectangle with Radius
Corners Worksurface**

Page 660

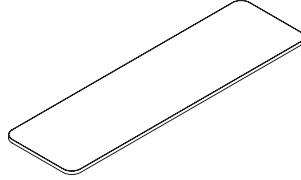

UNWR

Rectangle Worksurface

The Rectangle Worksurface provides a range of depths to support both primary and secondary worksurface applications.

WHAT'S INCLUDED

1 worksurface

NOTES

Actual depth is 1" less than nominal depth to allow for a cable management gap at the back and to align with storage.

Actual width equals nominal width, allowance for gaps at side edges must be specified.

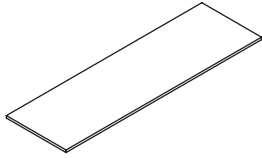

PRODUCT OPTIONS

Depth	Width (1" increments)	Worksurface Finish	Edge Trim Style	Edge Trim Finish	Grommet Location (optional)	Grommet Finish
17, 20, 24, 30, 36	22 - 96	Foundation Laminate Flintwood Natural Veneer	8 Flat (with Foundation) 9 Flat (with Flintwood and Natural Veneer) H Full Knife (with all)	Edge Trim Colors	1 Left 2 Centered 3 Right	Q Storm White P Espresso 7 Platinum V Very White

SAMPLE ORDER CODE

UNWR 24	48	LW	9	ST	2	7
---------	----	----	---	----	---	---

DIMENSIONS – INCHES FOR MM X BY 25.4

D	W	FOUNDATION LAMINATE		FLINTWOOD		NATURAL VENEER	
		Flat Edge	Full Knife Edge	Flat Edge	Full Knife Edge	Flat Edge	Full Knife Edge
17	22 - 24	259	311	585	684	613	717
17	25 - 27	281	331	614	715	645	752
17	28 - 30	300	367	645	747	676	785
17	31 - 33	303	374	675	781	709	818
17	34 - 36	306	379	719	831	755	871
17	37 - 39	342	429	748	863	785	905
17	40 - 42	347	434	780	895	816	938
17	43 - 45	350	439	809	928	848	972
17	46 - 48	353	448	839	959	879	1005
17	49 - 51	421	539	896	1029	940	1078
17	52 - 54	426	545	926	1061	972	1112
17	55 - 57	429	551	956	1092	1002	1145
17	58 - 60	432	557	986	1125	1035	1178
17	61 - 63	435	562	1016	1157	1065	1212
17	64 - 66	438	568	1045	1189	1097	1245
17	67 - 69	442	573	1114	1270	1168	1331
17	70 - 72	448	580	1144	1303	1199	1367
17	73 - 75	596	792	1174	1334	1230	1398
17	76 - 78	601	799	1203	1367	1261	1432
17	79 - 81	604	806	1234	1398	1292	1466
17	82 - 84	607	810	1263	1431	1324	1501
17	85 - 87	610	816	1311	1487	1375	1560
17	88 - 90	613	822	1342	1520	1406	1593
17	91 - 93	616	828	1371	1552	1437	1628
17	94 - 96	621	834	1401	1584	1470	1660

PRICING

If Grommet is specified, add 35

Pricing is continued on the following page.

U N W R
Rectangle Worksurface
(Continued)

DIMENSIONS – INCHES
FOR MM X BY 25.4

PRICING

D	W	FOUNDATION LAMINATE		FLINTWOOD		NATURAL VENEER	
		Flat Edge	Full Knife Edge	Flat Edge	Full Knife Edge	Flat Edge	Full Knife Edge
20	22 - 24	263	319	619	721	650	757
20	25 - 27	281	342	653	756	683	791
20	28 - 30	305	375	697	809	732	848
20	31 - 33	308	382	731	843	764	885
20	34 - 36	311	387	761	877	798	919
20	37 - 39	350	437	792	912	832	956
20	40 - 42	353	443	824	947	865	992
20	43 - 45	356	451	886	1018	928	1067
20	46 - 48	360	456	916	1051	961	1103
20	49 - 51	430	550	949	1087	994	1139
20	52 - 54	433	557	980	1122	1027	1175
20	55 - 57	436	562	1013	1156	1062	1211
20	58 - 60	441	568	1082	1240	1133	1300
20	61 - 63	445	574	1113	1275	1167	1335
20	64 - 66	450	581	1145	1309	1200	1371
20	67 - 69	453	586	1177	1343	1234	1407
20	70 - 72	457	591	1227	1402	1286	1470
20	73 - 75	608	808	1260	1436	1320	1505
20	76 - 78	611	813	1291	1471	1353	1542
20	79 - 81	614	820	1324	1505	1387	1579
20	82 - 84	619	826	1354	1540	1420	1614
20	85 - 87	624	832	1387	1573	1454	1650
20	88 - 90	628	838	1419	1608	1486	1685
20	91 - 93	631	845	1451	1643	1520	1721
20	94 - 96	635	850	1520	1726	1592	1810
24	22 - 24	290	357	680	789	713	828
24	25 - 27	325	405	714	827	748	867
24	28 - 30	328	410	748	865	785	908
24	31 - 33	369	457	783	902	821	947
24	34 - 36	370	463	846	977	887	1024
24	37 - 39	399	509	879	1015	922	1064
24	40 - 42	404	515	914	1051	959	1103
24	43 - 45	407	523	949	1089	994	1143
24	46 - 48	411	530	1021	1177	1069	1234
24	49 - 51	537	695	1056	1215	1106	1274
24	52 - 54	542	702	1090	1252	1141	1312
24	55 - 57	545	709	1124	1288	1177	1351
24	58 - 60	551	715	1177	1352	1234	1416
24	61 - 63	556	722	1212	1389	1269	1456
24	64 - 66	559	729	1245	1427	1305	1496
24	67 - 69	563	736	1280	1463	1342	1534
24	70 - 72	568	741	1314	1502	1377	1573
24	73 - 75	623	826	1350	1539	1414	1613
24	76 - 78	628	833	1421	1627	1489	1704
24	79 - 81	631	839	1455	1662	1526	1743
24	82 - 84	635	846	1489	1702	1562	1783
24	85 - 87	639	853	1524	1738	1597	1822
24	88 - 90	644	859	1559	1776	1633	1861
24	91 - 93	649	866	1593	1812	1669	1899
24	94 - 96	654	873	1666	1900	1744	1992

If Grommet is specified, add 35

Pricing is continued on the following page.

UNWR

Rectangle Worksurface (Continued)

DIMENSIONS – INCHES
FOR MM X BY 25.4

PRICING

D	W	FOUNDATION LAMINATE		FLINTWOOD		NATURAL VENEER	
		Flat Edge	Full Knife Edge	Flat Edge	Full Knife Edge	Flat Edge	Full Knife Edge
30	22 - 24	311	385	748	865	785	908
30	25 - 27	335	418	787	908	824	951
30	28 - 30	372	464	853	986	895	1035
30	31 - 33	376	475	891	1029	935	1078
30	34 - 36	380	481	930	1070	975	1123
30	37 - 39	434	554	1005	1163	1053	1219
30	40 - 42	439	562	1043	1204	1093	1262
30	43 - 45	445	569	1083	1246	1134	1306
30	46 - 48	451	578	1139	1313	1194	1377
30	49 - 51	553	716	1177	1355	1234	1421
30	52 - 54	558	723	1216	1397	1275	1464
30	55 - 57	563	732	1254	1439	1313	1508
30	58 - 60	568	738	1292	1482	1354	1553
30	61 - 63	573	746	1369	1574	1433	1650
30	64 - 66	580	755	1407	1616	1475	1694
30	67 - 69	584	761	1445	1658	1514	1737
30	70 - 72	588	767	1483	1700	1554	1782
30	73 - 75	887	1171	1522	1742	1593	1825
30	76 - 78	891	1179	1597	1834	1672	1922
30	79 - 81	897	1187	1635	1875	1713	1965
30	82 - 84	902	1194	1674	1918	1754	2010
30	85 - 87	908	1201	1712	1960	1793	2053
30	88 - 90	913	1210	1750	2002	1834	2098
30	91 - 93	917	1217	1788	2045	1873	2141
30	94 - 96	922	1224	1827	2087	1913	2186
36	22 - 24	393	503	846	977	887	1024
36	25 - 27	457	589	888	1024	931	1073
36	28 - 30	462	599	930	1070	975	1123
36	31 - 33	534	687	1010	1168	1058	1224
36	34 - 36	539	695	1051	1215	1102	1271
36	37 - 39	594	781	1093	1261	1146	1321
36	40 - 42	602	788	1154	1331	1210	1396
36	43 - 45	607	797	1196	1378	1254	1445
36	46 - 48	612	806	1240	1426	1299	1495
36	49 - 51	862	1133	1281	1472	1343	1542
36	52 - 54	867	1141	1361	1568	1427	1644
36	55 - 57	873	1150	1404	1615	1471	1693
36	58 - 60	879	1158	1445	1661	1514	1742
36	61 - 63	885	1167	1487	1709	1558	1791
36	64 - 66	890	1174	1567	1806	1641	1891
36	67 - 69	896	1182	1609	1852	1685	1940
36	70 - 72	902	1191	1652	1898	1731	1989
36	73 - 75	1007	1352	1694	1945	1774	2039
36	76 - 78	1014	1361	1736	1992	1819	2088
36	79 - 81	1019	1369	1779	2039	1862	2136
36	82 - 84	1025	1377	1875	2161	1964	2264
36	85 - 87	1031	1386	1919	2207	2009	2313
36	88 - 90	1038	1394	1961	2254	2052	2363
36	91 - 93	1043	1402	2002	2301	2097	2410
36	94 - 96	1049	1411	2045	2347	2141	2459

If Grommet is specified, add 35

UNWC

Rectangle with Radius Corners Worksurface

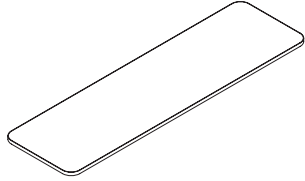

The Rectangle with Radius Corners Worksurface provides a range of depths to support both primary and secondary worksurface applications.

WHAT'S INCLUDED

1 worksurface, grommet (if specified).

NOTES

Worksurface is designed to accompany the District Infinity Curved Desk Edge Screen (GXCD).

Actual depth is 1" less than nominal depth to allow for a cable management gap at the back and to align with storage.

Actual width equals nominal width, allowance for gaps at side edges must be specified.

PRODUCT OPTIONS

Depth	Width (1" increments)	Corner Profile	Leg Style	Worksurface Finish	Edge Trim Style	Edge Trim Finish	Grommet Location (optional)	Grommet Finish (if applicable)
20, 24, 30, 36	48 - 96	F Four Round 3" Radius L Two Round Left 3" Radius R Two Round Right 3" Radius	K Leverage	Foundation Laminate Flintwood Natural Veneer	8 Flat (with Foundation) 9 Flat (with Flintwood and Natural Veneer) H Full Knife (with all)	Edge Trim Colors	1 Left 2 Centered 3 Right	7 Platinum V Very White P Espresso Q Storm White

SAMPLE ORDER CODE

UNWC 24	48	F	K	LW	8	ST	2	7
---------	----	---	---	----	---	----	---	---

DIMENSIONS – INCHES FOR MM X BY 25.4

D	W
20	48
20	49 - 51
20	52 - 54
20	55 - 57
20	58 - 60
20	61 - 63
20	64 - 66
20	67 - 69
20	70 - 72
20	73 - 75
20	76 - 78
20	79 - 81
20	82 - 84
20	85 - 87
20	88 - 90
20	91 - 93
20	94 - 96

PRICING

FOUNDATION LAMINATE		FLINTWOOD		NATURAL VENEER	
Flat Edge	Full Knife Edge	Flat Edge	Full Knife Edge	Flat Edge	Full Knife Edge
360	456	916	1051	961	1103
430	550	949	1087	994	1139
433	557	980	1122	1027	1175
436	562	1013	1156	1062	1211
441	568	1082	1240	1133	1300
445	574	1113	1275	1167	1335
450	581	1145	1309	1200	1371
453	586	1177	1343	1234	1407
457	591	1227	1402	1286	1470
608	808	1260	1436	1320	1505
611	813	1291	1471	1353	1542
614	820	1324	1505	1387	1579
619	826	1354	1540	1420	1614
624	832	1387	1573	1454	1650
628	838	1419	1608	1486	1685
631	845	1451	1643	1520	1721
635	850	1520	1726	1592	1810

If Grommet is specified, add 35

Pricing is continued on the following page.

UNWC

Rectangle with Radius Corners Worksurface (Continued)

DIMENSIONS – INCHES FOR MM X BY 25.4

PRICING

D	W	FOUNDATION LAMINATE		FLINTWOOD		NATURAL VENEER	
		Flat Edge	Full Knife Edge	Flat Edge	Full Knife Edge	Flat Edge	Full Knife Edge
24	48	411	530	1021	1177	1069	1234
24	49 - 51	537	695	1056	1215	1106	1274
24	52 - 54	542	702	1090	1252	1141	1312
24	55 - 57	545	709	1124	1288	1177	1351
24	58 - 60	551	715	1177	1352	1234	1416
24	61 - 63	556	722	1212	1389	1269	1456
24	64 - 66	559	729	1245	1427	1305	1496
24	67 - 69	563	736	1280	1463	1342	1534
24	70 - 72	568	741	1314	1502	1377	1573
24	73 - 75	623	826	1350	1539	1414	1613
24	76 - 78	628	833	1421	1627	1489	1704
24	79 - 81	631	839	1455	1662	1526	1743
24	82 - 84	635	846	1489	1702	1562	1783
24	85 - 87	639	853	1524	1738	1597	1822
24	88 - 90	644	859	1559	1776	1633	1861
24	91 - 93	649	866	1593	1812	1669	1899
24	94 - 96	654	873	1666	1900	1744	1992
30	48	451	578	1139	1313	1194	1377
30	49 - 51	553	716	1177	1355	1234	1421
30	52 - 54	558	723	1216	1397	1275	1464
30	55 - 57	563	732	1254	1439	1313	1508
30	58 - 60	568	738	1292	1482	1354	1553
30	61 - 63	573	746	1369	1574	1433	1650
30	64 - 66	580	755	1407	1616	1475	1694
30	67 - 69	584	761	1445	1658	1514	1737
30	70 - 72	588	767	1483	1700	1554	1782
30	73 - 75	887	1171	1522	1742	1593	1825
30	76 - 78	891	1179	1597	1834	1672	1922
30	79 - 81	897	1187	1635	1875	1713	1965
30	82 - 84	902	1194	1674	1918	1754	2010
30	85 - 87	908	1201	1712	1960	1793	2053
30	88 - 90	913	1210	1750	2002	1834	2098
30	91 - 93	917	1217	1788	2045	1873	2141
30	94 - 96	922	1224	1827	2087	1913	2186
36	48	612	806	1240	1426	1299	1495
36	49 - 51	862	1133	1281	1472	1343	1542
36	52 - 54	867	1141	1361	1568	1427	1644
36	55 - 57	873	1150	1404	1615	1471	1693
36	58 - 60	879	1158	1445	1661	1514	1742
36	61 - 63	885	1167	1487	1709	1558	1791
36	64 - 66	890	1174	1567	1806	1641	1891
36	67 - 69	896	1182	1609	1852	1685	1940
36	70 - 72	902	1191	1652	1898	1731	1989
36	73 - 75	1007	1352	1694	1945	1774	2039
36	76 - 78	1014	1361	1736	1992	1819	2088
36	79 - 81	1019	1369	1779	2039	1862	2136
36	82 - 84	1025	1377	1875	2161	1964	2264
36	85 - 87	1031	1386	1919	2207	2009	2313
36	88 - 90	1038	1394	1961	2254	2052	2363
36	91 - 93	1043	1402	2002	2301	2097	2410
36	94 - 96	1049	1411	2045	2347	2141	2459

If Grommet is specified, add 35

height-adjustability

height-adjustability product map

YAD Navigate Freestanding Table, Base Only

Page 666

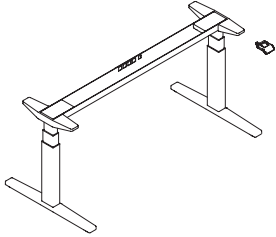

YHD Navigate Height-Adjustable Built-in Base - Parallel Planning

Page 670

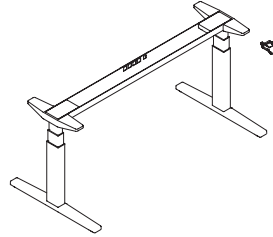

YGD Navigate Height-Adjustable Built-in Base - Perpendicular Planning

Page 672

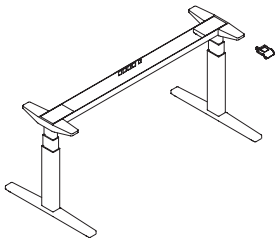

YWD Navigate Height-Adjustable Built-in Gable Base - Parallel Planning

Page 674

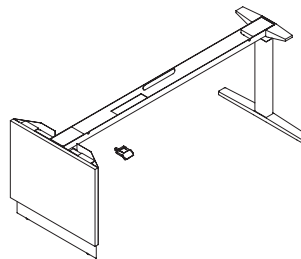

YVD Navigate Height-Adjustable Built-in Gable Base - Perpendicular Planning

Page 676

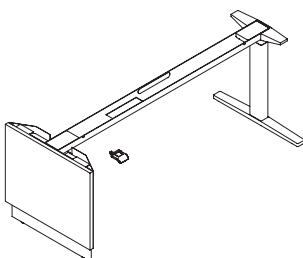

YSG hiSpace Quick Connect Height-Adjustable Built-in Base - Perpendicular Planning

Page 678

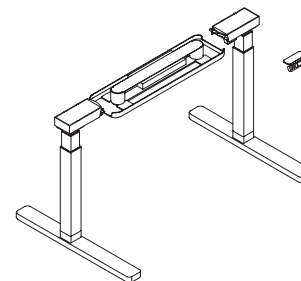

YSP hiSpace Quick Connect Height-Adjustable Built-in Base - Perpendicular Planning

Page 680

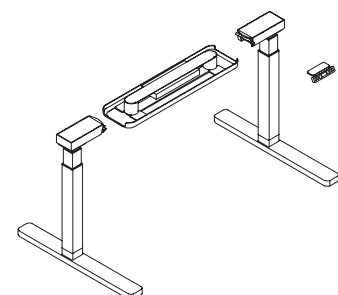

WHD Parallel Rectangular Height-Adjustable Built-in Worksurface, T-Legs

Page 682

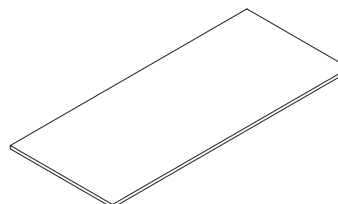

height-adjustability product map

WHD Parallel Rectangular Height-Adjustable Built-in Worksurface, Gable

Page 683

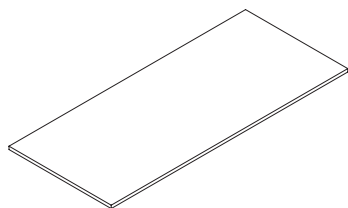

WLD Perpendicular Rectangular Height-Adjustable Built-in Worksurface, T-Legs

Page 684

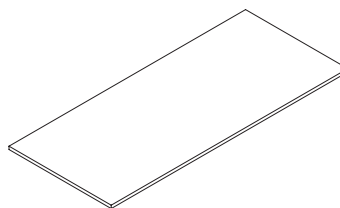

WLD Perpendicular Rectangular Height-Adjustable Built-in Worksurface, Gable

Page 685

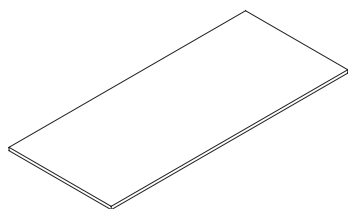

WBD Freestanding Table Rectangular Height-Adjustable Worksurface

Page 686

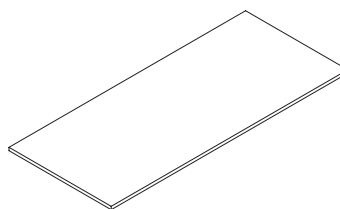

WMD Perpendicular Rectangular Height-Adjustable Built-in Worksurface with Radius Corners

Page 690

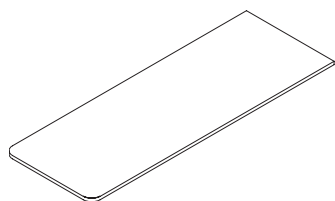

WBF hiSpace Parallel Rectangular Height-Adjustable Built-in Worksurface

Page 691

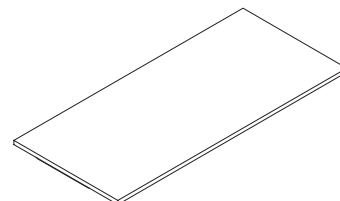

WBG hiSpace Perpendicular Rectangular Height-Adjustable Built-in Worksurface with connection kit for Quick Connect

Page 692

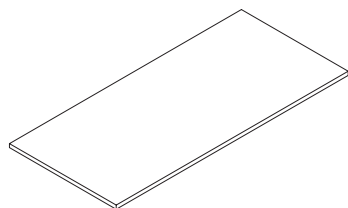

WJE hiSpace Rectangular Height-Adjustable Built-in Perpendicular Worksurface with Radius Corners

Page 693

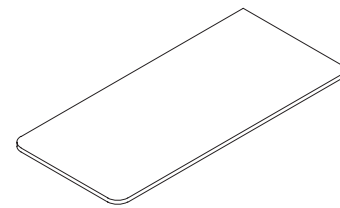

height-adjustability product map

UPPC Perpendicular Credenza for Height-Adjustable Table

Page 694

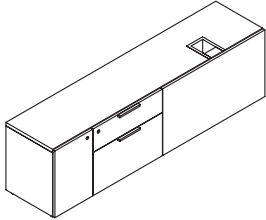

UPCS Shared Perpendicular Credenza for Height-Adjustable Table

Page 696

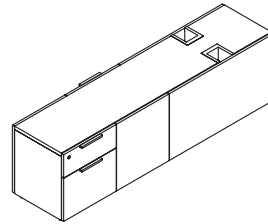

UPSC Parallel Spine Credenza for Height-Adjustable Table

Page 698

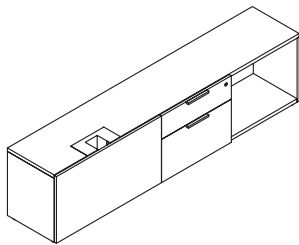

UPCC Parallel Corridor Credenza for Height-Adjustable Table

Page 700

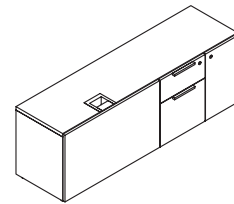

height-adjustability

Y A D

Navigate Freestanding Table, Base Only

One Table
One Plug

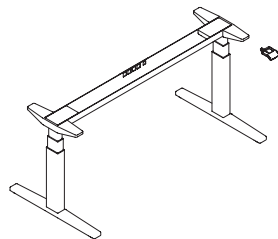

Navigate Freestanding Table Base Only to be used with Freestanding Table Rectangular Height-Adjustable Worksurface to create a Freestanding District specific height-adjustable table.

WHAT'S INCLUDED

1 Height-Adjustable base, leg and foot configuration as specified.

NOTES

Electric base mechanism has 0.1 Watt resting power draw and uses 120V North American control box.

Vertical Wire Carrier includes cross channel bracket and mounts into credenza.

The height-adjustable worksurface must be specified separately.

For Switch details, see the *Application Guide* section.

Cross Channel Integrated Powerbar option (C) includes 3 outlets + 1 IEC Connection. This IEC connection accepts only one IEC-compatible power accessory (with an IEC cord terminal) at a time.

Undersurface cable management option (5) - Dual Plastic Trays + Powerbar with IEC refers to a Power Rod (with IEC cord terminal) that must be plugged into the IEC connection of the Cross Channel Integrated Powerbar option (C).

For more information about the One Table One Plug electrical system, IEC-compatible power accessories and planning with IEC Connection, refer to Complements: Teknion's Ergonomics & Accessories Program.

PRODUCT OPTIONS

Leg Application	Base Mechanism	Actual Depth	Actual Width	Foot Style	Base Finish
CCC C-Legs	1S Counterbalance Standard (29.5" - 49.5")	23, 29, 35	45, 51, 57, 63, 69, 75, 81	1 Standard	Texture Foundation Mica Accent
TTT T-Leg	1X Counterbalance Lower Edition (26.5" - 43.5") 7S Standard Electric (27" - 43") 9C Extended Electric-Restricted (25" - 48.7") 9E Extended Electric-Extended (22.6" - 48.7")				Without Texture Foundation Mica Accent

SAMPLE ORDER CODE

YAD TTT	9C	29	57	1	52
----------------	-----------	-----------	-----------	----------	-----------

PRODUCT OPTIONS (CONTINUED)

Switch Style	Switch Finish	Powerbar	Undersurface Cable Management	Vertical Wire Carrier (optional)
S Standard Up/Down	E Ebony Coordinate	N None	N None	N None
D Display with Up/Down Memory	X Anthracite	I Cross Channel Integrated - 4 Outlets	1 Cable Organizer with Felt Cover	E Ebony Coordinate
T Toggle Up/Down	7 Platinum	C Cross Channel Integrated - 3 Outlets + 1 IEC	3 Dual Plastic Trays and Powerbar	7 Platinum Coordinate
X Display Toggle with Memory and Navigate GPS	6 Crisp Grey		4 Dual Plastic Trays	V Very White Coordinate
			5 Dual Plastic Trays+Powerbar with IEC	

SAMPLE ORDER CODE (CONTINUED)

X	X	I	1	E
----------	----------	----------	----------	----------

See pricing in the following page.

Navigate Freestanding Table, Base Only (Continued)

DIMENSIONS INCHES / MM

D	W
23 / 584	51 / 1294
23 / 584	57 / 1447
23 / 584	63 / 1600
23 / 584	69 / 1753
29 / 237	51 / 1294
29 / 237	57 / 1447
29 / 237	63 / 1600
29 / 237	69 / 1753

23 / 584	45 / 1143
23 / 584	51 / 1294
23 / 584	57 / 1447
23 / 584	63 / 1600
23 / 584	69 / 1753
23 / 584	75 / 1905
23 / 584	81 / 2057
29 / 237	45 / 1143
29 / 237	51 / 1294
29 / 237	57 / 1447
29 / 237	63 / 1600
29 / 237	69 / 1753
29 / 237	75 / 1905
29 / 237	81 / 2057
35 / 889	45 / 1143
35 / 889	51 / 1294
35 / 889	57 / 1447
35 / 889	63 / 1600
35 / 889	69 / 1753
35 / 889	75 / 1905
35 / 889	81 / 2057

PRICING

COUNTERBALANCE STANDARD / COUNTERBALANCE LOWER EDITION

Foundation	Mica/Accent
2781	2868
2781	2868
2812	2899
2812	2899
2781	2868
2781	2868
2812	2899
2812	2899

STANDARD ELECTRIC

Foundation	Mica/Accent
2781	2868
2781	2868
2781	2868
2812	2899
2812	2899
2812	2899
2812	2899
2781	2868
2781	2868
2781	2868
2812	2899
2812	2899
2812	2899
2812	2899
2781	2868
2781	2868
2781	2868
2812	2899
2812	2899
2812	2899
2812	2899

Pricing is continued on the following page

If Display with Up/Down Memory (D) switch is specified, add 153

If Display Toggle with Memory and Navigate GPS (X) switch is specified, add 153

If No Power Bar, Dual Plastic Trays are specified, add 49

If No Power Bar, Dual Plastic Trays + Powerbar are specified, add 236

If No Power Bar, Cable Organizer with Felt Cover is specified, add 242

If Cross Channel Integrated Powerbar - 4 Outlets (I) or 3 Outlets + 1 IEC (C) with No Cable Management is specified, add 205

If Cross Channel Integrated Powerbar - 4 Outlets (I) or 3 Outlets + 1 IEC (C) + Dual Plastic Trays are specified, add 255

If Cross Channel Integrated Powerbar - 4 Outlets (I) + Dual Plastic Trays + Powerbar are specified, add 442

If Cross Channel Integrated Powerbar - 3 Outlets + 1 IEC (C) + Dual Plastic Trays + Powerbar with IEC are specified, add 502

If Cross Channel Integrated Powerbar - 4 Outlets (I) or 3 Outlets + 1 IEC (C) + Cable Organizer with Felt Cover are specified, add 449

If Vertical Wire Carrier is specified, add 277

Y A D

Navigate Freestanding Table, Base Only (Continued)

DIMENSIONS INCHES / MM

D	W
23 / 584	45 / 1143
23 / 584	51 / 1294
23 / 584	57 / 1447
23 / 584	63 / 1600
23 / 584	69 / 1753
23 / 584	75 / 1905
23 / 584	81 / 2057
29 / 237	45 / 1143
29 / 237	51 / 1294
29 / 237	57 / 1447
29 / 237	63 / 1600
29 / 237	69 / 1753
29 / 237	75 / 1905
29 / 237	81 / 2057
35 / 889	45 / 1143
35 / 889	51 / 1294
35 / 889	57 / 1447
35 / 889	63 / 1600
35 / 889	69 / 1753
35 / 889	75 / 1905
35 / 889	81 / 2057

PRICING

EXTENDED ELECTRIC-RESTRICTED / EXTENDED ELECTRIC-RESTRICTED

Foundation	Mica/Accent
2970	3057
2970	3057
2970	3057
2981	3069
2981	3069
2981	3069
2981	3069
2970	3057
2970	3057
2970	3057
2981	3069
2981	3069
2981	3069
2981	3069
2970	3057
2970	3057
2970	3057
2981	3069
2981	3069
2981	3069
2981	3069

If Display with Up/Down Memory (D) switch is specified, add 153

If Display Toggle with Memory and Navigate GPS (X) switch is specified, add 153

If No Power Bar, Dual Plastic Trays are specified, add 49

If No Power Bar, Dual Plastic Trays + Powerbar are specified, add 236

If No Power Bar, Cable Organizer with Felt Cover is specified, add 242

If Cross Channel Integrated Powerbar - 4 Outlets (I) or 3 Outlets + 1 IEC (C) with No Cable Management is specified, add 205

If Cross Channel Integrated Powerbar - 4 Outlets (I) or 3 Outlets + 1 IEC (C) + Dual Plastic Trays are specified, add 255

If Cross Channel Integrated Powerbar - 4 Outlets (I) + Dual Plastic Trays + Powerbar are specified, add 442

If Cross Channel Integrated Powerbar - 3 Outlets + 1 IEC (C) + Dual Plastic Trays + Powerbar with IEC are specified, add 502

If Cross Channel Integrated Powerbar - 4 Outlets (I) or 3 Outlets + 1 IEC (C) + Cable Organizer with Felt Cover are specified, add 449

If Vertical Wire Carrier is specified, add 277

height-adjustability

Y H D

Navigate Height-Adjustable Built-in Base - Parallel Planning

One Table
One Plug

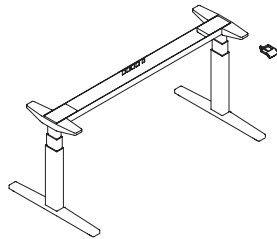

Navigate Height-Adjustable Built-in Base - Parallel Planning is to be paired with Parallel Rectangular Height-Adjustable Built-in Worksurface, T-Legs, to create a District specific integrated height-adjustable table supporting parallel planning.

WHAT'S INCLUDED

1 Height-Adjustable base, leg and foot configuration as specified.

NOTES

Electric base mechanism has 0.1 Watt resting power draw and uses 120V North American control box.

Vertical Wire Carrier includes cross channel bracket and mounts into credenza.

The height-adjustable worksurface must be specified separately.

For Switch details, see the *Application Guide* section.

Cross Channel Integrated Powerbar option (C) includes 3 outlets + 1 IEC Connection. This IEC connection accepts only one IEC-compatible power accessory (with an IEC cord terminal) at a time.

Undersurface cable management option (5) - Dual Plastic Trays + Powerbar with IEC refers to a Power Rod (with IEC cord terminal) that must be plugged into the IEC connection of the Cross Channel Integrated Powerbar option (C).

For more information about the One Table One Plug electrical system, IEC-compatible power accessories and planning with IEC Connection, refer to Complements: *Teknion's Ergonomics & Accessories Program*.

PRODUCT OPTIONS

Leg Application	Base Mechanism	Actual Depth	Actual Width	Foot Style	Base Finish
TZL Left in Perpendicular Credenza, Right toward Middle	7S Standard Electric (27" - 43")	29	52, 58, 64, 70, 76, 82	1 Standard	Foundation Mica Accent
TZR Right in Perpendicular Credenza, Left toward Middle					
TDL Left toward outside, Right in Shared Perpendicular Credenza	9C Extended Electric-Restricted (25" - 48.7")				
TDR Right toward outside, Left in Shared Perpendicular Credenza					
THL Left in Perpendicular Credenza, Right in Shared Perpendicular Credenza					
THR Right in Perpendicular Credenza, Left in Shared Perpendicular Credenza					

SAMPLE ORDER CODE

YHD TZL	9C	29	58	1	52
----------------	-----------	-----------	-----------	----------	-----------

PRODUCT OPTIONS (CONTINUED)

Switch Style	Switch Finish	Powerbar	Undersurface Cable Management	Vertical Wire Carrier (optional)
S Standard Up/Down	E Ebony Coordinate	N None	N None	N None
D Display with Up/Down Memory	X Anthracite	I Cross Channel Integrated - 4 Outlets	1 Cable Organizer with Felt Cover	E Ebony Coordinate
T Toggle Up/Down	7 Platinum	C Cross Channel Integrated - 3 Outlets + 1 IEC	3 Dual Plastic Trays and Powerbar	7 Platinum Coordinate
X Display Toggle with Memory and Navigate GPS	6 Crisp Grey		4 Dual Plastic Trays	V Very White Coordinate
			5 Dual Plastic Trays+Powerbar with IEC	

SAMPLE ORDER CODE (CONTINUED)

X	X	I	1	E
----------	----------	----------	----------	----------

See pricing in the following page.

YHD

**Navigate Height-Adjustable
Built-in Base - Parallel Planning
(Continued)**

**DIMENSIONS
INCHES / MM**

D	W
29 / 237	52 / 1321
29 / 237	58 / 1473
29 / 237	64 / 1626
29 / 237	70 / 1778
29 / 237	76 / 1930
29 / 237	82 / 2083

PRICING

STANDARD ELECTRIC

Foundation	Mica/Accent
2781	2868
2781	2868
2812	2899
2812	2899
2812	2899
2812	2899

EXTENDED ELECTRIC-RESTRICTED

Foundation	Mica/Accent
2970	3057
2970	3057
2981	3069
2981	3069
2981	3069
2981	3069

- If Display with Up/Down Memory (D) switch is specified, add 153
- If Display Toggle with Memory and Navigate GPS (X) switch is specified, add 153
- If No Power Bar, Dual Plastic Trays are specified, add 49
- If No Power Bar, Dual Plastic Trays + Powerbar are specified, add 236
- If No Power Bar, Cable Organizer with Felt Cover is specified, add 242
- If Cross Channel Integrated Powerbar - 4 Outlets (I) or 3 Outlets + 1 IEC (C) with No Cable Management is specified, add 205
- If Cross Channel Integrated Powerbar - 4 Outlets (I) or 3 Outlets + 1 IEC (C) + Dual Plastic Trays are specified, add 255
- If Cross Channel Integrated Powerbar - 4 Outlets (I) + Dual Plastic Trays + Powerbar are specified, add 442
- If Cross Channel Integrated Powerbar - 3 Outlets + 1 IEC (C) + Dual Plastic Trays + Powerbar with IEC are specified, add 502
- If Cross Channel Integrated Powerbar - 4 Outlets (I) or 3 Outlets + 1 IEC (C) + Cable Organizer with Felt Cover are specified, add 449
- If Vertical Wire Carrier is specified, add 277

Y G D

Navigate Height-Adjustable Built-in Base - Perpendicular Planning

One Table
One Plug

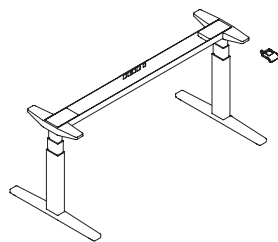

Navigate Height-Adjustable Built-in Base - Perpendicular Planning is to be paired with Perpendicular Rectangular Height-Adjustable Built-in Worksurface, T-Legs, to create a District specific height-adjustable table supporting perpendicular planning.

WHAT'S INCLUDED

1 Height-Adjustable base, leg and foot configuration as specified.

NOTES

Electric base mechanism has 0.1 Watt resting power draw and uses 120V North American control box.

Vertical Wire Carrier includes cross channel bracket and mounts into credenza.

The height-adjustable worksurface must be specified separately.

For Switch details, see the *Application Guide* section.

Cross Channel Integrated Powerbar option (C) includes 3 outlets + 1 IEC Connection. This IEC connection accepts only one IEC-compatible power accessory (with an IEC cord terminal) at a time.

Undersurface cable management option (5) - Dual Plastic Trays + Powerbar with IEC refers to a Power Rod (with IEC cord terminal) that must be plugged into the IEC connection of the Cross Channel Integrated Powerbar option (C).

For more information about the One Table One Plug electrical system, IEC-compatible power accessories and planning with IEC Connection, refer to Complements: *Teknion's Ergonomics & Accessories Program*.

PRODUCT OPTIONS

Leg Application	Base Mechanism	Actual Depth	Actual Width	Foot Style	Base Finish
TSL Left in Corridor, Right in Parallel Spine Credenza	7S Standard Electric (27" - 43")	30	65, 71, 77, 83	1 Standard	Foundation Mica Accent
TSR Right in Corridor, Left in Parallel Spine Credenza					
TCL Left in Parallel Corridor Credenza, Right in alignment panel	9C Extended Electric-Restricted (25" - 48.7")				
TCR Right in Parallel Corridor Credenza, Left in alignment panel					
TBL Left in Parallel Corridor Credenza, Right in Parallel Spine Credenza					
TBR Right in Parallel Corridor Credenza, Left in Parallel Spine Credenza					

SAMPLE ORDER CODE

YGD TCL	9C	30	65	1	52
----------------	-----------	-----------	-----------	----------	-----------

PRODUCT OPTIONS (CONTINUED)

Switch Style	Switch Finish	Powerbar	Undersurface Cable Management	Vertical Wire Carrier (optional)
S Standard Up/Down	E Ebony Coordinate	N None	N None	N None
D Display with Up/Down Memory	X Anthracite	I Cross Channel Integrated - 4 Outlets	1 Cable Organizer with Felt Cover	E Ebony Coordinate
T Toggle Up/Down	7 Platinum	C Cross Channel Integrated - 3 Outlets + 1 IEC	3 Dual Plastic Trays+Powerbar	7 Platinum Coordinate
X Display Toggle with Memory and Navigate GPS	6 Crisp Grey		4 Dual Plastic Trays	V Very White Coordinate
			5 Dual Plastic Trays+Powerbar with IEC	

SAMPLE ORDER CODE (CONTINUED)

X	X	I	1	E
----------	----------	----------	----------	----------

See pricing in the following page.

Y G D

**Navigate Height-Adjustable
Built-in Base - Perpendicular
Planning (Continued)**

**DIMENSIONS
INCHES / MM**

D	W
30 / 762	65 / 1651
30 / 762	71 / 1803
30 / 762	77 / 1956
30 / 762	83 / 2108

PRICING

STANDARD ELECTRIC

Foundation	Mica/Accent
2812	2899
2812	2899
2812	2899
2812	2899

EXTENDED ELECTRIC-RESTRICTED

Foundation	Mica/Accent
2981	3069
2981	3069
2981	3069
2981	3069

- If Display with Up/Down Memory (D) switch is specified, add 153
- If Display Toggle with Memory and Navigate GPS (X) switch is specified, add 153
- If No Power Bar, Dual Plastic Trays are specified, add 49
- If No Power Bar, Dual Plastic Trays + Powerbar are specified, add 236
- If No Power Bar, Cable Organizer with Felt Cover is specified, add 242
- If Cross Channel Integrated Powerbar - 4 Outlets (I) or 3 Outlets + 1 IEC (C) with No Cable Management is specified, add 205
- If Cross Channel Integrated Powerbar - 4 Outlets (I) or 3 Outlets + 1 IEC (C) + Dual Plastic Trays are specified, add 255
- If Cross Channel Integrated Powerbar - 4 Outlets (I) + Dual Plastic Trays + Powerbar are specified, add 442
- If Cross Channel Integrated Powerbar - 3 Outlets + 1 IEC (C) + Dual Plastic Trays + Powerbar with IEC are specified, add 502
- If Cross Channel Integrated Powerbar - 4 Outlets (I) or 3 Outlets + 1 IEC (C) + Cable Organizer with Felt Cover are specified, add 449
- If Vertical Wire Carrier is specified, add 277

YWD

Navigate Height-Adjustable Built-in Gable Base - Parallel Planning

One Table
One Plug

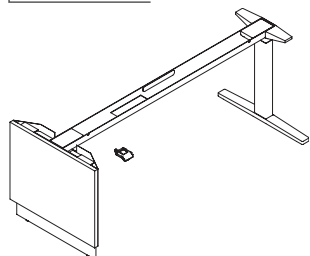

Navigate Height-Adjustable Built-in Gable Base - Parallel Planning is to be paired with Parallel Rectangular Height-Adjustable Built-in Worksurface, Gable, to create a District specific gable leg integrated height-adjustable table supporting parallel planning.

WHAT'S INCLUDED

1 Height-Adjustable base, leg and foot configuration as specified.

NOTES

Electric base mechanism has 0.1 Watt resting power draw and uses 120V North American control box.

Vertical Wire Carrier includes cross channel bracket and mounts into credenza.

The height-adjustable worksurface must be specified separately.

For Switch details, see the *Application Guide* section.

Cross Channel Integrated Powerbar option (C) includes 3 outlets + 1 IEC Connection. This IEC connection accepts only one IEC-compatible power accessory (with an IEC cord terminal) at a time.

Undersurface cable management option (5) - Dual Plastic Trays + Powerbar with IEC refers to a Power Rod (with IEC cord terminal) that must be plugged into the IEC connection of the Cross Channel Integrated Powerbar option (C).

For more information about the One Table One Plug electrical system, IEC-compatible power accessories and planning with IEC Connection, refer to Complements: *Teknion's Ergonomics & Accessories Program*.

PRODUCT OPTIONS

Leg Application	Base Mechanism	Actual Depth	Actual Width	Base Finish	Water Fall Finish
GZL Left in Perpendicular Credenza, Gable toward Middle	7S Standard Electric (27" - 43") 9C Extended Electric-Restricted (25" - 48.7")	29	46, 52, 58, 64, 70, 76, 82	Foundation	Foundation
GZR Right in Perpendicular Credenza, Gable toward Middle				Mica	Flintwood
GDL Left Gable toward outside, Right T-Leg in Shared Perpendicular Credenza				Accent	Natural Veneer
GDR Right Gable toward outside, Left T-Leg in Shared Perpendicular Credenza					

SAMPLE ORDER CODE

YWD GZL	9C	29	58	52	VZ
----------------	-----------	-----------	-----------	-----------	-----------

PRODUCT OPTIONS (CONTINUED)

Switch Style	Switch Finish	Powerbar	Undersurface Cable Management	Vertical Wire Carrier (optional)
S Standard Up/Down	E Ebony Coordinate	N None	N None	N None
D Display with Up/Down Memory	X Anthracite	I Cross Channel Integrated - 4 Outlets	1 Cable Organizer with Felt Cover	E Ebony Coordinate
T Toggle Up/Down	7 Platinum	C Cross Channel Integrated - 3 Outlets + 1 IEC	3 Dual Plastic Trays and Powerbar	7 Platinum Coordinate
X Display Toggle with Memory and Navigate GPS	6 Crisp Grey		4 Dual Plastic Trays	V Very White Coordinate
			5 Dual Plastic Trays+Powerbar with IEC	

SAMPLE ORDER CODE (CONTINUED)

X	X	I	1	N
----------	----------	----------	----------	----------

See pricing in the following page.

Y W D

Navigate Height-Adjustable Built-in Gable Base - Parallel Planning (Continued)

DIMENSIONS INCHES / MM

D	W
29 / 737	46 / 1168
29 / 737	52 / 1321
29 / 737	58 / 1473
29 / 737	64 / 1626
29 / 737	70 / 1778
29 / 737	76 / 1930
29 / 737	82 / 2083

29 / 737	46 / 1168
29 / 737	52 / 1321
29 / 737	58 / 1473
29 / 737	64 / 1626
29 / 737	70 / 1778
29 / 737	76 / 1930
29 / 737	82 / 2083

PRICING

STANDARD ELECTRIC

Foundation	Mica/Accent
4097	4185
4146	4234
4174	4262
4240	4327
4275	4363
4017	4106
4043	4132

EXTENDED ELECTRIC-RESTRICTED

Foundation	Mica/Accent
4425	4513
4476	4564
4508	4594
4541	4628
4577	4665
4324	4412
4352	4440

If Flintwood Water Fall Finish is specified,

46" Width	689
52" Width	658
58" Width	723
64" Width	828
70" Width	895
76" Width	706
82" Width	771

If Natural Veneer Water Fall Finish is specified,

46" Width	744
52" Width	716
58" Width	786
64" Width	895
70" Width	965
76" Width	782
82" Width	850

If Display with Up/Down Memory (D) switch is specified, add 153

If Display Toggle with Memory and Navigate GPS (X) switch is specified, add 153

If No Power Bar, Dual Plastic Trays are specified, add 49

If No Power Bar, Dual Plastic Trays + Powerbar are specified, add 236

If No Power Bar, Cable Organizer with Felt Cover is specified, add 242

If Cross Channel Integrated Powerbar - 4 Outlets (I) or 3 Outlets + 1 IEC (C) with No Cable Management is specified, add 205

If Cross Channel Integrated Powerbar - 4 Outlets (I) or 3 Outlets + 1 IEC (C) + Dual Plastic Trays are specified, add 255

If Cross Channel Integrated Powerbar - 4 Outlets (I) + Dual Plastic Trays + Powerbar are specified, add 442

If Cross Channel Integrated Powerbar - 3 Outlets + 1 IEC (C) + Dual Plastic Trays + Powerbar with IEC are specified, add 502

If Cross Channel Integrated Powerbar - 4 Outlets (I) or 3 Outlets + 1 IEC (C) + Cable Organizer with Felt Cover are specified, add 449

If Vertical Wire Carrier is specified, add 277

YVD

Navigate Height-Adjustable Built-in Gable Base - Perpendicular Planning

One Table
One Plug

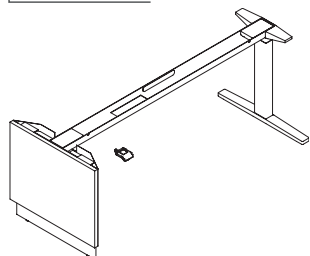

Navigate Height-Adjustable Built-in Gable Base - Perpendicular Planning is to be paired with Perpendicular Rectangular Height-Adjustable Built-in Worksurface, Gable, to create a District specific height-adjustable table supporting perpendicular planning.

WHAT'S INCLUDED

1 Height-Adjustable base, leg and foot configuration as specified.

NOTES

Electric base mechanism has 0.1 Watt resting power draw and uses 120V North American control box.

Vertical Wire Carrier includes cross channel bracket and mounts into credenza.

The height-adjustable worksurface must be specified separately.

For Switch details, see the *Application Guide* section.

Cross Channel Integrated Powerbar option (C) includes 3 outlets + 1 IEC Connection. This IEC connection accepts only one IEC-compatible power accessory (with an IEC cord terminal) at a time.

Undersurface cable management option (5) - Dual Plastic Trays + Powerbar with IEC refers to a Power Rod (with IEC cord terminal) that must be plugged into the IEC connection of the Cross Channel Integrated Powerbar option (C).

For more information about the One Table One Plug electrical system, IEC-compatible power accessories and planning with IEC Connection, refer to Complements: *Teknion's Ergonomics & Accessories Program*.

PRODUCT OPTIONS

Leg Application	Base Mechanism	Actual Depth	Actual Width	Base Finish	Water Fall Finish
GSL Left Gable alignment Corridor, Right in Parallel Spine Credenza	7S Standard Electric (27" - 43")	30	53, 59, 65, 71, 77, 83	Foundation	Foundation
GSR Right Gable alignment Corridor, Left in Parallel Spine Credenza	9C Extended Electric-Restricted (25" - 48.7")			Mica Accent	Flintwood Natural Veneer

SAMPLE ORDER CODE

YVD GSL	9C	30	53	52	VZ
----------------	-----------	-----------	-----------	-----------	-----------

PRODUCT OPTIONS (CONTINUED)

Switch Style	Switch Finish	Powerbar	Undersurface Cable Management	Vertical Wire Carrier (optional)
S Standard Up/Down	E Ebony Coordinate	N None	N None	N None
D Display with Up/Down Memory	X Anthracite	I Cross Channel Integrated - 4 Outlets	1 Cable Organizer with Felt Cover	E Ebony Coordinate
T Toggle Up/Down	7 Platinum	C Cross Channel Integrated - 3 Outlets + 1 IEC	3 Dual Plastic Trays and Powerbar	7 Platinum Coordinate
X Display Toggle with Memory and Navigate GPS	6 Crisp Grey		4 Dual Plastic Trays	V Very White Coordinate
			5 Dual Plastic Trays+Powerbar with IEC	

SAMPLE ORDER CODE (CONTINUED)

X	X	I	1	E
----------	----------	----------	----------	----------

See pricing in the following page.

**Navigate Height-Adjustable
Built-in Gable Base - Perpendicular
Planning (Continued)**

**DIMENSIONS
INCHES / MM**

D	W
30 / 762	53 / 1346
30 / 762	59 / 1499
30 / 762	65 / 1651
30 / 762	71 / 1803
30 / 762	75 / 1905
30 / 762	83 / 2108

PRICING

STANDARD ELECTRIC

Foundation	Mica/Accent
4146	4234
4174	4262
4240	4327
4275	4363
4017	4106
4043	4132

EXTENDED ELECTRIC-RESTRICTED

Foundation	Mica/Accent
4476	4564
4508	4594
4541	4628
4577	4665
4324	4412
4352	4440

If Flintwood Water Fall Finish is specified,

53" Width	658
59" Width	723
65" Width	828
71" Width	897
75" Width	706
83" Width	771

If Natural Veneer Water Fall Finish is specified,

53" Width	716
59" Width	786
65" Width	895
71" Width	965
75" Width	782
83" Width	850

If Display with Up/Down Memory (D) switch is specified, add 153

If Display Toggle with Memory and Navigate GPS (X) switch is specified, add 153

If No Power Bar, Dual Plastic Trays are specified, add 49

If No Power Bar, Dual Plastic Trays + Powerbar are specified, add 236

If No Power Bar, Cable Organizer with Felt Cover is specified, add 242

If Cross Channel Integrated Powerbar - 4 Outlets (I) or 3 Outlets + 1 IEC (C) with No Cable Management is specified, add 205

If Cross Channel Integrated Powerbar - 4 Outlets (I) or 3 Outlets + 1 IEC (C) + Dual Plastic Trays are specified, add 255

If Cross Channel Integrated Powerbar - 4 Outlets (I) + Dual Plastic Trays + Powerbar are specified, add 442

If Cross Channel Integrated Powerbar - 3 Outlets + 1 IEC (C) + Dual Plastic Trays + Powerbar with IEC are specified, add 502

If Cross Channel Integrated Powerbar - 4 Outlets (I) or 3 Outlets + 1 IEC (C) + Cable Organizer with Felt Cover are specified, add 449

If Vertical Wire Carrier is specified, add 277

height-adjustability

Y S G

hiSpace Quick Connect Height-Adjustable Built-in Base - Perpendicular Planning

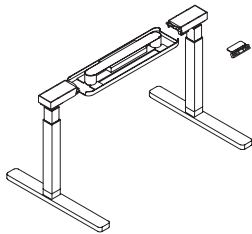

hiSpace Height-Adjustable Built-in Base - Perpendicular Planning is to be paired with hiSpace Height-Adjustable Built-In Base (YSU) to create an upStage specific integrated Height-Adjustable table to create a District specific height-adjustable table supporting perpendicular planning.

WHAT'S INCLUDED

Meets ANSI/BIFMA testing requirements height-adjustment range from 25" to 51 1/10" from the top of a 1" thick worksurface Includes a 240V universal control box Standby power consumption of 0.2W Power cord is 15' long.

WHAT'S EXCLUDED

HA worksurface WBG perpendicular not included.

NOTES

Meets ANSI/BIFMA testing requirements height-adjustment range from 25" to 51 1/10" from the top of a 1" thick worksurface Includes a 240V universal control box Standby power consumption of 0.2W Power cord is 15' long.

PRODUCT OPTIONS

Leg Application	Base Mechanism	Actual Depth	Actual Width
TSL Left in Corridor, Right in Parallel Spine Credenza	9U Extended Electricwith Riser (25"-51.1")	30	65, 71
TSR Right in Corridor, Left in Parallel Spine Credenza			
TCL Left in Parallel Corridor Credenza, Right alignment panel			
TCR Right in Parallel Corridor Credenza, Left alignment panel			
TBL Left in Parallel Corridor Credenza, Right in Parallel Spine Credenza			
TBR Right in Parallel Corridor Credenza, Left in Parallel Spine Credenza			

SAMPLE ORDER CODE

YSG TCL	9U	30	65
----------------	-----------	-----------	-----------

PRODUCT OPTIONS (CONTINUED)

Base Finish	Swith Style	Undersurface Cable Management	Vertical Wire Carrier	Vertical Wire Carrier Finish
60 Platinum	D Display with Up/Down Memory	N None	N None	E Ebony Coordinate
83 VeryWhite		1 Cable Organizer with Felt Cover	7 With Vertical Wire Carriere	7 Platinum Coordinate
52 Ebony		3 Dual Plastic Trays + Powerbar	E Ebony Coordinate	V Very White Coordinate
		4 Dual Plastic Trays	7 Platinum Coordinate	
			V Very White Coordinate	

SAMPLE ORDER CODE (CONTINUED)

52	D	1	N	7
-----------	----------	----------	----------	----------

See pricing in the following page.

Y S G

**hiSpace Quick Connect HA Built-in
Base - Perpendicular Planning
(Continued)**

PRICING

Cable Management, None (N)	Cable Organizer with Felt Cover (1)	Dual Plastic Trays + Powerbar (3)	Dual Plastic Trays (4)
1700	1941	1937	1748

If Vertical Wire Carrier is specified, add 277

height-adjustability

Y S P

hiSpace Height-Adjustable Built-in Base - Parallel Planning for Quick Connect

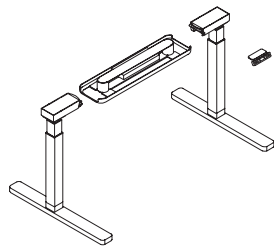

hiSpace Height-Adjustable Built-in Base - Parallel Planning is to be paired with hiSpace Height-Adjustable Built-In Base (YSU) to create an upStage specific integrated Height-Adjustable table to create a District specific height-adjustable table supporting parallel planning.

WHAT'S INCLUDED

Meets ANSI/BIFMA testing requirements height-adjustment range from 25" to 51-1/10" from the top of a 1" thick worksurface Includes a 240V universal control box Standby power consumption of 0.2W Power cord is 15' long.

WHAT'S EXCLUDED

HA worksurface WBF parallel not included.

NOTES

Meets ANSI/BIFMA testing requirements height-adjustment range from 25" to 51-1/10" from the top of a 1" thick worksurface Includes a 240V universal control box Standby power consumption of 0.2W Power cord is 15' long.

PRODUCT OPTIONS

Leg Application	Base Mechanism	Actual Depth	Actual Width
TZL Left in Perpendicular Credenza, Right toward Middle	9U Extended Electricwith Riser (25"-51.1")	29	52, 58, 64, 70
TZR Right in Perpendicular Credenza, Left toward Middle			
TDL Left toward outside, Right in Shared Perpendicular Credenza			
TDR Right toward outside, Left in Shared Perpendicular Credenza			
THL Left in Perpendicular Credenza, Right in Shared Perpendicular Credenza			
THR Right in Perpendicular Credenza, Left in Shared Perpendicular Credenza			

SAMPLE ORDER CODE

YSP TZL	9U	29	58
----------------	-----------	-----------	-----------

PRODUCT OPTIONS (CONTINUED)

Base Finish	Swith Style	Undersurface Cable Management	Vertical Wire Carrier	Vertical Wire Carrier Finish
60 Platinum	D Display with Up/Down Memory	N None	N None	E Ebony
83 VeryWhite		1 Cable Organizer with Felt Cover	7 With Vertical Wire Carriere	7 Platinum Coordinate
52 Ebony		3 Dual PlasticTrays + Powerbar	E Ebony	V Very White Coordinate
		4 Dual Plastic Trays	7 Platinum Coordinate	
			V Very White Coordinate	

SAMPLE ORDER CODE (CONTINUED)

52	D	1	N	7
-----------	----------	----------	----------	----------

See pricing in the following page.

Y S P

**hiSpace Height-Adjustable Built-in
Base - Parallel Planning for Quick
Connect (Continued)**

PRICING

Cable Management, None (N)	Cable Organizer with Felt Cover (1)	Dual Plastic Trays + Powerbar (3)	Dual Plastic Trays (4)
1700	1941	1937	1748

If Vertical Wire Carrier is specified, add 277

height-adjustability

W H D

Parallel Rectangular Height-Adjustable Built-in Worksurface, T-Legs

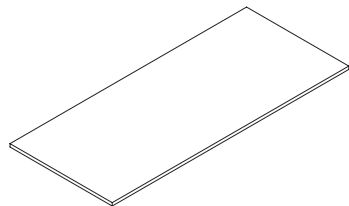

Parallel Rectangular Height-Adjustable Built-in Worksurface, T-Legs, is to be paired with Navigate Navigate Height-Adjustable Built-in Base - Parallel Planning to create a District specific gable leg integrated height-adjustable table supporting parallel planning.

WHAT'S INCLUDED

1 worksurface with cut out (if specified).

WHAT'S EXCLUDED

Base and grommet to be ordered separately.

NOTES

Worksurfaces only include a cut out when cut out style and location are specified.

Diecast grommet (UNDG- District, YEDG - Complements) must be ordered separately.

PRODUCT OPTIONS

Leg Application	Base Mechanism	Actual Depth	Actual Width	Cut Out Style
TZL Left in Perpendicular Credenza, Right toward Middle	7S Standard Electric (27" - 43") 9C Extended Electric-Restricted (25" - 48.7")	29	52, 58, 64, 70, 76, 82	N None
TZR Right in Perpendicular Credenza, Left toward Middle				G Round
TDL Left toward outside, Right in Shared Perpendicular Credenza				
TDR Right toward outside, Left in Shared Perpendicular Credenza				
THL Left in Perpendicular Credenza, Right in Shared Perpendicular Credenza				
THR Right in Perpendicular Credenza, Left in Shared Perpendicular Credenza				

SAMPLE ORDER CODE

WHD TZL	7S	29	70	G
----------------	-----------	-----------	-----------	----------

PRODUCT OPTIONS (CONTINUED)

Cut Out Location	Surface Finish	Edge Trim	Edge Trim Finish
N None	Foundation Laminate Flintwood Natural Veneer	8 Flat (with Foundation)	Edge Trim Colors
C Center		9 Flat (with Flintwood and Natural Veneer)	
L Left			
R Right		H Full Knife (with all)	

SAMPLE ORDER CODE (CONTINUED)

C	LW	8	ST
----------	-----------	----------	-----------

DIMENSIONS INCHES / MM

D	W
29 / 737	52 / 1321
29 / 737	58 / 1473
29 / 737	64 / 1626
29 / 737	70 / 1778
29 / 737	76 / 1930
29 / 737	82 / 2083

PRICING

FOUNDATION LAMINATE		FLINTWOOD		NATURAL VENEER	
Flat Edge	Full Knife Edge	Flat Edge	Full Knife Edge	Flat Edge	Full Knife Edge
558	723	1216	1397	1275	1464
568	738	1292	1482	1354	1553
580	755	1407	1616	1475	1694
588	767	1483	1700	1554	1782
891	1179	1597	1834	1672	1922
902	1194	1674	1918	1754	2010

If Cut Out is specified, add 37

Parallel Rectangular Height-Adjustable Built-in Worksurface, Gable, is to be paired with Navigate Height-Adjustable Built-in Gable Base - Parallel Planning to create a District specific gable leg integrated height-adjustable table supporting parallel planning.

WHAT'S INCLUDED

1 worksurface with cut out (if specified).

WHAT'S EXCLUDED

Base and grommet to be ordered separately.

NOTES

Worksurfaces only include a cut out when cut out style and location are specified.

Diecast grommet (UNDG- District, YEDG - Complements) must be ordered separately.

W H D _ Parallel Rectangular Height- Adjustable Built-in Worksurface, Gable

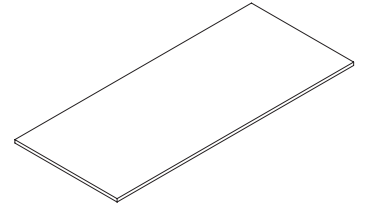

PRODUCT OPTIONS

Leg Application	Base Mechanism	Actual Depth	Actual Width	Cut Out Style
GZL Left T in Perpendicular Credenza, Gable toward Middle	7S Standard Electric (27" - 43") 9C Extended Electric-Restricted (25" - 48.7")	29	46, 52, 58, 64, 70, 76, 82	N None G Round
GZR Right T in Perpendicular Credenza, Gable toward Middle				
GDL Left Gable toward outside, Right T-Leg in Shared Perpendicular Credenza				
GDR Right Gable toward outside, Left T-Leg in Shared Perpendicular Credenza				

SAMPLE ORDER CODE

WHD_ GZL	7S	29	70	G
-----------------	-----------	-----------	-----------	----------

PRODUCT OPTIONS (CONTINUED)

Cut Out Location	Surface Finish	Edge Trim	Edge Trim Finish
N None	Foundation Laminate Flintwood Natural Veneer	8 Flat (with Foundation) 9 Flat (with Flintwood and Natural Veneer)	Edge Trim Colors
C Center			
L Left			
R Right			

SAMPLE ORDER CODE (CONTINUED)

C	LW	8	ST
----------	-----------	----------	-----------

DIMENSIONS INCHES / MM

D	W
29 / 737	46 / 1168
29 / 737	52 / 1321
29 / 737	58 / 1473
29 / 737	64 / 1626
29 / 737	70 / 1778
29 / 737	76 / 1930
29 / 737	82 / 2083

PRICING

FOUNDATION LAMINATE	FLINTWOOD	NATURAL VENEER
Flat Edge	Flat Edge	Flat Edge
451	1139	1194
558	1216	1275
568	1292	1354
580	1407	1475
588	1483	1554
891	1597	1672
902	1674	1754

If Cut Out is specified, add 37

W L D

Perpendicular Rectangular Height-Adjustable Built-in Worksurface, T-Legs

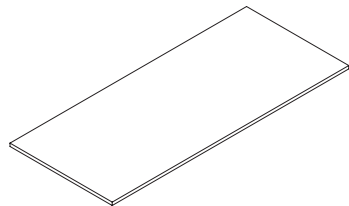

Perpendicular Rectangular Height-Adjustable Built-in Worksurface, T-Legs, is to be paired with Navigate Height-Adjustable Built-in Base - Perpendicular Planning to create a District specific height-adjustable table supporting perpendicular planning.

WHAT'S INCLUDED

1 worksurface with cut out (if specified).

WHAT'S EXCLUDED

Base and grommet to be ordered separately.

NOTES

Worksurfaces only include a cut out when cut out style and location are specified.

Diecast grommet (UNDG- District, YEDG - Complements) must be ordered separately.

PRODUCT OPTIONS

Leg Application		Base Mechanism	Actual Depth	Actual Width	Cut Out Style
TSL	Left in Corridor, Right in Parallel Spine Credenza	7S Standard Electric (27" - 43") 9C Extended Electric-Restricted (25" - 48.7")	30	65, 71, 77, 83	N None
TSR	Right in Corridor, Left in Parallel Spine Credenza				G Round
TCL	Left in Parallel Corridor Credenza, Right leg along panel				
TCR	Right in Parallel Corridor Credenza, Left leg along panel				
TBL	Left Parallel Corridor Credenza, Right Parallel Spine Credenza				
TBR	Right Parallel Corridor Credenza, Left Parallel Spine Credenza				

SAMPLE ORDER CODE

WLD TSL	7S	30	71	G
----------------	-----------	-----------	-----------	----------

PRODUCT OPTIONS (CONTINUED)

Cut Out Location	Surface Finish	Edge Trim	Edge Trim Finish
N None	Foundation Laminate Flintwood Natural Veneer	8 Flat (with Foundation)	Edge Trim Colors
C Center		9 Flat (with Flintwood and Natural Veneer)	
L Left		H Full Knife (with all)	
R Right			

SAMPLE ORDER CODE (CONTINUED)

C	LW	8	ST
----------	-----------	----------	-----------

DIMENSIONS INCHES / MM

D	W
30 / 762	65 / 1651
30 / 762	71 / 1803
30 / 762	77 / 1956
30 / 762	83 / 2108

PRICING

FOUNDATION LAMINATE		FLINTWOOD		NATURAL VENEER	
Flat Edge	Full Knife Edge	Flat Edge	Full Knife Edge	Flat Edge	Full Knife Edge
580	755	1407	1616	1475	1694
588	767	1483	1700	1554	1782
891	1179	1597	1834	1672	1922
902	1194	1674	1918	1754	2010

If Cut Out is specified, add 37

Perpendicular Rectangular Height-Adjustable Built-in Worksurface, Gable, is to be paired with Navigate Height-Adjustable Built-in Gable Base - Perpendicular Planning to create a District specific height-adjustable table supporting perpendicular planning.

W L D _

Perpendicular Rectangular Height-Adjustable Built-in Worksurface, Gable

WHAT'S INCLUDED

1 worksurface with cut out (if specified).

WHAT'S EXCLUDED

Base and grommet to be ordered separately.

NOTES

Worksurfaces only include a cut out when cut out style and location are specified.

Diecast grommet (UNDG- District, YEDG - Complements) must be ordered separately.

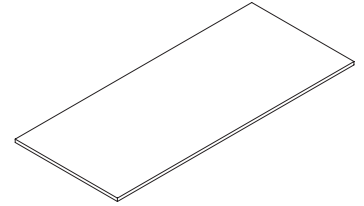

PRODUCT OPTIONS

Leg Application	Base Mechanism	Actual Depth	Actual Width	Cut Out Style
GSL Left Gable along corridor, Right T Parallel Spine Credenza	7S Standard Electric (27" - 43") 9C Extended Electric-Restricted (25" - 48.7")	30	53, 59, 65, 71, 77, 83	N None
GSR Right Gable along corridor, Left T Parallel Spine Credenza				G Round

SAMPLE ORDER CODE

WLD_ GSL	7S	30	71	G
-----------------	-----------	-----------	-----------	----------

PRODUCT OPTIONS (CONTINUED)

Cut Out Location	Surface Finish	Edge Trim	Edge Trim Finish
N None C Center L Left R Right	Foundation Laminate Flintwood Natural Veneer	8 Flat (with Foundation) 9 Flat (with Flintwood and Natural Veneer)	Edge Trim Colors

SAMPLE ORDER CODE (CONTINUED)

C	LW	8	ST
----------	-----------	----------	-----------

DIMENSIONS INCHES / MM

D	W
30 / 762	53 / 1346
30 / 762	59 / 1499
30 / 762	65 / 1651
30 / 762	71 / 1803
30 / 762	77 / 1956
30 / 762	83 / 2108

PRICING

FOUNDATION LAMINATE	FLINTWOOD	NATURAL VENEER
Flat Edge	Flat Edge	Flat Edge
558	1216	1275
568	1292	1354
580	1407	1475
588	1483	1554
891	1597	1672
902	1674	1754

If Cut Out is specified, add 37

W B D

Freestanding Table Rectangular Height-Adjustable Worksurface

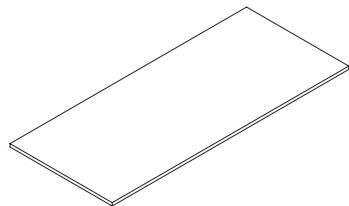

Freestanding Table Rectangular Height-Adjustable Worksurface is to be paired with Navigate Freestanding Table, Base Only, to create a Freestanding District specific height-adjustable table.

WHAT'S INCLUDED

1 worksurface with cut out (if specified).

WHAT'S EXCLUDED

Base and grommet to be ordered separately.

NOTES

To be used with Navigate Freestanding Table, Base Only (YAD).

PRODUCT OPTIONS

Leg Application	Base Mechanism	Actual Depth	Actual Width	Cut Out Style
CCC C-Legs	1S Counterbalance Standard (29.5" - 49.5")	23, 29, 35	45, 51, 57, 63, 69, 75, 81	N None
TTT T-Leg	1X Counterbalance Lower Edition (26.5" - 43.5")			G Round
	7S Standard Electric (27" - 43")			
	9C Extended Electric-Restricted (25" - 48.7")			
	9E Extended Electric-Extended (22.6" - 48.7")			

SAMPLE ORDER CODE

WBD TTT	7S	29	51	G
---------	----	----	----	---

PRODUCT OPTIONS (CONTINUED)

Cut Out Location	Surface Finish	Edge Trim	Edge Trim Finish
N None	Foundation Laminate Flintwood Natural Veneer	8 Flat (with Foundation)	Edge Trim Colors
C Center		9 Flat (with Flintwood and Natural Veneer)	
L Left		H Full Knife (with all)	
R Right			

SAMPLE ORDER CODE (CONTINUED)

C	LW	H	4T
---	----	---	----

See pricing in the following page.

W B D

**Freestanding Table Rectangular
Height-Adjustable Worksurface
(Continued)**

**DIMENSIONS
INCHES / MM**

D	W
23 / 584	51 / 1295
23 / 584	57 / 1448
23 / 584	63 / 1600
23 / 584	69 / 1753
29 / 737	51 / 1295
29 / 737	57 / 1448
29 / 737	63 / 1600
29 / 737	69 / 1753
35 / 889	51 / 1295
35 / 889	57 / 1448
35 / 889	63 / 1600
35 / 889	69 / 1753

PRICING

COUNTERBALANCE STANDARD / COUNTERBALANCE LOWER EDITION

FOUNDATION LAMINATE		FLINTWOOD		NATURAL VENEER	
Flat Edge	Full Knife Edge	Flat Edge	Full Knife Edge	Flat Edge	Full Knife Edge
537	695	1056	1215	1106	1274
545	709	1124	1288	1177	1351
556	722	1212	1389	1269	1456
563	736	1280	1463	1342	1534
553	716	1177	1355	1234	1421
563	732	1254	1439	1313	1508
573	746	1369	1574	1433	1650
584	761	1445	1658	1514	1737
862	1133	1281	1472	1343	1542
873	1150	1404	1615	1471	1693
885	1167	1487	1709	1558	1791
896	1182	1609	1852	1685	1940

STANDARD ELECTRIC

FOUNDATION LAMINATE		FLINTWOOD		NATURAL VENEER	
Flat Edge	Full Knife Edge	Flat Edge	Full Knife Edge	Flat Edge	Full Knife Edge
407	523	949	1089	994	1143
537	695	1056	1215	1106	1274
545	709	1124	1288	1177	1351
556	722	1212	1389	1269	1456
563	736	1280	1463	1342	1534
623	826	1350	1539	1414	1613
631	839	1455	1662	1526	1743
445	569	1083	1246	1134	1306
553	716	1177	1355	1234	1421
563	732	1254	1439	1313	1508
573	746	1369	1574	1433	1650
584	761	1445	1658	1514	1737
887	1171	1522	1742	1593	1825
897	1187	1635	1875	1713	1965
607	797	1196	1378	1254	1445
862	1133	1281	1472	1343	1542
873	1150	1404	1615	1471	1693
885	1167	1487	1709	1558	1791
896	1182	1609	1852	1685	1940
1007	1352	1694	1945	1774	2039
1019	1369	1779	2039	1862	2136

If Cut Out is specified, add 37

Pricing is continued on the following page.

W B D

Freestanding Table Rectangular Height-Adjustable Worksurface (Continued)

DIMENSIONS INCHES / MM

PRICING

		EXTENDED ELECTRIC-RESTRICTED / EXTENDED ELECTRIC-EXTENDED					
		FOUNDATION LAMINATE		FLINTWOOD		NATURAL VENEER	
D	W	Flat Edge	Full Knife Edge	Flat Edge	Full Knife Edge	Flat Edge	Full Knife Edge
23 / 584	45 / 1143	407	523	949	1089	994	1143
23 / 584	51 / 1295	537	695	1056	1215	1106	1274
23 / 584	57 / 1448	545	709	1124	1288	1177	1351
23 / 584	63 / 1600	556	722	1212	1389	1269	1456
23 / 584	69 / 1753	563	736	1280	1463	1342	1534
23 / 584	75 / 1905	623	826	1350	1539	1414	1613
23 / 584	81 / 2057	631	839	1455	1662	1526	1743
29 / 737	45 / 1143	445	569	1083	1246	1134	1306
29 / 737	51 / 1295	553	716	1177	1355	1234	1421
29 / 737	57 / 1448	563	732	1254	1439	1313	1508
29 / 737	63 / 1600	573	746	1369	1574	1433	1650
29 / 737	69 / 1753	584	761	1445	1658	1514	1737
29 / 737	75 / 1905	887	1171	1522	1742	1593	1825
29 / 737	81 / 2057	897	1187	1635	1875	1713	1965
35 / 889	45 / 1143	607	797	1196	1378	1254	1445
35 / 889	51 / 1295	862	1133	1281	1472	1343	1542
35 / 889	57 / 1448	873	1150	1404	1615	1471	1693
35 / 889	63 / 1600	885	1167	1487	1709	1558	1791
35 / 889	69 / 1753	896	1182	1609	1852	1685	1940
35 / 889	75 / 1905	1007	1352	1694	1945	1774	2039
35 / 889	81 / 2057	1019	1369	1779	2039	1862	2136

If Cut Out is specified, add 37

W M D

Perpendicular Rectangular Height-Adjustable Built-in Worksurface with Radius Corners

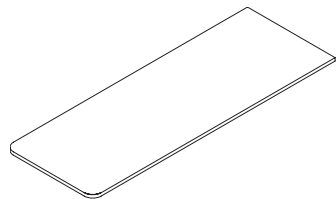

Perpendicular Rectangular Height-Adjustable Built-in Worksurface with Radius Corners to be paired with Navigate HA Built-in Base - Perpendicular Planning (YGD) to create a District specific integrated height-adjustable table that can also support curved screens.

WHAT'S INCLUDED

1 worksurface with cut out (if specified).

WHAT'S EXCLUDED

Base and grommet to be ordered separately.

NOTES

Worksurfaces only include a cut out when cut out style and location are specified.

Diecast grommet (UNDG- District, YEDG - Complements) must be ordered separately.

PRODUCT OPTIONS

Leg Application	Base Mechanism	Actual Depth	Actual Width	Cut Out Style
TSL Left in Corridor, Right in Parallel Spine Credenza	7S Standard Electric (27" - 43") 9C Extended Electric-Restricted (25" - 48.7")	30	65, 71, 77, 83	N None
TSR Right in Corridor, Left in Parallel Spine Credenza				G Round
TCL Left in Parallel Corridor Credenza, Right leg along panel				
TCR Right in Parallel Corridor Credenza, Left leg along panel				
TBL Left Parallel Corridor Credenza, Right Parallel Spine Credenza				
TBR Right Parallel Corridor Credenza, Left Parallel Spine Credenza				

SAMPLE ORDER CODE

WMD TSL	7S	30	71	G
----------------	-----------	-----------	-----------	----------

PRODUCT OPTIONS (CONTINUED)

Cut Out Location	Surface Finish	Edge Trim	Edge Trim Finish
N None	Foundation Laminate	8 Flat (with Foundation)	Edge Trim Colors
C Center	Flintwood	9 Flat (with Flintwood and Natural Veneer)	
L Left	Natural Veneer	H Full Knife (with all)	
R Right			

SAMPLE ORDER CODE (CONTINUED)

C	LW	8	ST
----------	-----------	----------	-----------

DIMENSIONS INCHES / MM

D	W
30 / 762	65 / 1651
30 / 762	71 / 1803
30 / 762	77 / 1956
30 / 762	83 / 2108

PRICING

FOUNDATION LAMINATE		FLINTWOOD		NATURAL VENEER	
Flat Edge	Full Knife Edge	Flat Edge	Full Knife Edge	Flat Edge	Full Knife Edge
580	755	1407	1616	1475	1694
588	767	1483	1700	1554	1782
891	1179	1597	1834	1672	1922
902	1194	1674	1918	1754	2010

If Cut Out is specified, add 37

W B F

hiSpace Parallel Rectangular Height-Adjustable Built-in Worksurface

Parallel Rectangular Height-Adjustable Built-in Worksurface, is to be paired with hiSpace Height-Adjustable Built-in Base - Parallel Planning to create a District specific gable leg integrated height-adjustable table supporting parallel planning.

WHAT'S INCLUDED

1 worksurface with quick connect.

WHAT'S EXCLUDED

Rectangle Grommet (HTEG) and HA mechanism must be ordered separately.

NOTES

Worksurfaces only include a cut out when cut out style and location are specified.
Diecast grommet (UNDG- District, YEDG - Complements) must be ordered separately.

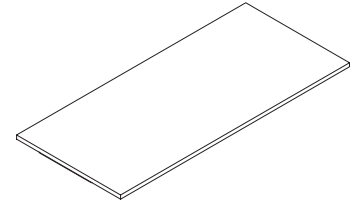

PRODUCT OPTIONS

Leg Application	Base Mechanism	Actual Depth	Actual Width	Cut Out Style
TZL Left in Perpendicular Credenza, Right toward Middle	9U Extended Electricwith Riser (25"-51.1")	29	52, 58, 64, 70	N None G Round
TZR Right in Perpendicular Credenza, Left toward Middle				
TDL Left toward outside, Right in Shared Perpendicular Credenza				
TDR Right toward outside, Left in Shared Perpendicular Credenza				
THL Left in Perpendicular Credenza, Right in Shared Perpendicular Credenza				
THR Right in Perpendicular Credenza, Left in Shared Perpendicular Credenza				

SAMPLE ORDER CODE

WBF TZL	9U	29	71	G
----------------	-----------	-----------	-----------	----------

PRODUCT OPTIONS (CONTINUED)

Cut Out Location	Surface Finish	Edge Trim Style	Edge Trim Finish
N None C Center L Left R Right	Foundation Laminate	8 Flat H Full Knife	Edge Trim Colors

SAMPLE ORDER CODE (CONTINUED)

C	LW	8	ST
----------	-----------	----------	-----------

DIMENSIONS INCHES / MM

D	W
29 / 737	52 / 1321
29 / 737	58 / 1473
29 / 737	64 / 1626
29 / 737	70 / 1778

PRICING

Flat Edge	Full Knife Edge
643	791
654	804
664	817
674	829

If Cut Out is specified, add 37

W B G

hiSpace Perpendicular Rectangular Height-Adjustable Built-in Worksurface with connection kit for Quick Connect

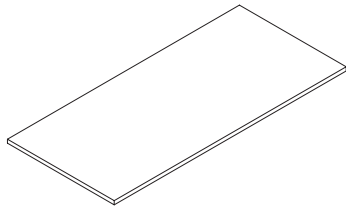

Perpendicular Rectangular Height-Adjustable Built-in Worksurface, is to be paired with hiSpace Height-Adjustable Built-in Base - Parallel Planning to create a District specific gable leg integrated height-adjustable table supporting perpendicular planning.

WHAT'S INCLUDED

1 worksurface with quick connect.

WHAT'S EXCLUDED

Rectangle Grommet (HTEG) and HA mechanism must be ordered separately.

NOTES

Worksurfaces only include a cut out when cut out style and location are specified. Diecast grommet (UNDG- District, YEDG - Complements) must be ordered separately.

PRODUCT OPTIONS

Leg Application	Base Mechanism	Actual Depth	Actual Width	Cut Out Style
TSL Left in Corridor, Right in Parallel Spine Credenza	9U Extended Electric with Riser (25"-51.1")	30	65, 71	N None G Round
TSR Right in Corridor, Left in Parallel Spine Credenza				
TCL Left in Parallel Corridor Credenza, Right alignment panel				
TCR Right in Parallel Corridor Credenza, Left alignment panel				
TBL Left in Parallel Corridor Credenza, Right in Parallel Spine Credenza				
TBR Right in Parallel Corridor Credenza, Left in Parallel Spine Credenza				

SAMPLE ORDER CODE

WBG TSL	9U	30	71	G
----------------	-----------	-----------	-----------	----------

PRODUCT OPTIONS (CONTINUED)

Cut Out Location	Surface Finish	Edge Trim Style	Edge Trim Finish
N None C Center L Left R Right	Foundation Laminate	8 Flat H Full Knife	Edge Trim Colors

SAMPLE ORDER CODE (CONTINUED)

C	LW	8	ST
----------	-----------	----------	-----------

DIMENSIONS INCHES / MM

D	W
30 / 762	65 / 1651
30 / 762	71 / 1803

PRICING

Flat Edge	Full Knife Edge
664	817
674	829

If Cut Out is specified, add 37

W J E

hiSpace Rectangular Height-Adjustable Built-in Perpendicular Worksurface with Radius Corners

Parallel Rectangular Height-Adjustable Built-in Worksurface with Radius Corners, is to be paired with hiSpace Height-Adjustable Built-in Base - Parallel Planning to create a District specific gable leg integrated height-adjustable table supporting parallel planning.

WHAT'S INCLUDED

1 worksurface with quick connect.

WHAT'S EXCLUDED

Rectangle Grommet (HTEG) and HA mechanism must be ordered separately.

NOTES

Worksurfaces only include a cut out when cut out style and location are specified. Diecast grommet (UNDG- District, YEDG - Complements) must be ordered separately.

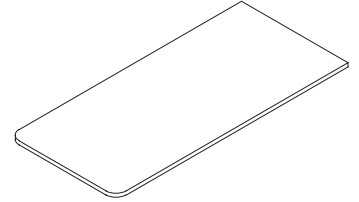

PRODUCT OPTIONS

Leg Application	Base Mechanism	Actual Depth	Actual Width	Cut Out Style
TSL Left in Corridor, Right in Parallel Spine Credenza	9U Extended Electricwith Riser (25"-51.1")	30	65, 71	N None G Round
TSR Right in Corridor, Left in Parallel Spine Credenza				
TCL Left in Parallel Corridor Credenza, Right alignment panel				
TCR Right in Parallel Corridor Credenza, Left alignment panel				
TBL Left in Parallel Corridor Credenza, Right in Parallel Spine Credenza				
TBR Right in Parallel Corridor Credenza, Left in Parallel Spine Credenza				

SAMPLE ORDER CODE

WJE TSL	9U	30	71	G
----------------	-----------	-----------	-----------	----------

PRODUCT OPTIONS (CONTINUED)

Cut Out Location	Surface Finish	Edge Trim Style	Edge Trim Finish
N None C Center L Left R Right	Foundation Laminate	8 Flat H Full Knife	Edge Trim Colors

SAMPLE ORDER CODE (CONTINUED)

C	LW	8	ST
----------	-----------	----------	-----------

DIMENSIONS INCHES / MM

D	W
30 / 762	65 / 1651
30 / 762	71 / 1803

PRICING

Flat Edge	Full Knife Edge
664	810
674	821

If Cut Out is specified, add 37

UPPC

Perpendicular Credenza for Height-Adjustable Table

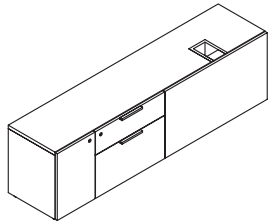

The Perpendicular Credenza for Height-Adjustable Table is installed perpendicular to the panel to allow for parallel planning within the worksurface.

WHAT'S INCLUDED

1 case, box/file drawers with pulls (as specified), lock and keys (if specified), counterweight, leg grommet

File with Hinged Door (H) has an extra kit that contains two 1-1/4" levelers and two 1-3/4" levelers will be shipped with the storage.

WHAT'S EXCLUDED

A Seat Cushion (UWLC) or Fitted Seated Cushion (UWLF) can be ordered separately. Can be found in Accessories section.

NOTES

Full Drawer (F) includes extended levelers (UNSLXB) already installed.

Hinged door is push latch, no handle required.

48" and 54" Widths are not available if configuration (H) File with Hinged Door is specified.

The following bases can be installed into this credenza:

Navigate Height-Adjustable Built-in Base - Parallel Planning (YHD)

Navigate Height-Adjustable Built-in Gable Base - Parallel Planning (YWD)

hiSpace HA Built-in Base - Perpendicular Planning (YSG)

hiSpace HA Built-in Base - Parallel Planning (YSP)

PRODUCT OPTIONS

Configuration	Depth	Width	Pull Style	Storage Compartment Location
F Navigate Compatible with Full drawer	16	48, 54, 60, 66, 72	D District	L Left (shown)
H Navigate Compatible with File with Hinged Door			R Rectangular	R Right
E hiSpace Compatible with Full drawer				
G hiSpace Compatible with File with Hinged Door				

SAMPLE ORDER CODE

UPPC F	16	60	D	L
---------------	-----------	-----------	----------	----------

PRODUCT OPTIONS (CONTINUED)

Pull Finish	Leg Grommet Finish	Case, Back & Front Finish	Key	Slot For Storage Screen
Foundation	Foundation	Source Laminate	K Key Alike	N No
Mica	Mica	Flintwood	R Key Random	Y Yes
		Natural Veneer	N No Key	

SAMPLE ORDER CODE (CONTINUED)

		Case	Back	Front		
7	7	ZA	ZA	ZA	R	N

See pricing in the following page.

U P P C

**Perpendicular Credenza for
Height-Adjustable Table
(Continued)**

**DIMENSIONS
INCHES / MM**

D	W
16 / 406	48 / 1219
16 / 406	54 / 1372
16 / 406	60 / 1524
16 / 406	66 / 1676
16 / 406	72 / 1829

PRICING

FULL DRAWER (F)

SOURCE LAMINATE CASE		FLINTWOOD CASE	VENEER CASE
Source Lam. Back & Front	Source Lam. Back, Flintwood Front	Flintwood Back & Front	Veneer Back & Front
1783	2318	3234	3397
1884	2450	3422	3592
2147	2791	3897	4090
2248	2922	4079	4283
2335	3034	4234	4447

FILE WITH HINGED DOOR (H)

SOURCE LAMINATE CASE		FLINTWOOD CASE	VENEER CASE		
Source Lam. Back & Front	Source Lam. Back, Flintwood Front	Flintwood Back & Front	Veneer Back & Front		
16 / 406	60 / 1524	2040	2650	3700	3883
16 / 406	66 / 1676	2135	2777	3876	4070
16 / 406	72 / 1829	2217	2882	4023	4224

UPCS

Shared Perpendicular Credenza for Height-Adjustable Table

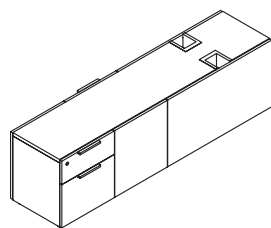

The Shared Perpendicular Credenza for Height-Adjustable Table is shared and installed perpendicular to the panel to allow for parallel planning within the worksurface.

Shared Perpendicular Credenza for Height-Adjustable Table provides file and personal storage with the capability to integrate height-adjustable tables and support stackers and panels.

WHAT'S INCLUDED

1 case, box/file drawers with pulls (as specified), lock and keys (if specified), counterweight, leg grommet

WHAT'S EXCLUDED

A Seat Cushion (UWLC) or Fitted Seated Cushion(UWLF) can be ordered separately. Can be found in Accessories section.

NOTES

This Product includes extended levelers (UNSLB) already installed.

Hinged door is push latch, no handle required.

The following bases can be installed into this credenza:

Navigate Height-Adjustable Built-in Base - Parallel Planning (YHD)

Navigate Height-Adjustable Built-in Gable Base - Parallel Planning (YWD)

hiSpace HA Built-in Base - Perpendicular Planning (YSG)

hiSpace HA Built-in Base - Parallel Planning (YSP)

PRODUCT OPTIONS

Depth	Width	Product Type	Storage Compartment Location
16	66, 72	D Navitage Compatible with District Pull Style R Navitage Compatible with Rectangular Pull Style H Navitage Compatible with District Pull Style J hiSpace Compatible with Rectangular Pull Style	L Left (shown) R Right

SAMPLE ORDER CODE

UPCS 16	72	D	L
---------	----	---	---

PRODUCT OPTIONS (CONTINUED)

Pull Finish	Leg Grommet Finish	Case & Back, Front Finish	Key
Foundation	Foundation	Source Laminate	K Key Alike
Mica	Mica	Flintwood	R Key Random
		Natural Veneer	N None

SAMPLE ORDER CODE (CONTINUED)

7	7	ZA	ZA	R
---	---	----	----	---

See pricing in the following page.

U P C S

**Shared Perpendicular Credenza
for Height-Adjustable Table
(Continued)**

**DIMENSIONS
INCHES / MM**

PRICING

		SOURCE LAMINATE BACK & CASE		FLINTWOOD BACK & CASE	VENEER BACK & CASE
		Source Lam. Front	Flintwood Front	Flintwood Front	Veneer Front
D	W				
16 / 406	66 / 1676	2773	3606	5032	5284
16 / 406	72 / 1829	2853	3708	5176	5434

UPSC

Parallel Spine Credenza for Height-Adjustable Table

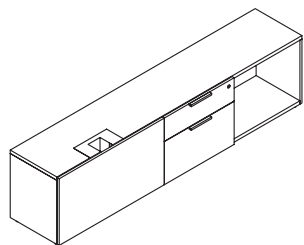

The Parallel Spine Credenza for Height-Adjustable Table is installed parallel to the panel to allow for perpendicular planning with the worksurface. This product can support the panel.

WHAT'S INCLUDED

1 case, box/file drawers with pulls (as specified), lock and keys (if specified), counterweight, leg grommet.

Open with Drawer (P) has an extra kit that contains two 1-1/4" levelers and two 1-3/4" levelers will be shipped with the storage.

WHAT'S EXCLUDED

A Seat Cushion (UWLC) or Fitted Seated Cushion (UWLF) can be ordered separately. Can be found in Accessories section.

NOTES

Full Drawer (F) includes extended levelers (UNSLB) already installed.

Hinged door is push latch, no handle required.

The following bases can be installed into this credenza:

Navigate Height-Adjustable Built-in Base - Perpendicular Planning (YGD)

Navigate Height-Adjustable Built-in Gable Base - Perpendicular Planning (YVD)

hiSpace HA Built-in Base - Perpendicular Planning (YSG)

hiSpace HA Built-in Base - Parallel Planning (YSP)

PRODUCT OPTIONS

Configuration	Depth	Width	Pull Style	Storage Compartment Location
F Navigate Compatible with Full Drawer	16	72, 78, 84	D District R Rectangular	L Left R Right
P Navigate Compatible Open with Drawer				
E hiSpace Compatible with Full Drawer				
J hiSpace Compatible Open with Drawer				

SAMPLE ORDER CODE

UPSC F	16	72	D	L
---------------	-----------	-----------	----------	----------

PRODUCT OPTIONS (CONTINUED)

Pull Finish	Leg Grommet Finish	Case & Back, Front Finish	Key
Foundation	Foundation	Source Laminate	K Key Alike R Key Random N None
Mica	Mica	Flintwood	
		Natural Veneer	

SAMPLE ORDER CODE (CONTINUED)

7	7	ZA	ZA	R
----------	----------	-----------	-----------	----------

See pricing in the following page.

U P S C

Parallel Spine Credenza for
Height-Adjustable Table
(Continued)

DIMENSIONS
INCHES / MM

PRICING

		FULL DRAWER (F/E)			
		SOURCE LAMINATE BACK & CASE		FLINTWOOD BACK & CASE	VENEER BACK & CASE
D	W	Source Lam. Front	Flintwood Front	Flintwood Front	Veneer Front
16 / 406	72 / 1829	2710	3524	4919	5164
16 / 406	78 / 1981	2836	3686	5145	5402
16 / 406	84 / 2134	2938	3820	5330	5598

		OPEN WITH DRAWER (P/J)			
		SOURCE LAMINATE BACK & CASE		FLINTWOOD BACK & CASE	VENEER BACK & CASE
D	W	Source Lam. Front	Flintwood Front	Flintwood Front	Veneer Front
16 / 406	72 / 1829	2192	2849	3976	4175
16 / 406	78 / 1981	2296	2984	4164	4374
16 / 406	84 / 2134	2374	3087	4307	4524

UPCC

Parallel Corridor Credenza for Height-Adjustable Table

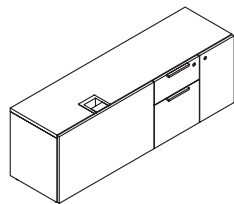

The Parallel Corridor Credenza for Height-Adjustable Table is installed parallel to the corridor to allow for perpendicular planning with the worksurface.

WHAT'S INCLUDED

1 case, box/file drawers with pulls (as specified), lock and keys (if specified), counterweight, leg grommet.

File with Hinged Door (H) has an extra kit that contains two 1-1/4" levelers and two 1-3/4" levelers will be shipped with the storage.

WHAT'S EXCLUDED

A Seat Cushion (UWLC) or Fitted Seated Cushion (UWLF) can be ordered separately. Can be found in Accessories section.

NOTES

Full Drawer (F) includes extended levelers (UNSLB) already installed.

Hinged door is push latch, no handle required.

48" and 54" Widths are not available if configuration (H) File with Hinged Door is specified.

The following bases can be installed into this credenza:

Navigate Height-Adjustable Built-in Base - Parallel Planning (YHD)

Navigate Height-Adjustable Built-in Gable Base - Parallel Planning (YWD)

hiSpace HA Built-in Base - Perpendicular Planning (YSG)

hiSpace HA Built-in Base - Parallel Planning (YSP)

PRODUCT OPTIONS

Configuration	Depth	Width	Pull Style	Storage Compartment Location
F Navigate Full Drawer	16	48, 54, 60	D District	L Left
H Navigate File with Hinged Door			R Rectangular	R Right
E hiSpace Quick-Connect Full drawer				
G hiSpace Quickconnect File with Hinged Door				

SAMPLE ORDER CODE

UPCC F	16	48	D	L
---------------	-----------	-----------	----------	----------

PRODUCT OPTIONS (CONTINUED)

Pull Finish	Leg Grommet Finish	Case, Back & Front Finish	Key
Foundation	Foundation	Source Laminate	K Key Alike
Mica	Mica	Flintwood	R Key Random
		Natural Veneer	N None

SAMPLE ORDER CODE (CONTINUED)

7	7	ZA	ZA	ZA	R
----------	----------	-----------	-----------	-----------	----------

See pricing in the following page.

U P C C

**Parallel Corridor Credenza for
Height-Adjustable Table(Continued)**

**DIMENSIONS
INCHES / MM**

D	W
16 / 406	48 / 1219
16 / 406	54 / 1372

PRICING

FULL DRAWER (F)

SOURCE LAMINATE CASE		FLINTWOOD CASE	VENEER CASE
Source Lam. Back & Front	Source Lam. Back, Flintwood Front	Flintwood Back & Front	Veneer Back & Front
1783	2318	3234	3397
1884	2450	3422	3592

FILE WITH HINGED DOOR (H)

SOURCE LAMINATE CASE		FLINTWOOD CASE	VENEER CASE
Source Lam. Back & Front	Source Lam. Back, Flintwood Front	Flintwood Back & Front	Veneer Back & Front
2147	2791	3897	4090

storage

storage product map

UPR Rolling Pedestal

Page 714

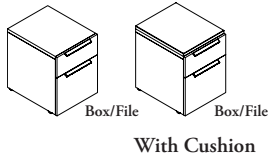

UPRB Rolling Pedestal with Box Drawer & Hinged Door

Page 715

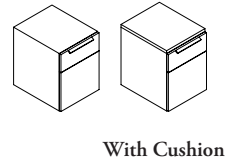

UPRH Rolling Pedestal with Hinged Door

Page 716

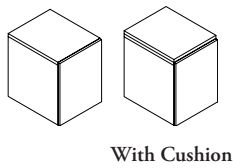

UPFD Pedestal with Solid Back

Page 717

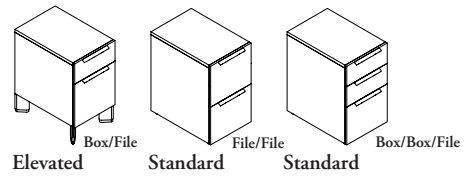

UPSE Stretch Pedestal – Elevated

Page 718

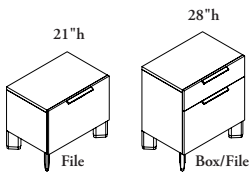

UPSS Stretch Pedestal – Standard

Page 720

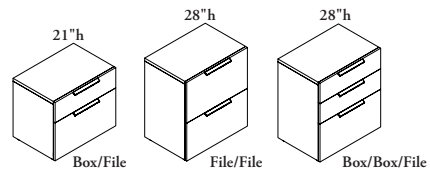

UFLS Lateral File – Standard

Page 722

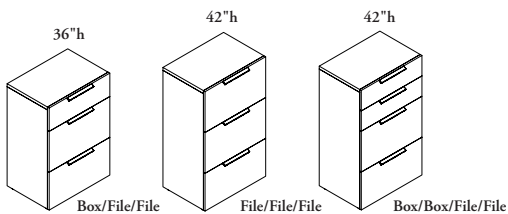

product map

UBKE Bookcase – Elevated

Page 724

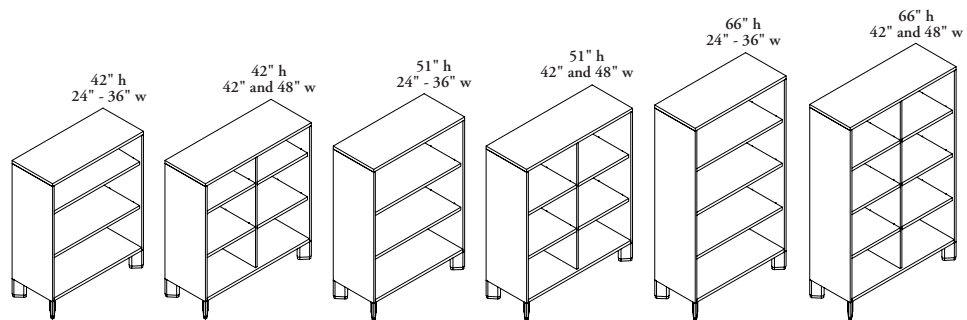

UBKS Bookcase – Standard

Page 725

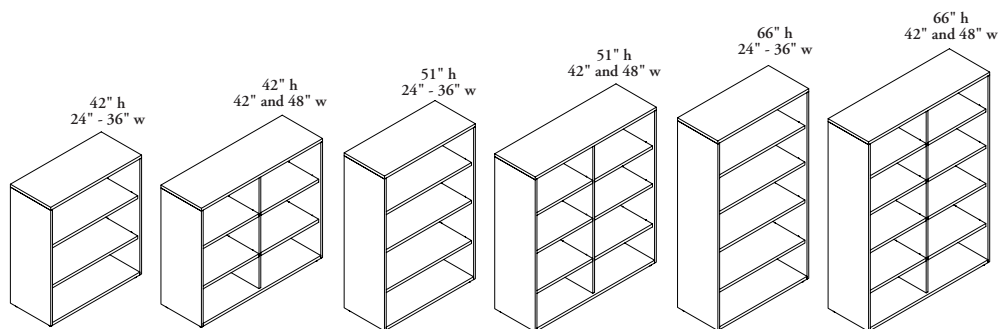

ULDE Low Full Drawer Credenza – Elevated

Page 726

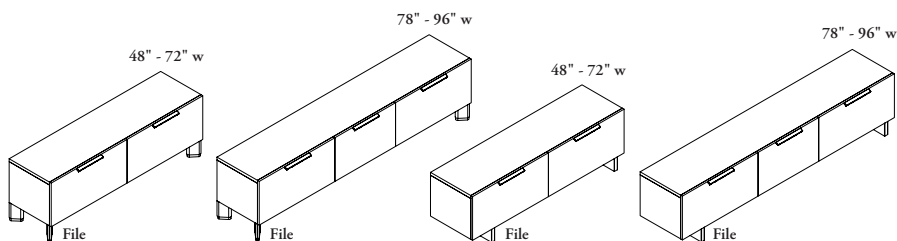

Angled Foot

District Foot (19" depth only)

ULDS Low Full Drawer Credenza – Standard

Page 727

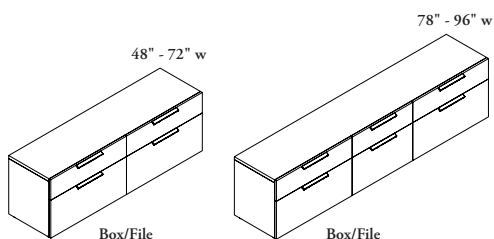

Box/File

Box/File

UHDE High Full Drawer Credenza – Elevated

Page 728

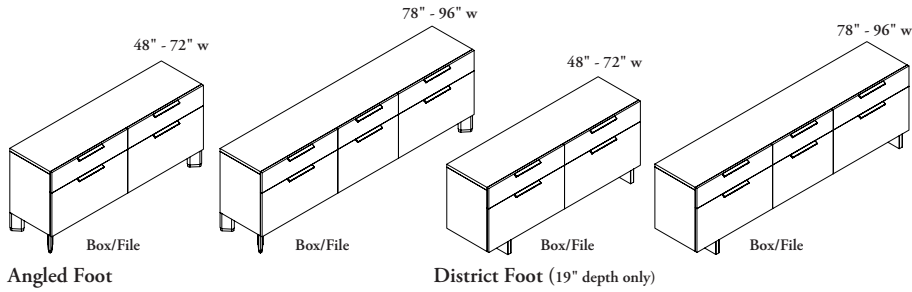

UHDS High Full Drawer Credenza – Standard

Page 730

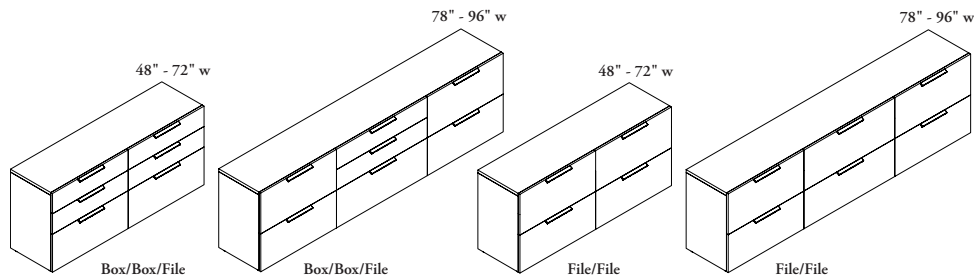

ULOE Low Open Credenza – Elevated

Page 732

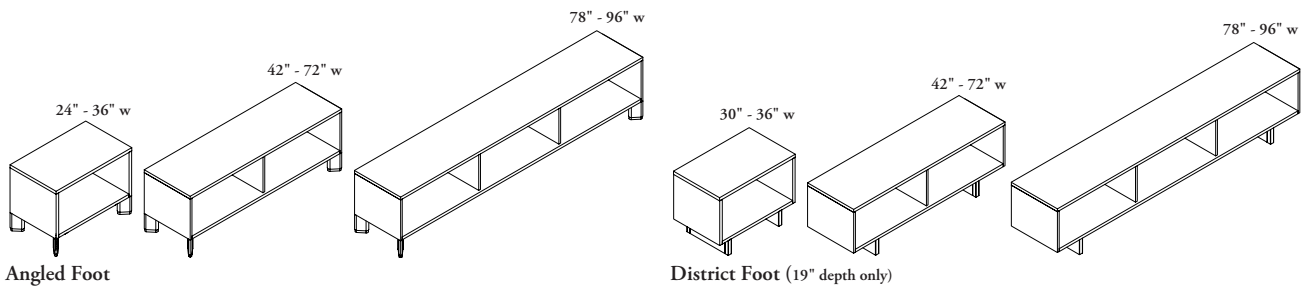

ULOS Low Open Credenza – Standard

Page 733

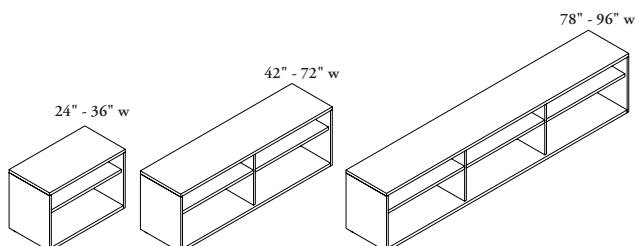

product map

UHOE High Open Credenza – Elevated

Page 734

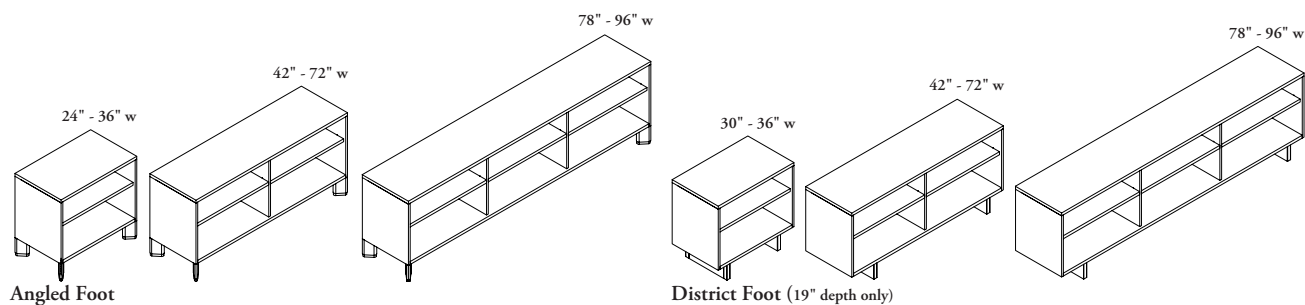

UHOS High Open Credenza – Standard

Page 736

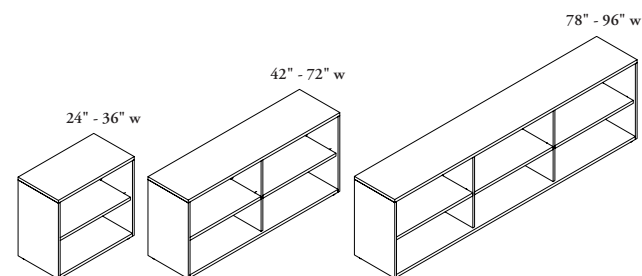

ULHE Low Open with Drawer Credenza – Elevated

Page 738

Open Compartment also available on right side

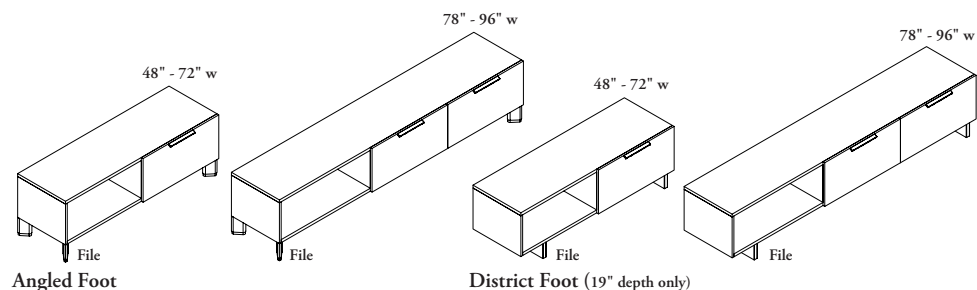

ULHS Low Open with Drawer Credenza – Standard

Page 740

Open Compartment also available on right side

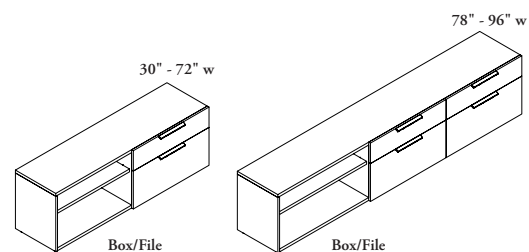

UHHE High Open with Drawer Credenza – Elevated

Page 742

Open Compartment also available on right side

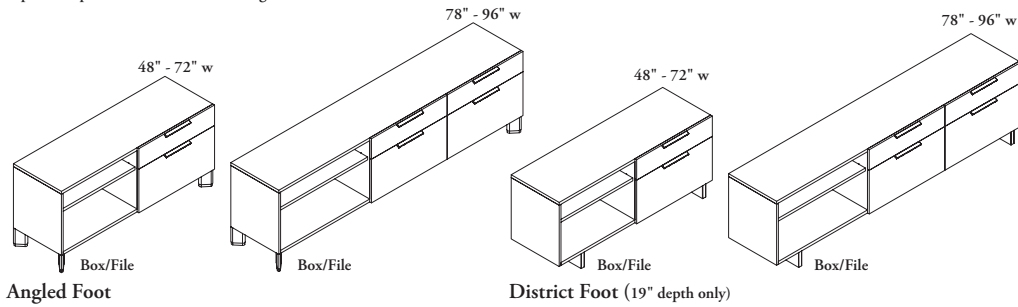

UHHS High Open with Drawer Credenza – Standard

Page 744

Open Compartment also available on right side

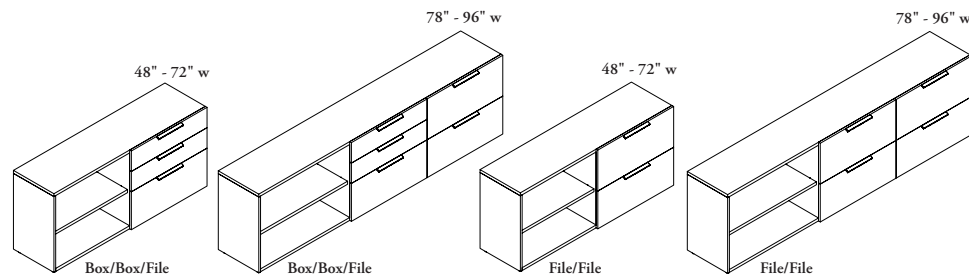

ULSE Low Double Sliding Door Credenza – Elevated

Page 746

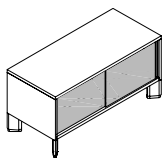

ULSS Low Double Sliding Door Credenza – Standard

Page 747

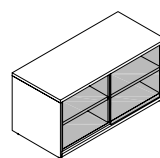

UHSE High Double Sliding Door Credenza – Elevated

Page 748

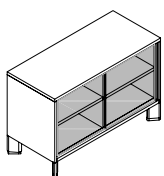

UHSS High Double Sliding Door Credenza – Standard

Page 749

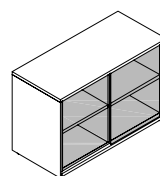

product map

UCO Open Stacker

Page 750

Double-Sided also available in right position

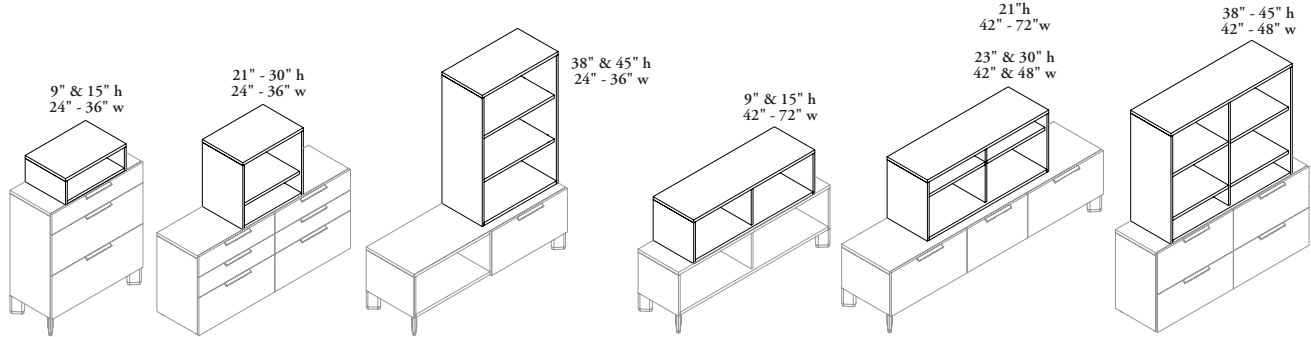

Single-Sided

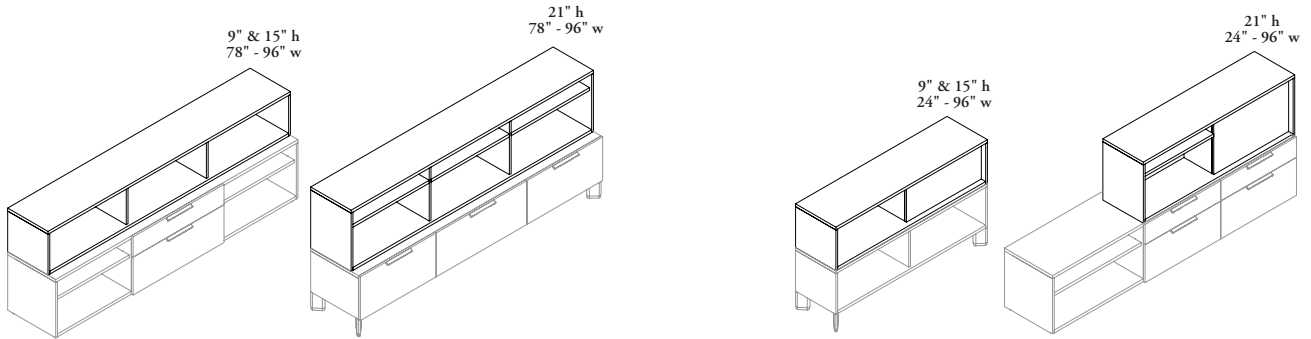

Single-Sided

Double-Sided

UCC Closed Stacker

Page 754

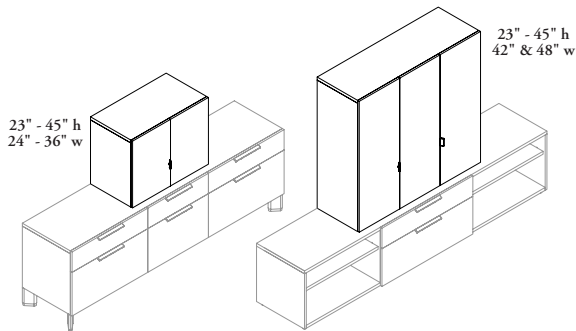

UCB Closed Stacker with Cubbies

Page 755

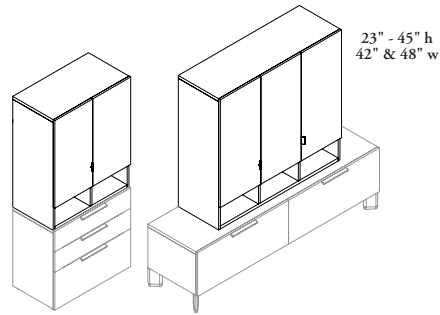

UKSD Single Locker with Solid Back

Page 756

Right door swing also available

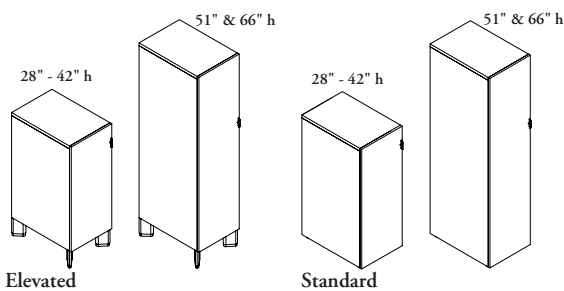

Elevated

Standard

UKC Single Locker with Side Closet

Page 758

Closet also available on right side

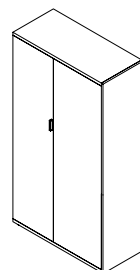

product map

UKN Cubby Locker

Page 760

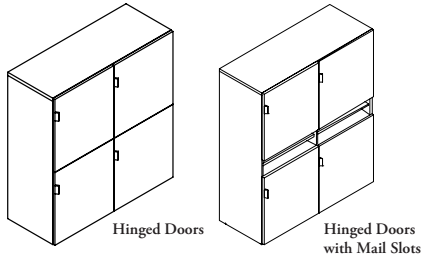

UKD Dual Locker

Page 762

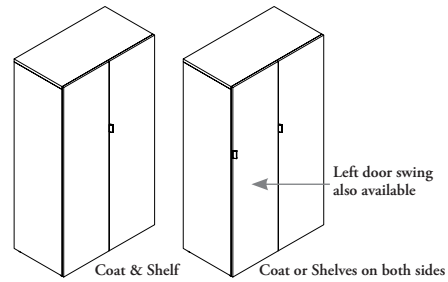

UKT Triple Locker

Page 764

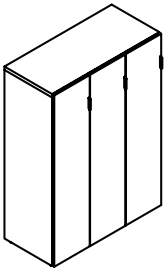

UKQ Quad Locker

Page 766

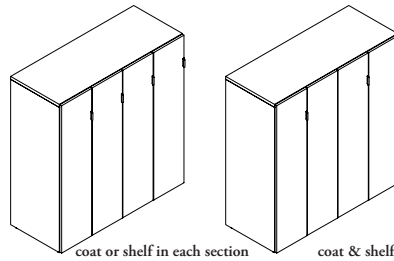

UTLE Lateral Tower – Elevated

Page 768

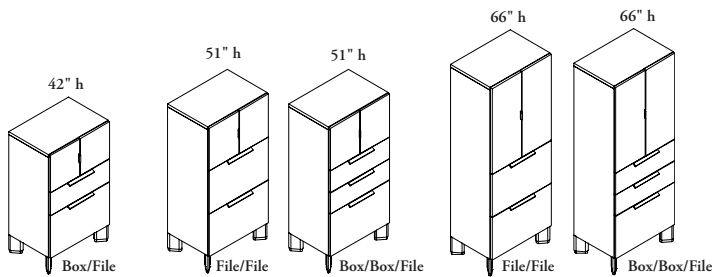

Secured

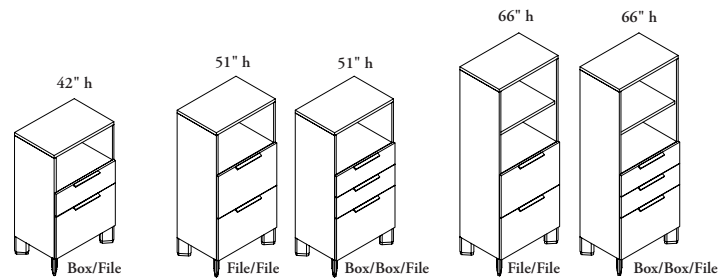

Closed Back

product map

UTLS Lateral Tower – Standard

Page 772

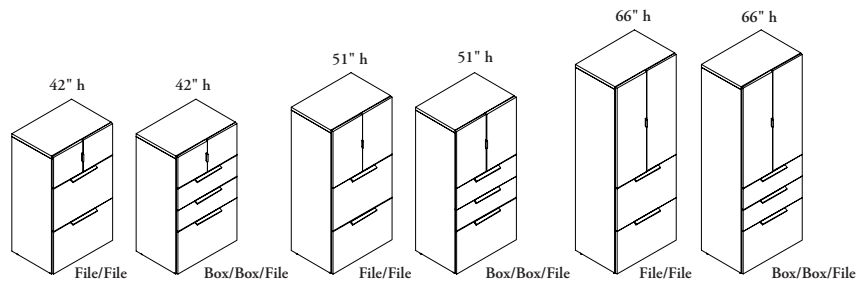

Secured

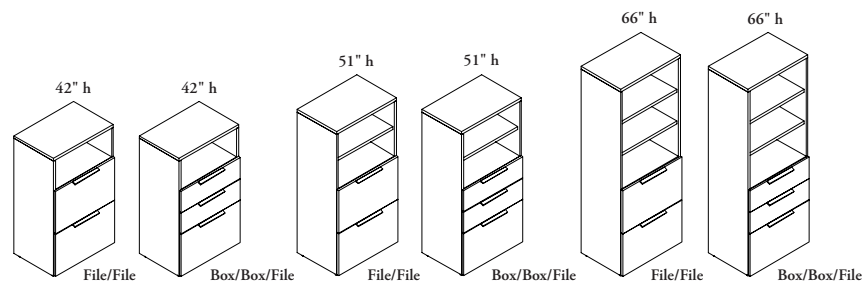

Closed Back

UTCE Combo Tower – Elevated

Page 776

Wardrobe also available on right side

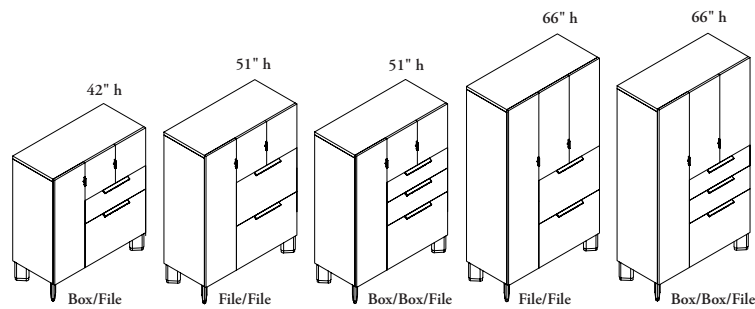

Secured

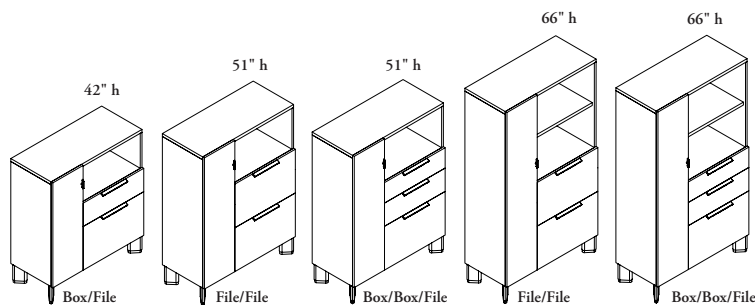

Closed Back

UTCS Combo Tower – Standard

Page 780

Wardrobe also available on right side

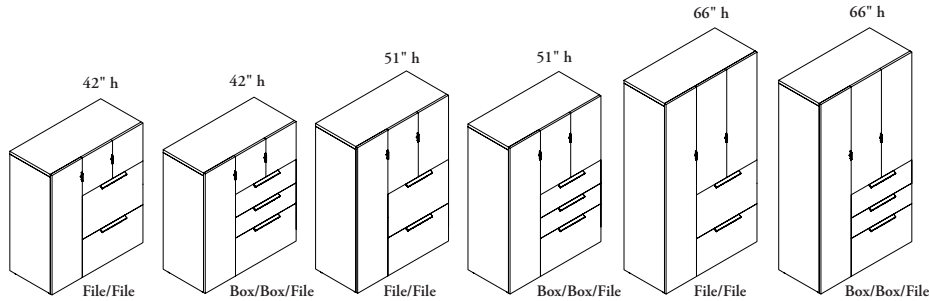

Secured

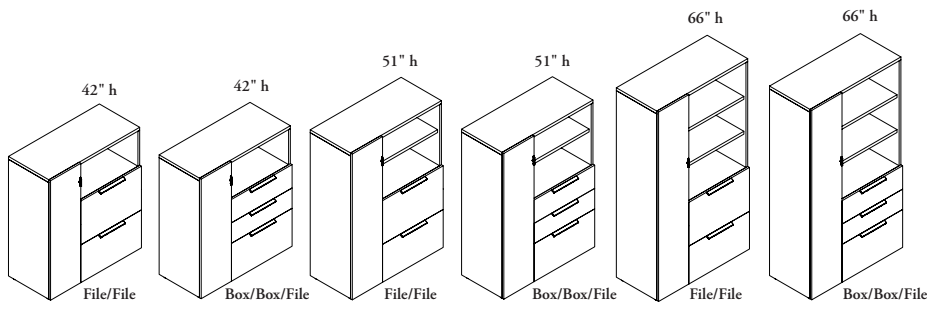

Closed Back

UTDC Pedestal Tower with Cubby Back

Page 784

Swing also available on left side

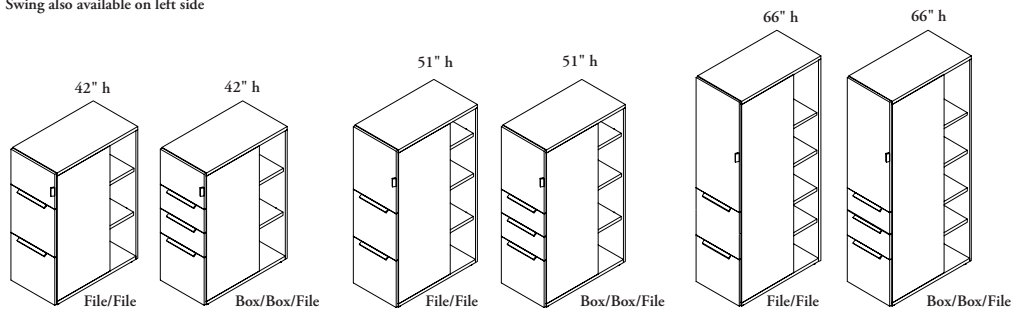

UTDD Pedestal Tower with Solid Back

Page 786

Swing also available on left side

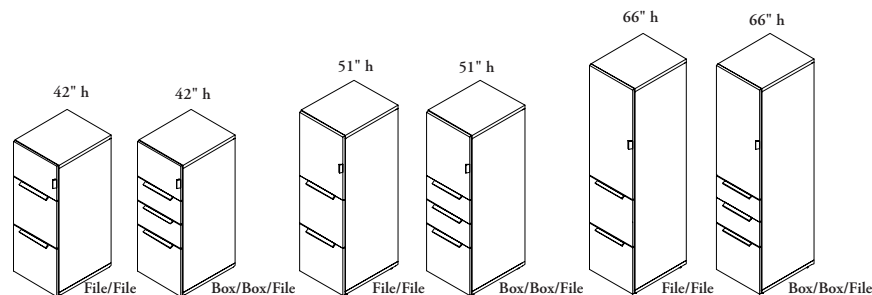

product map

UTDK Pedestal Tower with Side Closet

Page 787

Height: 51" & 66" / Depth: 29" & 35" / Width: 16"

Closet also available on left side

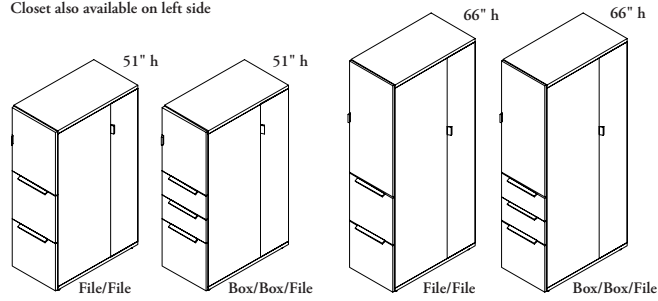

UTW Side Open Tower

Page 788

Opening also available on left side

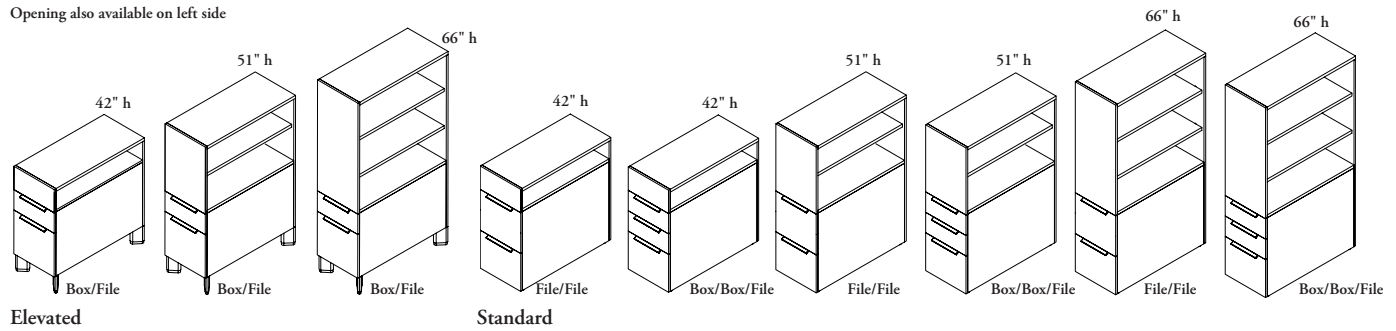

UTWW Wide Side Open Tower

Page 790

Opening also available on left side

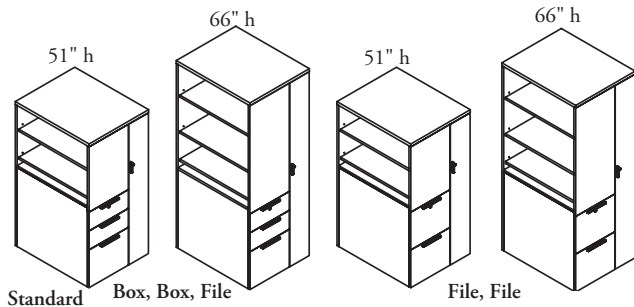

UOH Sliding Door Overhead

Page 792

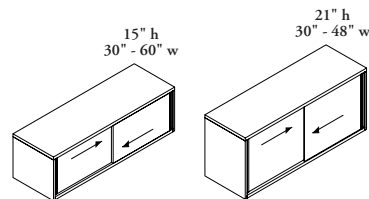

UOHC Sliding Door Centermount Overhead

Page 794

Double-Sided also available in left position

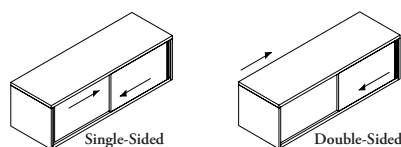

UOO Open Overhead

Page 796

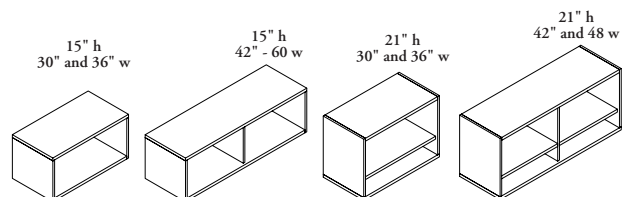

product map

UOOC Open Centermount Overhead

Page 798

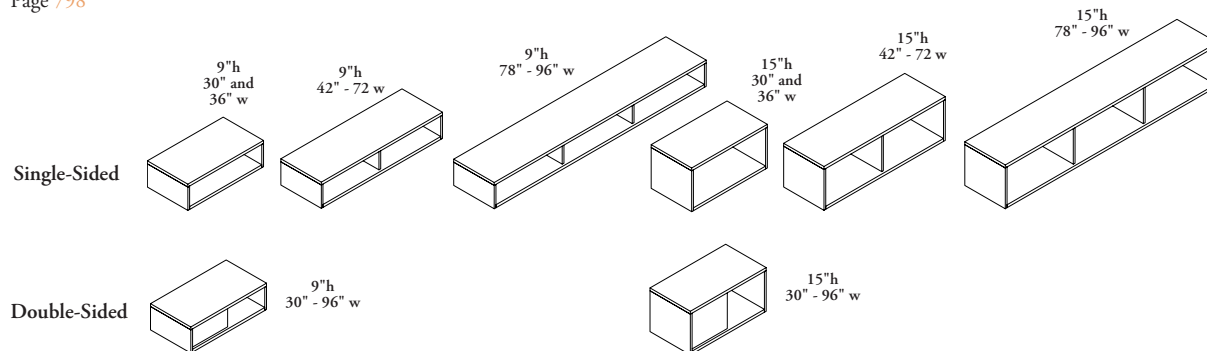

UTS Side Filer

Page 800

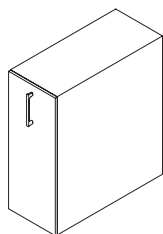

UTM Mini Side Filer

Page 802

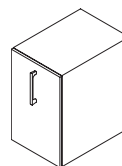

UNSLB Linking Bracket

Page 803

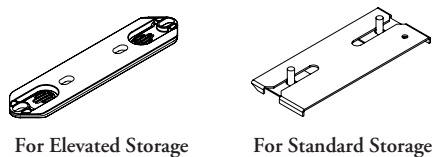

UNSXL Storage Extended Leveling Kit

Page 804

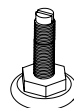

UWKA Locker Accessories

Page 805

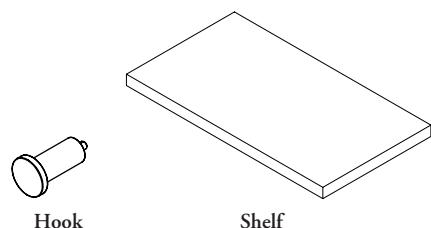

SOKL Set of Keys Alike

Page 806

UPR Rolling Pedestal

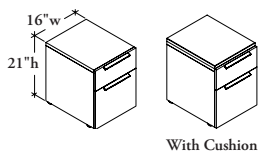

The Rolling Pedestal provides mobile filing storage with optional Seat Cushion for temporary guest seating.

WHAT'S INCLUDED

1 cabinet, drawers with pulls (as specified), 5 casters, lock and keys (if specified) and Seat Cushion (UWLC), if specified.

Includes a pencil tray.

WHAT'S EXCLUDED

A Seat Cushion (UWLC) can be ordered separately. Can be found in the *Accessories* section.

NOTES

Rolling Pedestal can be rolled under a worksurface.

Box/File smooth slide (S) option has a cut out in the back of the pedestal to allow it to clear the legs on a height-adjustable table for a tighter fit.

Yardage requirement for com or col is 0.8 yards based on a pattern of repeat of no more than 4" horizontal or vertical. Larger repeats will require additional yardage.

PRODUCT OPTIONS

Configuration	Depth	Pull Style	Pull Finish	Case, Back & Front Finish	Key Style	Seat Cushion Included	Seat Cushion Finish (If applicable)
X Box/File Standard	19	D District	Foundation	Source Laminate	K Keyed Alike	Y Yes	Seating Fabric
S Box/File Smooth Slide		R Rectangular	Mica	Flintwood Natural Veneer	R Keyed Randomly N No Lock	N No	Leather

SAMPLE ORDER CODE

				Case	Back	Front			
UPR X	19	D	7	ZA	ZA	ZA	R	Y	F510

DIMENSIONS INCHES / MM

D
19 / 483

PRICING

SOURCE LAMINATE CASE

Source Lam. Back & Front	Source Lam. Back, Flintwood Front
965	1416

FLINTWOOD CASE

Flintwood Back & Front
1657

VENEER CASE

Veneer Back & Front
1723

IF SEAT CUSHION IS SPECIFIED PLEASE ADD THE FOLLOWING:

Gr. 1	COM/ Gr. 2	COL/ Gr. 3	Gr. 4	Gr. 5	Gr. 6	Gr. 7	Gr. 8	Gr. 9	Gr. 10	Leather LA	Leather LB	Leather LC	Leather LD
539	592	612	641	655	668	697	723	752	781	940	1000	1176	1233

U P R B

Rolling Pedestal with Box Drawer & Hinged Door

The Rolling Pedestal with Box Drawer and Hinged Door provides mobile multiple-use storage with optional Seat Cushion for temporary guest seating.

WHAT'S INCLUDED

1 case, drawer with pulls (as specified), hinged door, 4 casters, lock and keys (if specified) and seat cushion (if specified).

NOTES

Rolling Pedestal can be rolled under a worksurface.

Yardage requirement for COM or COL is 0.75 yards based on a pattern of repeat of no more than 4" horizontal or vertical. Larger repeats will require additional yardage.

Door swing direction can be determined by the location of the hinges on the door.

Hinged door is push latch, no handle required.

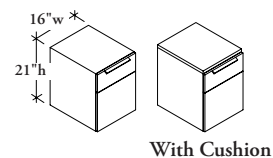

PRODUCT OPTIONS

Case, Back & Drawer Combination	Depth	Door Swing	Pull Style	Pull Finish	Case, Back & Front Finish	Key Style	Seat Cushion Included	Seat Cushion Finish (If applicable)
G Box, Hinged Door	19	L Left	D District	Foundation	Source Laminate Flintwood Natural Veneer	K Keyed Alike	Y Yes	Seating Fabric
		R Right	R Rectangular	Mica		R Keyed Randomly	N No	Leather
						N No Lock		

SAMPLE ORDER CODE

					Case Back Front					
UPRB G	19	L	D	7	ZA	ZA	ZA	R	Y	F510

DIMENSIONS INCHES / MM

D
19 / 483

PRICING

SOURCE LAMINATE CASE		FLINTWOOD CASE	VENEER CASE
Source Lam. Back & Front	Source Lam. Back, Flintwood Front	Flintwood Back & Front	Veneer Back & Front
737	1081	1513	1590

IF SEAT CUSHION IS SPECIFIED PLEASE ADD THE FOLLOWING:

Gr. 1	COM/ Gr. 2	COL/ Gr. 3	Gr. 4	Gr. 5	Gr. 6	Gr. 7	Gr. 8	Gr. 9	Gr. 10	Leather LA	Leather LB	Leather LC	Leather LD
539	592	612	641	655	668	697	723	752	781	940	1000	1176	1233

UPRH

Rolling Pedestal with Hinged Door

The Rolling Pedestal with Hinged Door provides mobile personal storage with optional Seat Cushion for temporary guest seating.

WHAT'S INCLUDED

1 case, hinged door, 4 casters, lock and keys (if specified) and seat cushion (if specified).

NOTES

Rolling Pedestal can be rolled under a worksurface.

Yardage requirement for COM or COL is 0.75 yards based on a pattern of repeat of no more than 4" horizontal or vertical. Larger repeats will require additional yardage.

Door swing direction can be determined by the location of the hinges on the door.

Hinged door is push latch, no handle required.

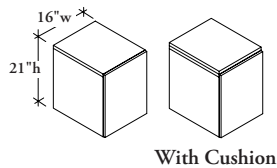

PRODUCT OPTIONS

Drawer Combination	Depth	Door Swing	Case, Back & Front Finish	Key Style	Seat Cushion Included	Seat Cushion Finish (If applicable)
H Hinged Door	19	L Left R Right	Source Laminate Flintwood Natural Veneer	K Keyed Alike R Keyed Randomly N No Lock	Y Yes N No	Seating Fabric Leather

SAMPLE ORDER CODE

			Case	Back	Front			
UPRH H	19	L	ZA	ZA	ZA	R	Y	F510

DIMENSIONS INCHES / MM

D
19 / 483

PRICING

SOURCE LAMINATE CASE

Source Lam. Back & Front	Source Lam. Back, Flintwood Front
651	956

FLINTWOOD CASE

Flintwood Back & Front
1428

VENEER CASE

Veneer Back & Front
1500

IF SEAT CUSHION IS SPECIFIED PLEASE ADD THE FOLLOWING:

Gr. 1	COM/ Gr. 2	COL/ Gr. 3	Gr. 4	Gr. 5	Gr. 6	Gr. 7	Gr. 8	Gr. 9	Gr. 10	Leather LA	Leather LB	Leather LC	Leather LD
539	592	612	641	655	668	697	723	752	781	940	1000	1176	1233

UPFD

Pedestal with Solid Back

The Pedestal with Solid Back provides filing storage with the capability to support worksurfaces and panels.

WHAT'S INCLUDED

1 cabinet, drawers with pulls (as specified), 4 angled feet (with Elevated style), lock and keys (if specified).

NOTES

The Elevated (E) pedestal includes a Box/File (X) drawer combination.

The Standard (S) pedestal is available with Box/Box/File (B) or File/File drawer combinations.

It is recommended that pedestals be attached to a panel or worksurface.

This product includes extended levelers (UNSXLB) already installed.

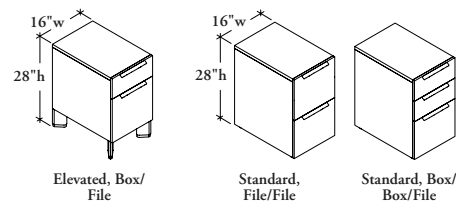

PRODUCT OPTIONS

Style	Drawer Combination	Depth	Pull Style	Pull Finish	Case, Back & Front Finish	Foot Finish (Elevated Style)	Key Style
E Elevated	X Box/File	19, 23, 29	D District	Foundation	Source Laminate	Q Storm White	K Keyed Alike
S Standard	B Box/Box/File F File/File		R Rectangular	Mica	Flintwood Natural Veneer	7 Platinum V Very White X Anthracite M Graphite 2 Burnished Bronze	R Keyed Randomly N No Lock

SAMPLE ORDER CODE

					Case	Back	Front		
UPFD E	X	29	D	7	ZA	ZA	ZA	Q	R

**DIMENSIONS
INCHES / MM**

D
19 / 483
23 / 584
29 / 737

PRICING

ELEVATED (E)					
BOX/FILE (X)					
SOURCE LAMINATE CASE		FLINTWOOD CASE		VENEER CASE	
Source Lam. Back & Front	Source Lam. Back, Flintwood Front	Flintwood Back & Front		Veneer Back & Front	
1239	1737	2006		2080	
1310	1871	2188		2267	
1452	2005	2368		2454	

STANDARD (S)					
BOX/FILE (X) FILE/FILE (F)					
SOURCE LAMINATE CASE		FLINTWOOD CASE		VENEER CASE	
Source Lam. Back & Front	Source Lam. Back, Flintwood Front	Flintwood Back & Front		Veneer Back & Front	
1126	1657	1960		2038	
1200	1813	2151		2237	
1332	1970	2345		2437	

BOX/FILE (X) FILE/FILE (F)					
SOURCE LAMINATE CASE		FLINTWOOD CASE		VENEER CASE	
Source Lam. Back & Front	Source Lam. Back, Flintwood Front	Flintwood Back & Front		Veneer Back & Front	
1072	1574	1838		1913	
1144	1707	2020		2104	
1285	1838	2198		2290	

UPSE

Stretch Pedestal – Elevated

The Elevated Stretch Pedestal provides high density filing storage in addition to a base to support most Stackers. It can also be used to support worksurfaces and panels or to provide power and data access.

WHAT'S INCLUDED

1 cabinet, drawer(s) with pull(s) (as specified), 4 angled feet, 2" high pencil drawer with removable organizing tray (if specified), lock and keys (if specified) and counterweight (if specified).

NOTES

Red Drawer Accessories **cannot** be specified for any 28" high stretch pedestal, or for any 16" deep stretch pedestal.

23" and 29" deep stretch pedestals **cannot** be specified with the Base Back Cut Out (B) option. (N) must be selected.

A counterweight **cannot** be specified when the Base Back Cut Out (B) option is selected. Stretch pedestals must be attached to a panel or worksurface or linked to another storage unit.

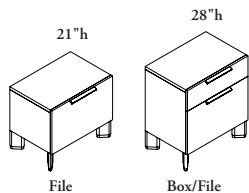

PRODUCT OPTIONS

Height	Depth	Width	Pull Style	Pull Finish	Case, Back & Front Finish
21, 28	16, 19, 23, 29	24, 30, 36	D District R Rectangular	Foundation Mica	Source Laminate Flintwood Natural Veneer

SAMPLE ORDER CODE

					Case	Back	Front
UPSE 21	19	30	D	7	ZA	ZA	ZA

PRODUCT OPTIONS CONTINUED

Foot Finish	Red Drawer Accessories	Key Style	Electrical Cut Out	Counter-weight
Q Storm White	Y Yes	K Keyed Alike	B Base Back Cut Out	1 Yes
7 Platinum	N No	R Keyed Randomly	N None	2 No
V Very White		N No Lock		
X Anthracite				
M Graphite				
2 Burnished Bronze				

SAMPLE ORDER CODE CONTINUED

7	Y	R	N	2
----------	----------	----------	----------	----------

See Pricing on the following page.

U P S E
Stretch Pedestal – Elevated
(Continued)

DIMENSIONS
FOR MM X BY 25.4

PRICING

			SOURCE LAMINATE CASE		FLINTWOOD CASE	VENEER CASE
			Source Lam. Back & Front	Source Lam. Back, Flintwood Front	Flintwood Back & Front	Veneer Back & Front
21	16	24	1342	1782	2304	2430
21	16	30	1400	1870	2418	2552
21	16	36	1498	1998	2589	2733
21	19	24	1393	1861	2410	2541
21	19	30	1457	1951	2528	2666
21	19	36	1553	2084	2707	2857
21	23	24	1503	2036	2648	2795
21	23	30	1562	2140	2780	2935
21	23	36	1660	2282	2983	3148
21	29	24	1624	2213	2891	3049
21	29	30	1685	2320	3036	3202
21	29	36	1794	2485	3259	3436
28	16	24	1580	2096	2560	2701
28	16	30	1646	2198	2688	2835
28	16	36	1762	2348	2878	3037
28	19	24	1640	2190	2677	2822
28	19	30	1713	2298	2809	2962
28	19	36	1829	2453	3009	3178
28	23	24	1770	2394	2943	3107
28	23	30	1836	2512	3088	3260
28	23	36	1952	2688	3312	3497
28	29	24	1910	2600	3214	3387
28	29	30	1983	2732	3374	3558
28	29	36	2110	2921	3620	3819

If Red Drawer Accessories are specified, add 208

If Base Back Cut Out is specified, add 105

If Counterweight is specified, add 168

UPSS

Stretch Pedestal – Standard

The Standard Stretch Pedestal provides high density filing storage in addition to a base to support most Stackers. It can also be used to support worksurfaces and panels.

WHAT'S INCLUDED

1 cabinet, drawers with pulls (as specified), lock and keys (if specified) and counterweight (if specified).

NOTES

The 21" high stretch pedestal includes a Box/File (X) drawer combination.

The 28" high stretch pedestal is available with Box/Box/File (B) or File/File (F) drawer combinations.

For shared filing, Individual Lock (L) key style is available when File/File (F) drawer combination is specified.

This product includes extended levelers (UNSLXB) already installed.

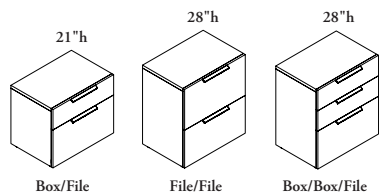

PRODUCT OPTIONS

Height	Drawer Combination	Depth	Width	Pull Style	Pull Finish	Case, Back & Front Finish	Key Style	Counterweight
21, 28	X Box/File B Box/Box/File F File/File	16, 19, 23, 29	24, 30, 36	D District R Rectangular	Foundation Mica	Source Laminate Flintwood Natural Veneer	L Individual Lock K Keyed Alike R Keyed Randomly N No Lock	1 Yes 2 No

SAMPLE ORDER CODE

				Case	Back	Front				
UPSS 21	X	19	30	D	7	ZA	ZA	ZA	R	1

DIMENSIONS FOR MM X BY 25.4

H	D	W
21	16	24
21	16	30
21	16	36
21	19	24
21	19	30
21	19	36
21	23	24
21	23	30
21	23	36
21	29	24
21	29	30
21	29	36

PRICING

BOX/FILE (X)			
SOURCE LAMINATE CASE		FLINTWOOD CASE	VENEER CASE
Source Lam. Back & Front	Source Lam. Back, Flintwood Front	Flintwood Back & Front	Veneer Back & Front
1398	1924	2380	2439
1466	2029	2505	2571
1582	2178	2697	2768
1459	2018	2496	2559
1533	2123	2627	2696
1646	2280	2830	2901
1588	2222	2762	2836
1658	2342	2908	2986
1772	2515	3133	3219
1728	2428	3031	3113
1803	2558	3191	3279
1927	2750	3437	3532

If Counterweight is specified, add 168

Pricing is continued on the following page.

U P S S
Stretch Pedestal – Standard
(Continued)

DIMENSIONS
FOR MM X BY 25.4

H	D	W
28	16	24
28	16	30
28	16	36
28	19	24
28	19	30
28	19	36
28	23	24
28	23	30
28	23	36
28	29	24
28	29	30
28	29	36

PRICING

BOX/BOX/FILE (B)			
SOURCE LAMINATE CASE		FLINTWOOD CASE	VENEER CASE
Source Lam. Back & Front	Source Lam. Back, Flintwood Front	Flintwood Back & Front	Veneer Back & Front
1644	2263	2799	2871
1724	2387	2947	3024
1860	2559	3175	3257
1719	2373	2936	3010
1803	2500	3090	3171
1937	2683	3328	3413
1870	2615	3253	3336
1949	2755	3424	3513
2083	2958	3685	3784
2034	2857	3566	3662
2120	3010	3755	3856
2267	3234	4048	4155

FILE/FILE (F)			
SOURCE LAMINATE CASE		FLINTWOOD CASE	VENEER CASE
Source Lam. Back & Front	Source Lam. Back, Flintwood Front	Flintwood Back & Front	Veneer Back & Front
1428	2061	2571	2657
1496	2166	2705	2794
1619	2329	2916	3011
1500	2166	2705	2794
1574	2281	2847	2942
1696	2452	3070	3169
1655	2411	3020	3119
1721	2538	3181	3284
1841	2727	3428	3541
1819	2650	3336	3448
1894	2793	3511	3627
2024	3004	3788	3911

If Individual Lock is specified, add 168
 If Counterweight is specified, add 168

U F L S

Lateral File – Standard

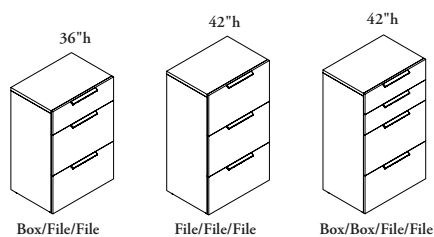

The Standard Lateral File provides high density filing storage in addition to a base to support most Stackers. It can also be used to support worksurfaces and panels.

WHAT'S INCLUDED

1 cabinet, drawers with pulls (as specified), lock and keys (if specified), counterweight (if specified).

NOTES

The 36" high lateral file includes a Box/File/File (W) drawer combination.

The 42" high lateral file is available with Box/Box/File/File (Q) or File/File/File (R) drawer combinations.

This product includes extended levelers (UNSXLB) already installed.

PRODUCT OPTIONS

Height	Drawer Combination	Depth	Width	Pull Style	Pull Finish	Case, Back & Front Finish	Key Style	Counterweight
36, 42	W Box/File/File	16, 19	24, 30, 36	D District	Foundation Mica	Source Laminate Flintwood Natural Veneer	K Keyed Alike	1 Yes 2 No
	Q Box/Box/File / File			R Rectangular			R Keyed Randomly	
	R File/File/File			N No Lock				

SAMPLE ORDER CODE

						Case	Back	Front		
UFLS 36	W	19	30	D	7	HL	HL	HL	K	1

DIMENSIONS

FOR MM X BY 25.4

H	D	W
36	16	24
36	16	30
36	16	36
36	19	24
36	19	30
36	19	36

PRICING

BOX/FILE/FILE (W)

SOURCE LAMINATE CASE		FLINTWOOD CASE		VENEER CASE	
Source Lam. Back & Front	Source Lam. Back, Flintwood Front	Flintwood Back & Front		Veneer Back & Front	
1955	2488	3210		3350	
2019	2617	3377		3527	
2128	2771	3582		3755	
2051	2617	3377		3527	
2118	2755	3557		3711	
2233	2916	3774		3952	

BOX/BOX/FILE/FILE (Q)

SOURCE LAMINATE CASE		FLINTWOOD CASE		VENEER CASE	
Source Lam. Back & Front	Source Lam. Back, Flintwood Front	Flintwood Back & Front		Veneer Back & Front	
2273	2813	3525		3743	
2354	2966	3711		3944	
2485	3135	3939		4197	
2378	2950	3700		3927	
2460	3110	3897		4135	
2596	3292	4133		4405	

If Counterweight is specified, add 168

Pricing is continued on the following page.

U F L S
Lateral File – Standard
(Continued)

DIMENSIONS
FOR MM X BY 25.4

PRICING

			FILE/FILE/FILE (R)			
			SOURCE LAMINATE CASE		FLINTWOOD CASE	VENEER CASE
H	D	W	Source Lam. Back & Front	Source Lam. Back, Flintwood Front	Flintwood Back & Front	Veneer Back & Front
42	16	24	2058	2617	3307	3527
42	16	30	2123	2755	3482	3711
42	16	36	2240	2916	3697	3952
42	19	24	2159	2755	3482	3711
42	19	30	2230	2900	3665	3907
42	19	36	2352	3071	3889	4159

If Counterweight is specified, add 168

UBKE

Bookcase – Elevated

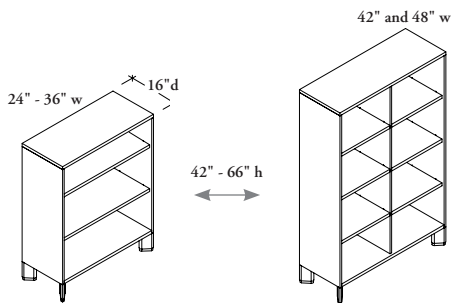

The Elevated Bookcase provides height-adjustable shelves for binder storage in addition to a base to support most Stackers. It can also be used to support panels.

WHAT'S INCLUDED

1 cabinet, 4 angled feet, grommet (if specified);

Adjust. Shelves	24" - 36" w	42" and 48" w
42" h	2	4
51" h	2	4
66" h	3	6

NOTES

Bookcases **cannot** be stacked on top of other base units, must use Open Stackers.

24", 30" and 36" wide bookcases **cannot** be specified with Electrical Cut Out (GL and GR) options.

42" and 48" wide bookcases **cannot** be specified with Electrical Cut Out (GC) option.

Grommets are finished in Platinum.

PRODUCT OPTIONS

Height	Width	Case & Back Finish	Foot Finish	Electrical Cut Out
42, 51, 66	24, 30, 36, 42, 48	Source Laminate Flintwood Natural Veneer	Q Storm White 7 Platinum V Very White X Anthracite M Graphite 2 Burnished Bronze	GL Base Grommet, Left GR Base Grommet, Right GC Base Grommet, Center NN None

SAMPLE ORDER CODE

		Case	Back		
UBKE 42	42	HL	HL	Q	GL

DIMENSIONS INCHES / MM

H	W
42 / 1067	24 / 610
42 / 1067	30 / 762
42 / 1067	36 / 914
42 / 1067	42 / 1067
42 / 1067	48 / 1219
51 / 1295	24 / 610
51 / 1295	30 / 762
51 / 1295	36 / 914
51 / 1295	42 / 1067
51 / 1295	48 / 1219
66 / 1676	24 / 610
66 / 1676	30 / 762
66 / 1676	36 / 914
66 / 1676	42 / 1067
66 / 1676	48 / 1219

PRICING

SOURCE LAMINATE CASE	FLINTWOOD CASE	VENEER CASE
Source Lam. Back	Flintwood Back	Veneer Back
1209	2502	2528
1258	3060	3088
1294	3663	3700
1407	4264	4304
1469	4866	4915
1258	2849	2875
1299	3452	3485
1341	4082	4121
1458	4684	4727
1522	5282	5335
1486	3443	3475
1548	4025	4063
1601	4608	4652
1745	5194	5241
1824	5776	5832

If Grommet is specified, add 147

The Standard Bookcase provides height-adjustable shelves for binder storage in addition to a base to support most Stackers. It can also be used to support panels.

WHAT'S INCLUDED

1 cabinet;

Adjust. Shelves	24" - 36" w	42" and 48" w
42" h	2	4
51" h	3	6
66" h	4	8

Extra kit that contains two 1-1/4" levelers and two 1-3/4" levelers will be shipped with the storage.

NOTES

Bookcases **cannot** be stacked on top of other base units, must use Open Stackers.

**UBKS
Bookcase – Standard**

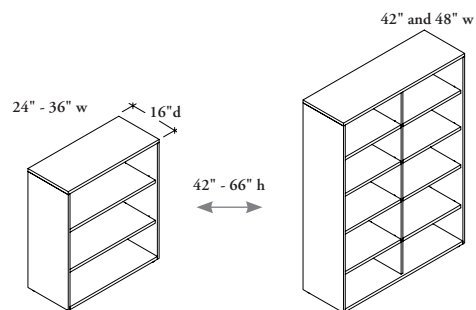

PRODUCT OPTIONS

Height	Width	Case & Back Finish
42, 51, 66	24, 30, 36, 42, 48	Source Laminate Flintwood Natural Veneer

SAMPLE ORDER CODE

		Case	Back
UBKS 42	30	HL	HL

**DIMENSIONS
INCHES / MM**

H	W
42 / 1067	24 / 610
42 / 1067	30 / 762
42 / 1067	36 / 914
42 / 1067	42 / 1067
42 / 1067	48 / 1219
51 / 1295	24 / 610
51 / 1295	30 / 762
51 / 1295	36 / 914
51 / 1295	42 / 1067
51 / 1295	48 / 1219
66 / 1676	24 / 610
66 / 1676	30 / 762
66 / 1676	36 / 914
66 / 1676	42 / 1067
66 / 1676	48 / 1219

PRICING

SOURCE LAMINATE CASE	FLINTWOOD CASE	VENEER CASE
Source Lam. Back	Flintwood Back	Veneer Back
1042	2337	2360
1088	2893	2921
1125	3497	3531
1239	4098	4137
1302	4699	4746
1088	2682	2707
1131	3282	3316
1176	3912	3952
1291	4516	4561
1354	5119	5168
1320	3275	3307
1380	3858	3898
1433	4444	4486
1578	5025	5076
1658	5608	5662

ULDE

Low Full Drawer Credenza – Elevated

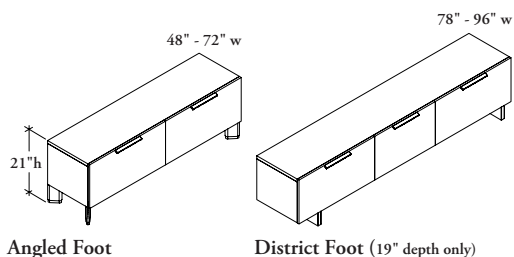

The Elevated Low Full Drawer Credenza provides file storage, the capability to support worksurfaces, stackers and panels and the ability to route and provide access to power and data.

WHAT'S INCLUDED

1 credenza, file drawers with pulls (as specified), 2 District feet or 4 angled feet (as specified), 2" high pencil drawer with removable organizing tray (if specified), lock and keys (if specified), counterweight (if specified).

WHAT'S EXCLUDED

A Seat Cushion (UWLC) or Fitted Seated Cushion (UWLF) can be ordered separately. Can be found in the *Accessories* section.

NOTES

The 16" deep credenza **cannot** be specified with Red Drawer Accessories.

The 16" deep credenza **cannot** be specified with a District Foot (D).

The District Foot (D) **cannot** be specified with the Electrical Cut Out (BL and BR) options. (NN) must be selected.

If Red Drawer Accessories are selected, they will be located in the center drawer (for 78" - 96" widths) or in the left drawer (for 42" - 72" widths).

PRODUCT OPTIONS

Depth	Width	Pull Style	Pull Finish	Case, Back & Front Finish	Foot Finish	Foot Style	Electrical Cut Out	Red Drawer Accessories	Key Style	Counterweight
16, 19	48, 60, 72, 78, 84, 90, 96	D District	Foundation Mica	Source Laminate Flintwood Natural Veneer	Q Storm White 7 Platinum V Very White X Anthracite M Graphite 2 Burnished Bronze	D District A Angled Foot	BL Base Back Cut Out, Left BR Base Back Cut Out, Right NN None BC Base Back Cut Out, Center	Y Yes N No	K Keyed Alike R Keyed Randomly N No Lock	1 Yes
		R Rectangular								2 No

SAMPLE ORDER CODE

SAMPLE ORDER CODE		Case Back Front										
ULDE 19	48	D	Q	ZA	ZA	ZA	7	A	BR	Y	K	1

DIMENSIONS
INCHES / MM

D	W
16 / 406	48 / 1219
16 / 406	60 / 1524
16 / 406	72 / 1829
16 / 406	78 / 1981
16 / 406	84 / 2134
16 / 406	90 / 2286
16 / 406	96 / 2438
19 / 483	48 / 1219
19 / 483	60 / 1524
19 / 483	72 / 1829
19 / 483	78 / 1981
19 / 483	84 / 2134
19 / 483	90 / 2286
19 / 483	96 / 2438

PRICING

SOURCE LAMINATE CASE		FLINTWOOD CASE	VENEER CASE
Source Lam. Back & Front	Source Lam. Back, Flintwood Front	Flintwood Back & Front	Veneer Back & Front
2317	2830	3662	3861
2421	3013	4056	4269
2584	3374	4561	4793
2912	3536	4577	4830
3044	3706	4802	5066
3245	3967	5370	5637
n/a	n/a	5591	5868
2438	2978	3854	4064
2550	3178	4270	4494
2719	3551	4799	5046
3066	3723	4818	5082
3203	3904	5054	5333
3418	4175	5652	5931
n/a	n/a	5885	6176

If Base Back Cut Out is specified, add 105

If Red Drawer Accessories are specified, add 208

If Counterweight is specified, add 168 for widths of 48" - 72"

If Counterweight is specified, add 334 for widths of 78" - 96"

The Standard Low Full Drawer Credenza provides file storage with the capability to support worksurfaces, stackers and panels.

WHAT'S INCLUDED

1 credenza, box/file drawers with pulls (as specified), lock and keys (if specified), counterweight (if specified).

WHAT'S EXCLUDED

A Seat Cushion (UWLC) or Fitted Seated Cushion (UWLF) can be ordered separately. Can be found in the *Accessories* section.

NOTES

This product includes extended levelers (UNSLB) already installed.

U L D S
Low Full Drawer Credenza – Standard

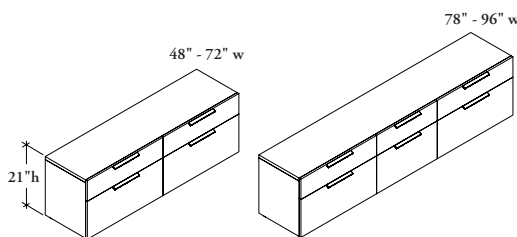

PRODUCT OPTIONS

Depth	Width	Pull Style	Pull Finish	Case, Back & Front Finish	Key Style	Counterweight
16, 19	48, 60, 72, 78, 84, 90, 96	D District R Rectangular	Foundation Mica	Source Laminate Flintwood Natural Veneer	K Keyed Alike R Keyed Randomly N No Lock	1 Yes 2 No

SAMPLE ORDER CODE

				Case	Back	Front		
ULDS 19	48	D	7	ZA	ZA	ZA	K	1

**DIMENSIONS
INCHES / MM**

D	W
16 / 406	48 / 1219
16 / 406	60 / 1524
16 / 406	72 / 1829
16 / 406	78 / 1981
16 / 406	84 / 2134
16 / 406	90 / 2286
16 / 406	96 / 2438
19 / 483	48 / 1219
19 / 483	60 / 1524
19 / 483	72 / 1829
19 / 483	78 / 1981
19 / 483	84 / 2134
19 / 483	90 / 2286
19 / 483	96 / 2438

PRICING

SOURCE LAMINATE CASE		FLINTWOOD CASE	VENEER CASE
Source Lam. Back & Front	Source Lam. Back, Flintwood Front	Flintwood Back & Front	Veneer Back & Front
2425	3333	4300	4527
2550	3501	4437	4672
2738	3755	5464	5720
3188	4367	6099	6367
3349	4579	7055	7339
3600	4919	7370	7663
n/a	n/a	7604	7906
2553	3505	4535	4774
2683	3681	4681	4926
2882	3950	5761	6029
3354	4588	6429	6713
3526	4818	7433	7734
3788	5173	7766	8076
n/a	n/a	8011	8330

If Counterweight is specified, add 168 for widths of 48" - 72"

If Counterweight is specified, add 334 for widths of 78" - 96"

U H D E

High Full Drawer Credenza – Elevated

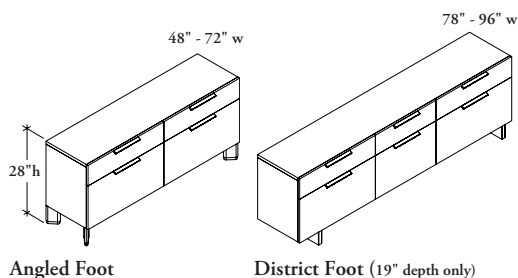

The Elevated High Full Drawer Credenza provides file storage, the capability to support worksurfaces, stackers and panels and the ability to route and provide access to Power and data.

WHAT'S INCLUDED

1 credenza, box/file drawers with pulls (as specified), 2 District feet or 4 angled feet (as specified), lock and keys (if specified), counterweight (if specified).

WHAT'S EXCLUDED

A Seat Cushion (UWLC) or Fitted Seated Cushion (UWLF) can be ordered separately. Can be found in the *Accessories* section.

NOTES

The 16" deep credenza **cannot** be specified with a District Foot (D).

The District Foot (D) **cannot** be specified with the Electrical Cut Out (BL, BR and BC) options. (NN) must be selected.

48", 60" and 72" wide credenzas **cannot** be specified with the Electrical Cut Out (BC) option.

PRODUCT OPTIONS

Drawer Combination	Depth	Width	Pull Style	Pull Finish	Case, Back & Front Finish	Foot Finish	Foot Style	Electrical Cut Out	Key Style	Counterweight
X Box/File	16, 19	48, 60, 72, 78, 84, 90, 96	D District R Rectangular	Foundation Mica	Source Laminate Flintwood Natural Veneer	Q Storm White 7 Platinum V Very White X Anthracite M Graphite 2 Burnished Bronze	D District A Angled Foot	BL Base Back Cut Out, Left BR Base Back Cut Out, Right BC Base Back Cut Out, Center NN None	K Keyed Alike R Keyed Randomly N No Lock	1 Yes 2 No

SAMPLE ORDER CODE

Case Back Front

UHDE X	19	48	D	7	ZA	ZA	ZA	7	A	BL	K	1
--------	----	----	---	---	----	----	----	---	---	----	---	---

DIMENSIONS
INCHES / MM

PRICING

		BOX/FILE (X)			
		SOURCE LAMINATE CASE		FLINTWOOD CASE	VENEER CASE
D	W	Source Lam. Back & Front	Source Lam. Back, Flintwood Front	Flintwood Back & Front	Veneer Back & Front
16 / 406	48 / 1219	2646	3573	4556	4790
16 / 406	60 / 1524	2772	3743	4699	4939
16 / 406	72 / 1829	2966	4004	5749	6008
16 / 406	78 / 1981	3423	4625	6398	6669
16 / 406	84 / 2134	3586	4844	7369	7661
16 / 406	90 / 2286	3845	5190	7692	7992
16 / 406	96 / 2438	n/a	n/a	7931	8240
19 / 483	48 / 1219	2776	3749	4799	5043
19 / 483	60 / 1524	2909	3928	4947	5199
19 / 483	72 / 1829	3112	4203	6050	6325
19 / 483	78 / 1981	3597	4855	6734	7021
19 / 483	84 / 2134	3769	5087	7759	8066
19 / 483	90 / 2286	4037	5450	8097	8412
19 / 483	96 / 2438	n/a	n/a	8349	8674

If Base Back Cut Out is specified, add 107

If Counterweight is specified, add 171 for widths of 48" - 72"

If Counterweight is specified, add 341 for widths of 78" - 96"

U H D S

High Full Drawer Credenza – Standard

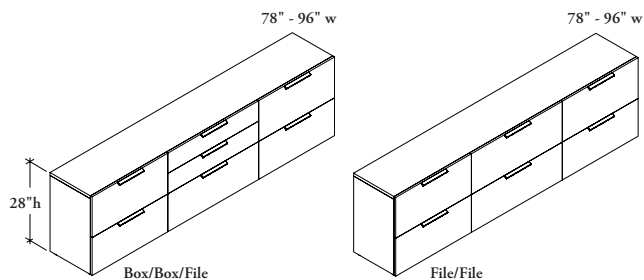

The Standard High Full Drawer Credenza provides file storage with the capability to support worksurfaces, stackers and panels.

WHAT'S INCLUDED

1 credenza, box/box/file or file/file drawers with pulls (as specified), lock and keys (if specified), counterweight (if specified).

WHAT'S EXCLUDED

A Seat Cushion (UWLC) or Fitted Seated Cushion (UWLF) can be ordered separately. Can be found in the *Accessories* section.

NOTES

If Box/Box/File (B) is selected for widths wider than 72", only the center drawers will have a box/box/file drawer combination. For 42" - 72" widths, the box/box/file drawers will be applied in both left and right drawer locations.

This product includes extended levelers (UNSLB) already installed.

PRODUCT OPTIONS

Drawer Combination	Depth	Width	Pull Style	Pull Finish	Case, Back & Front Finish	Key Style	Counterweight
B Box/Box/File	16, 19	48, 60, 72, 78, 84, 90, 96	D District	Foundation	Source Laminate Flintwood Natural Veneer	K Keyed Alike	1 Yes
F File/File			R Rectangular	Mica		R Keyed Randomly N No Lock	2 No

SAMPLE ORDER CODE

UHDS	F	19	48	D	7	Case	Back	Front	K	1											
						ZA	ZA	ZA													
<table border="1" style="width:100%; text-align:center;"> <tr> <td>UHDS</td> <td>F</td> <td>19</td> <td>48</td> <td>D</td> <td>7</td> <td>ZA</td> <td>ZA</td> <td>ZA</td> <td>K</td> <td>1</td> </tr> </table>											UHDS	F	19	48	D	7	ZA	ZA	ZA	K	1
UHDS	F	19	48	D	7	ZA	ZA	ZA	K	1											

**DIMENSIONS
INCHES / MM**

D	W
16 / 406	48 / 1219
16 / 406	60 / 1524
16 / 406	72 / 1829
16 / 406	78 / 1981
16 / 406	84 / 2134
16 / 406	90 / 2286
16 / 406	96 / 2438
19 / 483	48 / 1219
19 / 483	60 / 1524
19 / 483	72 / 1829
19 / 483	78 / 1981
19 / 483	84 / 2134
19 / 483	90 / 2286
19 / 483	96 / 2438

PRICING

BOX/BOX/FILE (B)					
SOURCE LAMINATE CASE		FLINTWOOD CASE		VENEER CASE	
Source Lam. Back & Front	Source Lam. Back, Flintwood Front	Flintwood Back & Front	Veneer Back & Front		
3117	4420	5411	5572		
3249	4629	5673	5846		
3463	4942	6080	6266		
3852	5782	7165	7393		
4028	6076	7530	7770		
4320	6509	8097	8358		
n/a	n/a	8268	8533		
3259	4629	5673	5845		
3399	4850	5948	6130		
3625	5178	6377	6574		
4042	6076	7531	7770		
4228	6382	7915	8170		
4539	6838	8514	8787		
n/a	n/a	8689	8971		

If Counterweight is specified, add 171 for widths of 48" - 72"

If Counterweight is specified, add 341 for widths of 78" - 96"

Pricing is continued on the following page.

UHDS

High Full Drawer Credenza – Standard (Continued)

DIMENSIONS
INCHES / MM
PRICING

DIMENSIONS INCHES / MM		FILE/FILE (F)			
		SOURCE LAMINATE CASE		FLINTWOOD CASE	VENEER CASE
D	W	Source Lam. Back & Front	Source Lam. Back, Flintwood Front	Flintwood Back & Front	Veneer Back & Front
16 / 406	48 / 1219	2692	3992	4983	5148
16 / 406	60 / 1524	2823	4205	5245	5418
16 / 406	72 / 1829	3039	4515	5653	5840
16 / 406	78 / 1981	3637	5569	6950	7180
16 / 406	84 / 2134	3813	5864	7314	7558
16 / 406	90 / 2286	4108	6297	7885	8145
16 / 406	96 / 2438	n/a	n/a	8052	8320
19 / 483	48 / 1219	2833	4205	5245	5417
19 / 483	60 / 1524	2971	4425	5523	5705
19 / 483	72 / 1829	3198	4751	5952	6148
19 / 483	78 / 1981	3830	5864	7317	7558
19 / 483	84 / 2134	4014	6172	7701	7957
19 / 483	90 / 2286	4324	6628	8301	8574
19 / 483	96 / 2438	n/a	n/a	8477	8759

If Counterweight is specified, add 171 for widths of 48" - 72"

If Counterweight is specified, add 341 for widths of 78" - 96"

U L O E

Low Open Credenza – Elevated

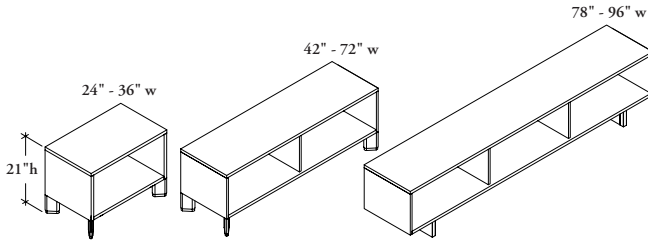

Angled Foot

District Foot (19" depth only)

The Elevated Low Open Credenza provides open binder storage, the capability to support worksurfaces, stackers and panels and the ability to route and provide access to power and data.

WHAT'S INCLUDED

1 credenza, 2 District feet or 4 angled feet (as specified), grommets (if specified), 42" - 72" widths include one divider; 78" - 96" widths include two dividers.

WHAT'S EXCLUDED

A Seat Cushion (UWLC) or Fitted Seated Cushion (UWLF) can be ordered separately. Can be found in the *Accessories* section.

NOTES

16" deep credenzas **cannot** be specified with a District Foot (D).

24" wide credenzas **cannot** be specified with a District Foot (D).

Electrical Cut Out options are **not** available when the District Foot (D) is specified. (NN) must be selected.

24", 30" and 36" wide credenzas **cannot** be specified with the Electrical Cut Out (TL, TR and TB) options.

42", 48", 54", 60", 66" and 72" wide credenzas **cannot** be specified with the Electrical Cut Out (TC) option.

Grommets are finished in Platinum.

PRODUCT OPTIONS

Depth	Width	Case & Back Finish	Foot Finish	Foot Style	Electrical Cut Out
16, 19	24, 30, 36, 42, 48, 54, 60, 66, 72, 78, 84, 90, 96	Source Laminate Flintwood Natural Veneer	Q Storm White 7 Platinum V Very White X Anthracite M Graphite 2 Burnished Bronze	D District A Angled Foot	TL Base and Top Grommet, Left TR Base and Top Grommet, Right TB Base and Top Grommet, Left and Right TC Base and Top Grommet, Center NN None

SAMPLE ORDER CODE

		Case	Back			
U L O E 16	48	HL	HL	Q	A	TL

DIMENSIONS
INCHES / MM

D	W
16 / 406	24 / 610
16 / 406	30 / 762
16 / 406	36 / 914
16 / 406	42 / 1067
16 / 406	48 / 1219
16 / 406	54 / 1372
16 / 406	60 / 1524
16 / 406	66 / 1676
16 / 406	72 / 1829
16 / 406	78 / 1981
16 / 406	84 / 2134
16 / 406	90 / 2286
16 / 406	96 / 2438
19 / 483	24 / 610
19 / 483	30 / 762
19 / 483	36 / 914
19 / 483	42 / 1067
19 / 483	48 / 1219
19 / 483	54 / 1372
19 / 483	60 / 1524
19 / 483	66 / 1676
19 / 483	72 / 1829
19 / 483	78 / 1981
19 / 483	84 / 2134
19 / 483	90 / 2286
19 / 483	96 / 2438

PRICING

SOURCE LAMINATE CASE	FLINTWOOD CASE	VENEER CASE
Source Lam. Back	Flintwood Back	Veneer Back
848	1940	2024
893	2042	2129
942	2220	2309
1016	2453	2550
1061	2632	2732
1103	2871	2970
1147	3049	3150
1194	3288	3385
1248	3466	3564
1351	3704	3803
1411	3882	3982
1472	4121	4222
n/a	4267	4368
882	2042	2129
929	2149	2241
981	2337	2430
1062	2584	2683
1105	2771	2873
1150	3021	3127
1198	3210	3312
1249	3459	3564
1303	3649	3753
1415	3899	4005
1476	4087	4193
1538	4338	4444
n/a	4493	4597

If Grommet is specified, add 208 for left, right or center grommet

If Grommet is specified, add 348 for left and right grommet

U L O S

Low Open Credenza – Standard

The Standard Low Open Credenza provides open binder storage with the capability to support worksurfaces, stackers and panels.

WHAT'S INCLUDED

1 credenza, 24" - 36" widths include one height-adjustable shelf; 42" - 72" widths include 1 divider and 2 height-adjustable shelves; 78" - 96" widths include 2 dividers and 3 height-adjustable shelves.

Extra kit that contains two 1-1/4" levelers and two 1-3/4" levelers will be shipped with the storage.

WHAT'S EXCLUDED

A Seat Cushion (UWLC) or Fitted Seated Cushion (UWLF) can be ordered separately. Can be found in the *Accessories* section.

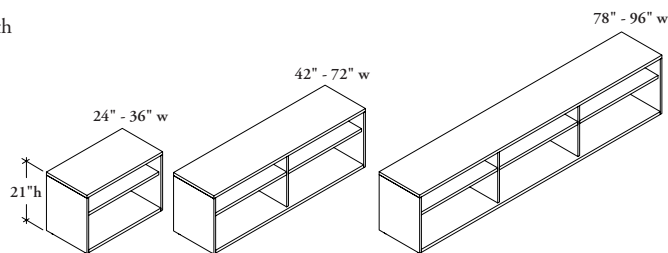

PRODUCT OPTIONS

Depth	Width	Case & Back Finish
16, 19	24, 30, 36, 42, 48, 54, 60, 66, 72, 78, 84, 90, 96	Source Laminate Flintwood Natural Veneer

SAMPLE ORDER CODE

		Case	Back
ULOS 16	30	HL	HL

**DIMENSIONS
INCHES / MM**

D	W
16 / 406	24 / 610
16 / 406	30 / 762
16 / 406	36 / 914
16 / 406	42 / 1067
16 / 406	48 / 1219
16 / 406	54 / 1372
16 / 406	60 / 1524
16 / 406	66 / 1676
16 / 406	72 / 1829
16 / 406	78 / 1981
16 / 406	84 / 2134
16 / 406	90 / 2286
16 / 406	96 / 2438
19 / 483	24 / 610
19 / 483	30 / 762
19 / 483	36 / 914
19 / 483	42 / 1067
19 / 483	48 / 1219
19 / 483	54 / 1372
19 / 483	60 / 1524
19 / 483	66 / 1676
19 / 483	72 / 1829
19 / 483	78 / 1981
19 / 483	84 / 2134
19 / 483	90 / 2286
19 / 483	96 / 2438

PRICING

SOURCE LAMINATE CASE	FLINTWOOD CASE	VENEER CASE
Source Lam. Back	Flintwood Back	Veneer Back
660	1773	1858
704	1873	1964
753	2051	2145
829	2286	2382
870	2466	2562
914	2703	2801
960	2882	2982
1006	3119	3220
1062	3300	3397
1163	3536	3635
1224	3714	3813
1284	3952	4053
n/a	4099	4199
695	1873	1964
742	1981	2074
794	2169	2263
871	2416	2516
917	2603	2706
962	2855	2958
1009	3042	3148
1064	3294	3397
1115	3481	3584
1227	3731	3835
1287	3921	4024
1351	4171	4273
n/a	4323	4427

U H O E

High Open Credenza – Elevated

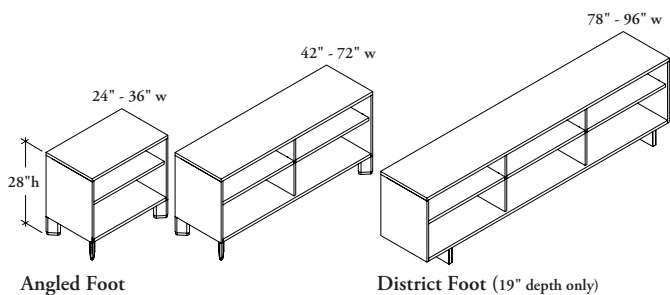

The Elevated High Open Credenza provides open binder storage, the capability to support worksurfaces, stackers and panels and the ability to route and provide access to power and data.

WHAT'S INCLUDED

1 credenza, 2 District feet or 4 angled feet (as specified), grommets (if specified), 24\" - 36\" widths include one height-adjustable shelf; 42\" - 72\" widths include 1 divider and 2 height-adjustable shelves; 78\" - 96\" widths include 2 dividers and 3 height-adjustable shelves.

WHAT'S EXCLUDED

A Seat Cushion (UWLC) or Fitted Seated Cushion (UWLF) can be ordered separately. Can be found in the *Accessories* section.

NOTES

16\" deep credenzas **cannot** be specified with a District Foot (D).

24\" wide credenzas **cannot** be specified with a District Foot (D).

Electrical Cut Out options are **not** available when the District Foot (D) is specified. (NN) must be selected.

24\", 30\" and 36\" widths **cannot** be specified with the Electrical Cut Out (TL, TR & TB) options.

42\", 48\", 54\", 60\", 66\" and 72\" widths **cannot** be specified with the Electrical Cut Out (TC) option.

Grommets are finished in Platinum.

PRODUCT OPTIONS

Depth	Width	Case & Back Finish	Foot Finish	Foot Style	Electrical Cut Out
16, 19	24, 30, 36, 42, 48, 54, 60, 66, 72, 78, 84, 90, 96	Source Laminate Flintwood Natural Veneer	Q Storm White 7 Platinum V Very White X Anthracite M Graphite 2 Burnished Bronze	D District A Angled Foot	TL Base and Top Grommet, Left TR Base and Top Grommet, Right TB Base and Top Grommet, Left and Right TC Base and Top Grommet, Center NN None

SAMPLE ORDER CODE

		Case	Back			
UHOE 16	84	HL	HL	7	A	TC

See Pricing on the following page.

U H O E
High Open Credenza – Elevated
(Continued)

DIMENSIONS
INCHES / MM
PRICING

DIMENSIONS INCHES / MM		PRICING		
		SOURCE LAMINATE CASE	FLINTWOOD CASE	VENEER CASE
D	W	Source Lam. Back	Flintwood Back	Veneer Back
16 / 406	24 / 610	944	2452	2557
16 / 406	30 / 762	996	2579	2692
16 / 406	36 / 914	1051	2794	2921
16 / 406	42 / 1067	1143	3110	3256
16 / 406	48 / 1219	1190	3312	3469
16 / 406	54 / 1372	1241	3514	3684
16 / 406	60 / 1524	1297	3725	3900
16 / 406	66 / 1676	1352	3976	4161
16 / 406	72 / 1829	1413	4225	4421
16 / 406	78 / 1981	1536	4757	4904
16 / 406	84 / 2134	1606	4933	5159
16 / 406	90 / 2286	1677	5409	5650
16 / 406	96 / 2438	n/a	5612	5863
19 / 483	24 / 610	985	2579	2692
19 / 483	30 / 762	1040	2715	2834
19 / 483	36 / 914	1102	2942	3077
19 / 483	42 / 1067	1192	3274	3425
19 / 483	48 / 1219	1243	3488	3652
19 / 483	54 / 1372	1299	3702	3877
19 / 483	60 / 1524	1357	3922	4104
19 / 483	66 / 1676	1416	4184	4379
19 / 483	72 / 1829	1478	4448	4652
19 / 483	78 / 1981	1608	5007	5161
19 / 483	84 / 2134	1682	5196	5430
19 / 483	90 / 2286	1757	5691	5950
19 / 483	96 / 2438	n/a	5909	6174

If Grommet is specified, add 208 for left, right or center grommet

If Grommet is specified, add 348 for left and right grommet

UHOS

High Open Credenza – Standard

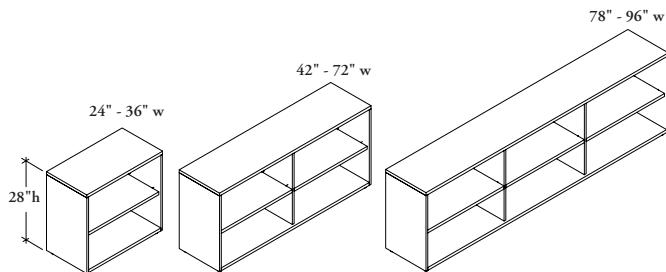

The Standard High Open Credenza provides open binder storage with the capability to support worksurfaces, stackers and panels.

WHAT'S INCLUDED

1 credenza, 24" - 36" widths include 1 height-adjustable shelf; 42" - 72" widths include 1 divider and 2 height-adjustable shelves; 78" - 96" widths include 2 dividers and 3 height-adjustable shelves.

Extra kit that contains two 1-1/4" levelers and two 1-3/4" levelers will be shipped with the storage.

WHAT'S EXCLUDED

A Seat Cushion (UWLC) or Fitted Seated Cushion (UWLF) can be ordered separately. Can be found in the *Accessories* section.

PRODUCT OPTIONS

Depth	Width	Case & Back Finish
16, 19	24, 30, 36, 42, 48, 54, 60, 66, 72, 78, 84, 90, 96	Source Laminate Flintwood Natural Veneer

SAMPLE ORDER CODE

		Case	Back
UHOS 16	84	HL	HL

DIMENSIONS
INCHES / MM

D	W
16 / 406	24 / 610
16 / 406	30 / 762
16 / 406	36 / 914
16 / 406	42 / 1067
16 / 406	48 / 1219
16 / 406	54 / 1372
16 / 406	60 / 1524
16 / 406	66 / 1676
16 / 406	72 / 1829
16 / 406	78 / 1981
16 / 406	84 / 2134
16 / 406	90 / 2286
16 / 406	96 / 2438
19 / 483	24 / 610
19 / 483	30 / 762
19 / 483	36 / 914
19 / 483	42 / 1067
19 / 483	48 / 1219
19 / 483	54 / 1372
19 / 483	60 / 1524
19 / 483	66 / 1676
19 / 483	72 / 1829
19 / 483	78 / 1981
19 / 483	84 / 2134
19 / 483	90 / 2286
19 / 483	96 / 2438

PRICING

SOURCE LAMINATE CASE	FLINTWOOD CASE	VENEER CASE
Source Lam. Back	Flintwood Back	Veneer Back
776	2282	2389
829	2413	2523
888	2627	2755
974	2942	3086
1026	3148	3303
1075	3349	3516
1128	3558	3733
1187	3809	3995
1245	4056	4255
1370	4588	4736
1440	4769	4990
1511	5240	5483
n/a	5449	5697
818	2413	2523
871	2549	2666
932	2775	2908
1028	3108	3259
1078	3320	3486
1131	3533	3710
1190	3754	3937
1249	4017	4213
1312	4279	4486
1443	4840	4995
1515	5027	5264
1590	5525	5780
n/a	5743	6005

ULHE

Low Open with Drawer Credenza – Elevated

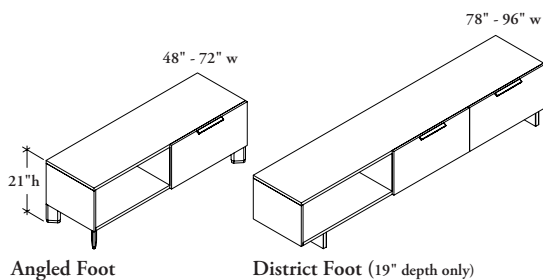

The Elevated Low Open Drawer Credenza provides both file storage and open binder storage, the capability to support worksurfaces, stackers and panels and the ability to route and provide access to power and data.

WHAT'S INCLUDED

1 credenza, 2 District feet or 4 angled feet (as specified), 2" high pencil drawer with removable organizing tray (if specified), lock and keys (if specified), counterweight (if specified), grommets (if specified), 30" - 72" widths include one file drawer and 1 pull; 78" - 96" widths include 2 file drawers and 2 pulls.

WHAT'S EXCLUDED

A Seat Cushion (UWLC) or Fitted Seated Cushion (UWLF) can be ordered separately. Can be found in the *Accessories* section.

NOTES

The 16" deep credenza **cannot** be specified with a District Foot (D).

Electrical Cut Out options are **not** available when the District Foot (D) is specified. (N) must be selected. Electrical cut out is only available on widths 48" - 96".

When Base Back Electrical Cut Out (B) option is specified, the cut out will appear on the back and the base of the drawer unit. When there are two drawers (78" - 96" w) the cut out will appear on the outside drawer unit (not the center drawer). If Base and Top Grommet (T) is specified, grommet will appear in the cubby.

The 16" deep credenza **cannot** be specified with Red Drawer Accessories.

If Red Drawer Accessories are selected on credenzas wider than 72" (two drawers), the accessories will be located in the left drawer.

Grommets are finished in Platinum.

Red Drawer Accessories are not available if widths 30", 36" or 42" is specified.

PRODUCT OPTIONS

Depth	Width	Open Compartment Location	Pull Style	Pull Finish	Case, Back & Front Finish
16, 19	30, 36, 42, 48, 54, 60, 66, 72, 78, 84, 90, 96	L Left (shown) R Right	D District R Rectangular	Foundation Mica	Source Laminate Flintwood Natural Veneer

SAMPLE ORDER CODE

					Case	Back	Front
ULHE 19	48	R	D	7	ZA	ZA	ZA

PRODUCT OPTIONS CONTINUED

Foot Finish	Foot Style	Electrical Cut Out	Red Drawer Accessories	Key Style	Counterweight
Q Storm White	D District	B Base Back Cut Out	Y Yes	K Keyed Alike	1 Yes
7 Platinum	A Angled Foot	T Base and Top Grommet	N No	R Keyed Randomly	2 No
V Very White		N None		N No Lock	
X Anthracite					
M Graphite					
2 Burnished Bronze					

SAMPLE ORDER CODE CONTINUED

7	A	N	Y	K	2
---	---	---	---	---	---

See Pricing on the following page.

ULHE

Low Open with Drawer Credenza – Elevated (Continued)

DIMENSIONS
INCHES / MM
PRICING

DIMENSIONS INCHES / MM		SOURCE LAMINATE CASE		FLINTWOOD CASE	VENEER CASE
		Source Lam. Back & Front	Source Lam. Back, Flintwood Front	Flintwood Back & Front	Veneer Back & Front
D	W				
16 / 406	30 / 762	1545	1998	2737	2873
16 / 406	36 / 914	1590	2055	2819	2959
16 / 406	42 / 1067	1637	2117	2904	3049
16 / 406	48 / 1219	1686	2181	2990	3141
16 / 406	54 / 1372	1735	2273	3184	3342
16 / 406	60 / 1524	1784	2363	3376	3542
16 / 406	66 / 1676	1851	2500	3594	3774
16 / 406	72 / 1829	1917	2638	3812	4005
16 / 406	78 / 1981	2369	2967	4030	4232
16 / 406	84 / 2134	2473	3098	4227	4440
16 / 406	90 / 2286	2628	3267	4656	4889
16 / 406	96 / 2438	n/a	n/a	4844	5086
19 / 483	30 / 762	1623	2104	2881	3022
19 / 483	36 / 914	1672	2165	2967	3114
19 / 483	42 / 1067	1722	2230	3054	3207
19 / 483	48 / 1219	1773	2297	3148	3304
19 / 483	54 / 1372	1824	2392	3350	3516
19 / 483	60 / 1524	1873	2489	3553	3731
19 / 483	66 / 1676	1944	2632	3781	3973
19 / 483	72 / 1829	2011	2776	4011	4213
19 / 483	78 / 1981	2492	3124	4244	4455
19 / 483	84 / 2134	2600	3262	4450	4673
19 / 483	90 / 2286	2763	3438	4904	5151
19 / 483	96 / 2438	n/a	n/a	5097	5352

If Base Back Cut Out is specified, add 105

If Base & Top Grommet is specified, add 208

If Red Drawer Accessories are specified, add 208

If Counterweight is specified, add 168

ULHS

Low Open with Drawer Credenza – Standard

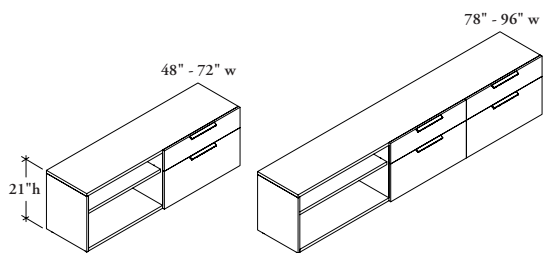

The Standard Low Open Drawer Credenza provides both file storage and open binder storage with the capability to support worksurfaces, stackers and panels.

WHAT'S INCLUDED

1 credenza, lock and keys (if specified), counterweight (if specified), 48" - 72" widths include 1 height-adjustable shelf, 1 box/file drawer and 2 pulls; 78" - 96" widths include 1 height-adjustable shelf, 2 box/file drawers and 4 pulls.

Extra kit that contains two 1-1/4" levelers and two 1-3/4" levelers will be shipped with the storage.

WHAT'S EXCLUDED

A Seat Cushion (UWLC) or Fitted Seated Cushion (UWLF) can be ordered separately. Can be found in the *Accessories* section.

PRODUCT OPTIONS

Depth	Width	Open Compartment Location	Pull Style	Pull Finish	Case, Back & Front Finish	Key Style	Counterweight
16, 19	30, 36, 42, 48, 54, 60, 66, 72, 78, 84, 90, 96	L Left (shown) R Right	D District R Rectangular	Foundation Mica	Source Laminate Flintwood Natural Veneer	K Keyed Alike R Keyed Randomly N No Lock	1 Yes 2 No

SAMPLE ORDER CODE

					Case	Back	Front		
ULHS 19	48	R	D	7	ZA	ZA	ZA	R	2

DIMENSIONS
INCHES / MM

D	W
16 / 406	30 / 762
16 / 406	36 / 914
16 / 406	42 / 1067
16 / 406	48 / 1219
16 / 406	54 / 1372
16 / 406	60 / 1524
16 / 406	66 / 1676
16 / 406	72 / 1829
16 / 406	78 / 1981
16 / 406	84 / 2134
16 / 406	90 / 2286
16 / 406	96 / 2438
19 / 483	30 / 762
19 / 483	36 / 914
19 / 483	42 / 1067
19 / 483	48 / 1219
19 / 483	54 / 1372
19 / 483	60 / 1524
19 / 483	66 / 1676
19 / 483	72 / 1829
19 / 483	78 / 1981
19 / 483	84 / 2134
19 / 483	90 / 2286
19 / 483	96 / 2438

PRICING

SOURCE LAMINATE CASE

Source Lam. Back & Front	Source Lam. Back, Flintwood Front
1690	2113
1738	2178
1793	2242
1846	2309
1906	2392
1966	2473
2045	2676
2125	2873
2786	3426
2928	3810
3133	3978
n/a	n/a
1779	2230
1832	2297
1887	2366
1944	2437
2006	2524
2070	2612
2155	2821
2238	3034
2935	3614
3082	4017
3301	4196
n/a	n/a

FLINTWOOD CASE

Flintwood Back & Front
3094
3190
3284
3383
3524
3661
4022
4381
5195
5881
6170
6373
3267
3366
3467
3572
3715
3860
4240
4621
5475
6200
6501
6716

VENEER CASE

Veneer Back & Front
3407
3510
3614
3723
3875
4026
4424
4820
5713
6469
6787
7009
3596
3703
3812
3926
4088
4246
4666
5084
6023
6820
7154
7387

If Counterweight is specified, add 168

U H H E

High Open with Drawer Credenza – Elevated

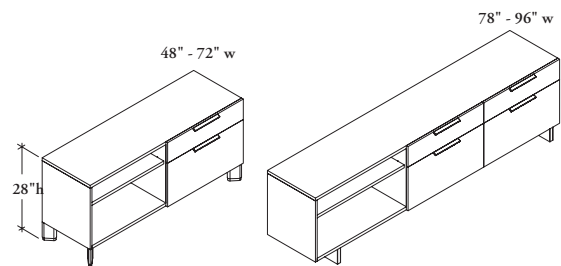

Angled Foot

District Foot (19" depth only)

The Elevated High Open Drawer Credenza provides both file storage and open binder storage, the capability to support worksurfaces, stackers and panels and the ability to route and provide access to power and data.

WHAT'S INCLUDED

1 credenza, 2 District feet or 4 angled feet (as specified), lock and keys (if specified), counterweight (if specified), grommets (if specified), 48" - 72" widths include 1 height-adjustable shelf, 1 box/file drawer and 2 pulls; 78" - 96" widths include 1 height-adjustable shelf, 2 box/file drawers and 4 pulls.

WHAT'S EXCLUDED

A Seat Cushion (UWLC) or Fitted Seated Cushion (UWLF) can be ordered separately. Can be found in the *Accessories* section.

NOTES

The 16" deep credenza **cannot** be specified with a District Foot (D).

Electrical Cut Out options are **not** available when the District Foot (D) is specified. (N) must be selected.

When Base Back Electrical Cut Out (B) option is specified, the cut out will appear on the back and the base of the drawer unit. When there are two drawers (78" - 96" w) the cut out will appear on the outside drawer unit (not the center drawer). If Base and Top Grommet (T) is specified, grommet will appear in the cubby.

Grommets are finished in Platinum.

PRODUCT OPTIONS

Drawer Combination	Depth	Width	Open Compartment Location	Pull Style	Pull Finish
X Box/File	16, 19	48, 54, 60, 66, 72, 78, 84, 90, 96	L Left (shown) R Right	D District R Rectangular	Foundation Mica

SAMPLE ORDER CODE

UHHE X	16	48	L	D	7
--------	----	----	---	---	---

PRODUCT OPTIONS CONTINUED

Case, Back & Front Finish	Foot Finish	Foot Style	Electrical Cut Out	Key Style	Counterweight
Source Laminate Flintwood Natural Veneer	Q Storm White 7 Platinum V Very White X Anthracite M Graphite 2 Burnished Bronze	D District A Angled Foot	B Base Back Cut Out T Base and Top Grommet N None	K Keyed Alike R Keyed Randomly N No Lock	1 Yes 2 No

SAMPLE ORDER CODE CONTINUED

Case	Back	Front					
ZA	ZA	ZA	7	A	B	R	2

See Pricing on the following page.

U H H E

High Open with Drawer Credenza – Elevated (Continued)

DIMENSIONS INCHES / MM

D	W
16 / 406	48 / 1219
16 / 406	54 / 1372
16 / 406	60 / 1524
16 / 406	66 / 1676
16 / 406	72 / 1829
16 / 406	78 / 1981
16 / 406	84 / 2134
16 / 406	90 / 2286
16 / 406	96 / 2438
19 / 483	48 / 1219
19 / 483	54 / 1372
19 / 483	60 / 1524
19 / 483	66 / 1676
19 / 483	72 / 1829
19 / 483	78 / 1981
19 / 483	84 / 2134
19 / 483	90 / 2286
19 / 483	96 / 2438

PRICING

BOX/FILE (X)

SOURCE LAMINATE CASE		FLINTWOOD CASE	VENEER CASE
Source Lam. Back & Front	Source Lam. Back, Flintwood Front	Flintwood Back & Front	Veneer Back & Front
2054	2519	3592	3930
2115	2600	3731	4084
2175	2683	3871	4234
2256	2883	4229	4633
2337	3083	4589	5028
2993	3635	5403	5922
3134	4020	6091	6678
3342	4187	6378	6995
n/a	n/a	6579	7216
2153	2647	3778	4134
2217	2735	3925	4299
2277	2820	4070	4455
2363	3031	4450	4876
2449	3238	4831	5294
3144	3823	5683	6231
3291	4226	6411	7030
3508	4405	6713	7360
n/a	n/a	6923	7597

If Base Back Cut Out is specified, add 105
 If Base & Top Grommet is specified, add 208
 If Counterweight is specified, add 168

U H H S

High Open with Drawer Credenza – Standard

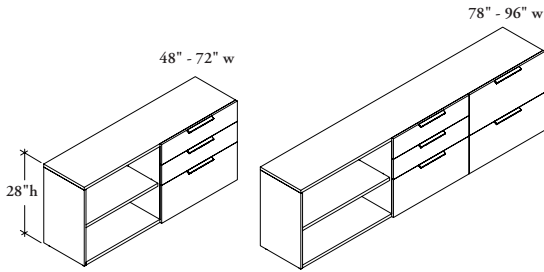

The Standard High Open Drawer Credenza provides both file storage and open binder storage with the capability to support worksurfaces, stackers and panels.

WHAT'S INCLUDED

1 credenza with 1 height-adjustable shelf, file/file or box/box/file drawers and pulls (as specified), lock and keys (if specified), counterweight (if specified).

Extra kit that contains two 1-1/4" levelers and two 1-3/4" levelers will be shipped with the storage.

WHAT'S EXCLUDED

A Seat Cushion (UWLC) or Fitted Seated Cushion (UWLF) can be ordered separately. Can be found in the *Accessories* section.

NOTES

If Box/Box/File (B) drawer combination is specified on widths 78" and greater, the box/box/file drawer will only appear in the middle section.

PRODUCT OPTIONS

Drawer Combination	Depth	Width	Open Compartment Location	Pull Style	Pull Finish	Case, Back & Front Finish	Key Style	Counterweight
B Box/Box/File (shown)	16, 19	48, 54, 60, 66, 72, 78, 84, 90, 96	L Left (shown) R Right	D District R Rectangular	Foundation Mica	Source Laminate Flintwood Natural Veneer	K Keyed Alike R Keyed Randomly N No Lock	1 Yes 2 No

SAMPLE ORDER CODE

							Case	Back	Front			
UHHS B	16	48	L	D	7	ZA	ZA	ZA	R	1		

DIMENSIONS

INCHES / MM

D	W
16 / 406	48 / 1219
16 / 406	54 / 1372
16 / 406	60 / 1524
16 / 406	66 / 1676
16 / 406	72 / 1829
16 / 406	78 / 1981
16 / 406	84 / 2134
16 / 406	90 / 2286
16 / 406	96 / 2438
19 / 483	48 / 1219
19 / 483	54 / 1372
19 / 483	60 / 1524
19 / 483	66 / 1676
19 / 483	72 / 1829
19 / 483	78 / 1981
19 / 483	84 / 2134
19 / 483	90 / 2286
19 / 483	96 / 2438

PRICING

BOX/BOX/FILE (B)			
SOURCE LAMINATE CASE		FLINTWOOD CASE	VENEER CASE
Source Lam. Back & Front	Source Lam. Back, Flintwood Front	Flintwood Back & Front	Veneer Back & Front
2244	2837	4011	4413
2307	2939	4172	4588
2372	3041	4331	4762
2463	3166	4544	4999
2553	3291	4758	5234
3234	4186	5839	6422
3386	4390	6122	6733
3624	4724	6616	7279
n/a	n/a	6787	7463
2348	2982	4221	4642
2418	3087	4384	4822
2486	3194	4551	5007
2582	3328	4776	5253
2677	3457	5002	5501
3401	4404	6142	6758
3558	4619	6438	7081
3804	4968	6963	7658
n/a	n/a	7138	7851

If Counterweight is specified, add 168

Pricing is continued on the following page.

U H H S

High Open with Drawer Credenza –
Standard (Continued)DIMENSIONS
INCHES / MM

PRICING

DIMENSIONS		PRICING			
INCHES / MM		FILE/FILE (F)			
		SOURCE LAMINATE CASE		FLINTWOOD CASE	VENEER CASE
D	W	Source Lam. Back & Front	Source Lam. Back, Flintwood Front	Flintwood Back & Front	Veneer Back & Front
16 / 406	48 / 1219	2014	2659	3813	4197
16 / 406	54 / 1372	2079	2761	3974	4372
16 / 406	60 / 1524	2145	2864	4132	4545
16 / 406	66 / 1676	2232	2988	4347	4781
16 / 406	72 / 1829	2323	3112	4561	5018
16 / 406	78 / 1981	3084	4068	5710	6279
16 / 406	84 / 2134	3234	4272	5991	6588
16 / 406	90 / 2286	3472	4606	6487	7136
16 / 406	96 / 2438	n/a	n/a	6652	7317
19 / 483	48 / 1219	2118	2800	4021	4422
19 / 483	54 / 1372	2190	2910	4187	4606
19 / 483	60 / 1524	2257	3014	4351	4787
19 / 483	66 / 1676	2352	3150	4578	5035
19 / 483	72 / 1829	2447	3278	4802	5281
19 / 483	78 / 1981	3252	4283	6011	6613
19 / 483	84 / 2134	3407	4499	6308	6936
19 / 483	90 / 2286	3653	4850	6833	7515
19 / 483	96 / 2438	n/a	n/a	7008	7709

If Counterweight is specified, add 168

ULSE

Low Double Sliding Door Credenza – Elevated

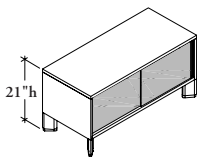

The Elevated Low Double Sliding Door Credenza provides secured, lockable binder storage, and the capability to support stackers and panels.

WHAT'S INCLUDED

1 credenza, 2 District feet or 4 angled feet (as specified), 2 sliding doors with pulls, lock and keys (if specified).

WHAT'S EXCLUDED

A Seat Cushion (UWLC) or Fitted Seated Cushion (UWLF) can be ordered separately. Can be found in the *Accessories* section.

NOTES

Double Sliding Door Credenzas will always have two sections secured with two sliding doors regardless of the width of the unit.

The 16" deep **cannot** be specified with a District Foot (D).

The Reconfigurable Low Credenza-to-Worksurface Support (UWCPWN) **cannot** be used with this unit as it will interfere with the sliding door.

It is **not** recommended that Double Sliding Door Credenzas be used to support worksurfaces in a perpendicular application as handle pulls will be difficult to reach under the worksurface.

Cubby Power Mounting (EWQPM) cannot be mounted in sliding door credenzas.

PRODUCT OPTIONS

Depth	Width	Pull Finish	Case, Back & Front Finish	Foot Finish	Foot Style	Electrical Cut Out (Angled Foot Only)	Key Style
16, 19	42, 48, 54, 60, 66, 72, 78, 84, 90, 96	Foundation Mica	Source Laminate Flintwood Natural Veneer FT Frost Standard Glass BP Backpainted Glass	Q Storm White 7 Platinum V Very White X Anthracite M Graphite 2 Burnished Bronze	D District A Angled Foot	TR Base and Top Grommet Right TL Base and Top Grommet Left NN None	K Keyed Alike R Keyed Randomly N No Lock

SAMPLE ORDER CODE

ULSE 16	90	7	Case Back Front			7	A	NN	R
			ZA	ZA	ZA				
			ZA	ZA	ZA				

DIMENSIONS
INCHES / MM

D	W
16 / 406	42 / 1067
16 / 406	48 / 1219
16 / 406	54 / 1372
16 / 406	60 / 1524
16 / 406	66 / 1676
16 / 406	72 / 1829
16 / 406	78 / 1981
16 / 406	84 / 2134
16 / 406	90 / 2286
16 / 406	96 / 2438
19 / 483	42 / 1067
19 / 483	48 / 1219
19 / 483	54 / 1372
19 / 483	60 / 1524
19 / 483	66 / 1676
19 / 483	72 / 1829
19 / 483	78 / 1981
19 / 483	84 / 2134
19 / 483	90 / 2286
19 / 483	96 / 2438

PRICING

SOURCE LAMINATE CASE

Source Lam. Back & Front	Source Lam. Back, Flintwood Front	Source Lam. Back, Glass Front
1372	2088	1583
1469	2154	1662
1559	2216	1747
1649	2274	1825
1747	2340	1918
1843	2404	2032
1935	2470	2148
2025	2539	2261
2118	2610	2366
n/a	n/a	n/a
1440	2193	1662
1544	2261	1746
1637	2324	1834
1732	2389	1918
1834	2455	2012
1935	2523	2133
2033	2594	2256
2125	2666	2373
2224	2742	2485
n/a	n/a	n/a

FLINTWOOD CASE

Flintwood Back, Glass Front	Flintwood Back & Front
3021	2885
3142	3001
3260	3112
3383	3230
3511	3352
3648	3481
3784	3613
3930	3752
4082	3896
4237	4046
3175	3030
3300	3151
3424	3267
3553	3391
3686	3521
3829	3654
3976	3795
4127	3939
4286	4089
4449	4245

VENEER CASE

Veneer Back, Glass Front	Veneer Back & Front
3127	2985
3255	3107
3376	3224
3503	3343
3636	3472
3775	3604
3921	3742
4071	3884
4227	4032
4388	4189
3280	3133
3416	3261
3542	3383
3679	3511
3819	3647
3963	3781
4116	3927
4273	4080
4440	4234
4608	4397

If Base & Top Grommet is specified, add 208

ULSS

Low Double Sliding Door Credenza – Standard

The Standard Low Double Sliding Door Credenza provides secured, lockable binder storage, and the capability to support stackers and panels.

WHAT'S INCLUDED

1 credenza, 2 sliding doors with pulls, 2 height-adjustable shelves, lock and keys (if specified).

WHAT'S EXCLUDED

A Seat Cushion (UWLC) or Fitted Seated Cushion (UWLF) can be ordered separately. Can be found in the *Accessories* section.

Extra kit that contains two 1-1/4" levelers and two 1-3/4" levelers will be shipped with the storage.

NOTES

Double Sliding Door Credenzas will always have two sections secured with two sliding doors regardless of the width of the unit.

The Reconfigurable Low Credenza-to-Worksurface Support (UWCPWN) **cannot** be used with this unit as it will interfere with the sliding door.

It is **not** recommended that Double Sliding Door Credenzas be used to support worksurfaces in a perpendicular application as handle pulls will be difficult to reach under the worksurface.

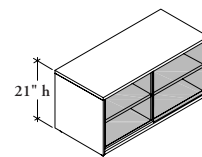

PRODUCT OPTIONS

Depth	Width	Pull Finish	Case, Back & Front Finish	Key Style
16, 19	42, 48, 54, 60, 66, 72, 78, 84, 90, 96	Foundation Mica	Source Laminate Flintwood Natural Veneer FT Frost Standard Glass BP Backpainted Glass	K Keyed Alike R Keyed Randomly N No Lock

SAMPLE ORDER CODE

			Case	Back	Front	
ULSS 16	90	7	ZA	ZA	ZA	R

DIMENSIONS
INCHES / MM

D	W
16 / 406	42 / 1067
16 / 406	48 / 1219
16 / 406	54 / 1372
16 / 406	60 / 1524
16 / 406	66 / 1676
16 / 406	72 / 1829
16 / 406	78 / 1981
16 / 406	84 / 2134
16 / 406	90 / 2286
16 / 406	96 / 2438
19 / 483	42 / 1067
19 / 483	48 / 1219
19 / 483	54 / 1372
19 / 483	60 / 1524
19 / 483	66 / 1676
19 / 483	72 / 1829
19 / 483	78 / 1981
19 / 483	84 / 2134
19 / 483	90 / 2286
19 / 483	96 / 2438

PRICING

SOURCE LAMINATE CASE

Source Lam. Back & Front	Source Lam. Back, Flintwood Front	Source Lam. Back, Glass Front
1372	2088	1583
1469	2154	1662
1559	2216	1747
1649	2274	1825
1747	2340	1918
1843	2404	2032
1935	2470	2148
2025	2539	2261
2118	2610	2366
n/a	n/a	n/a
1440	2193	1662
1544	2261	1746
1637	2324	1834
1732	2389	1918
1834	2455	2012
1935	2523	2133
2033	2594	2256
2125	2666	2373
2224	2742	2485
n/a	n/a	n/a

FLINTWOOD CASE

Flintwood Back, Glass Front	Flintwood Back & Front
3021	2885
3142	3001
3260	3112
3383	3230
3511	3352
3648	3481
3784	3613
3930	3752
4082	3896
4237	4046
3175	3030
3300	3151
3424	3267
3553	3391
3686	3521
3829	3654
3976	3795
4127	3939
4286	4089
4449	4245

VENEER CASE

Veneer Back, Glass Front	Veneer Back & Front
3127	2985
3255	3107
3376	3224
3503	3343
3636	3472
3775	3604
3921	3742
4071	3884
4227	4032
4388	4189
3280	3133
3416	3261
3542	3383
3679	3511
3819	3647
3963	3781
4116	3927
4273	4080
4440	4234
4608	4397

U H S E

High Double Sliding Door Credenza – Elevated

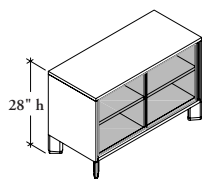

The Elevated High Double Sliding Door Credenza provides secured, lockable binder storage, and the capability to support stackers and panels.

WHAT'S INCLUDED

1 credenza, 2 District feet or 4 angled feet (as specified), 2 sliding doors with pulls, 2 height-adjustable shelves, lock and keys (if specified).

WHAT'S EXCLUDED

A Seat Cushion (UWLC) or Fitted Seated Cushion (UWLF) can be ordered separately. Can be found in the *Accessories* section.

NOTES

Double Sliding Door Credenzas will always have two sections secured with two sliding doors regardless of the width of the unit.

The 16" deep **cannot** be specified with a District Foot (D).

It is **not** recommended that Double Sliding Door Credenzas be used to support worksurfaces in a perpendicular application as handle pulls will be difficult to reach under the worksurface.

PRODUCT OPTIONS

Depth	Width	Pull Finish	Case, Back & Front Finish	Foot Finish	Foot Style	Electrical Cut Out (Angled Foot Only)	Key Style
16, 19	42, 48, 54, 60, 66, 72, 78, 84, 90, 96	Foundation Mica	Source Laminate Flintwood Natural Veneer FT Frost Standard Glass BP Backpainted Glass	Q Storm White 7 Platinum V Very White X Anthracite M Graphite 2 Burnished Bronze	D District A Angled Foot	NN None TL Base and Top Grommet Left TR Base and Top Grommet Right	K Keyed Alike R Keyed Randomly N No Lock

SAMPLE ORDER CODE

		Case			Back	Front				
UHSE 16	90	7	ZA	ZA	ZA	7	A	NN	R	

**DIMENSIONS
INCHES / MM**

D	W
16 / 406	42 / 1067
16 / 406	48 / 1219
16 / 406	54 / 1372
16 / 406	60 / 1524
16 / 406	66 / 1676
16 / 406	72 / 1829
16 / 406	78 / 1981
16 / 406	84 / 2134
16 / 406	90 / 2286
16 / 406	96 / 2438
19 / 483	42 / 1067
19 / 483	48 / 1219
19 / 483	54 / 1372
19 / 483	60 / 1524
19 / 483	66 / 1676
19 / 483	72 / 1829
19 / 483	78 / 1981
19 / 483	84 / 2134
19 / 483	90 / 2286
19 / 483	96 / 2438

PRICING

SOURCE LAMINATE CASE			FLINTWOOD CASE		VENEER CASE	
Source Lam. Back & Front	Source Lam. Back, Flintwood Front	Source Lam. Back, Glass Front	Flintwood Back, Glass Front	Flintwood Back & Front	Veneer Back, Glass Front	Veneer Back & Front
1673	2567	1868	3553	3391	3679	3511
1795	2655	1962	3701	3531	3676	3510
1907	2728	2066	3842	3665	3817	3646
2020	2807	2156	3988	3808	3963	3781
2145	2885	2266	4143	3952	4116	3927
2262	2967	2404	4301	4104	4272	4079
2379	3049	2542	4464	4262	4437	4233
2492	3134	2681	4640	4426	4608	4397
2608	3226	2807	4818	4598	4786	4568
n/a	n/a	n/a	5003	4774	4971	4742
1756	2695	1960	3731	3562	3861	3686
1883	2786	2059	3884	3707	3860	3685
2004	2864	2165	4032	3851	4008	3827
2120	2945	2263	4189	3997	4161	3973
2253	3030	2380	4348	4152	4322	4124
2375	3114	2523	4516	4307	4486	4280
2497	3202	2668	4688	4474	4658	4447
2615	3294	2813	4873	4648	4840	4618
2738	3385	2945	5058	4826	5027	4796
n/a	n/a	n/a	5253	5011	5221	4980

If Base & Top Grommet is specified, add 208

UHSS

High Double Sliding Door Credenza – Standard

The Standard High Double Sliding Door Credenza provides secured, lockable binder storage, and the capability to support stackers and panels.

WHAT'S INCLUDED

1 credenza, 2 sliding doors with pulls, 2 height-adjustable shelves, lock and keys (if specified).

Extra kit that contains two 1-1/4" levelers and two 1-3/4" levelers will be shipped with the storage.

WHAT'S EXCLUDED

A Seat Cushion (UWLC) or Fitted Seated Cushion (UWLF) can be ordered separately. Can be found in the *Accessories* section.

NOTES

Double Sliding Door Credenzas will always have two sections secured with two sliding doors regardless of the width of the unit.

It is **not** recommended that Double Sliding Door Credenzas be used to support worksurfaces in a perpendicular application as handle pulls will be difficult to reach under the worksurface.

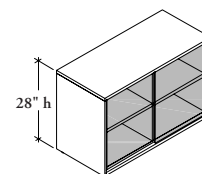

PRODUCT OPTIONS

Depth	Width	Pull Finish	Case, Back & Front Finish	Key Style
16, 19	42, 48, 54, 60, 66, 72, 78, 84, 90, 96	Foundation Mica	Source Laminate Flintwood Natural Veneer FT Frost Standard Glass BP Backpainted Glass	K Keyed Alike R Keyed Randomly N No Lock

SAMPLE ORDER CODE

UHSS 16	90	7	Case	Back	Front	R
			ZA	ZA	ZA	

DIMENSIONS
INCHES / MM

D	W
16 / 406	42 / 1067
16 / 406	48 / 1219
16 / 406	54 / 1372
16 / 406	60 / 1524
16 / 406	66 / 1676
16 / 406	72 / 1829
16 / 406	78 / 1981
16 / 406	84 / 2134
16 / 406	90 / 2286
16 / 406	96 / 2438
19 / 483	42 / 1067
19 / 483	48 / 1219
19 / 483	54 / 1372
19 / 483	60 / 1524
19 / 483	66 / 1676
19 / 483	72 / 1829
19 / 483	78 / 1981
19 / 483	84 / 2134
19 / 483	90 / 2286
19 / 483	96 / 2438

PRICING

SOURCE LAMINATE CASE

Source Lam. Back & Front	Source Lam. Back, Flintwood Front	Source Lam. Back, Glass Front
1673	2567	1868
1795	2655	1962
1907	2728	2066
2020	2807	2156
2145	2885	2266
2262	2967	2404
2379	3049	2542
2492	3134	2681
2608	3226	2807
n/a	n/a	n/a
1756	2695	1960
1883	2786	2059
2004	2864	2165
2120	2945	2263
2253	3030	2380
2375	3114	2523
2497	3202	2668
2615	3294	2813
2738	3385	2945
n/a	n/a	n/a

FLINTWOOD CASE

Flintwood Back, Glass Front	Flintwood Back & Front
3553	3391
3701	3531
3842	3665
3988	3808
4143	3952
4301	4104
4464	4262
4640	4426
4818	4598
5003	4774
3731	3562
3884	3707
4032	3851
4189	3997
4348	4152
4516	4307
4688	4474
4873	4648
5058	4826
5253	5011

VENEER CASE

Veneer Back, Glass Front	Veneer Back & Front
3679	3511
3676	3510
3817	3646
3963	3781
4116	3927
4272	4079
4437	4233
4608	4397
4786	4568
4971	4742
3861	3686
3860	3685
4008	3827
4161	3973
4322	4124
4486	4280
4658	4447
4840	4618
5027	4796
5221	4980

UCO Open Stacker

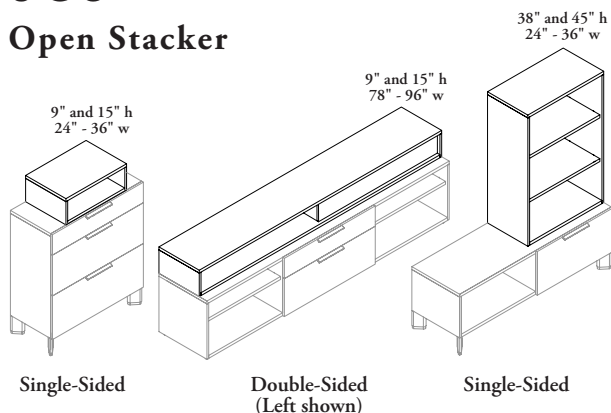

The Open Stacker is a 16" deep open cabinet that sits atop credenzas, towers and laterals to provide easily accessible open storage.

WHAT'S INCLUDED

1 cabinet with 1 to 4 height-adjustable shelves (depending on height and width).

NOTES

The Double-Sided (D) stacker is **not** available in 23", 30", 38" and 45" heights.

The Open Compartment Locations (L and R) do **not** apply to the Single-Sided (S) stacker.

Shelves are height-adjustable.

Heights of 23" and higher are only available in widths up to 48".

It is **not** recommended to stack units so that the total height exceeds 66".

Stackers **cannot** be stacked on top of each other.

PRODUCT OPTIONS

Style	Height	Width	Open Compartment Location	Case & Back Finish
D Double-Sided	09, 15, 21, 23, 30, 38, 45	24, 30, 36, 42, 48, 54, 60, 66, 72, 78, 84, 90, 96	L Left R Right N Not Applicable	Source Laminate Flintwood Natural Veneer
S Single-Sided				

SAMPLE ORDER CODE

				Case	Back
UCO S	15	84	L	ZA	ZA

DIMENSIONS INCHES / MM

H	W
9 / 229	24 / 610
9 / 229	30 / 762
9 / 229	36 / 914
9 / 229	42 / 1067
9 / 229	48 / 1219
9 / 229	54 / 1372
9 / 229	60 / 1524
9 / 229	66 / 1676
9 / 229	72 / 1829
9 / 229	78 / 1981
9 / 229	84 / 2134
9 / 229	90 / 2286
9 / 229	96 / 2438

PRICING

SINGLE-SIDED (S)

SOURCE LAMINATE CASE

Source Lam. Back
419
445
483
532
574
620
662
707
752
796
837
888
n/a

FLINTWOOD CASE

Flintwood Back
1336
1403
1482
1563
1649
1733
1821
1911
2006
2205
2317
2431
2553

VENEER CASE

Veneer Back
1380
1452
1533
1620
1708
1794
1883
1976
2075
2283
2399
2519
2646

Pricing is continued on the following page.

U C O
Open Stacker
(Continued)

DIMENSIONS
INCHES / MM

PRICING

SINGLE-SIDED (S) (CONTINUED)

DIMENSIONS		SOURCE LAMINATE CASE	FLINTWOOD CASE	VENEER CASE
H	W	Source Lam. Back	Flintwood Back	Veneer Back
15 / 381	24 / 610	464	1482	1533
15 / 381	30 / 762	493	1559	1615
15 / 381	36 / 914	534	1645	1702
15 / 381	42 / 1067	592	1737	1797
15 / 381	48 / 1219	640	1833	1898
15 / 381	54 / 1372	688	1925	1995
15 / 381	60 / 1524	738	2021	2092
15 / 381	66 / 1676	787	2122	2196
15 / 381	72 / 1829	836	2229	2307
15 / 381	78 / 1981	886	2453	2538
15 / 381	84 / 2134	930	2574	2665
15 / 381	90 / 2286	987	2702	2797
15 / 381	96 / 2438	n/a	2837	2939
21 / 533	24 / 610	579	1925	2070
21 / 533	30 / 762	618	2029	2180
21 / 533	36 / 914	669	2142	2299
21 / 533	42 / 1067	741	2259	2427
21 / 533	48 / 1219	800	2384	2561
21 / 533	54 / 1372	860	2502	2691
21 / 533	60 / 1524	921	2628	2827
21 / 533	66 / 1676	982	2761	2967
21 / 533	72 / 1829	1044	2897	3114
21 / 533	78 / 1981	1106	3187	3426
21 / 533	84 / 2134	1160	3348	3599
21 / 533	90 / 2286	1233	3512	3778
21 / 533	96 / 2438	n/a	3687	3969
23 / 584	24 / 610	639	2156	2317
23 / 584	30 / 762	678	2269	2439
23 / 584	36 / 914	738	2396	2574
23 / 584	42 / 1067	812	2532	2717
23 / 584	48 / 1219	879	2668	2870
30 / 762	24 / 610	859	2387	2481
30 / 762	30 / 762	899	2511	2612
30 / 762	36 / 914	930	2549	2648
30 / 762	42 / 1067	1024	3199	3329
30 / 762	48 / 1219	1075	3234	3367
38 / 965	24 / 610	1032	2647	2754
38 / 965	30 / 762	1079	2788	2899
38 / 965	36 / 914	1115	2817	2932
38 / 965	42 / 1067	1227	3535	3676
38 / 965	48 / 1219	1290	3564	3707
45 / 1143	24 / 610	1146	2910	3028
45 / 1143	30 / 762	1198	3062	3185
45 / 1143	36 / 914	1239	3084	3207
45 / 1143	42 / 1067	1362	3872	4025
45 / 1143	48 / 1219	1433	3895	4050

Pricing is continued on the following page.

U C O

Open Stacker
(Continued)

DIMENSIONS
INCHES / MM

PRICING

		DOUBLE-SIDED (D)		
		SOURCE LAMINATE CASE	FLINTWOOD CASE	VENEER CASE
H	W	Source Lam. Back	Flintwood Back	Veneer Back
9 / 229	24 / 610	471	1415	1465
9 / 229	30 / 762	499	1487	1541
9 / 229	36 / 914	531	1573	1626
9 / 229	42 / 1067	566	1660	1720
9 / 229	48 / 1219	601	1752	1813
9 / 229	54 / 1372	647	1873	1940
9 / 229	60 / 1524	695	2006	2074
9 / 229	66 / 1676	743	2148	2221
9 / 229	72 / 1829	790	2298	2375
9 / 229	78 / 1981	833	2456	2542
9 / 229	84 / 2134	877	2628	2720
9 / 229	90 / 2286	930	2813	2911
9 / 229	96 / 2438	n/a	3010	3114
15 / 381	24 / 610	523	1573	1627
15 / 381	30 / 762	554	1656	1712
15 / 381	36 / 914	591	1746	1807
15 / 381	42 / 1067	627	1843	1909
15 / 381	48 / 1219	668	1946	2014
15 / 381	54 / 1372	720	2082	2155
15 / 381	60 / 1524	770	2229	2306
15 / 381	66 / 1676	824	2385	2467
15 / 381	72 / 1829	875	2552	2641
15 / 381	78 / 1981	928	2732	2827
15 / 381	84 / 2134	974	2920	3022
15 / 381	90 / 2286	1035	3127	3233
15 / 381	96 / 2438	n/a	3343	3460
21 / 533	24 / 610	653	2115	2159
21 / 533	30 / 762	695	2225	2274
21 / 533	36 / 914	740	2344	2394
21 / 533	42 / 1067	786	2467	2521
21 / 533	48 / 1219	836	2543	2599
21 / 533	54 / 1372	899	2622	2681
21 / 533	60 / 1524	965	2702	2763
21 / 533	66 / 1676	1031	2859	2925
21 / 533	72 / 1829	1093	3194	3268
21 / 533	78 / 1981	1158	3388	3468
21 / 533	84 / 2134	1219	3552	3632
21 / 533	90 / 2286	1292	3715	3796
21 / 533	96 / 2438	n/a	3872	3957

UCC Closed Stacker

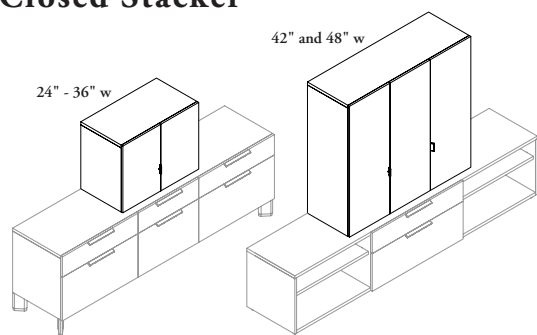

The Closed Stacker is a 16" deep closed cabinet that sits atop credenzas, towers and laterals to provide adjustable shelving and secured storage.

WHAT'S INCLUDED

1 cabinet, single-hinged door(s) or a combination of single-hinged door and bi-folding doors (depending on width), height-adjustable shelves (depending on height), lock and keys (if specified).

NOTES

For widths 24", 30" and 36", handedness will indicate which door will have the door handle and lock, for widths 42" and 48" handedness will indicate the location on the cabinet of the single hinged door (not the bi-fold).

Shelves are height-adjustable.

Height denotes height of the cabinet only and must be added to the height of the base unit (21" and 28" high credenzas or stretch pedestals or 36", 42" or 51" towers or lateral files) to get total height.

It is **not** recommended to stack units so that total height exceeds 66".

Stackers **cannot** be stacked on top of each other.

PRODUCT OPTIONS

Height	Width	Handedness	Pull Style	Pull Finish	Case, Back & Front Finish	Key Style
23, 30, 38, 45	24, 30, 36, 42, 48	L Left R Right	D District R Rectangular	Foundation Mica	Source Laminate Flintwood Natural Veneer	K Keyed Alike R Keyed Randomly N No Lock

SAMPLE ORDER CODE

UCC 23	42	L	D	7	Case	Back	Front	R
					ZA	ZA	ZA	

DIMENSIONS INCHES / MM

H	W
23 / 584	24 / 610
23 / 584	30 / 762
23 / 584	36 / 914
23 / 584	42 / 1067
23 / 584	48 / 1219
30 / 762	24 / 610
30 / 762	30 / 762
30 / 762	36 / 914
30 / 762	42 / 1067
30 / 762	48 / 1219
38 / 965	24 / 610
38 / 965	30 / 762
38 / 965	36 / 914
38 / 965	42 / 1067
38 / 965	48 / 1219
45 / 1143	24 / 610
45 / 1143	30 / 762
45 / 1143	36 / 914
45 / 1143	42 / 1067
45 / 1143	48 / 1219

PRICING

SOURCE LAMINATE CASE		FLINTWOOD CASE	VENEER CASE
Source Lam. Back & Front	Source Lam. Back, Flintwood Front	Flintwood Back & Front	Veneer Back & Front
1150	1841	2761	2871
1217	1945	2917	3035
1397	2233	3181	3305
1782	2851	4109	4272
1961	3135	4574	4757
1245	1996	2970	3087
1312	2101	3127	3254
1493	2388	3386	3524
1877	3006	4249	4418
2056	3291	4712	4907
1342	2148	3386	3524
1408	2255	3542	3685
1588	2542	3806	3957
1974	3158	4736	4925
2153	3447	5201	5409
1440	2304	3683	3829
1516	2425	3876	4030
1690	2705	4137	4303
2124	3404	5188	5395
2301	3683	5453	5673

UCB

Closed Stacker with Cubbies

The Closed Stacker with Cubbies is a 16" deep closed cabinet that sits atop credenzas, to provide secured storage combined with open cubby space.

WHAT'S INCLUDED

1 cabinet with pulls (depending on width), lock and keys (if specified), 1 or 2 height-adjustable shelves (depending on height).

NOTES

The handedness of 24", 30" and 36" units refer to handle location. The handedness of 42" and 48" units is determined by the opening orientation of the bi-fold door.

Shelves are height-adjustable.

Height denotes height of the cabinet only and must be added to the height of the base unit (21" and 28" high credenzas or stretch pedestals or 36", 42" or 51" towers or lateral files) to get total height.

It is **not** recommended to stack units so that total height exceeds 66".

Stackers **cannot** be stacked on top of each other.

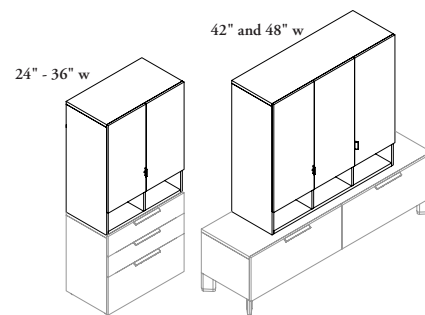

PRODUCT OPTIONS

Height	Width	Handedness	Pull Style	Pull Finish	Case, Back & Front Finish	Key Style
23, 30, 38, 45	24, 30, 36, 42, 48	L Left R Right	D District R Rectangular	Foundation Mica	Source Laminate Flintwood Natural Veneer	K Keyed Alike R Keyed Randomly N No Lock

SAMPLE ORDER CODE

UCB 23	42	L	D	7	Case	Back	Front	R
					ZA	ZA	ZA	

DIMENSIONS
INCHES / MM

PRICING

DIMENSIONS		SOURCE LAMINATE CASE		FLINTWOOD CASE		VENEER CASE	
H	W	Source Lam. Back & Front	Source Lam. Back, Flintwood Front	Flintwood Back & Front	Veneer Back & Front		
23 / 584	24 / 610	1323	1794	3037	3101		
23 / 584	30 / 762	1398	1896	3210	3276		
23 / 584	36 / 914	1604	2178	3497	3572		
23 / 584	42 / 1067	2049	2776	4521	4616		
23 / 584	48 / 1219	2256	3056	5030	5135		
30 / 762	24 / 610	1433	1945	3252	3364		
30 / 762	30 / 762	1509	2046	3419	3538		
30 / 762	36 / 914	1719	2323	3820	3952		
30 / 762	42 / 1067	2158	2926	4642	4795		
30 / 762	48 / 1219	2366	3205	5048	5200		
38 / 965	24 / 610	1545	2092	4205	3664		
38 / 965	30 / 762	1621	2194	4428	3856		
38 / 965	36 / 914	1827	2472	4135	4272		
38 / 965	42 / 1067	2269	3074	5011	5171		
38 / 965	48 / 1219	2474	3353	5419	5583		
45 / 1143	24 / 610	1657	2242	5166	3966		
45 / 1143	30 / 762	1744	2361	5439	4174		
45 / 1143	36 / 914	1944	2638	4452	4590		
45 / 1143	42 / 1067	2446	3311	5380	5546		
45 / 1143	48 / 1219	2647	3585	5794	5969		

U K S D

Single Locker with Solid Back

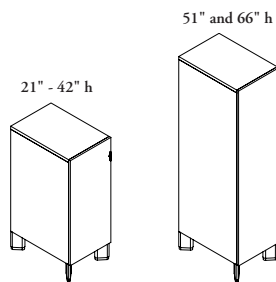

The Single Locker with Solid Back provides either coat storage, secured shelf storage or a recycling section with the capability to support worksurfaces or panels.

WHAT'S INCLUDED

1 single locker with pull, 4 angled feet (if specified), lock and keys (if specified), 2 coat hooks and boot shelf (if Closet (C) configuration is specified and unit is 66" high), 1 to 4 height-adjustable shelves (if shelves (S) configuration is specified).

Extra kit that contains two 1-1/4" levelers and two 1-3/4" levelers will be shipped with the storage.

NOTES

The 12" wide locker **cannot** be used in a freestanding application. It must be attached to a worksurface or panel or linked to another storage unit.

The Closet (C) interior configuration does **not** apply to 21", 28" and 42" heights.

Closet (C) and Shelves (S) interior configurations are only available when a Full Door (F) locker has been specified.

Recycle and Shelves (R) interior configuration is **not** available when Full Door (F) has been specified.

Door swing direction can be determined by the location of the hinges on the door.

PRODUCT OPTIONS

Style	Height	Depth	Width	Door Swing Direction	Door Split
E Elevated (Shown) S Standard	21, 28, 42, 51, 66	16, 19, 23	12, 16	L Left (shown) R Right	F Full Door

SAMPLE ORDER CODE

UKSD E	51	16	12	L	F
---------------	-----------	-----------	-----------	----------	----------

PRODUCT OPTIONS CONTINUED

Pull Style	Pull Finish	Case, Back & Front Finish	Interior Configuration	Key Style	Foot Finish (Elevated Style)
D District R Rectangular	Foundation Mica	Source Laminate Flintwood Natural Veneer	C Closet S Shelves R Recycle and Shelves	K Keyed Alike R Keyed Randomly N No Lock	Q Storm White 7 Platinum V Very White X Anthracite M Graphite 2 Burnished Bronze

SAMPLE ORDER CODE CONTINUED

D	Q	VU	VU	VU	C	R	Q
----------	----------	-----------	-----------	-----------	----------	----------	----------

See Pricing on the following page.

UKSD
Single Locker with Solid Back
(Continued)

DIMENSIONS
FOR MM X BY 25.4

H	D	W
21	16	12, 16
21	19	12, 16
21	23	12, 16
28	16	12, 16
28	19	12, 16
28	23	12, 16
42	16	12, 16
42	19	12, 16
42	23	12, 16
51	16	12, 16
51	19	12, 16
51	23	12, 16
66	16	12, 16
66	19	12, 16
66	23	12, 16

PRICING

ELEVATED (E)			
SOURCE LAMINATE CASE		FLINTWOOD CASE	VENEER CASE
Source Lam. Back & Front	Source Lam. Back, Flintwood Front	Flintwood Back & Front	Veneer Back & Front
838	1158	1568	1568
874	1215	1641	1641
923	1302	1786	1786
931	1290	1742	1742
971	1348	1823	1823
1027	1448	1984	1984
1125	1575	2144	2144
1178	1648	2244	2244
1242	1773	2450	2450
1241	1744	2379	2379
1298	1827	2495	2495
1374	1967	2723	2723
1372	1933	2644	2644
1433	2025	2773	2773
1517	2182	3030	3030

STANDARD (S)			
SOURCE LAMINATE CASE		FLINTWOOD CASE	VENEER CASE
Source Lam. Back & Front	Source Lam. Back, Flintwood Front	Flintwood Back & Front	Veneer Back & Front
673	990	1385	1385
706	1041	1457	1457
754	1126	1601	1601
765	1121	1574	1574
804	1181	1657	1657
857	1280	1819	1819
960	1408	1974	1974
1008	1482	2076	2076
1076	1606	2281	2281
1075	1576	2213	2213
1129	1660	2327	2327
1205	1798	2557	2557
1203	1767	2476	2476
1266	1859	2607	2607
1350	2014	2862	2862

If Shelves are specified, add 105

U K C Single Locker with Side Closet

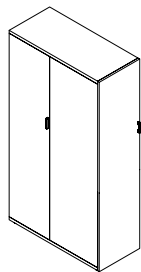

Full Door

The Single Locker with Side Closet provides secured coat storage at the side in addition to secured front shelf storage or a recycle section. This unit can support worksurfaces or panels.

WHAT'S INCLUDED

1 single locker with pulls, lock and keys (if specified), 2 coat hooks and boot shelf (for 66" high only) in side closet, 3 or 4 height-adjustable shelves depending on height or configuration.

Extra kit that contains two 1-1/4" levelers and two 1-3/4" levelers will be shipped with the storage.

NOTES

The 12" wide locker **cannot** be used in a freestanding application. It must be attached to a worksurface or panel or linked to another storage unit.

When Full Door (F) option is specified, the front section will be configured with shelves.

The front section will always be 16" deep, regardless of total depth of the unit. The width of the side closet will vary.

PRODUCT OPTIONS

Style	Height	Depth	Width	Closet Location	Door Split
S Standard (shown)	51, 66	23, 29, 35	12, 16	L Left (shown) R Right	F Full Door

SAMPLE ORDER CODE

UKC S	51	29	12	R	F
--------------	-----------	-----------	-----------	----------	----------

PRODUCT OPTIONS CONTINUED

Pull Style	Pull Finish	Case & Front Finish	Key Style	Foot Finish (Elevated Style)
D District R Rectangular	Foundation Mica	Source Laminate Flintwood Natural Veneer	K Keyed Alike R Keyed Randomly N No Lock	Q Storm White 7 Platinum V Very White X Anthracite M Graphite 2 Burnished Bronze

SAMPLE ORDER CODE CONTINUED

		Case	Front		
D	7	ZA	ZA	R	7

See Pricing on the following page.

U K C
Single Locker with Side Closet
(Continued)

DIMENSIONS
FOR MM X BY 25.4

PRICING

			STANDARD (S)			
			FULL DOOR (F)			
			SOURCE LAMINATE CASE		FLINTWOOD CASE	VENEER CASE
H	D	W	Source Lam. Front	Flintwood Front	Flintwood Front	Veneer Front
51	23	12, 16	2166	2809	4613	4822
51	29	12, 16	2279	2957	4855	5075
51	35	12, 16	2392	3005	4968	5196
66	23	12, 16	2428	3146	5163	5399
66	29	12, 16	2554	3311	5437	5686
66	35	12, 16	2678	3368	5565	5821

UKN Cubby Locker

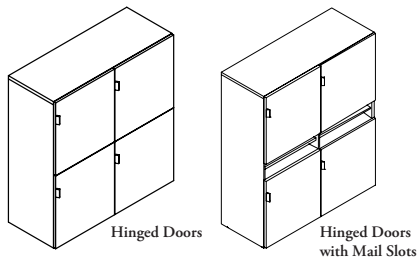

The Cubby Locker is a four-cubby locker with optional mail slots. It is available in standard and elevated styles and is designed for personal storage in shared office applications.

WHAT'S INCLUDED

1 case with pulls, lock and keys (if specified). Configuration (1): only hinged doors; Configuration (2); hinged doors with center mail slot.

Extra kit that contains two 1-1/4" levelers and two 1-3/4" levelers will be shipped with the storage.

NOTES

Door swing direction can be determined by the location of the hinges on the door.

PRODUCT OPTIONS

Style	Height	Depth	Width	Configuration	Door Swing Direction
S Standard (shown)	42, 51, 66	16	30, 36, 42	1 Hinged Doors 2 Hinged Doors with Mail Slots	L Left R Right

SAMPLE ORDER CODE

UKN S	51	16	30	1	L
--------------	-----------	-----------	-----------	----------	----------

PRODUCT OPTIONS CONTINUED

Pull Style	Pull Finish	Case, Back & Front Finish	Key Style	Foot Finish (Elevated Style)
D District R Rectangular	Foundation Mica	Source Laminate Flintwood Natural Veneer	K Keyed Alike R Keyed Randomly N No Lock	Q Storm White 7 Platinum V Very White X Anthracite M Graphite 2 Burnished Bronze

SAMPLE ORDER CODE CONTINUED

D	7	VU	VU	VU	R	Q
----------	----------	-----------	-----------	-----------	----------	----------

See Pricing on the following page.

U K N
Cubby Locker (Continued)

DIMENSIONS
FOR MM X BY 25.4

PRICING

			STANDARD (S)			
			HINGED DOORS (1)			
			SOURCE LAMINATE CASE		FLINTWOOD CASE	VENEER CASE
H	D	W	Source Lam. Back & Front	Source Lam. Back, Flintwood Front	Flintwood Back & Front	Veneer Back & Front
42	16	30	3253	4345	5462	5735
42	16	36	3478	4647	5846	6138
42	16	42	3723	4973	6251	6566
51	16	30	3412	4561	5735	6024
51	16	36	3652	4880	6136	6445
51	16	42	3908	5223	6566	6896
66	16	30	3594	4798	6036	6339
66	16	36	3843	5133	6459	6783
66	16	42	4113	5494	6911	7256
			HINGED DOORS WITH MAIL SLOTS (2)			
			SOURCE LAMINATE CASE		FLINTWOOD CASE	VENEER CASE
H	D	W	Source Lam. Back & Front	Source Lam. Back, Flintwood Front	Flintwood Back & Front	Veneer Back & Front
42	16	30	3339	4434	5551	5825
42	16	36	3567	4736	5933	6228
42	16	42	3812	5061	6344	6657
51	16	30	3503	4650	5825	6113
51	16	36	3743	4969	6227	6534
51	16	42	3999	5310	6657	6985
66	16	30	3682	4887	6126	6427
66	16	36	3933	5225	6547	6872
66	16	42	4201	5583	7001	7348

UKD Dual Locker

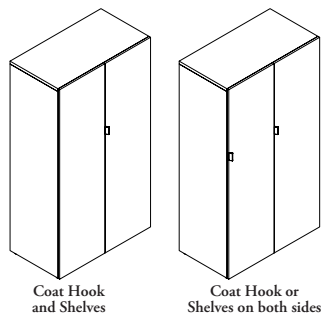

Coat Hook and Shelves

Coat Hook or Shelves on both sides

The Dual Locker provides coat and secured shelf storage. This unit can support panels or can be ganged together to create a bank of lockers.

WHAT'S INCLUDED

1 dual locker with pulls, lock and keys (if specified),

Configuration	Coat Hook	Boot Shelf	Shelves
CC	2	2 (66"h)	0
CS	1	1 (66"h)	2 - 4
SS	0	0	4 - 8

Extra kit that contains two 1-1/4" levelers and two 1-3/4" levelers will be shipped with the storage.

NOTES

Orientation (L and R) options do **not** apply to the Coat and Shelf (CS) interior configuration.

Orientation (F and G) options do **not** apply to the Coat Hook on Both Sides (CC) and Shelves on Both Sides (SS) interior configurations.

Shelves and coat hook are reconfigurable.

If Interior Configurations Coat Hook, Both Sides (CC) or Shelves, Both Sides (SS) are specified, each side will be individually locked.

PRODUCT OPTIONS

Style	Height	Depth	Width	Interior Configuration	Orientation	Pull Style	Pull Finish	Case, Back & Front Finish	Key Style	Foot Finish (Elevated Style)
S Standard (shown)	42, 51, 66	16, 19	24, 30, 36, 42	CC Coat Hook, Both Sides	L Door Swing, Left	D District	Foundation	Source Laminate Flintwood Natural Veneer	K Keyed Alike	Q Storm White
				CS Coat Hook & Shelves	R Door Swing, Right (shown)	R Rectangular	Mica		R Keyed Randomly	7 Platinum
				SS Shelves, Both Sides	F Coat Hook, Left				N No Lock	V Very White
					G Coat Hook, Right					X Anthracite
									M Graphite	
										2 Burnished Bronze

SAMPLE ORDER CODE

							Case Back Front					
UKD S	51	16	24	CS	F	D	7	ZA	ZA	ZA	R	7

DIMENSIONS FOR MM X BY 25.4

H	D	W
51	16	24
51	16	30
51	16	36
51	16	42
51	19	24
51	19	30
51	19	36
51	19	42
66	16	24
66	16	30
66	16	36
66	16	42
66	19	24
66	19	30
66	19	36
66	19	42

PRICING

STANDARD (S)

COAT HOOK, BOTH SIDES (CC)

SOURCE LAMINATE CASE

Source Lam. Back & Front	Source Lam. Back, Flintwood Front
2232	2984
2439	3260
2632	3514
2817	3759
2349	3141
2570	3430
2771	3702
2966	3959
2349	3141
2570	3430
2771	3702
2966	3959
2473	3304
2703	3611
2917	3897
3120	4169

FLINTWOOD CASE

Flintwood Back & Front
3753
4100
4422
4731
3949
4314
4653
4981
3949
4314
4653
4981
4157
4543
4901
5244

VENEER CASE

Veneer Back & Front
3942
4304
4644
4969
4149
4533
4886
5229
4149
4533
4886
5229
4368
4771
5145
5505

Pricing is continued on the following page.

UKD
Dual Locker (Continued)

DIMENSIONS
FOR MM X BY 25.4

PRICING

STANDARD (S) (CONTINUED)

COAT HOOK & SHELVES (CS)

H	D	W	SOURCE LAMINATE CASE		FLINTWOOD CASE	VENEER CASE
			Source Lam. Back & Front	Source Lam. Back, Flintwood Front	Flintwood Back & Front	Veneer Back & Front
51	16	24	2327	3108	3908	4102
51	16	30	2535	3384	4258	4471
51	16	36	2728	3646	4583	4813
51	16	42	2919	3900	4904	5152
51	19	24	2450	3270	4116	4322
51	19	30	2667	3563	4481	4705
51	19	36	2871	3834	4822	5064
51	19	42	3074	4102	5160	5418
66	16	24	2450	3270	4116	4322
66	16	30	2667	3563	4481	4705
66	16	36	2871	3834	4822	5064
66	16	42	3074	4102	5160	5418
66	19	24	2578	3447	4334	4549
66	19	30	2809	3752	4720	4954
66	19	36	3021	4033	5077	5331
66	19	42	3233	4314	5431	5705

SHELVES, BOTH SIDES (SS)

H	D	W	SOURCE LAMINATE CASE		FLINTWOOD CASE	VENEER CASE
			Source Lam. Back & Front	Source Lam. Back, Flintwood Front	Flintwood Back & Front	Veneer Back & Front
42	16	24	2306	3080	3874	4068
42	16	30	2501	3342	4202	4414
42	16	36	2685	3585	4510	4736
42	16	42	2873	3836	4826	5066
42	19	24	2427	3239	4078	4280
42	19	30	2635	3520	4425	4647
42	19	36	2830	3776	4749	4986
42	19	42	3025	4042	5082	5337
51	16	24	2421	3233	4069	4271
51	16	30	2628	3511	4417	4639
51	16	36	2820	3767	4737	4975
51	16	42	3018	4030	5070	5323
51	19	24	2550	3406	4282	4497
51	19	30	2768	3697	4648	4881
51	19	36	2970	3967	4987	5238
51	19	42	3180	4245	5338	5605
66	16	24	2550	3406	4282	4497
66	16	30	2768	3697	4648	4881
66	16	36	2970	3967	4987	5238
66	16	42	3180	4245	5338	5605
66	19	24	2683	3582	4507	4734
66	19	30	2912	3892	4894	5138
66	19	36	3127	4175	5251	5516
66	19	42	3343	4470	5621	5902

U K T
Triple Locker

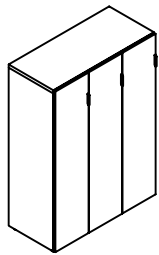

The Triple Locker provides coat and secured shelf storage. This unit can support panels or can be ganged together to create a bank of lockers.

WHAT'S INCLUDED

1 triple locker with pulls, lock and keys (if specified).

Extra kit that contains two 1-1/4" levelers and two 1-3/4" levelers will be shipped with the storage.

NOTES

Shelves and coat hooks are reconfigurable. See Locker Accessories (UWKA) in this section.

PRODUCT OPTIONS

Style	Height	Depth	Width	Interior Configuration	Orientation
S Standard	42, 51, 66	16	36, 42, 48	3C 3 Person All Coats 3S 3 Person All Shelves	L Door Swing, Left R Door Swing, Right

SAMPLE ORDER CODE

UKT S	51	16	36	3S	R
--------------	-----------	-----------	-----------	-----------	----------

PRODUCT OPTIONS CONTINUED

Pull Style	Pull Finish	Case, Back & Front Finish	Key Style	Foot Finish
D District R Rectangular	Foundation Mica	Source Laminate Flintwood Natural Veneer	K Keyed Alike R Keyed Randomly N No Lock	Q Storm White 7 Platinum V Very White X Anthracite M Graphite 2 Burnished Bronze

SAMPLE ORDER CODE CONTINUED

		Case	Back	Front		
D	7	ZA	ZA	ZA	R	7

See Pricing on the following page.

U K T
Triple Locker (Continued)

DIMENSIONS
FOR MM X BY 25.4

PRICING

			STANDARD (S)			
			THREE PERSON ALL COATS (3C)			
			SOURCE LAMINATE CASE		FLINTWOOD CASE	VENEER CASE
			Source Lam. Back & Front	Source Lam. Back, Flintwood Front	Flintwood Back & Front	Veneer Back & Front
42	16	36	3114	4158	5233	5497
42	16	42	3202	4277	5379	5650
42	16	48	3300	4405	5540	5820
51	16	36	3269	4370	5494	5770
51	16	42	3363	4493	5649	5931
51	16	48	3461	4626	5819	6110
66	16	36	3441	4598	5782	6073
66	16	42	3538	4727	5947	6243
66	16	48	3646	4869	6125	6429
			THREE PERSON ALL SHELVES (3S)			
			SOURCE LAMINATE CASE		FLINTWOOD CASE	VENEER CASE
			Source Lam. Back & Front	Source Lam. Back, Flintwood Front	Flintwood Back & Front	Veneer Back & Front
42	16	36	3362	4488	5647	5928
42	16	42	3455	4613	5804	6096
42	16	48	3398	4537	5707	5994
51	16	36	3529	4712	5929	6225
51	16	42	3628	4844	6096	6398
51	16	48	3566	4765	5994	6293
66	16	36	3715	4962	6241	6557
66	16	42	3819	5101	6416	6737
66	16	48	3935	5256	6609	6940

UKQ Quad Locker

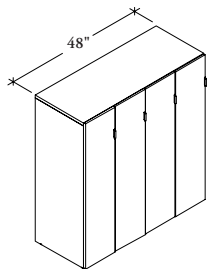

The Quad Locker provides coat and secured shelf storage. This unit can support panels or can be ganged together to create a bank of lockers.

WHAT'S INCLUDED

1 quad locker with pulls, lock and keys (if specified),

Configuration	Coat Hook	Boot Shelf	Shelves
2P	2	2 (66"h)	4-8
4C	4	4 (66"h)	0
4S	0	0	8-16

Extra kit that contains two 1-1/4" levelers and two 1-3/4" levelers will be shipped with the storage.

NOTES

Orientation (L and R) options do **not** apply to the Coat and Shelf (2P) interior configuration.

Orientation (F and G) options do **not** apply to the 4 Person all Coats (4C) and 4 Person all Shelves (4S) interior configurations.

Shelves and coat hooks are reconfigurable. See Locker Accessories (UWKA) in this section

If interior configurations Four Person All Coats (4C) or Four Person All Shelves (4S) are specified, each door will be individually locked.

If interior configuration Two Person Coat and Shelves (2P) is specified, there will be two individually locked sections.

PRODUCT OPTIONS

Style	Height	Depth	Interior Configuration	Orientation	Pull Style	Pull Finish	Case, Back & Front Finish	Key Style	Foot Finish (Elevated Style)
S Standard	51, 66	16, 19	2P Two Person Coat & Shelves	L Door Swing, Left (shown)	D District	Foundation	Source Laminate Flintwood Natural Veneer	K Keyed Alike	Q Storm White
			4C Four Person all Coats	R Door Swing, Right	R Rectangular	Mica		R Keyed Randomly	7 Platinum
			4S Four Person all Shelves	F Coat Hook, Left				N No Lock	V Very White
				G Coat Hook, Right				X Anthracite	
									M Graphite
									2 Burnished Bronze

SAMPLE ORDER CODE

							Case Back Front				
UKQ S	51	16	4S	F	D	7	ZA	ZA	ZA	R	7

DIMENSIONS INCHES / MM

H	D
51 / 1295	16 / 406
51 / 1295	19 / 483
66 / 1676	16 / 406
66 / 1676	19 / 406

PRICING

STANDARD (S)

TWO PERSON COAT & SHELVES (2P)

SOURCE LAMINATE CASE

Source Lam. Back & Front	Source Lam. Back, Flintwood Front
4071	5434
4286	5727

FLINTWOOD CASE

Flintwood Back & Front
6839
7204

VENEER CASE

Veneer Back & Front
7180
7563

4286	5727	7204	7563
4511	6029	7583	7962

FOUR PERSON ALL COATS (4C)

SOURCE LAMINATE CASE

Source Lam. Back & Front	Source Lam. Back, Flintwood Front
3908	5223
4113	5494

FLINTWOOD CASE

Flintwood Back & Front
6566
6911

VENEER CASE

Veneer Back & Front
6896
7256

4113	5494	6911	7256
4331	5781	7276	7638

Pricing is continued on the following page.

U K Q
Quad Locker (Continued)

DIMENSIONS
INCHES / MM

PRICING

DIMENSIONS INCHES / MM		STANDARD (S) (CONTINUED)			
		FOUR PERSON ALL SHELVES (4S)			
		SOURCE LAMINATE CASE		FLINTWOOD CASE	VENEER CASE
H	D	Source Lam. Back & Front	Source Lam. Back, Flintwood Front	Flintwood Back & Front	Veneer Back & Front
51 / 1295	16 / 406	4237	5658	7119	7475
51 / 1295	19 / 483	4460	5957	7496	7871
66 / 1676	16 / 406	4460	5957	7496	7871
66 / 1676	19 / 406	4694	6273	7890	8285

UTLE

Lateral Tower – Elevated

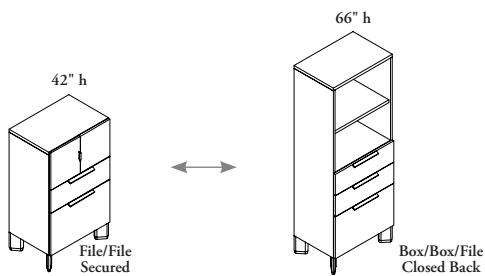

The Elevated Lateral Tower provides both file and binder storage, the capability to support worksurfaces, stackers and panels and the ability to route and provide access to power and data.

WHAT'S INCLUDED

1 tower, 4 angled feet, drawers and pulls (as specified), lock and keys (if specified).

NOTES

The 42" high Elevated Lateral Tower comes in a Box/File (X) drawer combination.

The 51" and 66" high Elevated Lateral Tower is available in a Box/Box/File (B) or File/File (F) drawer combination.

If a 36" high unit is desired, please see Lateral Files (UFLE)

Beltline Back Cut Out (E) electrical option **cannot** be specified on the 42" high tower.

Individual Locks may be specified on the File/File (F) drawer combination.

PRODUCT OPTIONS

Height	Depth	Width	Drawer Combination	Shelf Configuration	Pull Style	Pull Finish	Case, Back & Front Finish	Foot Finish	Key Style	Electrical Cut Out
42, 51, 66	16, 19	24, 30, 36	X Box/File B Box/Box/File F File/File	C Closed Back S Secured	D District R Rectangular	Foundation Mica	Source Laminate Flintwood Natural Veneer	Q Storm White 7 Platinum V Very White X Anthracite M Graphite 2 Burnished Bronze	K Keyed Alike R Keyed Randomly N No Lock L Individual Lock	E Beltline Back Cut Out B Base Back Cut Out N None

SAMPLE ORDER CODE

Case Back Front

UTLE 42	19	36	X	C	D	Q	ZA	ZA	ZA	7	R	B
------------	----	----	---	---	---	---	----	----	----	---	---	---

DIMENSIONS FOR MM X BY 25.4

H	D	W
42	16	24
42	16	30
42	16	36
42	19	24
42	19	30
42	19	36

PRICING

BOX/FILE (X)					
CLOSED BACK (C)					
SOURCE LAMINATE CASE		FLINTWOOD CASE		VENEER CASE	
Source Lam. Back & Front	Source Lam. Back, Flintwood Front	Flintwood Back & Front		Veneer Back & Front	
1876	2204	3034		3835	
2130	2528	3477		4303	
2413	2881	3972		4819	
1973	2318	3188		4010	
2242	2660	3662		4505	
2537	3029	4175		5049	

SECURED (S)					
SOURCE LAMINATE CASE		FLINTWOOD CASE		VENEER CASE	
Source Lam. Back & Front	Source Lam. Back, Flintwood Front	Flintwood Back & Front		Veneer Back & Front	
2536	3036	4186		4664	
2856	3437	4745		5251	
3210	3884	5366		5902	
2666	3192	4404		4907	
3006	3619	4995		5527	
3376	4088	5647		6211	

If Individual Lock is specified, add 165
 If Beltline Back Cut Out is specified, add 103
 If Base Back Cut Out is specified, add 103

Pricing is continued on the following page.

U T L E
Lateral Tower – Elevated
(Continued)

DIMENSIONS
FOR MM X BY 25.4

PRICING

			BOX/BOX/FILE (B)			
			CLOSED (C)			
			SOURCE LAMINATE CASE		FLINTWOOD CASE	VENEER CASE
H	D	W	Source Lam. Back & Front	Source Lam. Back, Flintwood Front	Flintwood Back & Front	Veneer Back & Front
51	16	24	1662	1918	2629	3449
51	16	30	1905	2223	3054	3889
51	16	36	2174	2560	3524	4379
51	19	24	1749	2016	2769	3605
51	19	30	2004	2338	3216	4073
51	19	36	2283	2692	3706	4587
66	16	24	2355	2772	3813	4346
66	16	30	2655	3150	4338	4894
66	16	36	2984	3563	4916	5501
66	19	24	2467	2901	3995	4549
66	19	30	2783	3299	4544	5128
66	19	36	3128	3731	5146	5761
			SECURED (S)			
			SOURCE LAMINATE CASE		FLINTWOOD CASE	VENEER CASE
H	D	W	Source Lam. Back & Front	Source Lam. Back, Flintwood Front	Flintwood Back & Front	Veneer Back & Front
51	16	24	2519	2996	4128	4639
51	16	30	2821	3377	4659	5197
51	16	36	3157	3803	5247	5814
51	19	24	2638	3134	4323	4855
51	19	30	2957	3538	4882	5446
51	19	36	3309	3984	5502	6096
66	16	24	2750	3268	4504	5071
66	16	30	3087	3697	5097	5691
66	16	36	3459	4162	5751	6377
66	19	24	2882	3424	4721	5311
66	19	30	3236	3873	5343	5966
66	19	36	3629	4369	6029	6686

If Individual Lock is specified, add 165
 If Beltline Back Cut Out is specified, add 103
 If Base Back Cut Out is specified, add 103

Pricing is continued on the following page.

U T L E

Lateral Tower – Elevated
(Continued)

DIMENSIONS
FOR MM X BY 25.4

PRICING

FILE/FILE (F)			CLOSED BACK (C)			
			SOURCE LAMINATE CASE		FLINTWOOD CASE	VENEER CASE
H	D	W	Source Lam. Back & Front	Source Lam. Back, Flintwood Front	Flintwood Back & Front	Veneer Back & Front
51	16	24	1924	2246	3087	3926
51	16	30	2194	2588	3562	4422
51	16	36	2489	2957	4076	4964
51	19	24	2024	2362	3254	4112
51	19	30	2307	2722	3749	4631
51	19	36	2620	3113	4294	5202
66	16	24	2124	2483	3412	3924
66	16	30	2424	2858	3935	4472
66	16	36	2754	3274	4511	5079
66	19	24	2237	2612	3592	4128
66	19	30	2552	3008	4143	4705
66	19	36	2897	3443	4746	5340
SECURED (S)			SOURCE LAMINATE CASE		FLINTWOOD CASE	VENEER CASE
H	D	W	Source Lam. Back & Front	Source Lam. Back, Flintwood Front	Flintwood Back & Front	Veneer Back & Front
51	16	24	2291	2706	3728	4220
51	16	30	2593	3088	4258	4775
51	16	36	2929	3512	4845	5391
51	19	24	2408	2846	3922	4433
51	19	30	2728	3253	4481	5022
51	19	36	3082	3697	5100	5673
66	16	24	2520	2981	4102	4649
66	16	30	2858	3407	4694	5270
66	16	36	3230	3875	5346	5953
66	19	24	2652	3133	4319	4889
66	19	30	3009	3581	4943	5543
66	19	36	3401	4077	5625	6265

If Individual Lock is specified, add 165
 If Beltline Back Cut Out is specified, add 103
 If Base Back Cut Out is specified, add 103

UTLS

Lateral Tower – Standard

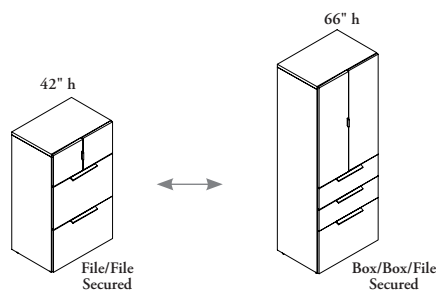

The Standard Lateral Tower provides both file and binder storage, and the capability to support worksurfaces, stackers and panels.

WHAT'S INCLUDED

1 tower, drawers and pulls (as specified), lock and keys (if specified).

NOTES

The 42", 51" and 66" high Standard Lateral Tower is available in a Box/Box/File (B) or File/File (F) drawer combination.

Individual Locks may be specified on the File/File (F) drawer combination.

This product includes extended levelers (UNSLB) already installed.

PRODUCT OPTIONS

Height	Depth	Width	Drawer Combination	Shelf Configuration	Pull Style	Pull Finish	Case, Back & Front Finish	Key Style
42, 51, 66	16, 19	24, 30, 36	B Box/Box/File (shown) F File/File	C Closed Back S Secured	D District R Rectangular	Foundation Mica	Source Laminate Flintwood Natural Veneer	L Individual Lock K Keyed Alike R Keyed Randomly N No Lock

SAMPLE ORDER CODE

							Case	Back	Front	
UTLS 42	16	36	B	C	D	7	VU	VU	VU	R

See Pricing on the following page.

UTLS
Lateral Tower – Standard
(Continued)

DIMENSIONS
FOR MM X BY 25.4

PRICING

			BOX/BOX/FILE (B)			
			CLOSED BACK (C)			
			SOURCE LAMINATE CASE		FLINTWOOD CASE	VENEER CASE
			Source Lam. Back & Front	Source Lam. Back, Flintwood Front	Flintwood Back & Front	Veneer Back & Front
42	16	24	2348	2811	3892	4356
42	16	30	2631	3167	4385	4879
42	16	36	2944	3563	4931	5452
42	19	24	2460	2943	4073	4562
42	19	30	2759	3318	4598	5110
42	19	36	3086	3733	5168	5713
51	16	24	2412	2872	3973	4477
51	16	30	2708	3252	4495	5025
51	16	36	3040	3663	5073	5633
51	19	24	2528	3009	4162	4688
51	19	30	2841	3406	4712	5268
51	19	36	3187	3837	5315	5901
66	16	24	2539	3013	4169	4720
66	16	30	2859	3418	4728	5307
66	16	36	3216	3862	5348	5957
66	19	24	2662	3157	4369	4944
66	19	30	3002	3582	4959	5564
66	19	36	3374	4052	5609	6248
			SECURED (S)			
			SOURCE LAMINATE CASE		FLINTWOOD CASE	VENEER CASE
			Source Lam. Back & Front	Source Lam. Back, Flintwood Front	Flintwood Back & Front	Veneer Back & Front
42	16	24	2498	3001	4152	4629
42	16	30	2796	3376	4674	5178
42	16	36	3126	3788	5246	5780
42	19	24	2617	3144	4348	4853
42	19	30	2934	3537	4899	5430
42	19	36	3278	3973	5502	6063
51	16	24	2570	3072	4250	4769
51	16	30	2883	3467	4799	5345
51	16	36	3229	3903	5403	5979
51	19	24	2694	3218	4451	4993
51	19	30	3024	3634	5029	5602
51	19	36	3386	4092	5668	6271
66	16	24	2707	3228	4462	5028
66	16	30	3046	3653	5056	5650
66	16	36	3418	4122	5707	6337
66	19	24	2839	3382	4679	5270
66	19	30	3195	3830	5302	5925
66	19	36	3586	4326	5989	6645

If Individual Lock is specified, add 168

Pricing is continued on the following page.

UTLS

Lateral Tower – Standard
(Continued)

DIMENSIONS
FOR MM X BY 25.4

PRICING

FILE/FILE (F)			CLOSED BACK (C)			
SOURCE LAMINATE CASE			FLINTWOOD CASE		VENEER CASE	
	Source Lam. Back & Front	Source Lam. Back, Flintwood Front	Flintwood Back & Front		Veneer Back & Front	
42	16	24	2118	2522	3489	3935
42	16	30	2402	2878	3983	4453
42	16	36	2715	3274	4533	5029
42	19	24	2230	2655	3670	4138
42	19	30	2532	3031	4195	4688
42	19	36	2857	3445	4769	5290
51	16	24	2182	2584	3572	4054
51	16	30	2480	2958	4092	4603
51	16	36	2810	3375	4670	5208
51	19	24	2298	2719	3761	4268
51	19	30	2612	3114	4309	4844
51	19	36	2957	3549	4916	5480
66	16	24	2309	2725	3767	4299
66	16	30	2629	3129	4328	4884
66	16	36	2984	3575	4946	5534
66	19	24	2431	2869	3963	4522
66	19	30	2771	3295	4557	5140
66	19	36	3144	3764	5206	5825
SECURED (S)			FLINTWOOD CASE		VENEER CASE	
SOURCE LAMINATE CASE			Flintwood Back & Front		Veneer Back & Front	
	Source Lam. Back & Front	Source Lam. Back, Flintwood Front				
42	16	24	2267	2708	3749	4205
42	16	30	2569	3086	4271	4758
42	16	36	2895	3500	4845	5358
42	19	24	2388	2854	3948	4429
42	19	30	2702	3252	4497	5007
42	19	36	3048	3683	5101	5644
51	16	24	2340	2783	3849	4346
51	16	30	2655	3180	4397	4923
51	16	36	3001	3611	5002	5558
51	19	24	2463	2928	4050	4570
51	19	30	2794	3343	4629	5178
51	19	36	3157	3803	5266	5848
66	16	24	2477	2938	4060	4607
66	16	30	2817	3366	4652	5228
66	16	36	3188	3833	5305	5912
66	19	24	2610	3091	4275	4848
66	19	30	2968	3539	4899	5502
66	19	36	3358	4033	5583	6222

If Individual Lock is specified, add 168

U T C E

Combo Tower – Elevated

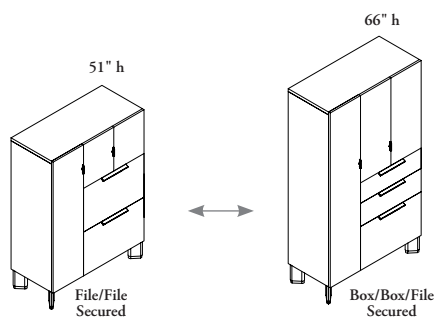

The Combo Tower provides both file and binder storage, the capability to support work surfaces, stackers and panels and the ability to route and provide access to power and data.

WHAT'S INCLUDED

1 tower, 4 angled feet, lock and keys (if specified), drawers and pulls (as specified), 42" high towers include shelves in wardrobe section, 51" and 66" high towers include a coat hook in wardrobe section, 66" high towers include a boot shelf in wardrobe section.

NOTES

The 42" high tower includes a Box/File (X) drawer combination.

51" and 66" high towers are available with Box/Box/File (B) or File/File (F) drawer combinations.

24" and 30" wide towers **cannot** be specified in the 16" depth.

Beltline Back Electrical Cut Out (E) option **cannot** be specified on the 42" high tower.

PRODUCT OPTIONS

Height	Depth	Width	Drawer Combination	Wardrobe Location	Shelf Configuration
42, 51, 66	16, 19	24, 30, 36, 42, 48	X Box/File B Box/Box/File (shown) F File/File (shown)	L Left R Right	C Closed Back S Secured

SAMPLE ORDER CODE

UTCE 51	16	48	B	L	S
---------	----	----	---	---	---

PRODUCT OPTIONS CONTINUED

Pull Style	Pull Finish	Case, Back & Front Finish	Foot Finish	Electrical Cut Out	Key Style
D District R Rectangular	Foundation Mica	Source Laminate Flintwood Natural Veneer	Q Storm White 7 Platinum V Very White X Anthracite M Graphite 2 Burnished Bronze	B Base Back Cut Out E Beltline Back Cut Out N None	K Keyed Alike R Keyed Randomly N No Lock

SAMPLE ORDER CODE CONTINUED

D	Q	Case	Back	Front	C	E	R
		VU	VU	VU			

See Pricing on the following page.

U T C E
Combo Tower – Elevated
(Continued)

DIMENSIONS
FOR MM X BY 25.4

H	D	W
42	16	36
42	16	42
42	16	48
42	19	24
42	19	30
42	19	36
42	19	42
42	19	48

PRICING

BOX/FILE (X)

CLOSED BACK (C)

SOURCE LAMINATE CASE		FLINTWOOD CASE	VENEER CASE
Source Lam. Back & Front	Source Lam. Back, Flintwood Front	Flintwood Back & Front	Veneer Back & Front
2722	3385	4639	5243
2978	3707	5084	5712
3259	4060	5576	6228
2336	2899	3960	4532
2586	3217	4399	4989
2856	3555	4873	5487
3127	3897	5345	5984
3419	4264	5857	6525

SECURED (S)

SOURCE LAMINATE CASE		FLINTWOOD CASE	VENEER CASE
Source Lam. Back & Front	Source Lam. Back, Flintwood Front	Flintwood Back & Front	Veneer Back & Front
2856	3555	4873	5487
3127	3897	5345	5984
3419	4264	5857	6525
2450	3044	4161	4738
2713	3376	4623	5226
2997	3733	5122	5752
3280	4092	5619	6271
3592	4484	6162	6840

If Base or Beltline Back Cut Out is specified, add 105

Pricing is continued on the following page.

UTCE

Combo Tower – Elevated
(Continued)

DIMENSIONS
FOR MM X BY 25.4

PRICING

			BOX/BOX/FILE (B)			
			CLOSED BACK (C)			
			SOURCE LAMINATE CASE		FLINTWOOD CASE	VENEER CASE
H	D	W	Source Lam. Back & Front	Source Lam. Back, Flintwood Front	Flintwood Back & Front	Veneer Back & Front
51	16	36	3384	4223	5799	6078
51	16	42	3683	4599	6319	6627
51	16	48	4011	5012	6897	7235
51	19	24	2934	3651	5006	5247
51	19	30	3227	4022	5522	5788
51	19	36	3541	4421	6075	6372
51	19	42	3856	4816	6625	6948
51	19	42	4201	5250	7228	7582
66	16	36	3610	4504	6195	6494
66	16	42	3930	4909	6755	7082
66	16	48	4283	5354	7373	7732
66	19	24	3124	3892	5340	5601
66	19	30	3437	4293	5894	6179
66	19	36	3778	4720	6488	6805
66	19	42	4118	5144	7080	7425
66	19	42	4490	5611	7731	8109
			SECURED (S)			
			SOURCE LAMINATE CASE		FLINTWOOD CASE	VENEER CASE
H	D	W	Source Lam. Back & Front	Source Lam. Back, Flintwood Front	Flintwood Back & Front	Veneer Back & Front
51	16	36	3541	4421	6075	6372
51	16	42	3856	4816	6625	6948
51	16	48	4201	5250	7228	7582
51	19	24	3066	3820	5240	5494
51	19	30	3376	4207	5781	6063
51	19	36	3707	4627	6364	6675
51	19	42	4042	5047	6944	7281
51	19	48	4404	5503	7581	7951
66	16	36	3778	4720	6488	6805
66	16	42	4118	5144	7080	7425
66	16	48	4490	5611	7731	8109
66	19	24	3266	4071	5590	5860
66	19	30	3600	4493	6174	6474
66	19	36	3957	4944	6800	7133
66	19	42	4311	5391	7423	7787
66	19	42	4705	5885	8108	8505

If Base or Beltline Back Cut Out is specified, add 105

Pricing is continued on the following page.

U T C E
Combo Tower – Elevated
(Continued)

DIMENSIONS
FOR MM X BY 25.4

PRICING

			FILE/FILE (F)			
			CLOSED BACK (C)			
			SOURCE LAMINATE CASE		FLINTWOOD CASE	VENEER CASE
H	D	W	Source Lam. Back & Front	Source Lam. Back, Flintwood Front	Flintwood Back & Front	Veneer Back & Front
51	16	36	3155	3931	5395	5656
51	16	42	3454	4306	5919	6204
51	16	48	3781	4724	6495	6810
51	19	24	2702	3360	4603	4824
51	19	30	2996	3733	5120	5368
51	19	36	3311	4130	5674	5950
51	19	42	3627	4527	6222	6525
51	19	48	3973	4961	6826	7161
66	16	36	3381	4219	5792	6073
66	16	42	3702	4620	6350	6659
66	16	48	4054	5065	6970	7310
66	19	24	2893	3603	4936	5175
66	19	30	3210	4002	5491	5756
66	19	36	3549	4428	6088	6381
66	19	42	3886	4855	6678	7005
66	19	48	4260	5325	7329	7687

			SECURED (S)			
			SOURCE LAMINATE CASE		FLINTWOOD CASE	VENEER CASE
H	D	W	Source Lam. Back & Front	Source Lam. Back, Flintwood Front	Flintwood Back & Front	Veneer Back & Front
51	16	36	3311	4130	5674	5950
51	16	42	3627	4527	6222	6525
51	16	48	3973	4961	6826	7161
51	19	24	2836	3531	4839	5073
51	19	30	3146	3922	5379	5641
51	19	36	3477	4339	5961	6249
51	19	42	3810	4757	6540	6860
51	19	48	4173	5214	7178	7529
66	16	36	3549	4428	6088	6381
66	16	42	3886	4855	6678	7005
66	16	48	4260	5325	7329	7687
66	19	24	3037	3781	5188	5439
66	19	30	3370	4201	5771	6051
66	19	36	3728	4652	6397	6712
66	19	42	4084	5101	7023	7362
66	19	48	4474	5598	7708	8083

If Base or Beltline Back Cut Out is specified, add 105

UTCS

Combo Tower – Standard

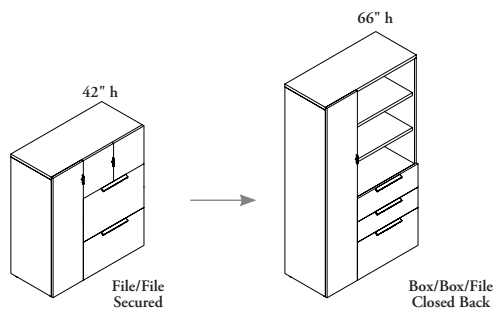

The Combo Tower provides both file and binder storage, the capability to support worksurfaces, stackers and panels.

WHAT'S INCLUDED

1 tower, lock and keys (if specified), drawers and pulls (as specified) 36" and 42" high towers include shelves in wardrobe section, 51" and 66" high towers include a coat hook in wardrobe section, 66" high towers include a bookshelf in wardrobe section.

Extra kit that contains two 1-1/4" levelers and two 1-3/4" levelers will be shipped with the storage.

NOTES

42", 51" and 66" high towers are available with Box/Box/File (B) or File/File (F) drawer combinations.

24" and 30" wide towers **cannot** be specified in the 16" depth.

PRODUCT OPTIONS

Height	Depth	Width	Drawer Combination	Wardrobe Location
42, 51, 66	16, 19	24, 30, 36, 42, 48	B Box/Box/File (shown) F File/File (shown)	L Left R Right

SAMPLE ORDER CODE

UTCS 42	16	36	B	L
----------------	-----------	-----------	----------	----------

PRODUCT OPTIONS CONTINUED

Shelf Configuration	Pull Style	Pull Finish	Case, Back & Front Finish	Key Style
C Closed Back S Secured	D District R Rectangular	Foundation Mica	Source Laminate Flintwood Natural Veneer	K Keyed Alike R Keyed Randomly N No Lock

SAMPLE ORDER CODE CONTINUED

C	D	E	Case VU	Back VU	Front VU	R
----------	----------	----------	-------------------	-------------------	--------------------	----------

See Pricing on the following page.

U T C S
Combo Tower – Standard
(Continued)

DIMENSIONS
FOR MM X BY 25.4

PRICING

			BOX/BOX/FILE (B)			
			CLOSED BACK (C)			
			SOURCE LAMINATE CASE		FLINTWOOD CASE	VENEER CASE
H	D	W	Source Lam. Back & Front	Source Lam. Back, Flintwood Front	Flintwood Back & Front	Veneer Back & Front
42	16	36	3070	3867	5373	5641
42	16	42	3351	4224	5865	6160
42	16	48	3664	4619	6414	6733
42	19	24	2639	3327	4618	4848
42	19	30	2917	3675	5103	5358
42	19	36	3219	4054	5631	5912
42	19	42	3516	4429	6155	6461
42	19	48	3846	4844	6726	7064
51	16	36	3219	4054	5631	5912
51	16	42	3514	4429	6154	6460
51	16	48	3847	4845	6731	7067
51	19	24	2766	3485	4839	5081
51	19	30	3058	3854	5353	5621
51	19	36	3376	4255	5907	6202
51	19	42	3688	4649	6457	6781
51	19	48	4033	5084	7061	7414
66	16	36	3445	4339	6026	6326
66	16	42	3764	4742	6586	6917
66	16	48	4118	5188	7206	7565
66	19	24	2956	3725	5173	5431
66	19	30	3270	4123	5727	6012
66	19	36	3611	4551	6321	6637
66	19	42	3950	4979	6913	7257
66	19	48	4322	5448	7564	7944

			SECURED (S)			
			SOURCE LAMINATE CASE		FLINTWOOD CASE	VENEER CASE
H	D	W	Source Lam. Back & Front	Source Lam. Back, Flintwood Front	Flintwood Back & Front	Veneer Back & Front
42	16	36	3219	4054	5631	5912
42	16	42	3516	4429	6155	6461
42	16	48	3846	4844	6726	7064
42	19	24	2766	3485	4839	5081
42	19	30	3058	3854	5353	5621
42	19	36	3376	4255	5907	6202
42	19	42	3688	4649	6457	6781
42	19	48	4033	5084	7061	7414
51	16	36	3376	4255	5907	6202
51	16	42	3688	4649	6457	6781
51	16	48	4033	5084	7061	7414
51	19	24	2899	3653	5074	5327
51	19	30	3207	4045	5613	5897
51	19	36	3539	4460	6197	6505
51	19	42	3873	4880	6774	7114
51	19	48	4234	5337	7413	7785
66	16	36	3611	4551	6321	6637
66	16	42	3950	4979	6913	7257
66	16	48	4322	5448	7564	7944
66	19	24	3098	3905	5422	5695
66	19	30	3431	4326	6005	6308
66	19	36	3789	4776	6634	6965
66	19	42	4149	5225	7255	7619
66	19	48	4537	5719	7942	8339

Pricing is continued on the following page.

UTCS

Combo Tower – Standard
(Continued)

DIMENSIONS
FOR MM X BY 25.4

PRICING

FILE/FILE (F)			CLOSED BACK (C)			
			SOURCE LAMINATE CASE		FLINTWOOD CASE	VENEER CASE
H	D	W	Source Lam. Back & Front	Source Lam. Back, Flintwood Front	Flintwood Back & Front	Veneer Back & Front
42	16	36	2838	3578	4969	5216
42	16	42	3120	3933	5463	5735
42	16	48	3433	4330	6011	6313
42	19	24	2410	3036	4219	4426
42	19	30	2688	3385	4703	4937
42	19	36	2987	3766	5228	5490
42	19	42	3288	4143	5753	6040
42	19	48	3614	4553	6325	6642
51	16	36	2987	3766	5228	5490
51	16	42	3287	4140	5752	6039
51	16	48	3616	4557	6328	6645
51	19	24	2536	3193	4436	4656
51	19	30	2831	3566	4950	5200
51	19	36	3146	3963	5504	5780
51	19	42	3459	4357	6055	6355
51	19	48	3806	4795	6659	6992
66	16	36	3216	4050	5623	5904
66	16	42	3533	4452	6181	6493
66	16	48	3886	4898	6802	7142
66	19	24	2727	3433	4771	5008
66	19	30	3042	3833	5325	5590
66	19	36	3382	4262	5920	6215
66	19	42	3722	4687	6510	6837
66	19	48	4092	5158	7163	7522

SECURED (S)			SOURCE LAMINATE CASE			
			Source Lam. Back & Front	Source Lam. Back, Flintwood Front	FLINTWOOD CASE	VENEER CASE
H	D	W	Source Lam. Back & Front	Source Lam. Back, Flintwood Front	Flintwood Back & Front	Veneer Back & Front
42	16	36	2987	3766	5228	5490
42	16	42	3288	4143	5753	6040
42	16	48	3614	4553	6325	6642
42	19	24	2536	3193	4436	4656
42	19	30	2831	3566	4950	5200
42	19	36	3146	3963	5504	5780
42	19	42	3459	4357	6055	6355
42	19	48	3806	4795	6659	6992
51	16	36	3146	3963	5504	5780
51	16	42	3459	4357	6055	6355
51	16	48	3806	4795	6659	6992
51	19	24	2668	3366	4672	4906
51	19	30	2979	3754	5213	5474
51	19	36	3309	4172	5795	6082
51	19	42	3644	4588	6375	6692
51	19	48	4007	5048	7010	7360
66	16	36	3382	4262	5920	6215
66	16	42	3722	4687	6510	6837
66	16	48	4092	5158	7163	7522
66	19	24	2870	3616	5022	5271
66	19	30	3202	4033	5605	5883
66	19	36	3560	4486	6231	6541
66	19	42	3916	4933	6856	7199
66	19	48	4306	5428	7539	7916

UTDC

Pedestal Tower with Cubby Back

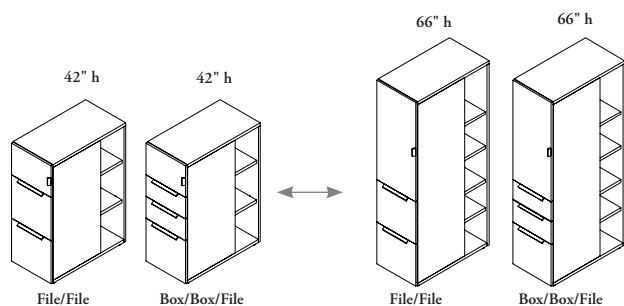

The Pedestal Tower with Cubby Back provides both file and binder storage, the capability to support worksurfaces, and panels and the ability to route and provide access to power and data.

WHAT'S INCLUDED

1 Pedestal Tower, 4 angled feet, lock and keys (if specified), drawers, door and pulls (as specified).

Extra kit that contains two 1-1/4" levelers and two 1-3/4" levelers will be shipped with the storage.

NOTES

In the Standard (S) Style, the 42", 51" and 66" heights are available in Box/Box/File (B) and File/File (F) drawer combinations.

Cubbies in the back will have a 1" inset on one side to allow for the application of an Infill Screen if closure is desired (purchased separately, see Screen Section). The handedness of the inset side will be the same side as the location of the hinges on the door.

Left or Right must be selected for this unit. Handedness is determined by the location of the hinges on the upper door.

Beltline Back Cut Out (E) **cannot** be applied to 42" Pedestal Towers.

The location of the locks on the pedestals will be on the same side as the locks for the hinged door.

PRODUCT OPTIONS

Style	Height	Depth	Drawer Combination	Door Swing Direction	Pull Style
S Standard	42, 51, 66	29, 35	B Box/Box/ File F File/File	L Left (shown) R Right	D District R Rectangular

SAMPLE ORDER CODE

UTDC S	51	35	F	L	D
--------	----	----	---	---	---

PRODUCT OPTIONS CONTINUED

Pull Finish	Case & Front Finish	Electrical Cut Out	Key Style	Foot Finish (Elevated Style)
Foundation Mica	Source Laminate Flintwood Natural Veneer	G Base Grommet (Elevated) B Base Back Cut Out (Elevated) E Beltline Back Cut Out (Elevated) N None	K Keyed Alike R Keyed Randomly N No Lock	Q Storm White 7 Platinum V Very White X Anthracite M Graphite 2 Burnished Bronze

SAMPLE ORDER CODE CONTINUED

7	Case VU	Front VU	G	R	Q
---	------------	-------------	---	---	---

See Pricing on the following page.

U T D C
Pedestal Tower with Cubby Back
(Continued)

DIMENSIONS
INCHES / MM

PRICING

DIMENSIONS INCHES / MM		STANDARD (S)			
		BOX/BOX/FILE (B)			
		SOURCE LAMINATE CASE		FLINTWOOD CASE	VENEER CASE
		Source Lam.		Flintwood Front	Veneer Front
H	D	Front	Flintwood Front	Flintwood Front	Veneer Front
42 / 1067	29 / 737	1897	2793	3325	3457
42 / 1067	35 / 889	2030	2988	3557	3701
51 / 1295	29 / 737	2318	3413	4060	4225
51 / 1295	35 / 889	2477	3653	4347	4522
66 / 1676	29 / 737	2529	3725	4429	4608
66 / 1676	35 / 889	2703	3984	4742	4930
		FILE/FILE (F)			
		SOURCE LAMINATE CASE		FLINTWOOD CASE	VENEER CASE
		Source Lam.		Flintwood Front	Veneer Front
H	D	Front	Flintwood Front	Flintwood Front	Veneer Front
42 / 1067	29 / 737	1821	2607	3118	3242
42 / 1067	35 / 889	1949	2789	3336	3469
51 / 1295	29 / 737	2225	3187	3811	3961
51 / 1295	35 / 889	2382	3410	4079	4240
66 / 1676	29 / 737	2428	3476	4157	4323
66 / 1676	35 / 889	2599	3718	4449	4626

UTDD

Pedestal Tower with Solid Back

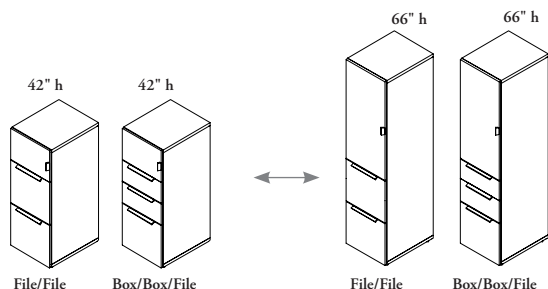

The Pedestal Tower with Solid Back provides both file and binder storage, and the capability to support both worksurfaces, and panels.

WHAT'S INCLUDED

1 Pedestal Tower, 4 angled feet, lock and keys (if specified), drawers, door and pulls (as specified).

NOTES

In the Standard (S) Style, the 42", 51" and 66" heights are available in Box/Box/File (B) and File/File (F) drawer combinations.

The location of the locks on the Pedestals will be on the same side as the locks for the hinged door.

The Pedestal Tower with Solid Back must be attached to worksurface, panel or another storage unit. It **cannot** be freestanding.

This product includes extended levelers (UNSLB) already installed.

PRODUCT OPTIONS

Style	Height	Depth	Drawer Combination	Door Swing Direction	Pull Style	Pull Finish	Case, Back & Front Finish	Key Style	Foot Finish (Elevated Style)
S Standard (left is shown)	42, 51, 66	19, 23	B Box/Box/File F File/File	L Left (shown) R Right	D District R Rectangular	Foundation Mica	Source Laminate Flintwood Natural Veneer	K Keyed Alike R Keyed Randomly N No Lock	Q Storm White 7 Platinum V Very White X Anthracite M Graphite 2 Burnished Bronze

SAMPLE ORDER CODE

							Case	Back	Front			
UTDD	S	51	19	B	L	D	7	VU	VU	VU	R	Q

DIMENSIONS
INCHES / MM

Height	Depth
42 / 1067	19 / 483
42 / 1067	23 / 584
51 / 1295	19 / 483
51 / 1295	23 / 584
66 / 1676	19 / 483
66 / 1676	23 / 584

PRICING

STANDARD (S)					
BOX/BOX/FILE (B)					
SOURCE LAMINATE CASE		FLINTWOOD CASE		VENEER CASE	
Source Lam. Back & Front	Source Lam. Back, Back & Front	Flintwood Back & Front	Veneer Back & Front		
1523	2233	2644	2750		
1623	2449	2905	3020		
1861	2733	3232	3360		
1982	2990	3549	3693		
2031	2981	3527	3665		
2160	3263	3873	4027		
FILE/FILE (F)					
SOURCE LAMINATE CASE		FLINTWOOD CASE		VENEER CASE	
Source Lam. Back & Front	Source Lam. Back, Back & Front	Flintwood Back & Front	Veneer Back & Front		
1448	2123	2483	2584		
1544	2304	2728	2836		
1770	2597	3036	3156		
1885	2817	3333	3467		
1931	2833	3309	3445		
2058	3074	3636	3780		

UTDK

Pedestal Tower with Side Closet

The Pedestal Tower with Side Closet provides file and binder storage in addition to a coat closet. As with all Pedestal Towers it has the capability to support both work surfaces, and panels.

WHAT'S INCLUDED

1 Pedestal Tower, lock and keys (if specified), drawers, door and pulls (as specified), coat hooks.

Extra kit that contains two 1-1/4" levelers and two 1-3/4" levelers will be shipped with the storage.

NOTES

51" and 66" heights are available in Box/Box/File (B) and File/File (F) drawer combinations.

Handedness is determined by the location of the side closet.

The location of the locks on the Pedestals will be on the same side as the locks for the front hinged door.

The depth of the front section is always 19" regardless of the total depth of the unit. The width of the side closet section will change depending on the width of the unit specified.

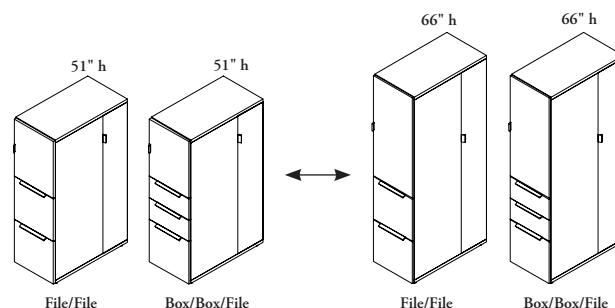

PRODUCT OPTIONS

Style	Height	Depth	Drawer Combination	Location of Closet	Pull Style	Pull Finish	Case & Front Finish	Key Style	Foot Finish (Elevated Style)
S Standard (shown)	51, 66	29, 35	B Box/Box/File F File/File	L Left R Right (shown)	D District R Rectangular	Foundation Mica	Source Laminate Flintwood Natural Veneer	K Keyed Alike R Keyed Randomly N No Lock	Q Storm White 7 Platinum V Very White X Anthracite M Graphite 2 Burnished Bronze

SAMPLE ORDER CODE

							Case	Front			
UTDK	S	51	35	L	L	D	7	VU	VU	R	Q

DIMENSIONS INCHES / MM

H	D
51 / 1295	29 / 737
51 / 1295	35 / 889
66 / 1676	29 / 737
66 / 1676	35 / 889

PRICING

STANDARD (S)					
BOX/BOX/FILE (B)					
SOURCE LAMINATE CASE		FLINTWOOD CASE		VENEER CASE	
Source Lam. Back & Front	Source Lam. Back, Flintwood Front	Flintwood Back & Front		Veneer Back & Front	
2666	3926	4672		4857	
2850	4201	4999		5200	
2907	4282	5095		5302	
3110	4582	5454		5673	
FILE/FILE (F)					
SOURCE LAMINATE CASE		FLINTWOOD CASE		VENEER CASE	
Source Lam. Back & Front	Source Lam. Back, Flintwood Front	Flintwood Back & Front		Veneer Back & Front	
2560	3664	4382		4558	
2741	3922	4688		4879	
2793	4000	4781		4972	
2988	4277	5118		5319	

U T W
Side Open Tower

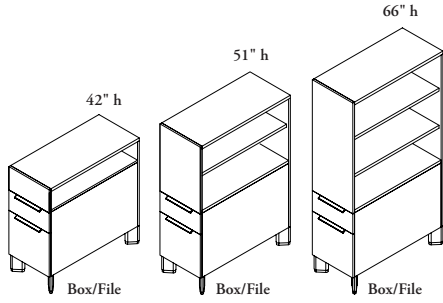

The Side Open Tower provides both file storage and open binder storage and the capability to support worksurfaces and panels.

WHAT'S INCLUDED

1 side open tower with drawers and pulls (as specified), 4 angled feet (if specified), height-adjustable shelves (depending on height and style selected), lock and keys (if specified).

NOTES

The Elevated (E) tower includes a Box/File (X) drawer combination.

The Standard (S) tower is available with Box/Box/File (B) or File/File (F) drawer combinations.

Left/Right orientation is determined by the location of the open compartment.

Power and data access **cannot** be applied to the Side Open Tower.

This product includes extended levelers (UNSLB) already installed.

PRODUCT OPTIONS

Style	Height	Depth	Width	Open Compartment Location	Drawer Combination	Pull Style	Pull Finish	Case & Front Finish	Key Style	Foot Finish (Elevated Style)
E Elevated (shown)	42, 51, 66	19, 23, 29, 35	16	L Left R Right (shown)	X Box/File B Box/Box/File F File/File	D District R Rectangular	Foundation Mica	Source Laminate Flintwood Natural Veneer	K Keyed Alike R Keyed Randomly N No Lock	Q Storm White 7 Platinum V Very White X Anthracite M Graphite 2 Burnished Bronze
S Standard										

SAMPLE ORDER CODE

								Case	Front		
UTW E	42	19	16	L	X	D	7	ZA	ZA	R	7

DIMENSIONS FOR MM X BY 25.4

PRICING

			ELEVATED (E)					
			BOX/FILE (X)					
			SOURCE LAMINATE CASE		FLINTWOOD CASE		VENEER CASE	
H	D	W	Source Lam. Front	Flintwood Front	Flintwood Front	Veneer Front		
42	19	16	1480	2215	2707	2842		
42	23	16	1535	2299	2822	2966		
42	29	16	1644	2468	3048	3199		
42	35	16	1720	2584	3199	3359		
51	19	16	1723	2589	3207	3369		
51	23	16	1836	2770	3448	3619		
51	29	16	2025	3062	3834	4026		
51	35	16	2118	3205	4025	4227		
66	19	16	2069	3128	3921	4116		
66	23	16	2220	3366	4232	4446		
66	29	16	2462	3738	4733	4969		
66	35	16	2576	3921	4969	5216		

Pricing is continued on the following page.

U T W
Side Open Tower
(Continued)

DIMENSIONS
FOR MM X BY 25.4

H	D	W
42	19	16
42	23	16
42	29	16
42	35	16
51	19	16
51	23	16
51	29	16
51	35	16
66	19	16
66	23	16
66	29	16
66	35	16

PRICING

STANDARD (S)

BOX/BOX/FILE (B)

SOURCE LAMINATE CASE		FLINTWOOD CASE	VENEER CASE
Source Lam. Front	Flintwood Front	Flintwood Front	Veneer Front
1376	2144	2835	2978
1433	2233	2958	3108
1527	2375	3148	3304
1602	2497	3305	3472
1610	2509	3324	3488
1731	2696	3572	3749
1907	2971	3935	4130
2004	3119	4132	4339
1955	3045	4031	4233
2113	3291	4355	4574
2344	3651	4833	5076
2460	3833	5076	5330

FILE/FILE (F)

SOURCE LAMINATE CASE		FLINTWOOD CASE	VENEER CASE
Source Lam. Front	Flintwood Front	Flintwood Front	Veneer Front
1313	2045	2707	2842
1368	2130	2822	2966
1477	2301	3048	3199
1551	2416	3199	3359
1554	2423	3207	3369
1671	2602	3448	3619
1859	2896	3834	4026
1952	3040	4025	4227
1900	2959	3921	4116
2051	3195	4232	4446
2296	3574	4733	4969
2410	3753	4969	5216

UTWW

Wide Side Open Tower

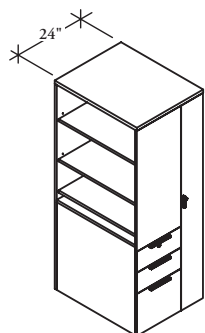

The Wide Side Open Tower provides both file storage and open binder storage and the capability to support worksurfaces and panels.

WHAT'S INCLUDED

1 side open tower with drawers and pulls (as specified), 4 angled feet (if specified), height-adjustable shelves (depending on height and style selected), lock and keys (if specified).

Extra kit that contains two 1-1/4" levelers and two 1-3/4" levelers will be shipped with the storage.

NOTES

The Elevated (E) tower includes a Box/File (X) drawer combination.

The Standard (S) tower is available with Box/Box/File (B) or File/File (F) drawer combinations.

Left/Right orientation is determined by the location of the open compartment.

Power and data access **cannot** be applied to the Side Open Tower.

PRODUCT OPTIONS

Style	Height	Depth	Width	Open Compartment Location	Drawer Combination	Pull Style	Pull Finish	Case & Front Finish	Key Style	Foot Finish (Elevated Style)
E Elevated S Standard (shown)	42, 51, 66	19, 23, 29, 35	24	L Left (shown) R Right	X Box/File B Box/Box/File F File/File	D District R Rectangular	Foundation Mica	Source Laminate Flintwood Natural Veneer	K Keyed Alike R Keyed Randomly N No Lock	Q Storm White 7 Platinum V Very White X Anthracite M Graphite 2 Burnished Bronze

SAMPLE ORDER CODE

								Case	Front		
UTWW E	42	19	24	L	X	D	7	ZA	ZA	R	7

DIMENSIONS FOR MM X BY 25.4

PRICING

			ELEVATED (E)					
			BOX/FILE (X)					
			SOURCE LAMINATE CASE		FLINTWOOD CASE		VENEER CASE	
H	D	W	Source Lam. Front	Flintwood Front	Flintwood Front	Veneer Front		
42	19	24	2005	2759	4137	4010		
42	23	24	2106	2876	4427	4279		
42	29	24	2257	3082	4795	4637		
42	35	24	2423	3312	5193	5022		
51	19	24	2454	3397	4813	4681		
51	23	24	2620	3626	5234	5081		
51	29	24	2876	3976	5665	5502		
51	35	24	3091	4278	6135	5954		
66	19	24	2818	3906	5707	5570		
66	23	24	3014	4182	6217	6063		
66	29	24	3328	4607	6727	6563		
66	35	24	3579	4962	7281	7102		

Pricing is continued on the following page.

U T W W
Wide Side Open Tower
(Continued)

DIMENSIONS
FOR MM X BY 25.4

H	D	W
42	19	24
42	23	24
42	29	24
42	35	24
51	19	24
51	23	24
51	29	24
51	35	24
66	19	24
66	23	24
66	29	24
66	35	24

PRICING

STANDARD (S)

BOX/BOX/FILE (B)

SOURCE LAMINATE CASE		FLINTWOOD CASE	VENEER CASE
Source Lam. Front	Flintwood Front	Flintwood Front	Veneer Front
1835	2592	4421	4301
1935	2707	4716	4576
2087	2912	5094	4943
2256	3146	5502	5335
2288	3229	5084	4955
2452	3457	5513	5368
2707	3808	5953	5797
2925	4112	6429	6261
2648	3736	5975	5845
2847	4011	6497	6348
3158	4440	7017	6857
3411	4795	7580	7405

FILE/FILE (F)

SOURCE LAMINATE CASE		FLINTWOOD CASE	VENEER CASE
Source Lam. Front	Flintwood Front	Flintwood Front	Veneer Front
1772	2527	4305	4181
1871	2657	4597	4449
2031	2847	4962	4804
2193	3077	5358	5189
2218	3169	4982	4848
2387	3398	5403	5249
2648	3751	5835	5672
2862	4050	6303	6124
2586	3680	5875	5736
2792	3949	6387	6231
3087	4375	6896	6731
3336	4725	7452	7270

U O H Sliding Door Overhead

The Sliding Door Overhead is a 16" deep double sliding door overhead that mounts to a panel or wall to provide secured lockable storage.

WHAT'S INCLUDED

1 cabinet with 2 sliding doors, lock and keys (if specified), mounting bracket (as specified).

NOTES

The 21" high overhead is **not** available in 54" and 60" widths.

Standard Glass, Frost is an etched tempered glass.

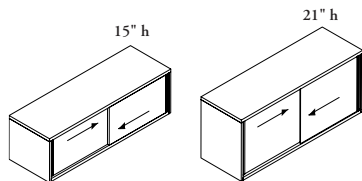

PRODUCT OPTIONS

Height	Width	Pull Finish	Case & Front Finish	Key Style	Mounting Bracket Configuration
15, 21	30, 36, 42, 48, 54, 60	Foundation Mica	Source Laminate Flintwood Natural Veneer FT Frost Standard Glass BP Backpainted Glass	K Keyed Alike R Keyed Randomly N No Lock	D District A Altos L Leverage W Drywall

SAMPLE ORDER CODE

		Case		Front			
UOH 15	42	Q	ZA	FT	K	D	

DIMENSIONS INCHES / MM

D	W
15 / 381	30 / 762
15 / 381	36 / 914
15 / 381	42 / 1067
15 / 381	48 / 1219
15 / 381	54 / 1372
15 / 381	60 / 1524
21 / 533	30 / 762
21 / 533	36 / 914
21 / 533	42 / 1067
21 / 533	48 / 1219

PRICING

SOURCE LAMINATE CASE			FLINTWOOD CASE		VENEER CASE	
Source Lam. Back & Front	Source Lam. Back, Flintwood Front	Source Lam. Back, Glass Front	Glass Front	Flintwood Front	Glass Front	Veneer Front
1154	1781	1781	2456	2573	2541	2661
1248	1846	1846	2571	2692	2661	2788
1343	2061	2061	2857	2992	2957	3096
1441	2124	2124	2971	3113	3078	3226
1532	2187	2187	3084	3231	3193	3348
1623	2246	2246	3202	3354	3316	3475
1410	2187	2187	2890	3028	2990	3133
1525	2273	2273	3029	3175	3134	3287
1644	2538	2538	3366	3526	3485	3651
1768	2626	2626	3503	3672	3482	3650

If Wall Rail System Mounting Brackets are specified, add 204

U O H C

Sliding Door Centermount Overhead

The Sliding Door Centermount Overhead is a 16" deep double sliding door overhead that sits atop a panel to provide secured lockable storage.

WHAT'S INCLUDED

1 cabinet with 2 sliding doors, lock and keys (if specified).

WHAT'S EXCLUDED

When Leverage Center Upmount (N) mounting brackets have been specified, the Centermount Overhead Storage Bracket (KUOHC) must be ordered separately. See the Leverage: *Mounted Storage & Accessories* section.

When District Center Upmount (U) mounting brackets have been specified, Centermount Cabinet Support Posts & Trim (UNOPT) or Centermount Cabinet Support Brackets & Top Trim (UNOBT) must be ordered separately. Can be found in the *Supports* section.

NOTES

Standard Glass, Frost is an etched tempered glass.

The Door Location option does not apply to a Single-Sided (S) overhead. (N) must be selected.

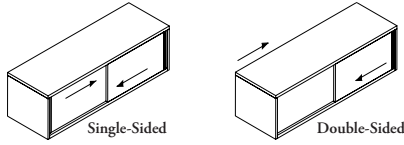

PRODUCT OPTIONS

Style	Height	Width	Door Location (Double-Sided)	Pull Finish	Case, Back & Front Finish	Key Style	Mounting Bracket Configuration
S Single-Sided D Double-Sided	15	30, 36, 42, 48, 54, 60, 66, 72, 78, 84, 90, 96	L Left R Right N Not Applicable	Foundation Mica	Source Laminate Flintwood Natural Veneer FT Frost Standard Glass BP Backpainted Glass	K Keyed Alike R Keyed Randomly N No Lock	U District Center Upmount N Leverage Center Upmount

SAMPLE ORDER CODE

				Case Back Front					
UOHC S	15	42	N	E	ZA	ZA	FT	K	U

DIMENSIONS
INCHES / MM

PRICING

		SINGLE-SIDED (S)						
		SOURCE LAMINATE CASE			FLINTWOOD CASE		VENEER CASE	
D	W	Source Lam. Back & Front	Source Lam. Back, Flintwood Front	Source Lam. Back, Glass Front	Flintwood Back, Glass Front	Flintwood Back & Front	Veneer Back, Glass Front	Veneer Back & Front
15 / 381	30 / 762	1016	1259	1641	2346	2434	2434	2521
15 / 381	36 / 914	1109	1332	1707	2460	2552	2554	2647
15 / 381	42 / 1067	1203	1416	1921	2751	2855	2856	2958
15 / 381	48 / 1219	1302	1496	1986	2868	2975	2978	3085
15 / 381	54 / 1372	1391	1581	2046	2982	3091	3094	3207
15 / 381	60 / 1524	1483	1659	2109	3101	3218	3220	3336
15 / 381	66 / 1676	1581	1751	2174	3226	3343	3349	3469
15 / 381	72 / 1829	1676	1867	2237	3353	3479	3482	3608
15 / 381	78 / 1981	1769	1980	2303	3488	3619	3622	3753
15 / 381	84 / 2134	1859	2093	2372	3627	3764	3768	3905
15 / 381	90 / 2286	1952	2197	2444	3774	3912	3917	4058
15 / 381	96 / 2438	n/a	n/a	n/a	3924	4070	4075	4223

Pricing is continued on the following page.

U O H C
Sliding Door Centermount Overhead
(Continued)

DIMENSIONS
INCHES / MM

PRICING

DIMENSIONS INCHES / MM		DOUBLE-SIDED (D)							
		SOURCE LAMINATE CASE			FLINTWOOD CASE		VENEER CASE		
D	W	Source Lam. Back & Front	Source Lam. Back, Flintwood Front	Source Lam. Back, Glass Front	Flintwood Back, Glass Front	Flintwood Back & Front	Veneer Back, Glass Front	Veneer Back & Front	
15 / 381	30 / 762	1475	1883	2299	3284	3408	3408	3530	
15 / 381	36 / 914	1585	2025	2389	3447	3574	3577	3707	
15 / 381	42 / 1067	1706	2180	2691	3852	3996	3997	4143	
15 / 381	48 / 1219	1833	2344	2783	4013	4162	4166	4320	
15 / 381	54 / 1372	1955	2453	2866	4173	4330	4334	4493	
15 / 381	60 / 1524	2082	2567	2950	4343	4501	4505	4670	
15 / 381	66 / 1676	2203	2668	3041	4513	4684	4687	4857	
15 / 381	72 / 1829	2324	2785	3133	4695	4873	4876	5051	
15 / 381	78 / 1981	2453	2893	3226	4882	5066	5070	5253	
15 / 381	84 / 2134	2567	2996	3324	5079	5269	5274	5464	
15 / 381	90 / 2286	2695	3148	3422	5281	5480	5485	5683	
15 / 381	96 / 2438	n/a	n/a	n/a	5493	5697	5704	5911	

U O O

Open Overhead

The Open Overhead is a 16" deep open cabinet that is mounted to a panel or wall to provide easily accessible open storage.

WHAT'S INCLUDED

1 cabinet with 1 to 2 height-adjustable shelves (depending on height and width), mounting bracket (as specified).

NOTES

The 21" high overhead is **not** available with 54" and 60" widths.

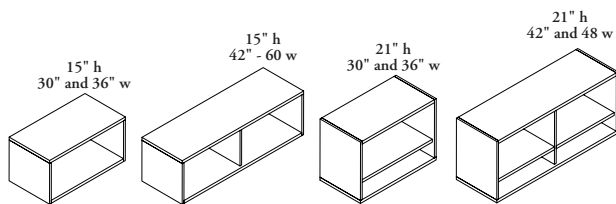

PRODUCT OPTIONS

Height	Width	Case & Back Finish	Mounting Brackets
15, 21	30, 36, 42, 48, 54, 60	Source Laminate Flintwood Natural Veneer	D District A Altos L Leverage W Drywall

SAMPLE ORDER CODE

		Case	Back	
UOO 15	42	ZA	ZA	D

DIMENSIONS INCHES / MM

H	W
15 / 381	30 / 762
15 / 381	36 / 914
15 / 381	42 / 1067
15 / 381	48 / 1219
15 / 381	54 / 1372
15 / 381	60 / 1524
21 / 533	30 / 762
21 / 533	36 / 914
21 / 533	42 / 1067
21 / 533	48 / 1219

PRICING

SOURCE LAMINATE CASE	FLINTWOOD CASE	VENEER CASE
Source Lam. Back	Flintwood Back	Veneer Back
632	1699	1753
675	1784	1842
730	1876	1936
779	1973	2038
828	2067	2130
875	2159	2231
755	2165	2318
809	2278	2437
879	2397	2567
938	2522	2701

If Wall Rail System Mounting Brackets are specified, add 204

U O O C

Open Centermount Overhead

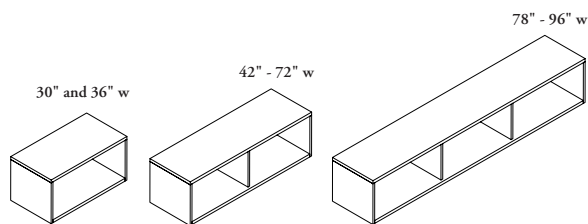

The Centermount Open Overhead is a 16" deep open cabinet that sits atop a panel to provide accessible open storage in a single- or double-sided application.

WHAT'S INCLUDED

- 42" - 72" h = 1 divider
- 78" - 96" h = 2 dividers

WHAT'S EXCLUDED

When Leverage Center Upmount (N) mounting brackets have been specified, the Centermount Overhead Storage Bracket (KUOHC) must be ordered separately. See the Leverage: *Mounted Storage & Accessories* section.

When District Center Upmount (U) mounting brackets have been specified, Centermount Cabinet Support Posts & Trim (UNOPT) or Centermount Cabinet Support Brackets & Top Trim (UNOBT) must be ordered separately. Can be found in the *Supports* section.

NOTES

The Open Compartment Locations (L & R) do **not** apply to the Single-Sided (S) stacker. (N) must be selected.

PRODUCT OPTIONS

Style	Height	Width	Open Location (Double-Sided)	Case & Back Finish	Mounting Brackets
S Single-Sided (Shown) D Double-Sided	09, 15	30, 36, 42, 48, 54, 60, 66, 72, 78, 84, 90, 96	L Left R Right N Not Applicable	Source Laminate Flintwood Natural Veneer	U District Center Upmount N Leverage Center Upmount

SAMPLE ORDER CODE

				Case	Back	
UOOC S	09	42	N	ZA	ZA	N

DIMENSIONS
INCHES / MM

H	W
9 / 229	30 / 762
9 / 229	36 / 914
9 / 229	42 / 1067
9 / 229	48 / 1219
9 / 229	54 / 1372
9 / 229	60 / 1524
9 / 229	66 / 1676
9 / 229	72 / 1829
9 / 229	78 / 1981
9 / 229	84 / 2134
9 / 229	90 / 2286
9 / 229	96 / 2438
15 / 381	30 / 762
15 / 381	36 / 914
15 / 381	42 / 1067
15 / 381	48 / 1219
15 / 381	54 / 1372
15 / 381	60 / 1524
15 / 381	66 / 1676
15 / 381	72 / 1829
15 / 381	78 / 1981
15 / 381	84 / 2134
15 / 381	90 / 2286
15 / 381	96 / 2438

PRICING

SINGLE-SIDED (S)

SOURCE LAMINATE CASE	FLINTWOOD CASE	VENEER CASE
Source Lam. Back	Flintwood Back	Veneer Back
445	1403	1452
483	1482	1533
532	1563	1620
574	1649	1708
620	1733	1794
662	1821	1883
707	1911	1976
752	2006	2075
828	2205	2283
869	2317	2399
912	2431	2519
n/a	2553	2646
493	1559	1615
534	1645	1702
592	1737	1797
640	1833	1898
688	1925	1995
738	2021	2092
787	2122	2196
836	2229	2307
886	2453	2538
930	2574	2665
987	2702	2797
n/a	2837	2939

Pricing is continued on the following page.

U O O C
Open Centermount Overhead
(Continued)

DIMENSIONS
INCHES / MM

PRICING

		DOUBLE-SIDED (D)		
		SOURCE LAMINATE CASE	FLINTWOOD CASE	VENEER CASE
H	W	Source Lam. Back	Flintwood Back	Veneer Back
9 / 229	30 / 762	499	1487	1541
9 / 229	36 / 914	531	1573	1626
9 / 229	42 / 1067	566	1660	1720
9 / 229	48 / 1219	601	1752	1813
9 / 229	54 / 1372	647	1873	1940
9 / 229	60 / 1524	695	2006	2074
9 / 229	66 / 1676	743	2148	2221
9 / 229	72 / 1829	790	2298	2375
9 / 229	78 / 1981	833	2456	2542
9 / 229	84 / 2134	877	2628	2720
9 / 229	90 / 2286	930	2813	2911
9 / 229	96 / 2438	n/a	3010	3114
15 / 381	30 / 762	554	1656	1712
15 / 381	36 / 914	591	1746	1807
15 / 381	42 / 1067	627	1843	1909
15 / 381	48 / 1219	668	1946	2014
15 / 381	54 / 1372	720	2082	2155
15 / 381	60 / 1524	770	2229	2306
15 / 381	66 / 1676	824	2385	2467
15 / 381	72 / 1829	875	2552	2641
15 / 381	78 / 1981	928	2732	2827
15 / 381	84 / 2134	974	2920	3022
15 / 381	90 / 2286	1035	3127	3233
15 / 381	96 / 2438	n/a	3343	3460

UTS
Side Filer

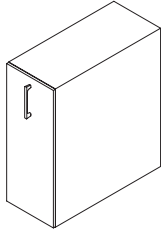

The Side Filer offers personal storage with space dividing functionality (users can leave the side filer open for lateral privacy). Designed for fixed or height-adjustable tables, it can be freestanding or attached based on layout requirements. Accessories can be specified for further functionality and better organization.

WHAT'S INCLUDED

1 side filer unit with levelers, 1 drawer with casters, metal shelves, 1 coat hook (wardrobe option only), lock and keys, USB with extension kit, grommet (if specified).

If Accessory Bundle A is specified:

1 pen pocket, 1 hanging tray, 1 headphone hook

If Accessory Bundle B is specified:

1 pen pocket, 1 hanging tray, 1 headphone hook, 1 paper filer

WHAT'S EXCLUDED:

Storage to worksurface support brackets, Side Filer Support Kit.

The Digital Lock (D) option does not include the Programming Key and the separate Manager Key. For further details on both related keys, please see the Teknion Lock Specification Guide on our website.

NOTES

Configurations without Wardrobe: (K, M, P) are only available in Depth 24".

To connect to a panel, Side Filer Support Kit (UWSPK) needs to be ordered separately.

To connect to a Worksurface, Worksurface-to-Tower Bracket Kit (UWBT) needs to be ordered separately.

PRODUCT OPTIONS

Height	Depth	Configuration	Handedness	Pull Finish	Case & Front Finish	Metal Finish	USB Power	Key
42, 51	24, 30, 36	N No Accessories, With Wardrobe	L Left	Foundation	Source Laminate	Foundation	N No	N No Key
		A Accessory Bundle A, With Wardrobe	R Right	Mica	Flintwood	Mica	S Grommet on the side	K Key Alike
		B Accessory Bundle B, With Wardrobe			Natural Veneer	Accent	B Grommet at the base	R Key Random
		K No Accessories, No Wardrobe						D Digital Lock
		M Accessory Bundle A, No Wardrobe						
		P Accessory Bundle B, No Wardrobe						

SAMPLE ORDER CODE

				Case		Front			
UTS 42	30	N	L	7	ZA	ZA	74	N	N

DIMENSIONS
INCHES / MM

H	W
42 / 1067	24 / 610
51 / 1295	24 / 610

PRICING

NO ACCESSORIES, NO WARDROBE (K)

SOURCE LAMINATE CASE		FLINTWOOD CASE		VENEER CASE	
Source Lam. Case & Front	Source Lam. Case, Flintwood Front	Flintwood Case & Front	Flintwood Case & Front	Veneer Case & Front	Veneer Case & Front
2274	2380	3969	4214	4166	4426
2450	2567				

NO ACCESSORIES, WITH WARDROBE (N)

SOURCE LAMINATE CASE		FLINTWOOD CASE		VENEER CASE	
Source Lam. Case & Front	Source Lam. Case, Flintwood Front	Flintwood Case & Front	Flintwood Case & Front	Veneer Case & Front	Veneer Case & Front
42 / 1067	24 / 610	2362	2468	4161	4371
42 / 1067	30 / 762	2638	2656	4431	4652
42 / 1067	36 / 914	2801	2907	4573	4800
51 / 1295	24 / 610	2538	2656	4431	4652
51 / 1295	30 / 762	2813	2932	4766	5004
51 / 1295	36 / 914	2971	3094	4930	5176

If Mica/Accent Finish is specified, add 43

If Grommet is specified, add 265

If Digital Lock is specified, add 480

Pricing is continued on the following page.

U T S
Side Filer (Continued)

DIMENSIONS
INCHES / MM

H	W
42 / 1067	24 / 610
51 / 1295	24 / 610

PRICING

ACCESSORIES BUNDLE A, NO WARDROBE (M)

SOURCE LAMINATE CASE		FLINTWOOD CASE	VENEER CASE
Source Lam. Case & Front	Source Lam. Case, Flintwood Front	Flintwood Case & Front	Veneer Case & Front
2404	2509	4098	4297
2579	2696	4345	4554

ACCESSORIES BUNDLE A, WITH WARDROBE (A)

SOURCE LAMINATE CASE		FLINTWOOD CASE	VENEER CASE		
Source Lam. Case & Front	Source Lam. Case, Flintwood Front	Flintwood Case & Front	Veneer Case & Front		
42 / 1067	24 / 610	2492	2597	4290	4499
42 / 1067	30 / 762	2767	2785	4560	4782
42 / 1067	36 / 914	2932	3036	4701	4930
51 / 1295	24 / 610	2667	2785	4560	4782
51 / 1295	30 / 762	2942	3060	4895	5132
51 / 1295	36 / 914	3101	3225	5058	5305

ACCESSORIES BUNDLE B, NO WARDROBE (P)

SOURCE LAMINATE CASE		FLINTWOOD CASE	VENEER CASE		
Source Lam. Case & Front	Source Lam. Case, Flintwood Front	Flintwood Case & Front	Veneer Case & Front		
42 / 1067	24 / 610	2486	2592	4179	4377
51 / 1295	24 / 610	2661	2779	4426	4637

ACCESSORIES BUNDLE B, WITH WARDROBE (B)

SOURCE LAMINATE CASE		FLINTWOOD CASE	VENEER CASE		
Source Lam. Case & Front	Source Lam. Case, Flintwood Front	Flintwood Case & Front	Veneer Case & Front		
42 / 1067	24 / 610	2573	2679	4373	4582
42 / 1067	30 / 762	2849	2866	4643	4863
42 / 1067	36 / 914	3012	3118	4783	5011
51 / 1295	24 / 610	2748	2866	4643	4863
51 / 1295	30 / 762	3025	3141	4977	5215
51 / 1295	36 / 914	3182	3306	5140	5387

If Mica/Accent Finish is specified, add 43
 If Grommet is specified, add 265
 If Digital Lock is specified, add 480

UTM Mini Side Filer

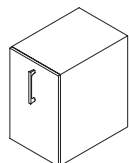

The Mini Side Filer offers personal storage and space division and is designed to be worksurface supporting.

WHAT'S INCLUDED

1 mini side filer unit with levelers, 1 drawer, metal shelves, lock and keys, USB with extension kit, grommet (if specified).

WHAT'S EXCLUDED

Storage to worksurface support brackets.

To connect to a Worksurface, Worksurface-to-Tower Bracket Kit (UWBT) needs to be ordered separately.

The Digital Lock (D) option does not include the Programming Key and the separate Manager Key. For further details on both related keys, please see the Teknion Lock Specification Guide on our website.

PRODUCT OPTIONS

Height	Depth	Configuration	Handedness	Pull Finish	Case & Front Finish	Metal Finish	USB Power	Key
28	23, 29	N No Accessories A Accessory Bundle A B Accessory Bundle B	L Left R Right	Foundation Mica	Source Laminate Flintwood Natural Veneer	Foundation Mica Accent	N No Y Yes	N No Key K Key Alike R Key Random D Digital Lock

SAMPLE ORDER CODE

UTM	28	23	N	L	7	Case	Front	74	N	N
UTM 28	23	N	L	7	ZA	ZA	74	N	N	

DIMENSIONS INCHES / MM

H	W
28 / 711	23 / 584
28 / 711	29 / 735

PRICING

NO ACCESSORIES (N)

SOURCE LAMINATE CASE		FLINTWOOD CASE	VENEER CASE
Source Lam. Case & Front	Source Lam. Case, Flintwood Front	Flintwood Case & Front	Veneer Case & Front
1994	2072	3686	3872
2345	2424	3904	4100

ACCESSORIES BUNDLE A (A)

SOURCE LAMINATE CASE		FLINTWOOD CASE	VENEER CASE
Source Lam. Case & Front	Source Lam. Case, Flintwood Front	Flintwood Case & Front	Veneer Case & Front
2122	2201	3816	4001
2473	2553	4032	4228

ACCESSORIES BUNDLE B (B)

SOURCE LAMINATE CASE		FLINTWOOD CASE	VENEER CASE
Source Lam. Case & Front	Source Lam. Case, Flintwood Front	Flintwood Case & Front	Veneer Case & Front
2204	2283	3899	4082
2556	2636	4114	4310

If Mica/Accent Finish is specified, add 43

If USB is specified, add 265

If Digital Lock is specified, add 480

Linking Brackets connect storage units together.

WHAT'S INCLUDED

Linking brackets as per specified.

NOTES

When routing electrics beneath a storage spine, storage units must be linked together to ensure certification.

Finished in Platinum Grey.

UNSLB
Linking Bracket

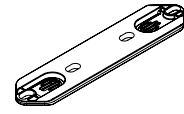

For Elevated Storage

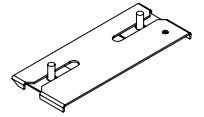

For Standard Storage

PRODUCT OPTIONS

Style	Quantity
E For Elevated Storage	4, 6, 12
S For Standard Storage	

SAMPLE ORDER CODE

UNSLB S	12
----------------	-----------

QUANTITY

PRICING

	Elevated (E)	Standard (S)
4	72	72
6	107	107
12	205	212

UN SXL

Storage Extended Leveling Kit

The Storage Extended Leveling Kit provides extended leveling height for District storage in standard configuration.

WHAT'S INCLUDED

Black leveler base with Zinc plated threaded rod.

NOTES

These are 5/16-18 UNC levelers that can be ordered if extra leveling range is needed or if extra kit was not sufficient to complete installation.

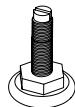

PRODUCT OPTIONS

Levelers Length	Quantity
A 1-1/4"	30, 60, 120
B 1-1/2"	
C 1-3/4"	

SAMPLE ORDER CODE

UN SXL B	30
----------	----

QUANTITY	PRICING
30	200
60	228
120	319

Locker Accessories can be used when reconfiguring a dual or quad locker from a "shelf" configuration to a "closet" configuration and vice versa.

WHAT'S INCLUDED

1 shelf (as specified) or one hook.

NOTES

Depths 23", 29" and 35" are **not** available when S24D, S30D, S36D and S48Q Shelf Styles are specified.

Shelves must be specified the same material as the case.

The single locker shelves (S125) and (S165) are only for use with the Single Locker with Solid Back (UKSD).

**U W K A
Locker Accessories**

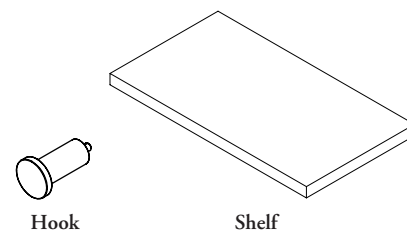

PRODUCT OPTIONS

Style		Depth (Applies to Shelf)	Shelf Finish (If applicable)
HOOK	Coat Hook	16, 19, 23, 29, 35	Source Laminate Flintwood Natural Veneer
S12S	Shelf for 12" wide Single Locker		
S16S	Shelf for 16" wide Single Locker		
S24D	Shelf for 24" wide Double Locker		
S30D	Shelf for 30" wide Double Locker		
S36D	Shelf for 36" wide Double Locker		
S48Q	Shelf for 48" wide Quad Locker		

SAMPLE ORDER CODE

UWKA S12S	16	ZA
------------------	-----------	-----------

STYLE

PRICING

Hook	25		
	Source Laminate	Flintwood	Natural Veneer
Single Locker	56	134	145
Double & Quad Locker	67	227	234

S O K L

Set of Keys Alike

WHAT'S INCLUDED

Each set of cores include a lock & core and 2 identical keys.

NOTES

All storage furniture is shipped with the lock housing pre-installed in each unit ready to receive the required lock plug cores. Based on the product option, lock cores and keys are shipped either numbered randomly or in "keyed-alike" sets. Quantity of lock cores and keys will match the quantities required for the locking components on the order.

SPECIFICATION NOTES

Count the number of locking components in each workstation. Enter the number of locks into the Quantity column, and then assign a SET to each quantity.

Office Number	Quantity	Set #	Set Total
T1	4	SOKL - 4	1
T2	2	SOKL - 2	1
T3	4	SOKL - 4	1
T4	3	SOKL - 3	1

Total the number of SOKL (Sets of Keys Alike) quantities and transfer each total quantity to your Purchase Order.

Sets ordered in the incorrect quantities that are required for the order may result in the order being placed on hold.

Please verify the quantity by reviewing the plan carefully to ensure that all products with locks have been identified. Remember that some products may have more than one lock core per unit based on size and configuration.

For further details on how to specify locks, please see the Teknion Lock Specification Guide on our website.

PRODUCT OPTIONS

Number of Sets of Cores			
01 1 Set of Cores	07 7 Sets of Cores	13 13 Sets of Cores	19 19 Sets of Cores
02 2 Sets of Cores	08 8 Sets of Cores	14 14 Sets of Cores	20 20 Sets of Cores
03 3 Sets of Cores	09 9 Sets of Cores	15 15 Sets of Cores	
04 4 Sets of Cores	10 10 Sets of Cores	16 16 Sets of Cores	
05 5 Sets of Cores	11 11 Sets of Cores	17 17 Sets of Cores	
06 6 Sets of Cores	12 12 Sets of Cores	18 18 Sets of Cores	

SAMPLE ORDER CODE

SOKL 02

supports

supports product map

UNGEN End Gable

Page 812

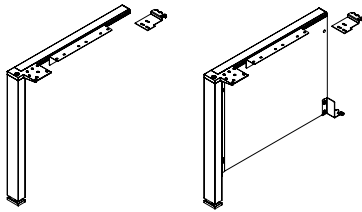

UNGEAN End Gable – Height-Adjustable

Page 813

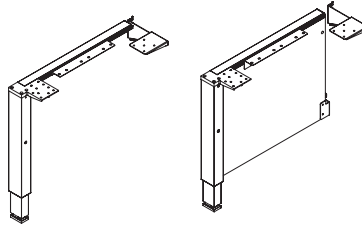

UNGEF Flush End Gable

Page 814

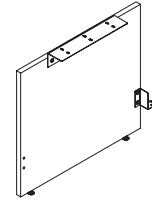

UNGEFA Flush End Gable – Height-Adjustable

Page 815

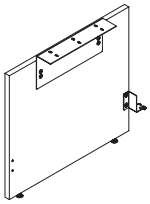

UNGMF Mid Gable

Page 816

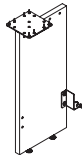

UNGMFA Mid Gable – Height-Adjustable

Page 817

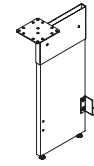

UNLVR Cantilever

Page 818

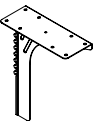

UNLVFN Off-Module Cantilever

Page 819

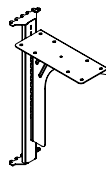

UALVFN Off-Module Cantilever for Panels with Accessory Beam

Page 820

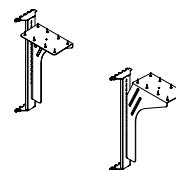

UNGSN Semi-Suspended Gable

Page 821

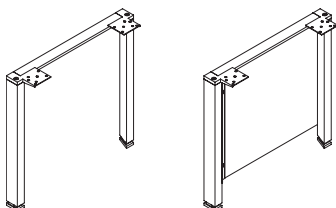

UNGSAN Semi-Suspended Gable – Height-Adjustable

Page 822

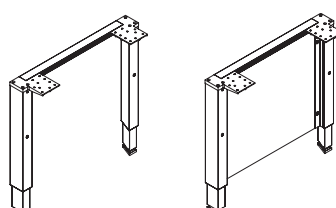

UNLGN Leg – Single

Page 823



supports product map

UNLGA Leg – Height-Adjustable Single

Page 824

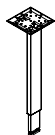

UNLGPN Leg – Pair

Page 825

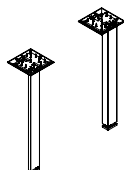

UNLGPA Leg – Height-Adjustable Pair

Page 825

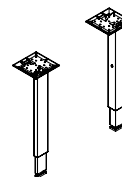

UNBP Worksurface Panel Wall Bracket – Pair

Page 826

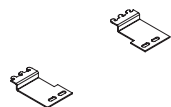

UNBPA Worksurface Panel Wall Bracket – Height-Adjustable

Page 826

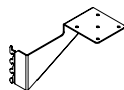

UWSPB Storage-to-Panel Bracket

Page 827

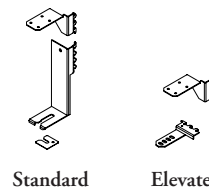

UWBT Worksurface-to-Tower Bracket Kit

Page 828

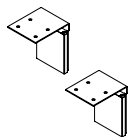

2 Brackets

UWBTH Height-Adjustable Worksurface-to-Tower Bracket Kit

Page 829

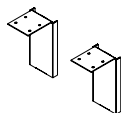

UNCPWN Low Credenza-to-Worksurface Support

Page 831

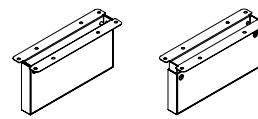

Fixed-Height Height-Adjustable

UWCPWN Reconfigurable Low Credenza-to-Worksurface Support

Page 831

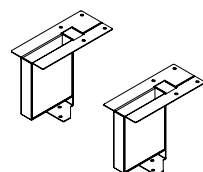

UNRF Flush Plate

Page 832

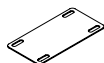

UNRFS Structural Flush Plate

Page 832

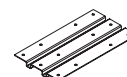

supports product map

UNRC Worksurface Reinforcement Channel

Page 833

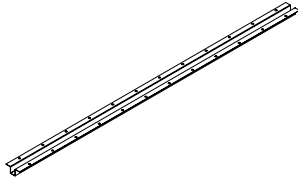

UNCLN Mini Leg

Page 834

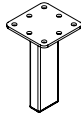

UNOPT Centermount Cabinet Support Posts & Trim

Page 835

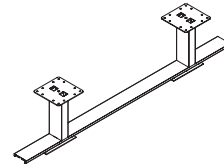

UNOBT Centermount Cabinet Support Brackets & Top Trim

Page 836

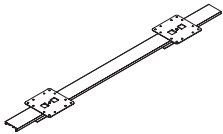

UWSPK Side Filer Support Kit

Page 837

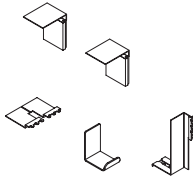

UNGEN End Gable

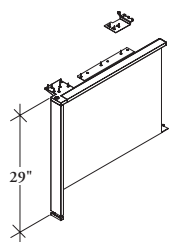

With Infill

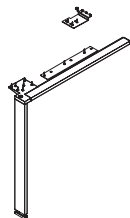

No Infill

The End Gable provides end of run worksurface support. Available open or with infill options.

WHAT'S INCLUDED

1 leg and support with or without infill (as specified), one worksurface support bracket, leveler, attachment hardware.

NOTES

Handedness is determined by the user when seated at the adjoining worksurface (right handed shown).

Height dimension includes worksurface.

Bottom of infill option is 6" above floor level.

Not compatible with 28" Fascia (see Supports section in Application Guide).

Brackets will be finished to match the frame finish. A Platinum paint is applied to brackets when an Anodized frame finish is specified.

PRODUCT OPTIONS

Depth	Orientation	Infill	Infill Finish	Frame Finish
17, 20, 24, 30, 36	L Left Handed R Right Handed (Shown)	0 No Infill 1 With Infill	Source Laminate Flintwood (Standard) Natural Veneer	AC Clear Anodized Foundation Mica

SAMPLE ORDER CODE

UNGEN 30	L	1	FX	AC
-----------------	----------	----------	-----------	-----------

DIMENSIONS INCHES / MM

D
17 / 432
20 / 508
24 / 610
30 / 762
36 / 914

PRICING

NO INFILL (0)	WITH INFILL (1)		
	Source Laminate	Flintwood	Natural Veneer
333	431	625	650
333	431	625	650
340	453	644	671
348	460	689	712
354	477	734	762

A End Gable – Height-Adjustable provides height-adjustable end of run worksurface support available open or with infill option.

WHAT'S INCLUDED

1 leg and support with or without infill (as specified), leveler and attachment hardware, a Worksurface Panel Wall Bracket – Height-Adjustable (UNBPA) with the same left/right orientation as specified on the End Gable.

NOTES

Handedness is determined by the user when seated at the adjoining worksurface (left handed shown).

Height dimension includes thickness of worksurface.

Bottom of infill option is 6" above floor level.

Brackets will be finished to match the frame finish. A Platinum paint is applied to brackets when an Anodized frame finish is specified.

**UNGEAN
End Gable – Height-Adjustable**

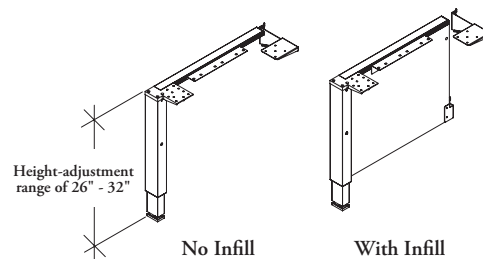

PRODUCT OPTIONS

Depth	Orientation	Infill	Infill Finish	Frame Finish
17, 20, 24, 30, 36	L Left Handed (Shown) R Right Handed	0 No Infill 1 With Infill	Source Laminate Flintwood (Standard) Natural Veneer	AC Clear Anodized Foundation Mica

SAMPLE ORDER CODE

UNGEAN 30	L	1	FX	AC
------------------	----------	----------	-----------	-----------

**DIMENSIONS
INCHES / MM**

D
17 / 432
20 / 508
24 / 610
30 / 762
36 / 914

PRICING

NO INFILL (0)	WITH INFILL (1)		
	Source Laminate	Flintwood	Natural Veneer
497	593	786	811
497	593	786	811
502	613	807	834
508	623	850	874
517	637	895	923

UNGEF Flush End Gable

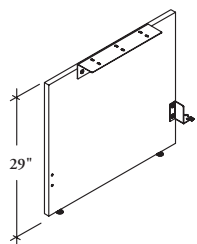

The Flush End Gable provides end of run worksurface support that is flush to the floor.

WHAT'S INCLUDED

Gable, levelers, brackets, attachment hardware.

WHAT'S EXCLUDED

Worksurface Panel Wall Bracket (UNBP) must be specified separately. Can be found in this section.

NOTES

Height dimension includes thickness of worksurface.

Not compatible with 28" Fascia (see *Supports* section in Application Guide).

PRODUCT OPTIONS

Depth	Gable Finish	Bracket Finish
17, 20, 24, 30, 36	Source Laminate Flintwood (Standard) Natural Veneer	Foundation Mica

SAMPLE ORDER CODE

UNGEF 20	FN	7
----------	----	---

DIMENSIONS INCHES / MM

D
17 / 432
20 / 508
24 / 610
30 / 762
36 / 914

PRICING

Source Laminate	Flintwood	Natural Veneer
274	537	560
274	537	560
348	637	664
404	727	745
420	763	786

The Flush End Gable – Height-Adjustable provides height-adjustable end of run worksurface support that is flush to the floor.

WHAT'S INCLUDED

Gable, levelers, brackets, attachment hardware.

WHAT'S EXCLUDED

Worksurface Panel Wall Bracket – Height-Adjustable (UNBPA) must be specified separately and can be found on in this section.

NOTES

Height dimension includes thickness of worksurface.

Not compatible with 28" Fascia (see Supports section in Application Guide).

UNGEFA
Flush End Gable –
Height-Adjustable

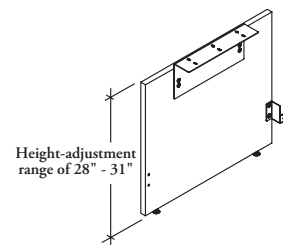

PRODUCT OPTIONS

Depth	Gable Finish	Bracket Finish
17, 20, 24, 30, 36	Source Laminate Flintwood (Standard) Natural Veneer	Foundation Mica

SAMPLE ORDER CODE

UNGEFA 20	FN	7
------------------	-----------	----------

DIMENSIONS
INCHES / MM

D
17 / 432
20 / 508
24 / 610
30 / 762
36 / 914

PRICING

Source Laminate	Flintwood	Natural Veneer
344	609	632
344	609	632
417	709	735
476	798	817
492	835	858

UNGMF Mid Gable

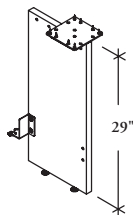

The Mid Gable provides mid-span support to panel wall mounted worksurface.

WHAT'S INCLUDED

Mid gable, levelers, brackets, attachment hardware.

NOTES

Height dimension includes thickness of worksurface.

Cannot attach to flush panel with 28" Fascia (see Supports section in Application Guide).

PRODUCT OPTIONS

Depth	Gable Finish	Bracket Finish
12, 18	Source Laminate Flintwood (Standard) Natural Veneer	Foundation Mica

SAMPLE ORDER CODE

UNGMF 12	VB	P
----------	----	---

DIMENSIONS INCHES / MM

D
12 / 305
18 / 457

PRICING

Source Laminate	Flintwood	Natural Veneer
234	436	450
341	594	615

The Mid Gable – Height-Adjustable provides mid-span height-adjustable support to panel wall mounted to worksurface.

WHAT'S INCLUDED

Mid gable, levelers, brackets, attachment hardware.

NOTES

Height dimension includes thickness of worksurface.

Cannot attach to flush panel with 28" Fascia (see Supports section in Application Guide).

UNGMFA
Mid Gable – Height-Adjustable

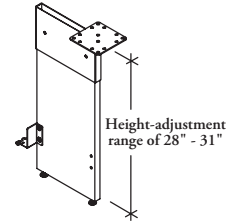

PRODUCT OPTIONS

Depth	Gable Finish	Bracket Finish
12, 18	Source Laminate Flintwood (Standard) Natural Veneer	Foundation Mica

SAMPLE ORDER CODE

UNGMFA 12	VB	P
------------------	-----------	----------

**DIMENSIONS
INCHES / MM**

D
12 / 305
18 / 457

PRICING

Source Laminate	Flintwood	Natural Veneer
306	506	521
412	665	688

UNLVR Cantilever

The Cantilever is applied on-module to a panel wall frame to support worksurfaces.

WHAT'S INCLUDED

1 cantilever.

NOTES

Handedness is determined by the user when seated at the adjoining worksurface (right handed shown).

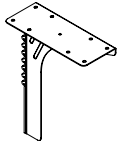

PRODUCT OPTIONS

Depth	Orientation	Finish
11, 14	L Left Handed R Right Handed (Shown)	Foundation Mica

SAMPLE ORDER CODE

UNLVR 14	L	7
----------	---	---

DIMENSIONS INCHES / MM

D
11 / 279
14 / 356

PRICING

97
97

The Off-Module Cantilever is applied off-module to a panel wall frame to support worksurfaces.

WHAT'S INCLUDED

1 cantilever, 1 bracket.

NOTES

Not compatible with 28" Fascia (see Supports section in Application Guide).

Handedness is determined by the user when seated at the adjoining worksurface.

**UNLVFN
Off-Module Cantilever**

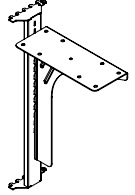

PRODUCT OPTIONS

Depth	Orientation	Finish
11, 14	L Left Handed (Shown) R Right Handed	Foundation Mica

SAMPLE ORDER CODE

UNLVFN 14	R	Q
------------------	----------	----------

**DIMENSIONS
INCHES / MM**

D
11 / 279
14 / 356

PRICING

161
161

U A L V F N Off-Module Cantilever for Panels with Accessory Beam

The Off-Module Cantilever is applied off-module to a panel wall frame to support worksurfaces.

WHAT'S INCLUDED

1 cantilever, 1 bracket.

NOTES

Not compatible with all Fascia (see Supports section in Application Guide).

Handedness is determined by the user when seated at the adjoining worksurface.

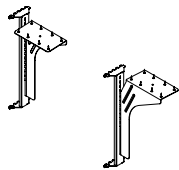

PRODUCT OPTIONS

Depth	Orientation	Finish
11, 14	L Left Handed R Right Handed	Foundation Mica

SAMPLE ORDER CODE

UALVFN 14	L	7
-----------	---	---

DIMENSIONS INCHES / MM

D
11 / 279
14 / 356

PRICING

161
161

The Semi-Suspended Gable supports a worksurface semi-suspended from a panel wall. Available open or with infill panel.

WHAT'S INCLUDED

2 legs and support with or without infill (as specified), levelers, attachment hardware.

NOTES

Height dimension includes thickness of worksurface.

Bottom of infill option is 6" above floor level.

UNGSN
Semi-Suspended Gable

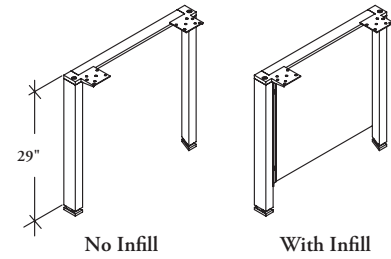

PRODUCT OPTIONS

Depth	Infill	Infill Finish	Frame Finish
20, 24, 30, 36	0 No Infill 1 With Infill	Source Laminate Flintwood (Standard) Natural Veneer	AC Clear Anodized Foundation Mica

SAMPLE ORDER CODE

UNGSN 30	0	VA	AC
-----------------	----------	-----------	-----------

DIMENSIONS
INCHES / MM

D
20 / 508
24 / 610
30 / 762
36 / 914

PRICING

NO INFILL (0)	WITH INFILL (1)		
	Source Laminate	Flintwood	Natural Veneer
436	540	745	778
441	562	769	802
450	588	822	845
457	604	872	893

UNGSAN

Semi-Suspended Gable – Height-Adjustable

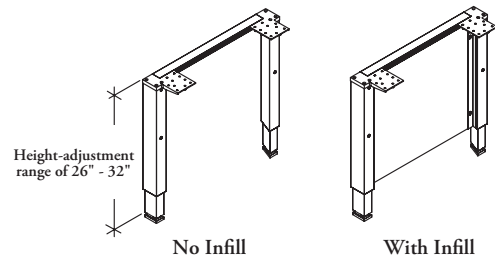

The Semi-Suspended Gable – Height-Adjustable provides height-adjustable support for worksurfaces semi-suspended from a panel wall.

WHAT'S INCLUDED

2 legs and support with or without infill (as specified), levelers, attachment hardware.

NOTES

Height dimension includes thickness of worksurface.

Bottom of infill option is 6" above floor level at worksurface height.

PRODUCT OPTIONS

Depth	Infill	Infill Finish	Frame Finish
20, 24, 30, 36	0 No Infill 1 With Infill	Source Laminate Flintwood (Standard) Natural Veneer	AC Clear Anodized Foundation Mica

SAMPLE ORDER CODE

UNGSAN 24	0	VA	AC
-----------	---	----	----

DIMENSIONS INCHES / MM

D
20 / 508
24 / 610
30 / 762
36 / 914

PRICING

NO INFILL (0)	WITH INFILL (1)		
	Source Laminate	Flintwood	Natural Veneer
720	826	1029	1062
727	847	1053	1088
734	872	1106	1129
741	888	1156	1177

The Single Leg provides Intermediate worksurface support as an alternative to a mid gable or cantilever.

WHAT'S INCLUDED

1 leg, leveler, attachment hardware.

NOTES

Height dimension includes thickness of worksurface.

Handedness is determined by the user when seated at the adjoining worksurface.

**UNLGN
Leg – Single**

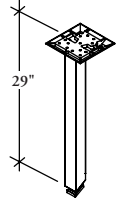

PRODUCT OPTIONS

Orientation	Finish
L Left Handed (Shown) R Right Handed	AC Clear Anodized Foundation Mica

SAMPLE ORDER CODE

UNLGN L	AC
----------------	-----------

PRICING

199

UNLGA

Leg – Height-Adjustable Single

The Height-Adjustable Single Leg provides intermediate height-adjustable worksurface support as an alternative to mid gable or cantilever.

WHAT'S INCLUDED

1 leg, leveler, attachment hardware.

NOTES

Height dimension includes thickness of worksurface.

Handedness is determined by the user when seated at the adjoining worksurface.

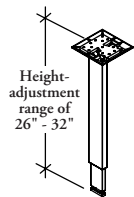

PRODUCT OPTIONS

Orientation	Finish
L Left Handed R Right Handed (Shown)	AC Clear Anodized Foundation Mica

SAMPLE ORDER CODE

UNLGA L	AC
---------	----

PRICING

341

The Leg is used in combination with other storage based supports or legs to create freestanding desks or tables.

WHAT'S INCLUDED

2 legs, levelers, attachment hardware.

NOTES

Height dimension includes thickness of worksurface.

UNLGP N
Leg – Pair

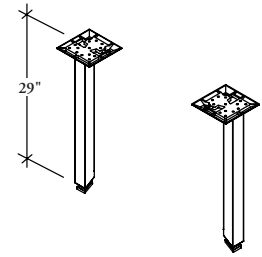

The Height-Adjustable – Leg is used in combination with other legs or storage based supports to create height-adjustable freestanding desks or tables.

WHAT'S INCLUDED

2 legs, levelers, attachment hardware.

NOTES

Height dimension includes thickness of worksurface.

UNLGP A
Height-Adjustable Leg – Pair

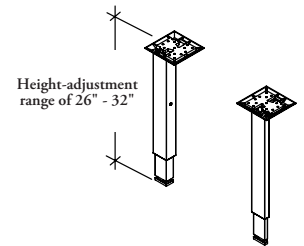

PRODUCT OPTIONS

Finish

AC Clear Anodized

Foundation

Mica

SAMPLE ORDER CODE

UNLGPA AC

UNLGP N
LEG – PAIR

389

UNLGPA
HEIGHT-ADJUSTABLE LEG – PAIR

668

UNBP

Worksurface Panel Wall Bracket – Pair

The Worksurface Panel Wall Bracket connects a worksurface to a panel wall providing support.

WHAT'S INCLUDED

2 brackets (one left oriented, one right oriented).

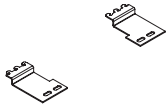

UNBPA

Worksurface Panel Wall Bracket – Height-Adjustable

The Height-Adjustable Worksurface Panel Wall Bracket connects a worksurface vertically to a panel wall providing height-adjustable support.

WHAT'S INCLUDED

1 bracket

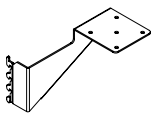

PRODUCT OPTIONS

Orientation (Applies to UNBPA only)	Finish
L Left Handed (Shown)	Foundation Mica
R Right Handed	

SAMPLE ORDER CODE

UNBPA R	E
---------	---

UNBP
WORKSURFACE PANEL WALL BRACKET – PAIR

66

UNBPA
WORKSURFACE PANEL WALL BRACKET –
HEIGHT-ADJUSTABLE

49

The Storage-to-Panel Bracket attaches to the back or side of a storage unit and mounts into the vertical channel of a District panel to provide support to the panel wall.

WHAT'S INCLUDED

1 top bracket, 1 bottom bracket, 1 plate (for some standard configurations) and attachment hardware.

NOTES

A Perpendicular Back (B) application is **not** available with a Wire Gap (W).

Handedness is determined by the side of the panel (when facing it) onto which the storage is mounted.

For details as to which application to choose, please see Planning Basics in the Supports section of the Application Guides chapter.

U W S P B
Storage-to-Panel Bracket



Standard



Elevated

PRODUCT OPTIONS

Storage Style	Application	Gapping	Orientation	Finish
E Elevated	P Parallel	W With Wire Gap	L Left	Foundation
S Standard	F Perpendicular Front B Perpendicular Back	N No Wire Gap	R Right	Mica

SAMPLE ORDER CODE

UWSPB E	P	W	L	Q
----------------	----------	----------	----------	----------

PRICING

127

U W B T

Worksurface-to-Tower Bracket Kit

The Worksurface-to-Tower Bracket is used to attach worksurfaces to storage. It also has an optional bag hook for undersurface organization.

WHAT'S INCLUDED

Brackets, as specified and attachment hardware.

NOTES

The One Bracket, One Flush Plate (BF) style option must be used when attaching to the side of a tower/locker that has a cubby back.

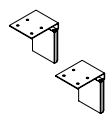

Two Brackets

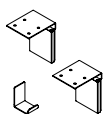

Two Brackets / One Hook

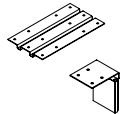

One Bracket / One Flush Plate

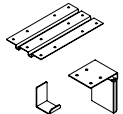

One Bracket / One Flush Plate / One Hook

PRODUCT OPTIONS

Style	Finish
BB Two Brackets	Foundation
HB Two Brackets, One Hook	Mica
BF One Bracket, One Flush Plate	
HF One Bracket, One Flush Plate, 1 Hook	

SAMPLE ORDER CODE

UWBT BB	7
----------------	----------

STYLE

BB
HB
BF
HF

PRICING

193
193
171
171

The Height-Adjustable Worksurface-to-Tower Bracket is used to attach worksurfaces to storage.

WHAT'S INCLUDED

2 brackets and attachment hardware.

NOTES

Cannot be used on a Pedestal Tower with Cubby Back (UTDC).

U W B T H
Height-Adjustable
Worksurface-to-Tower Bracket Kit

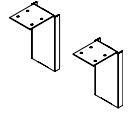

PRODUCT OPTIONS

Style	Finish
BB 2 Brackets	Foundation Mica

SAMPLE ORDER CODE

UWBTH BB	7
-----------------	----------

STYLE	PRICING
BB	287

UNCPWN Low Credenza-to-Worksurface Support

The Low Credenza-to-Worksurface Support mounts to the underside of a worksurface and to the top of a low credenza to provide support for the worksurface.

WHAT'S INCLUDED

Brackets, as specified and attachment hardware.

NOTES

Adjustment range is +3"/-1" (28" - 32" worksurface height).

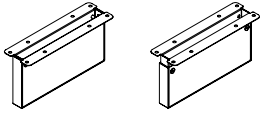

Fixed-Height Height-Adjustable

PRODUCT OPTIONS

Style	Finish
F Fixed-Height	Foundation Mica
H Height-Adjustable	

SAMPLE ORDER CODE

UNCPWN F	7
----------	---

STYLE

F
H

PRICING

185
212

The Reconfigurable Low Credenza-to-Worksurface Support mounts to the underside of a worksurface and wraps into the open section of a credenza so that screws are affixed to the interior of the credenza. This allows for reconfiguration without damaging the top of storage unit.

WHAT'S INCLUDED

2 brackets and attachment hardware.

NOTES

The depth of the worksurface **cannot** be more than 6" than the open section of the credenza onto which it is being mounted. (i.e., 24" depth worksurface **cannot** be mounted to a 36" wide open cubby.)

U W C P W N
Reconfigurable
Low Credenza-to-Worksurface
Support

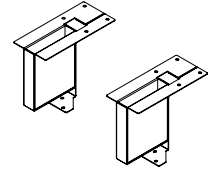

PRODUCT OPTIONS

Style	Finish
F Fixed-Height	Foundation Mica

SAMPLE ORDER CODE

UWCPWN F	7
----------	---

STYLE	PRICING
F	278

UNRF Flush Plate

The Flush Plate is used in conjunction with other supports to maintain alignment of worksurfaces.

WHAT'S INCLUDED

1 flush plate, attachment hardware.

NOTES

Finished in Ebony.

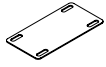

PRICING

43

UNRFS Structural Flush Plate

The Structural Flush Plate is used in conjunction with other supports to maintain and provide structural support to freestanding worksurfaces.

WHAT'S INCLUDED

1 bracket.

NOTES

Finished in Ebony.

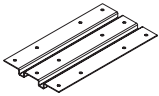

PRICING

56

The Worksurface Reinforcement Channel adds rigidity to worksurfaces.

UNRC

WHAT'S INCLUDED

1 reinforced channel, attachment hardware.

Worksurface Reinforcement Channel

NOTES

Finished in Ebony.

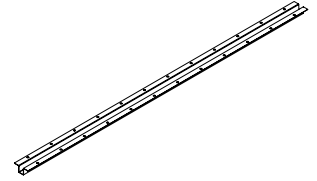

PRODUCT OPTIONS

Width (6" increments)
36 - 96

SAMPLE ORDER CODE

UNRC 60

**DIMENSIONS
INCHES / MM**

PRICING

W	
36 / 914	27
42 / 1067	29
48 / 1219	30
54 / 1372	34
60 / 1524	36
66 / 1676	41
72 / 1829	43
78 / 1981	45
84 / 2134	48
90 / 2286	50
96 / 2438	53

UNCLN

Mini Leg

The Mini Leg is used in place of the Low Credenza Worksurface Support (UNCPWN) when panel wall support is not required.

WHAT'S INCLUDED

1 mini leg, attachment hardware.

NOTES

Rests on, but does not attach to storage.

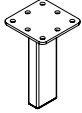

PRODUCT OPTIONS

Finish

Foundation

Mica

SAMPLE ORDER CODE

UNCLN 7

PRICING

51

The Centermount Cabinet Support Posts & Trim provides elevated support for centermount cabinets and overhead cabinets centered on District Panel Walls.

WHAT'S INCLUDED

Support posts, top trim, attachment hardware, gasket.

WHAT'S EXCLUDED

Centermount Cabinet and Overhead Cabinet specified separately.

NOTES

Post finish matches top trim finish selection. Anodized defaults to Platinum for bracket finish.

To match District datum heights:

On 42" panel: use 9" post and 15" cabinet for 66" datum.

On 29" panel: use 13" post and 9" cabinet for 51" datum.

Compatible Trim widths;

For 15" high cabinet: 30, 36, 42, 48

For 9" high cabinet: 30, 36, 42, 48, 54, 60

UNOPT
Centermount Cabinet Support Posts & Trim

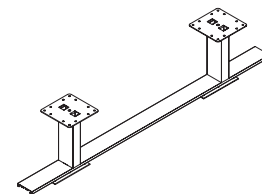

PRODUCT OPTIONS

Post Height	Top Trim Width	Top Trim Finish
09, 13	30, 36, 42, 48, 54, 60	AC Clear Anodized Foundation Mica

SAMPLE ORDER CODE

UNOPT 9	48	AC
----------------	-----------	-----------

DIMENSIONS
INCHES / MM

H	W
9 / 229	30 / 762
9 / 229	36 / 914
9 / 229	42 / 1067
9 / 229	48 / 1219
9 / 229	54 / 1372
9 / 229	60 / 1524
13 / 330	30 / 762
13 / 330	36 / 914
13 / 330	42 / 1067
13 / 330	48 / 1219
13 / 330	54 / 1372
13 / 330	60 / 1524

PRICING

437
449
456
462
472
479
462
474
482
487
499
503

UNOBT Centermount Cabinet Support Brackets & Trim

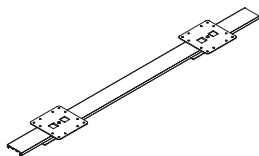

The Centermount Cabinet Support Brackets & Trim provides flush mounted support for centermount cabinets and District overhead cabinets centered on District Panel Walls.

WHAT'S INCLUDED

Top trim, supports, attachment hardware, gasket

WHAT'S EXCLUDED

Centermount Cabinet and Overhead Cabinet specified separately.

NOTES

Post finish matches top trim finish selection. Anodized defaults to Platinum for bracket finish.

Top trim width equals to cabinet width specified.

Compatible Trim widths;

For 15" high cabinet: 30", 36", 42", 48"

For 9" high cabinet: 30" to 96" in 6" increments

PRODUCT OPTIONS

Top Trim Width (6" increments)	Top Trim Finish
30 - 96	AC Clear Anodized Foundation Mica

SAMPLE ORDER CODE

UNOBT 30	AC
----------	----

DIMENSIONS INCHES / MM

W
30 / 762
36 / 914
42 / 1067
48 / 1219
54 / 1372
60 / 1524
66 / 1676
72 / 1829
78 / 1981
84 / 2134
90 / 2286
96 / 2438

PRICING

279
287
298
304
312
319
484
493
502
506
517
522

The Side Filer Support Kit is used to connect Side Filer to a panel and provide enhanced stability in side filer-to-panel applications.

WHAT'S INCLUDED

2 Worksurface to Tower Brackets (UWBTBB), 1 pair of Worksurface Panel Wall Brackets (UNBP), 1 storage bottom bracket, 1 anti-dislodgement plate for storage bottom bracket, 1 bag hook (if specified), attachment hardware

U W S P K
Side Filer Support Kit

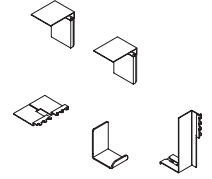

PRODUCT OPTIONS

Application	Orientation	Finish	Hook
S Side Filer (3/8" gap)	L Left	Foundation	N No
M Mini Side Filer (1" gap)	R Right	Mica	Y Yes

SAMPLE ORDER CODE

UWSPK S	L	Q	N
----------------	----------	----------	----------

PRICING

169

accessories

accessories product map

UNPSF Standing Storage Fascia

Page 842

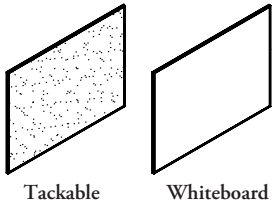

UNPSS Stacking Storage Fascia

Page 846

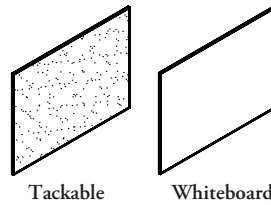

UNTBS Tackboard – Screen Mount

Page 850

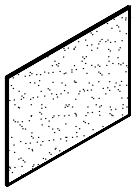

UNTBW Whiteboard – Screen Mount

Page 852

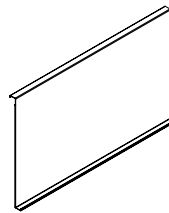

UNTBP Tackboard – Panel Wall Mount

Page 854

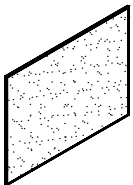

UKSCIS Single Locker with Cubby Infill

Page 856



UTLXIS Lateral Tower Infill

Page 858

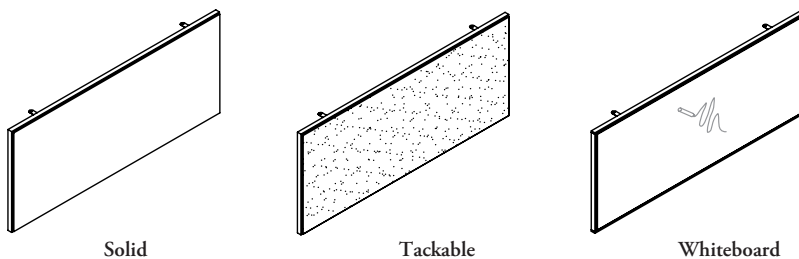

accessories product map

UTCXIS Combo Tower Infill

Page 860

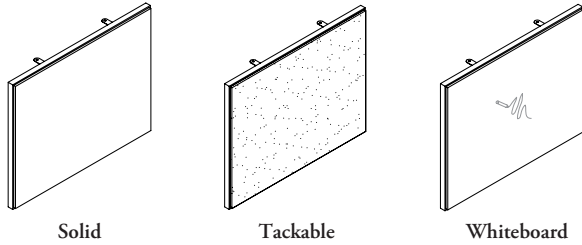

UTCXIX Source Laminate Combo Tower Infill

Page 864

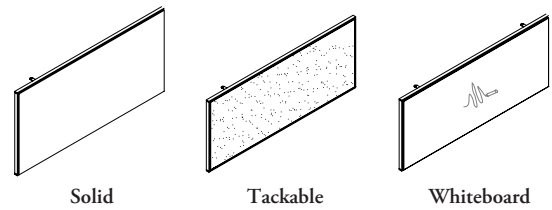

UTDCIS Pedestal Tower with Cubby Infill

Page 867

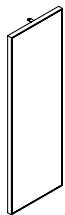

UWLC Seat Cushion

Page 868

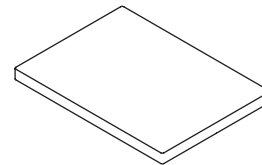

UWLF Fitted Seat Cushion

Page 869

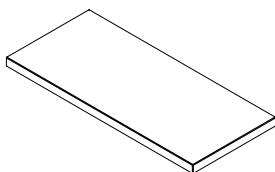

UNTK Tool Kit

Page 870



UNAB Accessory Bundle

Page 871

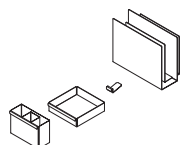

UNBW Side Filer Boot Tray

Page 872

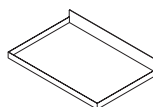

UNPSF

Standing Storage Fascia

The Standing Storage Fascia is a framed tackable fabric or whiteboard surface which mounts to storage units that are freestanding and not stacked onto other storage units.

WHAT'S INCLUDED

1 framed fascia and attachment hardware.

NOTES

Not all height/width combinations are available. Please see pricing for exact offering.

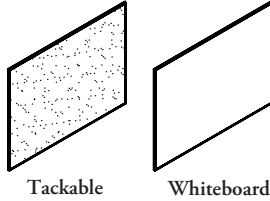

PRODUCT OPTIONS

Fascia Style	Height (1" increments)	Width (1" increments)	Frame Finish	Mounting Bracket Finish	Fascia Finish
T Tackable Fabric (Standard Mount)	12 - 60	12 - 48	AC Clear Anodized	Foundation	Standard Panel Fabric
A Tackable Fabric (Slot Mount)			BP Espresso Painted	Mica	
W Whiteboard (Standard Mount)			BH Storm White Painted		
I Whiteboard (Slot Mount)					

SAMPLE ORDER CODE

UNPSF T	45	16	AC	E	L341
----------------	-----------	-----------	-----------	----------	-------------

**DIMENSIONS
FOR MM X BY 25.4**

H	W
12 - 17	12 - 17
12 - 17	18 - 23
12 - 17	24 - 29
12 - 17	30 - 35
12 - 17	36 - 41
12 - 17	42 - 47
12 - 17	48
18 - 23	12 - 17
18 - 23	18 - 23
18 - 23	24 - 29
18 - 23	30 - 35
18 - 23	36 - 41
18 - 23	42 - 47
18 - 23	48
24 - 29	12 - 17
24 - 29	18 - 23
24 - 29	24 - 29
24 - 29	30 - 35
24 - 29	36 - 41
24 - 29	42 - 47
24 - 29	48

PRICING

TACKABLE FABRIC									
Standard Panel Fabric									
A/COM	Gr. 1	Gr. 2	Gr. 3	Gr. 4	Gr. 5	Gr. 6	Gr. 7		
256	266	278	286	299	311	324	337		
278	287	300	312	326	338	352	364		
300	312	325	337	352	364	379	395		
325	337	352	363	378	393	409	428		
351	363	378	393	410	426	441	460		
378	392	408	426	442	459	479	499		
408	424	439	459	479	497	517	537		
277	286	299	309	322	334	351	362		
300	312	325	337	352	364	379	395		
325	337	352	363	378	393	409	428		
351	363	378	393	410	426	441	460		
378	392	408	426	442	459	479	499		
408	424	439	459	479	497	517	537		
439	457	477	497	517	536	558	580		
299	309	324	334	348	362	377	392		
325	337	352	363	378	393	409	428		
351	363	378	393	410	426	441	460		
378	392	408	426	442	459	479	499		
408	424	439	459	479	497	517	537		
439	457	477	497	517	536	558	580		
477	496	515	535	557	579	602	625		

Pricing is continued on the following page.

UNPSF
Standing Storage Fascia
(Continued)

DIMENSIONS
FOR MM X BY 25.4

PRICING

		TACKABLE FABRIC							
		Standard Panel Fabric							
H	W	A/COM	Gr. 1	Gr. 2	Gr. 3	Gr. 4	Gr. 5	Gr. 6	Gr. 7
30 - 35	12 - 17	328	333	348	361	376	389	405	423
30 - 35	18 - 23	356	370	385	401	416	433	451	469
30 - 35	24 - 29	385	401	416	432	450	468	485	505
30 - 35	30 - 35	414	432	450	468	487	505	526	545
30 - 35	36 - 41	450	464	484	504	525	544	565	590
30 - 35	42 - 47	484	503	525	543	566	590	612	636
30 - 35	48	523	543	564	588	612	636	661	688
36 - 41	12 - 17	361	366	380	397	413	430	448	462
36 - 41	18 - 23	392	408	424	439	458	477	497	517
36 - 41	24 - 29	424	439	457	477	496	515	536	558
36 - 41	30 - 35	457	476	496	515	536	557	579	602
36 - 41	36 - 41	493	514	534	556	579	601	624	650
36 - 41	42 - 47	534	556	576	601	625	649	674	700
36 - 41	48	576	599	623	646	672	699	729	758
42 - 47	12 - 17	397	404	418	436	455	472	488	509
42 - 47	18 - 23	431	449	464	484	505	525	544	565
42 - 47	24 - 29	463	484	503	523	543	564	588	612
42 - 47	30 - 35	503	523	542	564	587	611	635	660
42 - 47	36 - 41	542	563	586	610	635	659	687	713
42 - 47	42 - 47	585	610	634	659	686	713	741	770
42 - 47	48	633	658	684	712	741	770	801	834
48 - 53	12 - 17	436	443	461	481	501	519	539	561
48 - 53	18 - 23	476	493	514	534	556	578	601	624
48 - 53	24 - 29	512	534	554	576	599	623	649	674
48 - 53	30 - 35	554	574	599	621	646	672	699	729
48 - 53	36 - 41	596	621	645	671	699	727	756	785
48 - 53	42 - 47	645	671	697	723	753	784	816	848
48 - 53	48	696	722	755	783	814	847	880	915
54 - 60	12 - 17	481	486	506	527	550	572	594	615
54 - 60	18 - 23	522	540	563	586	610	634	659	687
54 - 60	24 - 29	562	585	609	634	659	684	712	740
54 - 60	30 - 35	609	633	658	683	710	738	769	801
54 - 60	36 - 41	657	682	711	738	768	799	829	864
54 - 60	42 - 47	709	737	767	798	832	863	897	933
54 - 60	48	766	797	828	862	896	931	969	1010

Pricing is continued on the following page.

UNPSF

Standing Storage Fascia (Continued)

DIMENSIONS FOR MM X BY 25.4

PRICING

		WHITEBOARD
H	W	
12 - 17	12 - 17	385
12 - 17	18 - 23	416
12 - 17	24 - 29	451
12 - 17	30 - 35	486
12 - 17	36 - 41	527
12 - 17	42 - 47	570
12 - 17	48 - 53	615
12 - 17	54 - 59	666
12 - 17	60	720
18 - 23	12 - 17	429
18 - 23	18 - 23	461
18 - 23	24 - 29	500
18 - 23	30 - 35	538
18 - 23	36 - 41	581
18 - 23	42 - 47	633
18 - 23	48 - 53	681
18 - 23	54 - 59	736
18 - 23	60	797
24 - 29	12 - 17	476
24 - 29	18 - 23	512
24 - 29	24 - 29	553
24 - 29	30 - 35	594
24 - 29	36 - 41	640
24 - 29	42 - 47	731
24 - 29	48 - 53	826
24 - 29	54 - 59	892
24 - 29	60	964
30 - 35	12 - 17	517
30 - 35	18 - 23	557
30 - 35	24 - 29	601
30 - 35	30 - 35	646
30 - 35	36 - 41	697
30 - 35	42 - 47	780
30 - 35	48 - 53	845
30 - 35	54 - 59	939
30 - 35	60	1042
36 - 41	12 - 17	557
36 - 41	18 - 23	601
36 - 41	24 - 29	646
36 - 41	30 - 35	697
36 - 41	36 - 41	755
36 - 41	42 - 47	828
36 - 41	48 - 53	864
36 - 41	54 - 59	959
36 - 41	60	1065

DIMENSIONS FOR MM X BY 25.4

PRICING

		WHITEBOARD
H	W	
42 - 47	12 - 17	599
42 - 47	18 - 23	646
42 - 47	24 - 29	699
42 - 47	30 - 35	757
42 - 47	36 - 41	840
42 - 47	42 - 47	935
42 - 47	48 - 53	1037
42 - 47	54 - 59	1151
42 - 47	60	1281
48	12 - 17	640
48	18 - 23	694
48	24 - 29	748
48	30 - 35	811
48	36 - 41	900
48	42 - 47	1000
48	48 - 53	1109
48	54 - 59	1235
48	60	1371
49 - 53	12 - 17	640
49 - 53	18 - 23	694
49 - 53	24 - 29	748
49 - 53	30 - 35	811
49 - 53	36 - 41	900
49 - 53	42 - 47	1000
49 - 53	48 - 53	1109
49 - 53	54 - 59	1235
49 - 53	60	1371
54 - 60	12 - 17	683
54 - 60	18 - 23	738
54 - 60	24 - 29	799
54 - 60	30 - 35	863
54 - 60	36 - 41	957
54 - 60	42 - 47	1064
54 - 60	48 - 53	1180
54 - 60	54 - 59	1312
54 - 60	60	1457

UNPSS

Stacking Storage Fascia

The Stacking Storage Fascia is a framed tackable fabric or whiteboard surface which mounts onto stacking storage cabinets.

WHAT'S INCLUDED

1 framed fascia and attachment hardware.

NOTES

Fabric grades 5, 6 and 7 can be specified to a maximum width of 60".

Architectural fabric can be specified to a maximum width of 48".

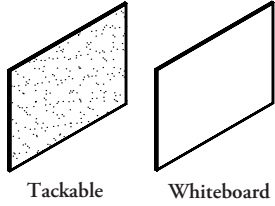

PRODUCT OPTIONS

Fascia Style	Height (1" increments)	Width (6" increments)	Frame Finish	Mounting Bracket Finish	Fascia Finish
T Tackable Fabric (Standard Mount)	12 - 45	24 - 96	AC Clear Anodized	E Ebony	Standard Panel Fabric
W Whiteboard (Standard Mount)			BP Espresso Painted		
			BH Storm White Painted		

SAMPLE ORDER CODE

UNPSS T	45	16	AC	E	L341
---------	----	----	----	---	------

DIMENSIONS
FOR MM X BY 25.4

H	W
12 - 17	24
12 - 17	30
12 - 17	36
12 - 17	42
12 - 17	48
12 - 17	54
12 - 17	60
12 - 17	66
12 - 17	72
12 - 17	78
12 - 17	84
12 - 17	90
12 - 17	96
18 - 23	24
18 - 23	30
18 - 23	36
18 - 23	42
18 - 23	48
18 - 23	54
18 - 23	60
18 - 23	66
18 - 23	72
18 - 23	78
18 - 23	84
18 - 23	90
18 - 23	96

PRICING

TACKABLE FABRIC									
Standard Panel Fabric									
A/COM	Gr. 1	Gr. 2	Gr. 3	Gr. 4	Gr. 5	Gr. 6	Gr. 7		
300	312	325	337	352	364	379	395		
325	337	352	363	378	393	409	428		
351	363	378	393	410	426	441	460		
378	392	408	426	442	459	479	499		
408	424	439	459	479	497	517	537		
439	457	477	497	517	536	558	580		
477	496	515	535	557	579	602	625		
514	535	557	578	599	n/a	n/a	n/a		
556	578	601	624	646	n/a	n/a	n/a		
599	623	649	674	700	n/a	n/a	n/a		
646	672	699	729	756	n/a	n/a	n/a		
699	727	757	785	814	n/a	n/a	n/a		
756	784	816	848	882	n/a	n/a	n/a		
325	337	352	363	378	393	409	428		
351	363	378	393	410	426	441	460		
378	392	408	426	442	459	479	499		
408	424	439	459	479	497	517	537		
439	457	477	497	517	536	558	580		
477	496	515	535	557	579	602	625		
514	535	557	578	601	625	650	675		
556	578	601	624	646	n/a	n/a	n/a		
599	623	649	674	700	n/a	n/a	n/a		
646	672	699	729	756	n/a	n/a	n/a		
699	727	757	785	814	n/a	n/a	n/a		
756	784	816	848	882	n/a	n/a	n/a		
813	847	880	916	949	n/a	n/a	n/a		

Pricing is continued on the following page.

UNPSS

Stacking Storage Fascia (Continued)

DIMENSIONS FOR MM X BY 25.4

PRICING

DIMENSIONS FOR MM X BY 25.4		TACKABLE FABRIC							
		Standard Panel Fabric							
H	W	A/COM	Gr. 1	Gr. 2	Gr. 3	Gr. 4	Gr. 5	Gr. 6	Gr. 7
24 - 29	24	351	363	378	393	410	426	441	460
24 - 29	30	378	392	408	426	442	459	479	499
24 - 29	36	408	424	439	459	479	497	517	537
24 - 29	42	439	457	477	497	517	536	558	580
24 - 29	48	477	496	515	535	557	579	602	625
24 - 29	54	514	535	557	578	601	625	650	675
24 - 29	60	556	578	601	624	649	675	702	731
24 - 29	66	599	623	649	674	700	n/a	n/a	n/a
24 - 29	72	646	672	699	729	756	n/a	n/a	n/a
24 - 29	78	699	727	757	785	814	n/a	n/a	n/a
24 - 29	84	756	784	816	848	882	n/a	n/a	n/a
24 - 29	90	813	847	880	916	949	n/a	n/a	n/a
24 - 29	96	879	915	951	988	1025	n/a	n/a	n/a
30 - 35	24	385	401	416	432	450	468	485	505
30 - 35	30	414	432	450	468	487	505	526	545
30 - 35	36	450	464	484	504	525	544	565	590
30 - 35	42	484	503	525	543	566	590	612	636
30 - 35	48	523	543	564	588	612	636	661	688
30 - 35	54	564	586	611	635	661	688	715	742
30 - 35	60	610	634	659	687	715	741	771	803
30 - 35	66	659	684	712	740	768	n/a	n/a	n/a
30 - 35	72	712	740	769	801	832	n/a	n/a	n/a
30 - 35	78	769	799	831	864	895	n/a	n/a	n/a
30 - 35	84	829	863	897	935	970	n/a	n/a	n/a
30 - 35	90	897	933	969	1010	1047	n/a	n/a	n/a
30 - 35	96	967	1007	1048	1090	1131	n/a	n/a	n/a
36 - 41	24	424	439	457	477	496	515	536	558
36 - 41	30	457	476	496	515	536	557	579	602
36 - 41	36	493	514	534	556	579	601	624	650
36 - 41	42	534	556	576	601	625	649	674	700
36 - 41	48	576	599	623	646	672	699	729	758
36 - 41	54	621	646	672	699	727	757	785	817
36 - 41	60	671	697	727	756	786	816	848	884
36 - 41	66	723	755	783	816	846	n/a	n/a	n/a
36 - 41	72	783	813	847	879	913	n/a	n/a	n/a
36 - 41	78	846	878	914	950	987	n/a	n/a	n/a
36 - 41	84	912	949	987	1025	1064	n/a	n/a	n/a
36 - 41	90	986	1024	1065	1107	1148	n/a	n/a	n/a
36 - 41	96	1064	1106	1149	1196	1241	n/a	n/a	n/a
42 - 45	24	463	484	503	523	543	564	588	612
42 - 45	30	503	523	542	564	587	611	635	660
42 - 45	36	542	563	586	610	635	659	687	713
42 - 45	42	585	610	634	659	686	713	741	770
42 - 45	48	633	658	684	712	741	770	801	834
42 - 45	54	683	711	738	769	801	831	864	899
42 - 45	60	737	767	799	829	863	898	935	972
42 - 45	66	798	828	863	897	933	n/a	n/a	n/a
42 - 45	72	862	895	931	967	1002	n/a	n/a	n/a
42 - 45	78	930	966	1005	1048	1089	n/a	n/a	n/a
42 - 45	84	1002	1047	1088	1131	1172	n/a	n/a	n/a
42 - 45	90	1087	1128	1173	1218	1262	n/a	n/a	n/a
42 - 45	96	1171	1217	1266	1318	1368	n/a	n/a	n/a

Pricing is continued on the following page.

UNPSS

**Stacking Storage Fascia
(Continued)**

**DIMENSIONS
FOR MM X BY 25.4**

PRICING

H	W	WHITEBOARD
15 - 17	24	451
15 - 17	30	486
15 - 17	36	527
15 - 17	42	570
15 - 17	48	615
15 - 17	54	666
15 - 17	60	720
18 - 23	24	500
18 - 23	30	538
18 - 23	36	581
18 - 23	42	633
18 - 23	48	681
18 - 23	54	736
18 - 23	60	797
24 - 29	24	553
24 - 29	30	594
24 - 29	36	640
24 - 29	42	731
24 - 29	48	826
24 - 29	54	892
24 - 29	60	964
30 - 35	24	601
30 - 35	30	646
30 - 35	36	697
30 - 35	42	780
30 - 35	48	845
30 - 35	54	939
30 - 35	60	1042
36 - 41	24	646
36 - 41	30	697
36 - 41	36	755
36 - 41	42	828
36 - 41	48	864
36 - 41	54	959
36 - 41	60	1065
42 - 45	24	699
42 - 45	30	757
42 - 45	36	840
42 - 45	42	935
42 - 45	48	1037
42 - 45	54	1151
42 - 45	60	1281

UNTBS

Tackboard – Screen Mount

The Tackboard – Screen Mount is a framed firm tackable fabric which mounts to desk edge storage and floor screens.

WHAT'S INCLUDED

1 tackboard, attachment hardware.

NOTES

Actual height is 1" less than nominal to provide clearance with worksurface for cable management.

22" height is available up to a 48" width only.

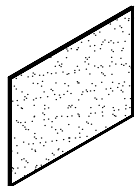

PRODUCT OPTIONS

Height	Width (1" increments)	Upholstery	Frame Finish	Mounting Bracket Finish
13, 22	23 - 96	Panel Fabric	AC Clear Anodized BP Espresso Painted BH Storm White Painted	Foundation Mica

SAMPLE ORDER CODE

UNTBS 13	60	L341	AC	7
-----------------	-----------	-------------	-----------	----------

**DIMENSIONS
FOR MM X BY 25.4**

H	W
13	23 - 24
13	25 - 27
13	28 - 30
13	31 - 33
13	34 - 36
13	37 - 39
13	40 - 42
13	43 - 45
13	46 - 48
13	49 - 51
13	52 - 54
13	55 - 57
13	58 - 60
13	61 - 63
13	64 - 66
13	67 - 69
13	70 - 72
13	73 - 75
13	76 - 78
13	79 - 81
13	82 - 84
13	85 - 87
13	88 - 90
13	91 - 93
13	94 - 96

PRICING

Standard Panel Fabric									
A/COM	Gr. 1	Gr. 2	Gr. 3	Gr. 4	Gr. 5	Gr. 6	Gr. 7		
200	205	214	221	229	238	248	253		
207	212	222	227	235	248	256	260		
212	220	227	234	245	254	261	270		
220	226	234	242	251	260	272	278		
225	232	242	249	258	270	279	283		
233	240	250	257	266	278	286	291		
235	245	253	260	272	285	293	302		
260	271	279	286	298	311	321	327		
288	299	309	322	335	350	361	369		
297	306	318	328	340	356	369	378		
302	311	325	334	348	363	377	387		
307	319	330	342	357	373	385	395		
312	325	337	350	363	379	393	404		
327	338	353	363	379	397	410	420		
341	353	366	379	395	413	429	437		
355	366	382	395	411	431	445	456		
369	380	397	409	427	448	460	474		
385	397	412	428	445	463	480	492		
400	412	429	441	460	482	499	509		
414	430	445	460	480	502	518	532		
431	445	461	479	500	521	537	553		
450	462	481	499	518	540	560	574		
464	481	500	517	539	562	581	595		
484	501	519	537	559	585	604	619		
503	519	538	558	581	607	628	644		

Pricing is continued on the following page.

U N T B S
Tackboard – Screen Mount
(Continued)

DIMENSIONS
FOR MM X BY 25.4

PRICING

H	W	Standard Panel Fabric							
		A/COM	Gr. 1	Gr. 2	Gr. 3	Gr. 4	Gr. 5	Gr. 6	Gr. 7
22	23 - 24	231	236	248	257	270	281	291	302
22	25 - 27	238	248	257	268	280	291	304	312
22	28 - 30	248	256	266	277	288	303	316	325
22	31 - 33	256	263	277	285	299	313	326	333
22	34 - 36	261	272	283	293	307	325	334	344
22	37 - 39	277	283	298	308	324	340	353	361
22	40 - 42	286	298	309	324	338	355	367	378
22	43 - 45	316	328	342	356	374	393	408	418
22	46 - 48	344	357	375	389	409	431	449	460

UNTBW
Whiteboard – Screen Mount

The Whiteboard – Screen Mount is an erasable writing surface which mounts to Desk edge, Storage and Floor Screens.

WHAT'S INCLUDED

1 whiteboard

NOTES

Actual height is 1" less than nominal to provide clearance with worksurface for cable management.

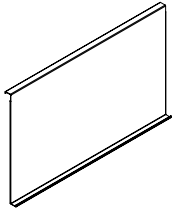

PRODUCT OPTIONS

Height	Width (1" increments)
15, 22	23 - 48

SAMPLE ORDER CODE

UNTBW 15	48
-----------------	-----------

**DIMENSIONS
 FOR MM X BY 25.4**

H	W
15	23 - 24
15	25 - 30
15	31 - 36
15	37 - 42
15	43 - 48

PRICING

155
185
205
221
242

**DIMENSIONS
 FOR MM X BY 25.4**

H	W
22	23 - 24
22	25 - 30
22	31 - 36
22	37 - 42
22	43 - 48

PRICING

185
212
234
256
283

UNTBP

Tackboard – Panel Wall Mount

The Tackboard – Panel Wall Mount is a framed tackable fabric surface which mounts casually to panel walls over existing fascias.

WHAT'S INCLUDED

1 tackboard, attachment hardware.

NOTES

Actual height is 1" less than nominal to provide clearance with worksurface for cable management.

22" and 37" heights are available up to a 48" width only.

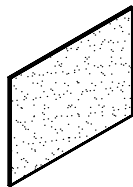

PRODUCT OPTIONS

Height	Width (1" increments)	Upholstery	Frame Finish
13, 22, 37	23 - 96	Panel Fabric	AC Clear Anodized BP Espresso Painted BH Storm White Painted

SAMPLE ORDER CODE

UNTBP 37	48	L341	AC
-----------------	-----------	-------------	-----------

**DIMENSIONS
FOR MM X BY 25.4**

H	W
13	23 - 24
13	25 - 27
13	28 - 30
13	31 - 33
13	34 - 36
13	37 - 39
13	40 - 42
13	43 - 45
13	46 - 48
13	49 - 51
13	52 - 54
13	55 - 57
13	58 - 60
13	61 - 63
13	64 - 66
13	67 - 69
13	70 - 72
13	73 - 75
13	76 - 78
13	79 - 81
13	82 - 84
13	85 - 87
13	88 - 90
13	91 - 93
13	94 - 96

PRICING

Standard Panel Fabric									
A/COM	Gr. 1	Gr. 2	Gr. 3	Gr. 4	Gr. 5	Gr. 6	Gr. 7		
200	205	214	221	229	238	248	253		
207	212	222	227	235	248	256	260		
212	220	227	234	245	254	261	270		
220	226	234	242	251	260	272	278		
225	232	242	249	258	270	279	283		
231	238	248	256	266	278	286	291		
235	245	253	260	272	285	293	302		
261	272	281	290	304	318	328	334		
288	299	309	322	335	350	361	369		
297	306	318	328	340	356	369	378		
302	311	325	334	348	363	377	387		
307	319	330	342	357	373	385	395		
312	325	337	350	363	379	393	404		
327	338	353	363	379	397	410	420		
341	353	366	379	395	413	429	437		
355	366	382	395	411	431	445	456		
369	380	397	409	427	448	460	474		
385	397	412	428	445	463	480	492		
400	412	429	441	460	482	499	509		
414	430	445	460	480	502	518	532		
431	445	461	479	500	521	537	553		
450	462	481	499	518	540	560	574		
464	481	500	517	539	562	581	595		
484	501	519	537	559	585	604	619		
503	519	538	558	581	607	628	644		

Pricing is continued on the following page.

U N T B P
Tackboard – Panel Wall Mount
(Continued)

DIMENSIONS
FOR MM X BY 25.4

PRICING

H	W	Standard Panel Fabric							
		A/COM	Gr. 1	Gr. 2	Gr. 3	Gr. 4	Gr. 5	Gr. 6	Gr. 7
22	23 - 24	231	236	248	257	270	281	291	302
22	25 - 27	238	248	257	268	280	291	304	312
22	28 - 30	248	256	266	277	288	303	316	325
22	31 - 33	256	263	277	285	299	313	326	333
22	34 - 36	261	272	283	293	307	325	334	344
22	37 - 39	277	283	298	308	324	340	353	361
22	40 - 42	286	298	309	324	338	355	367	378
22	43 - 45	316	328	342	356	374	393	408	418
22	46 - 48	344	357	375	389	409	431	449	460
37	23 - 24	250	259	275	285	301	319	331	344
37	25 - 27	266	278	290	304	321	338	354	364
37	28 - 30	281	291	307	322	338	357	375	385
37	31 - 33	293	307	324	338	357	378	395	408
37	34 - 36	307	322	338	355	376	399	416	431
37	37 - 39	321	333	352	367	388	412	431	445
37	40 - 42	330	347	363	379	401	428	445	459
37	43 - 45	373	389	409	430	455	483	504	522
37	46 - 48	412	432	455	479	507	538	563	583

UKSCIS

Single Locker with Cubby Infill



The Single Locker with Cubby Infill mounts to the open through Single Locker with Cubby to enclose the back of the storage unit.

WHAT'S INCLUDED

Infill, attachment hardware.

NOTES

Type (Elevated or Standard), height and width should be specified according to the size of the cabinet.

The Outside finish will match the Inside finish specified.

Stop options correspond to limitations of the product offering for the given storage unit.

Infill for 36" high Elevated is **not** available.

PRODUCT OPTIONS

Infill Style	Type	Height	Width	Outside & Inside Finish	Bracket Finish
S Solid	E Elevated	36, 42, 51, 66	29, 35	Source Laminate Flintwood Natural Veneer	Foundation Mica
	S Standard				

SAMPLE ORDER CODE

UKSCIS S	S	36	35	FX	7
----------	---	----	----	----	---

DIMENSIONS INCHES / MM

H	W
36 / 914	29 / 737
36 / 914	35 / 889
42 / 1067	29 / 737
42 / 1067	35 / 889
51 / 1295	29 / 737
51 / 1295	35 / 889
66 / 1676	29 / 737
66 / 1676	35 / 889

PRICING

ELEVATED (E)

Source Laminate	Flintwood	Natural Veneer
197	405	428
197	405	428
201	418	439
201	418	439
226	449	469
226	449	469
279	534	556
279	534	556

STANDARD (S)

Source Laminate	Flintwood	Natural Veneer
201	418	439
201	418	439
207	433	455
207	433	455
232	461	483
232	461	483
283	545	568
283	545	568

UTLXIS

Lateral Tower Infill

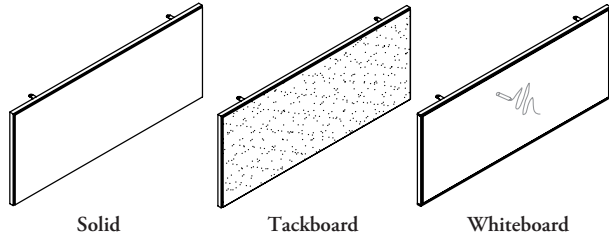

The Lateral Tower Infill mounts to the open through Lateral Tower with Cubby to enclose the back of the storage unit.

WHAT'S INCLUDED

Infill, attachment hardware.

NOTES

Type (Elevated or Standard), height and width should be specified according to the size of the cabinet.

When the Outside finish is Source Laminate, Flintwood or Natural Veneer, the Inside finish will match the outside.

When the Outside finish is fabric, the Inside finish will be painted.

When the Outside finish is a whiteboard, the Inside finish can be Source Laminate, Flintwood or Natural Veneer.

Actual size of storage infill relates to opening and will vary depending on type and size of storage unit.

Infill for 36" high Elevated is **not** available.

This Infill **cannot** be used on Combo Tower with a Source Laminate Case.

PRODUCT OPTIONS

Infill Style	Type	Height	Width	Outside Finish	Inside Finish	Bracket Finish
S Solid	E Elevated	36, 42, 51, 66	24, 30, 36	WZ Whiteboard	Foundation	Foundation
T Tackable	S Standard			Standard Panel Fabric	Mica	Mica
W Whiteboard				Source Laminate	Source Laminate	
				Flintwood	Flintwood	
				Natural Veneer	Natural Veneer	

SAMPLE ORDER CODE

UTLXIS S	S	36	36	11PP	7	7
-----------------	----------	-----------	-----------	-------------	----------	----------

DIMENSIONS INCHES / MM

H	W
42 / 1067	24 / 610
42 / 1067	30 / 762
42 / 1067	36 / 914
51 / 1295	24 / 610
51 / 1295	30 / 762
51 / 1295	36 / 914
66 / 1676	24 / 610
66 / 1676	30 / 762
66 / 1676	36 / 914

36 / 914	24 / 610
36 / 914	30 / 762
36 / 914	36 / 914
42 / 1067	24 / 610
42 / 1067	30 / 762
42 / 1067	36 / 914
51 / 1295	24 / 610
51 / 1295	30 / 762
51 / 1295	36 / 914
66 / 1676	24 / 610
66 / 1676	30 / 762
66 / 1676	36 / 914

PRICING

INFILL STYLE SOLID: OUTSIDE FINISH SOLID – Inside Finish will match

ELEVATED (E)

Source Laminate	Flintwood	Natural Veneer
226	383	400
236	412	430
249	439	459
236	399	414
249	428	445
260	455	476
308	512	535
351	582	609
391	654	683

STANDARD (S)

Source Laminate	Flintwood	Natural Veneer
236	399	414
249	428	445
260	455	476
226	383	400
236	412	430
249	439	459
268	455	476
290	499	519
313	539	563
331	568	594
385	654	683
428	723	758

Pricing is continued on the following page.

UTLXIS
Lateral Tower Infill
(Continued)

DIMENSIONS
INCHES / MM

H	W
42 / 1067	24 / 610
42 / 1067	30 / 762
42 / 1067	36 / 914
51 / 1295	24 / 610
51 / 1295	30 / 762
51 / 1295	36 / 914
66 / 1676	24 / 610
66 / 1676	30 / 762
66 / 1676	36 / 914

36 / 914	24 / 610
36 / 914	30 / 762
36 / 914	36 / 914
42 / 1067	24 / 610
42 / 1067	30 / 762
42 / 1067	36 / 914
51 / 1295	24 / 610
51 / 1295	30 / 762
51 / 1295	36 / 914
66 / 1676	24 / 610
66 / 1676	30 / 762
66 / 1676	36 / 914

H	W
42 / 1067	24 / 610
42 / 1067	30 / 762
42 / 1067	36 / 914
51 / 1295	24 / 610
51 / 1295	30 / 762
51 / 1295	36 / 914
66 / 1676	24 / 610
66 / 1676	30 / 762
66 / 1676	36 / 914

36 / 914	24 / 610
36 / 914	30 / 762
36 / 914	36 / 914
42 / 1067	24 / 610
42 / 1067	30 / 762
42 / 1067	36 / 914
51 / 1295	24 / 610
51 / 1295	30 / 762
51 / 1295	36 / 914
66 / 1676	24 / 610
66 / 1676	30 / 762
66 / 1676	36 / 914

PRICING

INFILL STYLE TACKABLE; OUTSIDE FINISH TACKABLE – Inside Finish will be painted. See appropriate pricing below.

ELEVATED (E)

Standard Panel Fabric

A/COM	Gr. 1	Gr. 2	Gr. 3	Gr. 4	Gr. 5	Gr. 6	Gr. 7
215	227	240	254	270	286	306	326
235	249	261	279	297	313	333	355
256	271	286	306	327	348	369	393
231	242	256	272	288	307	327	350
249	261	279	297	314	333	355	378
270	283	302	321	340	362	387	412
322	341	363	388	414	441	472	504
361	383	409	437	467	501	536	574
413	439	471	503	538	578	616	661

STANDARD (S)

Standard Panel Fabric

A/COM	Gr. 1	Gr. 2	Gr. 3	Gr. 4	Gr. 5	Gr. 6	Gr. 7
231	242	256	272	288	307	327	350
249	261	279	297	314	333	355	378
270	283	302	321	340	362	387	412
215	227	240	254	270	286	306	326
235	249	261	279	297	313	333	355
256	271	286	306	327	348	369	393
270	283	302	321	340	362	387	412
297	312	331	354	378	402	430	459
328	350	370	395	423	451	482	517
350	369	393	420	450	481	515	552
413	439	471	503	538	578	616	661
464	499	532	568	609	653	699	748

INFILL STYLE WHITEBOARD; OUTSIDE FINISH WHITEBOARD – Inside Finish will be solid. See appropriate pricing below.

ELEVATED (E)

Source Laminate	Flintwood	Natural Veneer
290	455	474
312	499	519
353	556	579
313	483	503
341	539	562
383	596	623
517	871	911
552	930	974
773	1318	1379

STANDARD (S)

Source Laminate	Flintwood	Natural Veneer
313	483	503
341	539	562
383	596	623
290	455	474
312	499	519
353	556	579
395	596	623
417	638	668
538	797	831
558	831	870
610	923	966
841	1209	1265

UTCXIS

Combo Tower Infill

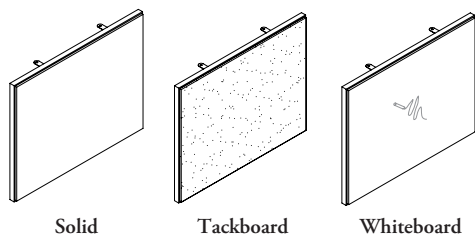

The Combo Tower Infill mounts to the open through Combo Tower with Cubby to enclose the back of the storage unit.

WHAT'S INCLUDED

Infill, attachment hardware.

NOTES

Type (Elevated or Standard), height and width should be specified according to the size of the cabinet.

When the Outside finish is Source Laminate, Flintwood or Natural Veneer, the Inside finish will match the outside.

When the Outside finish is fabric, the Inside finish will be painted.

When the Outside finish is a whiteboard, the Inside finish can be Source Laminate, Flintwood or Natural Veneer.

Cannot be used on Combo Tower with Source Laminate Case. Please see Source Laminate Tower Infill (UTCXIX).

PRODUCT OPTIONS

Infill Style	Type	Height	Width	Outside Finish	Inside Finish	Bracket Finish
S Solid	E Elevated	36, 42, 51, 66	24, 30, 36, 42, 48	WZ Whiteboard	Foundation	Foundation
T Tackable	S Standard			Standard Panel Fabric	Mica	Mica
W Whiteboard				Flintwood Natural Veneer	Flintwood Natural Veneer	

SAMPLE ORDER CODE

UTCXIS W	S	36	36	WZ	FX	7
----------	---	----	----	----	----	---

DIMENSIONS INCHES / MM

H	W
36 / 914	24 / 610
36 / 914	30 / 762
36 / 914	36 / 914
36 / 914	42 / 1067
36 / 914	48 / 1219
42 / 1067	24 / 610
42 / 1067	30 / 762
42 / 1067	36 / 914
42 / 1067	42 / 1067
42 / 1067	48 / 1219
51 / 1295	24 / 610
51 / 1295	30 / 762
51 / 1295	36 / 914
51 / 1295	42 / 1067
51 / 1295	48 / 1219
66 / 1676	24 / 610
66 / 1676	30 / 762
66 / 1676	36 / 914
66 / 1676	42 / 1067
66 / 1676	48 / 1219

PRICING

INFILL STYLE SOLID: OUTSIDE FINISH SOLID – Inside Finish will match

ELEVATED (E)		STANDARD (S)	
Flintwood	Natural Veneer	Flintwood	Natural Veneer
n/a	n/a	369	387
n/a	n/a	369	387
n/a	n/a	399	414
n/a	n/a	428	445
n/a	n/a	455	476
355	369	355	370
355	369	355	370
383	400	383	400
412	430	412	430
439	459	439	459
369	385	412	432
369	385	412	432
399	414	455	476
428	445	499	519
455	476	539	563
439	460	512	526
439	460	512	526
512	535	568	594
582	609	654	683
654	683	723	758

Pricing is continued on the following page.

UTCXIS
Combo Tower Infill
(Continued)

DIMENSIONS
INCHES / MM

H	W
42 / 1067	24 / 610
42 / 1067	30 / 762
42 / 1067	36 / 914
42 / 1067	42 / 1067
42 / 1067	48 / 1219
51 / 1295	24 / 610
51 / 1295	30 / 762
51 / 1295	36 / 914
51 / 1295	42 / 1067
51 / 1295	48 / 1219
66 / 1676	24 / 610
66 / 1676	30 / 762
66 / 1676	36 / 914
66 / 1676	42 / 1067
66 / 1676	48 / 1219

PRICING

INFILL STYLE TACKABLE; OUTSIDE FINISH TACKABLE – Inside Finish will be painted. See appropriate pricing below.

ELEVATED (E)

Standard Panel Fabric

A/COM	Gr. 1	Gr. 2	Gr. 3	Gr. 4	Gr. 5	Gr. 6	Gr. 7
197	205	219	231	239	245	259	278
197	205	219	231	239	245	259	278
215	227	240	254	263	271	286	306
235	249	261	279	290	297	313	333
256	271	286	306	319	326	348	369
211	221	233	248	257	261	280	299
211	221	233	248	257	261	280	299
231	242	256	272	282	287	307	327
249	261	279	297	308	313	333	355
270	283	302	321	333	340	362	387
282	299	318	337	351	357	382	408
282	299	318	337	351	357	382	408
322	341	363	388	406	413	441	472
361	383	409	437	458	468	501	536
413	439	471	503	526	538	578	616

STANDARD (S)

Standard Panel Fabric

A/COM	Gr. 1	Gr. 2	Gr. 3	Gr. 4	Gr. 5	Gr. 6	Gr. 7
211	221	233	248	263	280	299	319
211	221	233	248	263	280	299	319
231	242	256	272	288	307	327	350
249	261	279	297	314	333	355	378
270	283	302	321	340	362	387	412
197	205	219	231	246	259	278	297
197	205	219	231	246	259	278	297
215	227	240	254	270	286	306	326
235	249	261	279	297	313	333	355
256	271	286	306	327	348	369	393
242	256	271	285	304	324	344	364
242	256	271	285	304	324	344	364
270	283	302	321	340	362	387	412
297	312	331	354	378	402	430	459
328	350	370	395	423	451	482	517
282	299	318	338	360	383	410	437
282	299	318	338	360	383	410	437
350	369	393	420	450	481	515	552
413	439	471	503	538	578	616	661
464	499	532	568	609	653	699	748

Pricing is continued on the following page.

UTCXIS

Combo Tower Infill
(Continued)

DIMENSIONS
INCHES / MM

PRICING

INFILL STYLE WHITEBOARD; OUTSIDE FINISH WHITEBOARD – Inside Finish will be solid. See appropriate pricing below

		ELEVATED (E)		STANDARD (S)	
H	W	Flintwood	Natural Veneer	Flintwood	Natural Veneer
36 / 914	24 / 610	n/a	n/a	428	443
36 / 914	30 / 762	n/a	n/a	428	443
36 / 914	36 / 914	n/a	n/a	483	503
36 / 914	42 / 1067	n/a	n/a	539	562
36 / 914	48 / 1219	n/a	n/a	596	623
42 / 1067	24 / 610	412	429	412	430
42 / 1067	30 / 762	412	429	412	430
42 / 1067	36 / 914	455	474	455	474
42 / 1067	42 / 1067	499	519	499	519
42 / 1067	48 / 1219	556	579	556	579
51 / 1295	24 / 610	428	443	556	579
51 / 1295	30 / 762	428	443	556	579
51 / 1295	36 / 914	483	503	596	623
51 / 1295	42 / 1067	539	562	638	668
51 / 1295	48 / 1219	596	623	797	831
66 / 1676	24 / 610	812	849	745	781
66 / 1676	30 / 762	812	849	745	781
66 / 1676	36 / 914	871	911	831	870
66 / 1676	42 / 1067	930	974	923	966
66 / 1676	48 / 1219	1318	1379	1209	1265

UTCXIX

Source Laminate Combo Tower Infill

The Source Laminate Combo Tower Infill mounts to the open through Combo Tower with Cubby (Source Laminate Case finish only) to enclose the back of the storage unit.

WHAT'S INCLUDED

Infill, attachment hardware.

NOTES

Type (Elevated or Standard), height and width should be specified according to the size of the cabinet.

When the Outside finish is Source Laminate, Flintwood or Natural Veneer, the Inside finish will match the outside.

When the Outside finish is fabric, the Inside finish will be painted.

When the Outside finish is a whiteboard, the Inside finish can be Source Laminate, Flintwood or Natural Veneer.

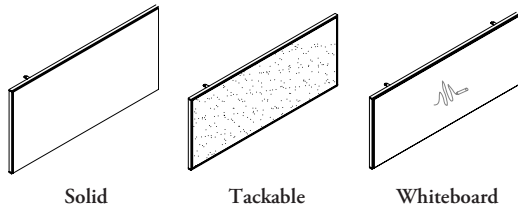

PRODUCT OPTIONS

Infill Style	Type	Height	Width	Outside Finish	Inside Finish	Bracket Finish
S Solid	E Elevated	36, 42, 51, 66	24, 30, 36, 42, 48	WZ Whiteboard	Foundation	Foundation
T Tackable	S Standard			Standard Panel Fabric	Mica	Mica
W Whiteboard				Source Laminate	Source Laminate	
				Flintwood	Flintwood	
				Natural Veneer	Natural Veneer	

SAMPLE ORDER CODE

UTCXIX W	S	36	36	WZ	FX	7
----------	---	----	----	----	----	---

DIMENSIONS INCHES / MM

H	W
36 / 914	24 / 610
36 / 914	30 / 762
36 / 914	36 / 914
36 / 914	42 / 1067
36 / 914	48 / 1219
42 / 1067	24 / 610
42 / 1067	30 / 762
42 / 1067	36 / 914
42 / 1067	42 / 1067
42 / 1067	48 / 1219
51 / 1295	24 / 610
51 / 1295	30 / 762
51 / 1295	36 / 914
51 / 1295	42 / 1067
51 / 1295	48 / 1219
66 / 1676	24 / 610
66 / 1676	30 / 762
66 / 1676	36 / 914
66 / 1676	42 / 1067
66 / 1676	48 / 1219

PRICING

INFILL STYLE SOLID: OUTSIDE FINISH SOLID – Inside Finish will match

ELEVATED (E)			STANDARD (S)		
Source Laminate	Flintwood	Natural Veneer	Source Laminate	Flintwood	Natural Veneer
n/a	n/a	n/a	220	356	375
n/a	n/a	n/a	220	356	375
n/a	n/a	n/a	229	385	401
n/a	n/a	n/a	240	412	430
n/a	n/a	n/a	253	438	459
205	344	356	205	344	357
205	344	356	205	344	357
220	370	386	220	370	386
229	399	414	229	399	414
240	427	443	240	427	443
220	356	373	234	399	417
220	356	373	234	399	417
229	385	401	258	438	459
240	412	430	281	481	502
253	438	459	304	522	544
258	427	445	286	496	507
258	427	445	286	496	507
299	496	517	322	550	574
338	562	588	373	632	660
378	632	660	412	700	733

Pricing is continued on the following page.

UTCXIX
Source Laminate Combo Tower Infill
(Continued)

DIMENSIONS
INCHES / MM

H	W
42 / 1067	24 / 610
42 / 1067	30 / 762
42 / 1067	36 / 914
42 / 1067	42 / 1067
42 / 1067	48 / 1219
51 / 1295	24 / 610
51 / 1295	30 / 762
51 / 1295	36 / 914
51 / 1295	42 / 1067
51 / 1295	48 / 1219
66 / 1676	24 / 610
66 / 1676	30 / 762
66 / 1676	36 / 914
66 / 1676	42 / 1067
66 / 1676	48 / 1219

PRICING

INFILL STYLE TACKABLE; OUTSIDE FINISH TACKABLE – Inside Finish will be painted. See appropriate pricing below.

ELEVATED (E)

Standard Panel Fabric

A/COM	Gr. 1	Gr. 2	Gr. 3	Gr. 4	Gr. 5	Gr. 6	Gr. 7
189	199	210	223	236	252	268	285
189	199	210	223	236	252	268	285
208	221	232	246	260	278	297	313
227	240	254	270	286	304	324	344
248	260	278	297	315	334	356	380
204	212	225	238	254	271	287	307
204	212	225	238	254	271	287	307
223	233	248	261	279	298	316	337
240	254	270	285	304	324	344	364
259	275	290	308	329	351	375	399
274	287	306	326	348	369	393	420
274	287	306	326	348	369	393	420
309	329	352	376	402	428	456	486
350	370	395	424	453	483	518	556
400	427	455	485	519	558	596	638

STANDARD (S)

Standard Panel Fabric

A/COM	Gr. 1	Gr. 2	Gr. 3	Gr. 4	Gr. 5	Gr. 6	Gr. 7
204	212	225	238	254	271	287	307
204	212	225	238	254	271	287	307
223	233	248	261	279	298	316	337
240	254	270	285	304	324	344	364
259	275	290	308	329	351	375	399
189	199	210	223	236	252	268	285
189	199	210	223	236	252	268	285
208	221	232	246	260	278	297	313
227	240	254	270	286	304	324	344
248	260	278	297	315	334	356	380
233	248	260	277	295	311	331	353
233	248	260	277	295	311	331	353
259	275	290	308	329	351	375	399
285	303	322	342	365	388	414	443
318	337	357	382	408	434	464	500
274	287	306	327	349	370	397	424
274	287	306	327	349	370	397	424
337	356	380	406	434	463	499	532
400	427	455	485	519	558	596	638
451	481	514	550	588	631	675	723

Pricing is continued on the following page.

UTCXIX

Source Laminate Combo Tower Infill
(Continued)

DIMENSIONS
INCHES / MM

PRICING

INFILL STYLE WHITEBOARD: OUTSIDE FINISH WHITEBOARD – Inside Finish will be solid. See appropriate pricing below

		ELEVATED (E)			STANDARD (S)		
H	W	Source Laminate	Flintwood	Natural Veneer	Source Laminate	Flintwood	Natural Veneer
36 / 914	24 / 610	n/a	n/a	n/a	281	412	429
36 / 914	30 / 762	n/a	n/a	n/a	281	412	429
36 / 914	36 / 914	n/a	n/a	n/a	304	465	485
36 / 914	42 / 1067	n/a	n/a	n/a	329	522	543
36 / 914	48 / 1219	n/a	n/a	n/a	370	578	602
42 / 1067	24 / 610	259	399	413	258	399	414
42 / 1067	30 / 762	259	399	413	258	399	414
42 / 1067	36 / 914	281	438	457	281	438	457
42 / 1067	42 / 1067	303	481	502	303	481	502
42 / 1067	48 / 1219	341	536	559	341	536	559
51 / 1295	24 / 610	278	412	429	355	536	559
51 / 1295	30 / 762	278	412	429	355	536	559
51 / 1295	36 / 914	304	465	485	382	578	602
51 / 1295	42 / 1067	329	522	543	404	616	645
51 / 1295	48 / 1219	370	578	602	521	769	803
66 / 1676	24 / 610	464	785	821	493	720	755
66 / 1676	30 / 762	464	785	821	493	720	755
66 / 1676	36 / 914	500	841	879	538	803	840
66 / 1676	42 / 1067	532	898	940	589	892	935
66 / 1676	48 / 1219	746	1274	1332	812	1168	1221

The Pedestal Tower with Cubby Infill mounts to the open through Pedestal Tower with Cubby to enclose the back of the storage unit.

WHAT'S INCLUDED

Infill, attachment hardware.

NOTES

Type (Elevated or Standard), height and width should be specified according to the size of the cabinet.

The Outside finish will match the Inside finish specified.

Stop options correspond to limitations of the product offering for the given storage unit.

Infill for 36" high Elevated is **not** available.

UTDCIS
Pedestal Tower with Cubby Infill



PRODUCT OPTIONS

Infill Style	Type	Height	Width	Outside & Inside Finish	Bracket Finish
S Solid	E Elevated	36, 42, 51, 66	29, 35	Source Laminate Flintwood Natural Veneer	Foundation Mica
	S Standard				

SAMPLE ORDER CODE

UTDCIS S	E	36	35	FX	7
-----------------	----------	-----------	-----------	-----------	----------

DIMENSIONS
INCHES / MM

H	W
36 / 914	29 / 737
36 / 914	35 / 889
42 / 1067	29 / 737
42 / 1067	35 / 889
51 / 1295	29 / 737
51 / 1295	35 / 889
66 / 1676	29 / 737
66 / 1676	35 / 889

PRICING

ELEVATED (E)

Source Laminate	Flintwood	Natural Veneer
197	405	428
197	405	428
201	418	439
201	418	439
226	449	469
226	449	469
279	534	556
279	534	556

STANDARD (S)

Source Laminate	Flintwood	Natural Veneer
201	418	439
201	418	439
207	433	455
207	433	455
232	461	483
232	461	483
283	545	568
283	545	568

U W L C
Seat Cushion

The Seat Cushion is removable and is intended to provide casual guest seating when applied to a low credenza top or rolling pedestal.

WHAT'S INCLUDED

1 seat cushion.

NOTES

Yardage requirement for com or col is 0.75 yards based on a pattern of repeat of no more than 4" horizontal or vertical. Larger repeats will require additional yardage.

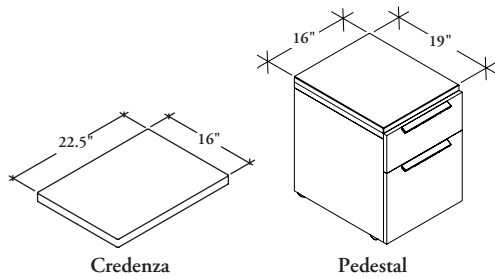

PRODUCT OPTIONS

Style	Upholstery Finish
R Rolling Pedestal	Seating Fabric
C Credenza	Leather

SAMPLE ORDER CODE

UWLC R	S491
---------------	-------------

PRICING

Gr. 1	COM/ Gr. 2	COL/ Gr. 3	Gr. 4	Gr. 5	Gr. 6	Gr. 7	Gr. 8	Gr. 9	Gr. 10	Leather LA	Leather LB	Leather LC	Leather LD
406	461	483	504	526	539	568	596	625	654	817	877	1057	1113

The Fitted Seated Cushion is specifically sized to fit credenza tops. It is removable and is intended to provide casual guest seating when applied to a low credenza top.

WHAT'S INCLUDED

1 seat cushion, velcro attachment strips.

NOTES

Yardage requirement for COM is 0.75 yards based on a pattern of repeat of no more than 4" horizontal or vertical. Larger repeats will require additional yardage.

**U W L F
Fitted Seat Cushion**

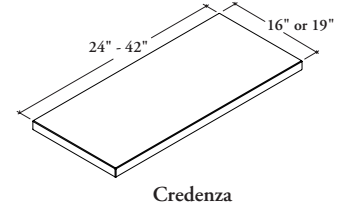

PRODUCT OPTIONS

Depth	Width (6" increments)	Upholstery Finish
16, 19	24 - 42	Seating Fabric

SAMPLE ORDER CODE

UWLF 16	30	GA06
----------------	-----------	-------------

**DIMENSIONS
INCHES / MM**

D	W
16 / 406	24 / 610
16 / 406	30 / 762
16 / 406	36 / 914
16 / 406	42 / 1067
19 / 483	24 / 610
19 / 483	30 / 762
19 / 483	36 / 914
19 / 483	42 / 1067

PRICING

Grade 1	COM/ Grade 2	Grade 3	Grade 4	Grade 5	Grade 6	Grade 7	Grade 8	Grade 9	Grade 10
409	471	496	521	544	572	602	631	664	695
451	518	543	572	601	630	660	694	731	764
504	580	609	638	670	705	740	776	816	855
558	640	672	708	741	780	818	858	904	948
409	471	496	521	544	572	602	631	664	695
451	518	543	572	601	630	660	694	731	764
504	580	609	638	670	705	740	776	816	855
558	640	672	708	741	780	818	858	904	948

U N T K
Tool Kit

The Tool Kit is required to install fascia connectors and to remove fascias from panel walls.

WHAT'S INCLUDED

1 tool (as specified).



Fascia Removal Tool



Male Connector
Insertion Tool



Bottom Vertical Male
Connector Insertion
Tool

PRODUCT OPTIONS

Style	
A	Male Connector Insertion Tool
B	Fascia Removal Tool
C	Bottom Vertical Male Connector Insertion Tool

SAMPLE ORDER CODE

UNTK A

STYLE	PRICING
A	211
B	26
C	224

Specifically designed to work with Side Filer and Mini Side Filer, Accessory Bundles help organize the interior and provide functional organization.

WHAT'S INCLUDED

Accessory Bundle A: 1 pen pocket, 1 hanging tray, 1 headphone hook

Accessory Bundle B: 1 pen pocket, 1 hanging tray, 1 headphone hook, 1 paper filer

NOTES

Compatible with standard accessory rails.

U N A B
Accessory Bundle

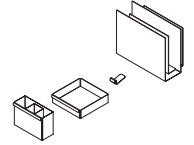

PRODUCT OPTIONS

Configuration	Metal Paint Finish
A Accessory Bundle A	Foundation
B Accessory Bundle B	Mica
	Accent

SAMPLE ORDER CODE

UNAB A	74
---------------	-----------

CONFIGURATION

PRICING

	Foundation	Mica/Accent
A	145	150
B	222	227

UNBW
Side Filer Boot Tray

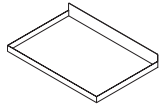

The Side Filer Boot Tray provides additional functionality for the bottom shelf of the Side Filer or Mini Side Filer. 180° reversible, it offers easier access to contents of the lower shelf in Mini Side Filer and secure containment for the items at the bottom of the Side Filer.

WHAT'S INCLUDED

1 boot tray with hardware

NOTES

Boot Tray is always 13" deep. The following outlines size compatibility for different widths.

12" - 24" deep Side Filer

18" - 30", 36" deep Side Filer

20" - 23" deep Mini Side Filer, 24" deep Side Filer without coat

26" - 29" deep Mini Side Filer

PRODUCT OPTIONS

Width	Metal Paint Finish
12, 18, 20, 26	Foundation Mica Accent

SAMPLE ORDER CODE

UNBW 18	74
----------------	-----------

DIMENSIONS
INCHES / MM

W
12 / 305
18 / 457
20 / 508
26 / 660

PRICING

	Foundation	Mica/Accent
	78	83
	78	83
	91	96
	91	96

electrics

electrics product map

UNQPR Power Box

Page 878

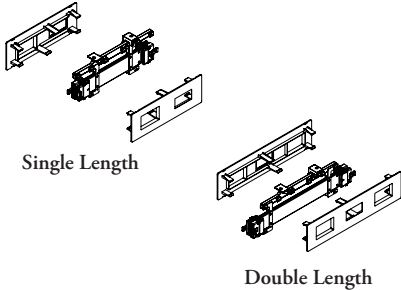

UNQRO Receptacle Outlet

Page 879



UNQBHR Power Harness

Page 880

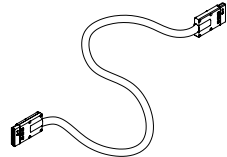

UNQBFR Base Feed

Page 881

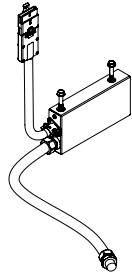

UNQBFSR Split Base Feed

Page 882

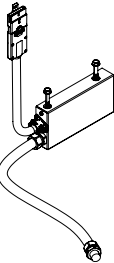

UNQCFR Ceiling Feed

Page 883



UNQEP Power Pole

Page 884

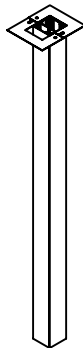

UNQEPR End of Run Power Pole

Page 885

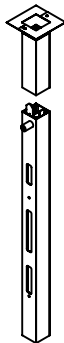

UNQCT Cable Trough

Page 886

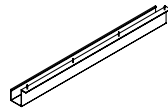

UNVC Vertical Cable Manager

Page 887

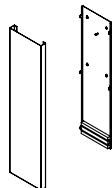

ZOEWM Casual Wire Manager Kit

Page 888

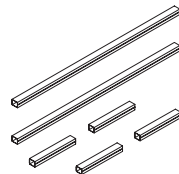

UNQDE Data Extender Plate

Page 889

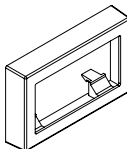

electrics product map

UNQPRCH Chicago Power Box

UNQBFRCH Chicago Base Feed

Page 890

Page 891

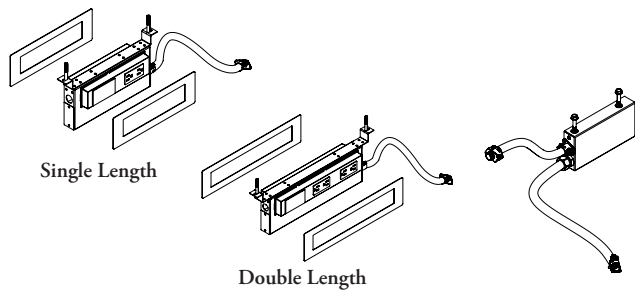

UNQCFRCH Chicago Ceiling Feed

Page 892



storage electrics

EWWT Under Cabinet Wire Tray

EWBF Storage Base Feed

Page 893

Page 894

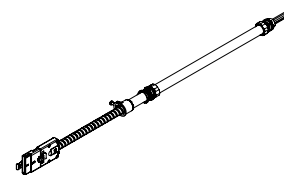
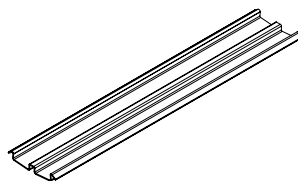

EWBFCH Storage Chicago Base Feed

EWBFS Storage Split Base Feed

EWCF Storage Ceiling Feed

Page 895

Page 896

Page 897

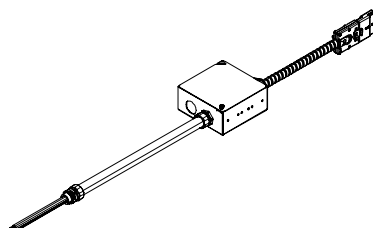
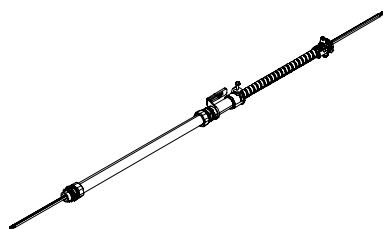

electrics product map

EWCFCH Storage Chicago Ceiling Feed

Page 898



EWBH Storage Power Harness

Page 894



EWDB 4-Way Splitter

Page 900

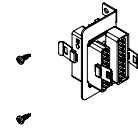

EWIC I-Connector

Page 900



EWQP Flush Mount Power & Data

Page 901

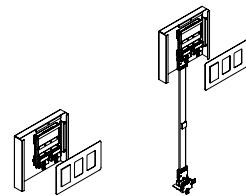

Base Height

Belldine Height

EWQPCH Chicago Flush-Mounted Power Box

Page 902



EWRO Storage Receptacle Outlet

Page 903



EWQPM Cubby Power Monument

Page 904

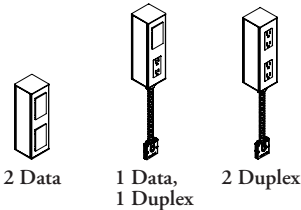

2 Data

1 Data,
1 Duplex

2 Duplex

EWQPMCH Chicago Cubby Power Monument

Page 905

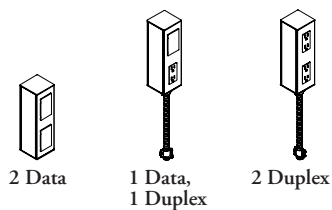

2 Data

1 Data,
1 Duplex

2 Duplex

EWEP Storage Power Pole

Page 906

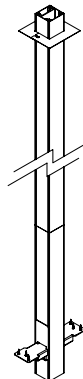

UNQPC Power Conservation System

Page 907

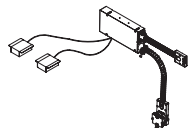

UNDG Diecast Grommet System

Page 908



UNQPR Power Box

The Power Box is a module that mounts to panel rails to allow mounting of receptacles.

WHAT'S INCLUDED

Single Length: bezel with 1 opening for receptacle and 1 opening for data.

Double Length: bezel with 2 openings for receptacle and 1 opening for data.

WHAT'S EXCLUDED

Receptacles (UNQRO) must be specified separately. Can be found in this section.

NOTES

For 24" and 30" wide panels, only the single length can be used.

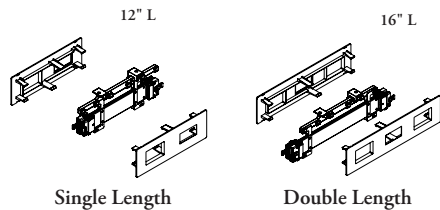

PRODUCT OPTIONS

Length	Application	Wire System	Country of Installation	Bezel Finish	PVC Free
S Single Length	A One-Sided	8T 8-Wire Isolated Ground	A Canada/U.S.A	YY Ebony	~ Standard
D Double Length	B Back-to-Back	8K 8-Wire Dual Isolated		YF Storm White	V PVC Free
			YN Platinum Grey Coordinate		
			YV Very White Coordinate		

SAMPLE ORDER CODE

UNQPR S	A	8K	A	YF	V
----------------	----------	-----------	----------	-----------	----------

DIMENSIONS

PRICING

	STANDARD		PVC FREE (V)	
	One-Sided (A)	Back-to-Back (B)	One-Sided (A)	Back-to-Back (B)
L				
S	205	234	227	258
D	249	278	275	306

The Receptacle is a single duplex that slides onto the power box to provide power.

WHAT'S INCLUDED

1 single duplex.

UNQRO
Receptacle



PRODUCT OPTIONS

Receptacle Style	Outlet Configuration	Country of Installation	Receptacle Finish
D Controlled 15 amp	1 Circuit 1	A Canada/U.S.A	YY Ebony
E Controlled 20 amp	2 Circuit 2		YF Storm White
S Standard 15 amp	3 Circuit 3 (use with 8T only)		YN Platinum Grey Coordinate
T T-Slot 20 amp	5 Circuit 5		YV Very White Coordinate
U USB (Circuit 1 only)	6 Circuit 6 (use with 8K only)		
	A Non Isolated Ground Circuit (use with 7T and 7K only)		
	B Non Isolated Ground Circuit (use with 7K only)		

SAMPLE ORDER CODE

UNQRO S	6	A	YF
----------------	----------	----------	-----------

DIMENSIONS

Style
S
T
U
D
E

PRICING

35
43
179
35
43

UNQBHR
Power Harness

The Power Harness routes power between power boxes and base feeds.

WHAT'S INCLUDED

Power harness.

NOTES

24" length is mesh conduit.

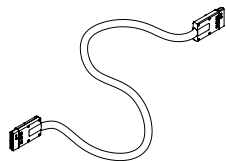

PRODUCT OPTIONS

Wire System	Length	Country of Installation	PVC Free
8K 8-Wire Dual Isolated	018, 024, 048, 072, 096, 120, 144	A Canada/U.S.A.	~ Standard
8T 8-Wire Isolated Ground			V PVC Free

SAMPLE ORDER CODE

UNQBHR 8K	72	A	V
------------------	-----------	----------	----------

DIMENSIONS

L
18
24
48
72
96
120
144

PRICING

8-WIRE DUAL ISOLATED (8K)		8-WIRE ISOLATED GROUND (8T)	
Standard	PVC Free (V)	Standard	PVC Free (V)
142	155	126	137
173	191	153	170
227	250	189	208
244	270	201	223
279	307	231	254
330	364	275	303
357	395	293	325

UNQBFR
Base Feed

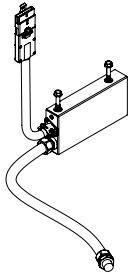

The Base Feed delivers power to a Panel Wall at base level.

WHAT'S INCLUDED

Base feed, 72" liquid-tite cable, power bezel mounting hardware.

NOTES

Power Harness (UNQBH) is required to route power to a power box or distribution box.

Base Feed Box finished in Platinum.

PRODUCT OPTIONS

Wire System	Length	Country of Installation	Bezel Finish	PVC Free
7T 7-Wire Non Isolated Ground	72	A Canada/U.S.A.	YY Ebony	~ Standard
7K 7-Wire Dual Non Isolated			YF Storm White	V PVC Free
8T 8-Wire Isolated Ground			YN Platinum Grey Coordinate	
8K 8-Wire Dual Isolated				

SAMPLE ORDER CODE

UNQBFR 8K	8K	72	YY	V
------------------	-----------	-----------	-----------	----------

PRICING

7-WIRE NON ISOLATED GROUND (7T) and 8-WIRE ISOLATED GROUND (8T)

Standard	PVC Free (V)
409	451

7-WIRE NON DUAL ISOLATED (7K) and 8-WIRE DUAL ISOLATED (8K)

Standard	PVC Free (V)
512	562

UNQBFSR
Split Base Feed

The Split Base Feed is hard-wired to the building power supply in two places. It feeds power into the Panel. Typically required in New York.

WHAT'S INCLUDED

1 split base feed, liquid-tite cable (18" or 72"), 1 wiring junction box, mounting hardware and data/communication bezel.

Split Base Feed is finished in Platinum.

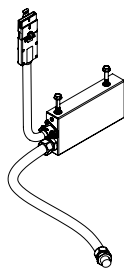

PRODUCT OPTIONS

Wire System	Length	Country of Installation	Bezel Finish	PVC Free
7T 7-Wire Non Isolated Ground	18, 72	A Canada/U.S.A.	YY Ebony	~ Standard
7K 7-Wire Dual Non Isolated			YF Storm White	V PVC Free
8T 8-Wire Isolated Ground			YN Platinum Grey Coordinate	
8K 8-Wire Dual Isolated				

SAMPLE ORDER CODE

UNQBFSR 8K	8K	72	YY	V
-------------------	-----------	-----------	-----------	----------

DIMENSIONS

L
18
72

PRICING

7-WIRE NON ISOLATED GROUND (7T) and 8-WIRE ISOLATED GROUND (8T)	
Standard	PVC Free (V)
369	406
426	468
7-WIRE DUAL NON ISOLATED (7K) and 8-WIRE DUAL ISOLATED (8K)	
Standard	PVC Free (V)
469	517
538	593

The Ceiling Feed routes power from the ceiling into Panel Walls.

WHAT'S INCLUDED

Ceiling feed harness, junction box, mounting hardware.

**UNQCFR
Ceiling Feed**



PRODUCT OPTIONS

Wire System	Length	Country of Installation	PVC Free
7T 7-Wire Non Isolated Ground	120	A Canada/U.S.A.	~ Standard
7K 7-Wire Dual Non Isolated			V PVC Free
8T 8-Wire Isolated Ground			
8K 8-Wire Dual Isolated			

SAMPLE ORDER CODE

UNQCFR 8T	120	A	V
------------------	------------	----------	----------

DIMENSIONS

L
120
120

PRICING

7-WIRE NON ISOLATED GROUND (7T) and 8-WIRE ISOLATED GROUND (8T)

Standard	PVC Free (V)
293	325

7-WIRE DUAL NON ISOLATED (7K) and 8-WIRE DUAL ISOLATED (8K)

Standard	PVC Free (V)
355	391

UNQEP
Power Pole

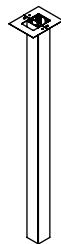

The Power Pole houses the ceiling feed and includes a pole divider for separating the ceiling feed from communications and data cables.

WHAT'S INCLUDED

Power pole, power pole cover, mounting bracket, attachment hardware, ceiling trim plate.

NOTES

Used for corner or off-module locations.

PRODUCT OPTIONS

Length	Finish	Mounting Application
48, 72, 96	AC Clear Anodized Foundation Mica	1 Corner 2 Off-Module

SAMPLE ORDER CODE

UNQEP 48	AC	1
----------	----	---

DIMENSIONS
INCHES / MM

L
48 / 1219
72 / 1829
96 / 2438

PRICING

307
401
481

The End of Run Power Pole houses the ceiling feed end of panel run entry points. A pole divider for separating the ceiling feed from communications and data cables is provided.

WHAT'S INCLUDED

1 base power pole, 1 upper power pole, ceiling plates, mounting hardware, ceiling trim plate.

NOTES

42" high base is for Panel Walls 42" - 66" and provides above and below worksurface power entry.

29" high base is for 29" high Panel Walls or when only below worksurface power entry is required.

UNQEPR
End of Run Power Pole



PRODUCT OPTIONS

Base Height	Upper Height	Finish
29, 42	48, 72, 96	AC Clear Anodized Foundation Mica

SAMPLE ORDER CODE

UNQEPR 42	96	AC
------------------	-----------	-----------

DIMENSIONS
INCHES / MM

Base Height	Upper Height
29 / 737	48 / 1219
29 / 737	72 / 1829
29 / 737	96 / 2438
42 / 1067	48 / 1219
42 / 1067	72 / 1829
42 / 1067	96 / 2438

PRICING

603
696
776
680
773
853

UNQCT Cable Trough

The Cable Trough is mounted below a worksurface for wire management.

WHAT'S INCLUDED

Cable trough, attachment hardware.

NOTES

The Cable Trough is Grey ABS plastic.

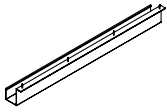

PRODUCT OPTIONS

Length
30, 72

SAMPLE ORDER CODE

UNQCT 30

DIMENSIONS INCHES / MM
L
30 / 762
72 / 1829

PRICING
46
81

The Vertical Cable Manager mounts to a Floor Screen to conceal and route cables from floor to desk height.

WHAT'S INCLUDED

Vertical cable manager (back and cover plate), attachment hardware.

NOTES

The North American height is 26". The additional height of 23" is for International requirements and enables an outlet box to be mounted above the cable manager.

UNVC
Vertical Cable Manager

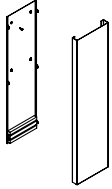

PRODUCT OPTIONS

Height	Finish
23, 26	Foundation Mica

SAMPLE ORDER CODE

UNVC 26	Q
---------	---

DIMENSIONS
INCHES / MM

H
23 / 584
26 / 660

PRICING

227
254

Z O E W M
Casual Wire Manager Kit

The Casual Wire Management Kit is applied to District credenzas to conceal and route wiring.

WHAT'S INCLUDED

2 x 24" casual wire managers, 4 x 4" casual wire managers.

NOTES

Finished in Ebony.

This product is mounted by double-sided tape and can be trimmed in length.

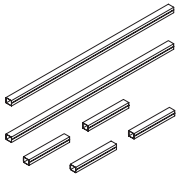

PRICING

43

The Data Extender Plate is placed over a communication opening to provide extended depth for data jacks which may be required in some applications. Consult your data cabling supplier for clearance requirements.

WHAT'S INCLUDED

1 data extender plate.

**UNQDE
Data Extender Plate**

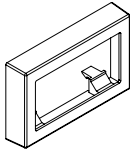

PRODUCT OPTIONS

Finish	
YY	Ebony
YF	Storm White
YN	Platinum Grey Coordinate
YV	Very White Coordinate

SAMPLE ORDER CODE

UNQDE YF

PRICING

29

UNQPRCH

Chicago Power Box

The Chicago Power Box provides one duplex and one communications opening on either one or both sides of a Panel Wall.

WHAT'S INCLUDED

Power box, 1 or 2 faceplates (as specified). Internal wiring (3-wire connection).

WHAT'S EXCLUDED

No connector provided.

NOTES

Faceplates have a Platinum painted finish.

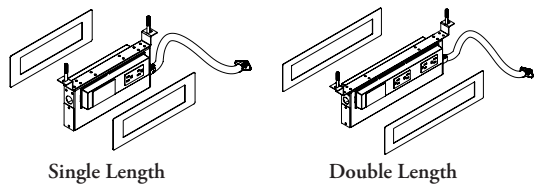

PRODUCT OPTIONS

Application	Mounting Location	Country of Installation
SA Single Length, One-Sided	L Below Worksurface Height (Base Fascia)	A Canada/U.S.A.
SB Single Length, Back-to-Back	U Above Worksurface Height (Upper Fascia)	
DA Double Length, One-Sided		
DB Double Length, Back-to-Back		

SAMPLE ORDER CODE

UNQPRCH A	U	A
-----------	---	---

APPLICATION	PRICING
SA	322
SB	387
DA	389
DB	453

The Chicago Base Feed delivers power to a Panel Wall at base level and provides entry for data communication feeds.

WHAT'S INCLUDED

Base feed, 72" liquid-tite cable, data/communications bezel mounting hardware. Internal wiring (3-wire connection).

WHAT'S EXCLUDED

No strain relief connector provided.

UNQBFRCH
Chicago Base Feed

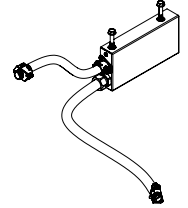

PRODUCT OPTIONS

Length	Country of Installation	Bezel Finish
72	A Canada/U.S.A.	YY Ebony YF Storm White YN Platinum Grey Coordinate

SAMPLE ORDER CODE

UNQBFRCH 72	A	YY
--------------------	----------	-----------

PRICING

354

UNQCFRCH
Chicago Ceiling Feed



The Chicago Ceiling Feed routes power from the ceiling into Panel Walls.

WHAT'S INCLUDED

Ceiling feed harness, junction box, mounting hardware.

WHAT'S EXCLUDED

Chicago Power Distribution Box (UNQDBCH) must be specified separately.

No strain relief connector provided.

PRODUCT OPTIONS

Length	Country of Installation
120	A Canada/U.S.A.

SAMPLE ORDER CODE

UNQCFRCH 120	A
--------------	---

PRICING

275

The Under Cabinet Wire Tray manages wires horizontally below the storage cabinet.

EWWT

Under Cabinet Wire Tray

WHAT'S INCLUDED

1 wire tray and mounting hardware.

NOTES

Tray **cannot** span across two storage units. Specify at least 12" less than the width of the cabinet onto which it is being mounted.

Finished in Platinum.

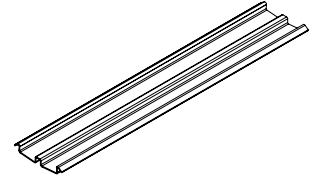

PRODUCT OPTIONS

Length
12, 24, 36, 48, 72, 84

SAMPLE ORDER CODE

EWWT 72

**DIMENSIONS
INCHES / MM**

PRICING

L	
12 / 305	29
24 / 610	49
36 / 914	75
48 / 1219	99
72 / 1829	148
84 / 2134	170

E W B F

Storage Base Feed

The Storage Base Feed provides power from the floor to the underside of the storage cabinet and connects to the harness.

WHAT'S INCLUDED

Base feed, 72" liquid-tite cable, I-connector, mounting hardware.

NOTES

Can be directly connected to the Flush Mounted Power & Data (EWQP) unit once I-connector is removed.

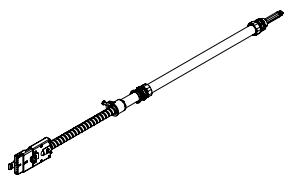

PRODUCT OPTIONS

Wire System	Length	Country of Installation	PVC Free
7T 7-Wire Non Isolated Ground	72, 144	A Canada/U.S.A.	~ Standard
7K 7-Wire Dual Non Isolated			V PVC Free
8T 8-Wire Isolated Ground			
8K 8-Wire Dual Isolated			

SAMPLE ORDER CODE

EWBF 8K	72	A	V
----------------	-----------	----------	----------

DIMENSIONS INCHES / MM

L
72 / 1529
144 / 3658

PRICING

7-WIRE NON ISOLATED GROUND (7T) and 8-WIRE ISOLATED GROUND (8T)

Standard	PVC Free (V)
362	666
471	919

7-WIRE DUAL NON ISOLATED (7K) and 8-WIRE DUAL ISOLATED (8K)

Standard	PVC Free (V)
400	734
518	1015

The Storage Chicago Base Feed delivers power from the floor to the underside of the storage cabinet.

WHAT'S INCLUDED

Base feed, 72" liquid-tite cable, mounting hardware.

NOTES

Storage Chicago Base Feed (EWBFCH) includes a 3-wire. No connection is provided on the bottom end due to Chicago electrics wiring restrictions.

Chicago electrics wiring restrictions require that all wiring and connections be supplied and connected by a licensed electrician.

EWBFCH
Storage Chicago Base Feed

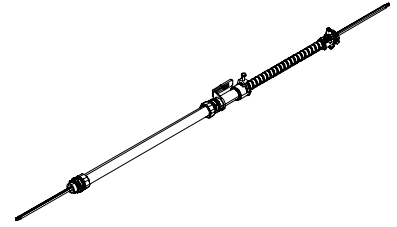

PRODUCT OPTIONS

Length	Country of Installation
72	A Canada/U.S.A.

SAMPLE ORDER CODE

EWBFCH 72	A
-----------	---

PRICING

299

EWBFS

Storage Split Base Feed

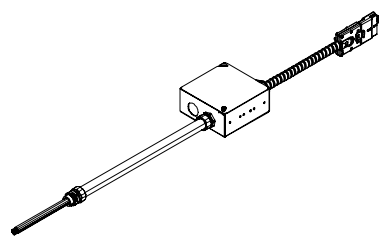

The Storage Split Base Feed delivers power from the floor to the underside of the storage cabinet. It is wired to the building power supply in two places for New York city wiring restrictions.

WHAT'S INCLUDED

1 base feed harness, junction box, I-connector, mounting hardware.

NOTES

Can be directly connected to the Flush Mounted Power & Data (EWQP) unit once I-connector is removed.

PRODUCT OPTIONS

Wire System	Length	Country of Installation	PVC Free
7T 7-Wire Non Isolated Ground	18, 72	A Canada/U.S.A.	Standard
7K 7-Wire Dual Non Isolated			V PVC Free
8T 8-Wire Isolated Ground			
8K 8-Wire Dual Isolated			

SAMPLE ORDER CODE

EWBFS 8K	72	A	V
-----------------	-----------	----------	----------

DIMENSIONS INCHES / MM

L
18 / 457
72 / 1529

PRICING

7-WIRE NON ISOLATED GROUND (7T) and 8-WIRE ISOLATED GROUND (8T)

Standard	PVC Free (V)
321	428
412	696

7-WIRE DUAL NON ISOLATED (7K) and 8-WIRE DUAL ISOLATED (8K)

Standard	PVC Free (V)
355	469
455	767

The Storage Ceiling Feed routes power to the underside of the storage cabinet from the ceiling through the storage power pole.

WHAT'S INCLUDED

Ceiling feed harness, junction box, I-connector, mounting hardware.

NOTES

Can be directly connected to the Flush Mounted Power & Data (EWQP) unit once I-connector is removed.

**EWCF
Storage Ceiling Feed**



PRODUCT OPTIONS

Wire System	Length	Country of Installation	PVC Free
7T 7-Wire Non Isolated Ground	120, 144	A Canada/U.S.A.	~ Standard
7K 7-Wire Dual Non Isolated			V PVC Free
8T 8-Wire Isolated Ground			
8K 8-Wire Dual Isolated			

SAMPLE ORDER CODE

EWCF 8K	120	A	V
----------------	------------	----------	----------

**DIMENSIONS
INCHES / MM**

L
120 / 3048
144 / 3658

PRICING

7-WIRE NON ISOLATED GROUND (7T) and 8-WIRE ISOLATED GROUND (8T)

Standard	PVC Free (V)
399	539
439	568

7-WIRE DUAL NON ISOLATED (7K) and 8-WIRE DUAL ISOLATED (8K)

Standard	PVC Free (V)
439	682
483	625

EWCFCH

Storage Chicago Ceiling Feed



The Storage Chicago Ceiling Feed routes power into the underside of the storage cabinet from the ceiling through the Storage Power Pole (EWEP).

WHAT'S INCLUDED

Ceiling feed harness, junction box, mounting hardware.

NOTES

The Storage Chicago Ceiling Feed (EWCFCH) includes a 3-wire. No connector is found on the bottom end due to Chicago electrics wiring restrictions.

Chicago electrics wiring restrictions require that all wiring and connections be supplied and connected by a licensed electrician.

PRODUCT OPTIONS

Length	Country of Installation
120, 144	A Canada/U.S.A.

SAMPLE ORDER CODE

EWCFCH 144	A
------------	---

DIMENSIONS INCHES / MM

L
120 / 3048
144 / 3658

PRICING

199
242

The Storage Power Harness carries power along the base of the cabinet to the Flush Mount Power & Data box or the Cubby Power Monument (EWQPM) in the storage unit.

EWBH

Storage Power Harness

WHAT'S INCLUDED

1 power harness.

NOTES

The 24" length is all mesh. Other lengths have mesh on both ends for maximum flexibility in a storage application.

To specify the correct length of power harness, determine the distance from the center of one cut out to the other, then add 24".

In order to plug into a Cubby Power Monument (EWQPM), a Four-Way Splitter (EWDB) or an I-Connector (EWIC) must be specified separately.

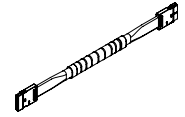

PRODUCT OPTIONS

Wire System	Length	Country of Installation	PVC Free
8T 8-Wire Isolated Ground	24, 48, 72, 96, 120, 144	A Canada/U.S.A.	~ Standard
8K 8-Wire Dual Isolated			V PVC Free

SAMPLE ORDER CODE

EWBH 8K	72	A	V
----------------	-----------	----------	----------

**DIMENSIONS
INCHES / MM**

L
24 / 610
48 / 1219
72 / 1829
96 / 2438
120 / 3048
144 / 3658

PRICING

8-WIRE DUAL ISOLATED (8K)

Standard	PVC Free (V)
170	208
259	311
290	350
354	424
416	500
476	572

8-WIRE ISOLATED GROUND (8T)

Standard	PVC Free (V)
153	191
235	282
263	318
322	385
378	454
432	519

EWDB

4-Way Splitter

The Four-Way Splitter attaches to a harness to split power at floor level.

WHAT'S INCLUDED

1 four-way splitter and hardware.

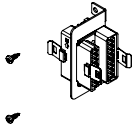

EWIC

I-Connector

The I-Connector is used to join two harnesses when a single harness length is not long enough.

WHAT'S INCLUDED

1 I-connector.



PRODUCT OPTIONS

Country of Installation

A Canada/U.S.A.

SAMPLE ORDER CODE

EWIC A

EWDB FOUR-WAY SPLITTER

142

EWIC I-CONNECTOR

44

EWQP

Flush Mount Power & Data

The Flush Mount Power & Data is a module that mounts to the back of a case where a drawer is located. This allows for accessibility of power and data from the back side of a storage unit.

WHAT'S INCLUDED

Base Height: 1 power box, faceplate, back cover, mounting hardware.

Beltline Height: 1 power box, faceplate, back cover, mounting hardware, four-way splitter, 1 power harness (to cover vertical distance to base).

WHAT'S EXCLUDED

Receptacle Outlets (EWRO) must be specified separately. Can be found in this section.

Data and communication must be sourced separately.

NOTES

Flush Mounted Power & Data (EWQP) units can also mount to the back cubby of a Pedestal or Pedestal Tower.

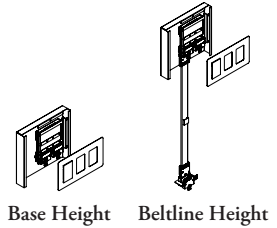

PRODUCT OPTIONS

Power Location	Wire System	Country of Installation	Bezel Finish	PVC Free
B Base Height	8T 8-Wire Isolated Ground	A Canada/U.S.A.	YY Ebony	~ Standard
E Beltline Height	8K 8-Wire Dual Isolated		YF Storm White	V PVC Free
			YN Platinum Grey Coordinate	
			YV Very White	

SAMPLE ORDER CODE

EWQP B	8K	A	YF	V
---------------	-----------	----------	-----------	----------

POWER LOCATION

PRICING

	Standard	PVC Free (V)
B	461	556
E	640	769

EWQPCH

Chicago Flush-Mounted Power Box

The Chicago Flush-Mounted Power and data is a module mounted to the back of a case where a drawer is located. This allows for accessibility of power and data from the back side of a storage unit.

WHAT'S INCLUDED

Base Height: 1 power box, faceplate, back cover, mounting hardware.

Beltline Height: 1 power box, faceplate, back cover, mounting hardware, four-way splitter, 1 power harness (to cover vertical distance to base), 1 receptacle outlet.

NOTES

Data and communications must be sourced separately.

Chicago electrics wiring restrictions require that all wiring and connections be supplied and connected by a licensed electrician.



PRODUCT OPTIONS

Power Location	Receptacle Style	Country of Installation	Bezel Finish (Standard 15 amp only)
B Base Height	S Standard 15 amp	A Canada/U.S.A.	YY Ebony
E Beltline Height	T T-Slot 20 amp		YF Storm White
			YN Platinum Grey Coordinate

SAMPLE ORDER CODE

EWQPCH B	T	A	YF
-----------------	----------	----------	-----------

POWER LOCATION

B
E

PRICING

Standard (S)	T-Slot (T)
469	483
512	526

The Storage Receptacle Outlet is a single duplex receptacle that fits into a Flush Mount Power & Data module to provide power used with electrified storage.

WHAT'S INCLUDED

Receptacle outlet.

NOTES

T-Slot (T) Receptacle Style is finished in Ebony.

If Receptacle Style USB 5 VDC 2.1 Amp (U) is selected, Circuits 2, 3, 5 and 6 are not available.

EWRO
Storage Receptacle Outlet



Standard 15 Amp T-Slot 20 Amp

PRODUCT OPTIONS

Receptacle Style	Outlet Configuration	Country of Installation	Receptacle Finish (standard 15 amp only)
D Controlled 15 amp	1 Circuit 1	A Canada/U.S.A.	YY Ebony YF Storm White YN Platinum Grey Coordinate YV Very White Coordinate
E Controlled 20 amp	2 Circuit 2		
S Standard 15 amp	3 Circuit 3 (use with 8T only)		
T T-Slot 20 amp	5 Circuit 5		
U USB 5 VDC 2.1 Amp	6 Circuit 6 (use with 8K only)		
	A Non Isolated Ground Circuit (use with 7T and 7K only)		
	B Non Isolated Ground Circuit (use with 7K only)		

SAMPLE ORDER CODE

EWRO S	6	A	YF
---------------	----------	----------	-----------

RECEPTACLE STYLE

PRICING

S	36
T	44
U	179

EWQPM

Cubby Power Monument

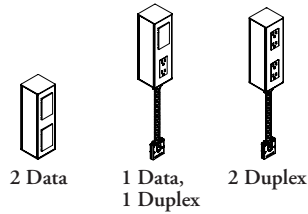

The Cubby Power Monument provides access to power and data in open cubby sections of credenzas or the back cubby sections of pedestals and pedestal towers.

WHAT'S INCLUDED

1 power box, mounting hardware, receptacles (if specified).

WHAT'S EXCLUDED

Data and communications must be sourced separately.

NOTES

T-Slot 20 amp receptacle style is finished in Ebony.

Cubby Power Monument must plug directly into a Four-Way Splitter (EWDB) or an I-Connector (EWIC). It plug directly into a Storage Power Harness (EWBH).

Configuration	Outlet	Wire System
PP	11, 12, 13, 15, 22, 23, 25, 33, 35, 55	For 8T
PP	11, 12, 15, 16, 22, 25, 26, 55, 56, 66	For 8K
DP	1, 2, 3, 5	For 8T
DP	1, 2, 5, 6	For 8K
DD	n/a	

PRODUCT OPTIONS

Configuration	Wire System	Receptacle Style	Outlet Configuration	Country of Installation	Finish (standard 15 amp only)	PVC Free
DD Two Data	8T 8-Wire Isolated Ground 8K 8-Wire Dual Isolated	S Standard 15 amp	1, 2, 3, 5, 6, 11, 12, 13, 15, 16, 22, 23, 25, 26, 33, 35, 55, 56, 66	A Canada/U.S.A	YY Ebony	~ Standard
DP One Duplex, One Data		T T-Slot 20 amp			YF Storm White	V PVC Free
PP Two Duplexes					YN Platinum Grey Coordinate	

SAMPLE ORDER CODE

EWQPM PP	8K	S	11	A	YF	V
-----------------	-----------	----------	-----------	----------	-----------	----------

RECEPTACLE STYLE

n/a

PRICING

TWO DATA (DD)

Standard

526

ONE DUPLEX, ONE DATA (DP)

8-WIRE DUAL ISOLATED (8K)

Standard PVC Free (V)

782 867

788 874

8-WIRE ISOLATED GROUND (8T)

Standard PVC Free (V)

738 824

745 831

TWO DUPLEXES (PP)

8-WIRE DUAL ISOLATED (8K)

Standard PVC Free (V)

797 880

810 895

8-WIRE ISOLATED GROUND (8T)

Standard PVC Free (V)

755 839

767 853

The Chicago Cubby Power Monument provides access to power and data in open cubby sections of credenzas or the back cubby sections of pedestals and pedestal towers.

WHAT'S INCLUDED

1 power box, mounting hardware, receptacles (if specified).

NOTES

T-Slot 20 amp receptacle style is finished in Ebony.

Chicago Cubby Power Monument (EWQPMCH) includes a 3-wire. No connector is provided on the bottom end due to Chicago electrics wiring restrictions.

Chicago electrics wiring restrictions require that all wiring and connections be supplied and connected by a licensed electrician.

EWQPMCH
Chicago Cubby Power Monument

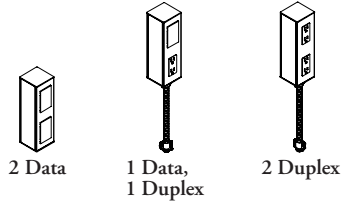

PRODUCT OPTIONS

Configuration	Receptacle Style	Country of Installation	Finish (standard 15 amp only)
DD Two Data	S Standard 15 amp	A Canada/U.S.A.	YY Ebony
DP One Duplex, One Data	T T-Slot 20 amp		YF Storm White
PP Two Duplexes			YN Platinum Grey Coordinate

SAMPLE ORDER CODE

EWQPMCH PP	S	A	YF
-------------------	----------	----------	-----------

RECEPTACLE STYLE

n/a
S
T
S
T

PRICING

TWO DATA (DD)	526
ONE DUPLEX, ONE DATA (DP)	654
	668
TWO DUPLEXES (PP)	668
	682

EWEP

Storage Power Pole

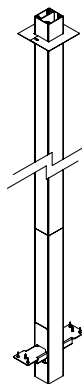

The Storage Power Pole houses the Storage Ceiling Feed and divides the ceiling feed from communication and data cables. It is used to feed power and data to the underside of the storage units.

WHAT'S INCLUDED

1 base power pole, one upper power pole, ceiling plate, 1 or 2 storage connector (as specified), mounting brackets.

WHAT'S EXCLUDED

Storage Ceiling Feed (EWCF) and Storage Chicago Ceiling Feed (EWCFCH) must be purchased separately.

NOTES

The Storage Power Pole (EWEP) can route power and data to two storage units.

PRODUCT OPTIONS

Height	Direction	Finish
08, 10	1 One-Sided 2 Two-Sided	Foundation Mica

SAMPLE ORDER CODE

EWEP 10	1	7
---------	---	---

DIMENSIONS FEET

H
8
10

PRICING

ONE-SIDED (1)	TWO-SIDED (2)
880	1011
910	1037

UNQPC

Power Conservation System

Power Conservation system provides an automatically turn off to items like task lights, monitors, personal heaters and fans and other non-essential user equipment when they are not in use.

WHAT'S INCLUDED

Power conservation system consists of a control box, selected number of sensors, system connection brackets, connecting cables and a four-way splitter.

NOTES

Timer is set for 20 minutes for automatic shut-off after area is unoccupied. System sensors are available in Black only. Sensor connection wires are available in Grey and White only. System control box is available in Platinum (Foundation) only. Each Control Box offers two separate output jack for connection of Occupancy Sensors. The first output jack controls power to all receptacles on Teknion Circuit 1 and the second output jack controls power to all receptacles on Teknion Circuit 2. Each of the output jacks is labeled on the control box.

Do not specify receptacles for circuits 1 and 2 at the same workstation when using Power Conservation System.

Each occupancy sensor can only control one circuit.

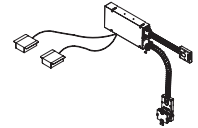

PRODUCT OPTIONS

Application	Sensors
D Interior of Panel for Back to Back Installation	2 Two 4 Four 8 Eight

SAMPLE ORDER CODE

UNQPC D	2
---------	---

PRICING

Two Sensors	Four Sensors	Eight Sensors
1604	1975	2718

UNDG

Diecast Grommet

The Diecast Grommet is designed for the round cut outs to be place on center, left or right locations on the worksurface.

WHAT'S INCLUDED

2 piece round grommet. Data cable nest which accommodates cables up to CAT 6 (approx 0.25").

NOTES

The Die Cast Grommets must be specified separately. A cut out must be specified on the related worksurface. The grommet can be applied to any Teknion District worksurface thickness with a grommet cut out specified. Pass through accommodates power cables up to 0.5" thick. Grommet can be finished in a Foundation, Mica or Accent finish.



PRODUCT OPTIONS

Grommet Type	Finish
1 Round	Foundation Mica Accent

SAMPLE ORDER CODE

UNDG 1	25
--------	----

PRICING

41

international electricians

international electric product map

VED Outlet Box

Page 914

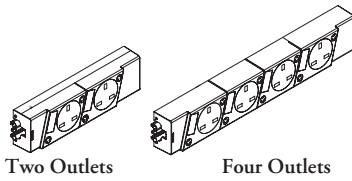

VCC Interconnecting Power Cable

Page 915



VEP Input Power Cable

Page 916

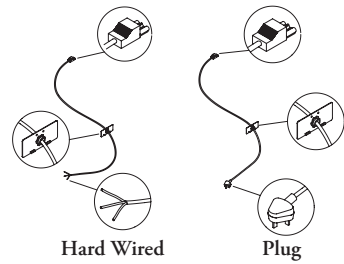

VVD Voice & Data Box

Page 917

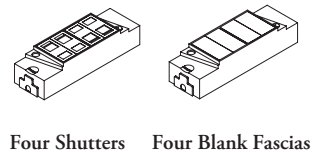

VDO Voice & Data Outlets

Page 918

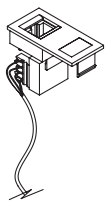

VAC Electric Accessories

Page 919

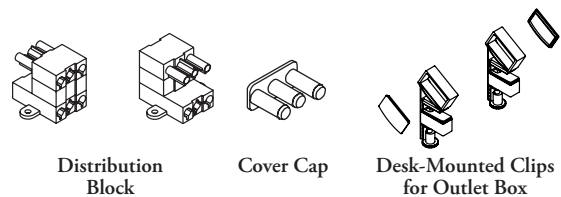

UNXSE Screen Mount Outlet Box Bracket

Page 920

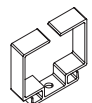

UNXPFR Base Feed Mounting Kit

Page 920

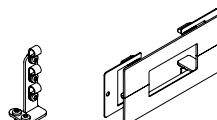

international electric product map

UNXBR Panel Mount Outlet Box Bracket

Page 921

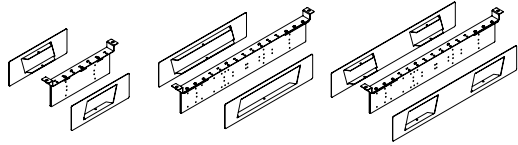

VB CD CALA Power Module

Page 922



VB PD CALA Power In Feed

Page 923

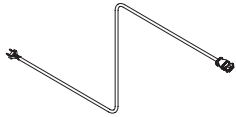

VB PH CALA Jumper Power Harness

Page 924

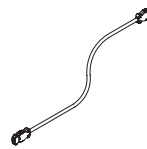

VB WB CALA Power Station

Page 925



VED Outlet Box

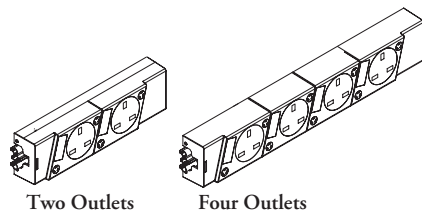

The Outlet Box provides access to power at worksurface height.

WHAT'S INCLUDED

1 outlet box.

WHAT'S EXCLUDED

Desk-Mounting Clip (VACB6) – Required if desk-mounting option is desired.

Panel Mount Outlet Box Bracket (UNXB) – Required for application to a Panel Wall.

Screen-Mount Outlet Box Bracket (UNXSE) – Required for application to a screen.

NOTES

Socket angles will always be 15°.

UPS option is only available with UK Outlets (G).

PRODUCT OPTIONS

Number of Outlets	Power Type	Fuse & Switch Option	Mounting Bracket	Country of Installation
2 Two Outlets	S Standard	N No Fuse and Switch	N None	F Germany
4 Four Outlets	U UPS	M Master Fuse and Master Switch	P Panel Mount for T/O/S or Transit	G U.K./Ireland
		S Individual Fuse and Individual Switch	E Panel Mount for Leverage (Shown)	I Australia and Argentina

SAMPLE ORDER CODE

VED 2	S	M	E	F
-------	---	---	---	---

NUMBER OF OUTLETS

2
4

PRICING

NO PANEL MOUNT (N)

No Fuse and Switch (N)	Master Fuse and Master Switch (M)	Individual Fuse and Individual Switch (S)
104	160	207
193	266	326

WITH PANEL MOUNTS (P, E)

No Fuse and Switch (N)	Master Fuse and Master Switch (M)	Individual Fuse and Individual Switch (S)
145	201	248
232	306	364

The Interconnecting Power Cable routes power between Outlet Boxes in Panel Wall access areas and also carries power through the adjacent Panel Wall.

VCC

Interconnecting Power Cable

WHAT'S INCLUDED

1 interconnecting power cable.

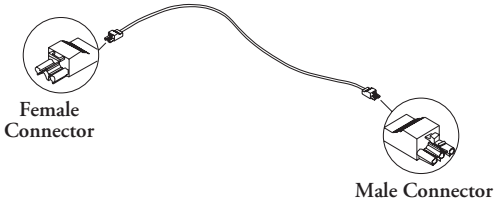

PRODUCT OPTIONS

Length	Power Type
10 One Meter	S Standard
20 Two Meters	U UPS
30 Three Meters	

SAMPLE ORDER CODE

VCC 10	U
--------	---

DIMENSIONS

L
10
20
30

PRICING

71
82
101

VEP

Input Power Cable

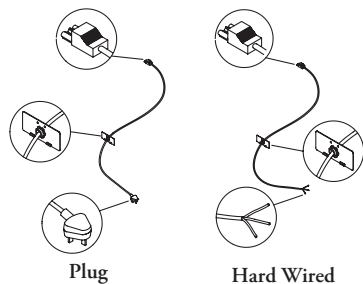

The Input Power Cable brings power from the building ceiling, wall or floor into the Panel Wall.

WHAT'S INCLUDED

1 input power cable with strain relief.

WHAT'S EXCLUDED

Base Feed Mounting Kit (UNXPF) – Required for installation at the base.

PRODUCT OPTIONS

Length	Plug Type	Power Type	Country of Installation (For Plug Type)
10 One Meter	H Hard Wired	S Standard	F Germany
20 Two Meters	P Plug	U UPS	G U.K./Ireland
30 Three Meters			I Australia

SAMPLE ORDER CODE

VEP 10	P	S	G
---------------	----------	----------	----------

DIMENSIONS

L
10
20
30

PRICING

Hard Wired (H)	Plug (P)
79	118
109	149
125	161

The Voice & Data Box is designed to bring access to communications and data to the user.

VVD

Voice & Data Box

WHAT'S INCLUDED

1 Voice & Data Box, with a Blank or Shutter faces (as specified).

WHAT'S EXCLUDED

Voice & Data Outlets (VDO) with drop leads must be specified separately.

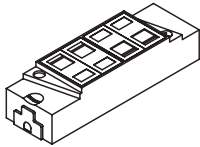

Four Shutters

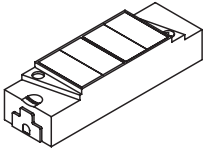

Four Blank Fascias

PRODUCT OPTIONS

Configuration	Shutter (If Applicable)
BBBB Blank Fascias	K Keystone A AT&T N Nordx
SSSS Four Shutters	

SAMPLE ORDER CODE

VVD BBBB	K
----------	---

CONFIGURATION

PRICING

BBBB	67
SSSS	81

V D O

Voice & Data Outlets

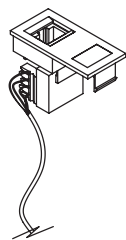

The Voice & Data Outlets are inserted into the Voice & Data Box (VVD).

WHAT'S INCLUDED

1 Voice or Data Outlet, with appropriate length drop lead (if specified).

WHAT'S EXCLUDED

Voice & Data Boxes (VVD) must be ordered separately.

NOTES

One must remove the blank facades in the boxes to allow placement of these items.

Drop Lead may be specified according to the size required.

PRODUCT OPTIONS

Outlet Type	Voice Outlet (Applies to Voice Outlet only)	Data Outlet	Drop Lead Option
V Voice D Data	01 RJ11	05 RJ45 Cat 5e Unshielded	N None 2 Two Meters 3 Three Meters 8 Eight Meters

SAMPLE ORDER CODE

VDO D	01	05	3
-------	----	----	---

OUTLET TYPE

V
D

PRICING

None (N)	Two Meters (2)	Three Meters (3)	Eight Meters (8)
69	78	81	118
69	133	137	193

Electric Accessories

The Distribution Block redirects power distribution. The Cover Cap is a safety cover for Outlet Boxes and Distribution Blocks. The Desk-Mounting Clips attach an Outlet Box to a desk or worksurface.

WHAT'S INCLUDED

1 distribution block or one Cover Cap or 1 pair of Desk-Mounting Clips for Outlet Box.

WHAT'S EXCLUDED

Outlet Box and all Interconnecting and Power Input Cables must specified separately.

NOTES

The Distribution Block has one male connector that directs power in and three female connectors that direct power out.

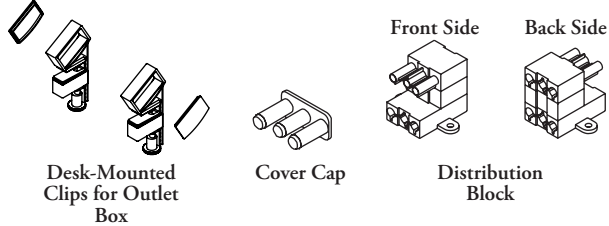

PRODUCT OPTIONS

Accessory Type		Power Option (For Distribution Block)
EB	Distribution Block	S Standard
EC	Cover Cap	U UPS
B6	Desk-Mounted Clips for Outlet Box	

SAMPLE ORDER CODE

VAC EB	S
---------------	----------

ACCESSORY TYPE

PRICING

EC	11
B6	66
EB	116

UNXSE

Screen Mount Outlet Box Bracket

The Screen Mount Outlet Box Bracket mounts any size Outlet Box or a Voice & Data Box to a Screen, Modesty Panel or underside of a worksurface.

WHAT'S INCLUDED

2 brackets, attachment hardware.

NOTES

Bracket fits all outlet configurations.

Finished in Black.

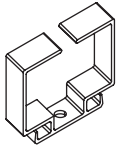

PRICING

25

UNXPR

Base Feed Mounting Kit

The Base Feed Mounting Kit provides panel entry to input power cables (up to 3) or voice/data cables to panel wall at input point.

WHAT'S INCLUDED

1 mounting kit, bracket, attachment hardware, cover plate.

NOTES

Finished in Platinum.

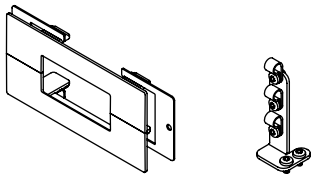

PRICING

75

The Panel Mount Outlet Box Bracket provides attachment of an Outlet Box (VED) and Voice & Data Box (VVD) to a panel wall.

U N X B R

Panel Mount Outlet Box Bracket

WHAT'S INCLUDED

1 bracket set, attachment hardware, 1 or 2 faceplates (as specified).

WHAT'S EXCLUDED

Outlet Box (VED) or Voice & Data Box (VVD) must be specified separately.

NOTES

Bracket can be used above or below worksurface height and in single- or double-sided applications.

Finished in Ebony.

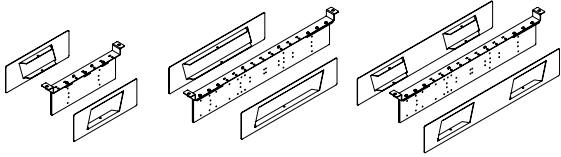

PRODUCT OPTIONS

Outlet Configuration	Faceplate Option
2 Two Power Outlets 3 Two Power Outlets, One Data Box 4 Four Power Outlets	A One face plate per single-sided application B Two face plates per double-sided application

SAMPLE ORDER CODE

UNXBR 2	A
----------------	----------

OUTLET CONFIGURATION

PRICING

2	127
3	268
4	268

V B C D

CALA Power Module

The CALA Power Modules provides one or two duplexes embedded to the District panel. CALA power and data can be specified on a single side or back to back in the panel.

WHAT'S INCLUDED

1 power module, mounting brackets and connection hardware

NOTES

Power module and element bezel are available in a Very White and Black finish.

Receptacle finish will automatically match the finish option selected.



PRODUCT OPTIONS

Application	Outlet Configuration	Country of Installation	Length	Receptacle Finish
DA Double Duplex, One Sided	003 Three Data	R Argentina	120	YY Ebony Coordinate YV Very White Coordinate
DB Double Duplex, Back-to-Back	200 Two Power	N Brazil		
SA Single Duplex, One Sided	120 One Power and One USB	L Chile		
SB Single Duplex, Back-to-Back	203 Two Power and Three Data			
	400 Four Power			
	320 Three Power and One USB			

SAMPLE ORDER CODE

VBCD DB	320	N	120	YY
----------------	------------	----------	------------	-----------

APPLICATION	PRICING					
	Three Data (003)	Two Power (200)	One Power and One USB (120)	Two Power and Three Data (203)	Four Power (400)	Three Power and One USB (320)
DA	n/a	n/a	n/a	299	441	602
DB	n/a	n/a	n/a	542	834	1094
SA	107	250	398	n/a	n/a	n/a
SB	170	455	747	n/a	n/a	n/a

The Power In feed cable brings power from the building to the panel. It can be installed in the base opening of the panel to feed power up to the CALA power module. It can also be brought down from the ceiling to the workstation.

V B P D
CALA Power In Feed

WHAT'S INCLUDED

1 input power cable, 1800mm in length

NOTES

Country of Installation is required to determine correct source plug in option is chosen.

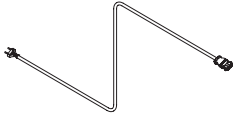

PRODUCT OPTIONS

Length	Country of Installation
18 1800 mm	R Argentina N Brazil L Chile

SAMPLE ORDER CODE

VBPD 18	R
---------	---

PRICING

319

VBPH **CALA Jumper Power Harness**

The Jumper Power Harness routes power between CALA Power Modules in panel access areas and also carries power through the adjacent panel.

WHAT'S INCLUDED

1 interconnecting power cable, 2000 mm in length



PRODUCT OPTIONS

Length

20 2 Meters

SAMPLE ORDER CODE

VBPH 20

PRICING

146

The CALA power station is designed to provide casual power/data at the worksurface level. It is designed to affixed to the edge of the worksurface.

VBWB

CALA Power Station

WHAT'S INCLUDED

1 CALA power station, 1800mm in length. Fronts and sides are finished with selected finish. Rear and Desk Edge Clamp are in Clear Anodized only.

NOTES

Each power station will include an extension plate so that it can be outfitted to a knife edge trim surface Enclosure and Connection clamp is available in Clear Anodized Aluminum finish only.



PRODUCT OPTIONS

Numbers of Outlets	Outlet Configuration	Country of Installation	Cable Length	Receptacle Finish
D Double Outlet	202 Two Power and Two Data	R Argentina	18 1800mm	YY Ebony Coordinate
	400 Four Power	N Brazil		YV Very White Coordinate
	320 Three Power and One USB	L Chile		

SAMPLE ORDER CODE

VBWB D	320	N	18	YY
---------------	------------	----------	-----------	-----------

OUTLETS

PRICING

	Two Power and Two Data (202)	Four Power (400)	Three Power and One USB (320)
D	682	878	1039

teknion

www.teknion.com

IN CANADA:

1150 Flint Road
Toronto, Ontario
M3J 2J5 Canada
Tel 866.teknion
866.835.6466

IN THE USA:

350 Fellowship Road
Mt Laurel, New Jersey
08054 USA
Tel 877.teknion
877.835.6466

OTHER OFFICES LOCATED IN:

Europe, South and Central America
Middle East, Asia and Russia
For regional contact information
go to www.teknion.com

CAN/US/INT 02-28

©Teknion 2022

®, ™ trade marks of Teknion
Corporation and/or its subsidiaries or
licensed to it. Patents may be pending.

Some products may not be available
in all markets. Contact your
local Teknion Representative for
availability.

MAY22-DIS