

pod (europe)

application guide

10.28.2024

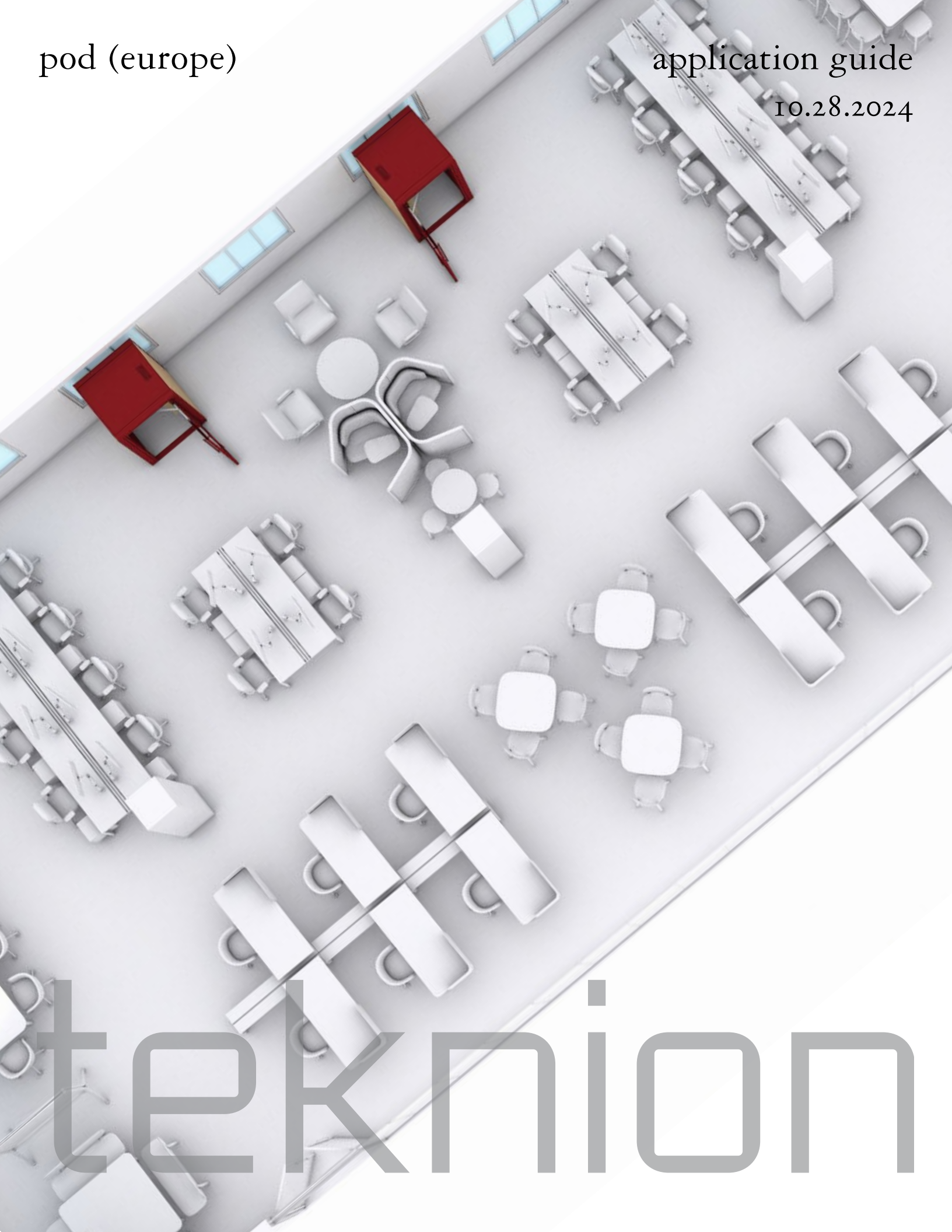

teknion

what is pod

what is pod

POD (*Privacy on Demand*) is a family of products that are designed for occasional, short-duration privacy from the open plan. It supports technology and helps shape an environment where people want to work and where they feel comfortable and connected. POD's freestanding design enables relocation and independence from building architecture, meeting company needs as they evolve.

The POD product line consists of Tek Booth, Tek Room and Tek Work. Both solutions work together to create a diverse range of small scale private environments within the open office. POD is backed by Teknion's impressive finish program to allow endless color palette combinations that suit any environmental aesthetic.



what is pod

office placement

Below describes the two core planning concepts in relation to POD and the open office.

perimeter planning

POD can be placed along exterior and interior building walls. When planning against windows consider POD's with a glass back to maintain light transmission. When planning against drywall consider POD's with a solid or frosted glass back to hide any exposed power cords.

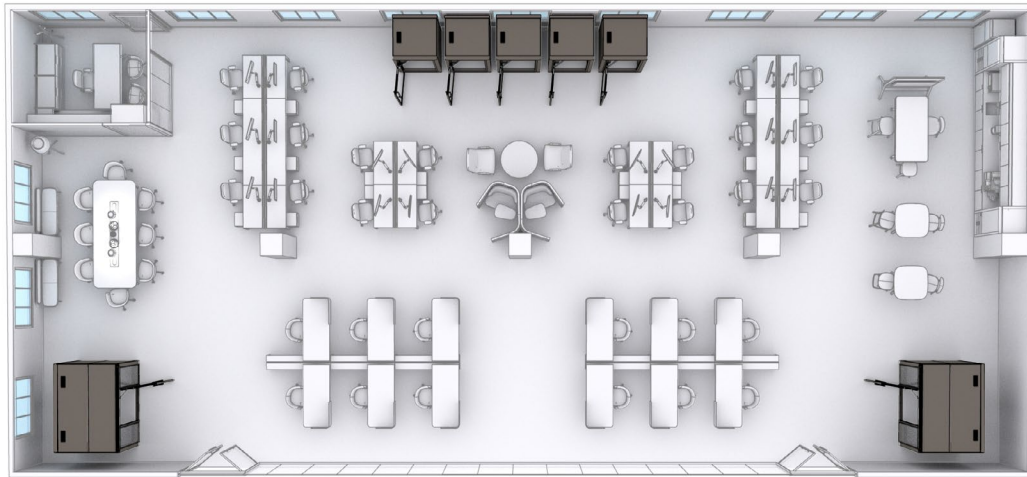

centralized planning

POD can be placed amongst furniture and workstations while acting as a space division element. When centrally planning consider POD's with a glass back to maintain light transmission. Consider a solid or frosted glass back for increased visual privacy.

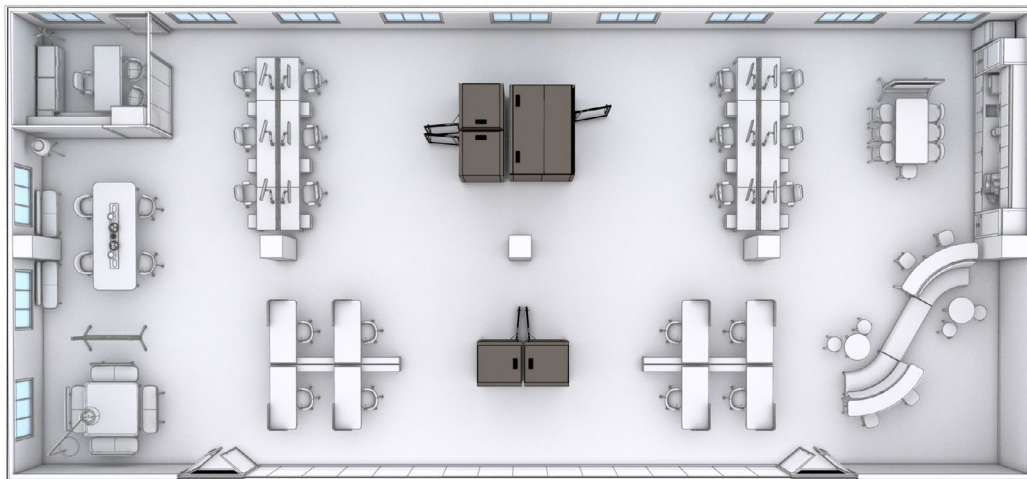

office placement (continued)

The following guidelines help ensure proper airflow and light sensor operation for the Tek Booth and Tek Room.

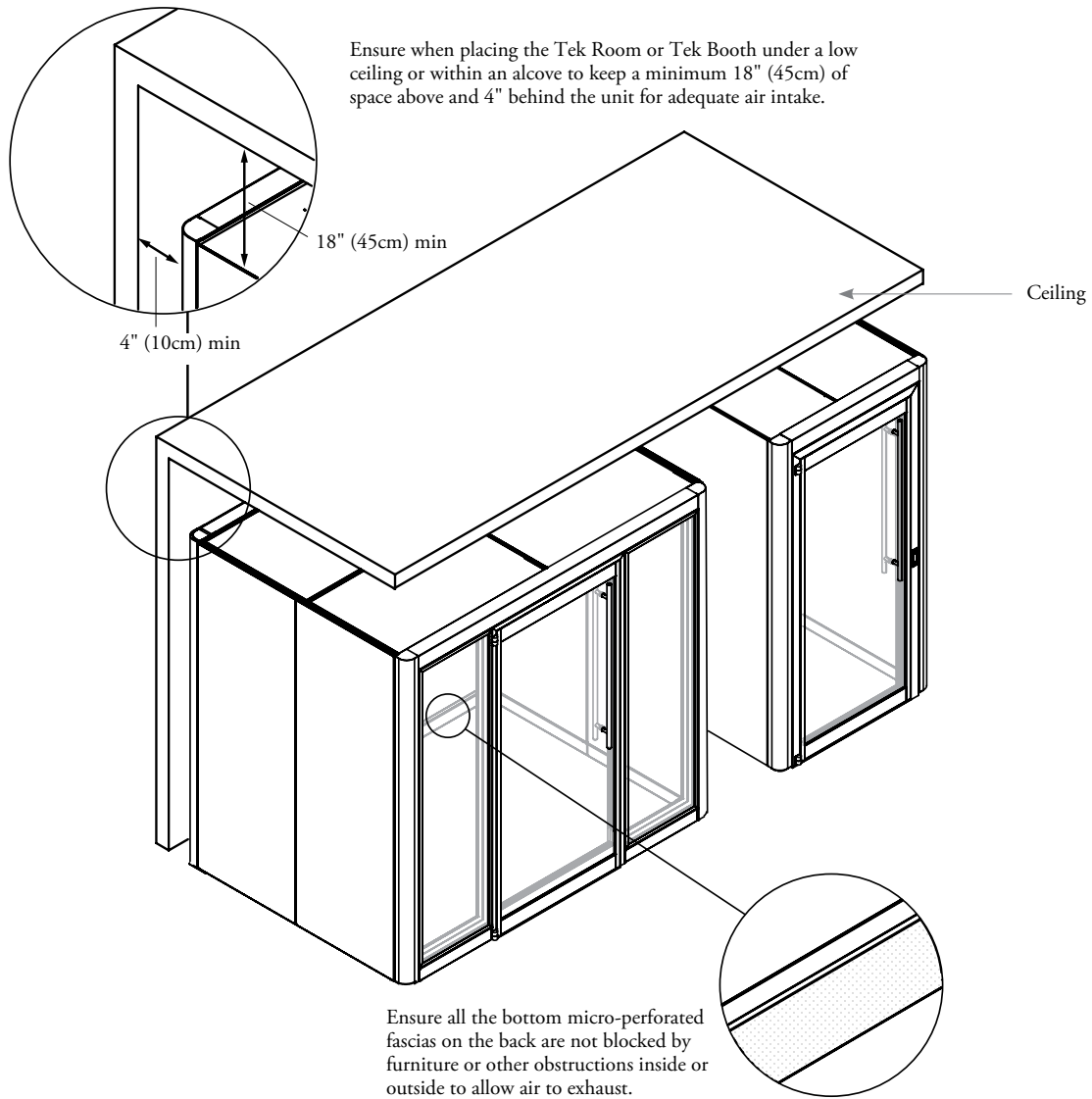

The light sensor responds to temperature changes and care should be taken when placing the Tek Room and Tek Booth within a space.

DO NOT place Tek Booth or Tek Room directly below or facing direct sunlight or a heating and cooling source, or in a location where hot or cold drafts will blow directly on the sensor.

application guide

application guide

PRODUCT MAPS	12
POD OVERVIEW	16
TEK BOOTH	25
TEK WORK	51
TEK ROOM	75

tek booth

EFTBSG Tek Booth
Structure for Glass
Back

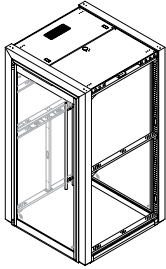

EFTBSO Tek Booth
Structure for Solid
Back

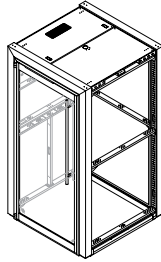

EFTBE Tek Booth Exterior



EFTBIT Tek Booth Interior
Glass & Solid Back
Booth

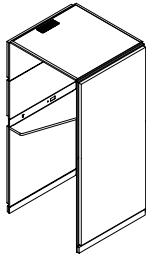

EFTBEG Tek Booth
Electrical Power
Kit Plug-In

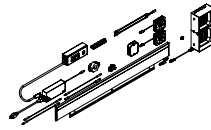

ELFTBNBM Powerbar for
Tek Booth

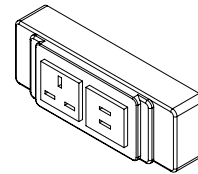

ELFTBEF Tek Booth
Electrical Fascia

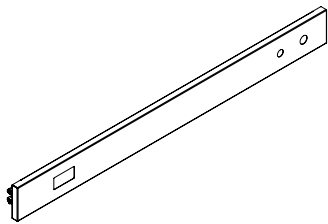

EFTPAK Tek Booth
Universal
Automated Door
Hardware Kit

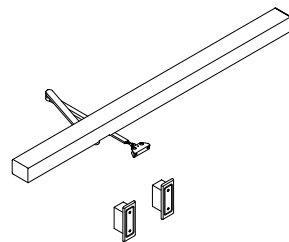

tek room

E F T R G Tek Room Structure for Glass Back

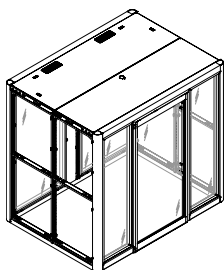

E F T R S Tek Room Structure for Solid Back

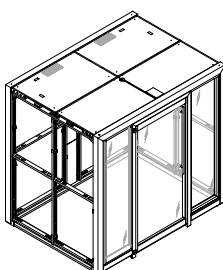

E F T R I Tek Room Interior for Glass and Solid Back

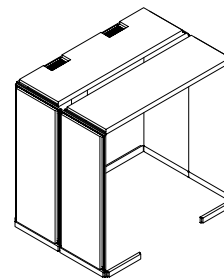

E F T R E Tek Room Exterior

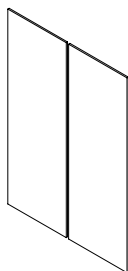

E F T R S W Tek Room Side Worksurface

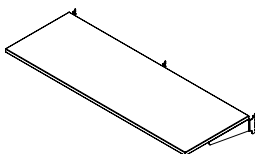

E F T R C W Tek Room Center Worksurface

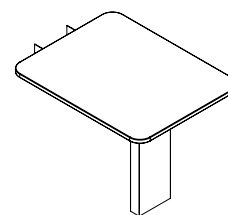

E F T R E P Tek Room Electrical Kit, Plug-In

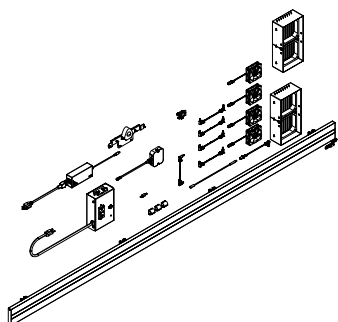

E F T R H Tek Room Coat / Bag Hook

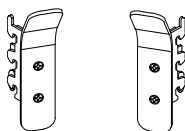

E F T R F Tek Room Vertical Technology Fascia



E F T R T Tek Room Tape Strip



E L F T R N B M Powerbar for Tek Room

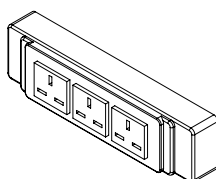

E L F T R N B L Netbox Style for Tek Room Worksurface

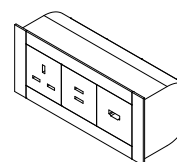

tek work

E F T W G Tek Work Structure
for Glass Back

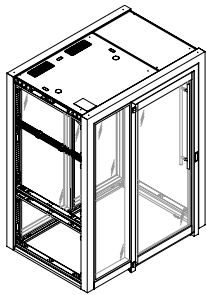

E F T W S Tek Work Structure
for Solid Back

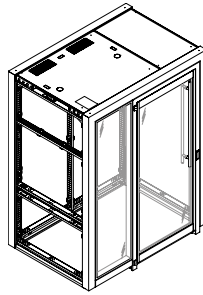

E F T W I F Tek Work Interior
for Fixed or No
Worksurface

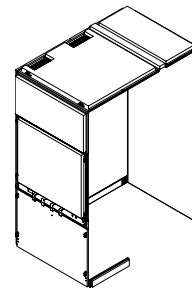

E F T W I H Tek Work
Interior for
Height-Adjustable
Worksurface

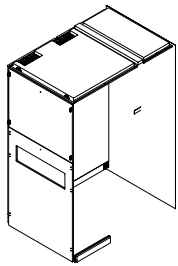

E F T W E Tek Work Exterior

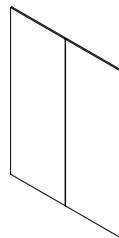

E F T W H A Tek Work
Height-Adjustable
Worksurface
Assembly

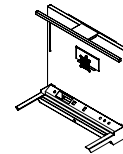

E F T W H W Tek Work
Height-Adjustable
Worksurface

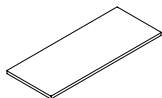

E F T W F W Tek Work Fixed
Worksurface

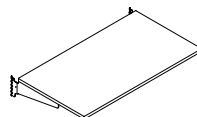

E F T W E P A Tek Work
Electrical Power
Kit for Height-
Adjustable
Worksurface
Plug-In

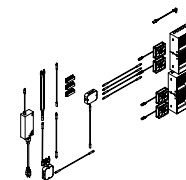

E F T W E P F Tek Work
Electrical Power
Kit for Fixed or
No Worksurface
Plug-In

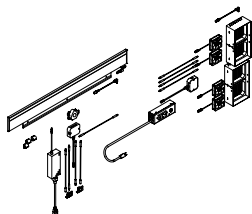

E L F T W E F Tek Work
Electrical Fascia
for Fixed or No
Worksurface

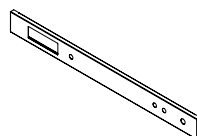

E L F T W N B M Powerbar for
Tek Work for
Height-
Adjustable

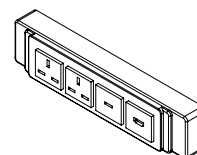

E L F T W N B W Powerbar for
Tek Work for
Fixed or No
Worksurface

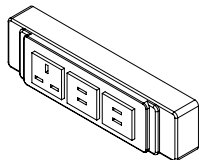

pod overview

The POD series consists of three size options, the Tek Booth, Tek Work and Tek Room. Each have features in common in addition to some Distinct options for each size. Review the basic functionality of each option below.



Tek Booth

Use Case: Ideal for short meetings and phone calls.
Exterior Footprint: 48" (122cm) D x 48" (122cm) W x 90" (228cm) H
Users : 1



Tek Work

Use Case: Ideal for extended periods of focus work and video calls.
Exterior Footprint: 48" (122cm) D x 70-1/8" (178cm) W x 90" (228cm) H
Users : 1



Tek Room

Use Case: Ideal for small team meetings.
Exterior Footprint: 70-1/8" (178cm) D x 96-1/4" (244cm) W x 90" (228cm) H
User: 2-4

application guide

pod door features

The Framed Pivot Door provides an acoustic barrier, reducing noise inside the booth. Below describes the details and features of the door.



Ladder Pull

- 1" (2.54cm) tube diameter
- Non-locking only

Magnetic Catch

- Ensures seal with door frame

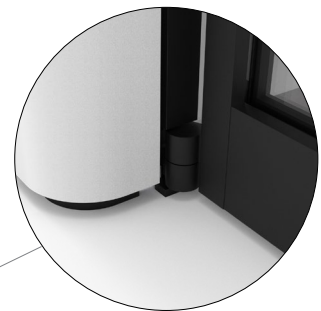

Pivot Hinge

- Two pivot points (top and bottom)
- Visible on exterior of booth
- Attached to vertical door jamb

pod door features (continued)



Pivot Hinge

- Two pivot points (top and bottom)
- Visible on exterior of room
- Attached to vertical door jamb



Door Closer with Hold Open

- Hold open range: 90° - 100°
- Adjustable speed
- No door stopper required on floor
- Black finish standard

pod door features (continued)

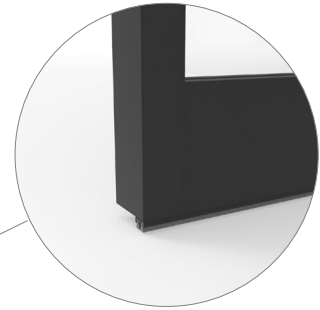

Bottom Seal

- Adjustable brush pile
- Continuous width across door

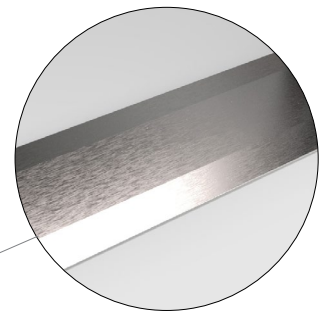

Threshold

- Stainless steel construction
- Provides lateral structure

pod door features (continued)



Fire Suppression Prep

The micro-perforated ceiling fascia comes standard with a punch out prep for easy sprinkler installation.



Tek Booth can be retrofitted with sprinklers if required, but are not included as standard.



Coat / Bag Hook

A coat / bag hook can be placed in the interior back corner of the booth, opposite of the worksurface. It can be installed at any height (in 1" (2.54cm) increments).

pod door features (continued)



Round Corner Trim

The round corner trim option provides a soft exterior aesthetic. The vertical and horizontal trim components meet at a butt joint.

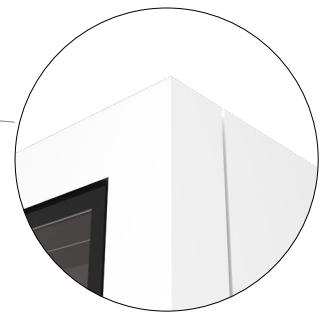

Square Corner Trim

The square corner trim option provides a rectilinear exterior aesthetic. The vertical and horizontal trim components meet at a miter joint.

pod door orientation

POD's orientation is determined by the location of the pivot door as viewed from the front exterior. POD's door pivots open to the exterior only.

Tek Booth



Left Orientation
Door swing direction is
left hand reversed



Right Orientation
Door swing direction is
right hand reversed

Tek Work



Left Orientation
Door swing direction is
left hand reversed



Right Orientation
Door swing direction is
right hand reversed

Tek Room



Left Orientation
Door swing direction is
left hand reversed



Right Orientation
Door swing direction is
right hand reversed

tek booth

tek booth

WHAT IS TEK BOOTH.	28
TEK BOOTH HOW TO ORDER A COMPLETE PACKAGE	30
TEK BOOTH FINISH REGIONS GLASS BACK	31
TEK BOOTH FINISH REGIONS SOLID BACK	32
TEK BOOTH SIZE & DIMENSIONS.	33
TEK BOOTH ORIENTATION	34
TEK BOOTH FASCIA FEATURES	35
TEK BOOTH FINISH FEATURES	36
TEK BOOTH DOOR FEATURES	37
TEK BOOTH AUTOMATED DOOR FEATURES	40
TEK BOOTH INTERIOR FEATURES	42
TEK BOOTH EXTERIOR FEATURES	45
TEK BOOTH SEATING RECOMMENDATIONS.	46
TEK BOOTH PLANNING WITH ELECTRICS.	47

what is tek booth

The following outlines the key concepts behind Tek Booth.



Individual Privacy

Tek Booth is designed to support the individual when focus, privacy and comfort are needed from the open plan environment. Hard external surfaces ensure sound isolation, while fabric and micro-perforated fascias on the interior minimize sound reflectivity.

Fine Tuned Interior

Tek Booth's interior fully integrates power, technology and ergonomics for an overall intuitive experience. Equipped with an angled worksurface, power receptacles, and a motion sensor that activates a dimmable task light and ventilation fans, Tek Booth is a space to feel comfortable and connected.

Space Efficiency

Tek Booth's small footprint allows for seamless integration into any environment. Its minimal size can be easily multiplied on various floor plans, ensuring office productivity is fully optimized.

tek booth basics

Tek Booth is comprised of four or six distinct top level codes that must be specified individually to create a complete booth. The booth can be specified to have numerous finish coordinations creating a limitless palette.

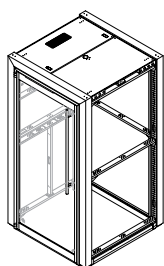

Structure for Solid Back (EFTBSO)

- Includes structural steel frame, corner trims, door frame, door leaf, door pull, exterior base fascia and threshold
- Corner Trim: Square or Round
- Door Orientation: Left or Right
- Door Glass Finish: Clear
- Frame Finish: Ebony or Anthracite
- Corner Trim Finish: Foundation, Mica or Accent
- Electrical Feed: Base or Ceiling
- Door Control: Closer with Hold-Open or Automated or Automated Accessible

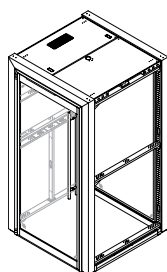

Structure for Glass Back (EFTBSG)

- Includes structural steel frame, corner trims, door frame, door leaf, door pull, exterior base fascia, back side glass fascia and threshold
- Corner Trim: Square or Round
- Door Orientation: Left or Right
- Door Glass Finish: Clear
- Back Wall Glass Finish: Clear or Frosted
- Frame Finish: Ebony or Anthracite
- Corner Trim Finish: Foundation, Mica or Accent
- Electrical Feed: Base or Ceiling
- Door Control: Closer with Hold-Open or Automated or Automated Accessible

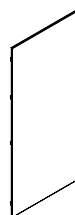

Exterior (EFTBE)

- Includes one exterior fascia
- Orientation: Left, Right or Back (must be specified individually)

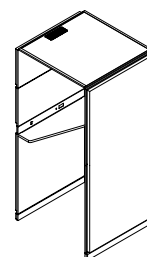

Interior for Glass & Solid Back Booth (EFTBIT)

- Includes interior base fascias, fabric fascias, ceiling fascia, worksurface and coat hook
- Orientation: Left or Right
- Metal Fascia Finish: Ebony or Anthracite
- Fabric Fascia Finish: Architectural fabrics
- Worksurface Finish: Veneer or Laminate
- Excluding electric fascia. To be purchase separately.

tek booth basics (continued)

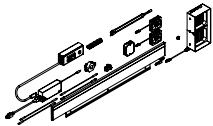

- Electrical Power Kit, Plug-In (EFTBEG)**
- Includes electrical components and task light
 - Wire type: Plug-in (15 Amp only)
 - Power Cord Lengths: 72" (183cm) or 180" (457cm)

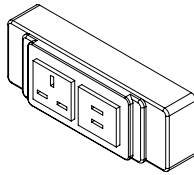

- Powerbar for Tek Booth (ELFTBNBM)**
- 2-Gang Netbox with connecting cables.

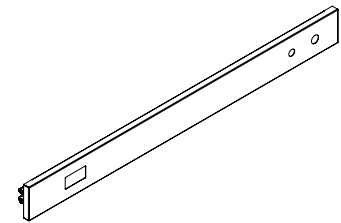

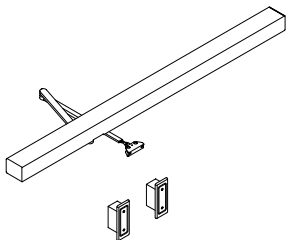

- Tek Booth Electrical Fascia (ELFTBEF)**
- Includes Electric Fascia with cut-out and mounting hardware.
 - Finish in ebony and anthracite



- Universal Automated Door Hardware Kit (EFTPAK)**
- Automated door operator and hand activator hardware kit
 - Works with plug-in electrical kit only

tek booth how to order a complete package

Tek Booth can be ordered with a glass back or solid back, with hardwire electrics, or plug-in. The following chart will help you select the appropriate items to order a full TekBooth package.

	Plug In Electrics
 <p>Tek Booth with Solid Back</p>	<ul style="list-style-type: none">• EFTBSO x1 (Structure for Solid Back)• EFTBIT x1 (Interior)• EFTBE x1 (Exterior, Left)• EFTBE x1 (Exterior, Right)• EFTBE x1 (Exterior, Back)• EFTBEG x1 (Plug-In Electrics)• ELFTBEF x1• ELFTBNBM x1
 <p>Tek Booth with Glass Back</p>	<ul style="list-style-type: none">• EFTBSG x1 (Structure for Glass Back)• EFTBIT x1 (Interior)• EFTBE x1 (Exterior, Left)• EFTBE x1 (Exterior, Right)• EFTBEG x1 (Plug-In Electrics)• ELFTBEF x1• ELFTBNBM x1

- For more details on how to specify this kit, please refer to *Planning with Electrics*

tek booth finish regions glass back

When Tek Booth Glass Back is being specified there are eleven finish regions to consider.



- 1 Door Frame, Door Leaf, Door Pull, Exterior Base Fascia, Glass Framing *
- 2 Door Threshold
- 3 Corner Trims
- 4 Interior Side Fascias (Acoustic Tackable)
- 5 Interior Base Fascias, Ceiling Fascia, Electrics Beam, Coat / Bag Hook, Worksurface Support *
- 6 Worksurface (Solid)
- 7 Left Side Exterior fascia (Solid)
- 8 Right Side Exterior fascia (Solid)
- 9 Back Fascia (Clear or Frosted Glass)
- 10 Door Insert (Clear Glass)
- 11 Task Light *

Finishes

- Metal painted finishes available in Foundation, Mica and Accent paint
- Certain finish regions only available in Ebony or Anthracite paints *
- Exterior fascias available in Foundation Laminate, Flintwood and Source Laminate
- Fabric Fascias are available in select Teknion Architectural Fabrics
- Worksurface finish includes Foundation Laminate, Source Laminate or Flintwood
- Threshold offered in Stainless finish as standard

tek booth finish regions solid back

When Tek Booth Solid Back is being specified there are eleven finish regions to consider.

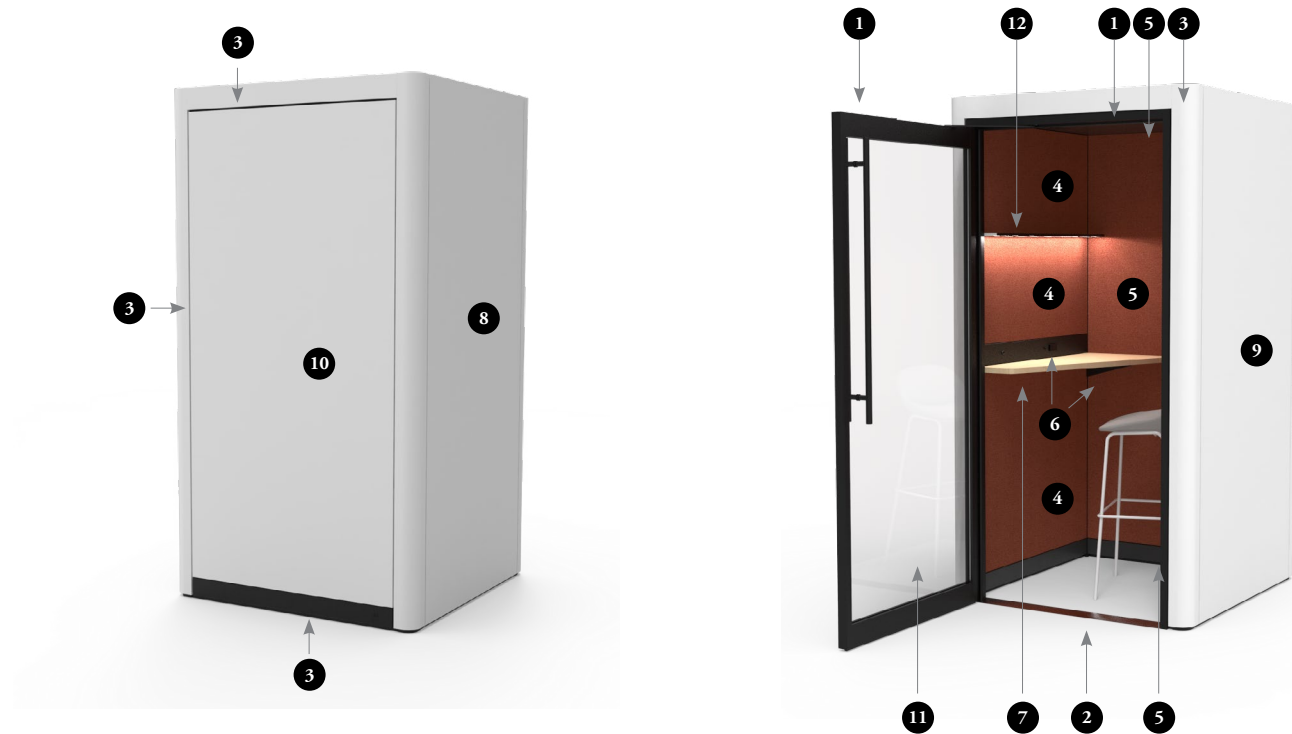

- 1 Door Frame, Door Leaf, Door Pull*
- 2 Door Threshold
- 3 Corner Trims, Exterior Base Fascia
- 4 Interior Side Fascias (Acoustic Tackable)
- 5 Interior Back Fascia (Fabric Wrapped)
- 6 Interior Base Fascias, Ceiling Fascia, Electrics Beam, Coat / Bag Hook, Worksurface Support *
- 7 Worksurface (Solid)
- 8 Left Side Exterior fascia (Solid)
- 9 Right Side Exterior fascia (Solid)
- 10 Back Side Exterior fascia (Solid)
- 11 Door Insert (Clear Glass)
- 12 Task Light *

Finishes

- Metal painted finishes available in Foundation, Mica and Accent paint
- Certain finish regions only available in Ebony or Anthracite paints *
- Exterior fascias available in Foundation Laminate, Flintwood and Source Laminate
- Fabric Fascias are available in select Teknion Architectural Fabrics
- Worksurface finish includes Foundation Laminate, Source Laminate or Flintwood
- Threshold offered in Stainless finish as standard

tek booth size and dimensions





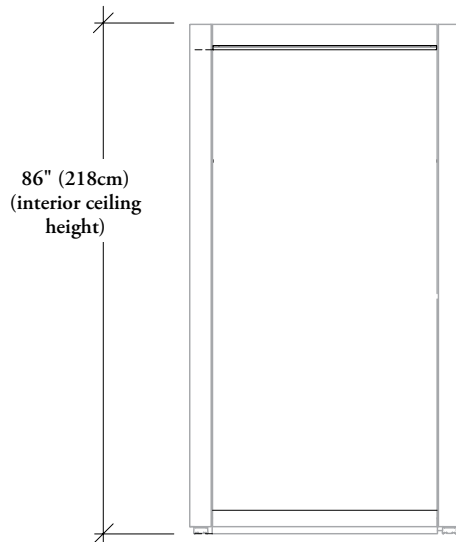
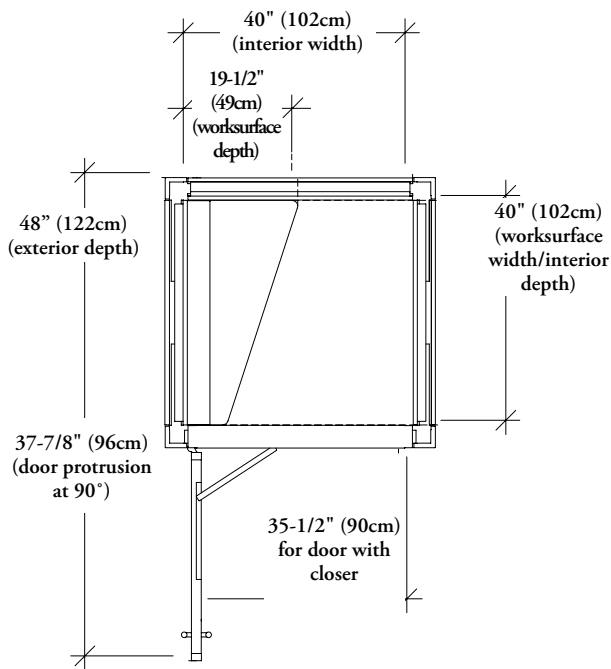
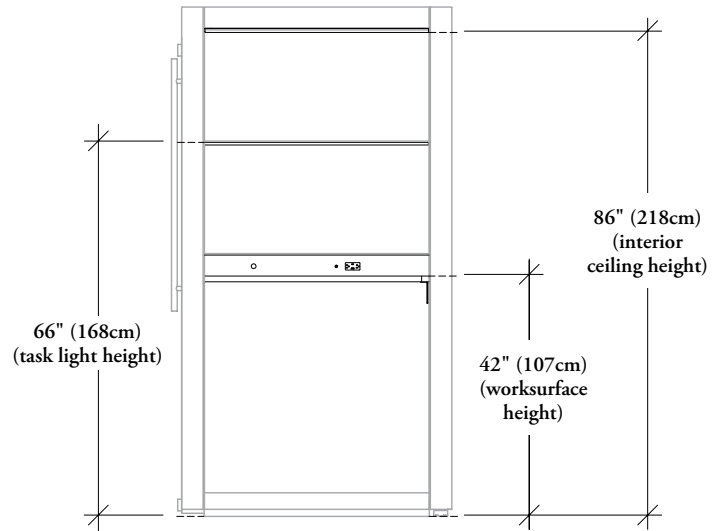
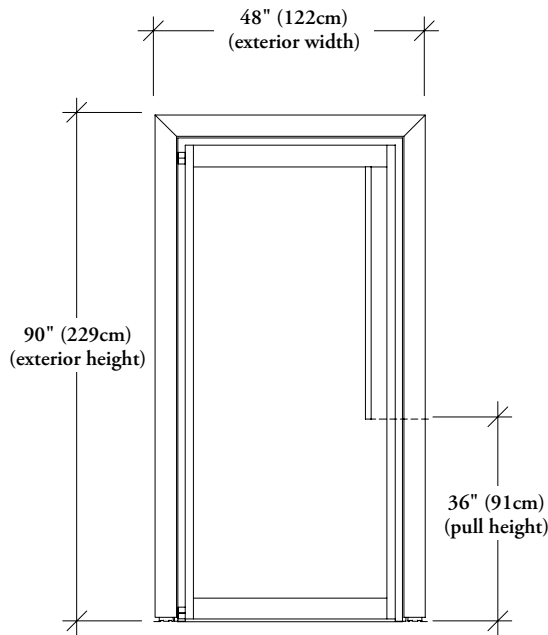

The following should be considered when planning with Tek Booth.

- All dimensions shown are nominal
- Base leveling range of -1/4" (0.63cm) to +1-3/4" (4.4cm)



tek booth orientation

Tek booth's orientation is determined by the handedness of the pivot door and the worksurface as viewed from the front exterior of the booth. Tek Booth's door pivots open to the exterior only. See the Electrics section for more detailed information on base and ceiling feed orientation.

Left Orientation	Right Orientation	Restrictions
		
		 <p data-bbox="1141 1220 1377 1314">The handedness of the door and the interior worksurface must be specified to match to allow for proper entry.</p>

tek booth fascia features

Tek booth fascias are configured to provide sound blocking and sound absorbing properties, while achieving a balance between visual privacy and light transmission. The following breaks down the overall fascia design configuration of the booth.

exterior



The exterior side fascias (Left or Right) are composed of hard surfaces (solid or backpainted glass) and keep external noise from entering the booth.



The 6mm double glazed back wall fascia provides light transmission into the booth while keeping an acoustic barrier.

interior

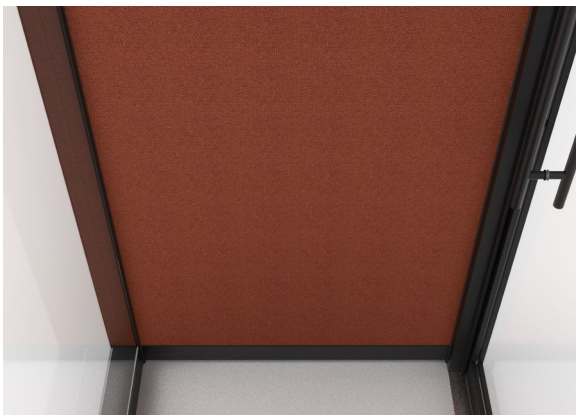

The interior side fascias are composed of acoustic tackable fabric, providing sound absorption, a place to pin notes and a soft, comfortable visual aesthetic.



The interior base and ceiling fascias are composed of microperforated steel providing sound absorption, a low maintenance finish, ventilation capabilities and fire suppression integration.

tek booth finish features

It is important to know the grain and fabric direction as well as maintenance requirements when specifying Tek Booth. The following outlines directionality for both fascias and worksurfaces as well as basic cleaning guidelines.

fabric direction

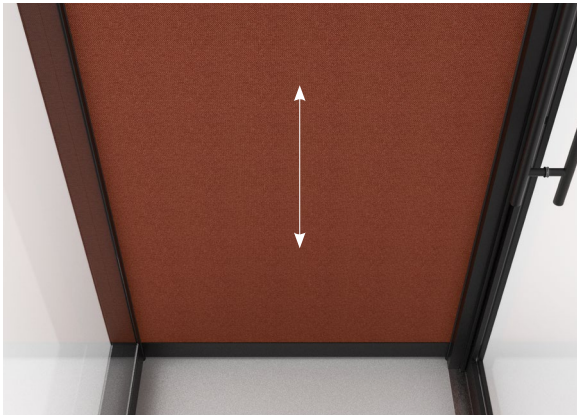

Fabric direction

Fabric direction on all interior side fascias run off-the-bolt.

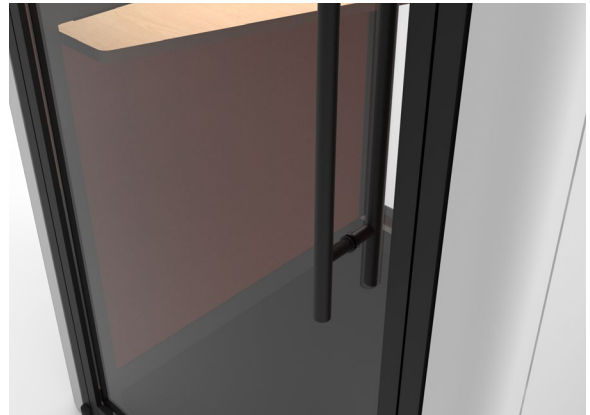

Cleaning

When cleaning pulls, it is important to note that no abrasive cleaners should be used so paint is not damaged or scratched.

woodgrain direction



Worksurface grain direction

The woodgrain on all worksurfaces runs the length of the surface.



Fascia grain direction

The woodgrain on all exterior fascias runs vertical.

tek booth door features

The Framed Pivot Door provides an acoustic barrier, reducing noise inside the booth. Below describes the details and features of the door.

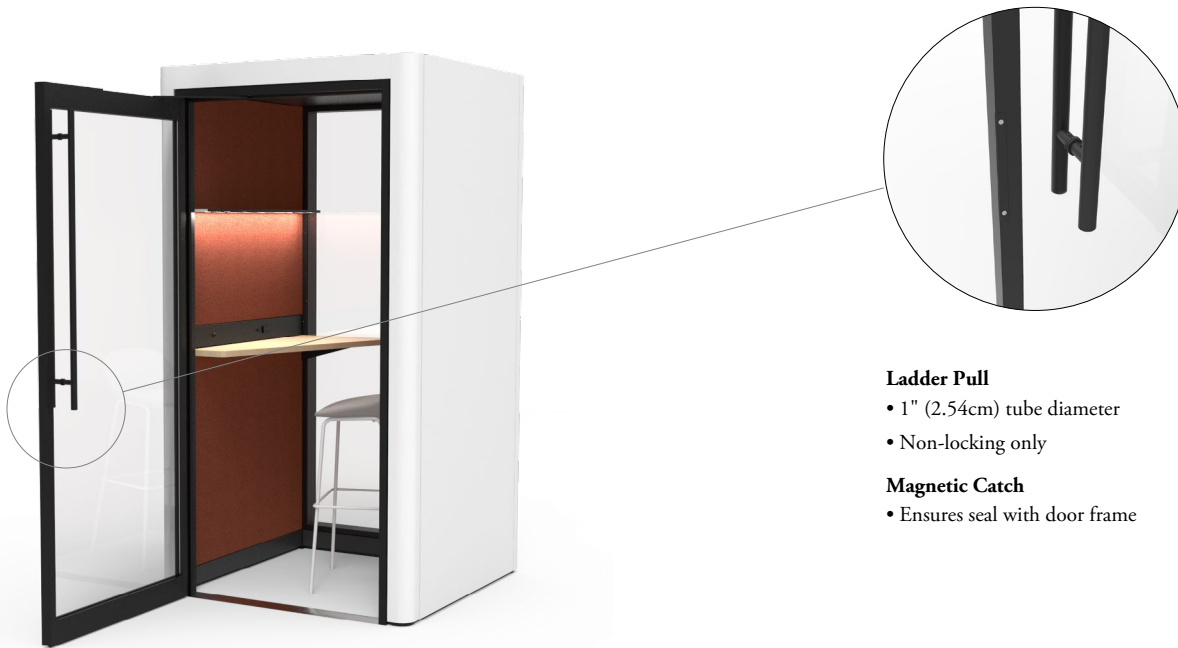

Ladder Pull

- 1" (2.54cm) tube diameter
- Non-locking only

Magnetic Catch

- Ensures seal with door frame



Pivot Hinge

- Two pivot points (top and bottom)
- Visible on exterior of booth
- Attached to vertical door jamb

tek booth door features (continued)



Bottom Seal

- Adjustable brush pile
- Continuous width across door



Threshold

- Stainless Steel construction
- Provides lateral structure

tek booth door features (continued)



Door Closer with Hold Open

- Hold open range: 90° - 100°
- Adjustable speed
- No door stopper required on floor
- Black finish standard

tek booth automated door features

The following describes the main features to consider when specifying door automation on Tek Booth.

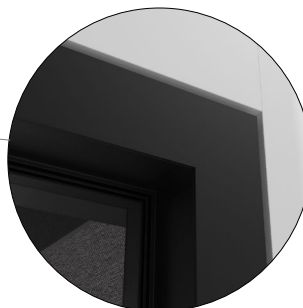

Automated Door Frame

- 2.4" (6cm) wide door frame accommodates automated hardware
- Clear opening: 33-1/4" (84cm)
- Header clearance: 83" (211cm) AFF



The 2.4" (6cm) wide door frame is only used when the automated door is specified.



Hand Activator

- Touch free hand activator triggers the door to open
- Located in the door jamb on the strike side of the door leaf
- Interior and exterior mounted (double sided)
- Mount height: 38-1/2" (98cm) AFF CL
- Hand activation range: 0-3" (7cm)
- Time delay: 5 seconds
- Black polycarbonate finish with hand icon standard



Hand activation range is preset by Teknion and is recommended to avoid accidental activation from body movement while inside the room.
Time delay is preset by Teknion and represents the minimum time the user must wait before reactivating the door.

tek booth automated door features (continued)



Automatic Door Operator

- Low energy, electro-mechanical swing door opener and closer
- Mounted on interior of door frame header (push side)
- Opening time: 4.5 seconds
- Opening angle: 90-100°
- Hold open time: 5 seconds
- Closing time: 4.5 seconds
- Dark finish standard



The opening time, opening angle, hold open time and closing time are specific settings recommended by Teknion.

The following settings are optional:

- Power assist - aids in the manual opening of the door
- Push and go - allows the door to open automatically when the operator senses manual movement of the door
- Stop on stall - door will stop when it hits an obstruction
- Reverse upon obstruction - door will stop and reverse when it hits an obstruction

The automatic door operator can only work with plug-in electrics. In the event of a power loss, the door can be opened manually.



Signage

- Signage for automated doors are not supplied directly by Teknion
- Below are Teknion's recommendations;
- Apply signage decal 38" (96cm) – 62" (157cm) AFF CL, on both sides of the door
- Automatic Caution Door signage must have minimum 6" diameter with black text on yellow background
- Activate Switch to Operate signage is required for the hand activator, and must be white on blue background
- Push to Operate and Pull to Operate signage is only required if the door operator has been programmed for Push and go
- All text must be 5/8" (1.6cm) tall minimum

tek booth interior features

Positioned above the worksurface, Tek Booth has a built-in electrics beam equipped with an occupancy sensor and receptacle outlets allowing for technology support.

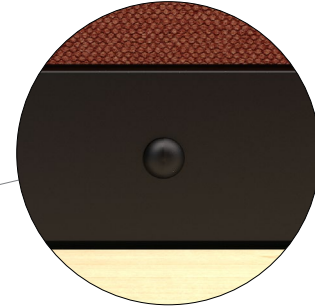

Occupancy Sensor

When the user enters the booth, the occupancy sensor is activated, automatically turning on ventilation fans and the task light. If no movement is detected after 5 minutes, the fan and light will automatically turn off.



Tek Booth occupancy sensor turn off time can be increased beyond 5 minutes if required by the end user. Installation instructions are available upon request.



Receptacle

Each booth is equipped with a single power 2-Gang that also contains option off one USB-A and one USB-C outlet. The receptacle is offered in black finish only.

tek booth interior features (continued)

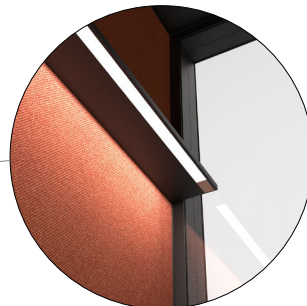

Task Light

Once the task light is activated, there are three dimmable settings to lower the brightness to the users preference. The dimmer button is always located on the electric fascia.

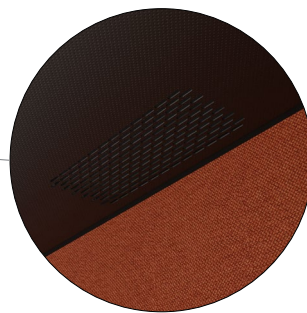

Ventilation

Ventilation intake is provided by a pair of low noise fans which are integrated into the micro-perforated ceiling fascia. The fans work in tandem with the base fascia, which acts as an exhaust, enabling full air exchange.

tek booth interior features (continued)

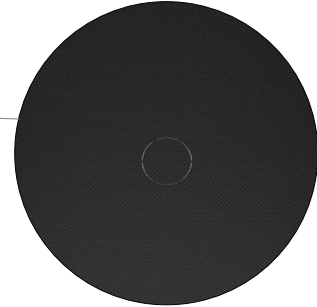

Fire Suppression Prep

The micro-perforated ceiling fascia comes standard with a punch out prep for easy sprinkler installation.



Tek Booth can be retrofitted with sprinklers if required, but are not included as standard.



Coat / Bag Hook

A coat / bag hook can be placed in the interior back corner of the booth, opposite of the worksurface. It can be installed at any height (in 1" (2.54cm) increments).

tek booth exterior features

The following describes the exterior corner trim options available on Tek Booth.

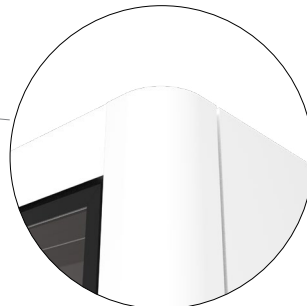

Round Corner Trim

The round corner trim option provides a soft exterior aesthetic. The vertical and horizontal trim components meet at a butt joint.

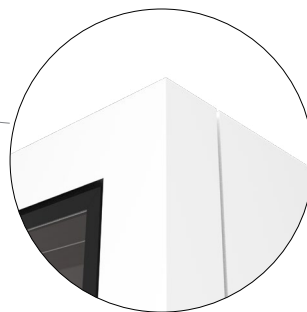
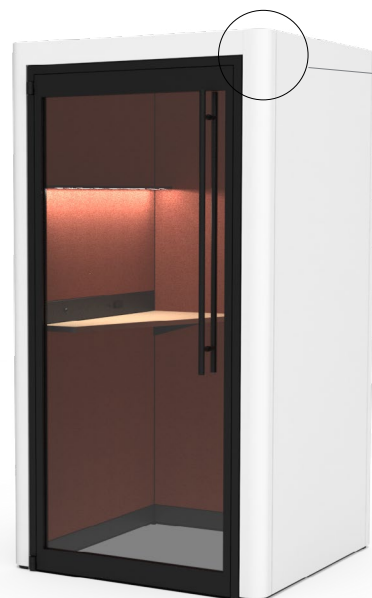

Square Corner Trim

The square corner trim option provides a rectilinear exterior aesthetic. The vertical and horizontal trim components meet at a miter joint.

tek booth seating recommendations

The following must be considered when planning seating inside Tek Booth.

Any seating required inside of Tek Booth must be specified separately and at bar height to function with the interior bar height worksurface. For Teknion Seating offerings, refer to www.teknion.com.



42" (107cm) high worksurface
32" (81cm) high bar seat recommended









Seating is not required for the booth if standing is the preferred ergonomic solution

tek booth planning with electric

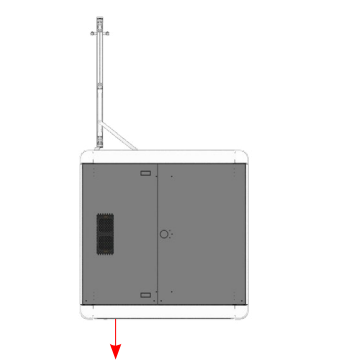
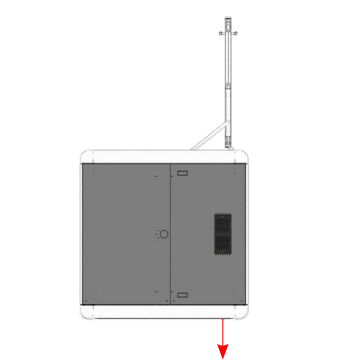
Tek booth offers base and ceiling feeds for routing electric to the base building. The following should be considered when planning with base and ceiling feeds.

- Base feed location is dictated by left and right orientation of specified door and worksurface
- Ceiling feed location is universal and is not dependent on booth orientation
- Base feed grommet is always supplied in Black finish
- Base and ceiling feed uses a Black power cord for plug in electric
- Base feed uses a Grey liquid tight conduit for hardwire electric
- Ceiling feed uses an exposed conduit in hardwire electric

	Base Feed (plug-in) (Right Orientation)	Base Feed (plug-in) (Left Orientation)	Ceiling Feed (plug-in or hardwired) (L/R Orientation)
Back View			
Top View			
Detail View (plug-in option shown)			

tek booth planning with electrics (continued)

The following rules and restrictions should be considered when connecting Tek Booth electrically in tandem and to the base building.

		Plug-In	Hardwire
Daisy Chain Base Feed		⊘	⊘
Daisy Chain Ceiling Feed Connected to building by base or ceiling feed		⊘	☑
Parallel/In Series Connected to building by base or ceiling feed		☑	☑

tek work

tek work

WHAT IS TEK WORK	52
TEK WORK BASICS.	53
TEK WORK HOW TO ORDER A COMPLETE PACKAGE.	56
TEK WORK FINISH REGIONS FIXED DESK	58
TEK WORK FINISH REGIONS HEIGHT-ADJUSTABLE	59
TEK WORK SIZE & DIMENSIONS	60
TEK WORK DOOR LOCATION.	62
TEK WORK FASCIA FEATURES	63
TEK WORK FINISH FEATURES	64
TEK WORK AUTOMATED DOOR FEATURES.	65
TEK WORK INTERIOR FEATURES	66
TEK WORK INTERIOR FEATURES - FIXED DESK	67
TEK WORK INTERIOR FEATURES - HEIGHT-ADJUSTABLE	68
TEK WORK PLANNING WITH FREESTANDING FURNITURE	69
TEK WORK PLANNING WITH ELECTRICS	71

what is tek work

The following outlines the key concepts behind Tek Work.



adaptable privacy

Tek Work is designed to support individual's private work sessions in an open plan environment. It's universal approach to planning works with a wide variety of freestanding Teknion furniture and can easily be grouped with other POD products such as the Booth or Room.

height adjustability and comfort

The Tek Work height-adjustable worksurface option improves user ergonomics allowing for longer more enjoyable working sessions with an overall improved comfort.

high quality video calls

Tek Work offers multiple lighting options. The task light improves illumination of the worksurface for focused work and a ceiling light serves as the general spatial light. The optional facelight provides the users with a high quality on screen video call appearance. All lighting options can be dimmed for maximum control.

tek work basics

Tek Work is comprised the following top level codes that are shared in common with both the fixed or no worksurface version and the height-adjustable worksurface version. Each code must be specified individually. It can be specified in numerous finishes and can accept additional furniture and accessories if required.

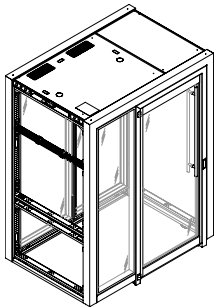

Tek Work Structure for Glass Back (EFTWG)

- Includes structural steel frame, corner trims, door frame, door leaf, door pull, top lid, three exterior base fascias, three double glass fascias (two for back and one for front wall) and threshold
- Corner Trim: Square or Round
- Door Location: Left or Right
- Door Kickplate Option
- Door Glass Finish: Clear
- Wall Glass Finish: Clear or Frosted
- Frame Finish: Ebony or Anthracite
- Corner Trim Finish: Foundation, Mica or Accent
- Electrical Feed: Base or Ceiling
- Door Control: Closer with Hold-Open or Automated

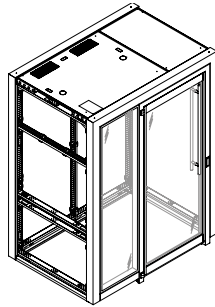

Tek Work Structure for Solid Back (EFTWS)

- Includes structural steel frame, corner trims, door frame, door leaf, door pull, top lid, three exterior base fascias, one double glass fascia (for front wall) and threshold
- Corner Trim: Square or Round
- Door Location: Left or Right
- Door Kickplate Option
- Door Glass Finish: Clear
- Wall Glass Finish: Clear or Frosted
- Frame Finish: Ebony or Anthracite
- Corner Trim Finish: Foundation, Mica or Accent
- Electrical Feed: Base or Ceiling
- Door Control: Closer with Hold-Open or Automated

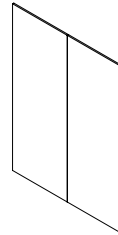

Tek Work Exterior (EFTWE)

- Qty 1 fascia is included when Left (L) or Right (R) Exterior Wall Side is selected
- Qty 2 fascias are included when Back (B) Exterior Wall Side is selected
- Two fascias (one left and one right) need to be ordered for complete assembly with glass back, one fascias per side
- Four fascias (two back, one left and one right) need to be ordered for complete assembly with solid back
- Orientation: Left Right or Back (must be specified individually)
- Finishes: Laminate

tek work basics (continued)

Tek Work fixed or no worksurface versions are comprised of the following top level codes. Each code must be specified individually.

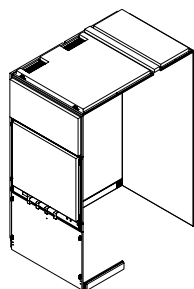

Tek Work Interior for Fixed or No Worksurface (EFTWIF)

- Includes interior base fascias, fabric fascias and ceiling fascias and sheet metal fascia for electrics
- Back: Glass or Solid
- Side Walls Finish: Architectural Fabrics
- Back Walls Finish: Architectural Fabrics or Laminates
- Metal Fascia Finish: Ebony or Anthracite
- Excluding electrical fascia
- Electrical fascia to be purchased separately

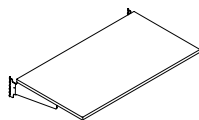

Tek Work Fixed Worksurface (EFTWFW)

- Includes worksurface, cantilever supports
- 38" (97cm) width x 23" (58cm) depth (nominal)
- Worksurface Finish: Foundation Laminate, Source Laminate or Flintwood
- Support Finish: Ebony or Anthracite

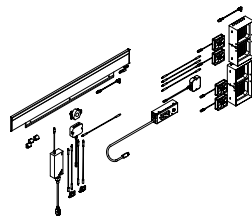

Tek Work Electrical Kit for Fixed or No Worksurface Plug-In (EFTWEPF)

- Includes electrical components and ceiling light
- Ceiling Light Finish: Ebony or Anthracite
- Task Light Finish: Ebony or Anthracite
- Powerbar and Stater Cable to be purchased separately

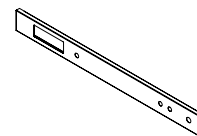

Tek Work Electrical Fascia for Fixed or No Worksurface (ELFTWEF)

- Includes Electric Fascia with cut-out and mounting hardware.
- Finish in Ebony and Anthracite

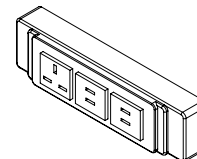

Powerbar for Tek Work For Fixed or No Worksurface (ELFTWNBW)

- Power Cord Lengths: 300cm or 500cm
- Come with Netbox 3-Gang, Starter Cable and IEC cable

tek work basics (continued)

Tek Work height adjustable versions are comprised of the following top level codes. Each code must be specified individually.

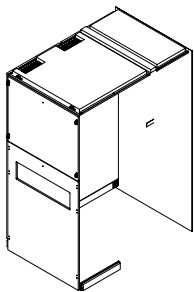

Tek Work Interior for Height-Adjustable Worksurface (EFTWIH)

- Includes interior base fascias, fabric fascias and ceiling fascias
- Back wall finish is only available for Back Type Solid (S)
- Side/Above Worksurface Finish: Architectural Fabrics
- Side/Below Worksurface Finish: Laminates
- Back Walls Finish: Architectural Fabrics or Laminates
- Metal Fascia Finish: Ebony or Anthracite

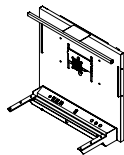

Tek Work Height-Adjustable Worksurface Assembly (EFTWHA)

- Includes task light and face-light
- Charging Ports: USB-C 30W
- Shroud/Cantilever arms Finish: Foundation, Accent or Mica
- Technology Fascia Finish: Ebony or Anthracite
- Powerbar and Starter Cable to be purchased separately

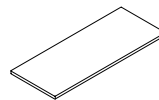

Tek Work Height-Adjustable Worksurface (EFTWHW)

- Includes worksurface
- 38" (96cm) width x 15" (38cm) depth (nominal)
- Worksurface Finish: Foundation Laminate, Source Laminate or Flintwood

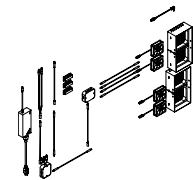

Tek Work Electrical Power Kit for Height-Adjustable Worksurface Plug-In (EFTWEPA)

- Includes electrical components and ceiling light
- Ceiling Light Finish: Ebony or Anthracite
- Powerbar and Starter Cable to be purchased separately

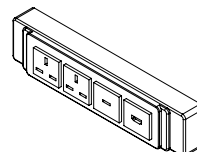

Powerbar for Tek Work Height Adjustable (ELFTWNB)

- Power Cord Lengths: 300cm or 500cm
- Inclusive of - Starter Cable, Netbox M-4 Gang, Connector Cable, Netbox 5-Gang with IEC connector

tek work how to order a complete package

The following chart will help you select the appropriate items to order Tek Work.

fixed worksurface



Required Work Items

- EFTWG x1 - Structure for Glass Back
- EFTWEL x1 - Exterior Left
- EFTWER x1 - Exterior Right
- EFTWIF x1 - Interior, No Worksurface/Fixed Worksurface
- EFTWEPF x1 - Electrical Kit - Plugin
- ELFTWEF x1 - Tek Work Electrical Fascia
- ELFTWNBW x1 - Powerbar for fixed or no worksurface

Optional Furniture and Accessory Items

- EFTRH - Coat/Bag Hook
- ETWFW - Fixed Worksurface



Required Work Items

- EFTRS x1 - Structure for Solid Back
- EFTWEL x1 - Exterior Left
- EFTWER x1 - Exterior Right
- EFTWEB x1 - Exterior Back
- EFTWIF x1 - Interior, No Worksurface/Fixed Worksurface
- EFTWEPF x1 - Electrical Kit - Plugin
- ELFTWEF x1 - Tek Work Electrical Fascia
- ELFTWNBW x1 - Powerbar for fixed or no worksurface

Optional Furniture and Accessory Items

- EFTRH - Coat/Bag Hook
- EFTWFW - Fixed Worksurface

tek work how to order a complete package (continued)

The following chart will help you select the appropriate items to order Tek Work.

height-adjustable worksurface



Required Work Items

- EFTWG x1 - Structure for Glass Back
- EFTWEL x1 - Exterior Left
- EFTWER x1 - Exterior Right
- EFTWIH x1 - Interior - HA Worksurface
- EFTWHW x1 - HA Worksurface
- EFTWHA x1 - HA Worksurface Assembly
- EFTWEPA x1 - Electrical Kit HA WS
- ELFTWNB x1 - Powerbar for Height Adjustable

Optional Furniture and Accessory Items

- EFTRH - Coat/Bag Hook



Required Work Items

- EFTWS x1 - Structure for Solid Back
- EFTWEL x1 - Exterior Left
- EFTWER x1 - Exterior Right
- EFTWEB x1 - Exterior Back
- EFTWIH x1 - Interior - HA Worksurface
- EFTWHW x1 - HA Worksurface
- EFTWHA x1 - HA Worksurface Assembly
- EFTWEPA x1 - Electrical Kit HA Worksurface
- ELFTWNB x1 - Powerbar for Height Adjustable

Optional Furniture and Accessory Items

- EFTRH - Coat/Bag Hook

tek work finish regions fixed desk

The following outlines the finish regions within Tek Work. There are up to 15 different finish regions, depending on the additional furniture and accessories specified

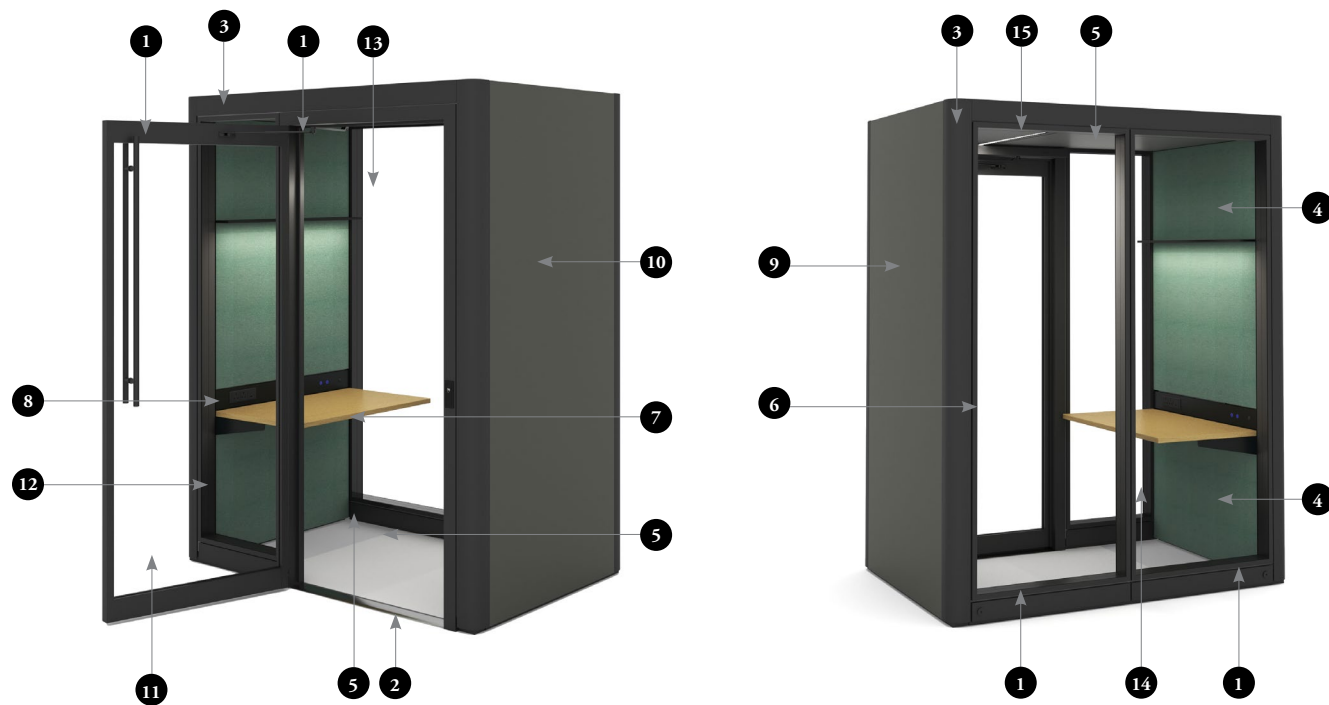

Image represents an example of finish regions of one right hand version with a glass back structure.

- 1 Door Frame, Door Leaf, Door Pull, Exterior Base Fascias, Glass Framing *
- 2 Door Threshold
- 3 Corner Trims
- 4 Interior Side Fascias (Acoustic Tackable/Fabric Wrap below worksurface)
- 5 Interior Base Fascias, Ceiling Fascias *
- 6 Coat / Bag Hook *
- 7 Worksurface (Solid)
- 8 Technology Fascia *
- 9 Left Side Exterior Fascia (Solid)
- 10 Right Side Exterior Fascia (Solid)
- 11 Door Insert (Clear Glass)
- 12 Front Fascias (Clear or Frosted Glass)
- 13 Interior Back Fascias (Fabric Wrapped or Laminate) (pair with Solid back structure)
Interior Back Fascias (Clear or Frosted) (included with Glass back structure)
- 14 Exterior Back Fascias (Laminate) (pair with Solid back structure)
Exterior Back Fascias (Clear or Frosted) (included with Glass back structure)
- 15 Ceiling Light*

Finishes

- Metal painted finishes available in Foundation, Mica and Accent paint
- Certain finish regions only available in Ebony or Anthracite paints *
- Interior Fascias are available in select Teknion Architectural Fabrics
- Worksurface finishes available in Foundation Laminate, Source Laminate or Flintwood
- Threshold offered in Stainless finish as standard

tek work finish regions height-adjustable

The following outlines the finish regions within Tek Room. There are up to 16 different finish regions, depending on the additional furniture and accessories specified.

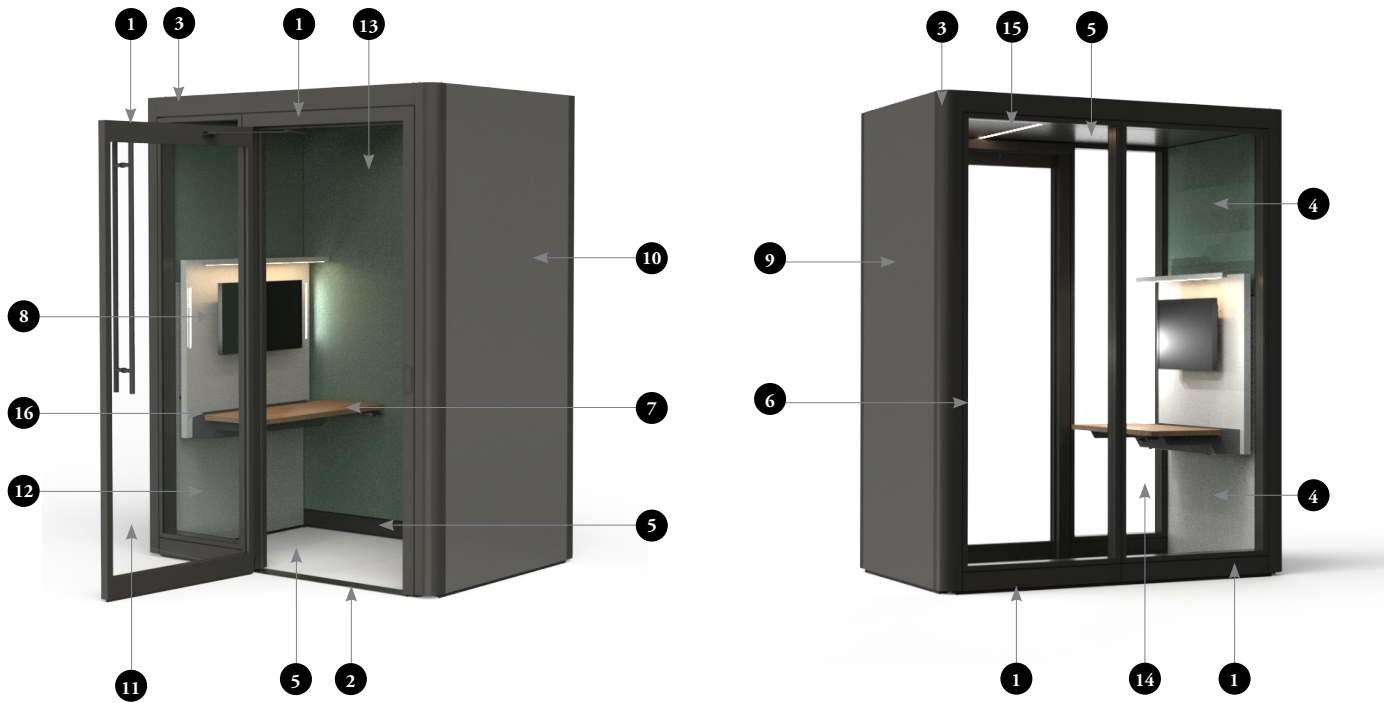

Images represent an example of finish regions of one right hand version with a glass back structure.

- 1 Door Frame, Door Leaf, Door Pull, Exterior Base Fascias, Glass Framing*
- 2 Door Threshold
- 3 Corner Trims
- 4 Interior Side Fascias (Fabric Wrapped)/Above Worksurface (Fabric Wrapped),
Interior Fascias Below Worksurface (Laminate)
- 5 Interior Base Fascias, Ceiling Fascias*
- 6 Coat / Bag Hook* (not shown in image)
- 7 Worksurface (Solid)
- 8 Monitor Shroud, Worksurface Support and Task Light
- 9 Left Side Exterior Fascia (Solid)
- 10 Right Side Exterior Fascia (Solid)
- 11 Door Insert (Clear Glass)
- 12 Front Fascias (Clear or Frosted Glass)
- 13 Interior Back Fascias (Fabric Wrapped or Laminate) (pair with Solid back structure)
Interior Back Fascias (Clear or Frosted) (included with Glass back structure)
- 14 Exterior Back Fascias (Laminate) (pair with Solid back structure)
Exterior Back Fascias (Clear or Frosted) (included with Glass back structure)
- 15 Ceiling Light*
- 16 Technology Fascia*

Finishes

- Metal painted finishes available in Foundation, Mica and Accent paint
- Certain finish regions only available in Ebony or Anthracite paints *
- Exterior Fascias are available in select Teknion Architectural Fabrics
- Worksurface finishes available in Foundation Laminate, Source Laminate or Flintwood
- Threshold offered in Stainless finish as standard

tek work size & dimensions

The following should be considered when planning with Tek Work.

- All dimensions shown are nominal values
- Base leveling range of $-1/4"$ to $+1-3/4"$ (0.6cm - 4.4cm)

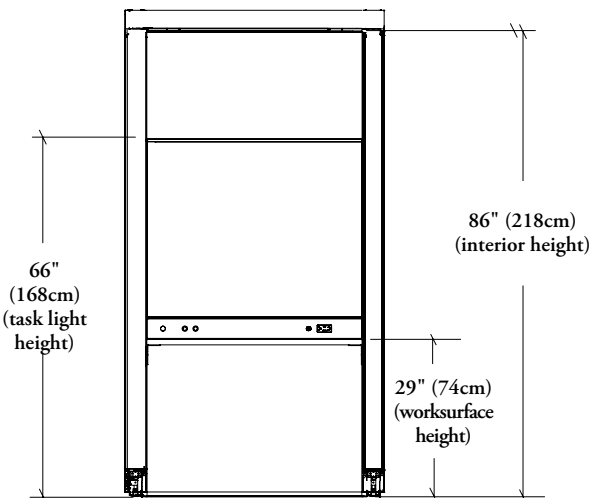
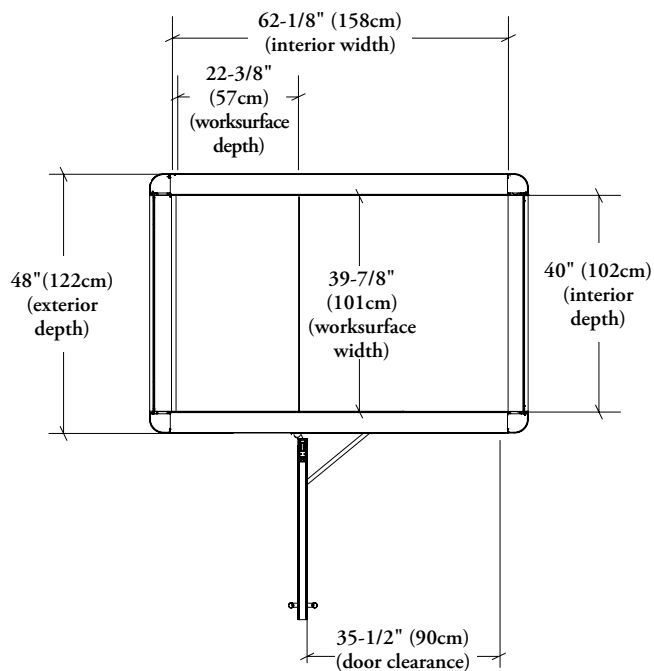
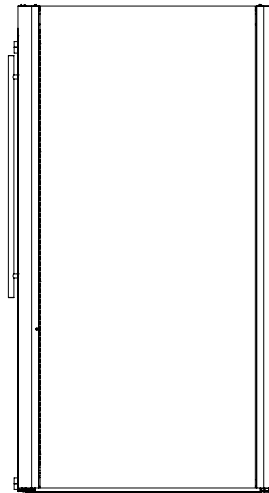
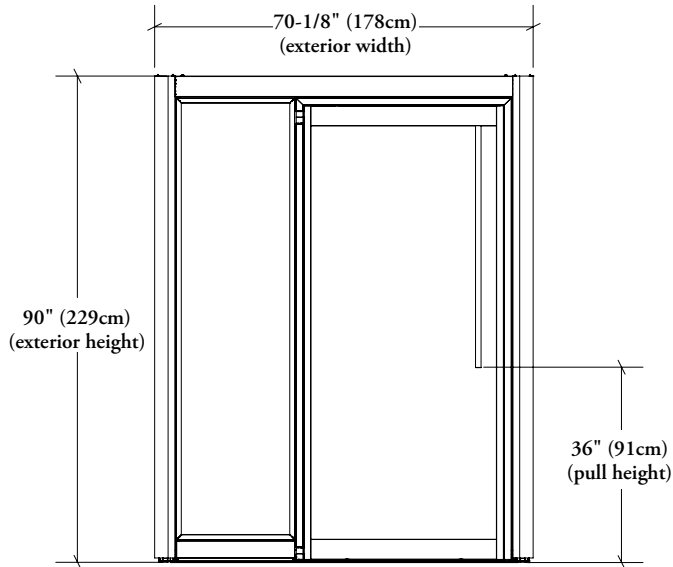

tek work size & dimensions (continued)

The following should be considered when planning with Tek Work.

- All dimensions shown are nominal values
- Base leveling range of $-1/4"$ to $+1-3/4"$ (0.6cm - 4.4cm)

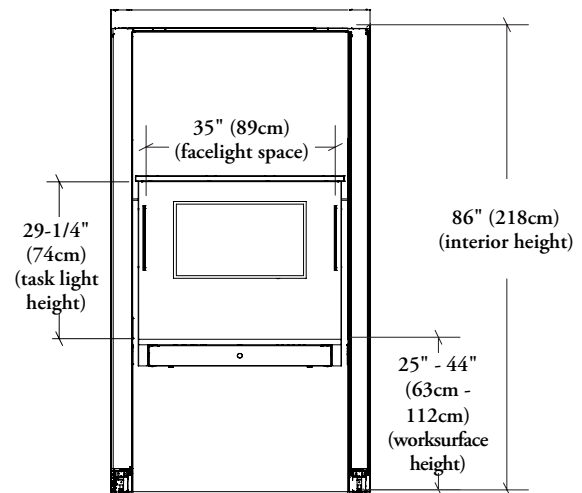
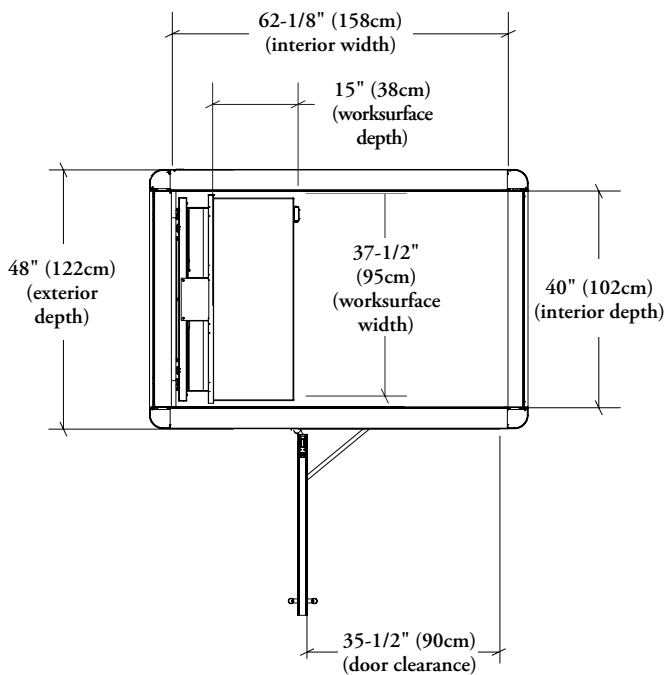
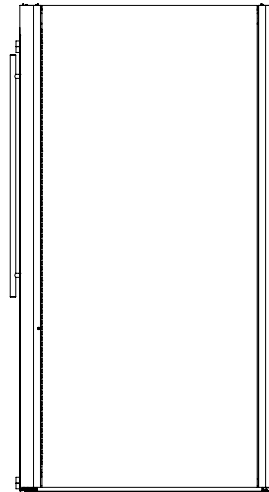
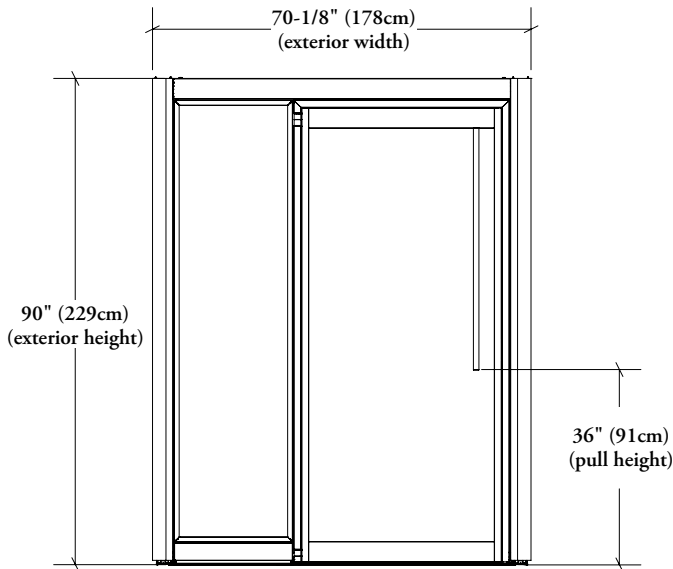

tek work door location

Tek Work's orientation is determined by the location of the pivot door as viewed from the front exterior. Tek Work's door pivots open to the exterior only.

left hand location, right hand reversed door swing



right hand location, left hand reversed door swing



tek work fascia features

Tek Work fascias are configured to provide sound blocking and sound absorbing properties, while achieving a balance between visual privacy and light transmission. The following breaks down the overall fascia design configuration.

exterior fascias



The exterior side fascias (left and right) are composed of hard surfaces (solid) and keep external noise from entering the room.



The 0.6cm double glazed back and front wall fascias provide light transmission into the room while keeping an acoustic barrier.

interior fascias

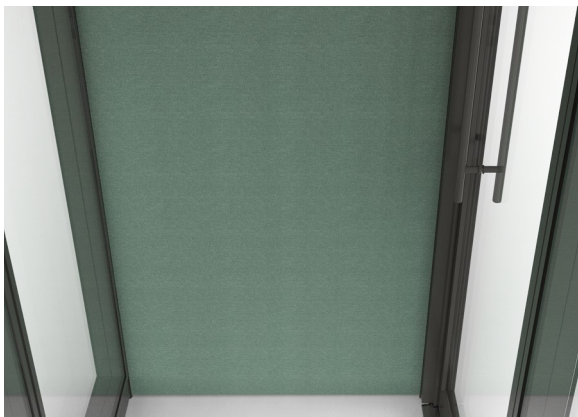

The interior side fascias (left and right) are composed of acoustic tackable fabric (behind user only on height adjustable version), providing sound absorption, a place to pin notes and a soft, comfortable visual aesthetic.



The interior base and ceiling fascias are composed of microperforated steel providing sound absorption, a low maintenance finish, ventilation capabilities and fire suppression integration.

tek work finish features

It is important to know the grain and fabric direction when specifying Tek Work. The following outlines directionality for both fascias and worksurface.

fabric direction

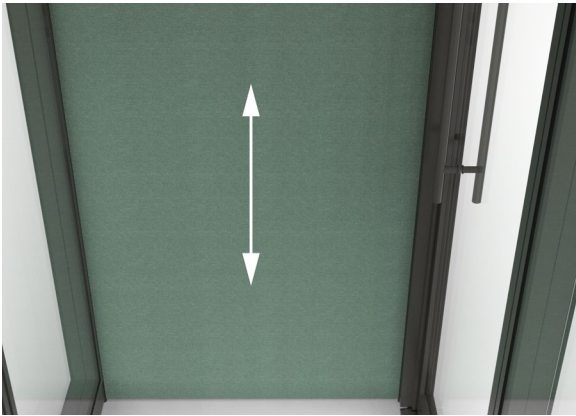

Fabric direction on all interior side fascias run off-the-bolt.

woodgrain direction



The woodgrain on the worksurface runs the length of the surface.



The woodgrain on all exterior fascias runs vertical.

tek work automated door features

The following describes the main features to consider when specifying door automation on Tek Work.

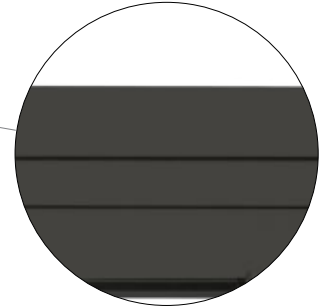

Automated Door Frame

- 2.4" (6cm) wide door frame accommodates automated hardware
- Clear opening: 37-1/2" (95cm)
- Header clearance: 83" (211cm) AFF



Hand Activator (Automated option)

- Touch free hand activator triggers the door to open
- Located in the door jamb on the strike side of the door leaf
- Interior and exterior mounted (double sided)
- Mount height: 38-1/2 (98cm) AFF CL
- Hand activation range: 0-3" (0-7.5cm)
- Time delay: 5 seconds
- Black polycarbonate finish with hand icon standard

tek work interior features

The following describes the features built into the interior ceiling.

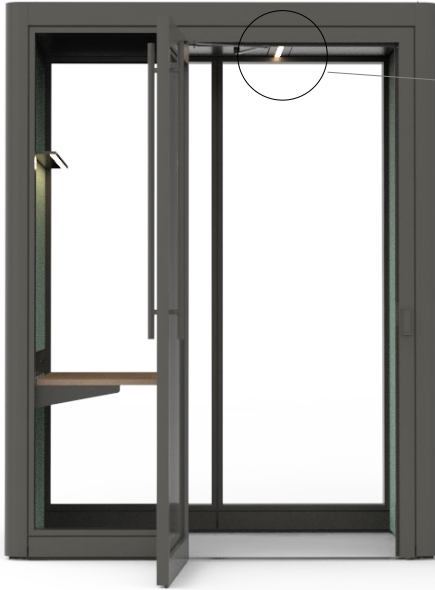

Ceiling Light

The recessed LED ceiling light spans the full interior depth of the Tek Work. Once activated, the light intensity can be controlled by the light switch located on the vertical technology column.

Fire Suppression Prep

The micro-perforated front ceiling fascia comes standard with a punch out prep for easy sprinkler installation.



Ventilation

Ventilation intake is provided by two pairs of low noise fans integrated into the micro-perforated back ceiling fascia. The fans work in tandem with the base fascia, which acts as an exhaust, enabling full air exchange.

tek work interior features - fixed desk

Tek Work's fixed worksurface is ideal for longer work sessions. Below describes the main design features.

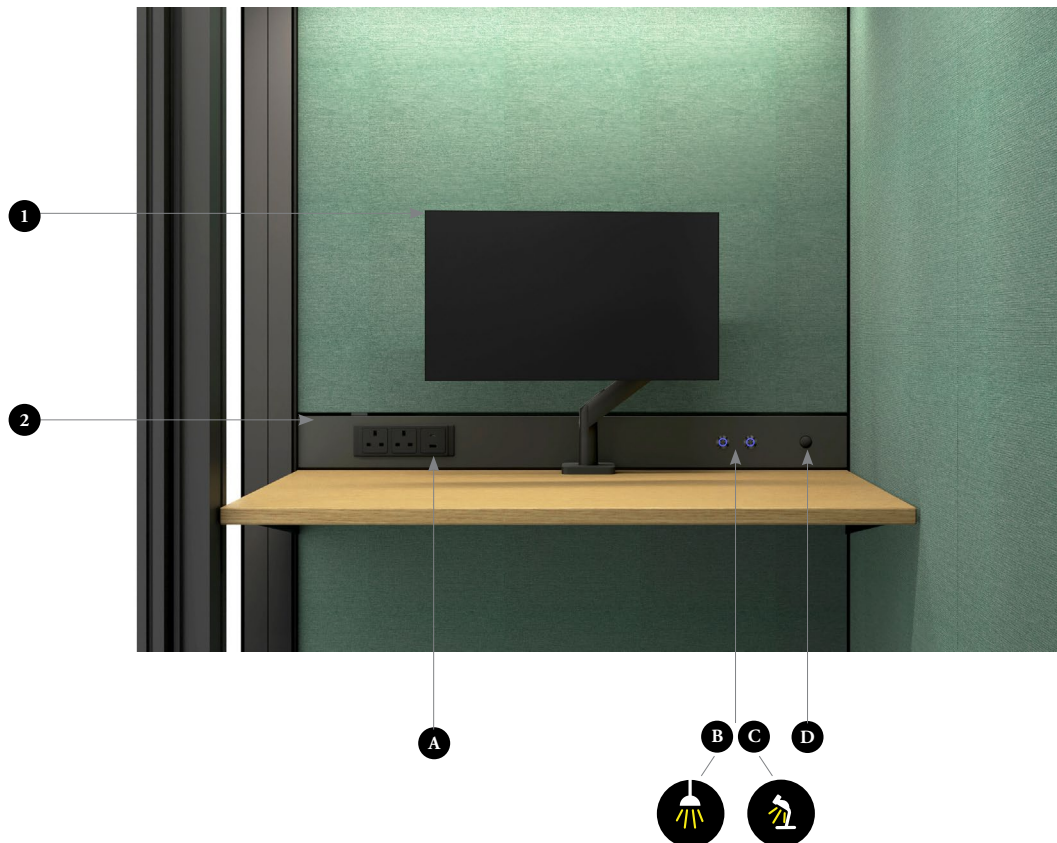

worksurface features

- 1 Monitor and Mount**
Monitor and mount are optional and sold separately.
- 2 Technology Fascias**
Charging outlets, light controls and sensor.

technology fascia

- A 240V Outlet**
The technology fascia is equipped with 2 power that also contains one USB-A and one USB-C outlet . The receptacle is offered in Black finish only.
- B Ceiling Light Dimmer**
The dimmable LED light switch allows for full control over the ceiling light intensity . To dim or increase light intensity, hold down the button.
To turn the light on and off, tap the button . Light brightness resets to the default brightness after shutting off.
- C Task Light Dimmer**
Turns light on/off and dims light.
- D Sensor**
When the user enters the room the occupancy sensor is activated, automatically turning on ventilation fans and the ceiling light . If no movement is detected after five minutes, the fan and light will automatically turn off.



There are additional power outlets on the electrical box located behind the vertical technology fascia to plug in secondary devices if required (e.g. door opener) . Ensure any cable routing behind fascias will pass local inspection codes. Secondary high voltage powerbars/cubes cannot be daisy chained to this unit.

Tek Work occupancy sensor turn off time can be increased beyond five minutes if required by the end user . Installation instructions are available upon request.

tek work interior features - height-adjustable

Tek Work's height-adjustable worksurface is ideal for longer work sessions. Below describes the main design features.



worksurface features

- 1 Task Light**
For improved lighting for task that utilizes the worksurface.
- 2 Face Light**
For improved in video call appearance.
- 3 Monitor and Mount**
Height-adjustable monitor mount is included. Monitor not included. Monitor mount can hold monitors up to 27" (68.5cm) and maximum of 15lbs (6.8kg)
- 4 Technology Fascias**
Charging, video port and light controls with cable tray.
- 5 Worksurface Height adjustment control**
Control paddle allows adjustment of worksurface from 28"-44" (71.1cm - 111.7cm) AFF.
- Sensor**
When the user enters the room the occupancy sensor is activated, automatically turning on ventilation fans and the ceiling light . If no movement is detected after five minutes, the fan and light will turn off.

technology fascia

- A 240V Outlet + USB A/USBC**
The technology fascia is equipped with 2 power and is offered in black finish only
- USB A
- USB C 30 watts
- B HDMI Port to Monitor**
Port to connect laptop or device to monitor.
- C Face light Dimmer**
The dimmable LED light switches allows for full control over the ceiling light intensity . To dim or increase light intensity, hold down the button. To turn the light on and off, tap the button . Light brightness resets to the default brightness after shutting off.
- D Ceiling Light Dimmer**
Turns light on/off and dims light.
- E Task Light Dimmer.**
Turns light on/off and dims light.



There are four additional power outlets on the technology fascia located under the worksurface to plug in secondary devices if required (e.g. door opener, monitor etc.).

tek work planning with freestanding furniture

The following shows examples of how Tek Work can be planned with freestanding furniture in various work settings.

focused work

Focused Work

- Without furnishings



Focused Work

- Task Chair
- 29" (74cm) high fixed worksurface shown



tek work planning with freestanding furniture (continued)

video calls

Video Calls





- Height-Adjustable Stool
- 25" - 44" (63cm - 112cm) high
height-adjustable range



tek work planning with electric



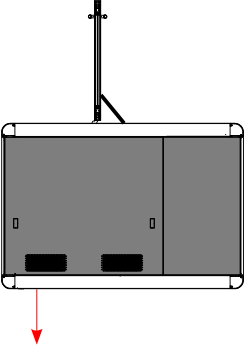
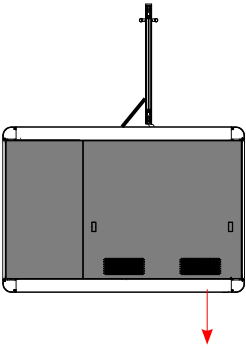
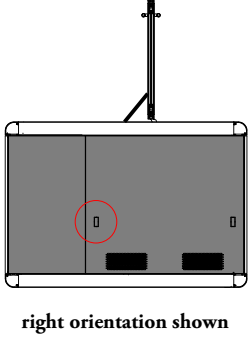

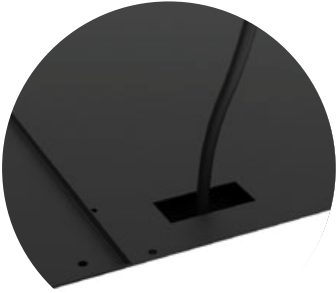

Tek Work offers base and ceiling feeds for routing electric to the base building. The following should be considered when planning with base and ceiling feeds.

- Base feed location is dictated by left and right orientation of specified door and worksurface
- Ceiling feed location left or right handed dependent on Tek Work orientation
- Base feed grommet is always supplied in Black finish
- Base and ceiling feed uses a Black power cord for plug in electric

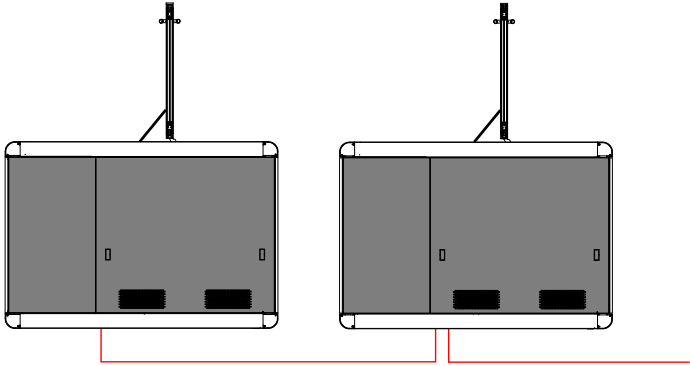
	Base Feed (Plug-In) (Left Orientation)	Base Feed (Plug-In) (Right Orientation)	Ceiling Feed (Plug-In/Hardwired) (Right/Left Orientation)
Back View			 right orientation shown
Top View			 right orientation shown
Detail View (Plug-In option shown)			

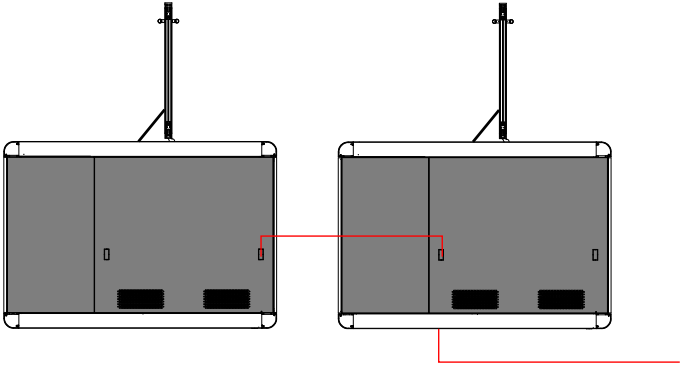
tek work planning with electricians (continued)

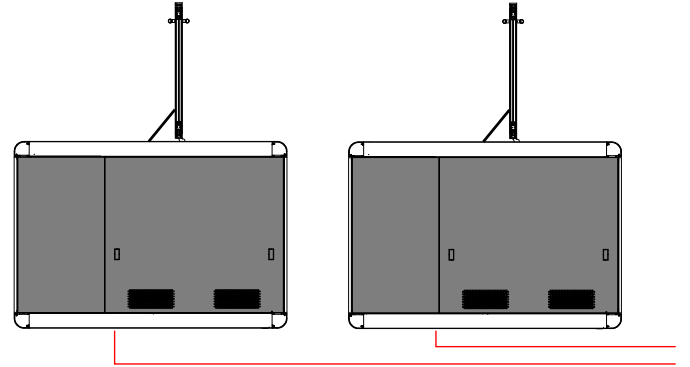
The following rules and restrictions should be considered when planning Tek Work in tandem and connecting electrically to the base building.

<p>Daisy Chain Base Feed Connected to building by base or ceiling feed</p>		
<p>Daisy Chain Ceiling Feed Connected to building by base or ceiling feed</p>		
<p>Parallel / In Series Connected to building by base or ceiling feed</p>		

tek room

tek room

WHAT IS TEK ROOM	77
TEK ROOM BASICS	78
TEK ROOM HOW TO ORDER A COMPLETE PACKAGE.	80
TEK ROOM FINISH REGIONS GLASS BACK	81
TEK ROOM FINISH REGIONS SOLID BACK	82
TEK ROOM SIZE & DIMENSIONS	83
TEK ROOM ORIENTATION.	84
TEK ROOM FASCIA FEATURES	85
TEK ROOM FINISH FEATURES	86
TEK ROOM AUTOMATED DOOR FEATURES.	87
TEK ROOM INTERIOR FEATURES	91
TEK ROOM EXTERIOR FEATURES.	94
TEK ROOM CENTER WORKSURFACE FEATURES	95
TEK ROOM PLANNING WITH THE CENTER WORKSURFACE.	96
TEK ROOM SIDE WORKSURFACE FEATURES	97
TEK ROOM PLANNING WITH THE SIDE WORKSURFACE	98
TEK ROOM PLANNING WITH FREESTANDING FURNITURE	99
TEK ROOM PLANNING WITH ELECTRICS	103

what is tek room

The following outlines the key concepts behind Tek Room.



Planning Flexibility

Tek Room is designed to support the individual or small group when focus, privacy and comfort are needed from the open plan environment. Its universal approach to planning works with a wide variety of freestanding Teknion furniture and allows for easy reconfigurability as business needs change.

Adaptable Electrics and Technology

Tek Room incorporates vertically integrated central power to accommodate various ergonomic settings as well as secondary communication and technology devices. An infinitely dimmable lighting system provides a high degree of environmental control and a more personalized work experience.

Accessibility and Safety

Tek Room can respond to different regional requirements to ensure successful integration into any building or project. Accessible room and door sizing supports a variety of end users, while fire suppression systems can be seamlessly retrofitted when needed.

tek room basics

Tek Room is comprised of a minimum of four distinct top level codes that must be specified individually to create a complete room. It can be specified in numerous finishes and can accept additional furniture and accessories if required.

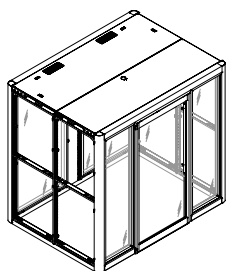

Tek Room Structure for Glass Back (EFTRG)

- Includes structural steel frame, corner trims, door frame, door leaf, door pull, exterior base fascias, exterior vertical technology fascia, back side glass fascias and threshold
- Corner Trim: Square or Round
- Door Orientation: Left or Right
- Door Kickplate option
- Door Glass Finish: Clear
- Wall Glass Finish: Clear or Frosted
- Frame Finish: Ebony or Anthracite
- Corner Trim Finish: Foundation, Mica or Accent
- Electrical Feed: Base or Ceiling
- Door Control: Closer with Hold-Open or Automated or Automated Accessible

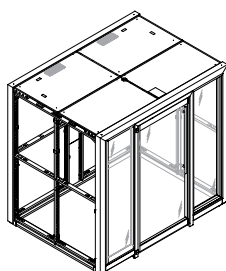

Tek Room Structure for Solid Back (EFTRS)

- Includes structural steel frame, corner trims, door frame, door leaf, door pull, exterior base fascia, exterior vertical technology fascia, and threshold
- Corner Trim: Square or Round
- Door Orientation: Left or Right
- Door Kickplate Option
- Door Glass Finish: Clear
- Wall Glass Finish: Clear or Frosted
- Frame Finish: Ebony or Anthracite
- Corner Trim Finish: Foundation, Mica or Accent
- Electrical Feed: Base or Ceiling
- Door Control: Closer with Hold-Open or Automated or Automated Accessible

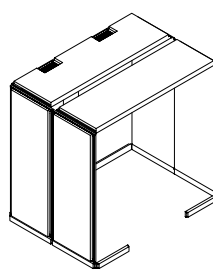

Tek Room Interior for Glass and Solid Back (EFTRI)

- Includes interior base fascias, upper fabric fascias, and ceiling fascias
- Electrics Height: 26" (66cm), 29" (74cm) or 42" (107cm)
- Center Worksurface prep option
- Metal Fascia Finish: Ebony or Anthracite
- Side Walls Finish: Architectural Fabrics
- Solid Back Wall Finish: Architectural Fabrics and Laminate
- Door Control: Closer with Hold-Open or Automated or Automated Accessible
- Excluding interior of vertical technology fascia



Tek Room Exterior (EFTRE)

- Includes two exterior fascias
- Orientation: Left Right or Back (must be specified individually)
- Finishes: Source Laminate, Foundation Laminate or Flintwood

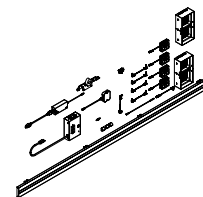

Tek Room Electrical Kit, Plug-In (EFTREP)

- Includes electrical components and ceiling light
- Wire Type: Plug-in (15 Amp only)
- Power Cord Length: 72" (183cm) or 180" (457cm)
- Ceiling Light Finish: Ebony or Anthracite

tek room basics (continued)

Tek Room is comprised of a minimum of four distinct top level codes that must be specified individually to create a complete room. It can be specified in numerous finishes and can accept additional furniture and accessories if required.

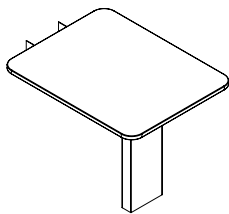

Tek Room Center Worksurface (EFTRCW)

- Includes worksurface, leg support and optional power module
- 38" (96cm) width x 30" (76cm) depth
- Height: 29" (77cm) or 42" (107cm)
- Worksurface Finish: Foundation Laminate, Source Laminate or Flintwood
- Support Finish: Ebony or Anthracite
- Power Module Option

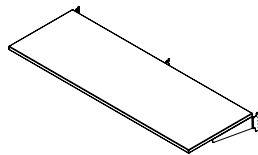

Tek Room Side Worksurface (EFTRSW)

- Includes worksurface, cantilever supports, wire management kit and optional power module
- 62" (157cm) width x 23" (58cm) depth (nominal)
- Worksurface Finish: Foundation Laminate or Flintwood
- Support Finish: Ebony or Anthracite
- Power Module Option



Tek Room Vertical Technology Fascia (EFTRF)

- Includes single interior fascia only
- Must be ordered on every order
- Electrics Height: 26" (66cm), 29" (737cm) or 42" (107cm)
- Center Worksurface prep option
- Fascia Finish: Ebony or Anthracite



Tek Room Tape Strip (EFTRT)

- Includes black tape roll
- For reconfiguring purposes only
- Hides any puncture marks from wall hung furniture or accessories

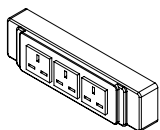

Power Bar for Tek Room (ELFTRNBM)

- Includes 2 Netbox 3-Gang & 5-Gang with all connecting cables
- Must be ordered with order

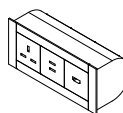

Netbox Style for Tek Room Worksurface (ELFTRNBL)

- Include 1 unit of netbox with cables
- To be ordered when power module option is selected for worksurface

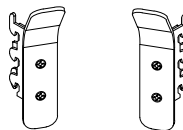

Tek Room Coat / Bag Hook (EFTRH)

- Includes two hooks (one left, one right)
- Finish: Ebony or Anthracite

tek room how to order a complete package

The following chart will help you select the appropriate items to order Tek Room.



Glass Back

Required Room Items

- EFTRE (L) x 1 - Exterior, Left
- EFTRG x 1 - Structure for Glass Back
- EFTRE (R) x 1 - Exterior, Right
- EFTRI x 1 - Interior
- EFTREP x 1 - Electrical Kit, Plug-In
- EFTRF - Vertical Technology Fascia
- ELFTRNBM x1 - Powerbar for Tek Room

Optional Furniture and Accessory Items

- EFTRCW - Center Worksurface
- EFTRSW - Side Worksurface
- EFTRH - Coat / Bag Hook
- ELFTRNBL - Netbox Line for Tek Room Worksurface

Optional Items for Reconfiguration (on Day 2)

- EFTRF - Vertical Technology Fascia
- EFTRT - Tape Strip



Solid Back

Required Room Items

- EFTRS x 1 - Structure for Solid Back
- EFTRE (L) x 1 - Exterior, Left
- EFTRE (R) x 1 - Exterior, Right
- EFTRI x 1 - Interior
- EFTREP x 1 - Electrical Kit, Plug-In
- EFTRF - Vertical Technology Fascia
- ELFTRNBM x1 - Powerbar for Tek Room

Optional Furniture and Accessory Items

- EFTRCW - Center Worksurface
- EFTRSW - Side Worksurface
- EFTRH - Coat / Bag Hook
- EFTPAK - Automated Door Hardware Kit
- ELFTRNBL - Netbox Line for Tek Room Worksurface

Optional Items for Reconfiguration (on Day 2)

- EFTRF - Vertical Technology Fascia
- EFTRT - Tape Strip

tek room finish regions glass back

The following outlines the finish regions within Tek Room. Please note there are up to 13 different finish regions, depending on the additional furniture and accessories specified.

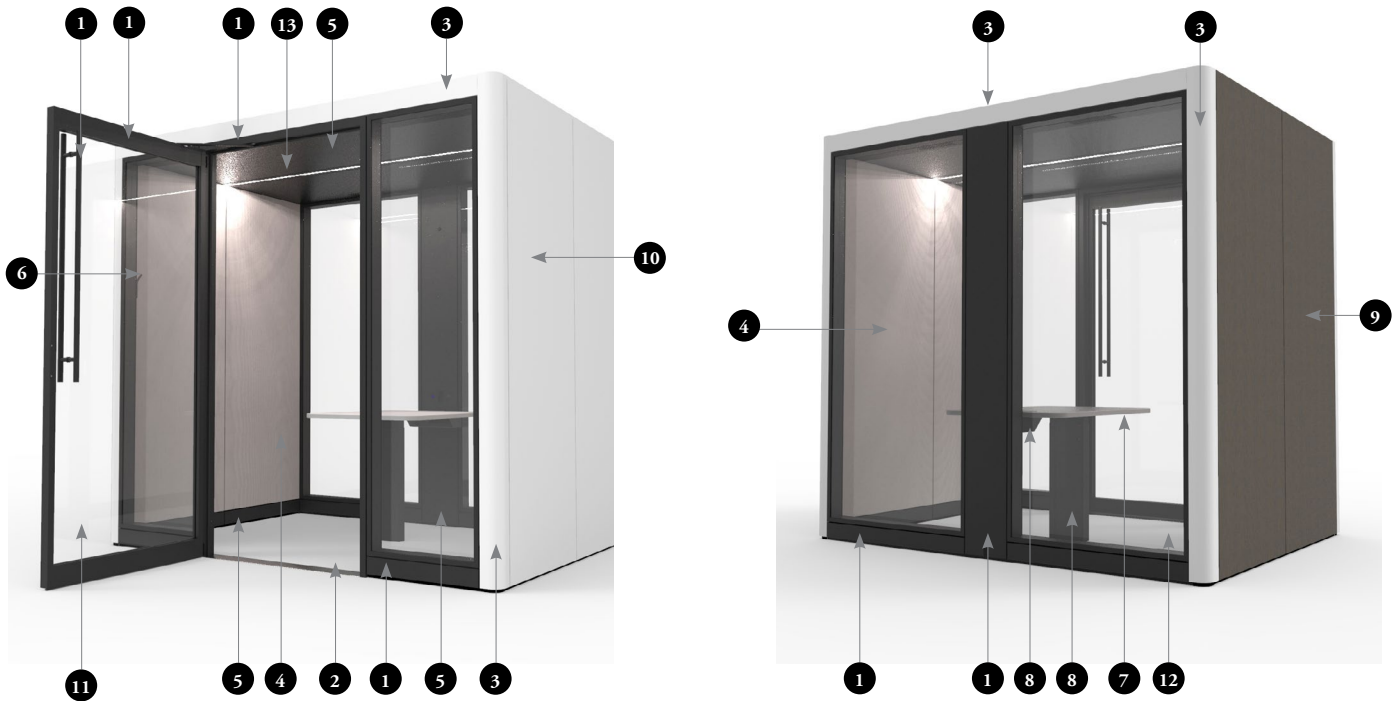

Images represent example of finish regions for one left handed version with additional center worksurface and coat/bag hook accessory

- 1 Door Frame, Door Leaf, Door Pull, Exterior Base Fascias, Exterior Technology Fascia, Glass Framing *
- 2 Door Threshold
- 3 Corner Trims
- 4 Interior Side Fascias (Acoustic Tackable)
- 5 Interior Base Fascias, Ceiling Fascias, Vertical Technology Fascia *
- 6 Coat / Bag Hook *
- 7 Worksurface (Solid)
- 8 Worksurface Support and Power Module *
- 9 Left Side Exterior fascia (Solid)
- 10 Right Side Exterior fascia (Solid)
- 11 Door Insert (Clear Glass)
- 12 Front and Back Fascias (Clear or Frosted Glass)
- 13 Ceiling Light*

Finishes

- Metal painted finishes available in Foundation, Mica and Accent paint
- Certain finish regions only available in Ebony or Anthracite paints *
- Exterior fascias available in Foundation Laminate, Flintwood and Source Laminate
- Fabric Fascias are available in select Teknion Architectural Fabrics
- Worksurface finish includes Foundation Laminate, Source Laminate or Flintwood
- Threshold offered in Stainless finish as standard

tek room finish regions solid back

The following outlines the finish regions within Tek Room. Please note there are up to 15 different finish regions, depending on the additional furniture and accessories specified.

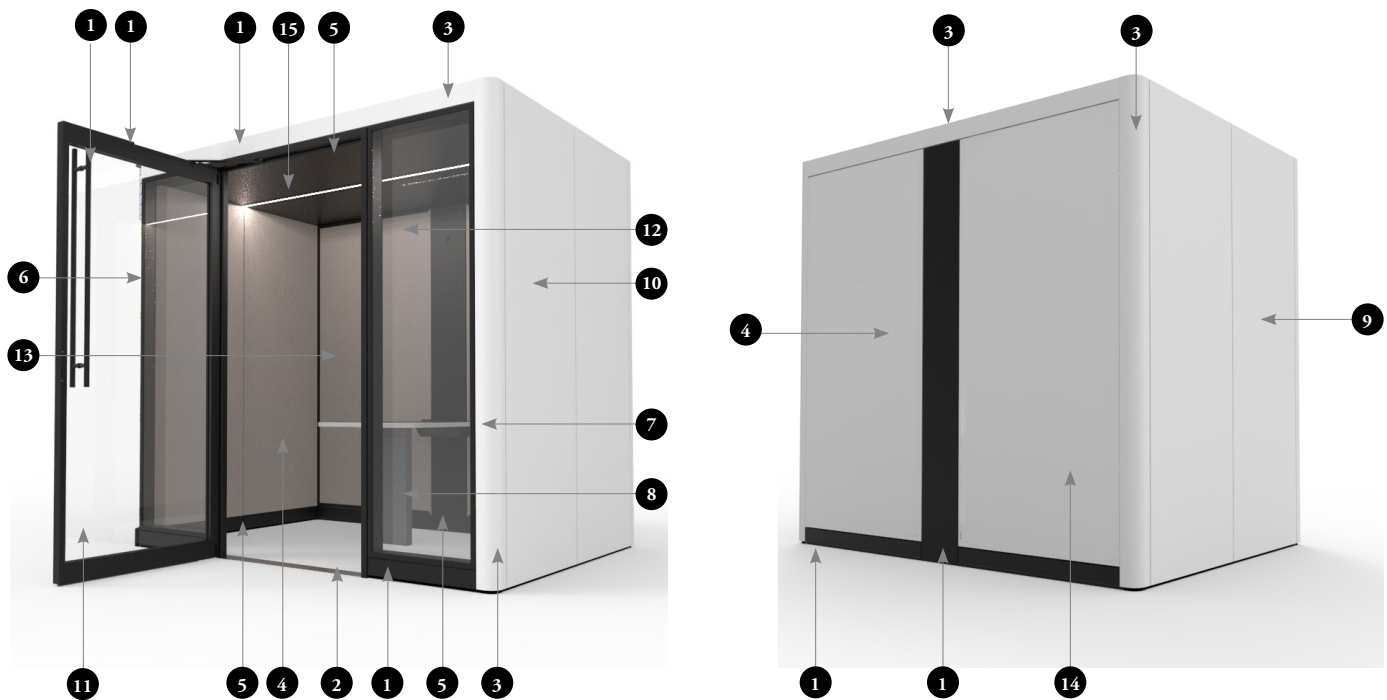

Images represent example of finish regions for one left handed version with additional center worksurface and coat/bag hook accessory

- 1 Door Frame, Door Leaf, Door Pull, Exterior Base Fascias, Exterior Technology Fascia, Glass Framing *
- 2 Door Threshold
- 3 Corner Trims
- 4 Interior Side Fascias (Acoustic Tackable)
- 5 Interior Base Fascias, Ceiling Fascias, Vertical Technology Fascia *
- 6 Coat / Bag Hook *
- 7 Worksurface (Solid)
- 8 Worksurface Support and Power Module *
- 9 Left Side Exterior fascia (Solid)
- 10 Right Side Exterior fascia (Solid)
- 11 Door Insert (Clear Glass)
- 12 Front Fascias (Clear or Frosted Glass)
- 13 Interior Back Fascias (Fabric Wrapped or Solid)
- 14 Exterior Back Fascias (Backpainted Glass or Solid)
- 15 Ceiling Light*

Finishes

- Metal painted finishes available in Foundation, Mica and Accent paint
- Certain finish regions only available in Ebony or Anthracite paints *
- Exterior fascias available in Foundation Laminate, Flintwood and Source Laminate
- Fabric Fascias are available in select Teknion Architectural Fabrics
- Worksurface finish includes Foundation Laminate, Source Laminate or Flintwood
- Threshold offered in Stainless finish as standard

tek room size and dimensions

The following should be considered when planning with Tek Room.

- All dimensions shown are nominal values
- Base leveling range of $-1/4"$ (0.635cm) to $+1-3/4"$ (4.4cm)

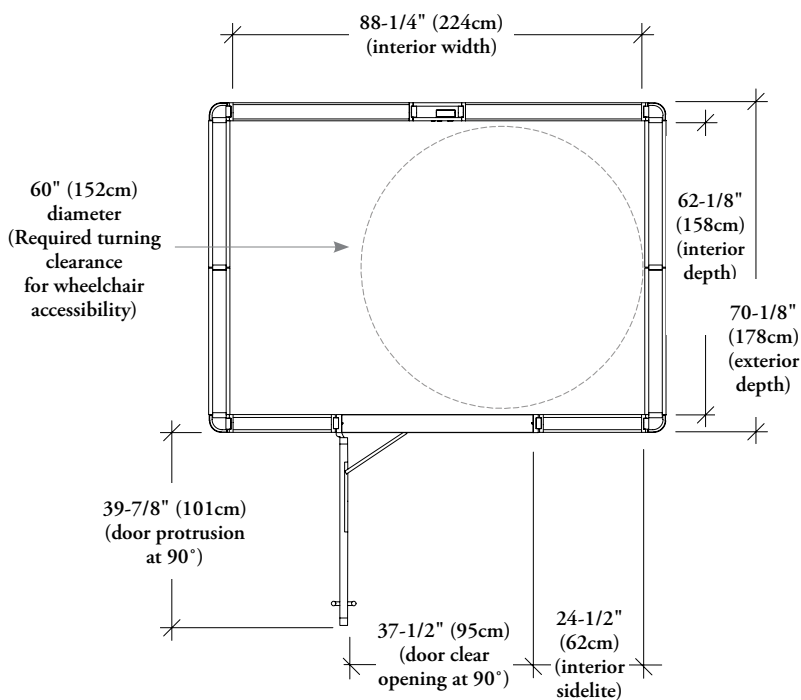
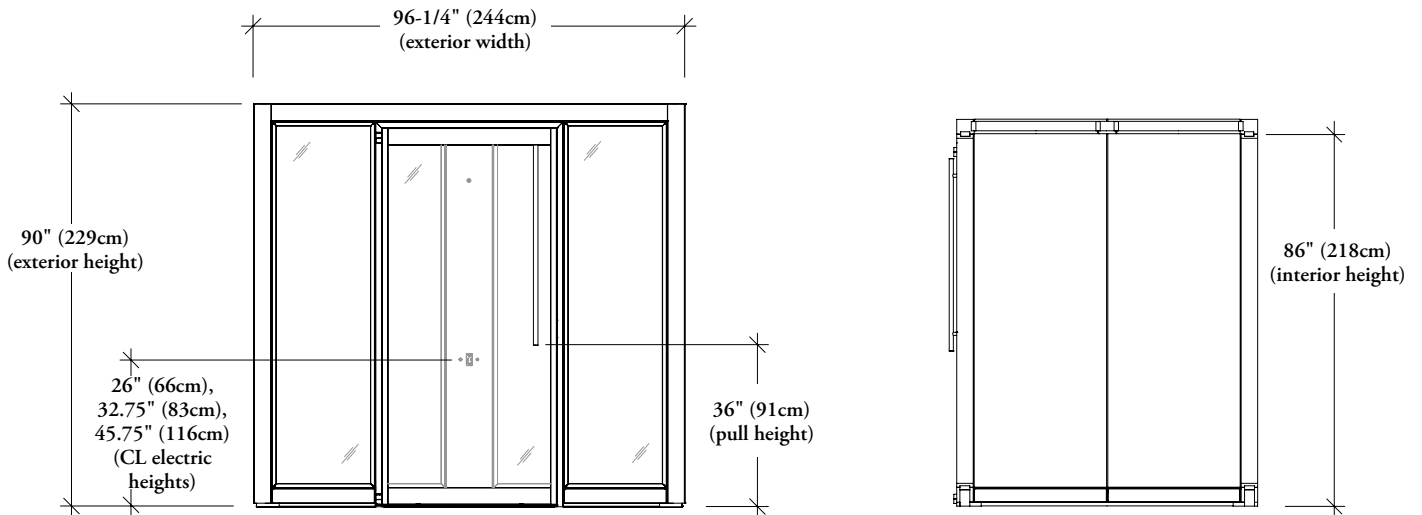

tek room orientation

Tek Room's orientation is determined by the handedness of the pivot door as viewed from the front exterior. Tek Room's door pivots open to the exterior only.

left orientation



right orientation



tek room fascia features

Tek Room fascias are configured to provide sound blocking and sound absorbing properties, while achieving a balance between visual privacy and light transmission. The following breaks down the overall fascia design configuration.

exterior fascias



The exterior side fascias (left and right) are composed of hard surfaces (solid or backpainted glass) and keep external noise from entering the room.

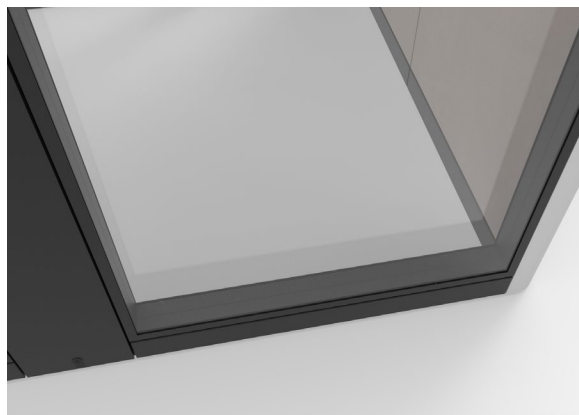

The 6mm double glazed back and front wall fascias provide light transmission into the room while keeping an acoustic barrier.

interior fascias

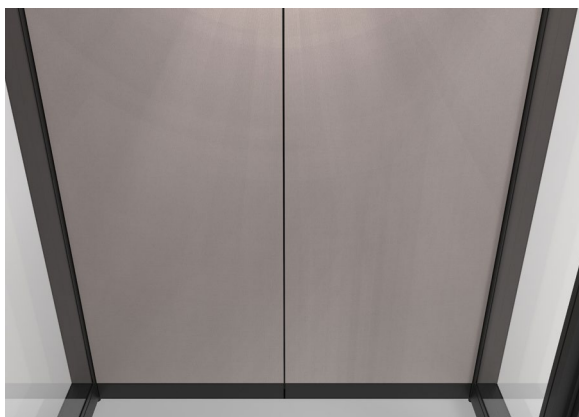

The interior side fascias (left and right) are composed of acoustic tackable fabric, providing sound absorption, a place to pin notes and a soft, comfortable visual aesthetic.

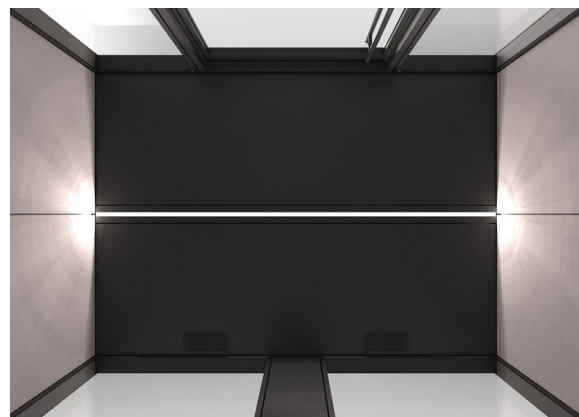

The interior base and ceiling fascias are composed of micro-perforated steel providing sound absorption, a low maintenance finish, ventilation capabilities and fire suppression integration.

tek room finish features

It is important to know the grain and fabric direction as well as maintenance requirements when specifying Tek Room. The following outlines directionality for both fascias and worksurfaces as well as basic cleaning guidelines.

fabric direction

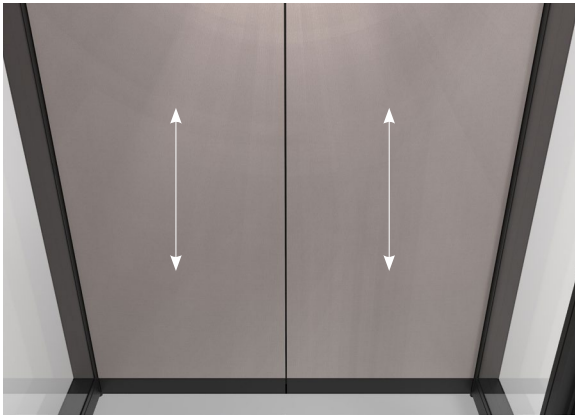

Fabric direction on all interior side fascias run off-the-bolt.

paint cleaning

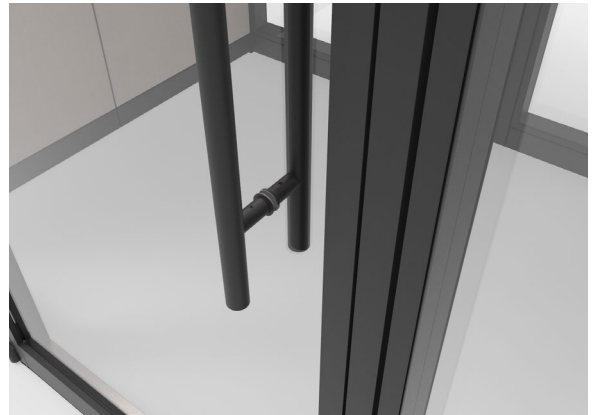

When cleaning pulls, it is important to note that no abrasive cleaners should be used so paint is not damaged or scratched

woodgrain direction



The woodgrain on the center and side worksurface runs the length of the surface.

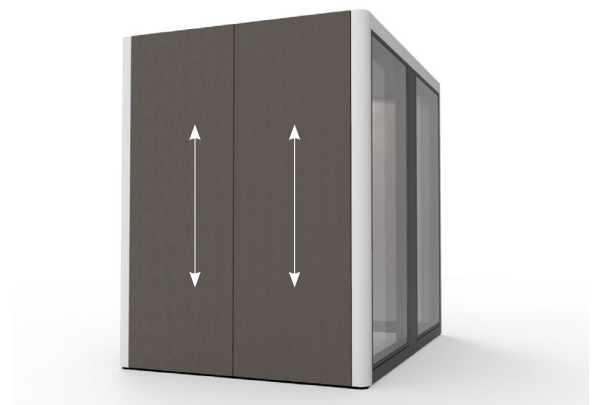

The woodgrain on all exterior fascias runs vertical.

tek room automated door features

The following describes the main features to consider when specifying door automation on Tek Room.

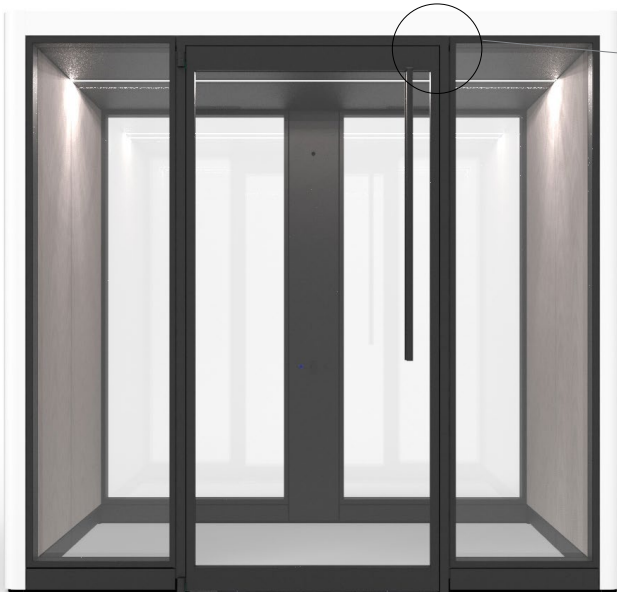

Automated Door Frame

- 2.4" (6cm) wide door frame accommodates automated hardware
- Clear opening: 37-1/2" (95cm)
- Header clearance: 83" (211cm) AFF



The 2.4" (6cm) wide door frame is only used when the automated door is specified.

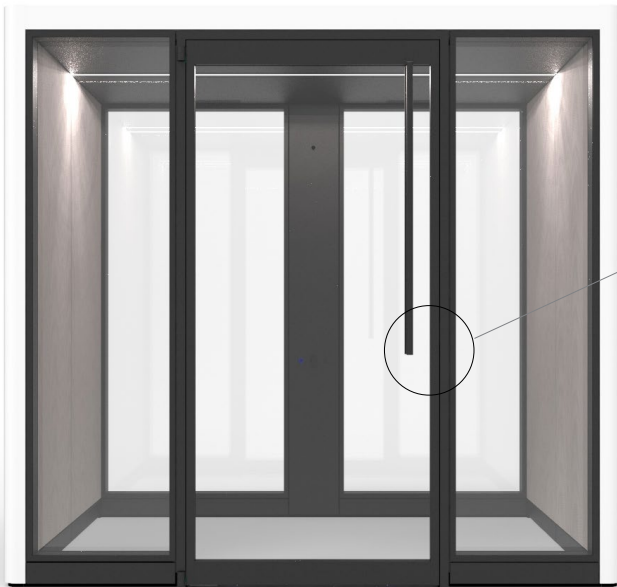

Hand Activator (Automated option)

- Touch free hand activator triggers the door to open
- Located in the door jamb on the strike side of the door leaf
- Interior and exterior mounted (double sided)
- Mount height: 38-1/2" (98cm) AFF CL
- Hand activation range: 0-3"
- Time delay: 5 seconds
- Black polycarbonate finish with hand icon standard



Hand activation range is preset by Teknion and is recommended to avoid accidental activation from body movement while inside the room.

Time delay is preset by Teknion and represents the minimum time the user must wait before reactivating the door.

tek room automated door features (continued)



Hand Activator (Automated Accessible option)

- Touch free hand activator triggers the door to open
- Located in a side panel on the strike side of the door leaf
- Over 12" (30cm) away from the swing path of door for accessibility
- Interior and exterior mounted (double sided)
- Mount height: 38-1/2" (98cm) AFF CL
- Hand activation range: 0-3"
- Time delay: 5 seconds
- Black polycarbonate finish with hand icon standard



Hand activation range is preset by Teknion and is recommended to avoid accidental activation from body movement while inside the room.

Time delay is preset by Teknion and represents the minimum time the user must wait before reactivating the door.

The interior strike side of the door must be free of furniture and objects to ensure access to the hand activator.

tek room automated door features (continued)

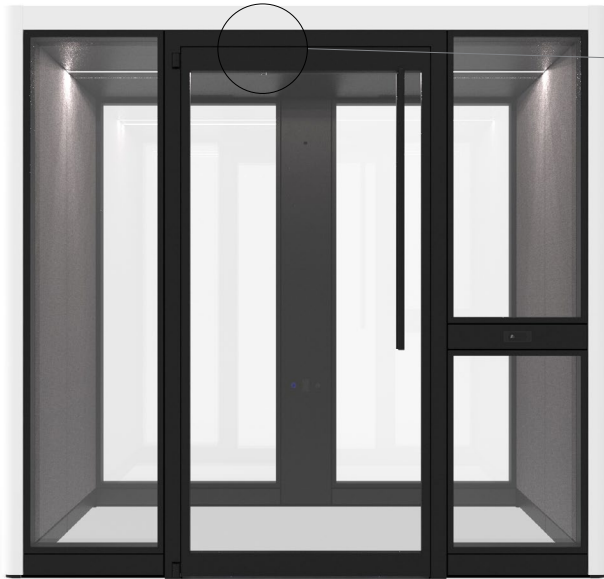
**Automatic Door Operator**

- Low energy, electro-mechanical swing door opener and closer
- Mounted on interior of door frame header (push side)
- Opening time: 4.5 seconds
- Opening angle: 90-100°
- Hold open time: 5 seconds
- Closing time: 4.5 seconds
- Dark finish standard



The opening time, opening angle, hold open time and closing time are specific settings recommended by Teknion.

The following settings are optional:

- Power assist - aids in the manual opening of the door
- Push and go - allows the door to open automatically when the operator senses manual movement of the door
- Stop on stall - door will stop when it hits an obstruction
- Reverse upon obstruction' - door will stop and reverse when it hits an obstruction

The automatic door operator can only work with plug-in electrics. In the event of a power loss, the door can be opened manually.

tek room automated door features (continued)

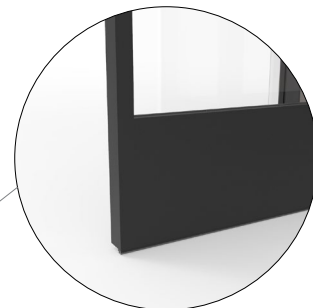
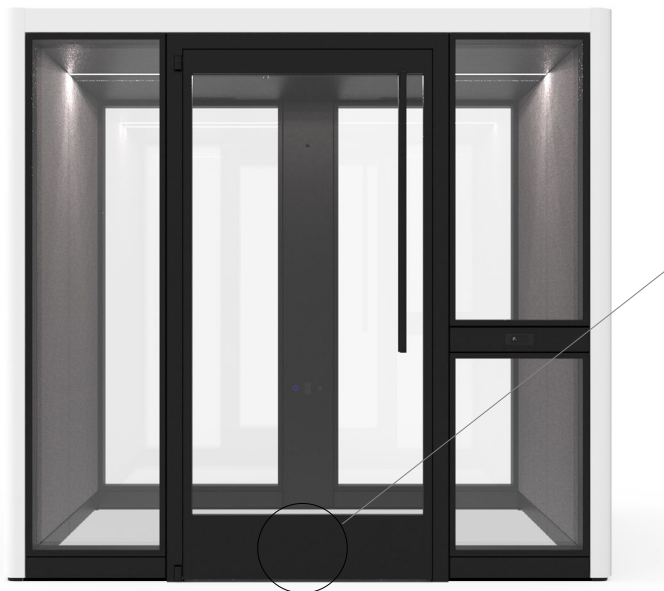

Kickplate

- Kickplates are an optional item for Tek Room automated doors
- If hand activation is sufficient for accessibility, consider a door without a kickplate
- If hand activation is insufficient for accessibility, consider a door with a kickplate
- If a kickplate is required, consider programming the door operator for 'Power assist'
- If a kickplate is required, consider programming the door operator for Push and go



Signage

- Signage for automated doors are not supplied directly by Teknion
- Below are Teknion's recommendations;
- Apply signage decal 38"-62" AFF CL, on both sides of the door
- Automatic Caution Door signage must have minimum 6" diameter with black text on yellow background
- Activate Switch to Operate signage is required for the hand activator, and must be white on blue background
- Push to Operate and Pull to Operate signage is only required if the door operator has been programmed for Push and go
- All text must be 5/8" tall minimum

tek room interior features

Positioned on the center back wall, Tek Room’s vertical technology column is equipped with a dimmable light switch, occupancy sensor and receptacle outlet. Below gives an overview of these features.

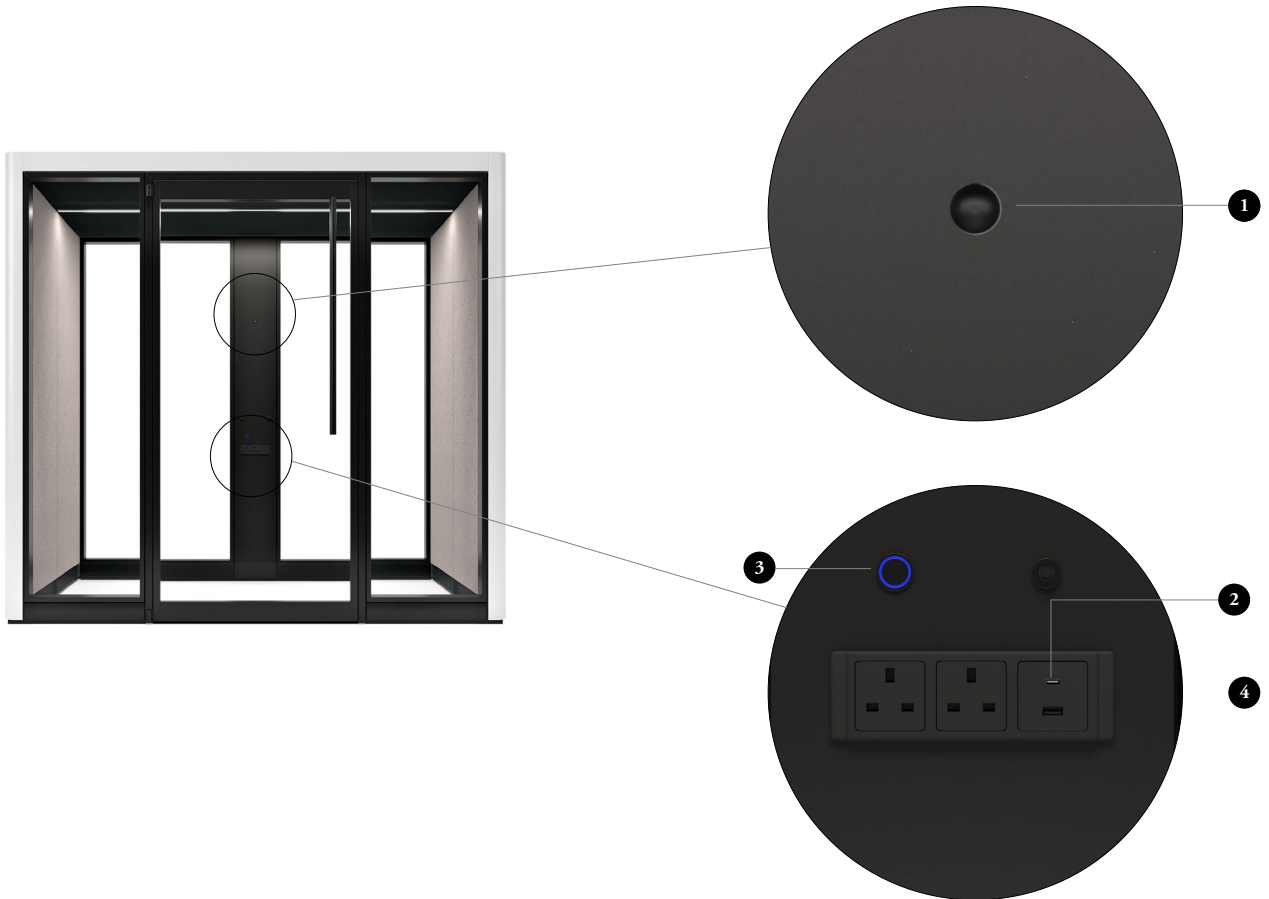

1 Occupancy Sensor

When the user enters the room the occupancy sensor is activated, automatically turning on ventilation fans and the ceiling light. If no movement is detected after 5 minutes, the fan and light will automatically turn off

2 Receptacle

The vertical technology fascia is equipped with a 3-Gang power that also contains option of one USB-A and one USB-C outlet. The receptacle is offered in black finish only

3 Dimmable Light Switch

The dimmable LED light switch allows for full control over the ceiling light intensity. To dim or increase light intensity, hold down the button. To turn the light on and off, tap the button. Light brightness resets to the default brightness after shutting off.



There are three additional power outlets on the electrical box located behind the vertical technology fascia to plug in secondary devices if required (e.g. monitor). Ensure any cable routing behind fascias will pass local inspection codes. Please note, secondary high voltage powerbars / cubes cannot be daisy chained to this unit.

Tek Room occupancy sensor turn off time can be increased beyond 5 minutes if required by the end user. Installation instructions are available upon request.

tek room interior features (continued)

The following describes the features built into the interior ceiling.

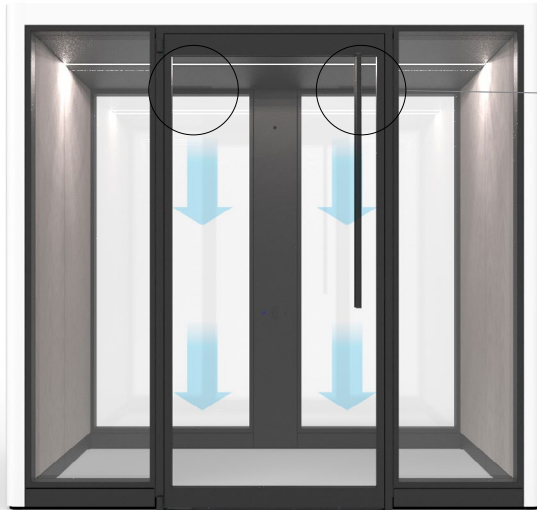

Ventilation

Ventilation intake is provided by two pairs of low noise fans integrated into the micro-perforated back ceiling fascia. The fans work in tandem with the base fascia, which acts as an exhaust, enabling full air exchange.

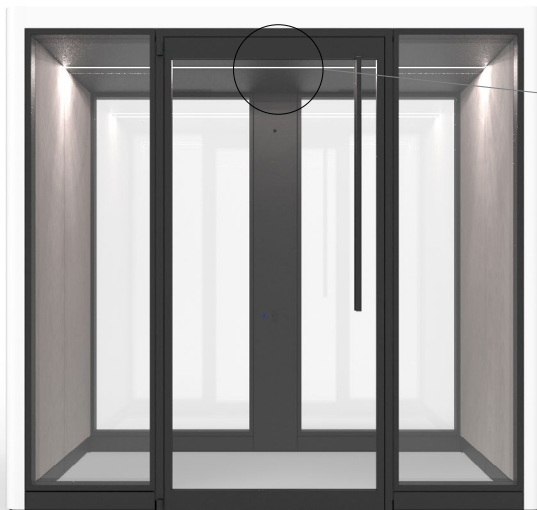

Ceiling Light

The recessed LED ceiling light spans the full interior width of the room. Once activated, the light intensity can be controlled by the light switch located on the vertical technology column.

Fire Suppression Prep

The micro-perforated front ceiling fascia comes standard with a punch out prep for easy sprinkler installation.



Tek Room can be retrofitted with sprinklers if required, but are not included as standard.

tek room interior features (continued)

The following describes additional interior features.

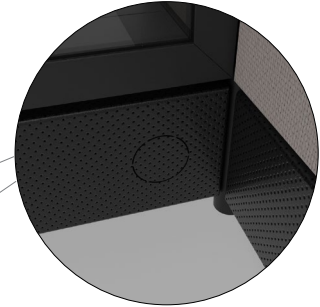
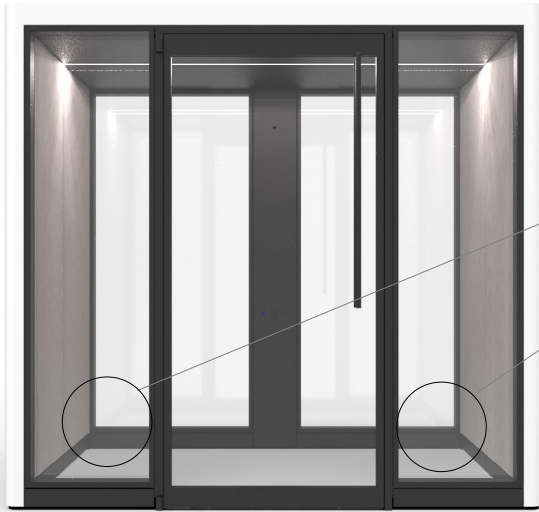

Cable Routing Prep

The micro-perforated base fascias on the interior back wall come with punch out preps and a grommet kit to accommodate internal cable routing of secondary devices if required.



When planning to use internal cable routing, please ensure practice will pass local codes and inspection.

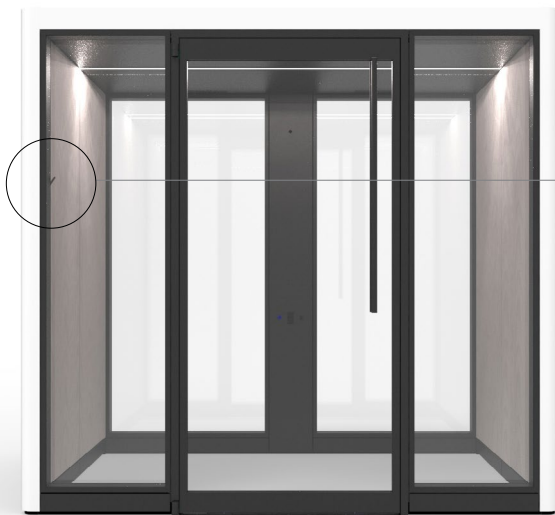

Coat / Bag Hook

The coat / bag hook can be installed in any interior corner, at any height (in 1" (2.54cm) increments). Please consider the following general recommendations when planning the coat hook height;

Accessible Coat Hook Height: 15" (38cm) - 48" (122cm) AFF

Non-Accessible Coat Hook Height 48" (122cm) - 66" (168cm) AFF

tek room exterior features

The following describes the exterior corner trim options available on Tek Room.



Round Corner Trim

The round corner trim option provides a soft exterior aesthetic. The vertical and horizontal trim components meet at a butt joint.



Square Corner Trim

The square corner trim option provides a rectilinear exterior aesthetic. The vertical and horizontal trim components meet at a miter joint.

tek room center worksurface features

Tek Room's center worksurface is ideal for environments requiring collaboration and technology integration. Below describes the main design features.



Worksurface

- 38" (96cm) wide x 30" (76cm) deep
- Fastened to vertical technology column

Mono Leg

- 29" (77cm) or 42" (107cm) high
- 9" (23cm) wide footprint
- Leveling capabilities

Power Module

- Allows access to communication cables
- Works in tandem with TV / monitor

tek room planning with the center worksurface

The following shows the center worksurface planning configurations and the relevant rules and restrictions.



29" (74cm) High Worksurface with Power Module

- 29" (74cm) high electrics must be specified on vertical technology column
- Monitor must be used when specifying Power Module
- Monitor cannot be wider than 30" (76cm)
- Monitor and monitor cables are not included



29" (74cm) High Worksurface without Power Module

- 29" (74cm) high electrics must be specified on vertical technology column
- Monitor cannot be used



42" (107cm) High Worksurface with Power Module

- 42" (107cm) high electrics must be specified on vertical technology column
- Monitor must be used when specifying power module
- Monitor cannot be wider than 30" (76cm)
- Monitor and monitor cables are not included



42" (107cm) High Worksurface without Power Module

- 42" (107cm) high electrics must be specified on vertical technology column
- Monitor cannot be used

tek room side worksurface features

Tek Room's side worksurface is ideal for environments requiring focused work, accessibility and technology integration. Below describes the main design features.



Wire Management Kit

- Can be mounted horizontally below worksurface
- Can be mounted vertically in corner of fascias

Worksurface

- 62" (157cm) wide x 23" (58cm) deep (22" (56cm) actual depth with 1" (2.54cm) gap)
- 1" (2.54cm) gap between fabric fascia and worksurface to allow edge mounting of secondary accessories and devices (e.g. monitor arm)

Power Module

- Allows access to communication cables
- Works in tandem with monitor

Cantilever Bracket

- Can be mounted to wall at any height in 1" (2.54cm) increments
- Provides unobstructed leg clearance

tek room planning with the side worksurface

The following shows the side worksurface planning configurations and the relevant rules, restrictions and recommendations.



Worksurface with Power Module

- Recommended when communication cables are required (e.g. monitor, ethernet)
- Monitor, monitor arm and monitor cables are not included
- 15 ft monitor power cord is recommended to reach Tek Room's electrical unit



Worksurface without Power Module

- Recommended when secondary communication devices are not required (e.g. monitor, ethernet)



Worksurface Height

- The side worksurface can be installed for sitting or standing
- Please note, the side worksurface is not height-adjustable by the end user
- Recommended overall height range: 22" (56cm)- 48" (122cm)
- Recommended wheelchair accessible height range: 28" (72cm)- 34" (86cm)



Additional Accessories

- Any additional edge mounted accessories must be specified separately
- For Teknion accessories, please refer to teknion.com



Please note, secondary high voltage powerbars / cubes cannot be daisy chained to Tek Room's main electrical unit. A separate power source must be used in this application. If planning, please ensure power cord length is sufficient to reach source.

When planning to use internal cable routing, please ensure practice will pass local codes and inspection.

tek room planning with freestanding furniture

The following shows examples of how Tek Room can be planned with freestanding furniture in various work settings.

Please note, any freestanding furniture required inside of Tek Room must be specified separately.
For Teknion furniture offerings, refer to www.teknion.com.

Collaborative

- Lounge seating
- 29" (74cm) high electrics shown



Collaborative

- Barstool table and seating
- 42" (107cm) high electrics shown

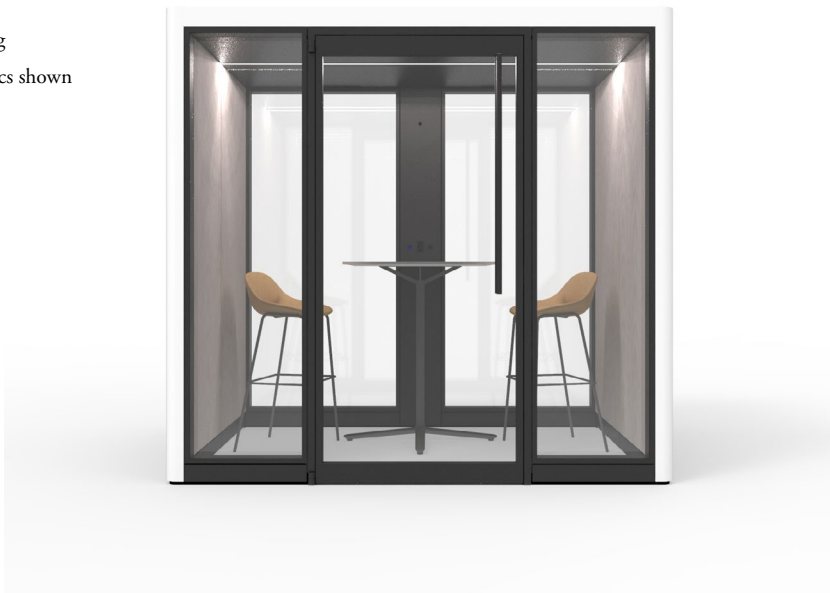

tek room planning with freestanding furniture (continued)

Teleconferencing

- Lounge seating, task table and casegoods
- 29" (74cm) high electrics shown

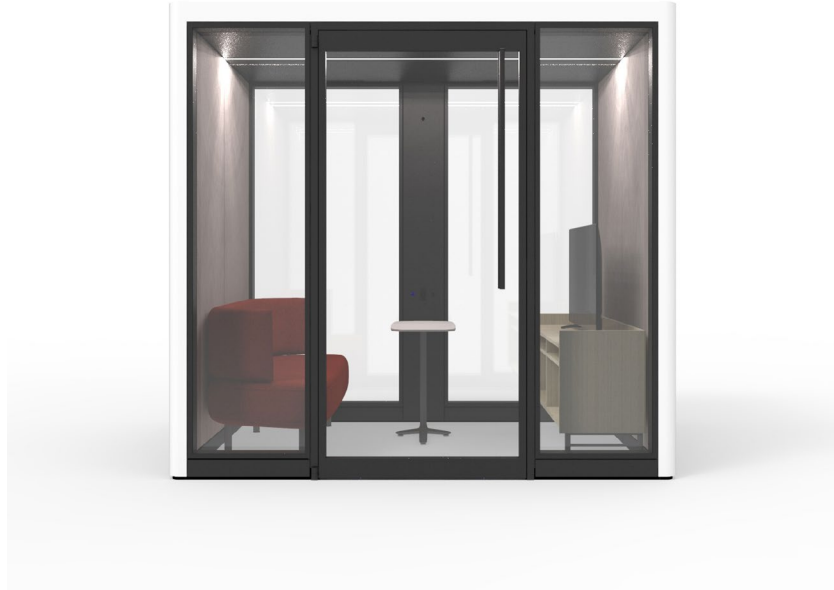

Casual meeting

- Lounge seating and side table
- 26" (66cm) high electrics shown

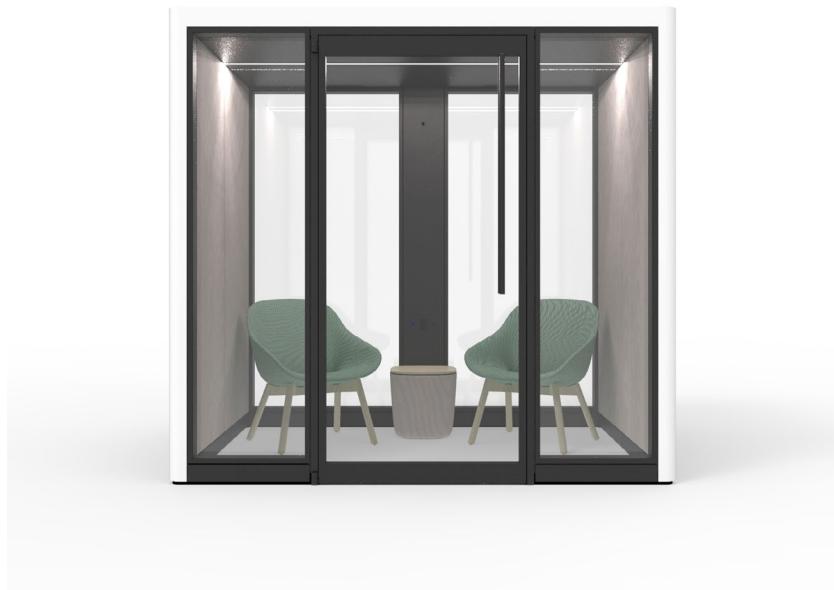

tek room planning with freestanding furniture (continued)

Focused work

- Task and lounge seating
- 26" (66cm) high electrics shown



Focused work

- Lounge seating, ottoman, task and height-adjustable table
- 26" (66cm) high electrics shown



Please consider the following when planning with height-adjustable tables to ensure proper fit and function within Tek Room.

- Maximum worksurface size: 60" (152cm) wide x 24" (61cm) deep
- Electrified tables can be plugged directly into Tek Room's electrical unit, as long as cord length is sufficient
- Electrified tables with IEC connectivity can directly power multiple worksurface devices and accessories, including high voltage powerbars/cubes
- If planning to use internal cable routing, please ensure practice will pass local codes and inspection



tek room planning with freestanding furniture (continued)

Accessible, casual meeting

- Lounge seating and task table
- 60" (152cm) turning diameter clearance for wheelchair within interior
- Maneuvering clearance on interior strike side of door
- 26" (66cm) high electrics shown

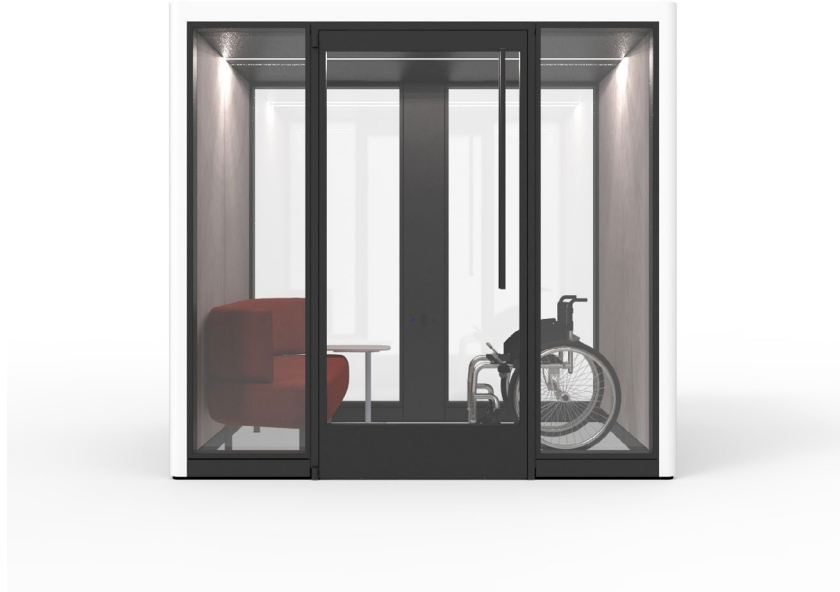

Accessible, focused work

- Height-adjustable table
- 60" (152cm) turning diameter clearance for wheelchair within interior
- Maneuvering clearance on interior strike side of door
- 26" (66cm) high electrics shown



Please consider the following when planning with height-adjustable tables to ensure proper fit and function within Tek Room;



- Maximum worksurface size: 60" (152cm) wide x 24" (61cm) deep
- Electrified tables can be plugged directly into Tek Room's electrical unit, as long as cord length is sufficient
- Electrified tables with IEC connectivity can directly power multiple worksurface devices and accessories, including high voltage powerbars / cubes
- If planning to use internal cable routing, please ensure practice will pass local codes and inspection



tek room planning with electrics



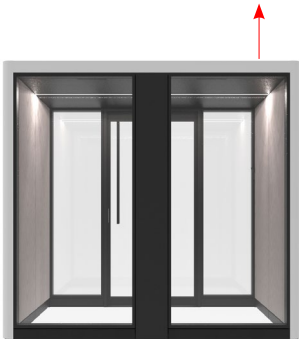
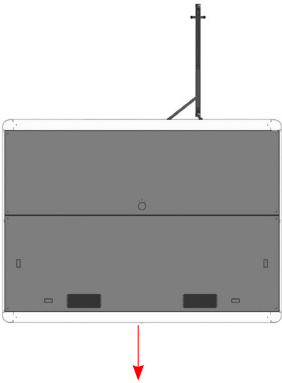
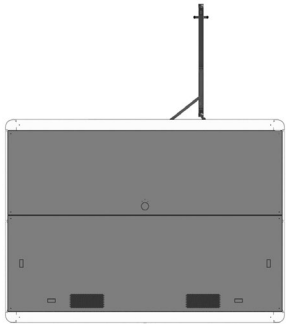



Tek Room offers base and ceiling feeds for routing electrics to the base building. The following should be considered when planning with base and ceiling feeds.

- The base feed location is always centered on the back of the vertical technology column
- There are 4 ceiling feed locations which can be used (2 back left, 2 back right)
- Base feed grommet is always supplied in black finish
- Base and ceiling feed use a black power cord for plug in electrics

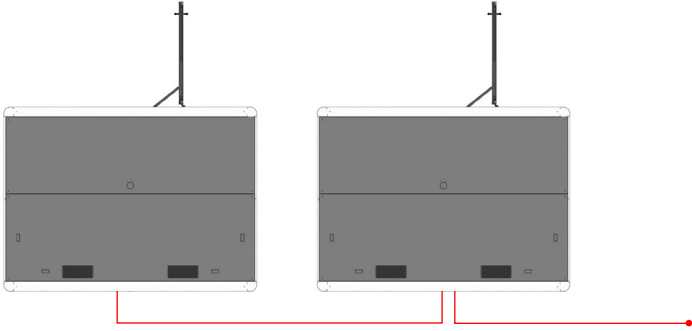
	Base Feed	Ceiling Feed
Back View		
Top View		
Detail View		

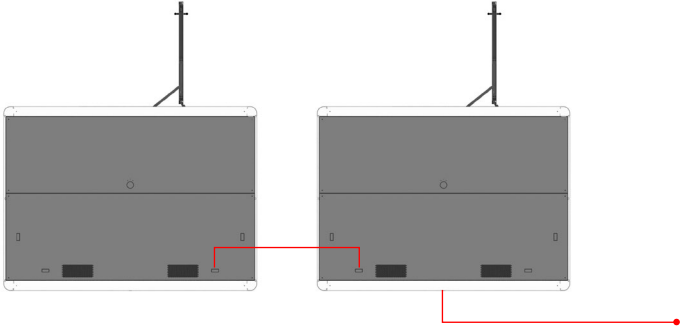
tek room planning with electrics (continued)

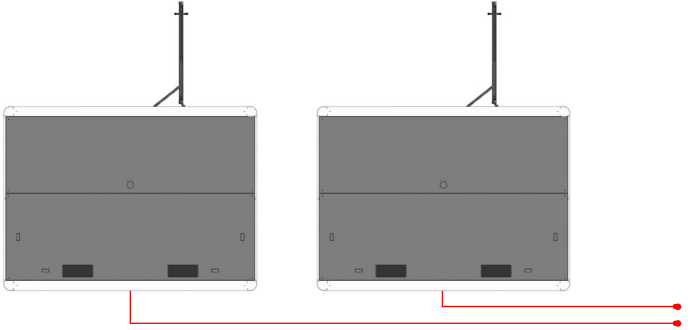
The following rules and restrictions should be considered when planning Tek Room in tandem and connecting electrically to the base building.

<p>Daisy Chain Base Feed Connected to building by base or ceiling feed</p>		
<p>Daisy Chain Ceiling Feed Connected to building by base or ceiling feed</p>		
<p>Parallel / In Series Connected to building by base or ceiling feed</p>		

teknion

www.teknion.com

CAN/US/INT 10-28
©Teknion 2024

®, ™ trade marks of Teknion Corporation
and/or its subsidiaries or licensed to it.
Patents may be pending.

Some products may not be available in
all markets. Contact your local Teknion
Representative for availability.

OCT24-AIH-PG