

filing & storage (europe)

price & application guide

10.24.2022



teknion



INDEX . . . . .	7
APPLICATION GUIDE . . . . .	9
PRICE GUIDE . . . . .	17



# where to find the information you need

Teknion provides an array of tools and information resources to help you get things done simply and easily. From product pricing to application guidelines to online planning suggestions, you will find what you need when you need it.

## guide contents

This guide contains all the information you need to order this product through your specification software. The Introduction section provides everything you need to get started, including an index for product reference. The Application Guide section contains detailed specification guidelines, application and planning information to help you plan your project correctly. The Price Guide sections provide detailed pricing and specification information by product type. Available online at [www.teknion.com](http://www.teknion.com).

---

## where to find the information you need

All Teknion marketing materials are available online at [www.teknion.com](http://www.teknion.com), including:

price & product guide

application guide

planning tool

installation guides

fabrics & finishes

product photography & drawings

weights & volumes

order forms

warranty/terms & conditions of sale

xpress program guide

---

## teknion forms

The following forms are available online at [www.teknion.com](http://www.teknion.com), to help you specify and place your order if required:

### teknipaint

If you require a custom paint color match, you must submit a TekniPaint form.

### using your own material (COM)

If you wish to use your own material on fabric-covered products, you must submit a completed COM form including a sample upholstery and safety testing. A COM Order Information Sheet must also be submitted. This form captures all relevant ordering and tracking information. A COM Request for Yardage Calculation form may be sent to Teknion for preliminary yardage requirements.

### placing a manual order

Complete an Order Cover Sheet with the information we need to fill your order. This is the most important step. If the Order Cover Sheet is not complete and correct, the order may be delayed.

---

## key requirements

If you require that certain pieces share the same locks you will need to specify Set of Keys Alike (SOKL) located in the Price and Product Guide.

---

## user feedback

How is our marketing material working for you?

Feedback from the user is very important to the quality of Teknion's marketing material. We ask that if you have suggestions on how you think we could improve content OR if you have found an error, that you contact your Teknion Technical Services department.



Section Contents	Product Code	Page No.
<b>INTRODUCTION</b>		
Where to find the information you need		5
<b>APPLICATION GUIDE</b>		
Mobile Pedestal Basics		10
Planning with Mobile Pedestals		11
Freestanding Storage Basics		12
Locker Basics		13
Planning with Lockers		14
<b>PEDESTALS</b>		
Mobile Pedestal - Standard, Metal	ESMPS	20
Mobile Pedestal - Standard with Cushion, Metal	ESMPSC	21
Mobile Pedestal - Tall (Legacy), Metal	ESMPT	22
tn Bag Drop	ETNMB	23
<b>FREESTANDING STORAGE</b>		
Hinged Door Cabinet, Metal	ESMFH	26
Lateral Drawer File, Metal	ESMFL	27
Lateral & Hinged Door Worksurface for Metal Storage	ESMAW	28
Accessories	ESMA	29
<b>LOCKERS</b>		
Single Locker, Metal	ESMLS	32
Double Locker, Metal	ESMLD	33
Triple Locker, Metal	ESMLT	34

application guide



# application guide

MOBILE PEDESTAL BASICS . . . . .	10
PLANNING WITH MOBILE PEDESTALS . . . . .	11
FREESTANDING STORAGE BASICS . . . . .	12
LOCKER BASICS . . . . .	13
PLANNING WITH LOCKERS . . . . .	14

## mobile pedestal basics

Mobile Pedestals are available in a variety of heights and drawer configurations to integrate aesthetically with all products in the Teknion portfolio.

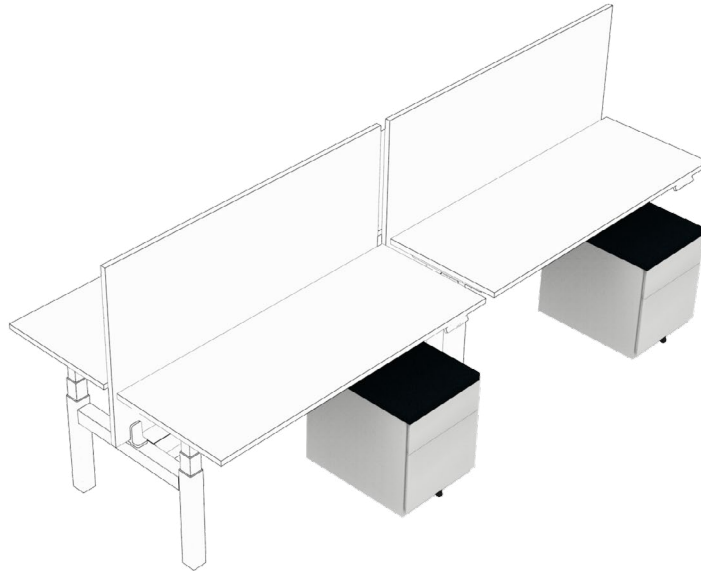

### Finishes

- Case finishes available:
  - Ebony
  - Very White
- Cushion finish available:
  - Camira-Xtreme
- Felt finish:
  - Alloy

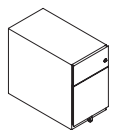

Box, File

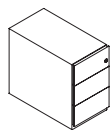

Box, Box, Box

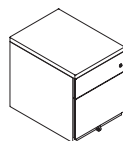

Box, File

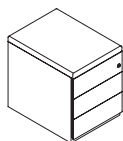

Box, Box, Box

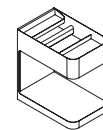
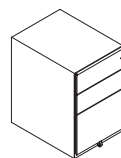

### Mobile Pedestal - Standard, Metal (ESMPS)

- A mobile pedestal with drawers
- Width: 420mm
- Height: 495mm
- Depth: 565mm
- Caster Options:
  - 5 casters (one anti-tilt caster, does not require a counterweight)
- Pedestal file drawers accommodate both imperial and A4 filing sizes
- Drop-in Pen Tray (DIP) is available and order separately.

### Mobile Pedestal - Standard with Cushion, Metal (ESMPSC)

- A mobile pedestal with drawers and a seat cushion
- Available configurations: Box,File and Box, Box, File
- Width: 300mm, 420mm
- Height: 495mm
- Depth: 565mm
- Caster Options:
  - 5 casters (one anti-tilt caster, does not require a counterweight)
- Pedestal file drawers accommodate both imperial and A4 filing sizes
- Drop-in Pen Tray (DIP) is available and order separately.

### Mobile Pedestal - Tall (Legacy), Metal (ESMPT)

- A mobile pedestal with drawers
- Available configurations: Box,File and Box, Box, File
- Width: 420mm
- Height: 695mm
- Depth: 565mm
- Caster Options:
  - 5 casters (one anti-tilt caster, does not require a counterweight)
- Pedestal file drawers accommodate both imperial and A4 filing sizes
- Cannot be used under a Height-Adjustable Desk
- Drop-in Pen Tray (DIP) is available and order separately

### tn Bag Drop (ETNMB)

- An open mobile storage unit for storing personal belongings
- Optional rail shelf
- Available with two finish locations, primary and second and includes a felt bottom liner

# planning with mobile pedestals

The following should be considered when planning with Pedestals.

Careful attention should be given to pedestal heights, as not all pedestals can be used under a height adjustable table

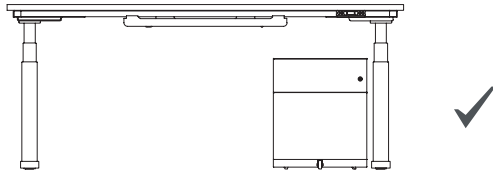

Mobile Pedestal, Standard

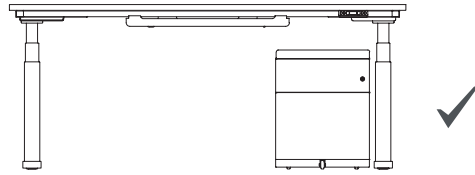

Mobile Pedestal Standard with Cushion

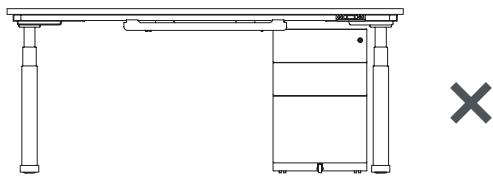

Mobile Pedestal Tall

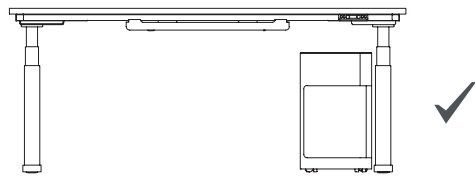

t'n Bag Drop

The t'n Bag Drop can specified with a Primary and Secondary Paint Finish. The following outlines where these finishes are applied.

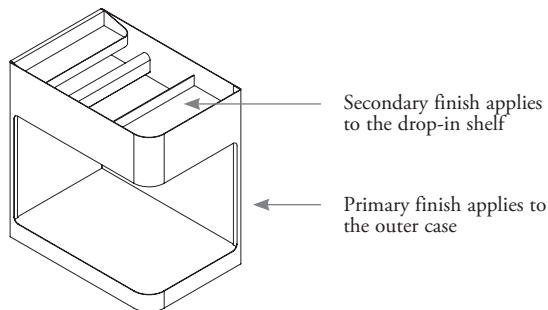

## freestanding storage basics

Freestanding Lateral Files and Hinged Door Cabinets are available in a variety of configurations.

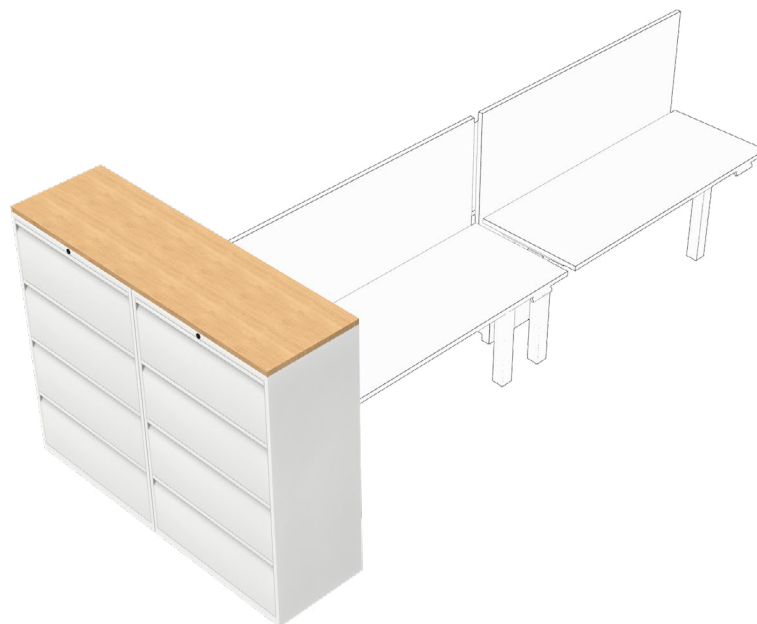

### Finishes

- Case finishes available:
  - Ebony
  - Very White
- Worksurface finish available:
  - Oak
  - Walnut
  - Light Walnut
  - White
  - Snow White

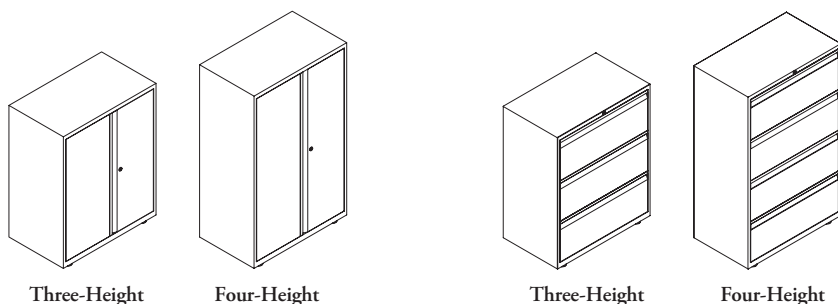

### Hinged Door Cabinet, Metal (ESMFH)

- Provide closed storage and can be configured with a variety of accessories
- Height: 997mm (3H), 1301mm (4H)
- Width: 800mm, 1000mm
- Depth: 470mm
- All accessories are ordered separately

### Lateral Drawer File, Metal (ESMFL)

- Lateral Files provide closed file drawers
- Height: 997mm (3H), 1301mm (4H)
- Width: 800mm, 1000mm
- Depth: 470mm
- Counterbalance is included in both three and four-high units

### Lateral & Hinged Door Worksurface for Metal Storage (ESMAW)

- Used on the top of a Lateral Drawer Files and Hinged Door Cabinet
- Width: 800mm, 1000mm, 1600mm
- Depth: 470mm
- Can be used as a single on the matching cabinet width, or the 1600 mm can be used to span across two 800 mm cabinets



Cross Rails for Lateral, Metal Storage



Shelf Divider Pack, Metal Storage



Piggy Back Cross Rails for Lateral, Metal Storage

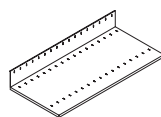

Slotted Shelf, Metal Storage

### Accessories (ESMA)

- Used within a Lateral Drawer File or Hinged Door Cabinet to provide functionality

# locker basics

Locker Towers are available in a variety of configurations to provide personal and coat storage.

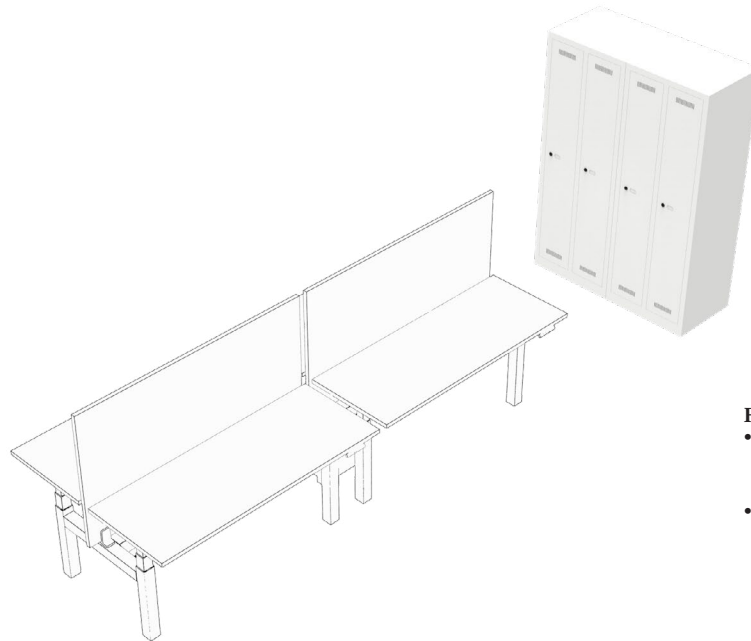

**Finishes**

- Case finishes available:
  - Ebony
  - Very White
- Door Paint finish available:
  - Ebony
  - Very White

- Height: 1700mm
- Depth: 500mm
- Doors available per section:
  - One Doors
  - Two Doors
  - Three Doors
  - Four Doors
- Lock Type:
  - Standard Lock, Metal
  - Digital Lock Metal
  - RFID Lock, Metal
  - Combination Lock, Metal
- All lockers can be ganged

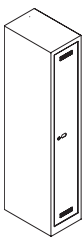

**Single Locker, Metal (ESMLS)**

- Width: 322mm

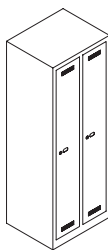

**Double Locker, Metal (ESMLD)**

- Width: 610mm

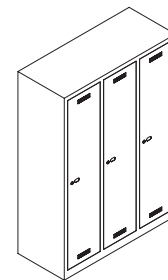

**Triple Locker, Metal (ESMLT)**

- Width: 900mm

# planning with lockers

The following outlines the available locker configurations available.

## Single Locker Configurations

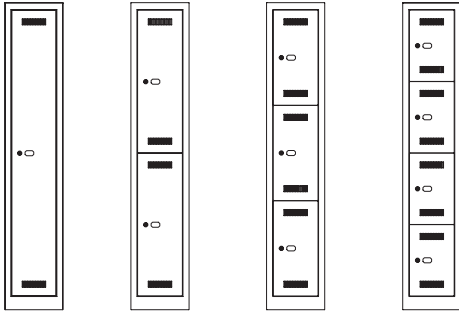

One Door (1) Two Door (2) Three Door (3) Four Door (4)

## Double Locker Configurations

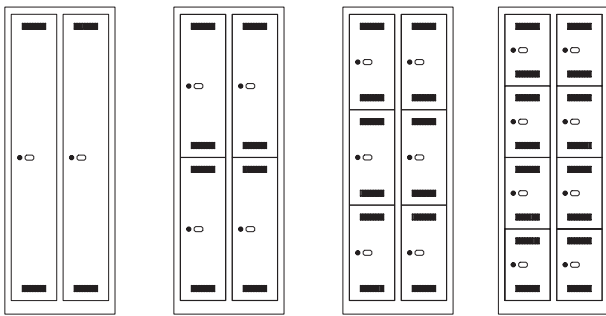

One Door (1) Two Door (2) Three Door (3) Four Door (4)

## Triple Locker Configurations



One Door (1) Two Door (2) Three Door (3) Four Door (4)



price & product guide



# price & product guide

PEDESTALS . . . . .	19
FREESTANDING STORAGE . . . . .	25
LOCKERS . . . . .	31

pedestals

# product map

## ESMPS Mobile Pedestal - Standard, Metal

Page 20

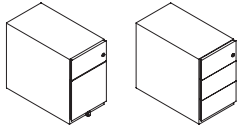

Box, File      Box, Box, Box

## ESMPSC Mobile Pedestal - Standard with Cushion, Metal

Page 21

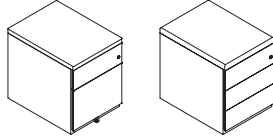

Box, File      Box, Box, Box

## ESMPT Mobile Pedestal - Tall (Legacy), Metal

Page 22

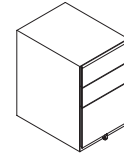

---

## ETNMB in Bag Drop

Page 23

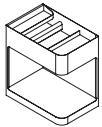

Right (shown)

---

# pedestals

## ESMPS

### Mobile Pedestal - Standard, Metal

#### WHAT'S INCLUDED

1 lockable steel pedestal, with fifth anti-tilt castor.

#### NOTES

Drop-In Pen Tray is included.

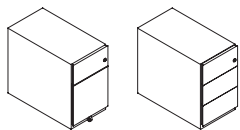

Box, File

Box, Box, Box

#### PRODUCT OPTIONS

Configuration	Width	Height	Depth	Case Finish	Key
<b>BFN</b> Box, File	<b>30</b> 300 mm	<b>49</b> 495 mm	<b>56</b> 565 mm	<b>52</b> Ebony	<b>K</b> Key Alike
<b>BBB</b> Box, Box, Box	<b>42</b> 420 mm			<b>83</b> Very White	<b>R</b> Key Random

#### SAMPLE ORDER CODE

<b>ESMPSU BFN</b>	<b>42</b>	<b>49</b>	<b>56</b>	<b>52</b>	<b>R</b>
-------------------	-----------	-----------	-----------	-----------	----------

#### DIMENSIONS CODE

#### PRICING

Box, Box, Box (BBB)	813
Box, File (BFN)	781

**WHAT'S INCLUDED**

1 lockable steel pedestal, with fifth anti-tilt castor and fabric covered seat pad.

**NOTES**

Drop-In Pen Tray is included.

**ESMPSC**

**Mobile Pedestal - Standard with Cushion, Metal**

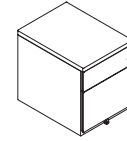

Box, File

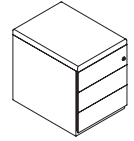

Box, Box, Box

**PRODUCT OPTIONS**

Configuration	Width	Height	Depth	Case Finish	Seat Finish	Key
<b>BFN</b> Box, File	<b>42</b> 420 mm	<b>49</b> 495 mm	<b>56</b> 565 mm	<b>52</b> Ebony	<b>F01</b> Camira Xtreme	<b>K</b> Key Alike
<b>BBB</b> Box, Box, Box				<b>83</b> Very White		<b>R</b> Key Random

**SAMPLE ORDER CODE**

<b>ESMPSCU BFN</b>	<b>42</b>	<b>49</b>	<b>56</b>	<b>52</b>	<b>H100</b>	<b>R</b>
--------------------	-----------	-----------	-----------	-----------	-------------	----------

**DIMENSIONS  
CODE**

**PRICING**

Box, Box, Box (BBB)
Box, File (BFN)

1324
1293

## ESMPT

### Mobile Pedestal - Tall (Legacy), Metal

#### WHAT'S INCLUDED

1 lockable steel pedestal, with fifth anti-tilt castor.

#### NOTES

Drop-In Pen Tray is included.

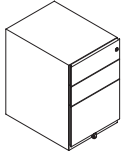

#### PRODUCT OPTIONS

Configuration	Width	Height	Depth	Case Finish	Key
BBF Box, Box, File	42 420 mm	64 645 mm	56 565 mm	52 Ebony	K Key Alike
				83 Very White	R Key Random

#### SAMPLE ORDER CODE

ESMPTU BBF	42	64	56	52	R
------------	----	----	----	----	---

#### PRICING

813
-----

**WHAT'S INCLUDED**

1 bag drop, with felt liner to lower section.

**NOTES**

Available with optional rail shelf.

Left or right orientation available.

**ETNMB  
tn Bag Drop**

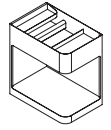

Right (shown)

**PRODUCT OPTIONS**

Configuration	Bottom Liner Style	Rail Shelf	Orientation	Primary Finish	Secondary Finish	Felt Finish
N No Accessories	F Felt	N No Y Yes	L Left R Right	52 Ebony 83 Very White	52 Ebony 83 Very White	NE Alloy

**SAMPLE ORDER CODE**

ETNMB N	F	Y	R	52	52	NE
---------	---	---	---	----	----	----

**DIMENSIONS  
CODE**

**PRICING**

No Rail Shelf (N)	690
With Rail Shelf (Y)	758

freestanding storage



# product map

## ESMFH Hinged Door Cabinet, Metal

Page 26

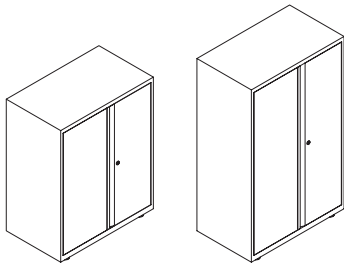

Three-Height

Four-Height

## ESMFL Lateral Drawer File, Metal

Page 27

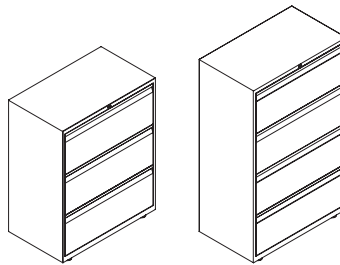

Three-Height

Four-Height

## ESMAW Lateral & Hinged Door Worksurface for Metal Storage

Page 28

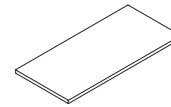

## ESMA Accessories

Page 29



Cross Rails for Lateral, Metal Storage

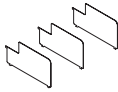

Shelf Divider Pack, Metal Storage



Piggy Back Cross Rails for Lateral, Metal Storage

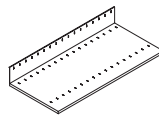

Slotted Shelf, Metal Storage

# freestanding storage

**E S M F H**

## Hinged Door Cabinet, Metal

### WHAT'S INCLUDED

1 lockable steel cupboard.

### NOTES

Cabinets are supplied empty. Shelves and fitting must be ordered separately.

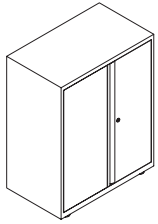

Three-Height

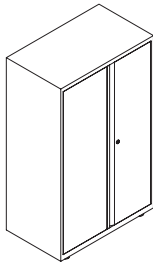

Four-Height

### PRODUCT OPTIONS

Configuration	Width	Depth	Case Finish	Key Style
<b>3H</b> Three-High (997 mm)	<b>080</b> 800 mm	<b>047</b> 470 mm	<b>52</b> Ebony	<b>K</b> Key Alike
<b>4H</b> Four-High (1301 mm)	<b>100</b> 1000 mm		<b>83</b> Very White	<b>R</b> Key Random

### SAMPLE ORDER CODE

<b>ESMFH 3H</b>	<b>080</b>	<b>047</b>	<b>74</b>	<b>R</b>
-----------------	------------	------------	-----------	----------

### DIMENSIONS CODE

D	W
470	800
470	1000

### PRICING

Three-High	Four-High
1988	2152
2098	2365

**WHAT'S INCLUDED**

1 steel lateral file drawer unit, complete with file bars for suspension filing.

**NOTES**

Counterbalance is included in both Three and Four-High units.

**ESMFL**  
**Lateral Drawer File, Metal**

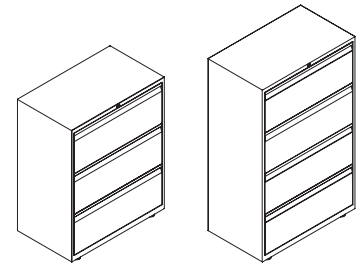

Three-Height

Four-Height

**PRODUCT OPTIONS**

Configuration		Width		Depth		Case Finish		Front Finish		Key Style	
<b>3H</b>	Three-High (997 mm)	<b>080</b>	800 mm	<b>047</b>	470 mm	<b>52</b>	Ebony	<b>52</b>	Ebony	<b>K</b>	Key Alike
		<b>100</b>	1000 mm								
<b>4H</b>	Four-High (1301 mm)										

**SAMPLE ORDER CODE**

<b>ESMFL 3H</b>	<b>080</b>	<b>047</b>	<b>52</b>	<b>52</b>	<b>K</b>
-----------------	------------	------------	-----------	-----------	----------

**DIMENSIONS  
CODE**

D	W
470	800
470	1000

**PRICING**

Three-High	Four-High
3088	3624
3205	3827

# freestanding storage

## ESMAW

### Lateral & Hinged Door Worksurface for Metal Storage

#### WHAT'S INCLUDED

25mm worksurface with matching lipping.

#### NOTES

Fitted on-site.

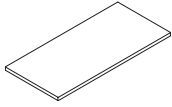

#### PRODUCT OPTIONS

Width		Surface Finish	
<b>080</b>	800 mm	<b>OK</b>	Oak
<b>100</b>	1000 mm	<b>WT</b>	Walnut
<b>160</b>	1600 mm	<b>LW</b>	Light Walnut
		<b>MP</b>	Maple
		<b>WH</b>	White
		<b>SW</b>	Snow White

#### SAMPLE ORDER CODE

<b>ESMAW 14</b>	<b>OK</b>
-----------------	-----------

#### DIMENSIONS CODE

D	W
470	800
470	1000
470	1600

#### PRICING

261
268
382

**WHAT'S INCLUDED**

**Shelf Divider Pack, Metal Storage:** shelf dividers, for use with slotted shelf  
**Piggy Back Cross Rails for Lateral, Metal Storage:** piggy back rails for filing pocket sizes  
**Cross Rails for Lateral, Metal Storage:** cross rails, if side to side filing preferred  
**Slotted Shelf, Metal Storage:** shelf with slots for vertical dividers

**ESMA  
Accessories**

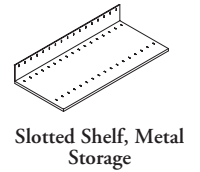

**PRODUCT OPTIONS**

Accessory	Switch
<b>D</b> Shelf Divider Pack, Metal Storage	<b>080</b> 800mm
<b>P</b> Piggy Back Cross Rails for Lateral, Metal Storage	<b>100</b> 1000mm
<b>R</b> Cross Rails for Lateral, Metal Storage	
<b>S</b> Slotted Shelf, Metal Storage	

**SAMPLE ORDER CODE**

<b>ESMA S</b>	<b>080</b>
---------------	------------

**DIMENSIONS  
CODE**

**PRICING**

D	128
P	79
R	75
S 080	215
S 100	242

lockers

# product map

## ESMLS Single Locker, Metal

Page 32

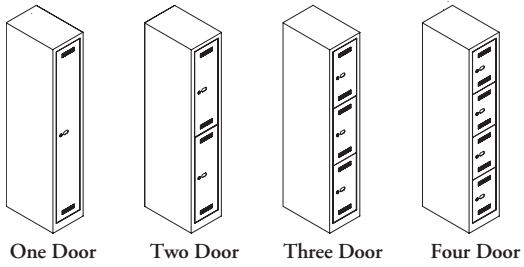

One Door      Two Door      Three Door      Four Door

## ESMLD Double Locker, Metal

Page 33

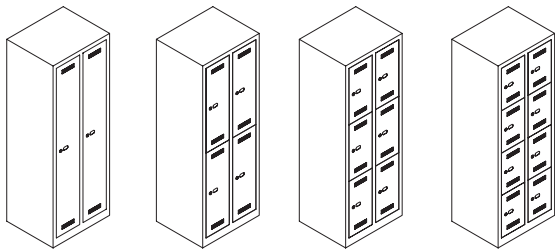

One Door      Two Door      Three Door      Four Door

## ESMLT Triple Locker, Metal

Page 34

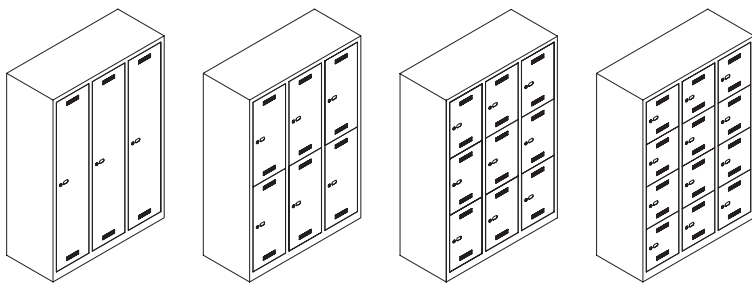

One Door      Two Door      Three Door      Four Door

## ESMLS

### Single Locker, Metal



One Door (shown)

#### WHAT'S INCLUDED

1 single locker unit.

#### NOTES

One, two, three or four door styles are available.

Available with four lock type options.

Can be ganged together.

#### PRODUCT OPTIONS

Doors	Lock Type	Case Finish	Door Finish	Key Type
1 One Door	S Standard Lock, Metal	52 Ebony	52 Ebony	R Key Random
2 Two Doors	D Digital Lock, Metal	83 Very White	83 Very White	K Key Alike
3 Three Doors	R RFID Lock, Metal			
4 Four Doors	B Combination Lock, Metal			

#### SAMPLE ORDER CODE

ESMLS 2	S	52	52	R
---------	---	----	----	---

#### DIMENSIONS CODE

One Door (1)
Two Door (2)
Three Door (3)
Four Door (4)

#### PRICING

	Combination Lock (B)	Digital Lock (D)	RFID Lock (R)	Standard Lock (S)
One Door (1)	642	778	891	487
Two Door (2)	867	1141	1366	558
Three Door (3)	1056	1466	1805	593
Four Door (4)	1265	1815	2264	649



**WHAT'S INCLUDED**

1 double locker unit.

**NOTES**

One, two, three or four door styles are available.

Available with four lock type options.

Can be ganged together.

**ESMLD**  
**Double Locker, Metal**

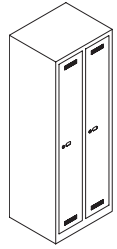

One Door (shown)

**PRODUCT OPTIONS**

Doors	Lock Type	Case Finish	Door Finish	Key Type
1 One Door	<b>S</b> Standard Lock, Metal	<b>52</b> Ebony	<b>52</b> Ebony	<b>R</b> Key Random
2 Two Doors	<b>D</b> Digital Lock, Metal	<b>83</b> Very White	<b>83</b> Very White	<b>K</b> Key Alike
3 Three Doors	<b>R</b> RFID Lock, Metal			
4 Four Doors	<b>B</b> Combination Lock, Metal			

**SAMPLE ORDER CODE**

<b>ESMLD 2</b>	<b>S</b>	<b>52</b>	<b>52</b>	<b>R</b>
----------------	----------	-----------	-----------	----------

**DIMENSIONS  
CODE**

**PRICING**

	Combination Lock (B)	Digital Lock (D)	RFID Lock( R)	Standard Lock (S)
One Door (1)	1192	1466	1692	884
Two Door (2)	1661	2209	2660	1043
Three Door (3)	2018	2840	3516	1092
Four Door (4)	2453	3550	4451	1220

## ESMLT

### Triple Locker, Metal

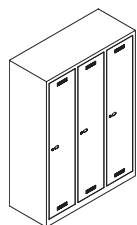

One Door (shown)

#### WHAT'S INCLUDED

1 triple locker unit.

#### NOTES

One, two, three or four door styles are available.

Available with four lock type options.

Can be ganged together.

#### PRODUCT OPTIONS

Doors	Lock Type	Case Finish	Door Finish	Key Type
1 One Door	<b>S</b> Standard Lock, Metal	<b>52</b> Ebony	<b>52</b> Ebony	<b>R</b> Key Random
2 Two Doors	<b>D</b> Digital Lock, Metal	<b>83</b> Very White	<b>83</b> Very White	<b>K</b> Key Alike
3 Three Doors	<b>R</b> RFID Lock, Metal			
4 Four Doors	<b>B</b> Combination Lock, Metal			

#### SAMPLE ORDER CODE

<b>ESMLT 2</b>	<b>S</b>	<b>52</b>	<b>52</b>	<b>R</b>
----------------	----------	-----------	-----------	----------

#### DIMENSIONS CODE

One Door (1)
Two Door (2)
Three Door (3)
Four Door (4)

#### PRICING

	Combination Lock (B)	Digital Lock (D)	RFID Lock (R)	Standard Lock (S)
One Door (1)	1750	2162	2500	1288
Two Door (2)	2446	3269	3945	1521
Three Door (3)	2993	4226	5239	1604
Four Door (4)	3636	5281	6633	1785



# teknion

[www.teknion.com](http://www.teknion.com)

IN UK:

TEKNION EUROPE  
11 BOWLING GREEN LANE  
CLERKENWELL  
LONDON  
EC1R 0BG  
Tel 0207.490.2101

IN ASIA:

Tel 603.3342.4345  
603.3342.3466

IN CANADA:

Tel 866.TEKNION  
866.835.6466

IN THE USA:

Tel 877.TEKNION  
877.8335.6466

OTHER OFFICES LOCATED IN:

South and Central America  
Middle East, Asia and Russia  
For regional contact information  
go to [www.teknion.com](http://www.teknion.com)

CAN/US/INT 2022

©Teknion 2022

®, ™ trade marks of Teknion  
Corporation and/or its subsidiaries or  
licensed to it. Patents may be pending.

Some products may not be available  
in all markets. Contact your  
local Teknion Representative for  
availability.