

fractals nook

features

Fractals Nook, an extension of the Fractals Seating product, uses an organic high shell with an added worksurface to create an intimate desk carrel for heads down work. Fractals Nook allows for users to create a distraction free zone for work. The natural curves of Fractals create unique space planning capabilities for social spaces that require the need for privacy. The addition of the Fractals Nook now allows for new planning scenarios for the complete Fractals line. It offers the ability to intertwine high back lounge pieces with high desk nooks.

Fractals Nook allows the same broad canvas of the lounge series for the selection of multiple fabrics and finishes to create your own distinctive look. Powdercoat finishes on both the legs and the inner frame are chosen individually as well as inner and outer fabric selection for those environments that encourage space division emphasized by finish.

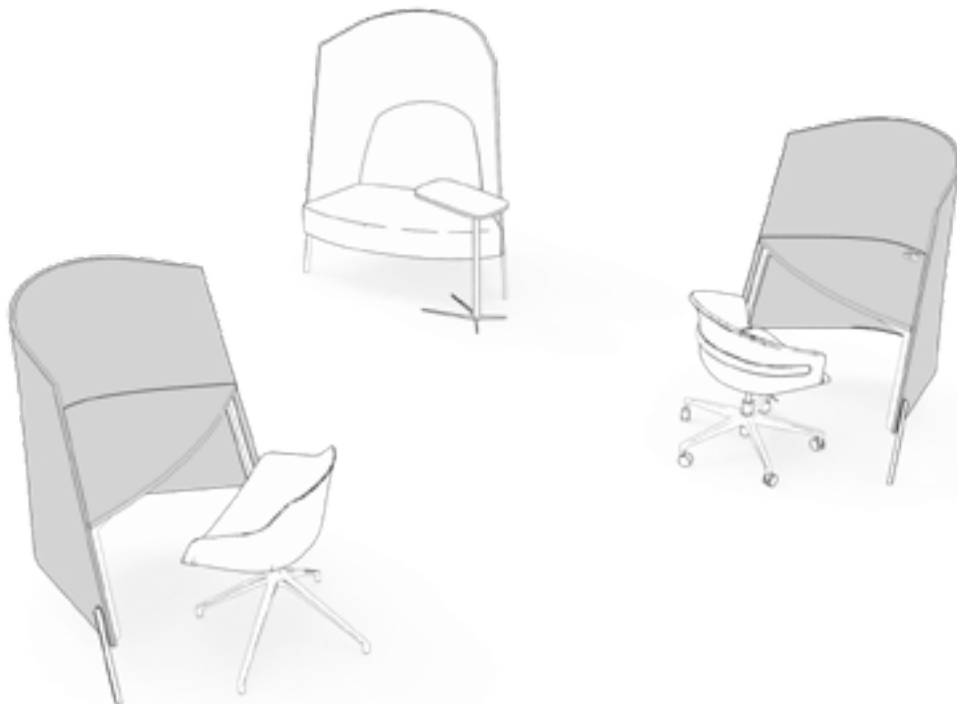

dimensions

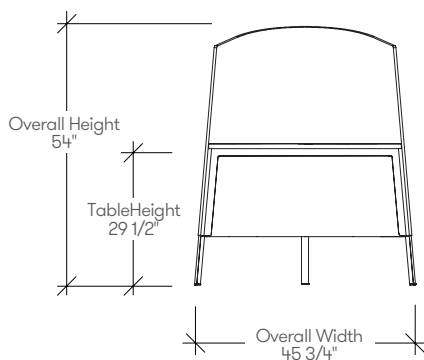

Fractals Nook
(STFNA)
side view

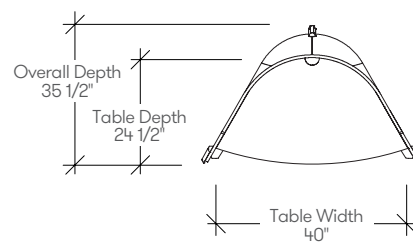

Fractals Nook
(STFNA)
front view

fractals nook

planning

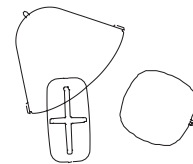
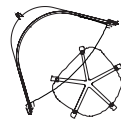
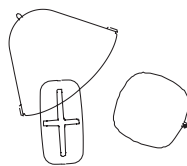
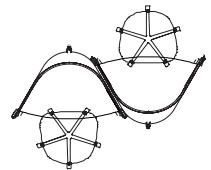
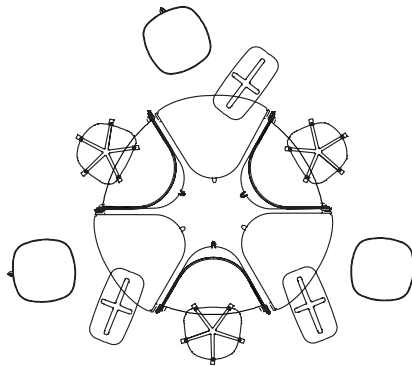
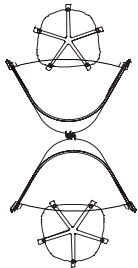
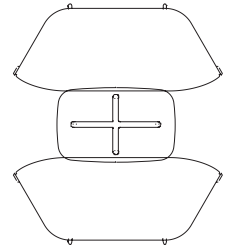
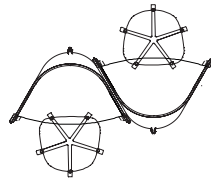
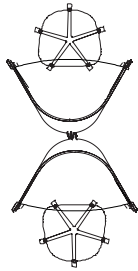
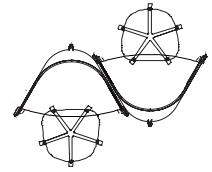
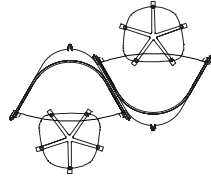
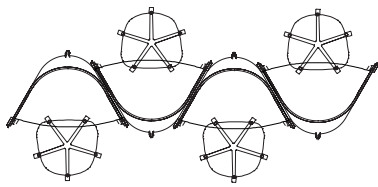

specifying fractals nook finishes

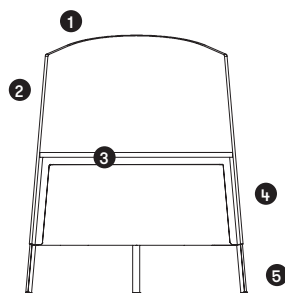

Fractals Nook permits a wide range of combinations that vary dependent of the configuration specified. The following demonstrates the order that must be selected.

- 1 **Inner Back Upholstery**
Select inner back upholstery
- 2 **Outer Back Upholstery**
Select outer back upholstery
- 3 **Surface Finish**
Select surface finish

- 4 **Inner Frame Finish**
Select inner frame finish
- 5 **Leg Finish**
Select leg finish

specification example

STFND Fractals Nook, Power Cut Out for Single Round Bump		
1	Inner Back Gr. 5	2428
2	Outer Back Gr. 3	99
3	Surface Finish Foundation Laminate	0
Total:		\$2527

STFND Fractals Nook, Power Cut Out for Single Round Bump		
1	Inner Back Gr. 9	2575
2	Outer Back Gr. 3	99
3	Surface Finish Veneer	200
Total:		\$2874

STFNN Fractals Nook, No Cut Out		
1	Inner Back Gr. 5	2408
2	Outer Back Gr. 3	99
3	Surface Finish Foundation Laminate	0
Total:		\$2507

STFNN Fractals Nook, No Cut Out		
1	Inner Back Gr. 9	2555
2	Outer Back Gr. 3s	99
3	Surface Finish Veneer	200
Total:		\$2854

COM/COL material requirement

Yardage is based on a non-patterned fabric. Additional yardage may be required for pattern repeats and the matching required. Leather yield may be affected by the quality of the COL. However, variance in the size of the hides will not affect the yield.

SINGLE UPHOLSTERY

	COM [yards]	COL [sq. ft.]
Inner Back	3	54
Outer Back	3	54

STFN fractals nook

Product Options

Power Cut Out	Inner Back Upholstery	Outer Back Upholstery	Surface Finish	Inner Frame Finish	Leg Finish
N No Cut Out	Fabric	Fabric	Studio Foundation Laminate	Fundamental Paint	C6 Chrome
D Power Cut Out for Single Round Power Bump					Leather
			Studio Veneer		Fashion Paint

Note For Laminate Surface, add \$0
 For Studio Veneer Surface, add \$200
 For Inner Frame Fundamental and Fashion Paint, add \$0
 For Chrome Leg, add \$0
 For Fundamental Leg Finish, add \$55
 For Fashion Leg Finish, add \$75



Inner Back

	COM	COL	Gr.1	Gr.2	Gr.3	Gr.4	Gr.5	Gr.6	Gr.7	Gr.8	Gr.9	Gr.10	Gr. 11
N No Cut Out	2095	2221	2215	2268	2315	2368	2408	2442	2475	2515	2555	2595	2642
D Power Cut Out	2115	2242	2235	2288	2335	2388	2428	2462	2495	2535	2575	2615	2662
								Leather	Leather	Leather			
								LB	LC	LD			
N No Cut Out	2695	2762	2828	2895	2962			2941	3301	3421			
D Power Cut Out	2715	2782	2848	2915	2982			2962	3322	3442			

Outer Back

	COM	COL	Gr.1	Gr.2	Gr.3	Gr.4	Gr.5	Gr.6	Gr.7	Gr.8	Gr.9	Gr.10	Gr. 11
N No Cut Out	100	100	54	78	99	123	141	156	171	189	207	225	246
D Power Cut Out	100	100	54	78	99	123	141	156	171	189	207	225	246
								Leather	Leather	Leather			
								LB	LC	LD			
N No Cut Out	270	300	330	360	390			324	486	540			
D Power Cut Out	270	300	330	360	390			324	486	540			