

expansion
desking

price & application guide

09.25.2023



teknion

update summary

Please be advised that information has been updated within the Expansion Desking Price & Application Guide. To highlight these updates, a summary has been created for your reference.

revised product

Numbered Keys (K) option has been removed Locks and Keys (K).

Please note, first orders for new products will be accepted on September 25, 2023. All software will also be updated by September 25, 2023. If you have any questions regarding the information enclosed, please contact your Teknion Customer Service Representative.





WHAT IS EXPANSION DESKING? . . . 6

INDEX 12

APPLICATION GUIDE 17

PRICE & PRODUCT GUIDE. 201

what is expansion desking?

what is expansion desking? – modular desks

metal structure

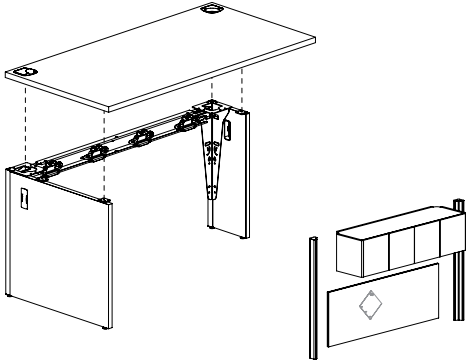

The desk structure is composed of:

- Metal Corner Posts
- Metal Structural Beams
- Laminate or metal Gables

This structure can be outfitted with:

- Optional solid or metal Flush-Mounted Modesty Panel
- Structural Columns that support Screens and Overhead Cabinets

The Modular Desk is the only option for using:

- A Column-Mounted Overhead Cabinet – 66" datum height
- Double-stacked Column-Mounted Overhead Cabinets – 81" datum height

modularity

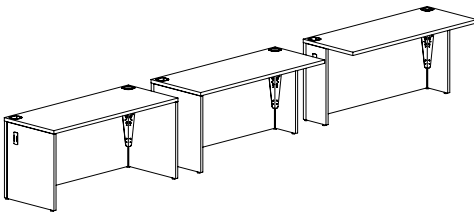

The Modular Desks offer full on-site reconfigurability:

- Full Gable desks are freestanding
- Parts and desk units are non-handed
- Half Gables are universal for all desk depths
- All connections are metal to metal

workspace height electrical solution

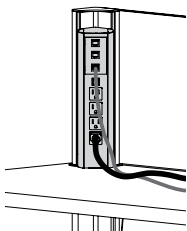

Column-Mounted

The Modular Desks can be outfitted with a power and data solution above workspace:

- Worksurface Power and Communication Center (RLDCC)

cable management

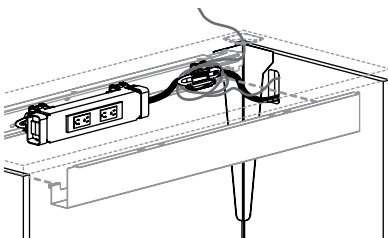

Under worksurface cable management is built-in along the Modular Desk structure:

- The cable management is integrated in the Structural Beam using supplied wire management clips
- A grommet is supplied on all gables
- An optional Beam Cover (RLDEC) can be ordered separately to hide wires

what is expansion desking? – spine desks

The desk structure is composed of:

- Solid End and/or Laminate Intermediate Gables
- Laminate Modesty Panel
- Hidden Cantilever Brackets

This structure refines the aesthetic of a workstation by minimizing visible construction details:

- Grommets are optional on End Gables
- Gables can be shared on back-to-back and side-by-side desks
- Gables and Modesty Panels are joined using hidden metal connectors
- Hinged Cable Tray hides electrics and Cantilever Brackets

The Spine Desks can be outfitted with Desktop Mounted products that can reach a maximum datum height of 51"

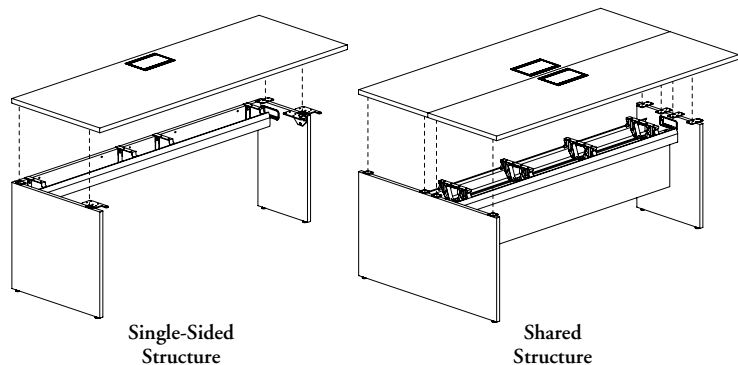

The Spine Desks maximizes the efficiency of its components providing a maximal usable space at a minimal workstation price

Shared components on shared desks:

- End Gables
- Intermediate Gables
- Modesty Panels
- Electrics
- Cantilever Brackets

Shared components on single-sided desks:

- Intermediate Gables

Most components are handed reducing the on-site reconfigurability to adding/removing In-Line Position desks from a workstation

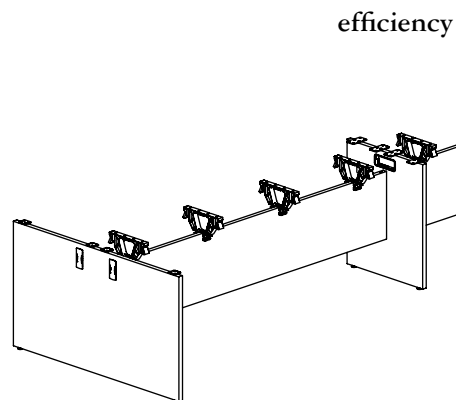

The Spine Desks can be configured with a worksurface Access Door providing above worksurface access to the electrics that are concealed underneath the worksurface:

- Offers a maximal functionality at a minimal price
- Can conceal extra wire of daily plugged equipment

worksurface height electrical solution

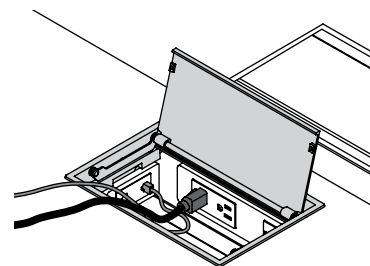

Wire management is integrated and hidden at no extra cost providing a clean aesthetic:

- Hinged Cable Tray is included with all Spine Desks
- Grommets are optional on End Gables

cable management

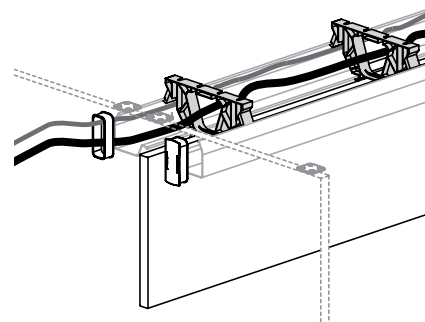

what is expansion desking?

how to specify expansion desking – modular desks

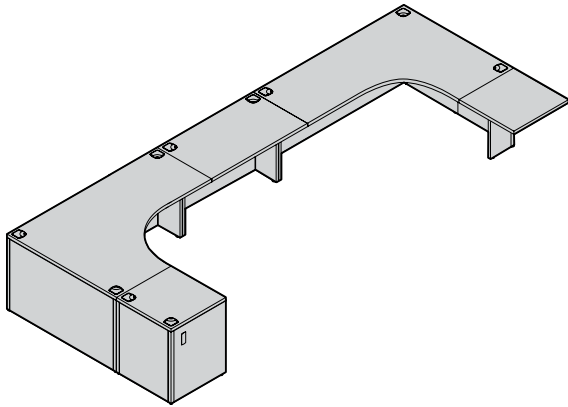

Step 1: Desks

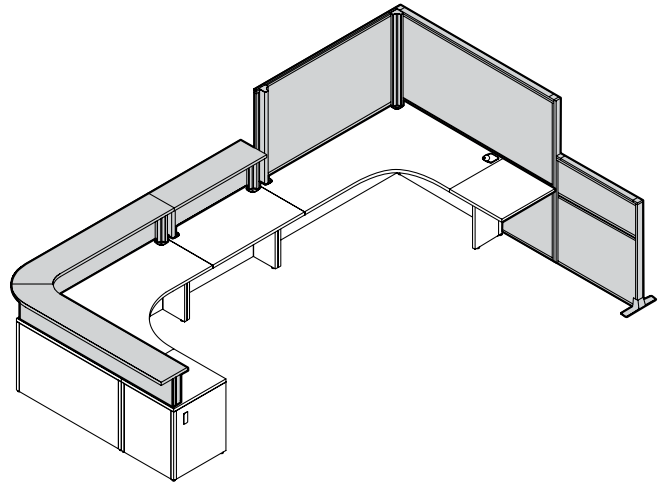

Step 2: Screens and Countertops

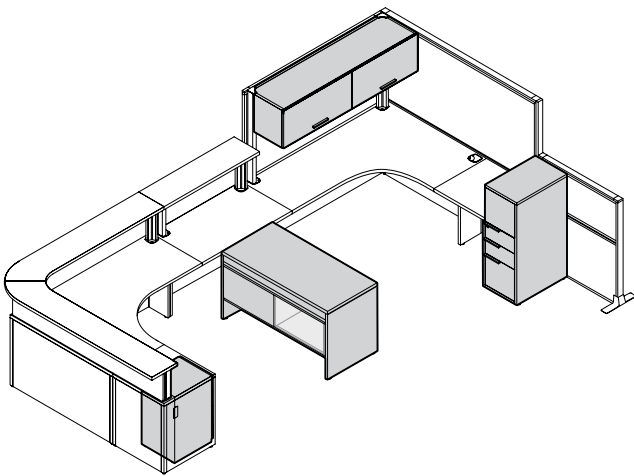

Step 3: Storage and Credenzas

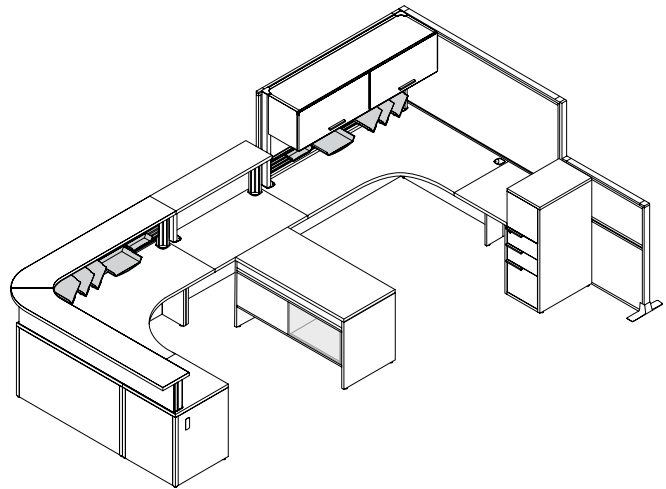

Step 4: Accessories

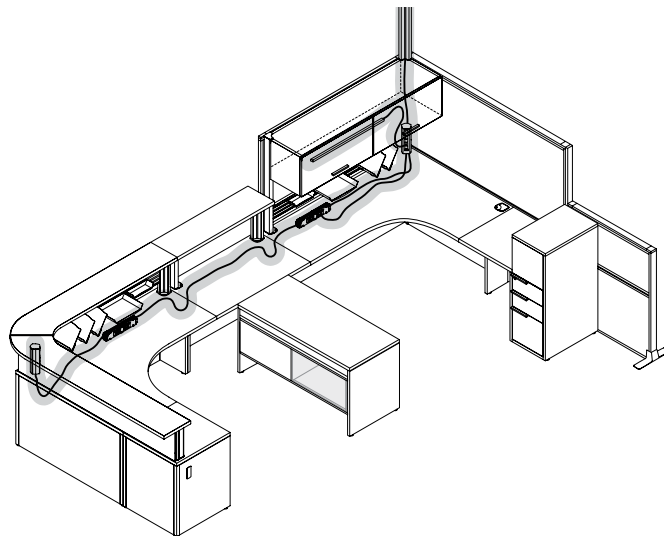

Step 5: Lighting, Electrics and Communications

how to specify expansion desking – spine desks

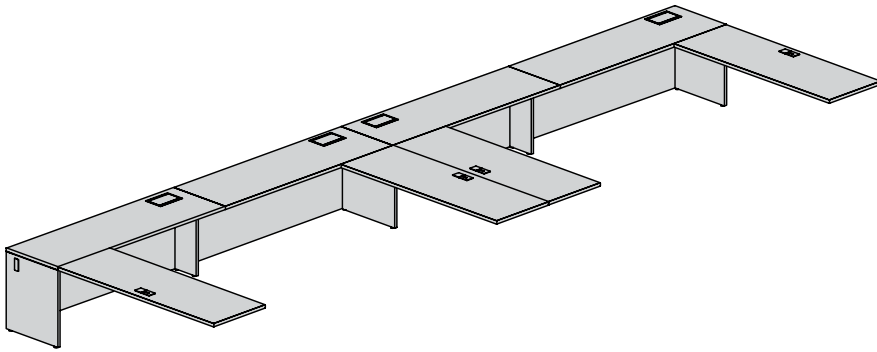

Step 1: Desks (from left to right)

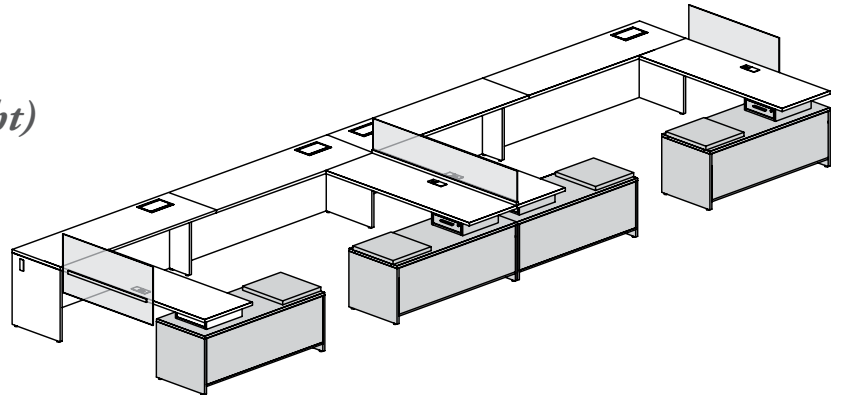

Step 2: Screens, Credenzas and Freestanding Storage

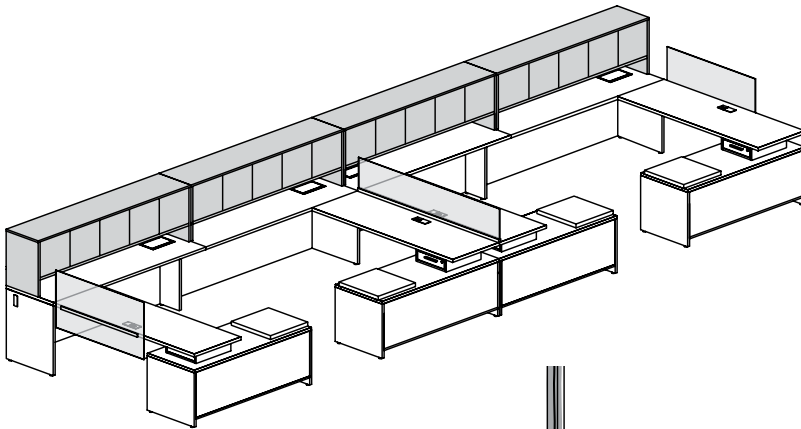

Step 3: Mounted Storage & Accessories

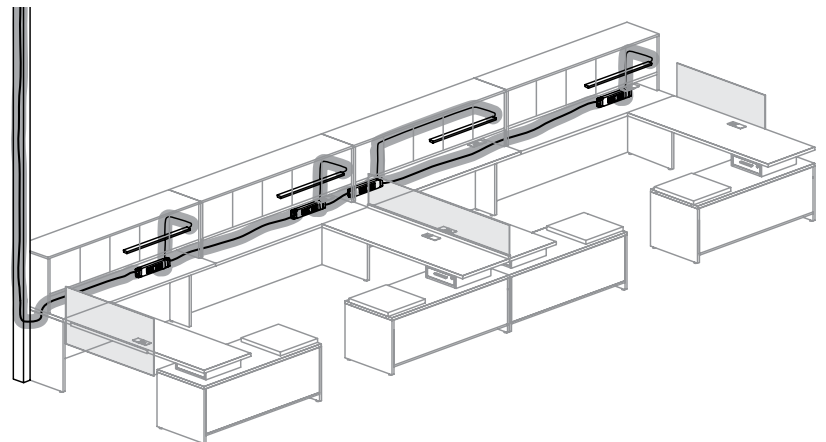

Step 4: Lighting, Electrics & Communications

introduction

where to find the information you need

Teknion provides an array of tools and information resources to help you get things done simply and easily. From product pricing to application guidelines to online planning suggestions, you will find what you need when you need it.

guide contents

This guide contains all the information you need to order this product through your specification software. The Introduction section provides everything you need to get started, including an index for product reference. The Application Guide section contains detailed specification guidelines, application and planning information to help you plan your project correctly. The Price Guide sections provide detailed pricing and specification information by product type. Available online at www.teknion.com.

Xpress The Xpress symbol is displayed beside products that are offered in Teknion's Xpress Program. Available online at www.teknion.com.

where to find the information you need

All Teknion marketing materials are available online at www.teknion.com, including:

price & product guide

application guide

planning tool

installation guides

fabrics & finishes

product photography & drawings

weights & volumes

order forms

warranty/terms & conditions of sale

xpress program guide

teknion forms

The following forms are available online at www.teknion.com, to help you specify and place your order if required:

teknipaint

If you require a custom paint color match, you must submit a TekniPaint form.

using your own material (COM)

If you wish to use your own material on fabric-covered products, you must submit a completed COM form including a sample upholstery and safety testing. A COM Order Information Sheet must also be submitted. This form captures all relevant ordering and tracking information. A COM Request for Yardage Calculation form may be sent to Teknion for preliminary yardage requirements.

placing a manual order

Complete an Order Cover Sheet with the information we need to fill your order. This is the most important step. If the Order Cover Sheet is not complete and correct, the order may be delayed.

key requirements

If you require that certain pieces share the same locks you will need to specify Set of Keys Alike (SOKL) located in the Price and Product Guide.

user feedback

How is our marketing material working for you?

Feedback from the user is very important to the quality of Teknion's marketing material. We ask that if you have suggestions on how you think we could improve content OR if you have found an error, that you contact your Teknion Technical Services department.

Section Contents	Product Code	Page No.
WHAT IS EXPANSION DESKING?		
What is expansion desking? – modular desks		6
What is expansion desking? – spine desks		7
How to specify expansion desking – modular desks		8
How to specify expansion desking – spine desks		9
INTRODUCTION		
Where to find the information you need		11
APPLICATION GUIDES		
Modular desk basics		20
Rect. peninsula desk & rectangular worksurface for L-shaped workstation basics		23
Gable guidelines		26
Visitor option basics		27
Modular desk finishes		28
Modular desk grain direction/user edge		30
Understanding spine desks		34
Spine desk basics		38
Planning with spine desks		44
Planning with worksurfaces, mounted storage & screens		46
Planning with access doors & rectangular grommets positions		48
Spine desk finishes		50
Spine desk grain direction/user edge		51
Desk accessory basics		54
Planning with modesty panels		56
Columns-mounted unframed element basics		63
Columns-mounted framed element basics		64
Add-on screen for modular desk & worksurface edge screen basics		66
Central screen for spine desk basics		67
Lateral screen for spine desk basics		68
1" floor screen basics		69
Markerboard – screen mounted basics		70
Planning with add-on screens for modular desk		72
Planning with worksurface edge screens		74
Planning with central screens for spine desk		76
Planning with lateral screens for spine desk		78
Central & lateral screens compatibility		82
Planning with 1" floor screens		84
2" freestanding screen basics		88
Freestanding screen connections		90
Freestanding screen restrictions		91
Planning with cable pass-through		92
Column & screen finishes		95
Countertop basics		102
Mounted storage basics		106
Stacked column-mounted storage applications		108
Elevated desktop cabinet basics		109
Desk-mounted storage compatibility chart		111
Mounted storage lock chart		112
Mounted storage accessories		113
Mounted storage finishes		114

Section Contents	Product Code	Page No.
Mounted storage grain direction		116
Credenza basics		120
Credenza filing drawer capacities		124
23" high freestanding credenza configurations		126
29" high freestanding credenza configurations		130
Grommet & cable-pass-through applications		132
Credenza product offering		133
Credenza lock chart		134
Credenza finishes		135
Credenza grain direction/user edge		137
Freestanding storage basics		140
Laminate freestanding storage – filing drawer capacities		148
Metal freestanding storage – filing drawer capacities		149
Freestanding storage inside clearance		150
Markerboard – freestanding storage mounted basics		152
Freestanding storage compatibility		154
Freestanding storage lock chart		155
Freestanding storage product offering		156
Freestanding storage accessories		158
Freestanding storage finishes		160
Freestanding storage grain direction		162
Lighting, electrics & communications overview		167
Lighting basics		168
Power & data distribution – modular desks applications		170
Specifying correct power harness length – modular desks applications		173
Power & data distribution – spine desks applications		178
Specifying correct power harness length – spine desks applications		184
Power & data distribution – modular & spine desks applications		192
Wiring systems		194
International electric basics		198
MODULAR DESKS		
Single Structure L-Shaped Desk – Full Gables	RUDR	206
Single Structure L-Shaped Desk with Radius Corner – Full Gables	RURR	210
Rectangular Desk with Visitor Access – Full Gables	RDAR	212
Rectangular Desk – Full Gables	RDRR	214
Rectangular Desk – Full and Half Gables	RDRS	216
Rectangular Desk – Half Gables	RDRD	218
Cross Grain Rectangular Desk – Full and Half Gables	RDFS	220
Cross Grain Rectangular Desk – Half Gables	RDFD	222
Concave Transition Desk – Full and Half Gables	RVSS	224
Radius Corner Desk – Half Gables	RVRD	225
Standard Corner Desk – Half Gables	RDS D	226
Standard Radius Corner Desk – Half Gables	RTSR	227
Extended Corner Desk – Full Gables	RVUR	228
Extended Corner Desk – Full and Half Gables	RVUS	230
Extended Corner Desk – Half Gables	RVUD	232
Rectangular Worksurface	RTL DL	234
Cross Grain Rectangular Worksurface	RTL DC	236

Section Contents	Product Code	Page No.
Rectangular Peninsula Desk – Half Gables	RDRP	238
D-Shaped Peninsula Worksurface	RDBN	239
D-Shaped Peninsula Desk – Half Gables	RDBU	240
Extended D-Shaped Peninsula Desk – Half Gables	RVDD	242
Extended P-Shaped Peninsula Desk – Half Gables	RVXD	244
P-Shaped Peninsula Desk – Half Gables	RDPD	246
Rectangular Table	RTRT	248
SPINE DESKS		
Spine Desk – Single-Sided – Freestanding	RMSRL	252
Spine Desk – Single-Sided – Left-End Position	RMSSL	256
Spine Desk – Single-Sided – In-Line Position	RMSDL	262
Spine Desk – Single-Sided – Right-End Position	RMSEL	268
Spine Desk – Shared – Freestanding	RMDRL	
Spine Desk – Shared – Left-End Position	RMDSL	274
Spine Desk – Shared – In-Line Position	RMDDL	
Spine Desk – Shared – Right-End Position	RMDEL	
DESK ACCESSORIES		
Flush-Mounted Modesty Panel – Solid	RDML	288
Flush-Mounted Modesty Panel – Metal	RDMO	289
Inset Modesty Panel – Solid	RAML	290
Inset Modesty Panel – Metal	RAMO	291
Worksurface Suspended Modesty Panel – Solid	REVL	292
Worksurface Suspended Modesty Panel – Metal	REVO	294
Worksurface Suspended Modesty Panel – Glass	REVG	296
Corner Post Cover	RAPC	297
Semi-Supported Leg – Solid	RAVG	298
Frame Leg – Open	RWWO	299
Frame Leg – Full Infill	RWWF	300
Angled Leg	RWLA	301
Central Post Leg – Square	RWSQ	302
Central Post Leg – 3 1/2" Round	RWLD	303
Multi-Functional Drawer	RADMF	304
Retractable Keyboard Shelf	RAKB	305
Accessories	RAX	306
COLUMNS & SCREENS		
Structural Column	RPSC	314
Column Extension	RPCE	315
Unframed Element – Fabric	RPSF	316
Element Connector Kit – Unframed	RPAJ	318
1" Framed Element – Fabric	RYEF	320
1" Framed Element – Glass	RYEG	322
2" Framed Element – Fabric	RYSF	324
2" Framed Element – Glass	RYSG	326
Lateral Stabilizer – Elements	RYCE	328
Add-On Screen for Modular Desk – Glass	RPSAG	330
Central Screen for Spine Desk – Solid	RCSBLN	334
Lateral Screen for Spine Desk – Solid	RCSLLN	336
Central Screen for Spine Desk – Glass	RCSBG	338
Lateral Screen for Spine Desk – Glass	RCSLG	340

Section Contents	Product Code	Page No.
Central Framed Screen for Spine Desk – Fabric	RCFBF	342
Lateral Framed Screen for Spine Desk – Fabric	RCFLF	344
Central Framed Screen for Spine Desk – Glass	RCFBG	346
Lateral Framed Screen for Spine Desk – Glass	RCFLG	348
Central Framed Screen for Spine Desk – Magnetic Glass	RCFBM	350
Lateral Framed Screen for Spine Desk – Magnetic Glass	RCFLM	352
Marker Holder for Makerboard	RACMT	354
Worksurface Edge Screen – Glass	RPSWG	356
Worksurface Edge Screen – Solid	RPSWL	357
1" Floor Screen – Back Connection	RPSBL	358
1" Floor Screen – Lateral Connection	RPSLL	360
1" Floor Screen with Glass – Back Connection	RPSBG	362
1" Floor Screen with Glass – Lateral Connection	RPSLG	364
Glass Makerboard – Screen Mounted	RACMS	368
2" Freestanding Screen – Upper Fabric Element	RY_F	372
2" Freestanding Screen – Upper Glass Element	RY_G	376
2" Freestanding Screen – Middle Fabric and Upper Glass Elements	RY_FG	380
Back Connection Kit – 2" Freestanding Screen	RYC_	384
Lateral Connection Kit – 2" Freestanding Screen	RYCL	385
Wall Connection Kit – 2" Freestanding Screen	RYCW	386
Desk Connection Kit – 2" Freestanding Screen	RYCD	387
Height-Change Connection Kit – 2" Freestanding Screen	RYCH	388
Foot – 2" Freestanding Screen	RYCF	389
COUNTERTOPS		
Countertop – Straight	RCSC	392
Corner Countertop – Straight	RCCC	393
Countertop Support	RCCS	394
MOUNTED STORAGE & ACCESSORIES		
Elevated Desktop Cabinet – Sliding Doors	RSEDS	400
Elevated Desktop Cabinet – Solid Hinged Doors	RSEHD	404
Elevated Desktop Cabinet – Open	RSEOO	406
Overhead Cabinet – Solid Hinged Doors	ROCC	408
Overhead Cabinet – Glass Hinged Doors	ROCHG	409
Overhead Cabinet – Solid Flipper Door(s)	ROCF	410
Overhead Cabinet – Metal Flipper Door(s) – Linear Style	ROCML	411
Overhead Cabinet – Metal Flipper Door(s) – Flush Front Style	ROCMF	412
Overhead Cabinet – Solid Receding Door(s)	RORL	413
Overhead Cabinet – Metal Receding Door(s) – Linear Style	RORML	414
Overhead Cabinet – Metal Receding Door(s) – Flush Front Style	RORMF	415
Overhead Cabinet – Sliding Doors	ROCD	416
Overhead Cabinet – No Door	ROCO	417
Overhead Cabinet Filler	ROGF	418
Shelf – Solid	ROSL	419
Shelf – Metal	ROSM	420
Accessory Rail	ROAR	421

index

Section Contents	Product Code	Page No.
Wall-Mounted Tackboard	RPWT	422
Personal Organizers	PAX	423
CREDENZAS		
Freestanding Credenza – Box/File Drawers	RSCLD	426
Freestanding Credenza – Open with Box/File Drawers	RSCOD	428
Freestanding Credenza – Lateral Files	RSCLL	430
Freestanding Credenza – Open with Lateral Files	RSCOL	432
Freestanding Credenza – Sliding Doors	RSCSS	434
Freestanding Credenza – Open with Sliding Doors	RSCOS	438
Worksurface Drawer Support – Low Credenza	RSMD	442
Seat Cushion	RSSC	443
FREESTANDING STORAGE & ACCESSORIES		
Supporting Tower with Lateral Access and Drawers	RBHAT	450
Supporting Tower with Full Door	RBHSC	451
Extended Supporting Tower with Drawers	RBXT	452
Extended Supporting Tower with Full Door	RBXTC	453
Metal Pedestal	RBNSP	454
Pedestal	RBSP	455
Mobile Pedestal with Seat	RBTPS	456
Suspended Pedestal	RBS S	457
Freestanding Tower with Lateral Access and Drawers	RBAT	458
Freestanding Tower with Lateral Access, Drawers and Wardrobe	RBATW	459
Metal Combo Pedestal	RBNC P	460
Combo Pedestal	RBCP	461
Metal Lateral File	RBNLF	462
Lateral File	RBLF	463
Storage Cabinet	RBCD	464
Storage Cabinet with Drawer(s)	RBSD	466
Underworksurface Bookcase	RBSUB	467
Half Wardrobe Filing Cabinet	RBSF	468
Half Wardrobe Unit with Drawers – Open Shelves	RBSCO	469
Half Wardrobe Unit with Drawers – Solid Doors	RBSCL	470
Half Wardrobe Unit with Drawers – Glass Door	RBCG	472
Storage Unit	RBSU	474
Storage Unit – Glass Doors	RBUSG	475
Storage Unit with Wardrobe – Solid Doors	RBUW	476
Wardrobe Cabinet – Solid Doors	RBSW	477
Bookcase	RBOB	478
Glass Markerboard – Freestanding Storage Mounted	RACMF	480
Supported Pedestal Kit	RBXSK	482
Hang-On Kit	RBXHK	483
Top for Metal Storage Cabinet	RSNRT	484
Top for Solid Storage Cabinet	RSRT	485
Shelf for Storage Cabinet	RSHE	486
Gap Filler for Pedestals	RBG F	487
Hanging File Bar	RSLB	488
Metal Storage Accessories	RBNSA	489
Locks and Keys	K	490

Section Contents	Product Code	Page No.
Set of Keys Alike	SOKL	491
LIGHTING, ELECTRICS & COMMUNICATIONS		
Linear LED Light	RL ED	496
Tangent Undercabinet Light	RLYTU	497
Shelf Adapter for Universal Light	RLSA	498
Cable Tray	RLWT	499
Communication Box	RLUDB	500
Underworksurface Plug-In Power Bar	RLPP	501
Worksurface Power and Communication Center	RLDCC	502
Power and Data Center	RLDMC	503
Power Box	RLDU	504
Chicago Power Box	RLCU	505
Distribution Box	RLDSB	506
Beam Cover	RLDEC	507
Power Harness Extension	RLDS	508
Power Harness	RLDC	510
Base Feed	RLDB	512
NYC Split Base Feed	RLBS	514
Ceiling Feed	RLDF	516
Column-Mounted Power Pole	RLSP	520
Power Pole Divider	RLSD	521
Lateral Power Pole	RLPS	522
Desking Grommet	RAG	523
Rectangular Grommet	RAGC	524
Cable Pass-Through Cover	RAWPC	525
INTERNATIONAL ELECTRICS		
Outlet Box	VED	528
Interconnecting Power Cable	VCC	529
Input Power Cable	VEP	530
Voice and Data Box	VVD	531
Voice and Data Outlets	VDO	532
Electric Accessories	VAC	533
Desking Adapter for International Electrics	RLI_B	534

application guide

application guide

MODULAR DESKS	19
SPINE DESKS	33
DESK ACCESSORIES	53
COLUMNS & SCREENS	59
COUNTERTOPS	101
MOUNTED STORAGE & ACCESSORIES	105
CRENZAS	119
FREESTANDING STORAGE & ACCESSORIES	139
LIGHTING, ELECTRICS & COMMUNICATIONS	165
INTERNATIONAL ELECTRICS	197

modular desks

modular desks

MODULAR DESK BASICS	20
RECTANGULAR PENINSULA DESK & RECTANGULAR WORKSURFACE FOR L-SHAPED WORKSTATION BASICS	23
GABLE GUIDELINES	26
VISITOR OPTION BASICS	27
MODULAR DESK FINISHES	28
MODULAR DESK GRAIN DIRECTION / USER EDGE	30

modular desk basics

Expansion Desking workspaces are offered in Generic, Linear and Curvilinear shapes. They can be used individually or with other desks to create a variety of workstation configurations.

- Desks are available: Modular and Single Structure L-Shaped Desks
- Desk assemblies span up to 84" in width without multiple supports
- Desks are shipped knocked down
- Desks are compatible with all Teknion underworksurface storage products

Curvilinear Shape Modular Desks

Designed to create wrap-around workstations that minimize lateral movement

Generic Shape Modular Desks

Available in a variety of shapes including: Rectangular, Standard Corner, Extended Corner and Rectangular, and D-Shaped Peninsula

Also available:

Linear Shape Modular Desks

- Inspired from other Teknion product offerings
- May be used as an aesthetic alternative to generic or curvilinear shape desks

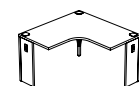

Standard Radius Corner Desk – Half Gables (RTSR)

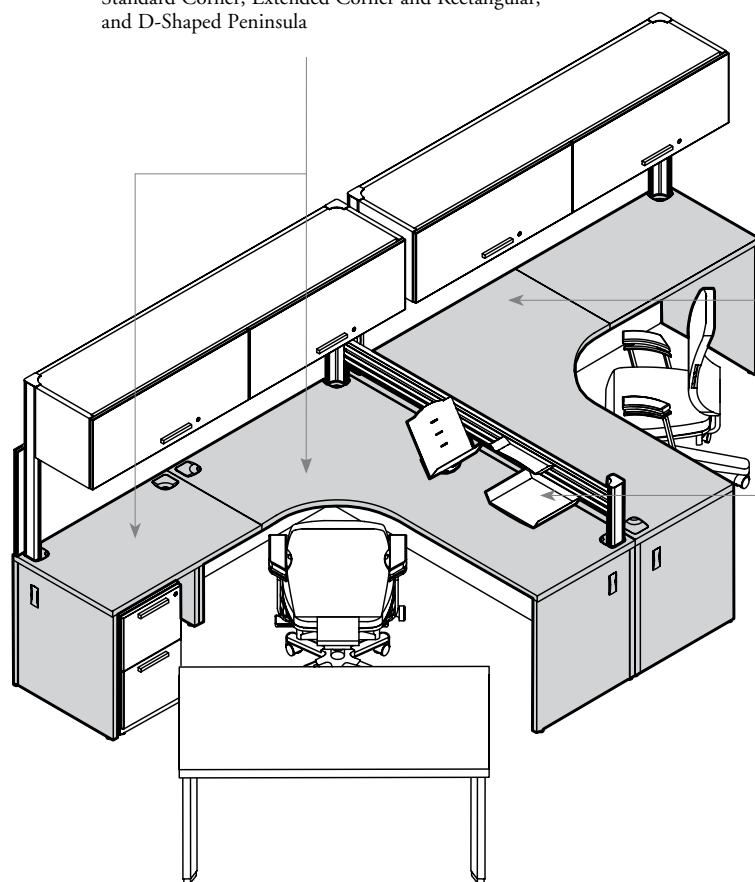

Single Structure L-Shaped Desks

- Available with or without Radius Corner Worksurface
- Are supported with gables on both ends
- Are available up to 84" x 84"

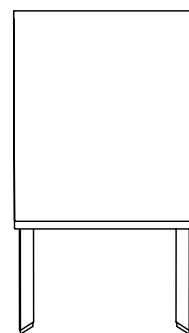

Accessories

Can be specified separately

Worksurfaces

- Worksurface dimensions listed are actual dimensions of the finished product.
- Grain direction varies depending on the type of desk specified, see page 30

modular desk basics (continued)

⚠ All desks include a worksurface, grommets, structural beams, corner posts and gables (or c-legs)

modular desk anatomy

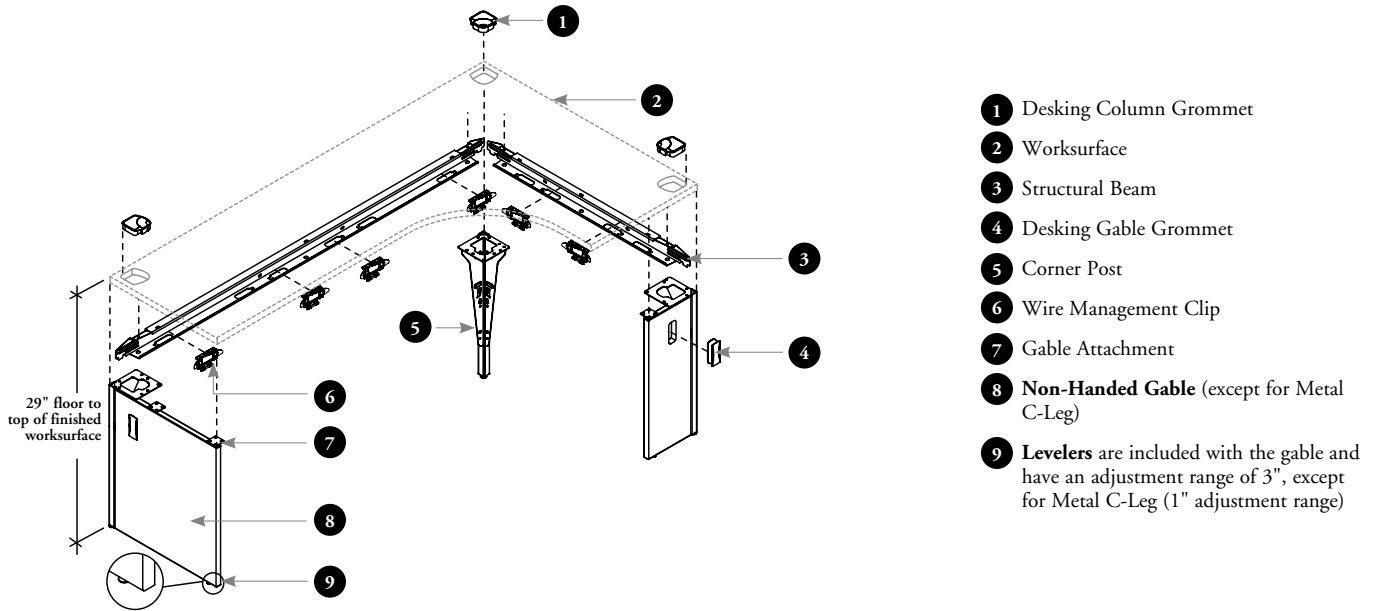

single structure L-shaped desk anatomy

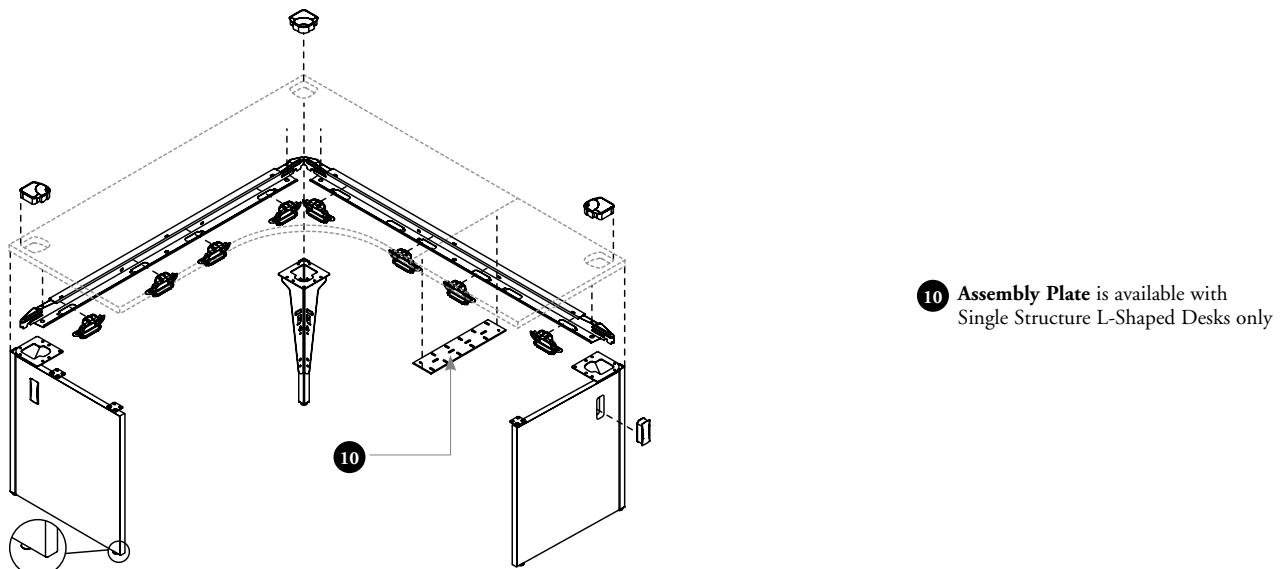

modular desk basics (continued)

⚠ All desks with half gables must be connected to other desks

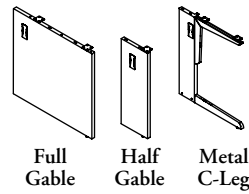

Gables

- Full and half gables are non-handed for on-site reconfigurability; Metal C-Leg is handed
- All gable styles include a grommet
- Half gables provide additional kneespace clearance at desk junctions
- Flush plates are included to maintain stability and level the surface
- A desk **cannot** be mounted with Metal C-Legs, if:
 - Overhead cabinets are stacked
 - Elevated Desktop Cabinets are used

Flush-Mounted Modesty Panels (RDML, RDMO)

- **Not** required for structural stability, except in some configurations when overhead cabinets are stacked. For details, refer to page 108
- Can be specified full- or 3/4-height
- Available in Solid (Laminate) or Metal. Metal panels are offered in two styles: Embossed (2 patterns) and Solid
- Can be specified with or without grommet

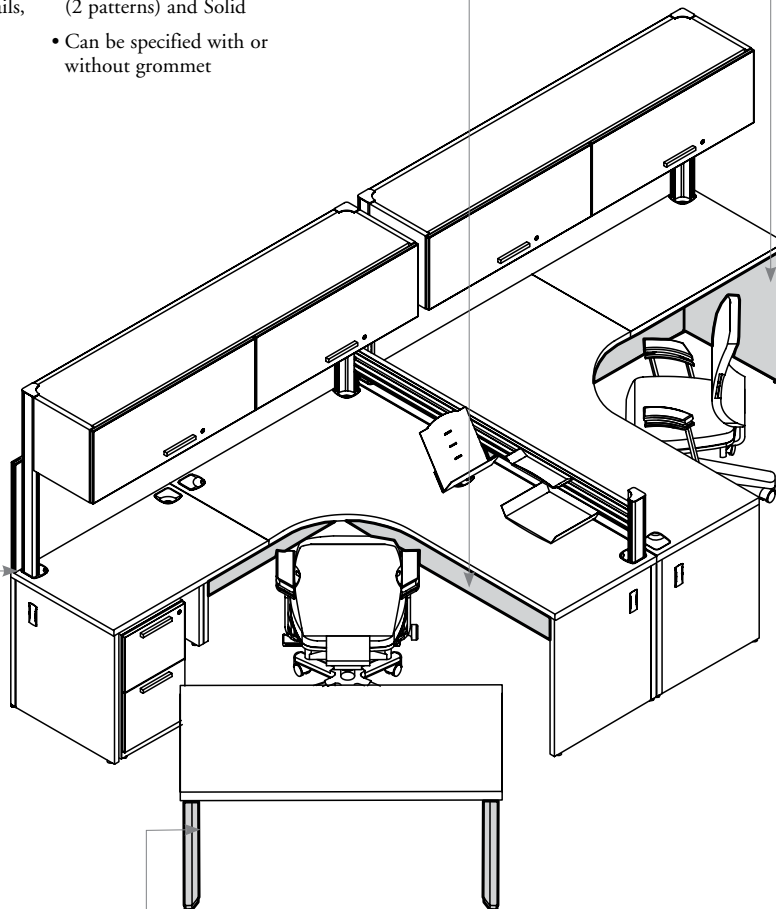

Grommets

- Desks come with factory-made grommet cut-outs on the gables and worksurfaces
- Provide openings for electrical wiring and communication cables
- Include plastic ring and cover

Supports

- Five support styles are available to provide a variety of aesthetic options
- Include leveler with a 3" adjustment range
- Support style/desk combinations are **not** all available; see individual product pages

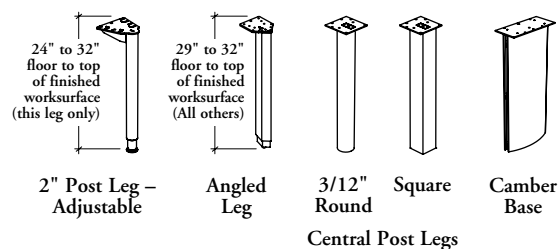

Central Post Legs

rectangular peninsula desk & rectangular worksurface for L-shaped workstation basics

- ◆ Only Rectangular Peninsula Desk (RDRP) or Rectangular Worksurfaces (RTLDL and RTLDC) can be semi-supported for L-shaped workstation
- Legs, Frame Leg, Semi-Supported Leg, or Storage, must be ordered separately
- Worksurface Suspended Modesty Panel is optional and can be ordered separately

supporting applications – 28" high freestanding storage and other supports

Rectangular Worksurface (RTLDL or RTLDC) in Collaborative Applications (Shown)

- Must be connected in the junction of two desks (shown) or can also be used as a return on a single desk with a full gable or credenza
- Even widths are actual; odd widths are 1/2" smaller
- 60" maximum unsupported span is required when connected as a return on a junction of two desks with half gables or c-legs
- Overall workstation dimension should not exceed 84" when connected as a run-off and when supported by legs

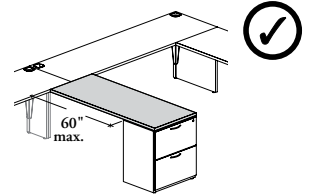

Rectangular Peninsula Desk (RDRP) in Collaborative Applications

- Must be connected between two desks or can also be used as a return of a semi-supported desk with a half gable (shown)



Linking Plates

- Can be used to link one end of a worksurface to a desk
- When specified, Linking Plates and hardware are included with desk or worksurface

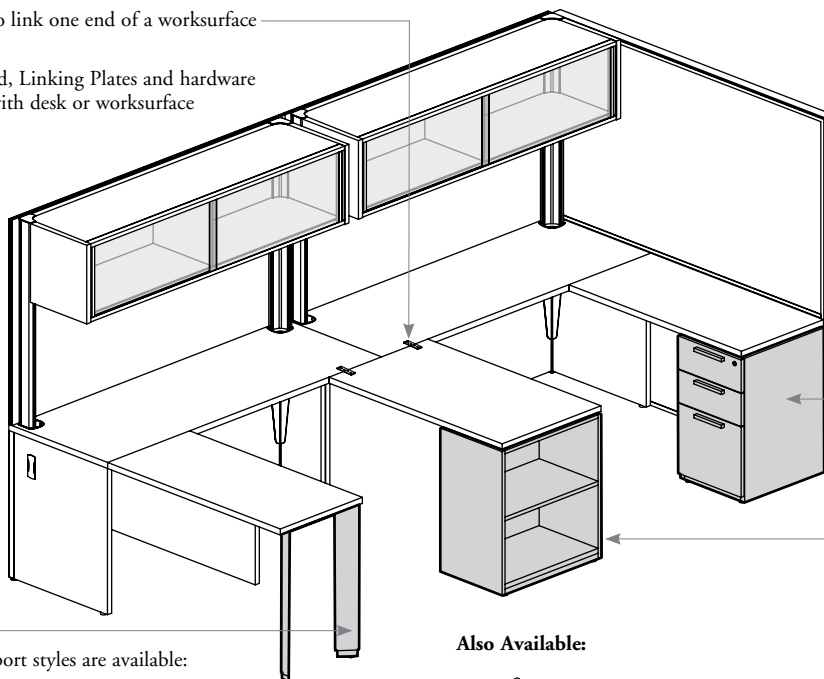

Supported by a Freestanding Storage Configurations

- Can be used to support one end of a desk or worksurface
- Must be installed with Supported Pedestal and hardware are included with desk to maintain stability

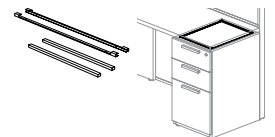

Side-Supported Configurations

- Cabinet depth must equal depth of worksurface under which it is installed

Back-Supported Configurations

- Cabinet width must equal depth of worksurface under which it is installed

Legs

- Three leg support styles are available:

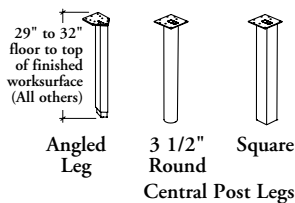

- Central Post Leg can be specified with Rectangular Worksurfaces (RTLDL or RTLDC) only
- When specified, support and hardware are not included with desk

Also Available:

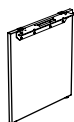

Semi-Supported Leg – Solid (RAVG)

- Supports the end of a worksurface which must be attached to another desk or storage to maintain stability
- Must be specified full width only
- Cannot replace a standard gable when attached to a corner post
- When specified, support and hardware are not included with desk

Frame Legs (RWWO, RWWFL, or RWWFG)

- Support the end of a worksurface to maintain stability
- Three Frame Leg support styles are available:

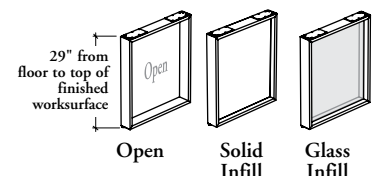

- When specified, support and hardware are not included with desk

rectangular peninsula desk & rectangular worksurface for L-shaped workstation basics (continued)

hanging applications – freestanding storage higher than 28"

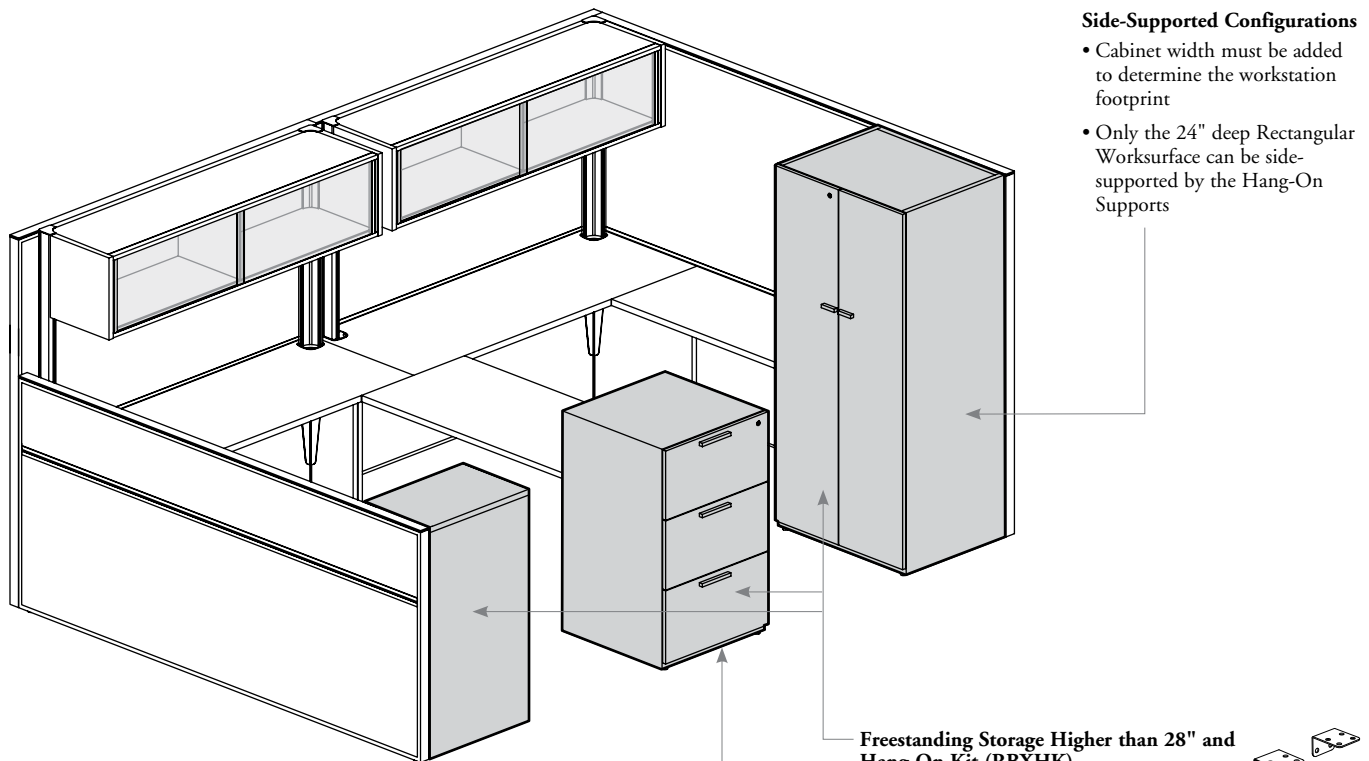

Side-Supported Configurations

- Cabinet width must be added to determine the workstation footprint
- Only the 24" deep Rectangular Worksurface can be side-supported by the Hang-On Supports

Freestanding Storage Higher than 28" and Hang-On Kit (RBXHK)

- Can be used to support one end of a desk or worksurface
- Must be installed with Hang-On Kit to maintain stability
- When specified, Hang-On Brackets and hardware are included with desk, except for Extended Supporting Towers (RBXT or RBXTC) the brackets and hardware are included with storage only

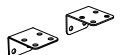

Back-Supported Configurations

- Cabinet width must equal depth of worksurface under which it is installed
- Cabinet depth must be added to determine the workstation footprint

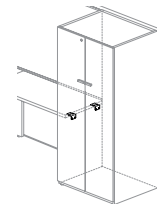

rectangular peninsula desk & rectangular worksurface for L-shaped workstation basics (continued)

freestanding applications

Freestanding Configurations

The appropriate support combination will allow using the Rectangular Worksurface as a freestanding product

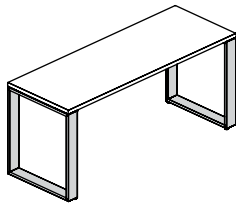

Frame Legs

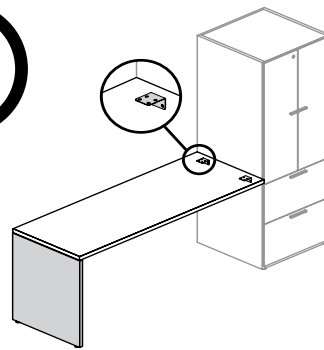

Hang-On Supports and Semi-Supported Leg

Some restrictions apply to the support combinations:

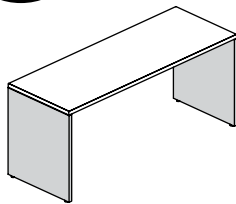

Semi-Supported Legs

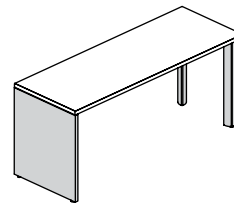
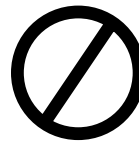

Semi-Supported Leg and Legs

gable guidelines

Desks are available with full or half gables. Half gables provide additional kneespace clearance at desk junction.

- ❗ Two half gables can sufficiently support two semi-supported desks butted up against one another. Flush plates are included to maintain stability and level the surface
- All desks with half gables **cannot** be used alone; they must be combined with one or more desks with half gable to form a complete workstation

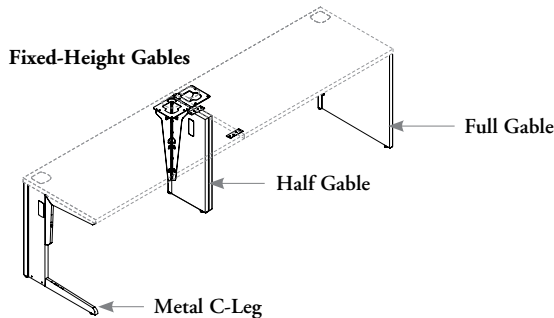

Two Full Gables or Metal C-Legs

- Single desks with two full gables or Metal C-Legs are freestanding and can either be used alone or combined with other desks
- Any desk that does **not** have two full gables or Metal C-Legs is semi-supported and must be attached to other desks with full gable or Metal C-Leg, or similar support at both ends
- A run of desks **cannot** exceed 168" without full gable or Metal C-Leg support to maintain stability

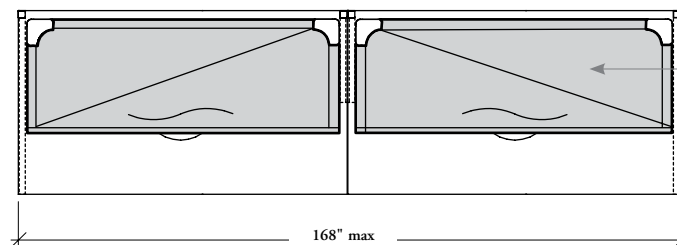
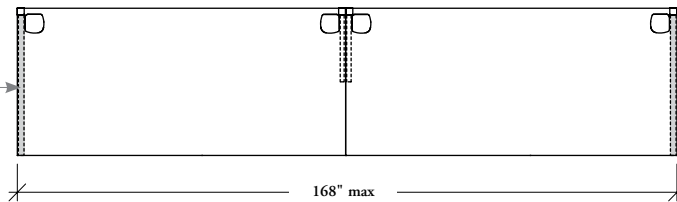

Support Requirements for Overhead Storage

When supporting overhead storage, desks require full gable or Metal C-Leg every 168" maximum

Extended or Corner Desks

- Can be used instead of full gables or Metal C-Legs to provide stability and increase kneespace clearance
- The distance between corner desks must **not** exceed 72"

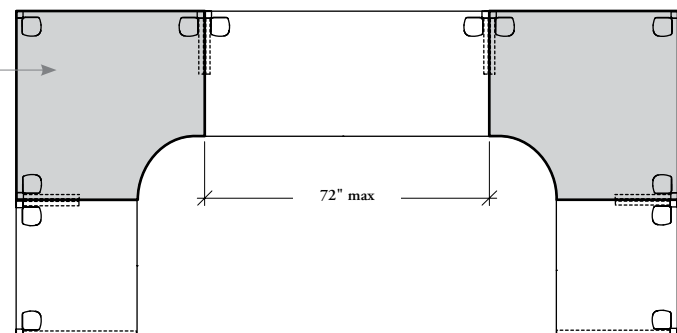

Shared Desks

- Provide sufficient support (full gables or Metal C-Legs are **not** required)
- Act as a full gable or a Metal C-Leg
- May **not** span more than 120" on either side without full gable or Metal C-Leg support

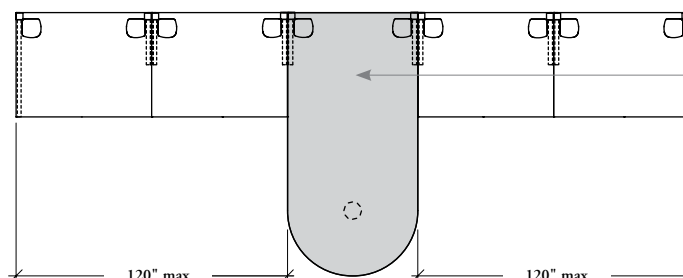

visitor option basics

The visitor recessed option allows an additional kneespace clearance for visitor.

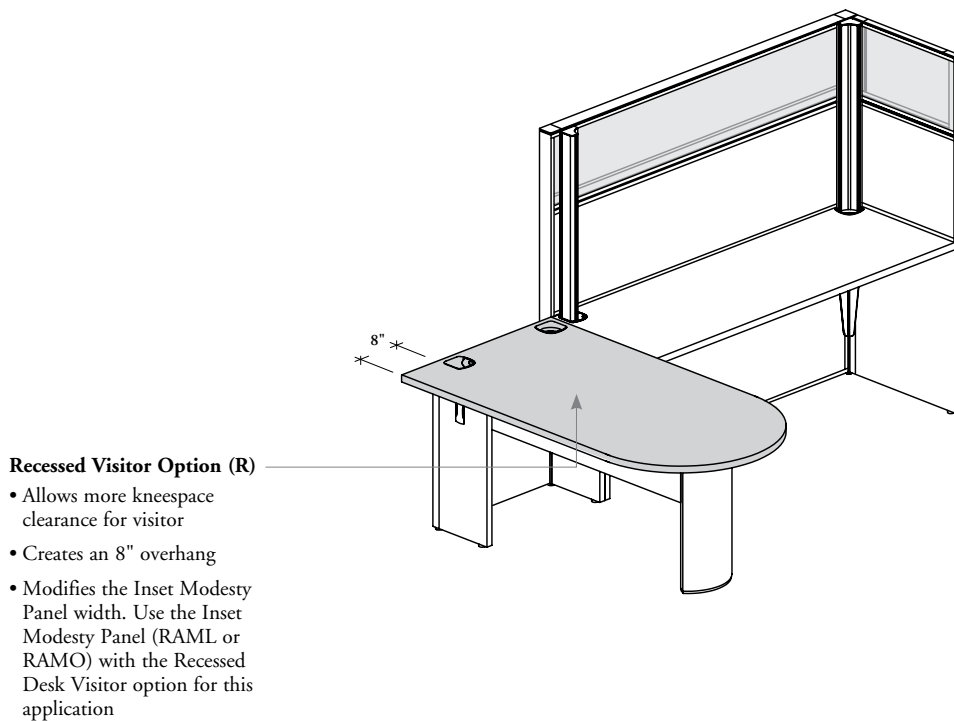
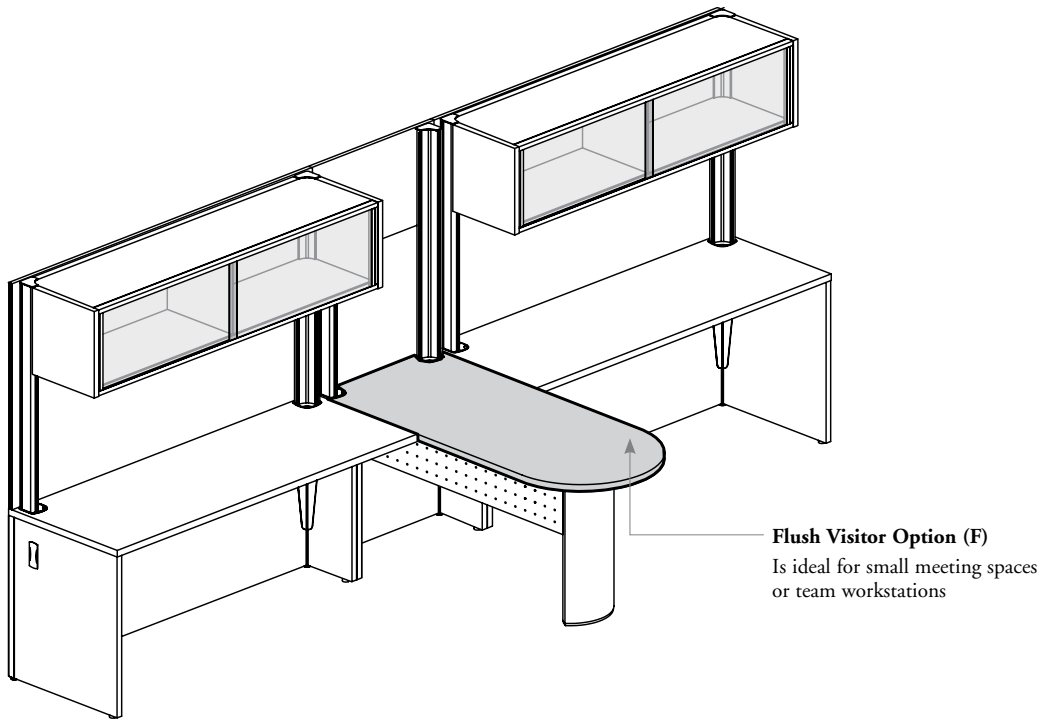

modular desk finishes

Desks and related parts are available in a wide variety of finish colors. Finish codes must be included in the order.

⚠ All Laminate components are protected with a solid plastic edge

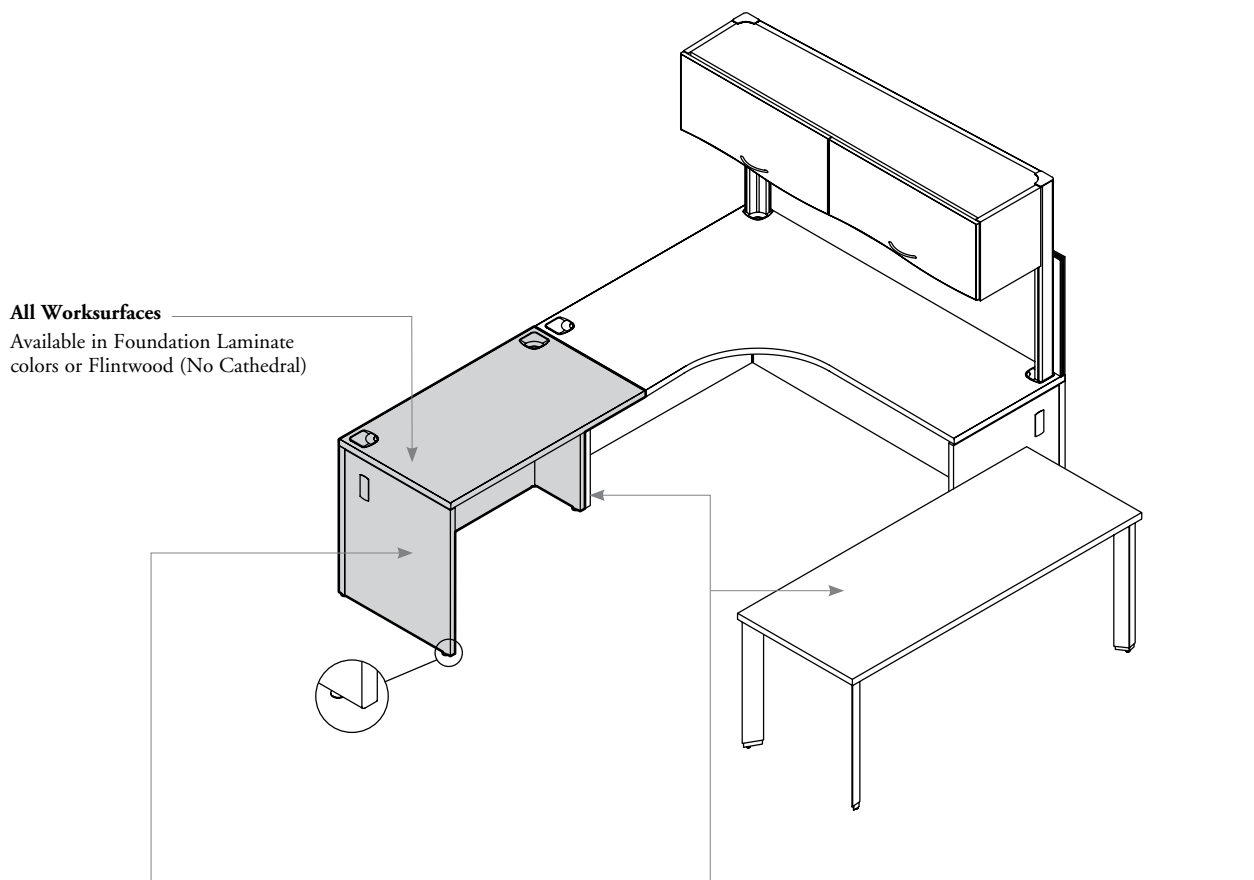

All Worksurfaces

Available in Foundation Laminate colors or Flintwood (No Cathedral)

Solid End Gables and Semi-Supported Leg

- Available in Source Laminate colors
- Corner Posts and Structural Beams will match the color of end gables

Metal End Gables

- Available in Foundation or Mica colors
- Corner Posts and Structural Beams will match the color of end gables

Full Metal C-Legs

- Available in Foundation or Mica colors
- Corner Posts and Structural Beams will match the color of Metal C-Legs

Edge Trims

- Available in Straight Trim (6) or Flintwood Flat Trim (9)
- Flintwood Flat Trim is only available on Flintwood worksurfaces. Edge trims will be finished to match the Flintwood worksurface
- Straight Trim is **not** available on Flintwood worksurfaces

modular desk finishes (continued)

All Desking Grommets (RAG)

- Available in Source Laminate, Foundation and Mica colors
- Worksurface grommets match with a Flintwood worksurface finish or with a Foundation Laminate finish whenever a corresponding match is available in Source Laminate colors. Otherwise worksurface grommets match with the gable finish
- Grommets on modesty panels will match the panel finish

Flintwood Work. Finish		Closest Match for Grommet Finish		
Code	Color	Code	Color	Finish Style
FX	Flax	3J	Flax Reflect	Source
FN	Natural Pecan	3K	Pecan Reflect	Source
FM	Medium Sycamore	3E	Estate Cherry	Source
FC	Chianti	3E	Estate Cherry	Source
FD	Dark Walnut	3B	Java Walnut	Source
NR	Sierra Flint	XQ	Walnut Cathedralgrain	Source
NT	Cocoa Brown Flint	3N	Cocoa Brown Reflect	Source
VA	Sycamore	3P	Sycamore Reflect	Source
VB	Black Walnut	X*	Anthracite	Mica
VZ	Blonde Maple	3D	Choice Maple	Source
5N	White Oak	3F	Campus Oak	Source
5P	Poppy Seed	3C	Urban Walnut	Source
5Q	Harvest Cherry	3E	Estate Cherry	Source
5R	Earl Grey	S	Sepia Bronze	Mica
5S	Silverwash	3V	Earth	Source
5T	White Truffle	2L	Coastal Elm	Source
5V	Caraway	3V	Earth	Source
5W	Drift Oak	3U	Sand	Source
5Z	American Walnut	XQ	Walnut Cathedralgrain	Source

* This match suggestion is not close enough to be considered as tone on tone

Solid Modesty Panels (RDML, RAML and REVL)

Available in Source Laminate colors

Metal Modesty Panels (RDMO, RAMO and REVO)

Available in Foundation or Mica colors

Glass Modesty Panels (REVG)

Available in 1/4" (6 mm) Standard or Back-Painted tempered glass

Standard glass finish:

- Frosted (FT)

Levelers
Finished in Black

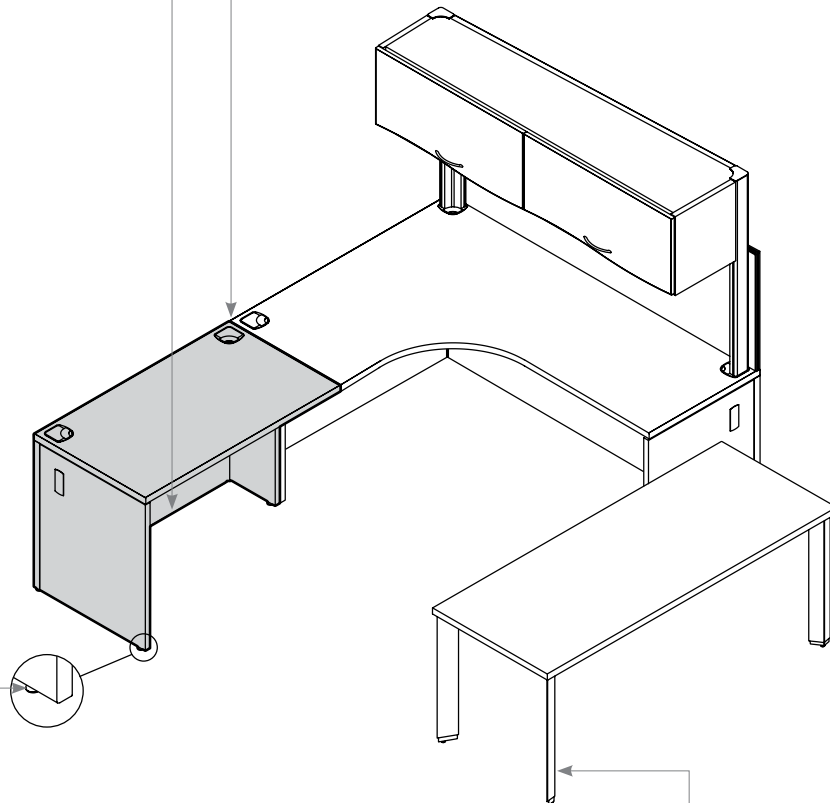

Legs and Base (when included)

- Are available in Foundation or Mica colors, except Central Square Post Leg which can also be specified Clear Anodized
- Leveler comes in Black

modular desk grain direction / user edge

laminate worksurface grain/pattern direction

- ◆ Grain direction is an important factor when planning workstation, if a different grain direction is required, please contact your Teknion Customer Service Representative
- Shading indicates user edge

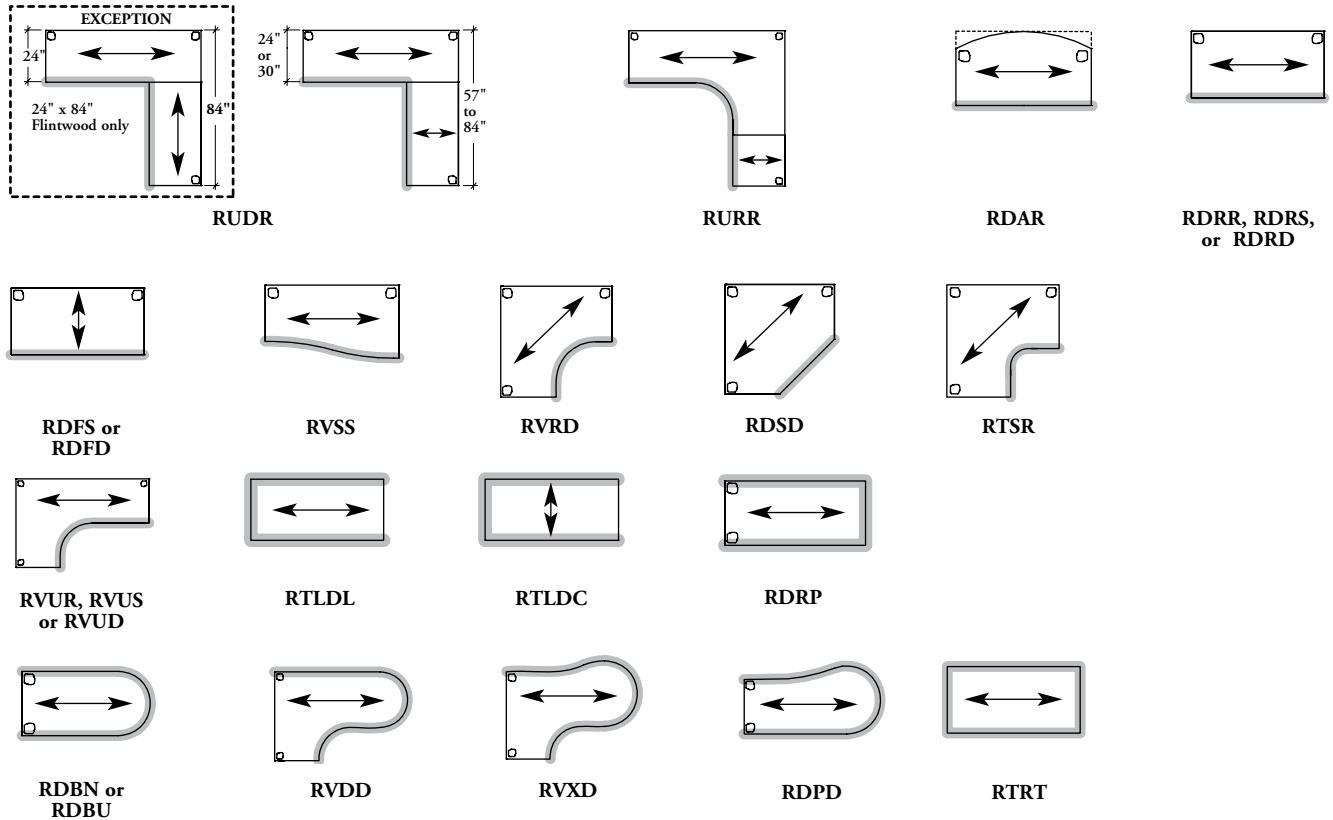

modular desk grain direction / user edge (continued)

laminite worksurface grain/pattern direction (continued)

- ❗ The pattern direction of Laminite is **not** "centered" and grain direction can appear in different direction from side-to-side worksurface

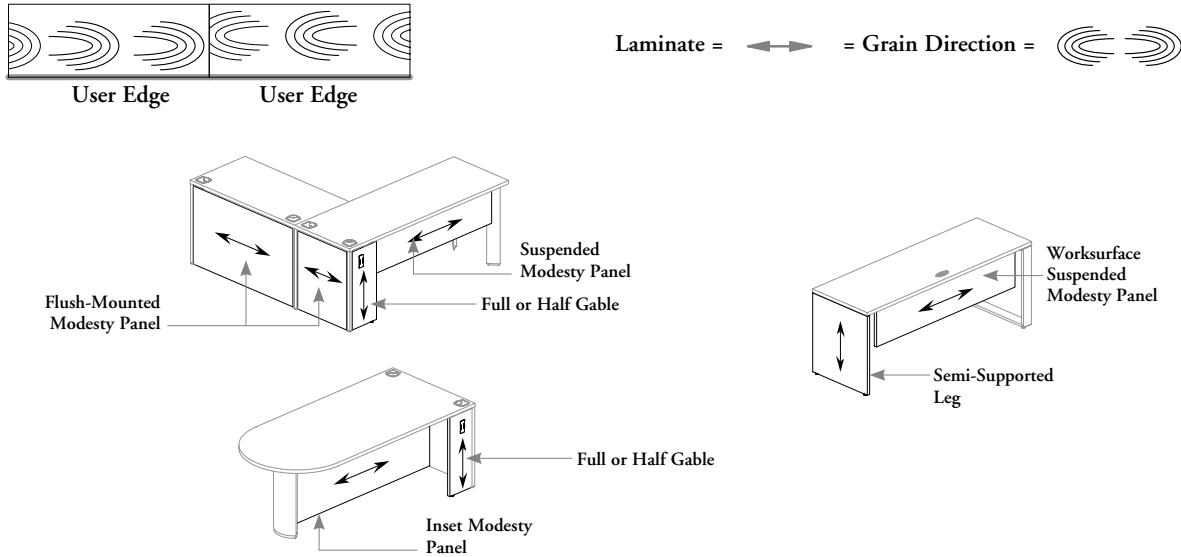

flintwood worksurface grain/pattern direction

- ❗ There is no user edge so care must be taken during installation to match grain/pattern direction
- Grain/patterns are **not** "centered" on worksurface
- Applies to Flintwood (Standard)

Flintwood = \longrightarrow = Grain Direction = 

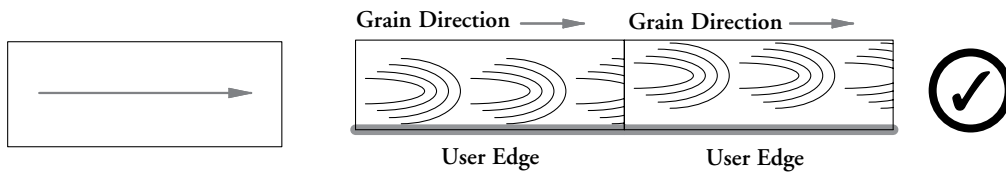

- Grain direction will appear in the same direction, from side to side worksurface

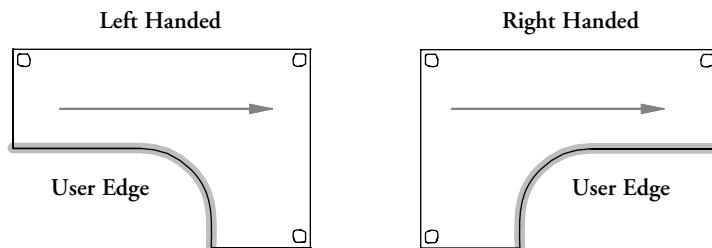
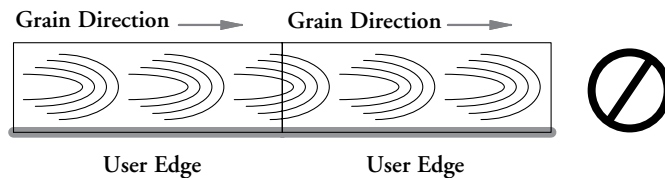

- Regardless of worksurface handedness, grain direction from left to right from the user's perspective

spine desks

spine desks

UNDERSTANDING SPINE DESKS	34
SPINE DESK BASICS	38
MODESTY PANEL & GABLE BASICS	43
PLANNING WITH SPINE DESKS	44
PLANNING WITH WORKSURFACES, MOUNTED STORAGE & SCREENS	46
PLANNING WITH ACCESS DOORS & RECTANGULAR GROMMETS POSITIONS	48
SPINE DESK FINISHES	50
SPINE DESK GRAIN DIRECTION / USER EDGE	51

understanding spine desks

The versatility of the Spine Desks allows to use it in a variety of applications. It can be installed in single-sided or shared applications and in individual or collaborative spaces.

- ❗ Only the Single-Sided and Shared Freestanding Spine Desks can be used alone.
- The Left-End, Right-End or In-Line Position, Single-Sided and Shared Spine Desks are semi-supported and must always be connected with each-other for stability

single-sided spine desks

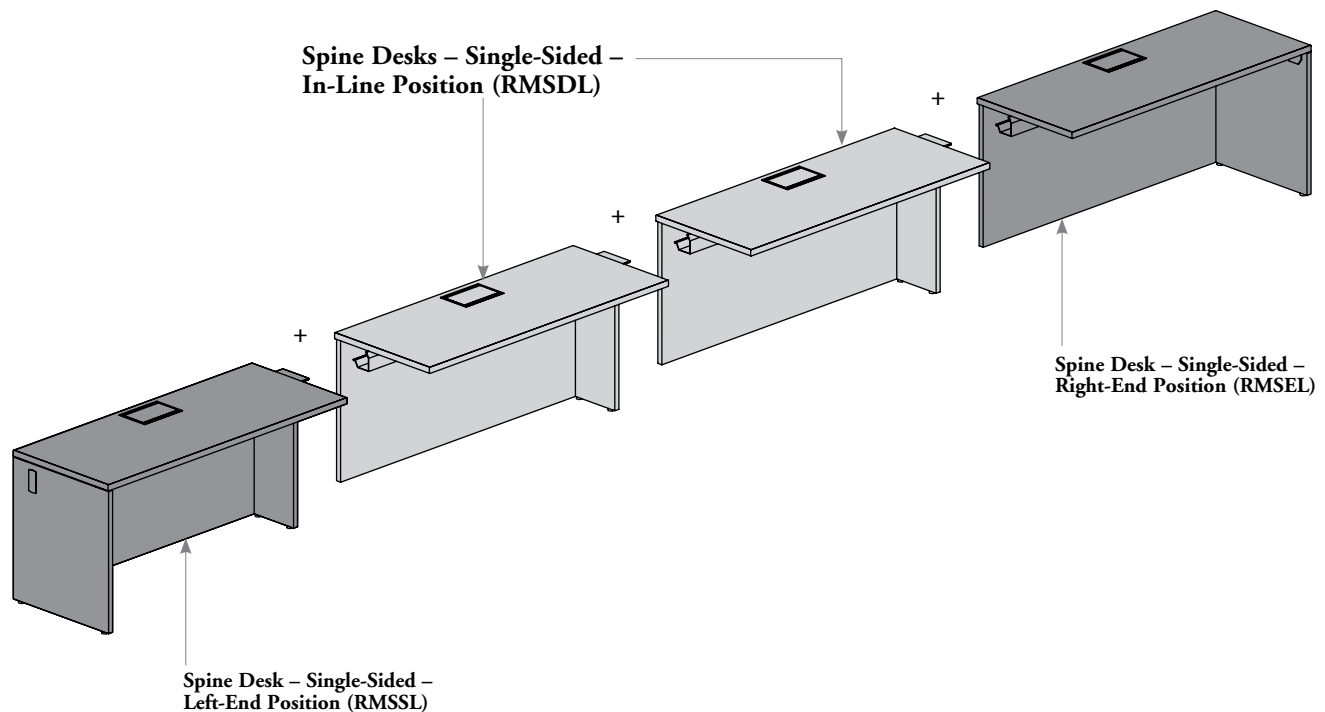

understanding spine desks (continued)

temporary address (benching)

individual space

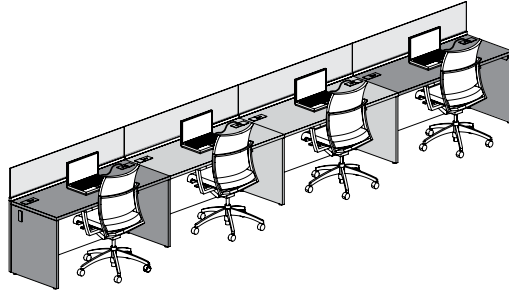

This configuration can be created with a combination of:

Single-Sided Spine Desks:

- One Left-End Position with Intermediate Full Gable (RMSSLF)
- Two In-Line Positions with Intermediate Full Gables (RMSDLF)
- One Right-End Position (RMSEL)

with Wall Access Modesty Panels (W), Rectangular Grommets on both sides (B) and screens

collaborative space

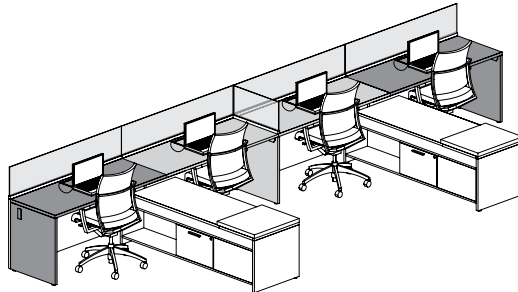

This configuration can be created with a combination of:

Single-Sided Spine Desks

- One Left-End Position with Intermediate Half Gable (RMSSLH)
- One In-Line Position with Intermediate Full Gable (RMSDLF)
- One In-Line Position with Intermediate Half Gable (RMSDLH)
- One Right-End Position (RMSEL)

with Wall Access Modesty Panels, Middle Access Doors (M), screens and credenzas

permanent address (workstations)

individual space

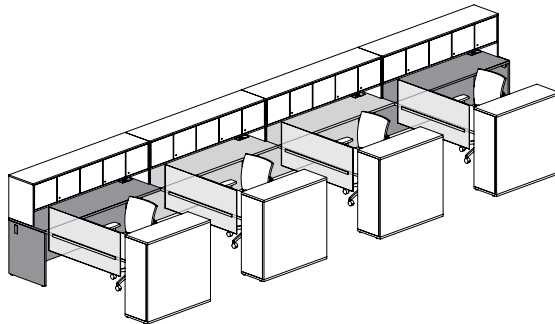

This configuration can be created with a combination of:

Single-Sided Spine Desks:

- One Left-End Position with Intermediate Half Gable (RMSSLH)
- Two In-Line Positions with Intermediate Half Gables (RMSDLH)
- One Right-End Position (RMSEL)

with Full Modesty Panels (F), Rectangular Grommets on both sides (B), rectangular worksurfaces, screens, mounted storage and freestanding storage

collaborative space

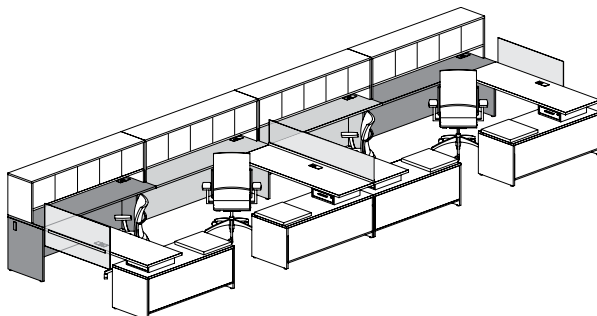

This configuration can be created with a combination of:

Single-Sided Spine Desks:

- One Left-End Position with Intermediate Half Gable (RMSSLH)
- One In-Line Position with Intermediate Full Gable (RMSDLF)
- One In-Line Position with Intermediate Half Gable (RMSDLH)
- One Right-End Position (RMSEL)

with Full Modesty Panels (F), Rectangular Grommets on both sides (B), rectangular worksurfaces, screens, mounted storage and credenzas

understanding spine desks (continued)

shared spine desks

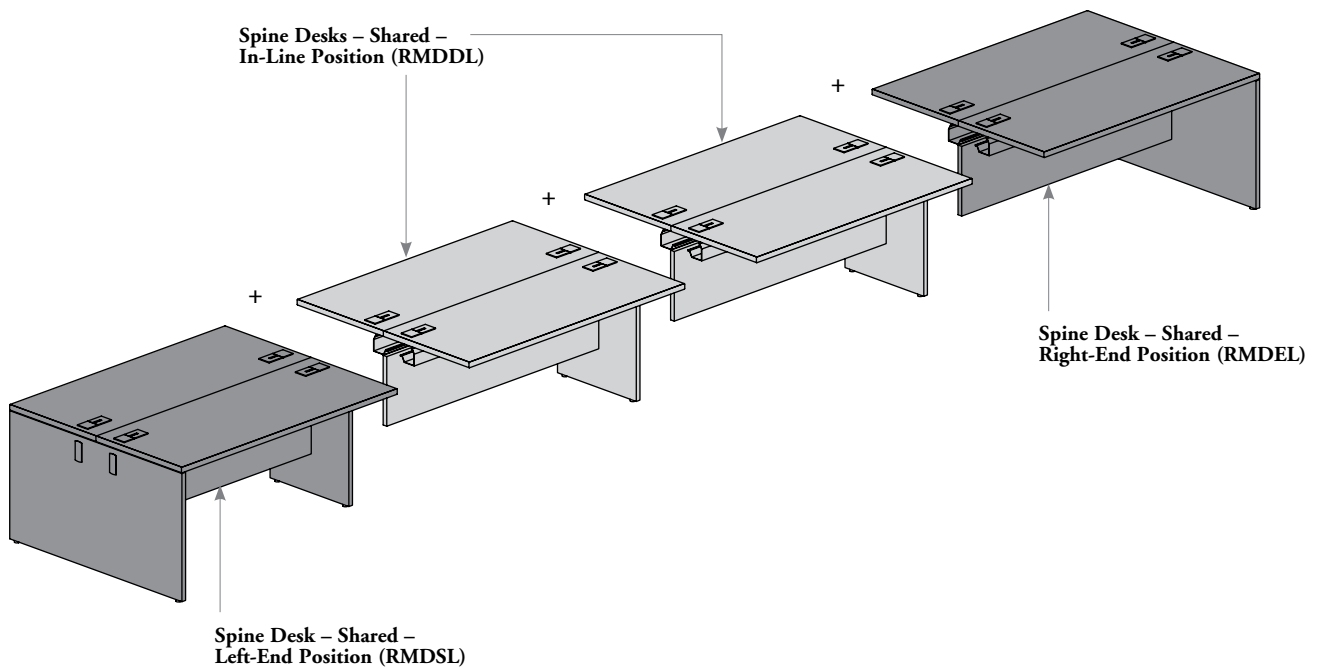

understanding spine desks (continued)

temporary address (benching)

individual space



This configuration can be created with a combination of:

Shared Spine Desks:

- One Left-End Position with Intermediate Half Gable (RMDSLH)
- Two In-Line Positions with Intermediate Half Gables (RMDDLH)
- One Right-End Position (RMDEL)

with Raised Modesty Panels (R), Rectangular Grommets on both sides (B) and screens

collaborative space

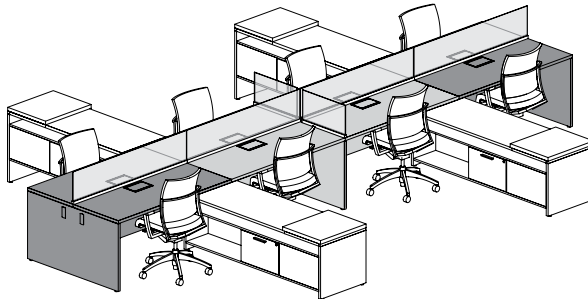

This configuration can be created with a combination of:

Shared Spine Desks

- One Left-End Position with Intermediate Half Gable (RMDSLH)
- One In-Line Position with Intermediate Full Gable (RMDDLDF)
- One In-Line Position with Intermediate Half Gable (RMDDLH)
- One Right-End Position (RMDEL)

with Raised Modesty Panels (R), Middle Access Doors (M), screens and credenzas

permanent address (workstations)

individual space

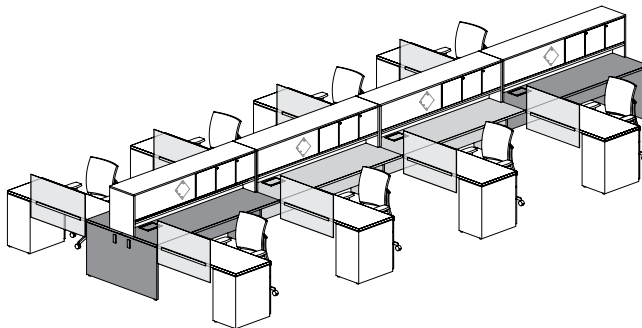

This configuration can be created with a combination of:

Shared Spine Desks:

- One Left-End Position with Intermediate Half Gable (RMDSLH)
- Two In-Line Positions with Intermediate Half Gables (RMDDLH)
- One Right-End Position (RMDEL)

with Raised Modesty Panels (R), Left Access Doors (L), rectangular worksurfaces, screens, mounted storage and freestanding storage

collaborative space

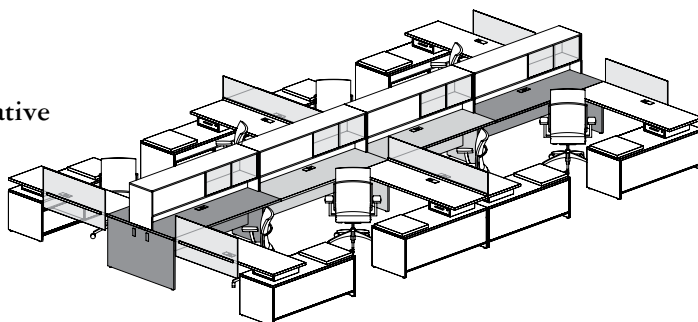

This configuration can be created with a combination of:

Shared Spine Desks:

- One Left-End Position with Intermediate Half Gable (RMDSLH)
- One In-Line Position with Intermediate Full Gable (RMDDLDF)
- One In-Line Position with Intermediate Half Gable (RMDDLH)
- One Right-End Position (RMDEL)

with Raised Modesty Panels (R), Centered Rectangular Grommets (C), rectangular worksurfaces, screens, mounted storage and credenzas

spine desk basics

Spine Desks are available for End and In-Line positions, in single-sided or shared applications.

⚠ All Spine Desks include worksurfaces, gables, modesty panels and hinged cable tray

single-sided spine anatomy

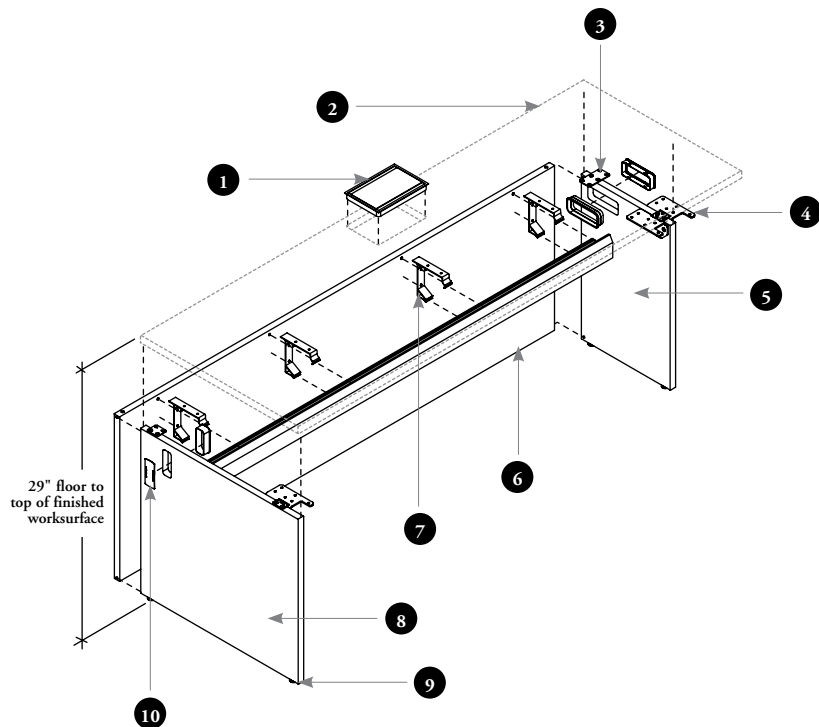

- 1 Access Door
- 2 Worksurface
- 3 Flush Plate
- 4 Assembly Plate
- 5 Non-Handed Intermediate Gable
- 6 Full or Wall Access Modesty Panel
- 7 Single-Sided Cantilever
- 8 Handed End Gable
- 9 **Levelers** are included with the gable and have an adjustment range of 3"
- 10 Gable Grommet with Cover on End Gable

shared spine desk anatomy

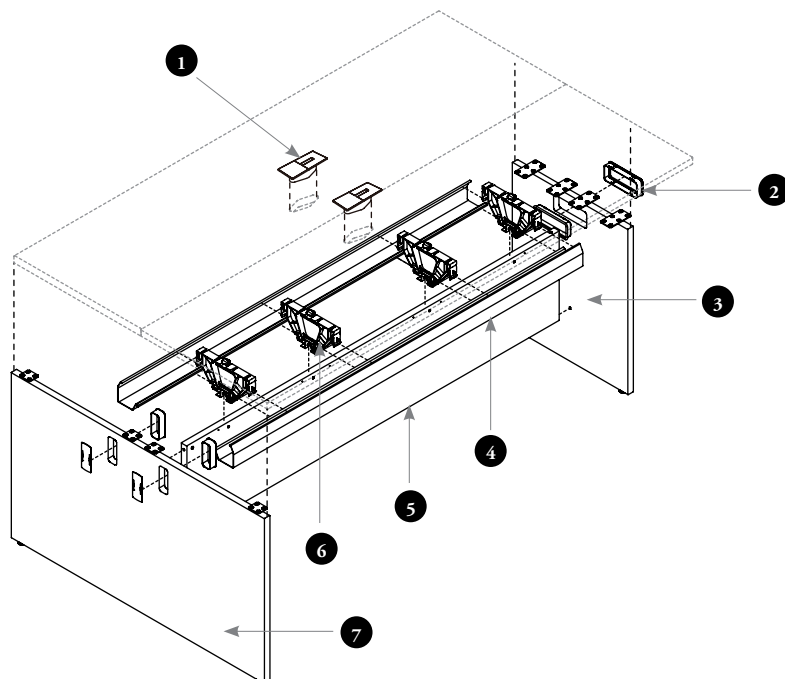

- 1 Rectangular Worksurface Grommet
- 2 The Intermediate Gable come with factory-made pass-through cut-outs to insert the **Cable Pass-Through Ring**
- 3 Non-Handed Intermediate Gable
- 4 Hinged Cable Tray
- 5 Raised Modesty Panel
- 6 Shared Cantilever
- 7 Non-Handed End Gable

spine desk basics (continued)

- ❗ Two End Spine Desks (one left and one right) can be connected side-by-side. When In-Line Spine Desks are specified, they must always be installed between a Left- and Right-End Spine Desks
- Two wire management options are available, grommets or access doors
- Desk are shipped knocked down

Single-Sided – Spine Desk – Left-End Position (RMSSL) and Single-Sided – Right-End Position (RMSEL)

- Are specified at the beginning (RMSSL) or end (RMSEL) of a desk run
- One left-end and one right-end desk are required for all single-sided applications. In-Line Position Spine Desks can be added in between the left and right end desks
- All 28" high Freestanding Storage and the Multi-Functional Drawer can be specified separately and installed under the worksurface
- Grain direction is specified on page 51

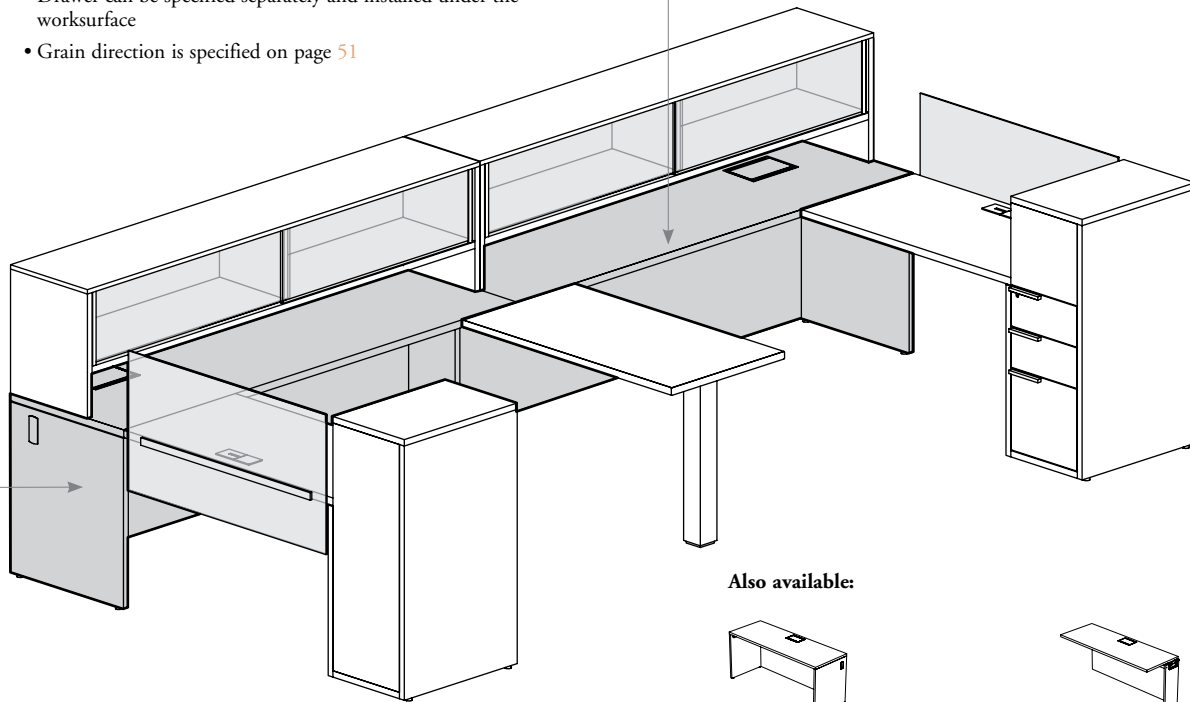

Also available:

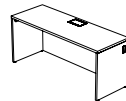

Single-Sided – Spine Desk – Freestanding (RMSRL)

- Can be use alone
- Several Freestanding Spine Desks can be connected together allowing more modularity

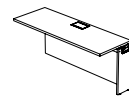

Single-Sided – Spine Desk – In-Line Position (RMSDL)

- Comes with a Full or Half (Shown) Intermediate Gable only
- Cannot be use alone
- Are used only in the center sections of a desk run

spine desk basics (continued)

Modesty Panels

- Required on all Single-Sided Spine Desks for structural stability, For details, refer on page 43
- Available in Laminate only
- Can be specified full-height or wall access, but must be consistent within same desk run
- Wall Access Modesty Panel allows access to power and communication on building wall; it is **not** intended for corridor or visitor applications, except when used in combination with a 1" Floor Screen or a 2" Freestanding Screen

Access Doors or Rectangular Worksurface Grommets

- Provide opening for electrical wiring and communication cables
 - The Access Doors also provide direct access to the electrics that are concealed underneath the worksurface
 - The Rectangular Grommet can be changed with Elliptical Grommet (RAG3) which can be specified separately
- Two rectangular worksurface grommet position styles are available :
- Both Ends (B)
 - Centered (C)
- and three Access Door position styles are available:
- Left (L)
 - Middle (M)
 - Right (R)

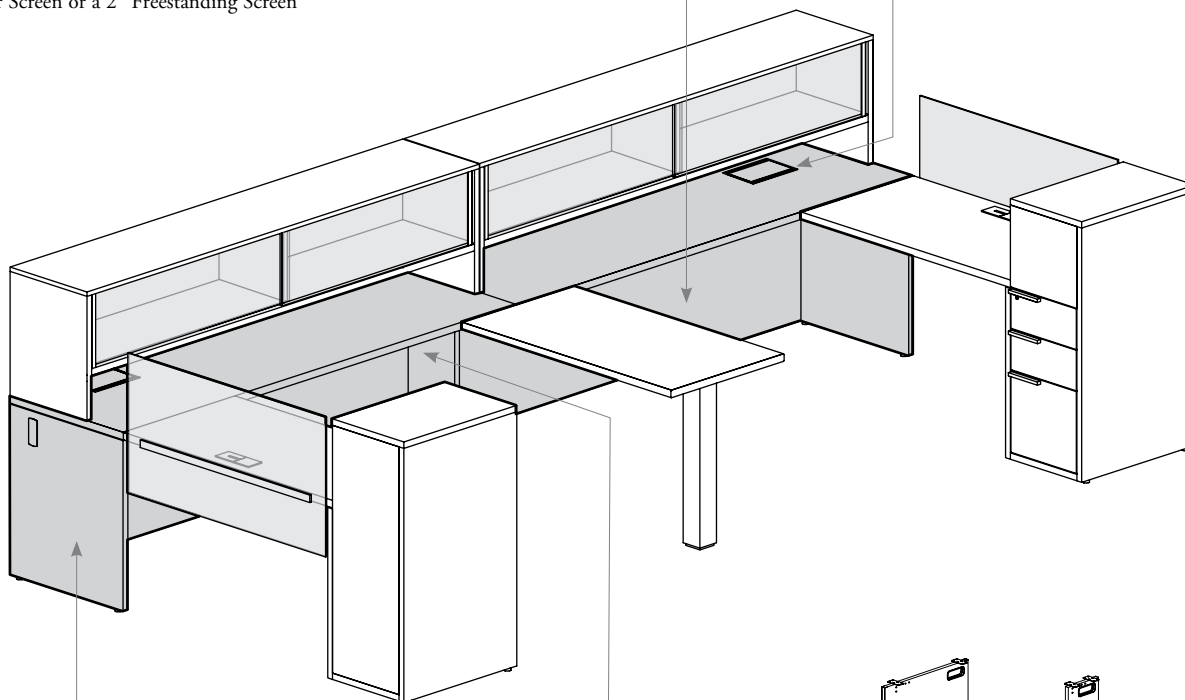

End Gables

- Are handed and **cannot** be reconfigured on-site
- Spine Desks offer four grommet styles on gables:
 - Left and Right Grommet (B)
 - Left Grommet (L)
 - No Grommet (N)
 - Right Grommet (R)
- When a Lateral Power Pole is specified, the gable grommet must be specified to allow its installation

Intermediate Gables

- Full and half Intermediate Gables are non-handed for on-site reconfigurability
- Include a Cable Pass-Through that provides opening for electrical wiring and communication cables and is always horizontally positioned
- Half gables provide additional kneespace clearance at desk junctions, see planning restrictions on page 45

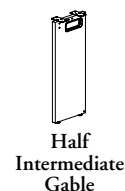
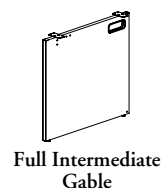

spine desk basics (continued)

Shared – Spine Desk – Left-End Position (RMDSL) and Shared – Right-End Position (RMDEL)

- Are specified at the beginning (RMDSL) or end (RMDEL) of a desk run
- One left-end and one right-end desk are required for all shared applications. In-Line Position Spine Desks can be added in between the left and right end desks
- All 28" high Freestanding Storage and the Multi-Functional Drawer can be specified separately and installed under the worksurface
- Grain direction is specified on page 51

Shared – Spine Desk – In-Line Position (RMDDL)

- Comes with a Full or Half Intermediate Gable only
- Cannot be use alone
- Are used only in the center sections of a configuration

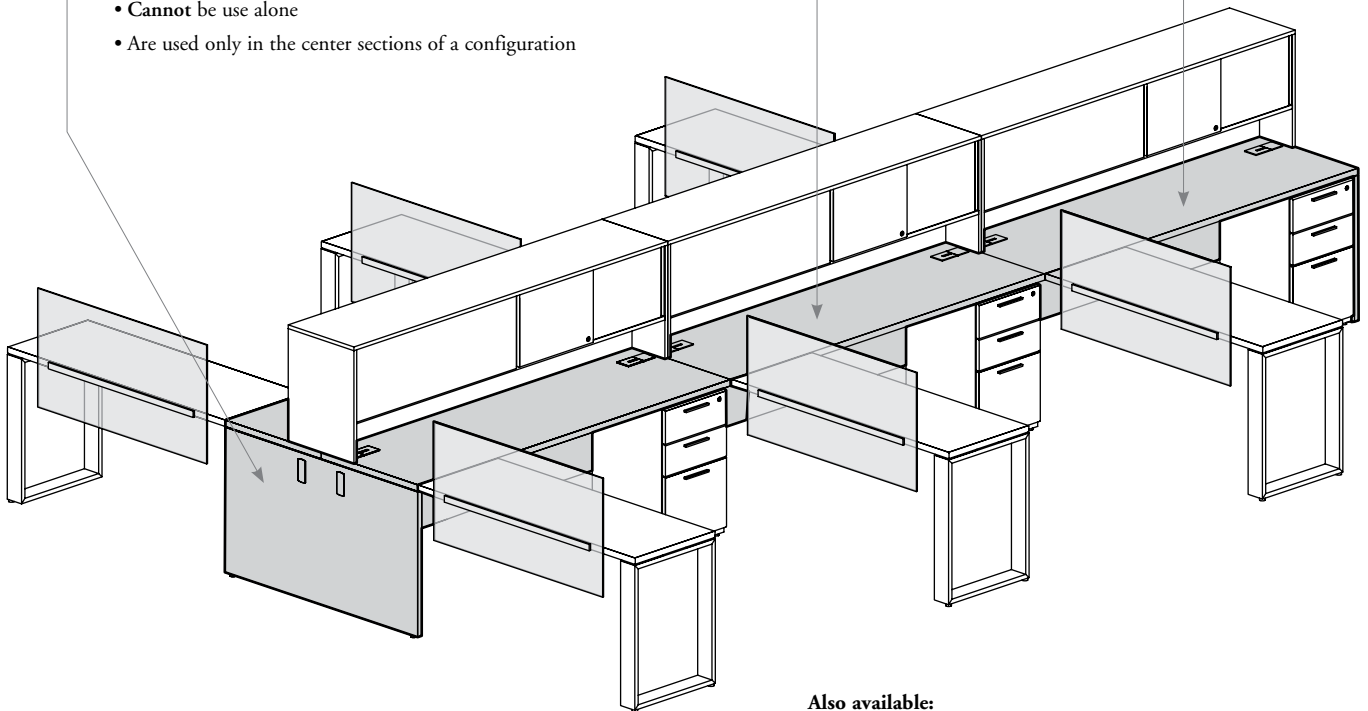

Also available:

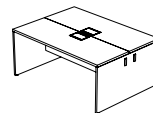

Shared – Spine Desk – Freestanding (RMDRL)

- Can be use alone
- Several Freestanding Spine Desks can be connected together allowing more modularity

spine desk basics (continued)

Access Doors or Rectangular Worksurface Grommets

- Provide opening for electrical wiring and communication cables
 - The Access Doors also provide direct access to the electrics that are concealed underneath the worksurface
 - The Rectangular Grommet can be changed with Elliptical Grommet (RAG3) which can be specified separately
 - Two rectangular worksurface grommet position styles are available:
 - Both Ends (B)
 - Centered (C)
- and five Access Door position styles are available:
- Offset Left (D)
 - Offset Right (E)
 - Left (L)
 - Middle (M)
 - Right (R)

Modesty Panels

- Raised-Height Modesty Panels are included with all Shared Spine Desks. For details, refer on page 43
- Available in Laminate only
- Raised Modesty Panel allows access from both sides of the desk to power and communication under desks

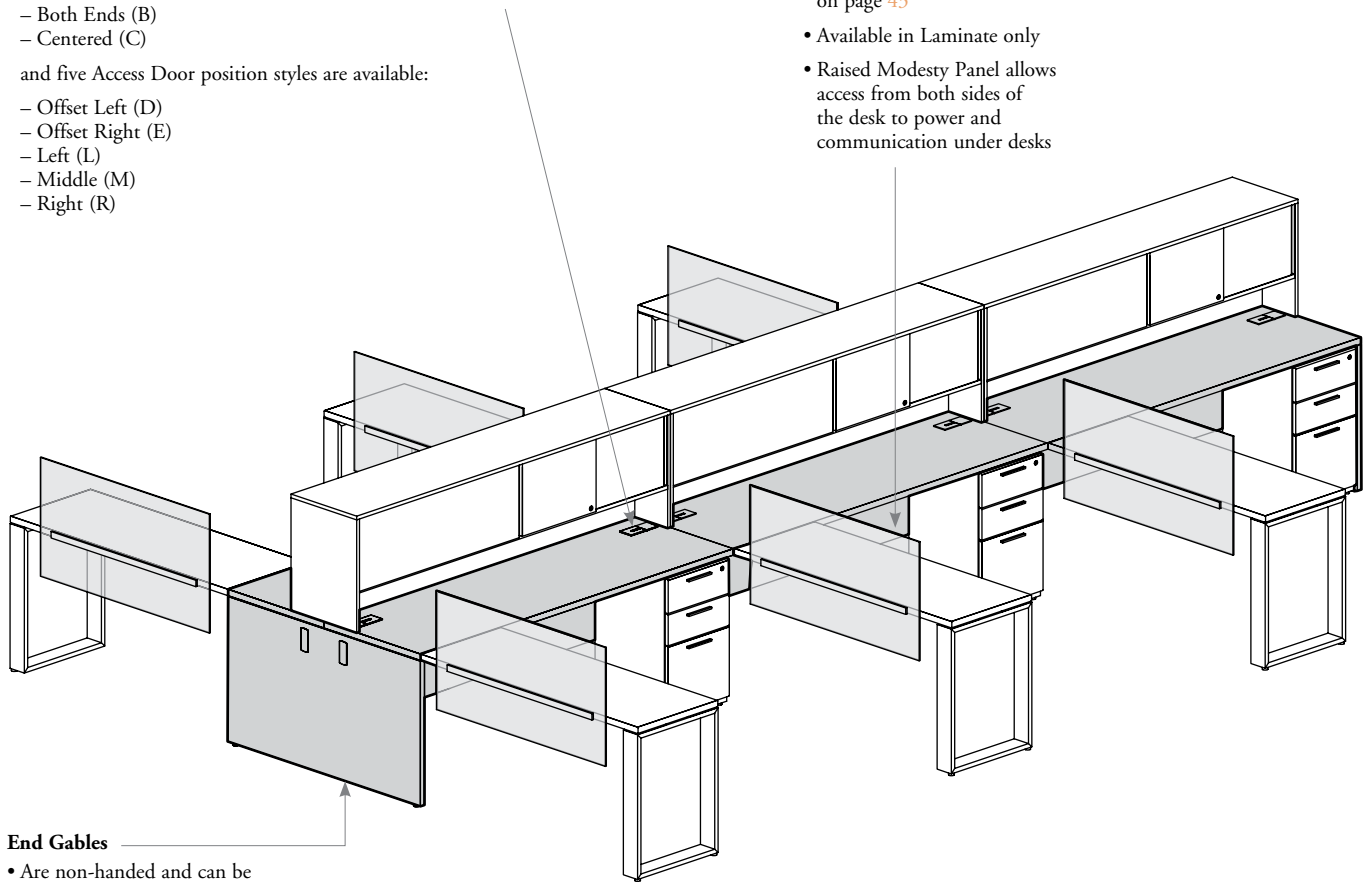

End Gables

- Are non-handed and can be reconfigured from left end position desk to right end position desk
- Spine Desks offer two grommet styles:
 - Grommet (G)
 - No Grommet (N)
- When a Lateral Power Pole is specified, the gable grommet must be specified to allow its installation

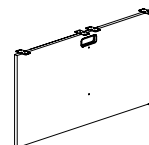

Full Intermediate Gable



Half Intermediate Gable

Intermediate Gables

- Full and half intermediate gables are non-handed for on-site reconfigurability
- Include a Cable Pass-Through that provide openings for electrical wiring and communication cables
- Half gables provide additional kneespace clearance at desk junctions

modesty panel & gable basics

Modesty Panels create seated privacy for various configurations. The **Raised Height** allow access to electrical outlets as well as power/data sharing between workstation in cluster applications.

- ❗ All Spine Desks come with 1" thick low pressure laminate (LPL) modesty panels and gables
- No grommet on all modesty panels

End Gables

All Spine Desks can be specified with or without grommet

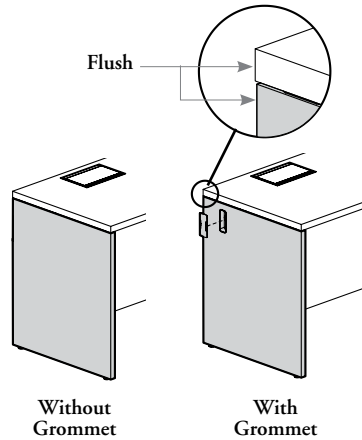

Intermediate Gables

Come with an horizontal Cable Pass-Through Ring

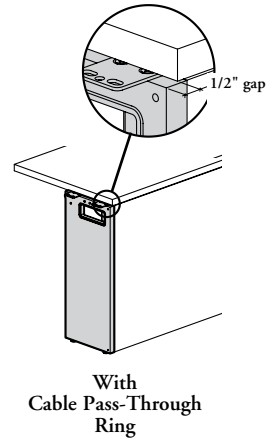

Flush Full-Height Modesty Panels

- Only available with Single-Sided Spine Desks
- Connect to the rear of a Spine Desk
- A 1" Floor Screen **cannot** be installed to the rear of a Spine Desk with full-height modesty panel
- It is recommended for corridor application

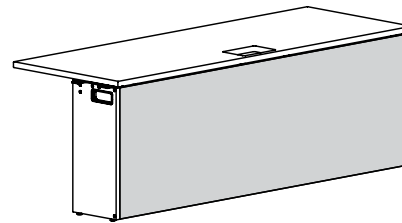

Flush Full-Height (F)

Wall Access Modesty Panels

- Only available with Single-Sided Spine Desks
- Connect to the rear of a Spine Desk
- It is **not** intended for corridor or visitor application, except when used in combination with screens
- The 20" clearance above floor allows access to wall outlets
- Can be used in combination with 1" Floor Screens or 2" Freestanding Screens

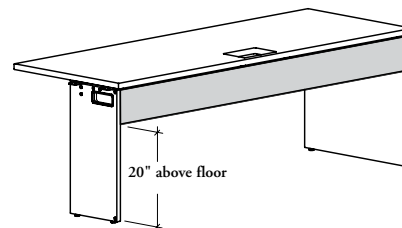

Wall Access (W)

Raised-Height Modesty Panels

- Only available with Shared Spine Desks
- Centered below two shared worksurfaces of a Spine Desk
- The 4" clearance underneath worksurface and top of modesty panel allows wire management

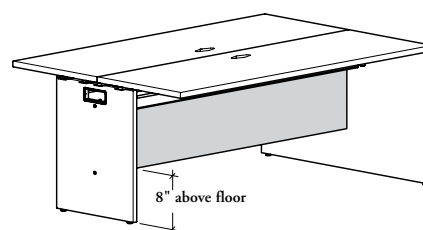

Raised Height (R)

planning with spine desks

The following should be taken into consideration when planning with Spine Desks.

single-sided or shared spine desks – freestanding

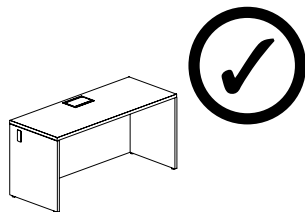

Only the Freestanding Spine Desks can be used alone

Alone Application

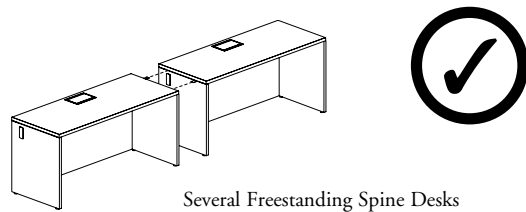

Several Freestanding Spine Desks can be linked together using the linking plate provided with each desk

Benching Application

single-sided or shared spine desks – end & in-line position

End Positions or In-Line Positions **cannot** be used freestanding

Two Spine Desks Side-by-Side

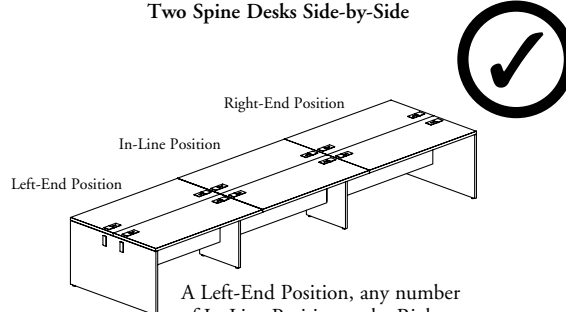

A Left-End Position, any number of In-Line Position and a Right-End Position are necessary for the construction of a bench

Single Benching

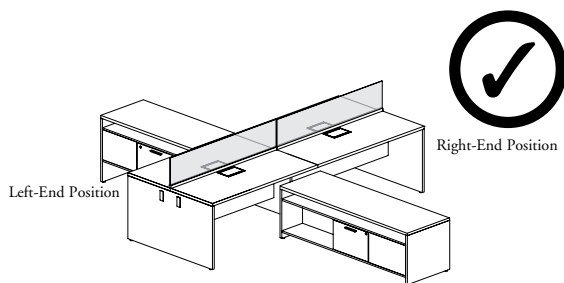

The Left- and the Right-End Spine Desks can be linked side-by-side allowing the collaborative space

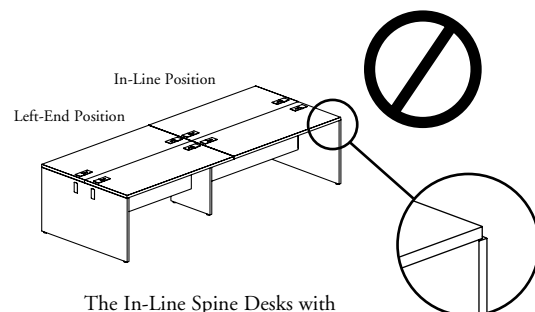

The In-Line Spine Desks with Full Intermediate Gable **cannot** be used as an End Spine Desk. They are used only in the center section of a configuration

planning with spine desks (continued)

Several Benching

Desk Bench can be linked with another desk bench

24" deep single-sided spine desks – end & in-line position

24" deep Single-Sided Spine Desks assembly requires full gables at each worksurface junction

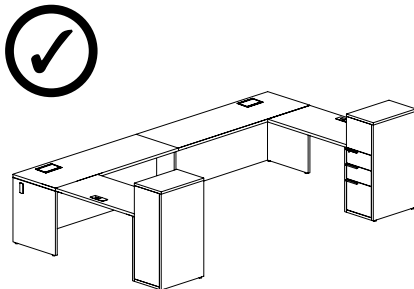
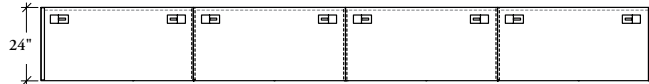
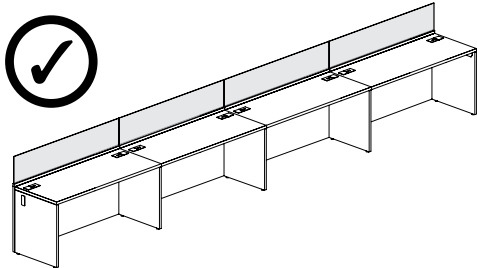

With Rectangular or Peninsula Workspaces

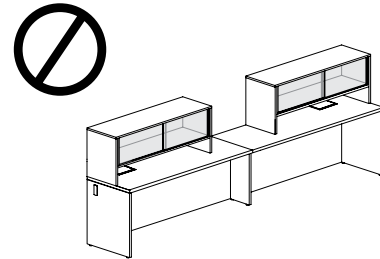

With Elevated Desktop Cabinets

Cannot be mounted off-module on Single-Sided Spine Desks. Refer on Desk-Mounted Storage Compatibility Chart on page 111 for more details

30" deep single-sided spine desks – end & in-line position

30" deep Single-Sided Spine Desks assembly requires full gables at each 168" span

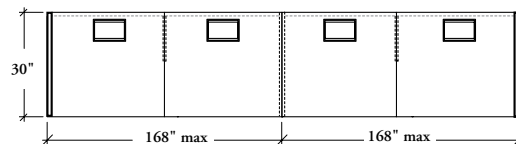
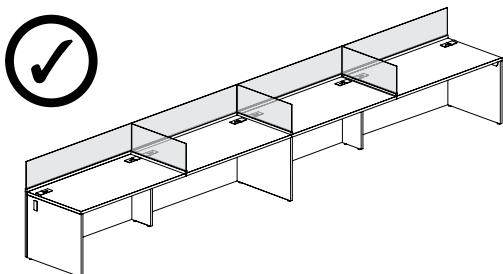

planning with worksurfaces, mounted storage & screens

The following should be considered when planning with Spine Desks and compatible Expansion Desking products.

- ◆ The Spine Desks are compatible with the following Expansion Desking products: worksurfaces, screens and Elevated Desktop Cabinets
- In addition to the applications listed below, other restrictions should be applied when specifying Expansion Desking products. See the applications page of each section of the compatible products below

worksurface applications

Rectangular Worksurface and D-Shaped Peninsula Worksurfaces

Worksurfaces mounts perpendicular on the user edge

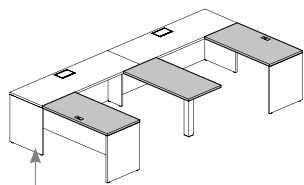

Must be aligned or centered with worksurface ends

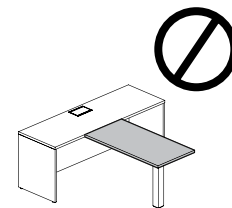
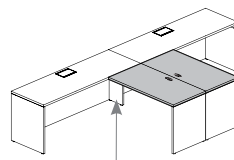

Cannot be centered on a worksurface

elevated desktop cabinets applications

Spine Desks / Elevated Desktop Cabinets combinations are **not** all possible, see Desks-Mounted Storage Compatibility Chart in Mounted Storage Application Guide

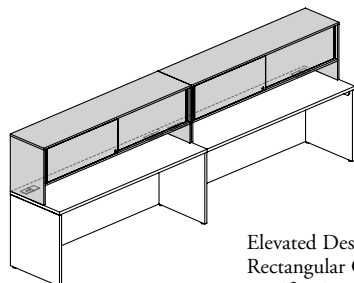

Elevated Desktop Cabinets will allow using Rectangular Grommets or Access Doors. Use specification software appropriately to avoid any interference

planning with worksurfaces, mounted storage & screens (continued)

screen applications

Add-On Screens and 1" Floor Screens

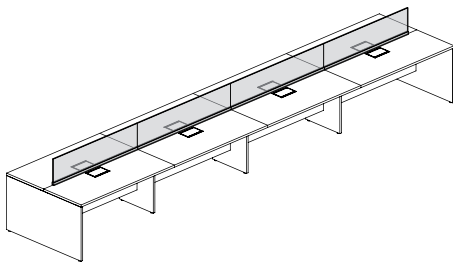

Several Central Screens for Spine Desks can be mounted on- or off-module in Back Position on the connection between two Single-Sided Spine Desks back-to-back or centered on a Shared Spine Desk

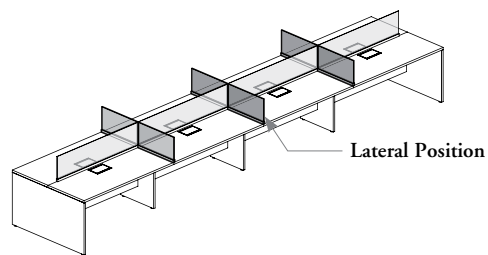

Only three Lateral Screens for Spine Desks can be installed on a bench

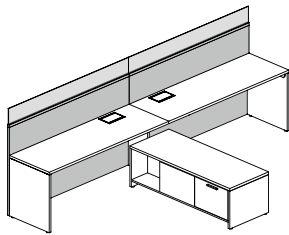

Several 1" Floor Screens can be mounted on-module in back position on a Single-Sided Spine Desk with Wall-Access Modesty Panel and must be fixed between two gables

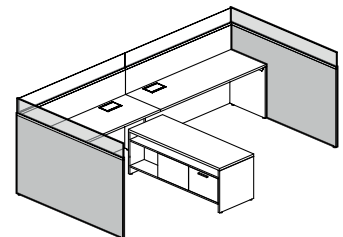

One 1" Floor Screen can be mounted on- or off-module in lateral position on a Single-Sided or a Shared Spine Desk and must be fixed to a full gable

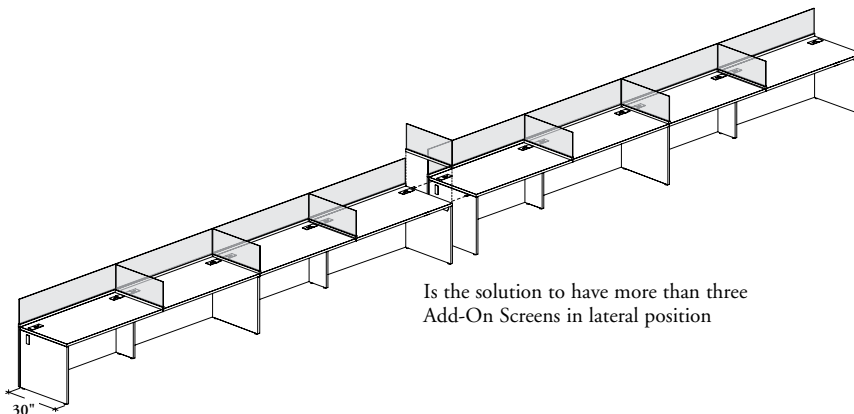

Is the solution to have more than three Add-On Screens in lateral position

planning with access doors & rectangular grommets positions

The following should be considered when planning grommets and access doors positions on Spine Desks.

- All desks are available with factory-made grommet or access door cut-outs
- Provide opening for routing electrical wiring and communication cables through the worksurface

single-sided applications

Outline of Single Elevated Desktop Cabinets

The Access Doors and Rectangular Grommets will be accessible when installed under the shelf of an Single Elevated Desktop Cabinet

Rectangular Grommet Positions

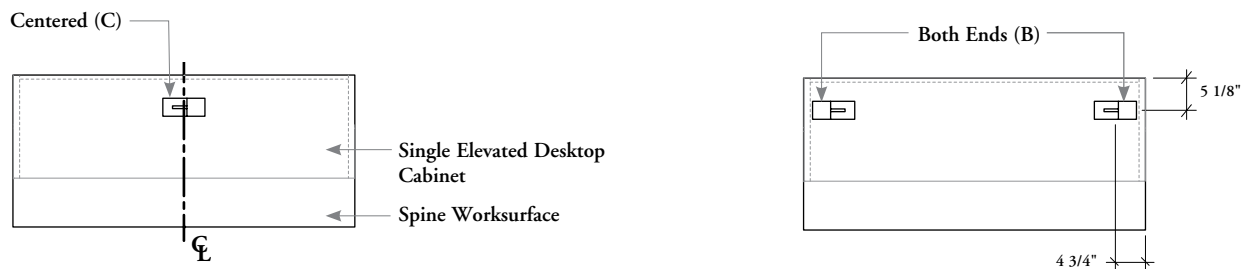

Access Door Positions

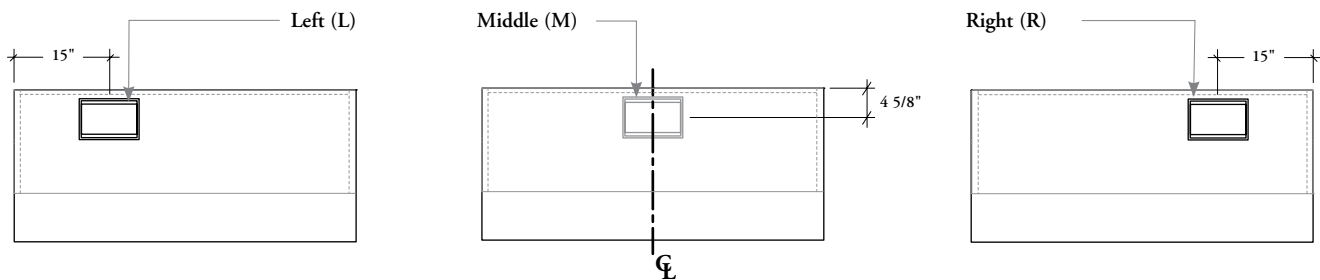

Rectangular Grommets

- Can be centered or at both ends of each worksurface
- Complements MAST Manual Arm with Expansion Grommet Mount (YMSTM_5), Dynamic Arm (YMSTD_5) or Dynamic Arm Light (YMSTX_5) can be installed through the hole of the Rectangular Grommet. For details, refer to Complements product
- The Rectangular Grommet can be changed with Elliptical Grommet (RAG3) which can be specified separately. For details, refer on page 193

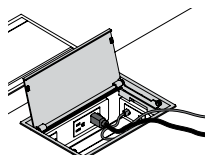

Access Doors

- Can be located to the middle, to the left or to the right of each worksurface. Can also be offset left or offset right on Shared Spine Desks
- Allows direct access to power/data under the worksurface. Can also be specified separately. See electrical section for details

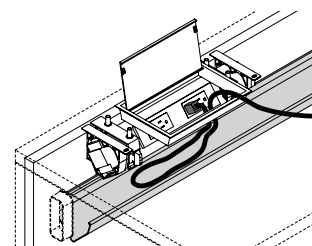

Hinged Cable Tray

- Comes with all Spine Desks and are mounted below each worksurface to manage cables coming from Access Doors or Rectangular Grommets
- Conceals and hides all electrical and data equipment
- Is mounted on hinges to allow front user access to power and data from underneath the worksurface

planning with access doors & rectangular grommets positions (continued)

shared applications

Outline of Shared Elevated Desktop Cabinets

The Access Doors and Rectangular Grommets will be accessible when installed under the shelf of an Shared Elevated Desktop Cabinet

Rectangular Grommet Positions

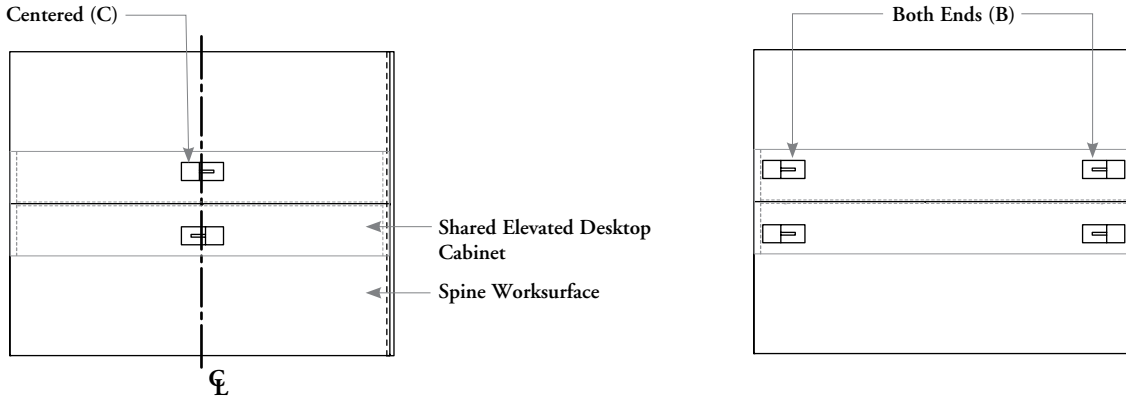

Access Door Positions

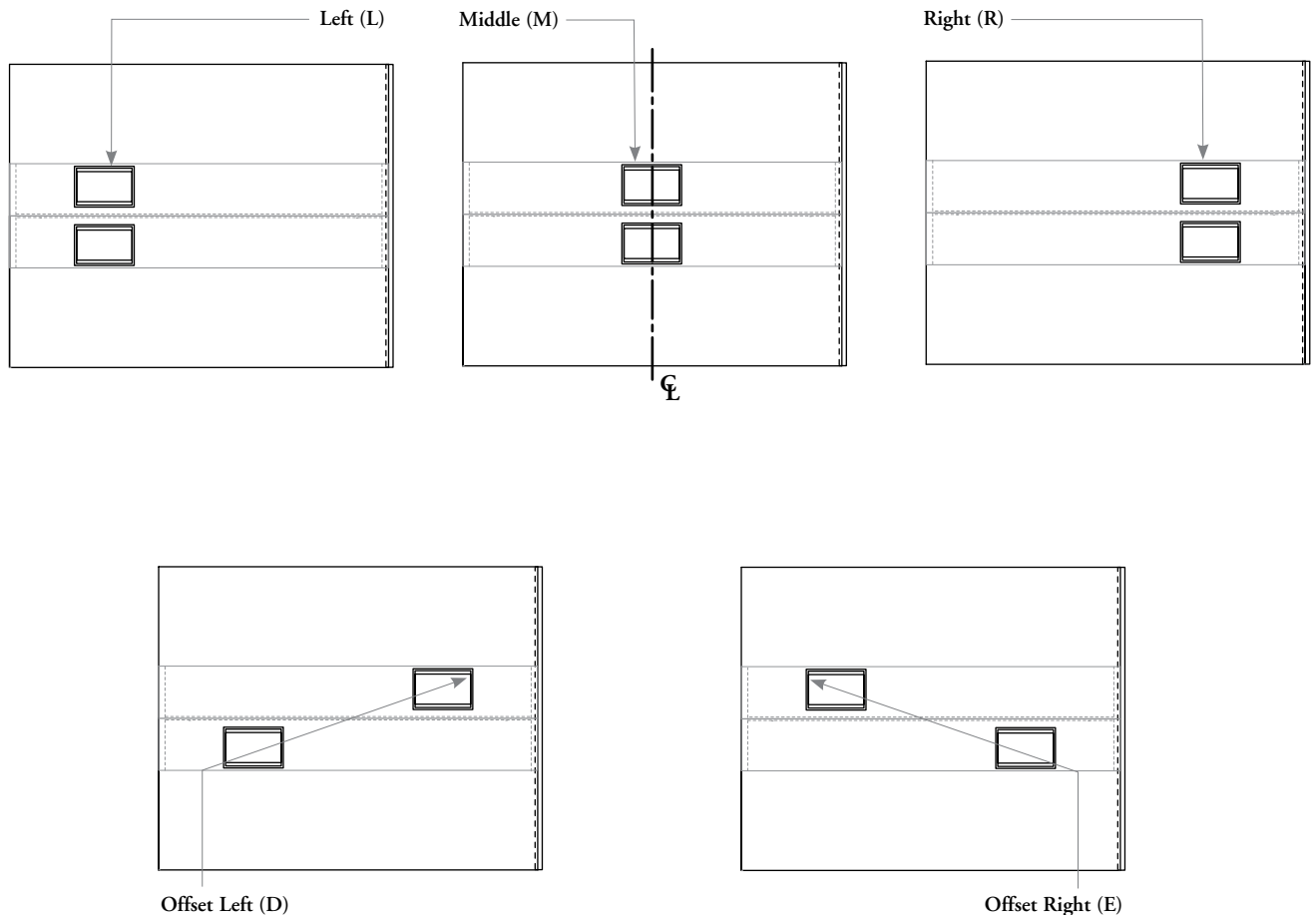

spine desk finishes

Spine Desks related parts are available in a wide variety of finish colors. Finish codes must be included in the order.

⚠ All Laminate components are protected with a solid plastic edge

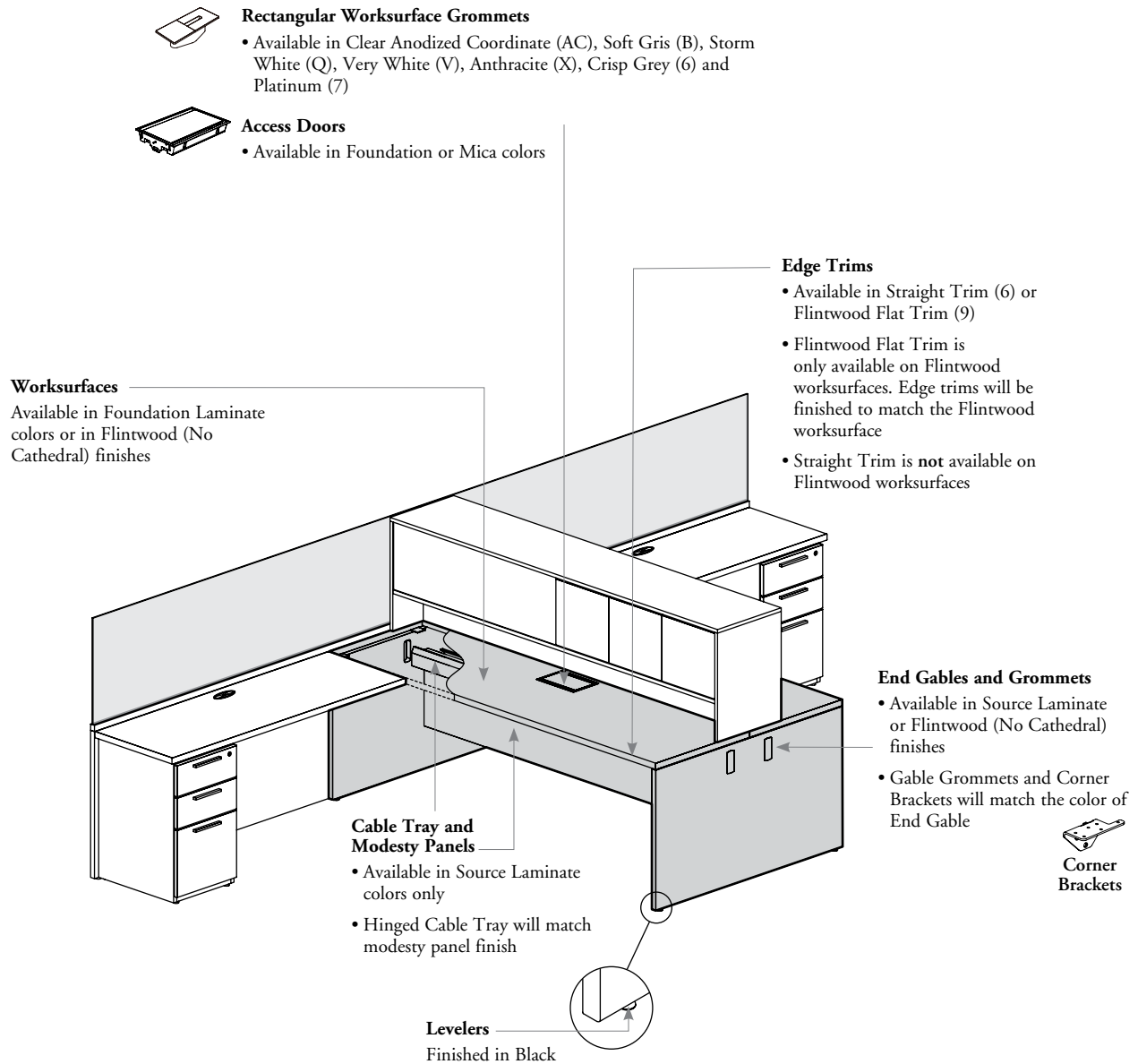

Also Available:

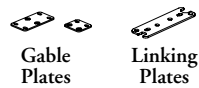

Finished in Black

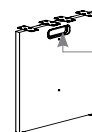

Intermediate Gables and Cable Pass-Through Ring

- The Intermediate Gable is available in Source Laminate colors only
- Cable Pass-Through Ring comes in a Platinum Coordinate

spine desk grain direction / user edge

laminite worksurface grain/pattern direction

- ❗ Grain direction is an important factor when planning learning configuration, if a different grain direction is required, please contact your Teknion Customer Service Representative
- The pattern direction of Laminate is **not** "centered" and grain direction can appear in different direction from side-to-side worksurface
- Shading indicates user edge

Single-Side Spine Desks

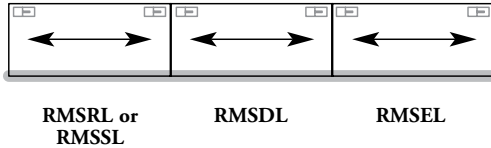

Shared Spine Desks

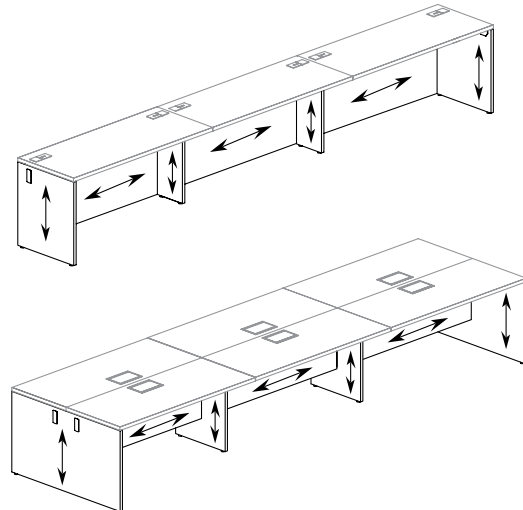
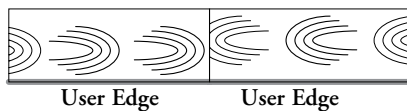
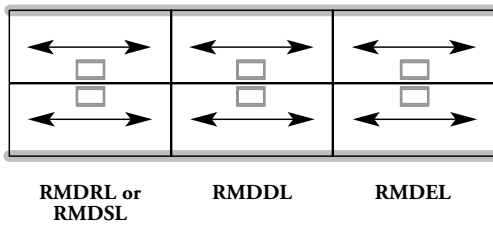

Laminate = = Grain Direction =

flintwood worksurface grain/pattern direction

- ❗ There is no user edge so care must be taken during installation to match grain/pattern direction
- Grain/patterns are **not** "centered" on worksurface
- Applies to Flintwood (Standard)

Flintwood = = Grain Direction =

- Grain direction will appear in the same direction, from side to side worksurface

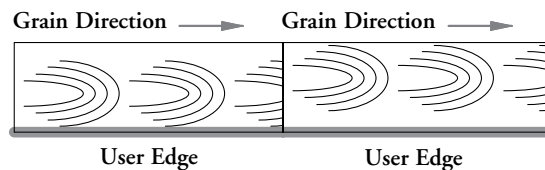

Single-Side Spine Desk or Shared Spine Desk

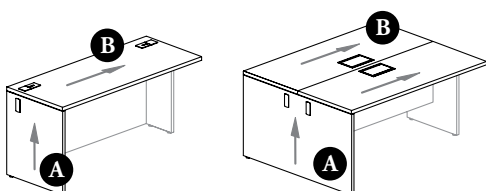

- Grain direction on Full End Gable is always vertical
- There is no matching grain across Full End Gable (A) and Worksurface (B)

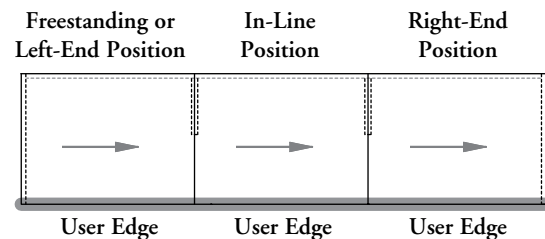

- Regardless of worksurface position, Single-Sided or Shared Spine Desks, grain direction from left to right from the user's perspective

desk accessories

desk accessories

DESK ACCESSORY BASICS54

PLANNING WITH MODESTY PANELS56

desk accessory basics

Desk accessories are used in conjunction with desks and storage to meet many work requirements.

- All accessories must be specified separately
- All dimensions are nominal

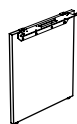

Semi-Supported Leg – Solid (RAVG)

- Supports the end of a worksurface to maintain stability
- It can be installed under a:
 - Rectangular Worksurfaces (RTLDDL, RTLDC)
 - Rectangular Peninsula Desk with Half Gables (RDRP)
- Must be specified the same depth than the worksurface
- **Cannot** replace a standard gable when attached to a corner post
- **Cannot** be used in pairs to build freestanding desks
- Are available in Source Laminate or Flintwood (No Cathedral) finishes
- Mounting Bracket will match the gable finish

Also available:

Frame Legs

- Three styles are available:



Open
RWWO

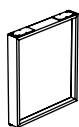

Solid
Infill
RWWFL

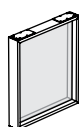

Glass
Infill
RWWFG

- Support the end of a worksurface to maintain stability
- It can be installed under a:
 - Rectangular Worksurfaces (RTLDDL, RTLDC)
 - Rectangular Peninsula Desk with Half Gables (RDRP)
- Must be specified the same depth than the worksurface
- Glass Infill is available in 5/32" (4 mm) Standard (Frosted (FT)) or Back-Painted tempered glass
- Frames are available in Clear Anodized, Foundation, or Mica colors
- Solid Infill is available in Source Laminate or Flintwood (No Cathedral) finishes
- Levelers and support brackets come in Black

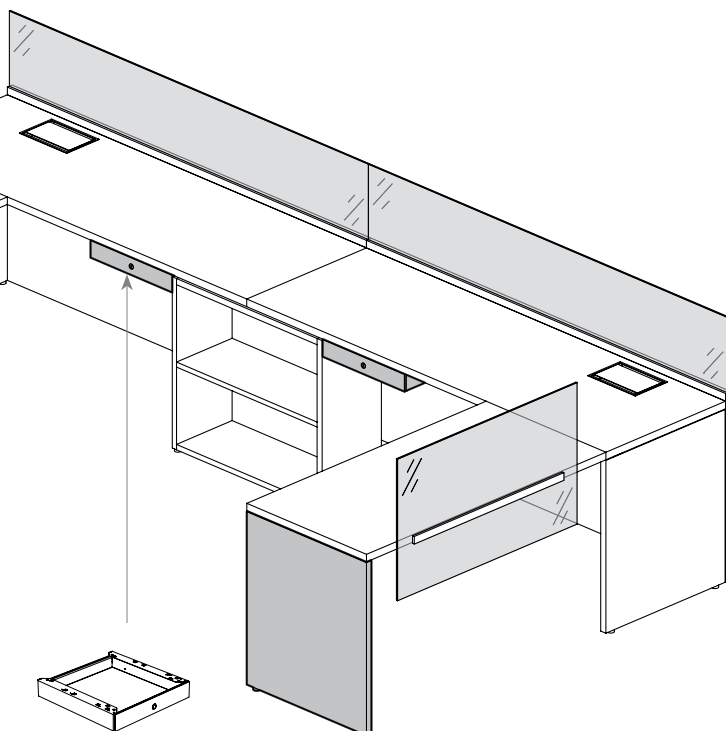

Multi-Functional Drawers (RADMF)

- Provide convenient small lockable (if specified) storage space for a workstation
- Have no pull; slides have an integrated touch-latch for the opening
- Drawers have full extension slides
- Drawer Front and Pencil Tray are finished in Clear Anodized and Case Finish is available in Arctic color only
- Included Features (actual dimensions):
 - Internal space capacity is 12 1/2" deep x 14 1/2" wide x 2" high with pencil tray
 - Removing the pencil tray will provide an additional depth of:
 - 2" (with lock)
 - 3 1/2" (no lock)
 - Wires up to 5/8" diameter can be routed inside the drawer; wires can be restrained using tie wraps (not included)

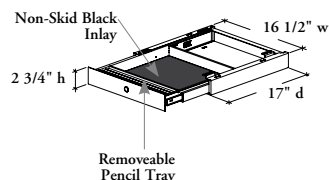

desk accessory basics (continued)

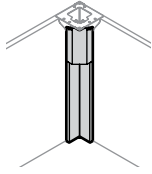

Corner Post Cover (RAPC)

- Magnetic
- Provides an aesthetic look and hides the Corner Post
- Available in Foundation, Mica and Coordinate Colors

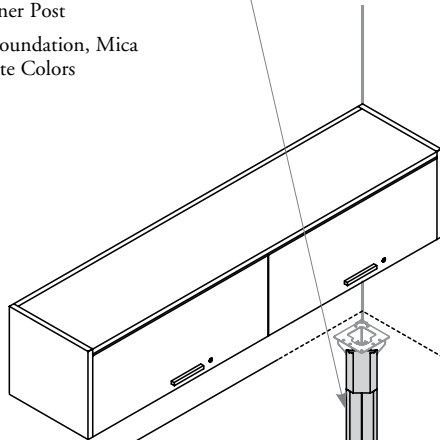

Retractable Keyboard Shelf (RAKB)

- Provides a retractable support for both a keyboard and a mouse
- The shelf is available in Source Laminate colors
- The wrist support and retaining rods are finished in Black

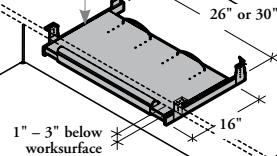

Half-Moon Pencil Tray (RAX01)

Finished in Black



Legs (When specified separately)

- Are available in Foundation or Mica colors, except Central Square Post Leg which can also be specified Clear Anodized
- Leveler comes in Black
- Three supports are available:



Angled Leg (RWLA)

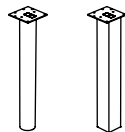

Central Post Legs –
3 1/2\"/>

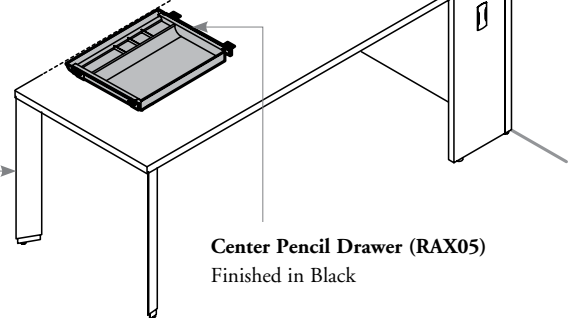

Center Pencil Drawer (RAX05)
Finished in Black

planning with modesty panels

Flush-Mounted, Inset and Worksurface Suspended Modesty Panels create privacy below the worksurface.

- Must be specified separately
- Worksurface Suspended Modesty Panels can be installed 6" recessed or at the user's convenience

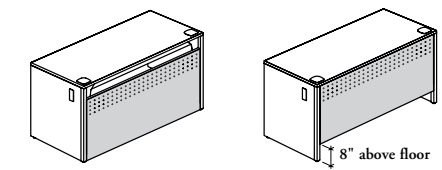
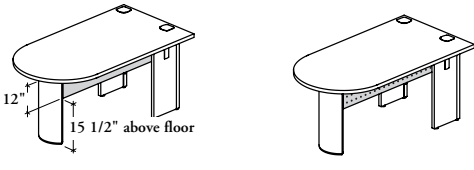
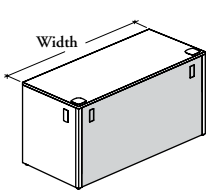
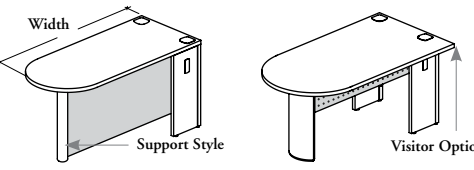
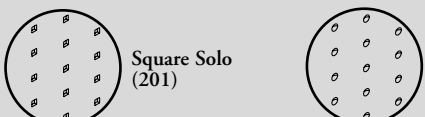
Modesty Panel Style	Flush-Mounted Modesty Panels (RDML, RDMO)	Inset Modesty Panels (RAML, RAMO)
<p>Modesty Panel Style and Height Option Graphic</p> 	 <p>3/4-Height (T) Low Position (flush with bottom of gable) Solid (RDMLT) or Metal (RDMOT)</p> <p>3/4-Height (T) High Position Solid (RDMLT) or Metal (RDMOT) 8" above floor</p>	 <p>Half-Height (H) Solid (RAMLH)</p> <p>Half-Height (H) Metal (RAMOH)</p>
<p>Product Compatibility</p>	<p>All Modular Desks with Corner Posts (installed between two Corner Posts)</p>	<p>Peninsula Desks (RDBU, RVDD, RVXD, RDPD) and Peninsula Worksurface (RDBN) with Central Post Leg or Camber Base only</p>
<p>Width Specification</p>	 <p>Specify Desk Width</p>	 <p>Specify Desk Visitor option, Support Style and Desk Width (D-Shaped Peninsula Worksurface (RDBN) requires to add 6")</p>
<p>Wire Routing</p>	<p>Grommet Option available on Full-Height Modesty Panel only, 3/4"-Height (T) in low position allows sharing electrics</p>	<p>No grommet supplied, wires can be routed in the 3/8" high gap between modesty panel and worksurface</p>
<p>Laminate Construction and Finish</p>	<p>1" thick LPL (Low Pressure Laminate) available in Source Laminate colors</p>	
<p>Metal Construction and Finish</p>	<p>1" thick folded metal sheet panel available in Foundation or Mica colors</p>	
<p>Glass Construction and Finish</p>	<p>N/A</p>	
<p>Embossed Pattern Option on Metal Modesty Panel</p>	 <p>Square Solo (201)</p> <p>Dot Solo (401)</p>	

planning with modesty panels (continued)

Worksurface Suspended Modesty Panels (REVL, REVO and REVG)

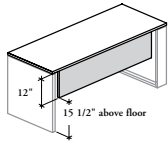

Half-Height (H)
Solid
(REVLH)

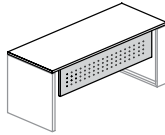

Half-Height (H)
Metal
(REVOH)

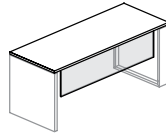

Half-Height (H)
Standard or
Back-Painted Glass
(REVGH)

N/A

Rectangular Worksurfaces (RTLDDL, RTLDC) or any table like or peninsula like product when a more accurate fit with supports is needed (use specification software)

The appropriate width is determined by subtracting the corresponding value of a support style for each end of the worksurface from nominal width of the worksurface

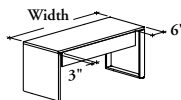

Example:
Rectangular Worksurface
with Frame Leg and
Semi-Supported Leg
(Worksurface Width minus 6"
and minus 3")

Style	Style Description	Modesty panel width compared to worksurface width**	Style	Style Description	Modesty panel width compared to worksurface width**
F	Flush Plates	+ 6"	P	Central Post Legs	- 16"
H	Hang-On	- 1"	S	Pedestal	- 16"
L	Legs	- 7"		Lateral File, Combo Pedestal or 28" high Storage Cab.	* - 19", - 25", - 31", - 37"
	Semi-Supported Leg	- 3"			
	Frame Leg	- 6"			

* 1" wider than storage nominal dimension
** For better fit, use specification software

No grommet supplied, wires can be routed in the 3/8" high gap between modesty panel and worksurface

1" thick LPL (Low Pressure Laminate) available in Source Laminate colors

1" thick folded metal sheet panel available in Foundation or Mica colors

1/4" (6 mm) thick Tempered Glass available in Standard Glass finish: Frosted (FT) is a single-sided etched tempered glass which is facing inward of workstation or in Back-Painted Glass

All Embossed Patterns listed on the previous page can be used with these modesty panels

columns & screens

columns & screens

COLUMN-MOUNTED UNFRAMED ELEMENT BASICS	63
COLUMN-MOUNTED FRAMED ELEMENT BASICS	64
ADD-ON SCREEN FOR MODULAR DESK & WORKSURFACE EDGE SCREEN BASICS	66
CENTRAL SCREEN FOR SPINE DESK BASICS.	67
LATERAL SCREEN FOR SPINE DESK BASICS	68
1" FLOOR SCREEN BASICS	69
MARKERBOARD – SCREEN MOUNTED BASICS	70
PLANNING WITH ADD-ON SCREENS FOR MODULAR DESK.	72
PLANNING WITH WORKSURFACE EDGE SCREENS	74
PLANNING WITH CENTRAL SCREENS FOR SPINE DESK	76
PLANNING WITH LATERAL SCREENS FOR SPINE DESK.	78
CENTRAL & LATERAL SCREENS COMPATIBILITY	82

columns & screens (cont'd)

PLANNING WITH 1" FLOOR SCREENS	84
2" FREESTANDING SCREEN BASICS.	88
FREESTANDING SCREEN CONNECTIONS.	90
FREESTANDING SCREEN RESTRICTIONS.	91
PLANNING WITH CABLE PASS-THROUGH	92
COLUMN & SCREEN FINISHES	95

column-mounted unframed element basics

Expansion Desking offers a wide range of space division products. Column-Mounted Unframed Elements can be mounted to structural columns in side-by-side or vertical combinations. Screens of various heights allow the right balance of privacy and interaction.

- ❗ Can only be installed on straight edges of Modular Desks products
- All column and element dimensions listed are nominal: elements should be specified according to column height and worksurface width, refer to the bottom of this page
- Base element must be a full-width single element
- When used with a standalone 20" deep Rectangular Desk, or with a standalone 24" deep Rectangular Desk with Metal C-Legs, the unit must be used against a wall or in a back-to-back application for stability

Structural Column (RPSC)

- To mount components above the worksurface:
 - overhead cabinets
 - elements
 - shelves
 - accessory rails
 - countertops
- 37" or 52" high columns are recommended for all overhead storage applications
- 52" high columns are required when overhead storage or shelves are stacked
- Can be used to route electrical and data cables
- The central groove may be used for the light cords
- Requires no tool for installation

Column Extension (RPCE)
To mount elements only, not for overhead storage or shelves

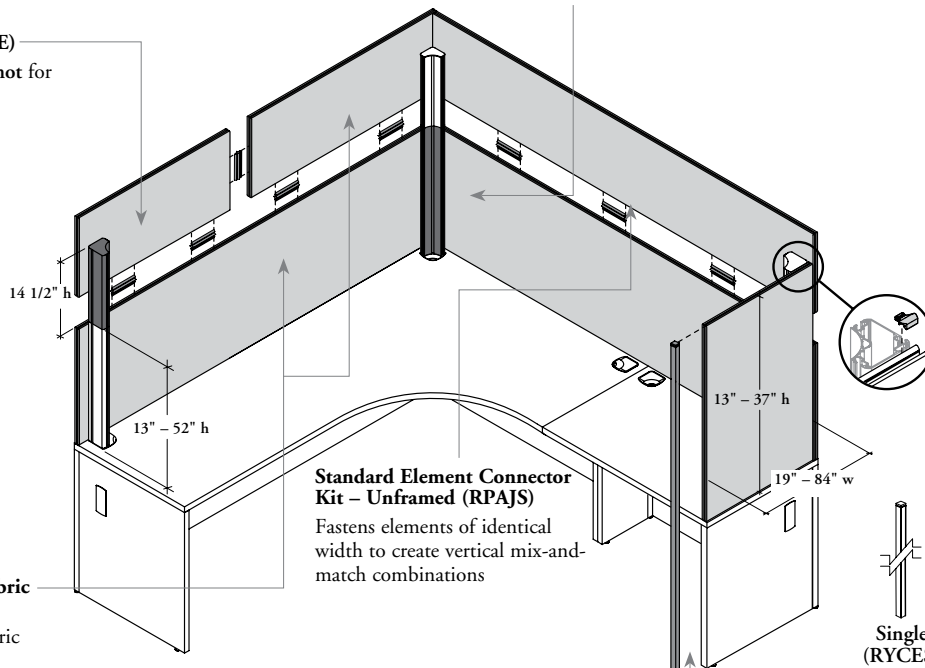
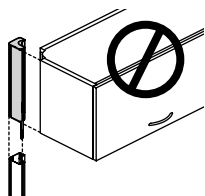

Standard Element Connector Kit – Unframed (RPAJS)
Fastens elements of identical width to create vertical mix-and-match combinations

Unframed Elements – Fabric (RPSF)

- Two-sided with same fabric
- Come in one piece
- Tackable on both sides
- Elements are 1" thick

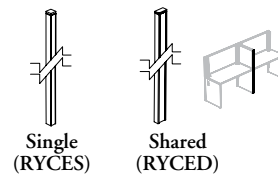

Lateral Stabilizer – Elements (RYCE)

- Stabilizes elements mounted on the side of a desk
- Provides a finished covering for the end of an element(s)
- Available in single or shared configuration
- Single configuration is used to stabilize 1" elements
- Must be applied to a full gable

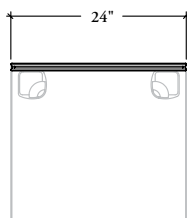

Full Size – Back
(element matches width of worksurface)

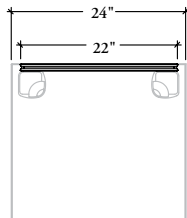

Recessed Size – Back
(element applied flush with edge of columns)

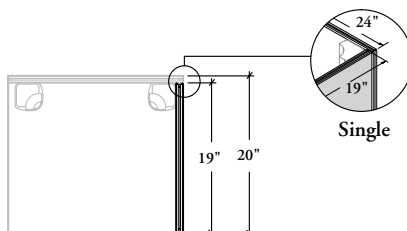

Recessed Size – Lateral

column-mounted framed element basics

Expansion Desking offers a wide range of space division products. Framed elements can be mounted to structural columns in vertical combinations only. Elements of various heights allow the right balance of privacy and interaction.

- Framed Elements are 1" or 2" thick
- Framed Elements can only be installed on-module and on straight edges
- All element dimensions listed are nominal: elements should be specified according to column height and worksurface width, refer on the following pages
- When used with a standalone 20" deep Rectangular Desk, or with a standalone 24" deep Rectangular Desk with Metal C-Legs, the unit must be used against a wall or in a back-to-back application for stability

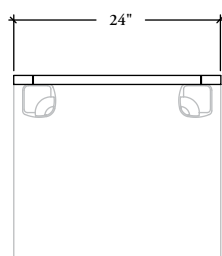
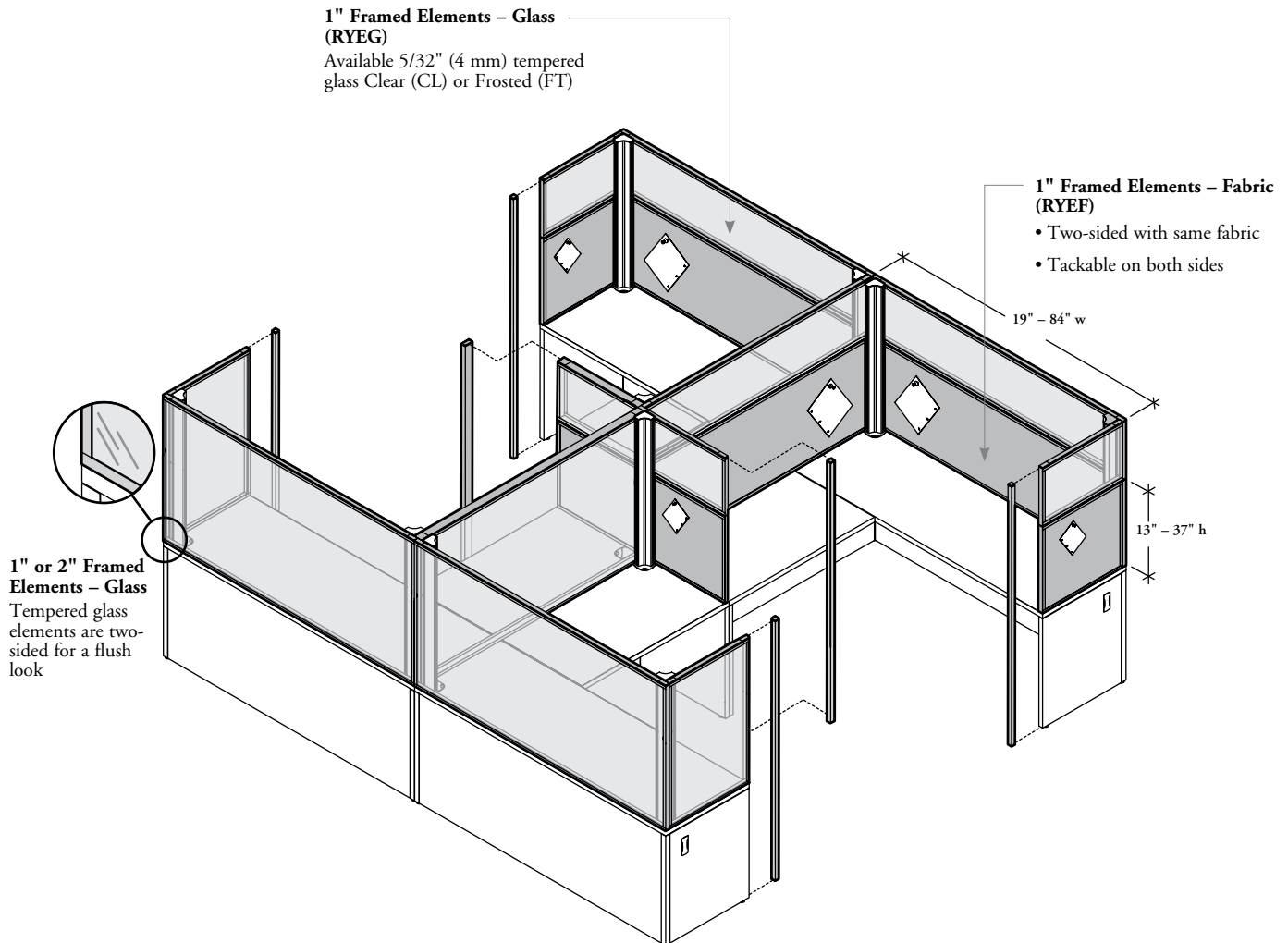

Full Size – Back
(element matches width of worksurface)

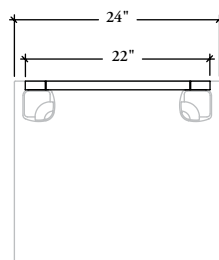

Recessed Size – Back
(element applied flush with edge of columns)

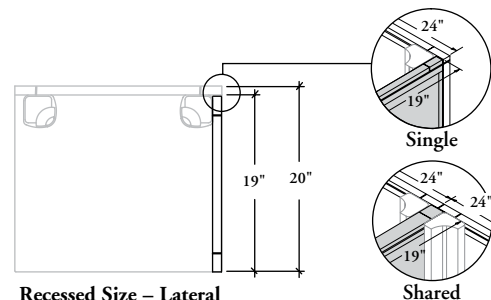

Recessed Size – Lateral

column-mounted framed element basics (continued)

❗ 2" Framed Elements can only be used between two workstations made with Modular Desks

Lateral Stabilizer – Elements (RYCE)

- Stabilizes elements mounted on the side of a desk and provides a finished covering for the end of an element(s)
- Available in single or shared configuration
- Single configuration is used to stabilize 1" Framed Elements
- Shared configuration is used to stabilize 2" Framed Elements
- Must be applied to a full gable

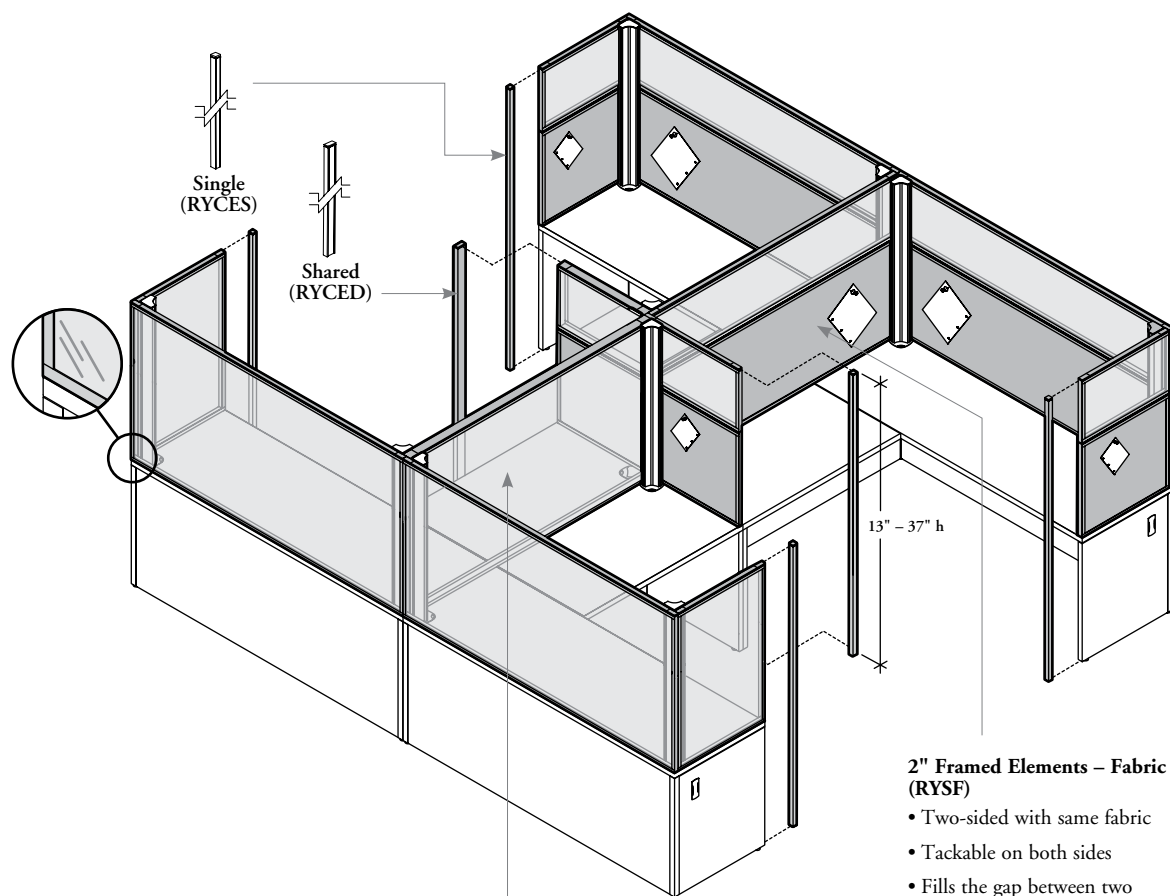

2" Framed Elements – Glass (RYSG)

- Available 5/32" (4 mm) tempered glass Clear (CL) or Frosted (FT)
- Fills the gap between two structural columns for a nicer aesthetic

2" Framed Elements – Fabric (RYSF)

- Two-sided with same fabric
- Tackable on both sides
- Fills the gap between two structural columns and overhead cabinets for a nicer aesthetic

add-on screen for modular desk & worksurface edge screen basics

Expansion Desking provides a variety of casual screens for space division in freestanding applications.

- ❗ • All screen dimensions listed are nominal
- Match 42" or 51" high datum line

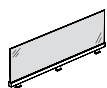

Add-On Screens for Modular Desk (RPSAG)

- A mounted screen used for back or perpendicular territorial screening
- Intended to sit on the top of the modular desks
- When Desk-Mounted option (D) is specified, screens provide 6", 7", 13", 15" or 22" of privacy above modular desk (Shown)
- Even widths are actual; odd widths are 1/2" smaller
- Available with a 1/4" (6 mm) thick single-sided etched tempered glass on top
- **Cannot** be mounted on a 1" Floor Screen or 2" Freestanding Screens

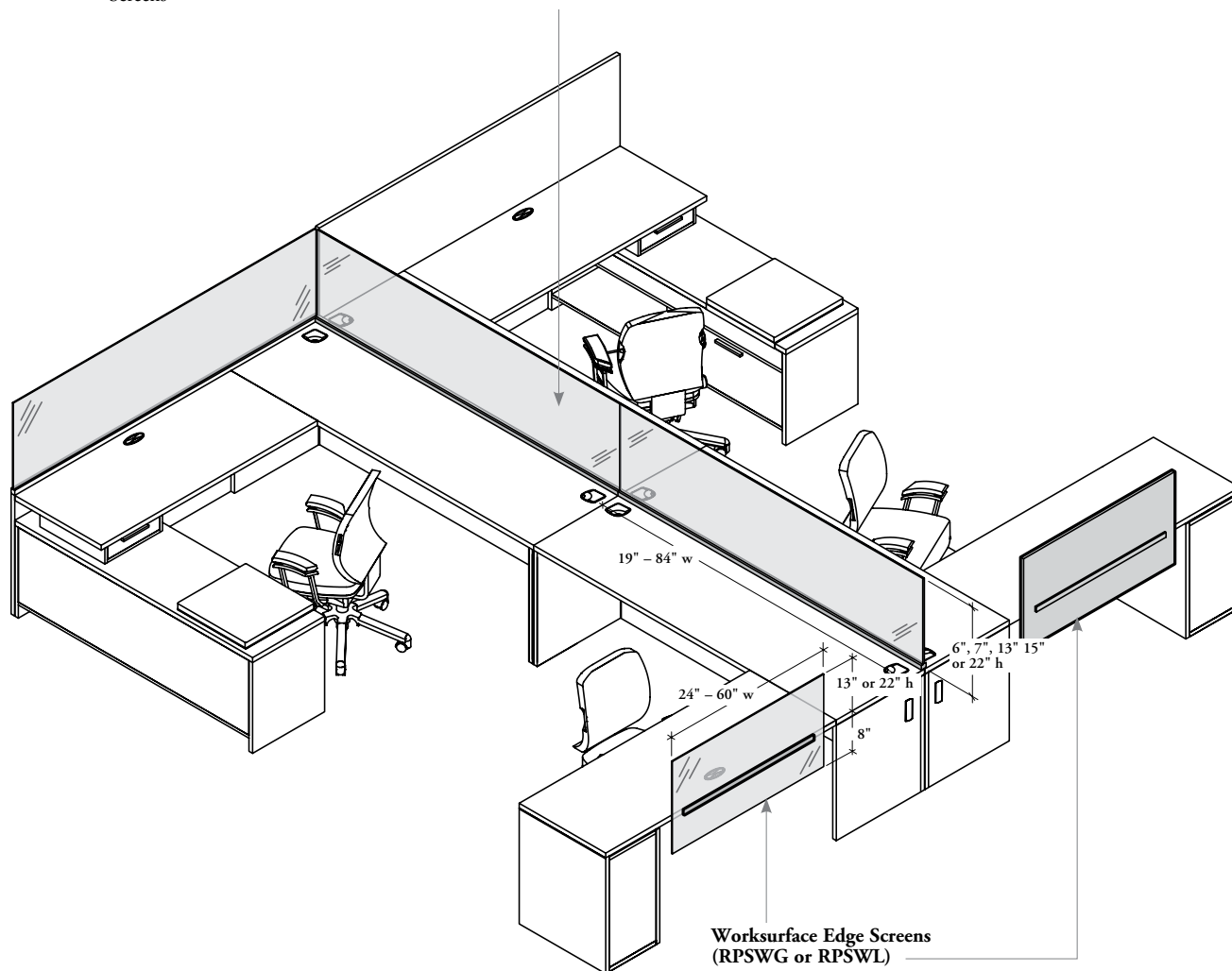

Worksurface Edge Screens (RPSWG or RPSWL)

- A territorial screen that is mounted on the back edge of a worksurface that must be free of any sub-structure
- Provide partial privacy from 8" below desk up to 13" or 22" above desk
- **Cannot** be used in combination with a Worksurface Suspended Modesty Panel
- Two finish styles are available: Solid (Laminate) and Frosted glass

central screen for spine desk basics

Expansion Desking provides a variety of casual screens for space division in freestanding application.

- All screen dimensions listed are nominal
- These screens are an ideal solution for space division in "benching" applications where various numbers of users occupy the workstation
- Match 42" or 51" high datum line
- Can be used with all Single-Sided or Shared Spine Desks and Rectangular Worksurfaces (RTLDDL or RLTDCL). The restrictions apply when specifying with Spine Desks. See the applications on pages 47 and 76
- **Cannot** be used with Modular Desks or Credenzas
- Central Screens are shipped knocked-down

Central Screens or Central Framed Screens

- A central screen used for territorial screening
- Intended to sit on the top between two worksurfaces
- Two mounting options are available:
 - Desk-Mounted (D)
 - Worksurface-Mounted (W)
- When Desk- or Worksurface-Mounted option is specified, screens provide 7" (if applicable), 13" or 22" of privacy above Spine Desk
- **Cannot** be mounted on a 1" Floor Screens or 2" Freestanding Screens
- A Markerboard – Screen Mounted can be specified separately and can be installed on Solid Central Screen for Spine Desk only (RCSBLN)

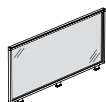

Central Framed Screens for Spine Desk – Glass (RCFBG)

- Available with two 5/32" (4 mm) thick Frosted single-sided etched tempered glass facing inward of screen assembly or Back Painted tempered glass
- Back-Painted can be used as a markerboard. Only dry erasable markers can be used

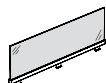
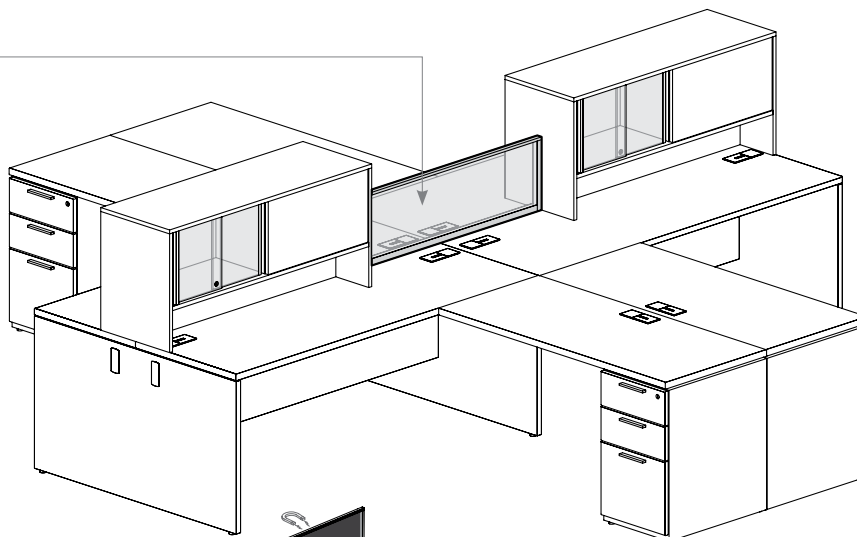

Central Screens for Spine Desk – Glass (RCSBG)

Available with a 1/4" (6 mm) thick single-sided etched tempered glass

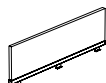

Central Screens for Spine Desk – Solid (RCSBLN)

11/16" thick laminate panel

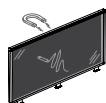

Central Framed Screens for Spine Desk – Magnetic Glass (RCFBM)

- Accept rare earth magnets
- Only dry erase markers can be used
- Available with two 5/32" (4 mm) Back-Painted tempered glass only laminated on steel sheets

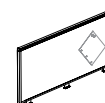

Central Framed Screens for Spine Desk – Fabric (RCFBF)

- Two-sided with same fabric
- Tackable on both sides

lateral screen for spine desk basics

Expansion Desking provides a variety of casual screens for space division in freestanding application.

- ❗ All screen dimensions listed are nominal
- These screens are an ideal solution for perpendicular space division in "benching" applications where various numbers of users occupy the workstation
- Match 42" or 51" high datum line
- Can be used with all Single-Sided or Shared Spine Desks completed or **not** with Rectangular Worksurfaces (RTLDDL or RTLDC)
- **Cannot** be used with Modular Desks or Credenzas
- Lateral Screens are shipped knocked-down

Lateral Screens or Lateral Framed Screens for Spine Desk

- A lateral screen used for perpendicular territorial screening
- Intended to sit on the top between two worksurfaces
- Three mounting options are available:
 - From Two Central Screens (C)
 - From Rear Edge (E)
 - From Two Mounted Storage (M)
- The mounting option (M) is only applicable with Elevated Desktop Cabinets
- **Cannot** be mounted on a 1" Floor Screens or 2" Freestanding Screens
- A Markerboard – Screen Mounted can be specified separately and can be installed on Solid Central Screen for Spine Desk only (RCSSLN)



Lateral Framed Screens for Spine Desk – Magnetic Glass (RCFLM)

- Accept rare earth magnets
- Only dry erase markers can be used
- Available with two 5/32" (4 mm) Back-Painted tempered glass laminated on steel sheets

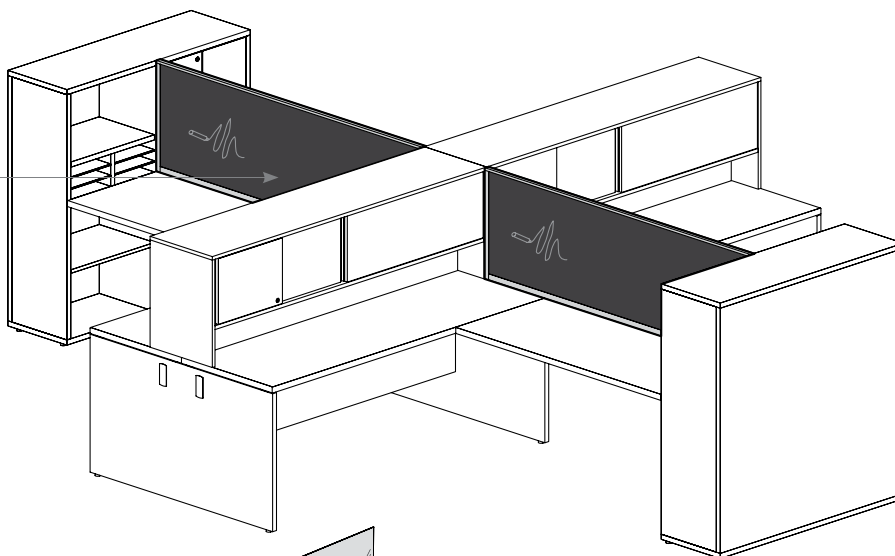

Lateral Framed Screens for Spine Desk – Glass (RCFLG)

- Available with two 5/32" (4 mm) thick Frosted single-sided etched tempered glass facing inward of screen assembly or Back-Painted tempered glass
- Back-Painted can be used as a markerboard. Only dry erasable markers can be used



Lateral Screens for Spine Desk – Glass (RCSLG)

Available in with a 1/4" (6 mm) thick single-sided etched tempered glass



Lateral Screens for Spine Desk – Solid (RCSSLN)

11/16" thick laminate panel



Lateral Framed Screens for Spine Desk – Fabric (RCFLF)

- Two-sided with same fabric
- Tackable on both sides

1" floor screen basics

Expansion Desking provides a variety of casual screens for space division in freestanding applications.

- All screen dimensions listed are nominal
- These screens are an ideal solution for space division in "benching" applications where various numbers of users occupy the workstation

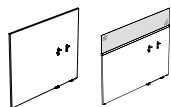

1" Floor Screens – Lateral Connection
Solid or Solid/Glass
(RPSLL, RPSLG)

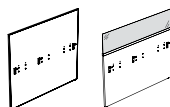

1" Floor Screens – Back Connection
Solid or Solid/Glass
(RPSBL or RPSBG)

1" Floor Screens

- Provide casual space division with various levels of privacy
- 42" or 51" high visual screen that provides privacy from floor level and is mounted to a worksurface on- or off-module
- Do **not** provide any support to the worksurface
- Two finish styles are available: all 1" thick Solid (Laminate) screen or 1" thick Solid (Laminate) base with a 1/4" (6 mm) Tempered Glass on top
- When 1" Floor Screen with Glass (RPSBG or RPSLG) are specified, the glass screens provide 9", 13" or 22" of privacy on its upper section
- Two glass finish styles are available: Clear or Frosted glass
- Frosted (FT) is a single-sided etched tempered glass which is facing inward of workstation
- A Markerboard – Screen Mounted can be specified separately and can be installed on Solid Panel section. See Markerboard – Applications and Stability Restrictions on page 71

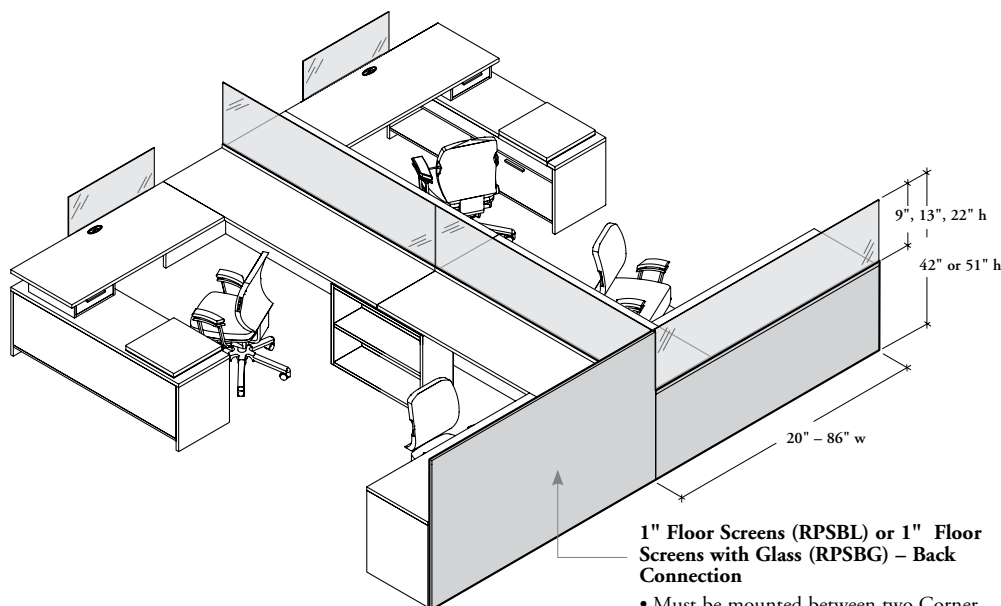

1" Floor Screens (RPSBL) or 1" Floor Screens with Glass (RPSBG) – Back Connection

- Must be mounted between two Corner Posts of the Modular Desks or on the back of a Single-Sided Spine Desks
- Two Mounting Hardware options are available:
 - Modular Desk (M)
 - Spine Desk (S)
- Two Cable Pass-Through position styles are available:
 - Center Pass-Through (C)
 - None (N)
- When Spine Desk Mounting Hardware option (S) is specified, the Center Pass-Through (C) is **not** available

1" Floor Screens (RPSLL) or 1" Floor Screens with Glass (RPSLG) – Lateral Connection

- Must be mounted from a full gable on Modular Desks, Single-Sided or Shared Spine Desks
- Can be specified left, right or in shared configuration
- Two Cable Pass-Through position styles are available:
 - End Pass-Through (E)
 - None (N)

markerboard – screen mounted basics

Expansion Desking offers a wide range of markerboards that can be mounted on 1" Floor Screen or Solid Central/Lateral Screen for Spine Desk.

- ❗ Attached to the solid vertical surface of a 1" Floor Screen or solid horizontal surface of a Central/Lateral Screen for Spine Desk only
- **Cannot** be used on building walls, 2" Freestanding Screens or Worksurface Edge Screens
- Match 42" or 51" high datum line



Glass only
(RACMSG)



Magnetic Glass
(RACMSM)

Glass Markerboard – Screen Mounted (RACMS)

- Are available in two glass markerboard styles:

Glass only (G):

Provides erasable message board

Magnetic Glass (M):

Provides erasable message board and accepts rear earth magnets

- Only dry erase markers can be used
- Are available in 5/32" (4 mm) Back-Painted tempered glass

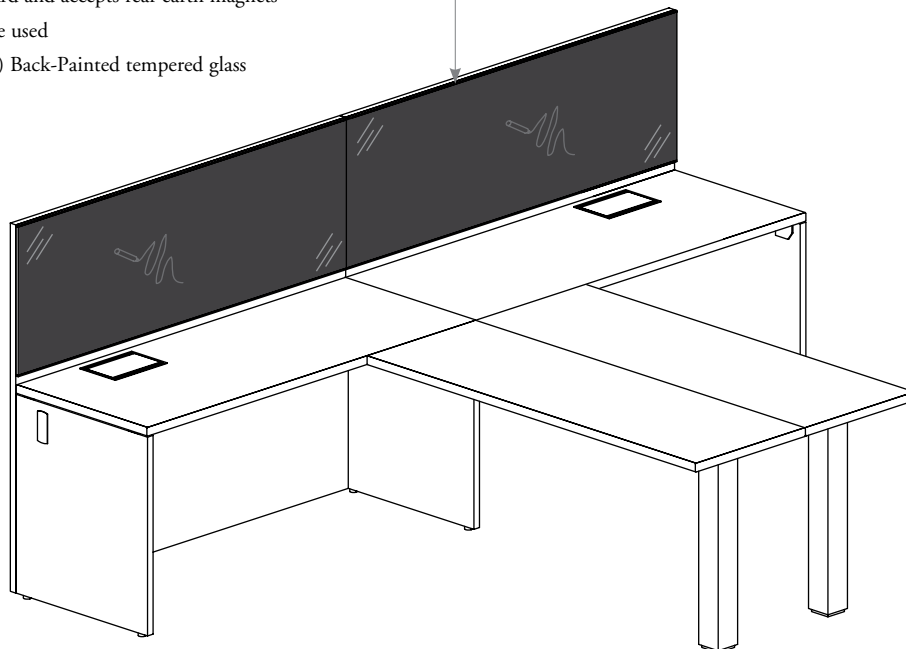

Marker Holder for Markerboard (RACMT)

- Provides storage for dry-erase markers and eraser and can be installed on a Central/ Lateral Screen for Spine Desk or Markerboard with the use of Velcro® bands
- Dry erase markers and eraser are **not** included
- Marker Holder is available in Foundation, Accent or Mica colors

markerboard – screen mounted basics (continued)

markerboard – applications

- Can be mounted onto a single 1" Floor Screen or Central/Lateral Screen for Spine Desk
- All Markerboards are 1/8" smaller than the screen on which it is mounted

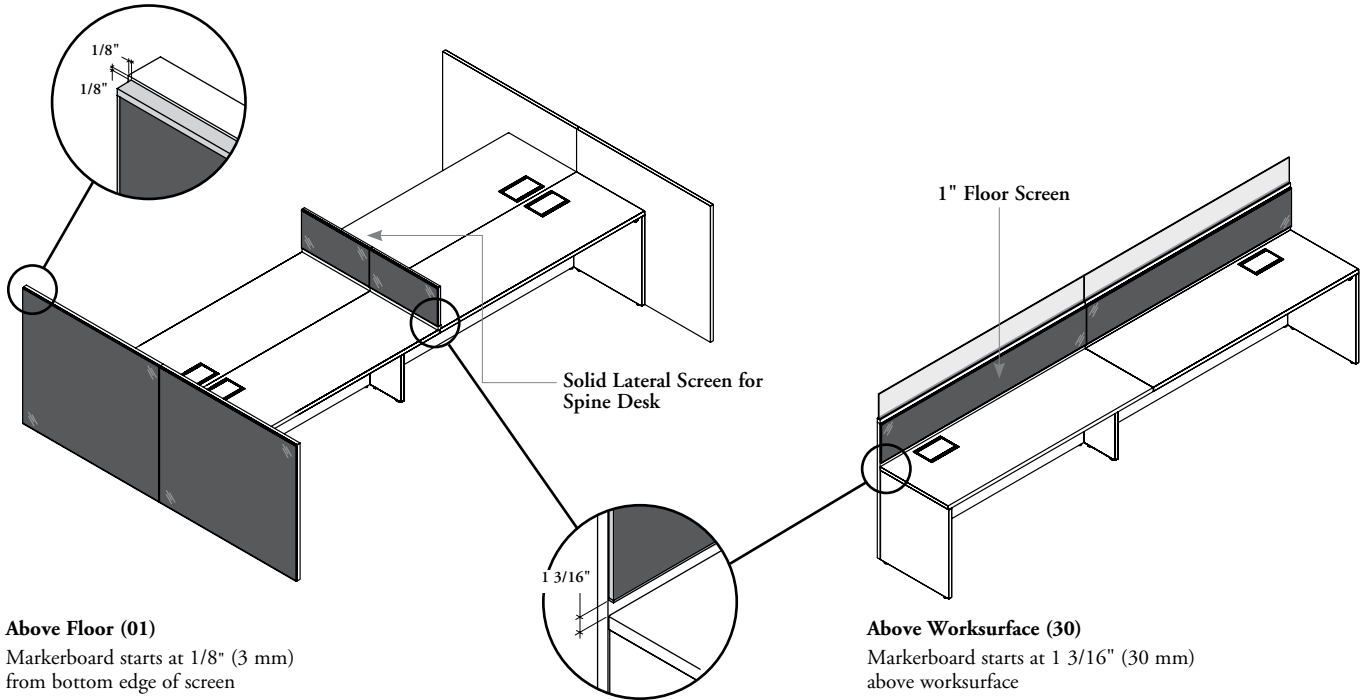

markerboard – stability restrictions

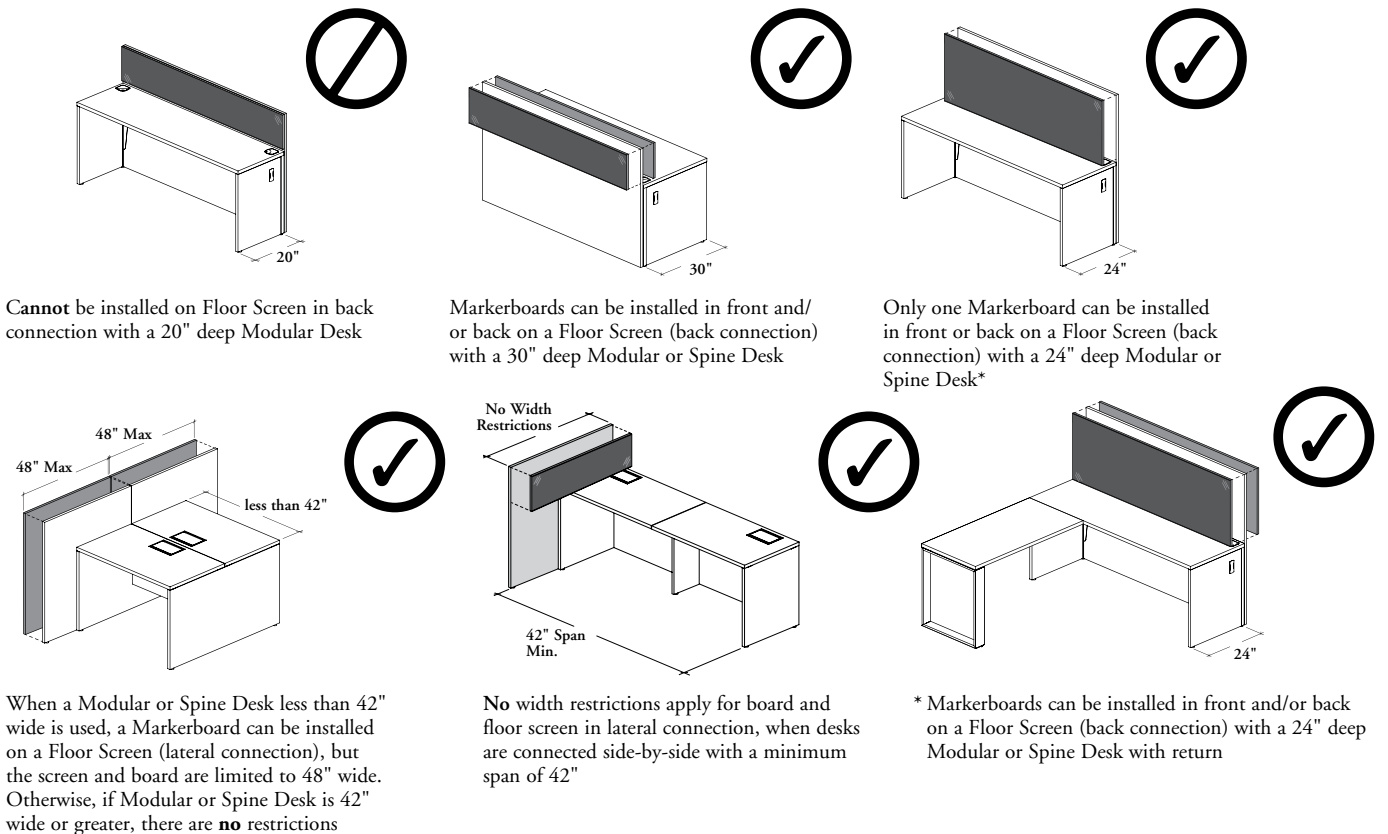

planning with add-on screens for modular desk

Information on this page should be considered when planning with Add-On Screens for Modular Desk.

- ❗ Can only be used in back-to-back or side-by-side configuration and provides privacy at 42" or 51" high
- Can be used between users anywhere along the width or depth of two connected desks
- Screen support is 1" thick
- Can be mounted between users on- or off-module on the connection between two modular desks

desk-mounted applications

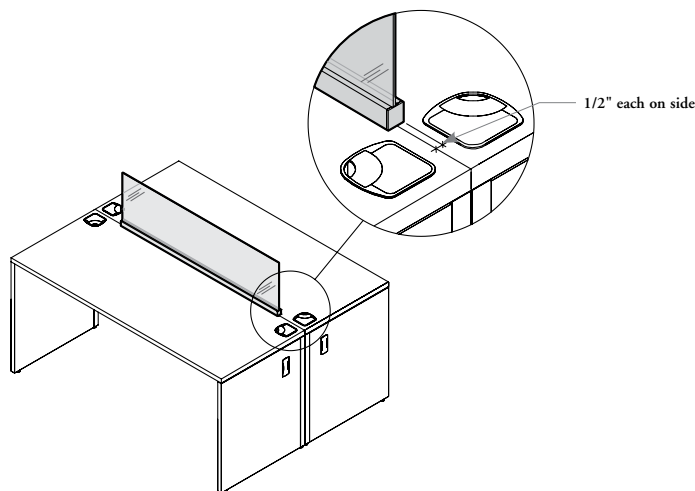

Back-to-Back Configuration
and Off-Module

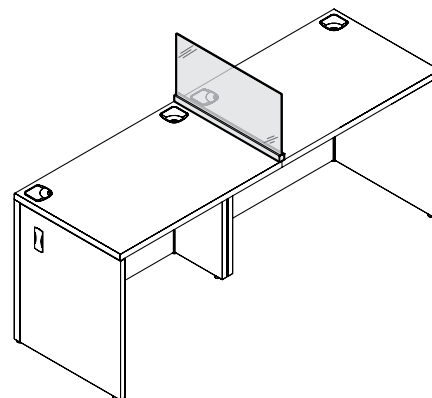

Side-by-Side Configuration
and On-Module

planning with add-on screens for modular desk (continued)

add-on screen dimensions

In workstations with multiple screens, **not** all of them will be flush

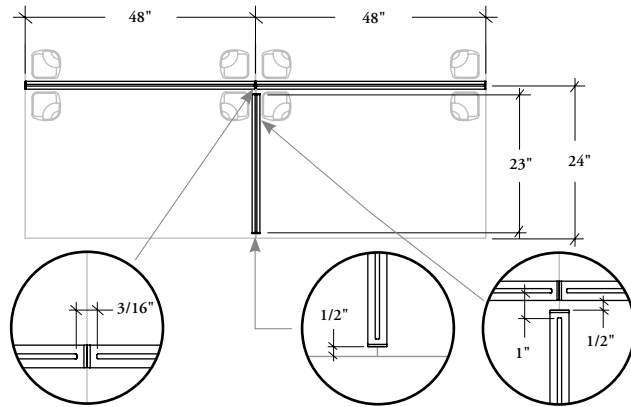
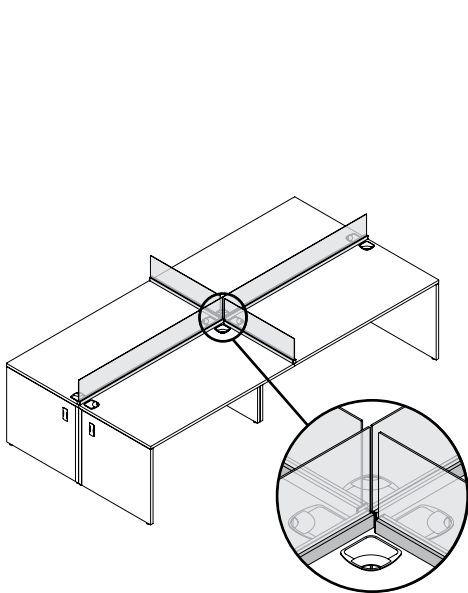

Full Size – Back
(screen matches width of
worksurface)

Recessed Size – Lateral
(screen should be specified
1" smaller)

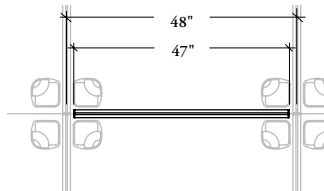

Recessed Size – Back
(screen should be specified
1" smaller)

height matches 42" or 51" datum line

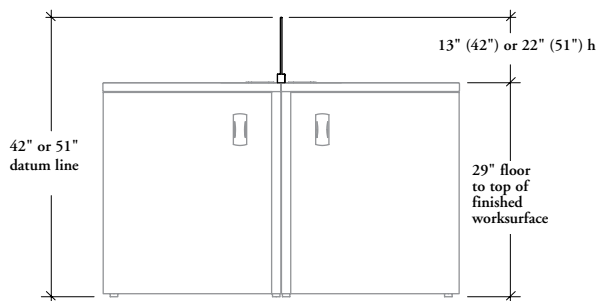

Desk-Mounted Application

planning with worksurface edge screens

Information on this page should be considered when planning with Worksurface Edge Screens.

⚠ Edge Screens can only be attached to Rectangular Worksurfaces (RTLDDL, RTLDC and RDRP)

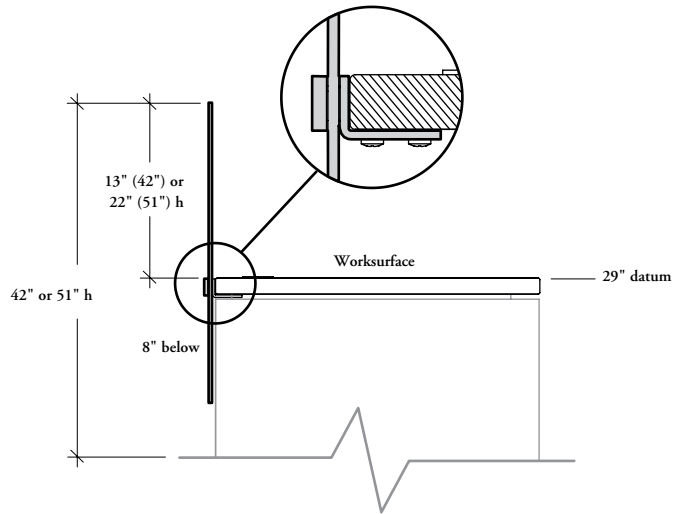

Worksurface Edge Screen – Glass (RPSWG)

- Provide visual privacy above and additional modesty privacy below
- The Worksurface Edge Screen (RPSWG or RPSWL) can only be mounted on the back side of a suspended worksurface and extends 8" below the worksurface
- Can be placed on worksurface with straight edge only
- Height matches 42" or 51" datum line
- **Cannot** be mounted to the back side of a Freestanding Modular Desk or Spine Desk
- **Cannot** be mounted on a Rectangular Worksurface of less than 24" deep when it is used as a freestanding desk or table

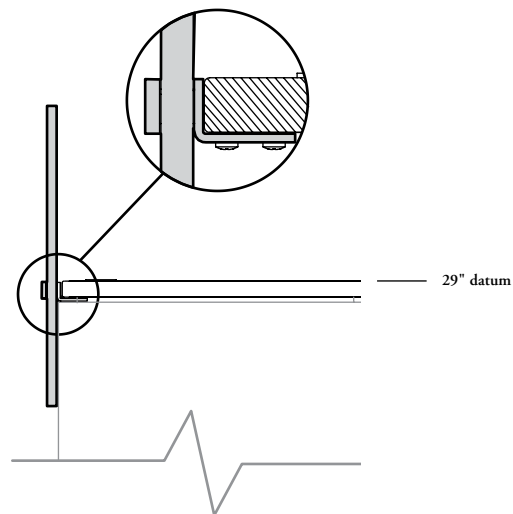
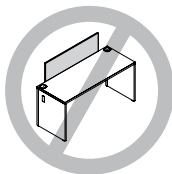

Worksurface Edge Screen – Solid (RPSWL)

planning with worksurface edge screens (continued)

worksurface edge screen widths

- Screens can be specified with different widths depending on the intended result

Full width for total privacy

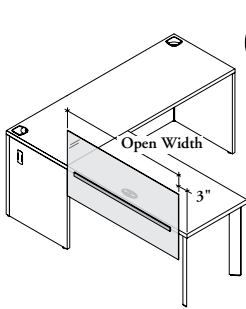

Legs or Semi-Supported Legs
(Maximum width = open width minus 3")

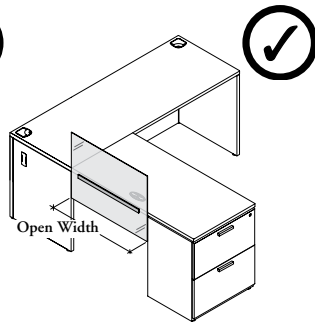

All other supports
(Maximum width = open width)

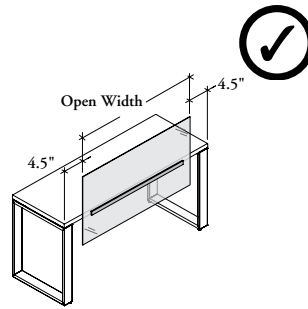

Frame Legs only
(Maximum width = open width minus 4.5" a each side)

Casual width for partial privacy

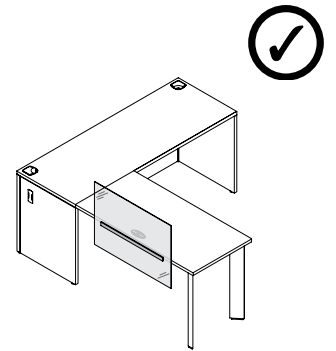

- Must be installed within open width available
- Cannot overlap legs, gables, storage or credenzas

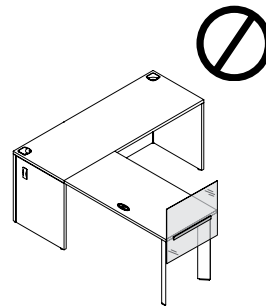
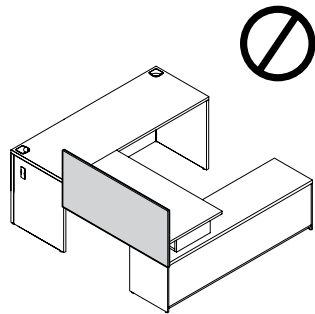
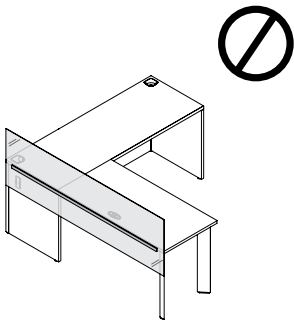

All supports or storage

All support styles or storage will interfere with mounting brackets

planning with central screens for spine desk

Information on this page should be considered when planning with Central Screens and Central Framed Screens for Spine Desk.

- ❗ Can only be used between two worksurfaces of Spine Desks or two Rectangular Worksurfaces (RLTDL, RTLDC) and provides privacy at 42" or 51" high
- Respecting mounting option is mandatory for product compatibility
- Screen support is 1" (25,4 mm) thick and 1 3/16" (30,2 mm) high
- Can be mounted between users on- or off-module. Off-modularity only works within the same mounting option group
- Other restrictions apply when specifying with Spine Desks. See the applications on page [47](#)

desk-mounted applications

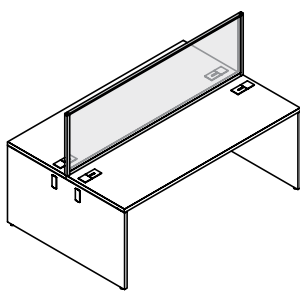

On-Module

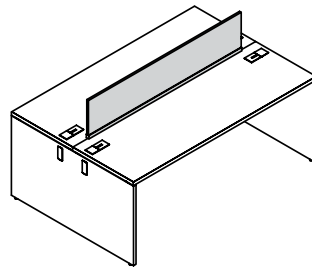

Off-Module

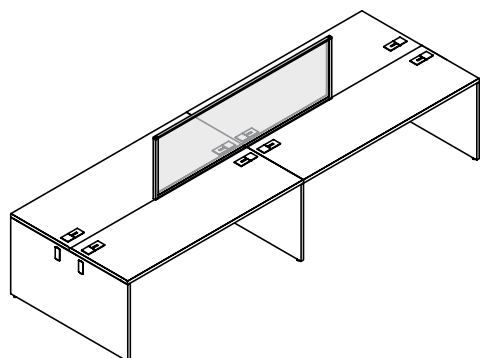

On- or Off-Module

planning with central screens for spine desk (continued)

worksurface-mounted applications

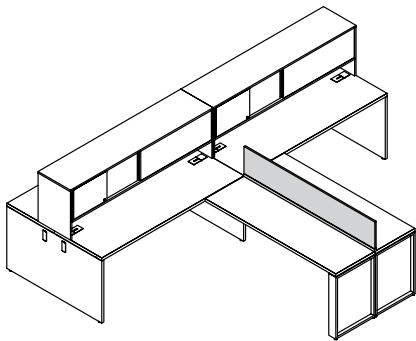

On-Module on worksurface only

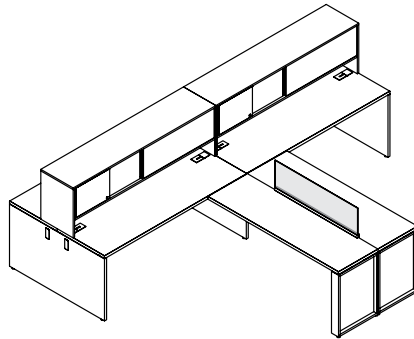

Off-Module on worksurface only

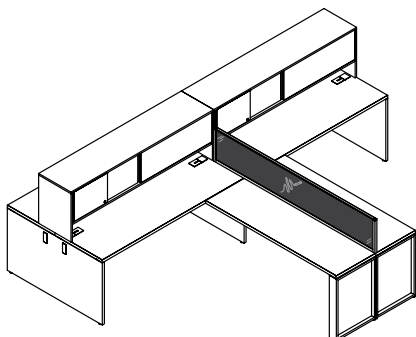

**On- or Off-Module on worksurfaces and Spine Desks
(Refer to Lateral Screens for this application)**

planning with lateral screens for spine desk

Information on this page should be considered when planning with Lateral Screens and Lateral Framed Screens for Spine Desk.

- ❗ Mounting option dictates the mandatory Lateral Screen starting position on Spine Desk. The other end can be on- or off-module on same Spine Desks or on the Rectangular Worksurfaces connected to those Spine Desks
- Respecting mounting option is mandatory for product compatibility
- Can be used between users anywhere along the depth of two worksurfaces. Starting position along the depth must be respected
- Screen support is 1" (25,4 mm) thick and 1 3/16" (30,2 mm) high
- Can be mounted between users on- or off-module. Off-modularity only works within the same mounting option group
- Other restrictions apply when specifying with Spine Desks. See the applications on page [47](#)

from rear edge applications

- A Lateral Screen **cannot** be installed between two Central Screens
- A Lateral Screen **cannot** be installed from rear edge of two Rectangular Worksurfaces

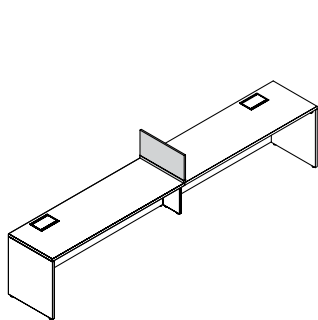

On-Module on Spine Desks only

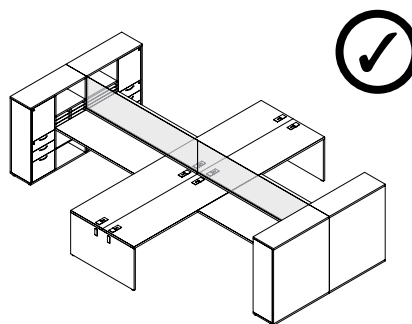

On-Module on Spine Desks and worksurfaces

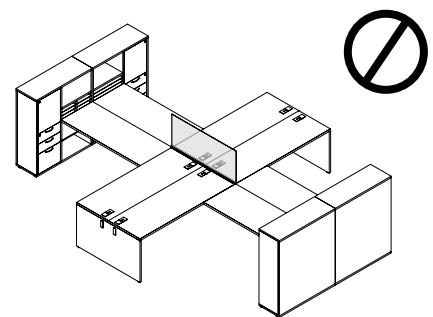

On-Module not starting from rear edge

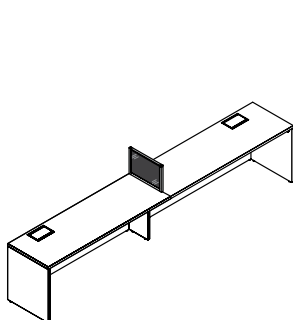

Off-Module on Spine Desks only

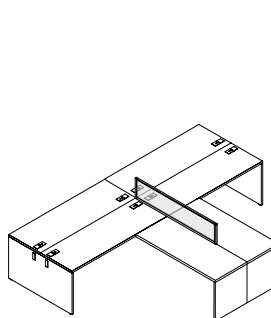

Off-Module on Spine Desks and worksurfaces

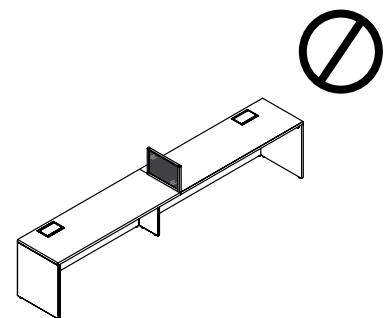

Off-Module not starting from rear edge

planning with lateral screens for spine desk (continued)

from two central screen applications

- For screen width calculation, central screens count for 1" from the nominal sizes of products on which they are installed
- Can be specified flush or lower than the Central Screens. To opposite is **not** applicable
- The Lateral Screen must align with the junction of two Central Screens
- Framed Lateral Screens are **not** compatible with Glass Central (unframed) Screens

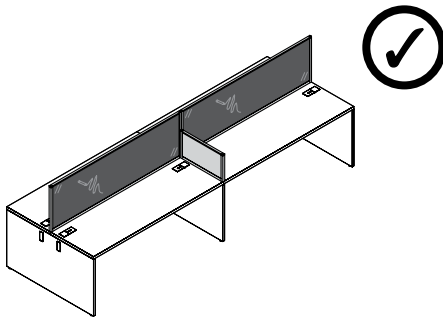

On-Module on Spine Desks only

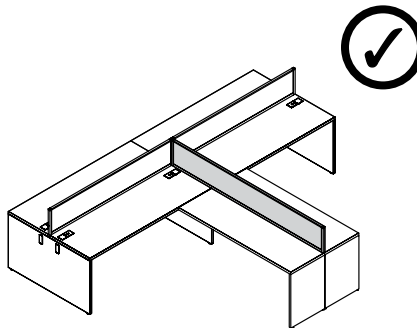

On-Module on Spine Desks and worksurfaces

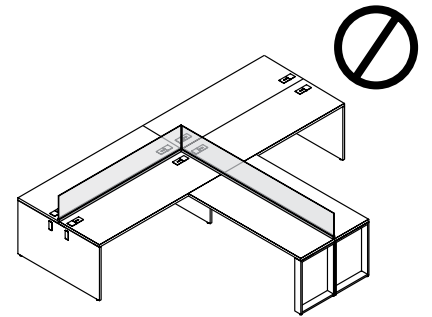

On-Module not starting from two Central Screens

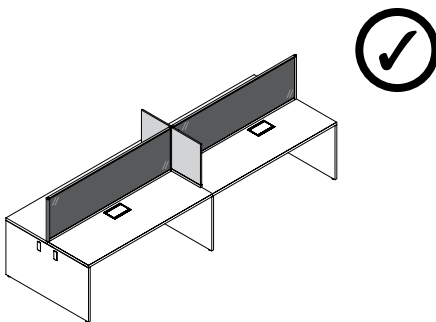

Off-Module on Spine Desks only

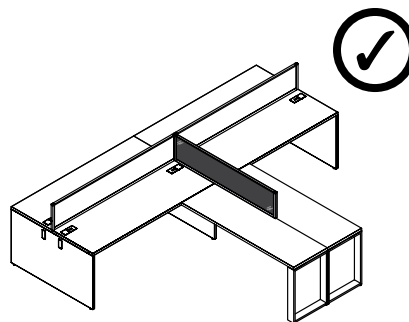

Off-Module on Spine Desks and worksurfaces

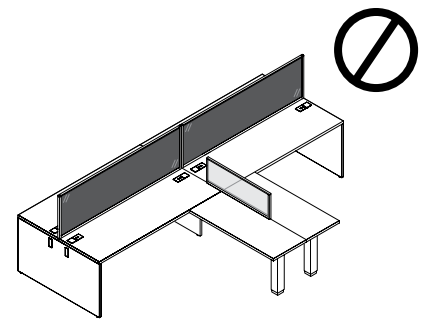

Off-Module not starting from two Central Screens (Applicable with Framed Screens only)

planning with lateral screens for spine desk (continued)

from two mounted storage applications

- For screen width calculation, mounted storage in single-sided position counts for 16" and mounted storage in shared position counts for 8" from the nominal sizes of products on which they are installed
- Compatible with Elevated Desktop Cabinets only
- Can be specified flush or lower than mounted storage. The opposite is **not** applicable
- Lateral Screens from two mounted storage will reduce the opening angle of hinged doors

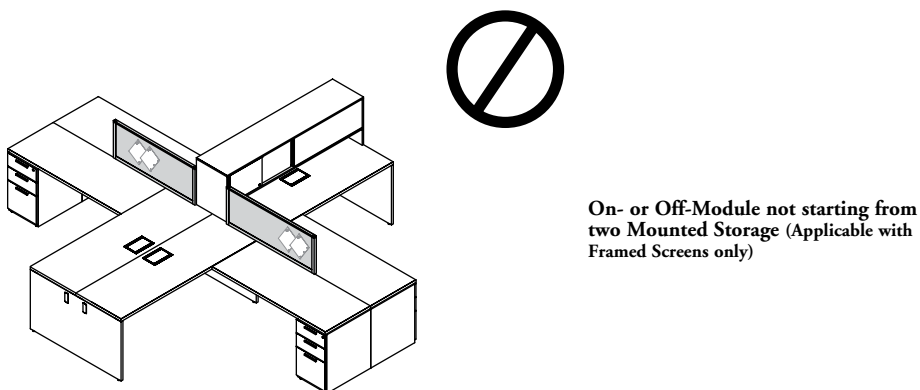
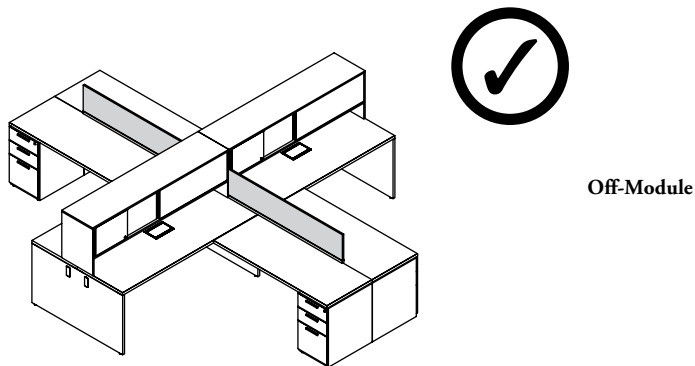
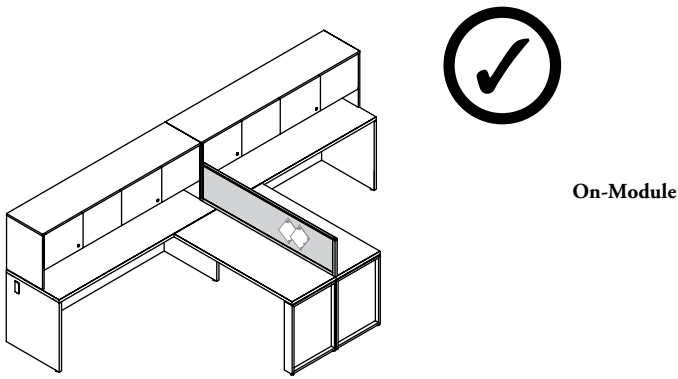

central & lateral screens compatibility

Information on this page should be considered when planning with Central/Lateral Screens and Central/Lateral Framed Screens for Spine Desk.

- ❗ Central and Lateral Screens are compatible with most products that can complete a Spine Desk workstation but some restrictions apply

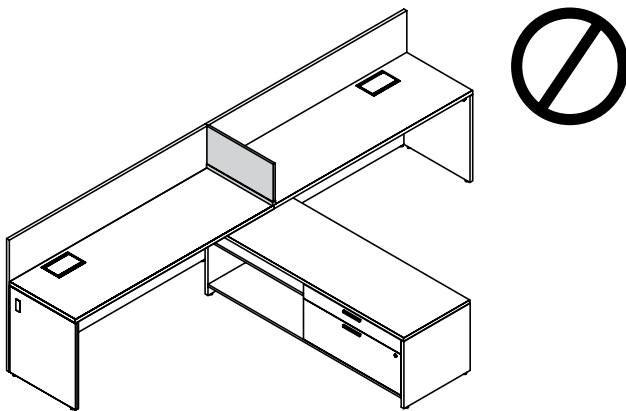

With Low Credenza and Worksurface Support

Cannot be installed on top of a Worksurface Support, because there will be an interference with mounting hardware

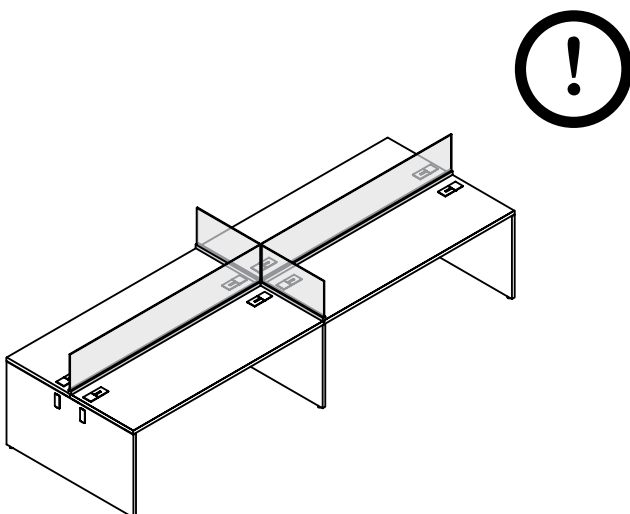

Glass Central and Lateral Unframed Screens

Glass Central Screen (unframed) is compatible with Glass Lateral Screen (unframed) only

central & lateral screens compatibility (continued)

❗ Screen dimensions are calculated as per mounting option in order to minimize gaps between frames

central and lateral screen dimensions

Solid and Glass Screens (unframed)

Solid or glass elements are **not** full width of mounting frames which leaves gaps at their junction

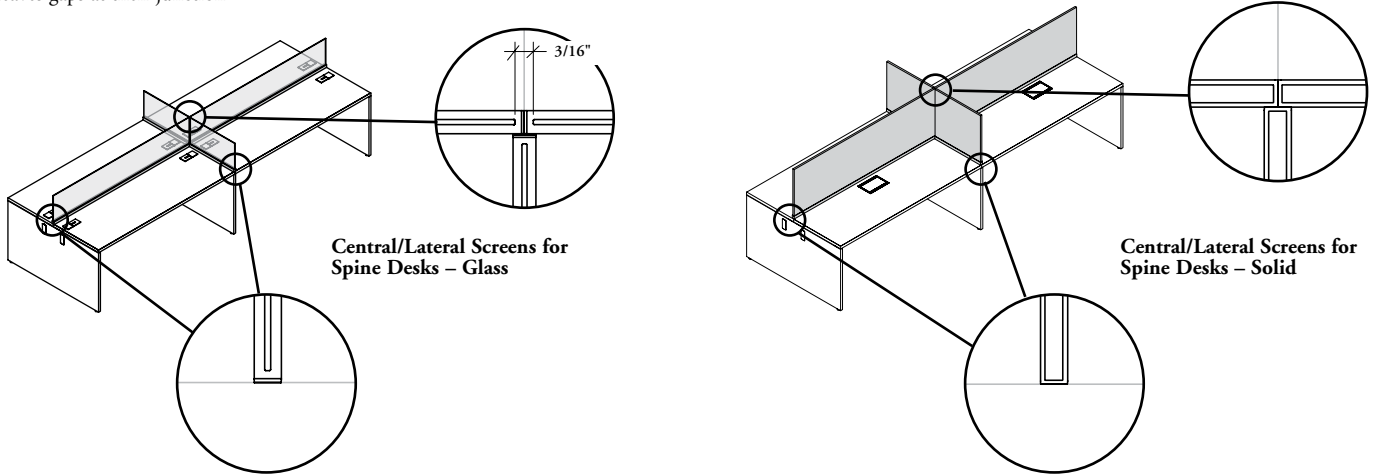

Framed Screens

- Connecting hardware is provided with Framed Screens only
- 3- and 4-way junctions are done by connecting the Central Screens together and then connecting the Lateral Screens in the 1/16" remaining gap

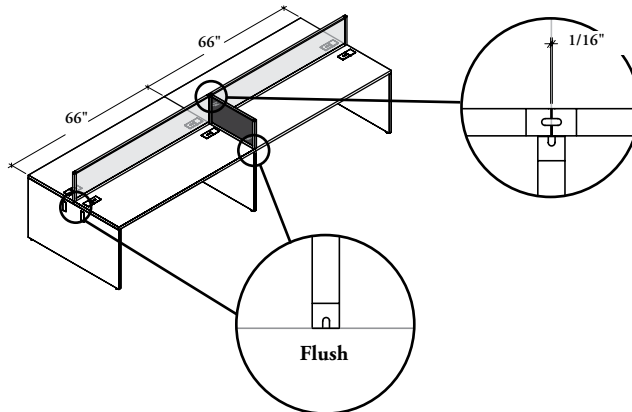

height matches 42" or 51" datum line

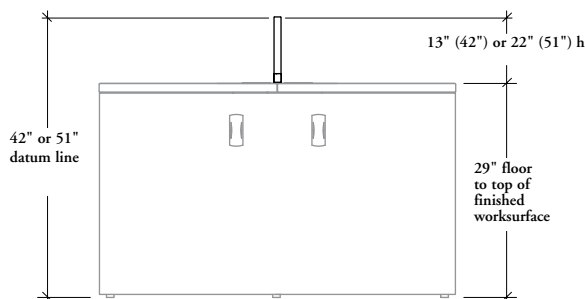

Desk- or Worksurface-Mounted Application

planning with 1" floor screens

Information on this page should be considered when planning with 1" Floor Screens.

❗ **Cannot** be used with Rectangular Worksurfaces (RTLDL or RTLDC) used above

- The 1" Floor Screen can be used in:
 - back connection (RPSBG or RPSBL)
 - lateral connection (RPSLG or RPSLL) and provides privacy at 42" or 51" high
- According to the connection selected, they can be mounted on- or off-module on a Modular Desks or Spine Desks
- Other restrictions should be applied when specifying with Spine Desks. See the applications on page 47

Lateral Connection Application

- The Lateral Connection Kit is provided when 1" Floor Screen – Lateral Connection (RPSLG or RPSLL) is specified
- Can be placed on- or off-module and must be fixed to a full gable of the Modular or Spine Desks
- **Cannot** be fixed to a half-gable, a Metal C-Leg, a Semi-Supported Leg (RAVG), or Frame Legs (RWWO or RWWF)
- Can overlap legs, full gables, storage or credenzas

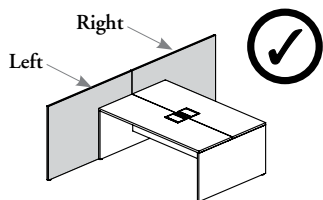
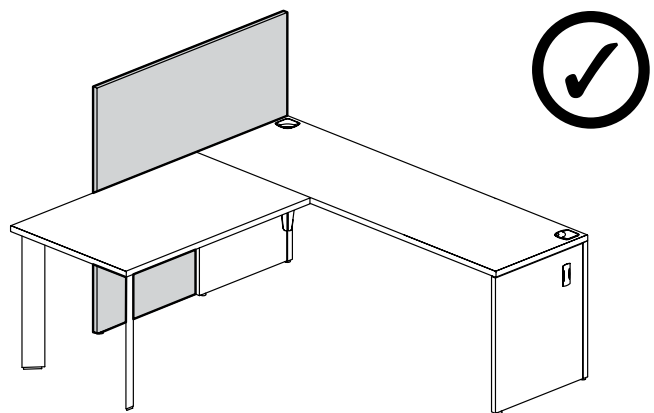
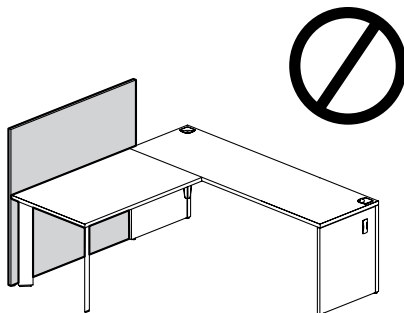

- The 1" Floor Screens can exceed the Single-Sided or Shared Spine Desk, but a left and a right 1" Floor Screen must be specified for each side of the Spine Desk

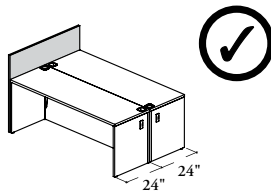

- A shared 1" Lateral Floor Screen can also be specified on- or off-module on two full gables of two Modular Desks or Single-Sided Spine Desks (in back-to-back configuration) only if they have the same depth

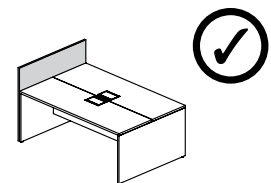

- With Shared Spine Desks, a shared 1" Lateral Floor Screen can be specified on- or off-module when centered on the full gable

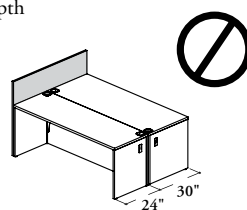
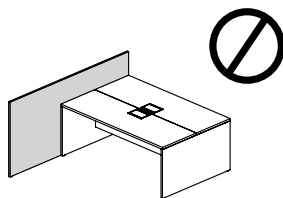

- If two desks (back-to-back) do **not** have the same depth, the cable pass-through on the 1" Floor Screen are **not** aligned with those on the gables

planning with 1" floor screens (continued)

Back Connection Application

- The Back Connection Kit is provided when 1" Floor Screen – Back Connection (RPSBG or RPSBL) is specified
- Can only be placed on-module and must be fixed to two metal corner posts of the Modular Desks and two gables of the Single-Sided Spine Desks

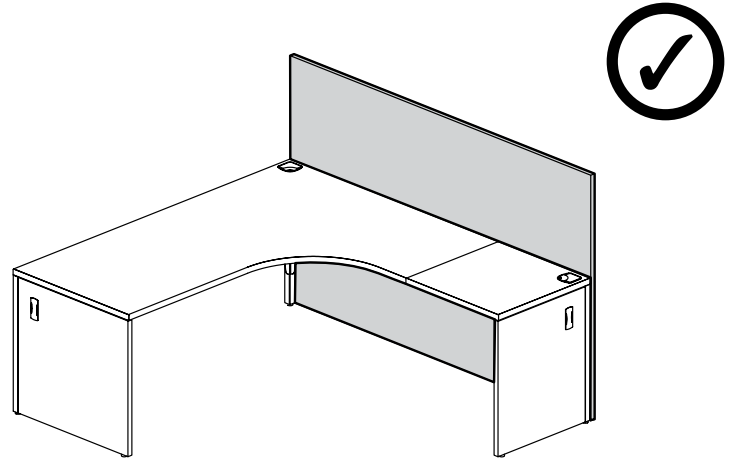
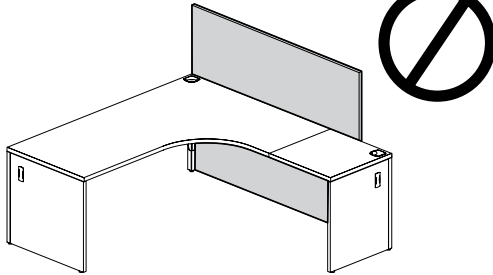

- **Cannot** be used in combination with a Modesty Panel (RDML or RDMO) or Single-Sided Spine Desk with full-height modesty panel

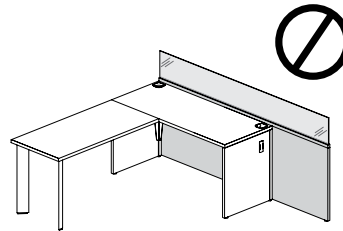

- The 1" Floor Screen **cannot** exceed the workstation width in back position, but it can exceed the workstation depth in lateral position

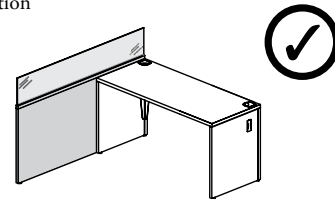

planning with 1" floor screens (continued)

- When Back Connection is specified, widths are available from 24" to 84" in 6" increments for flush application, 25" to 85" in 6" increments for extended one side and 26" to 86" in 6" increments for extended both sides
- When Lateral Connection is specified, depths are available from 20" to 84" in 6" increments for flush application, 21" to 85" in 6" increments for back extended

1" floor screen widths

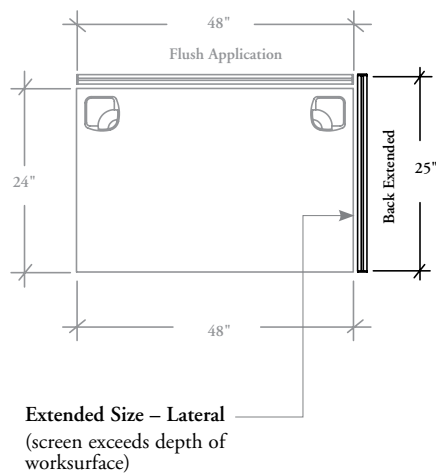
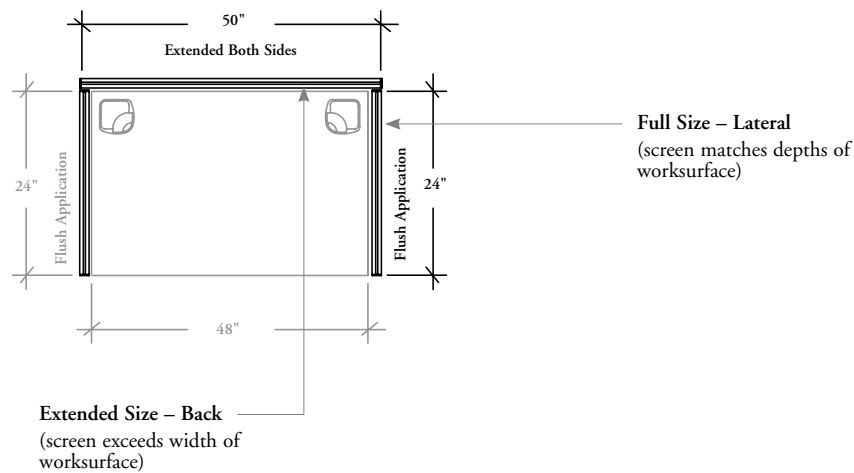

planning with 1" floor screens (continued)

screen junction

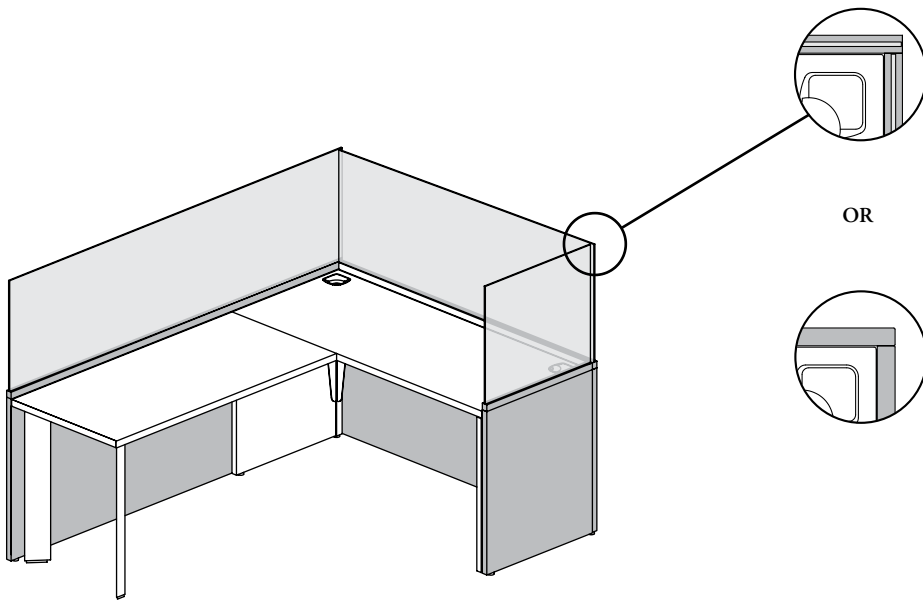

With 1" Floor Screen with Glass

- When two 1" Floor Screens with Glass are connected, the glass on top will **not** be aligned

OR

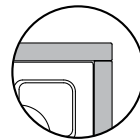

With 1" Floor Screen

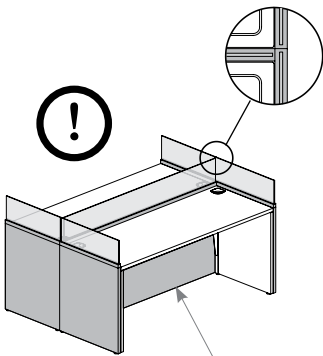

With 1" Floor Screen

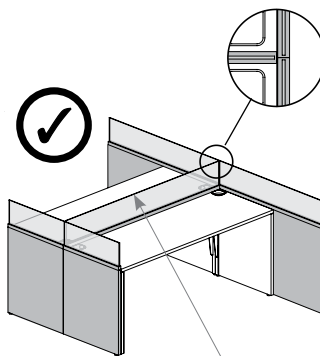

With Add-On Screen or Central Screen

- In shared application, you can replace 1" Floor Screens between two desks; use an Add-On Screen or Central Screen for flush aesthetic

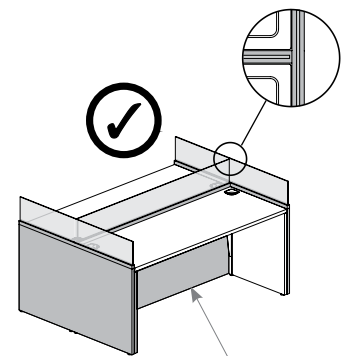

With 1" Floor Screen (Shown) or Add-On Screen/Central Screen

- For a seamless look on the 1" Floor Screen, use a shared configuration

2" freestanding screen basics

2" Freestanding Screens may be used individually or connected to other 2" Freestanding Screens to divide workspaces.

⚠ Elements have identical finish on both sides

2" Freestanding Screens

- May be used connected to walls, desks or other freestanding screens
- Connection hardware from freestanding screen to freestanding screen are included
- Five Connection Kits are available and can be specified separately:
 - Desk Connection Kit (RYCD)
 - Back Connection Kit (RYC_)
 - Lateral Connection Kit (RYCL)
 - Height-Change Connection Kit (RYCH)
 - Wall Connection Kit (RYCW)
- Three Cable Pass-Through position styles are available:
 - Center Pass-Through (C)
 - End Pass-Through (E)
 - None (N)

2" Freestanding Screens

- Fabric (two-sided and tackable)
 - All elements must be specified with the same fabric grade
 - When Fabric Base Element is specified, the Cable Pass-Through is **not** available
- Glass (Clear or Frosted)
- Source Laminate colors

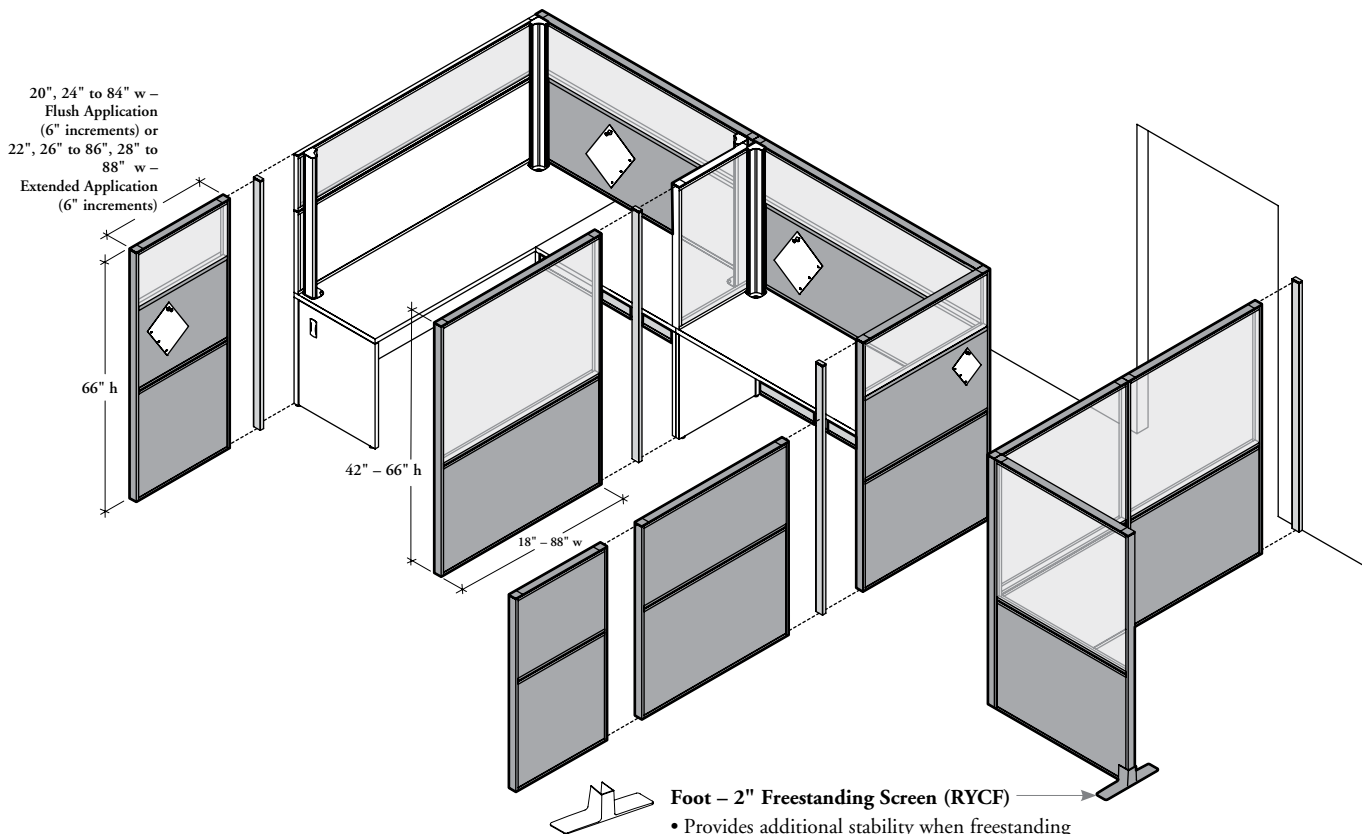
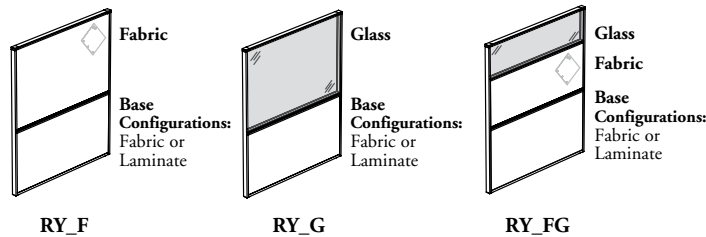

- Foot - 2" Freestanding Screen (RYCF)**
- Provides additional stability when freestanding screens are used in a straight run
 - Fits all screen sizes and are installed at the end of a freestanding screen run

2" freestanding screen basics (continued)

- All connection kits are used to stabilize either elements or freestanding screens
- All kits are available from 42" to 66" high, except for Back and Lateral Connection Kits



Desk Connection Kit – 2" Freestanding Screen (RYCD)

- Connects a freestanding screen to a desk with a column-mounted element
- Compatible with Unframed, 1" or 2" Framed Elements
- Can be mounted to the end of an element and a corner post (corner post connection) or on the end of an element and the front of a full gable (lateral connection)

- Cannot allow height change if it is used in corner post connection. No height change is allowed for lateral screen connection

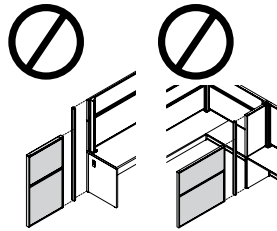

Connection Examples:

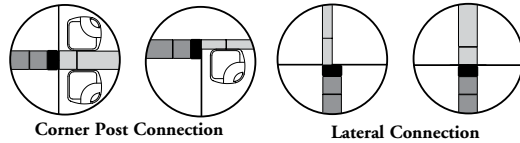

Back Connection Kits – 2" Freestanding Screen (RYC_U)

- Connect a freestanding screen on the back of a Modular Desk (RYCM) or a Spine Desk – Single-Sided (RYCS)
- The dimension of the freestanding screen should be specified equal or wider than the desk

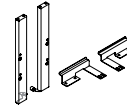

Modular Desk (M)



Spine Desk (S)

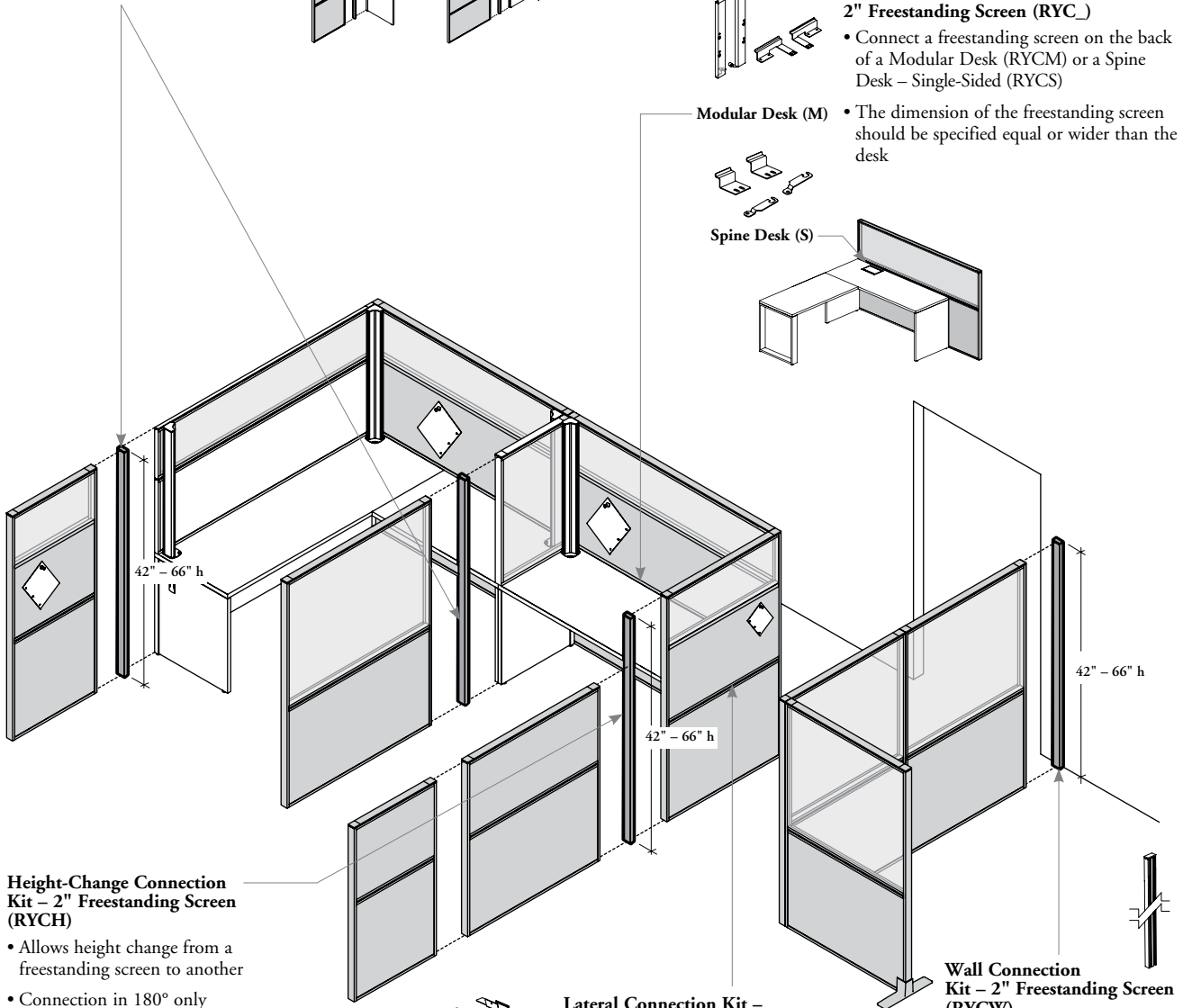
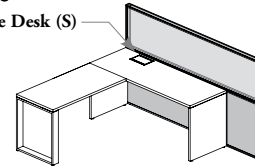

Height-Change Connection Kit – 2" Freestanding Screen (RYCH)

- Allows height change from a freestanding screen to another
- Connection in 180° only



Lateral Connection Kit – 2" Freestanding Screen (RYCL)

Connects a freestanding screen on the side of a desk



Wall Connection Kit – 2" Freestanding Screen (RYCW)

Connects a freestanding screen to a wall



freestanding screen connections

90° connection

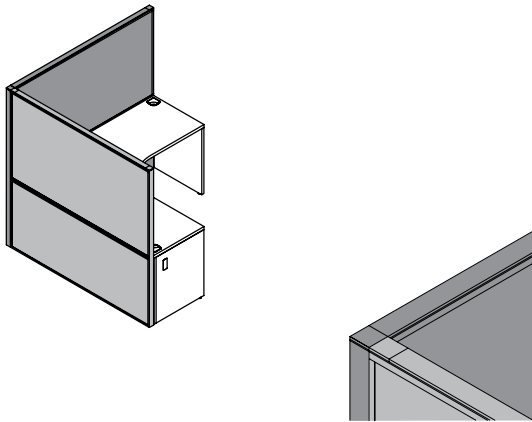

180° connection

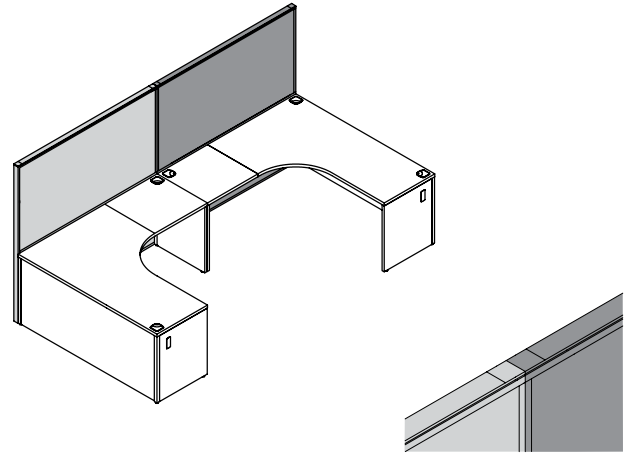

270° connection

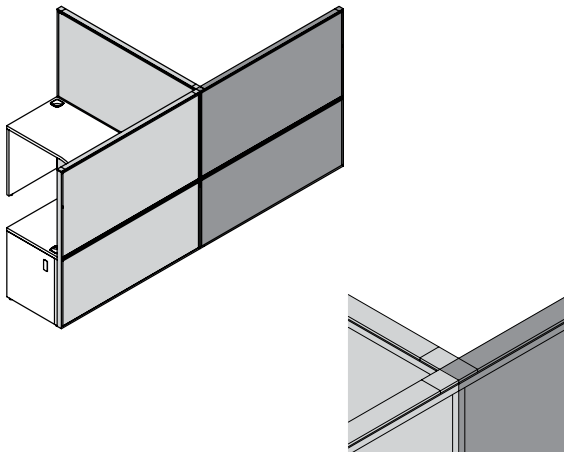

360° connection

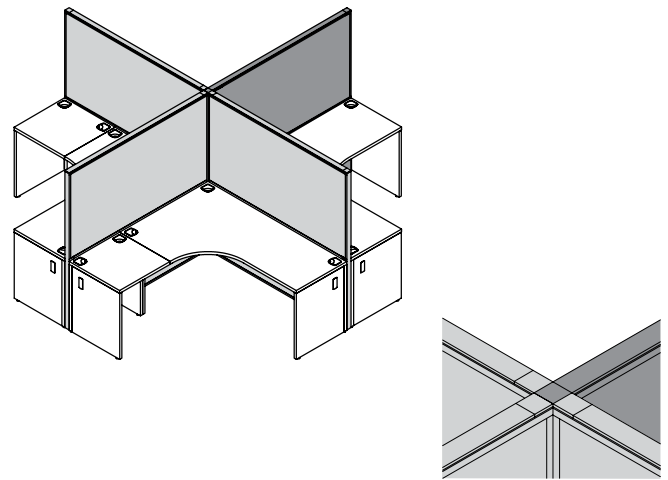

freestanding screen restrictions

with 2" freestanding screens (in 90° Connection)

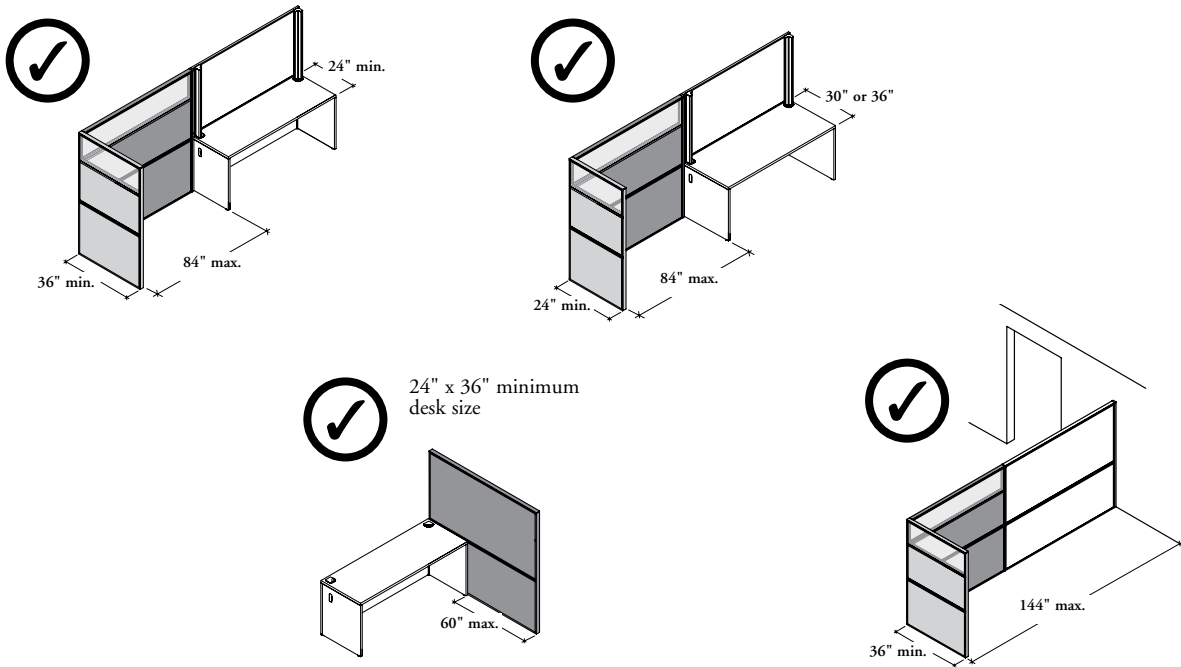

with a foot

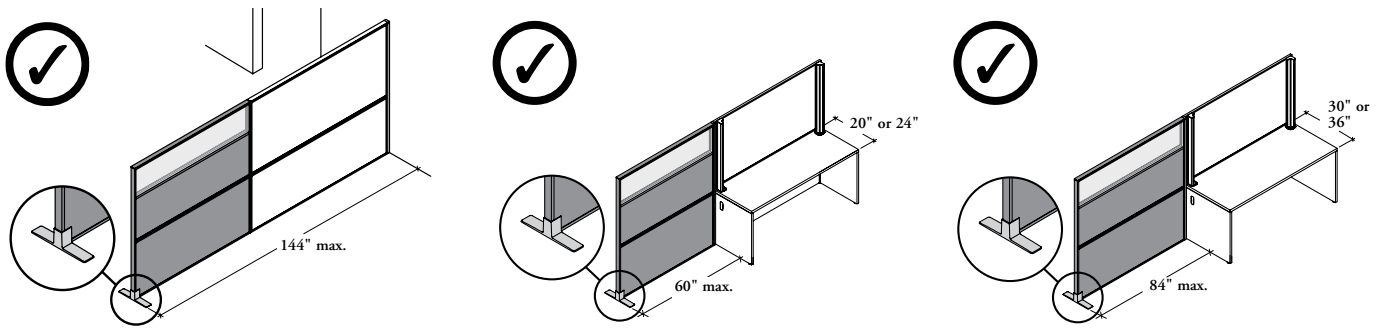

with 2" freestanding screens (in Back Connection)

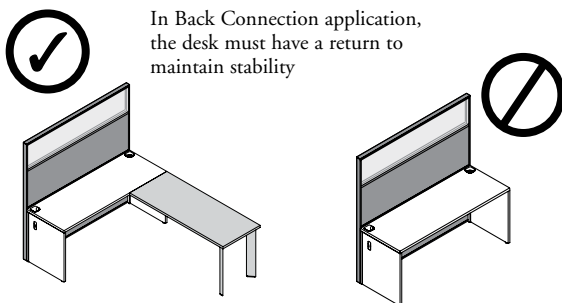

spine desks with a 2" freestanding screen (in Back and Lateral Connection)

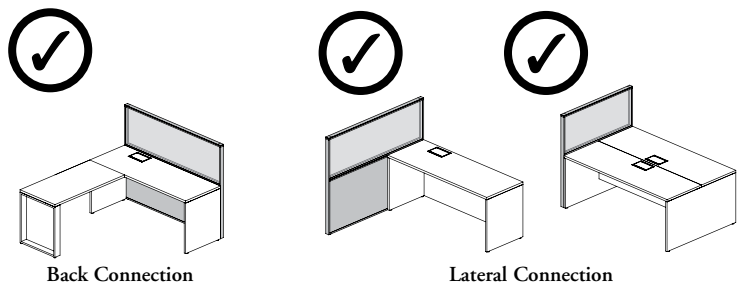

planning with cable pass-through

Information on this page should be considered when planning with Cable Pass-Through vs 1" Floor or 2" Freestanding Screens.

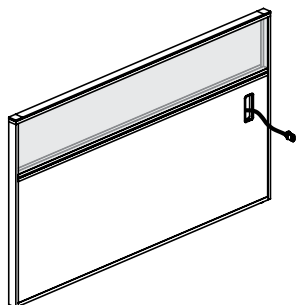

Cable Pass-Through

- Screens can be specified with factory-made cable pass-through cut outs on the 1" Floor Screens and 2" Freestanding Screens
- Provide openings for electrical wiring and communication cables
- Are available in a vertical position only
- Metal Cable Pass-Through Covers (RAWPC) can be specified separately
- Three Cable Pass-Through position styles are available:
 - Center Pass-Through (C)
 - End Pass-Through (E)
 - None (N)

The Cable Pass-Through position styles/screen type combinations are **not** all available; see individual product pages for details

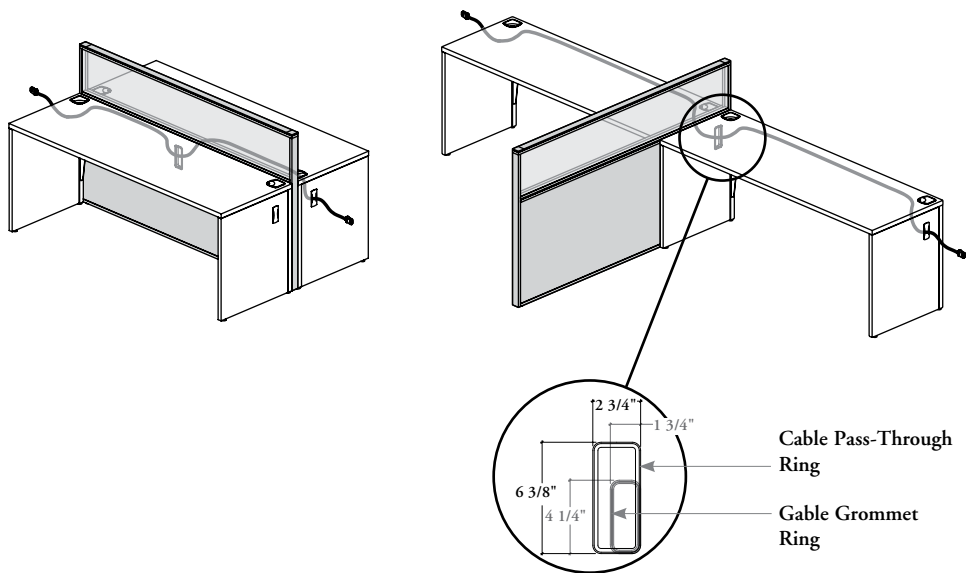

planning with cable pass-through (continued)

1" floor screens

In Back Connection (with Center Pass-Through)

Center Cable Pass-Through position is always centered on the panel, it can be specified Flush, Extended One Side or Extended Both Sides. Not available when Spine Desk Mounting Hardware (S) is specified

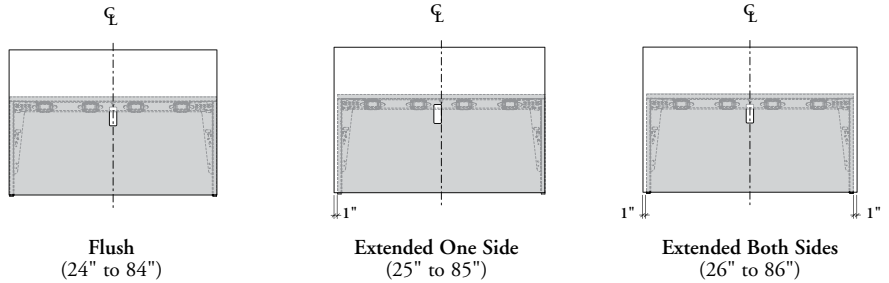

In Lateral Connection (with Shared Cable Pass-Through)

Shared Cable Pass-Through will align with gable grommets of a Shared Spine Desk or two contiguous Modular or Single Spine Desks of the same depth

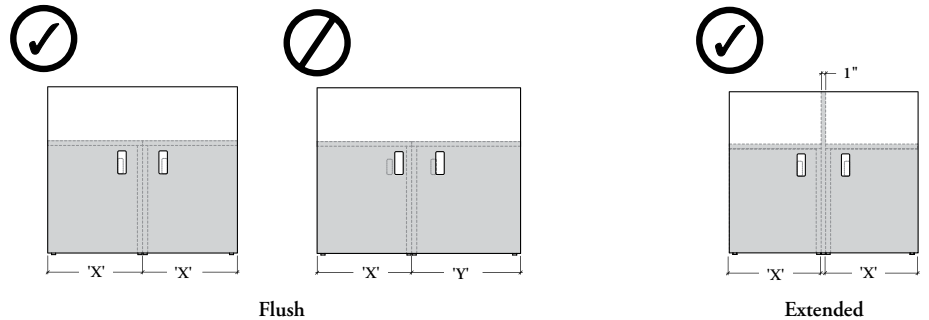

In Lateral Connection (with End Cable Pass-Through)

Standard position on Flush Application (20", 24" to 84") widths option will align with gable grommet

Left or Right Configuration

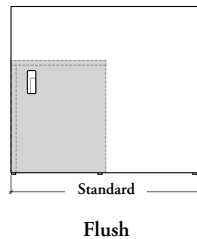

Standard position is shifted 1" forward on Back Extended (21", 25" to 85") widths option to align with gable grommet

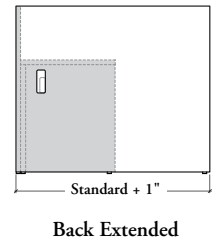

planning with cable pass-through (continued)

2" freestanding screens

End Pass-Through style (Lateral Application)

The End Pass-Through is designed for lateral application only

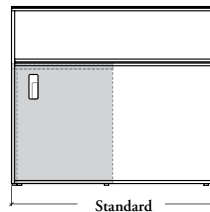
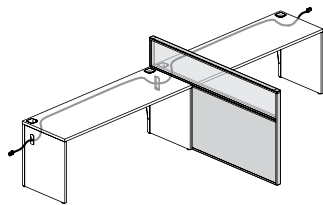

Flush

Standard position on Flush Application (20", 24" to 84") widths option

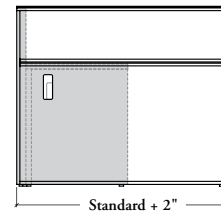

Back Extended

- Standard position is shifted 2" forward on Back Extended (22", 26" to 86") widths option
- 2" Freestanding Screen is non-handed

Center Pass-Through style (Back-to-Back or Lateral Shared Applications)

The Center Pass-Through is designed for back-to-back applications

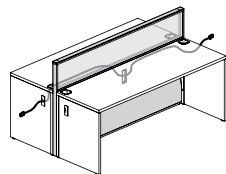

Back-to-Back

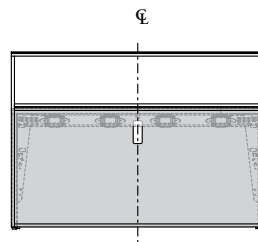

Flush

Center position standard on Flush Application (20", 24" to 84") widths option

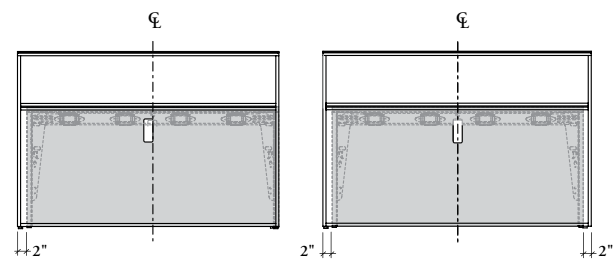

Extended

Center position is standard on Extended Application (22", 26" to 86") or (28" to 88") widths option

The Center Pass-Through is doubled for on-module lateral applications on a Shared Spine Desk or two back-to-back desks

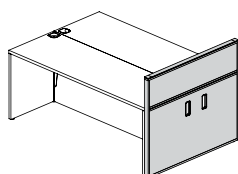

Lateral Shared

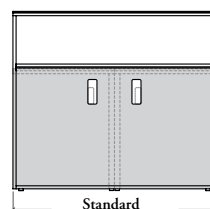

Flush

Center position is standard and doubled on Flush Application (40", 48", 60", 72") widths

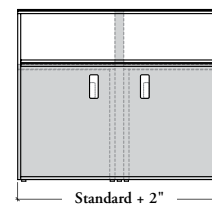

Extended

Center position is doubled and shifted 2" apart on Extended Application (42", 50", 62", 74") widths

column & screen finishes

Screens are available in a wide variety of fabric. Codes must be included in the order.

unframed elements

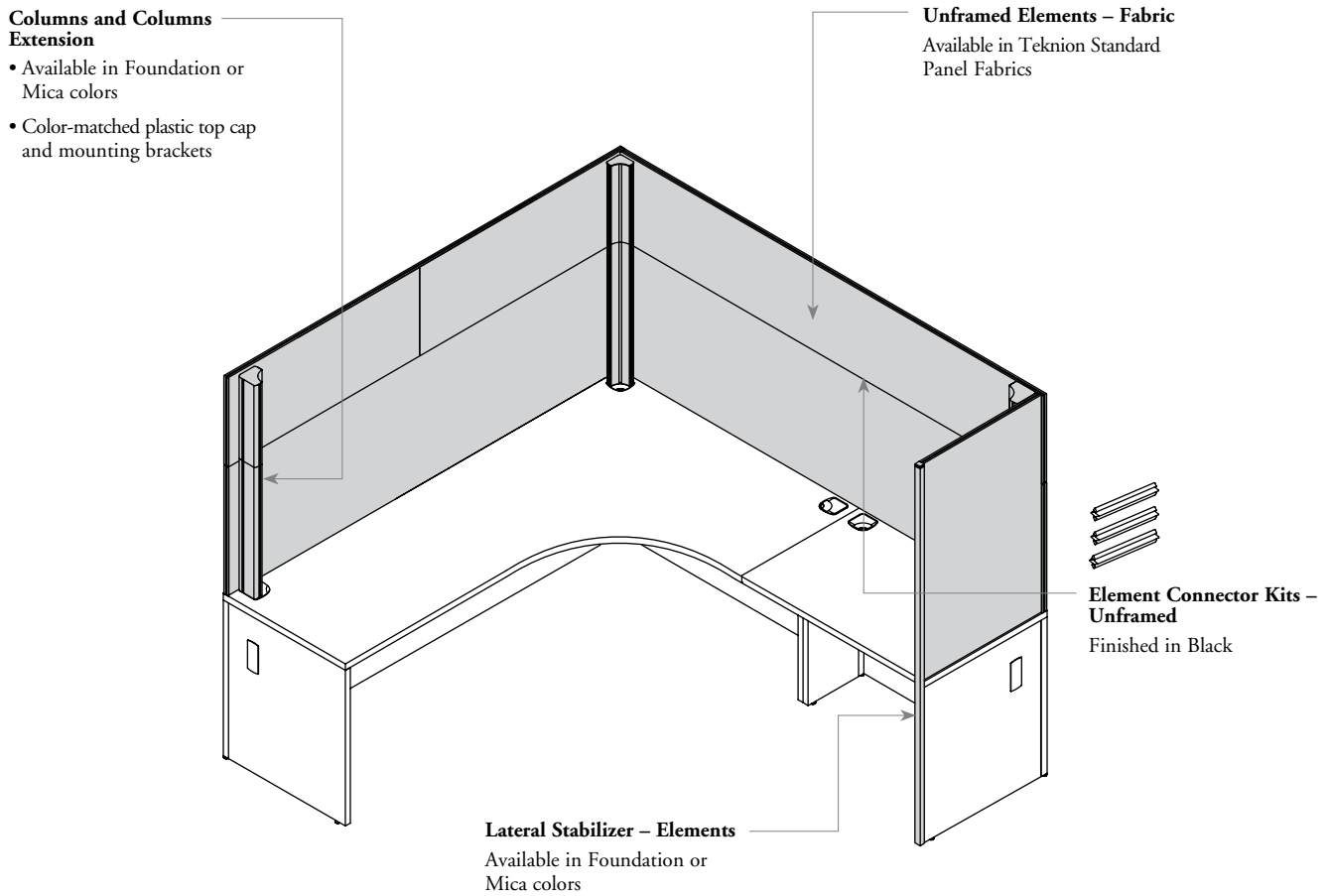

column & screen finishes (continued)

add-on, central/lateral screen for spine desk, markerboard, worksurface edge, and 1" floor screens

1" Floor Screens with Glass – Back or Lateral Connection

- Solid base available in Source Laminate colors
- Top section available in 1/4" (6 mm) tempered glass Clear (CL) or Frosted (FT) finishes
- Mounting hardware is available in Foundation, Mica or Coordinate colors
- Frosted (FT) is a single-sided etched tempered glass which is facing inward of workstation
- Supporting Frame is available in Foundation or Mica colors

1" Floor Screens
Available in Source Laminate colors

Glass Markerboard – Screen Mounted

- Available in Back-Painted Glass
- Mounted Extrusion match the glass finish

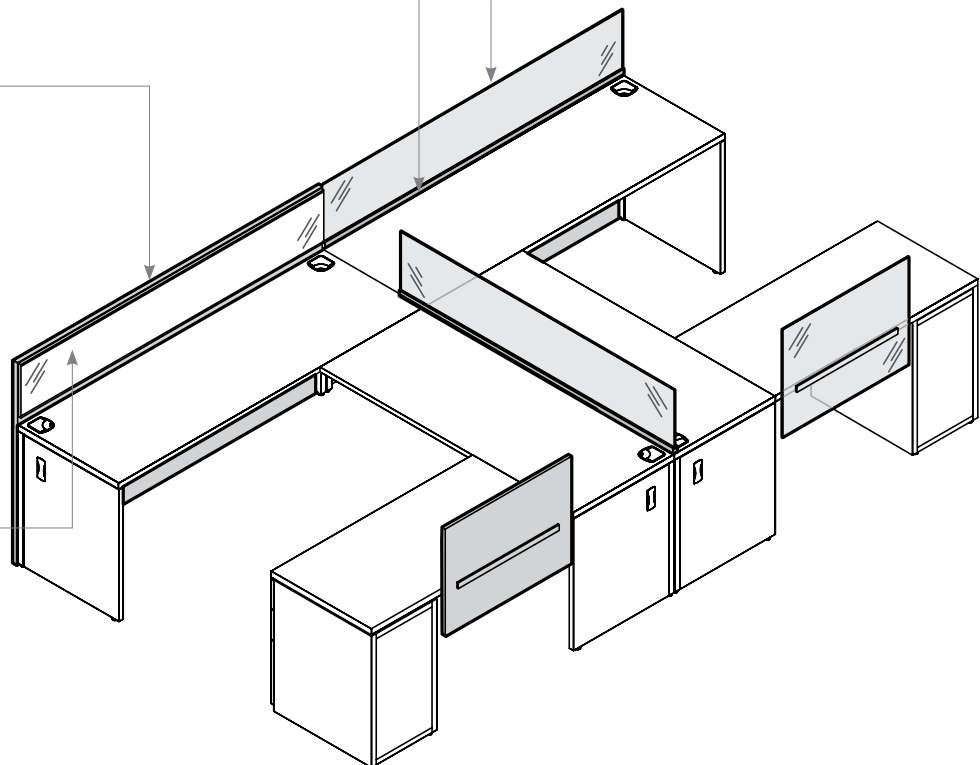

column & screen finishes (continued)

add-on, central/lateral screen for spine desk, markerboard, worksurface edge, and 1" floor screens (continued)

- Supporting Frame is available in Foundation or Mica colors

Add-On Screens or Glass Central/Lateral Screens for Spine Desk

- Available in 1/4" (6 mm) tempered glass Clear (CL) or Frosted (FT) finishes
- Frosted (FT) is a single-sided etched tempered glass

Solid Central/Lateral Screens for Spine Desk

- Available in Source Laminate colors
- 11/16" thick

Fabric Central/Lateral Screens for Spine Desk

Available in Teknion Standard Panel Fabrics

Glass only/Magnetic Glass Central/Lateral Screens for Spine Desk

Available in 1/4" (6 mm) Standard or Back-Painted tempered glass

Standard finish:

Frosted (FT) finish (Glass only) is a single-sided etched tempered glass which is facing inward of double-glass screen assembly

Worksurface Edge Screens – Glass

- Available in 1/4" (6 mm) tempered glass Frosted (FT) finish
- Frosted (FT) is a single-sided etched tempered glass which is facing inward of workstation
- Mounting hardware available in Foundation or Mica colors

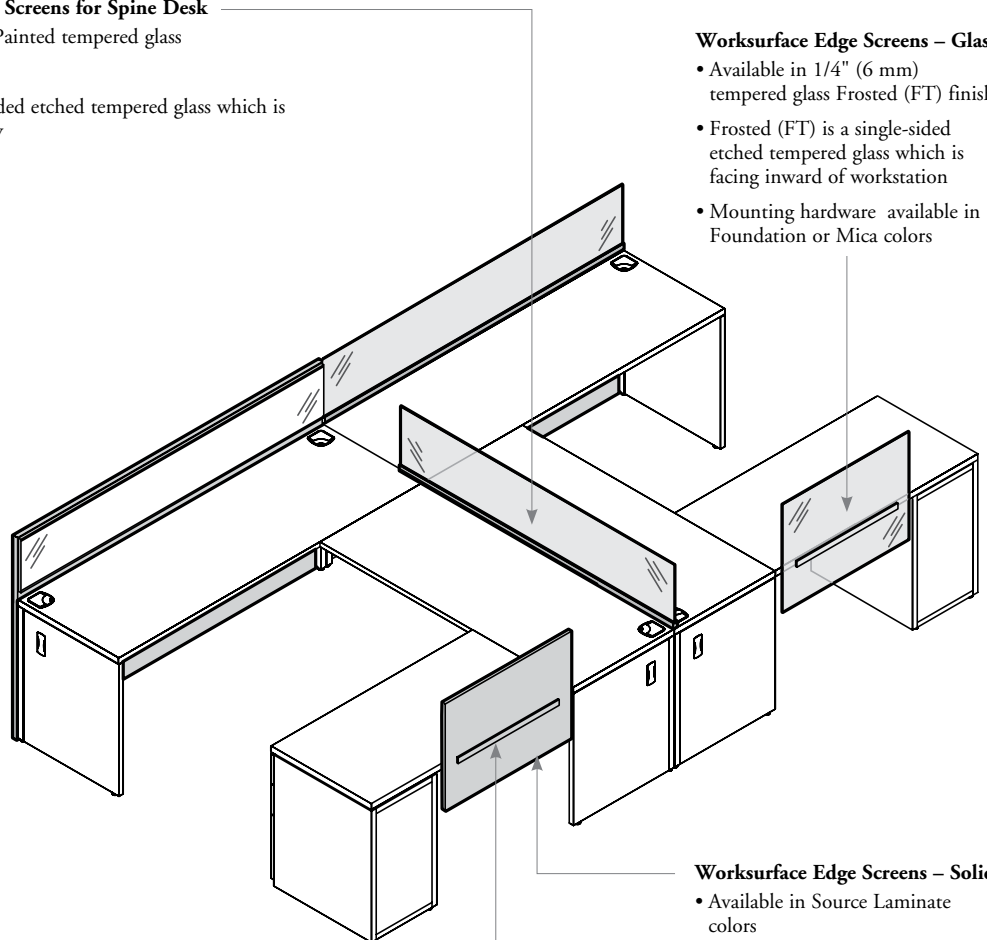

Cable Pass-Through

Available in a Platinum Coordinate color

Worksurface Edge Screens – Solid

- Available in Source Laminate colors
- 11/16" thick
- Mounting hardware available in Foundation, Mica or Coordinate colors

column & screen finishes (continued)

1" or 2" framed elements and 2" freestanding screens

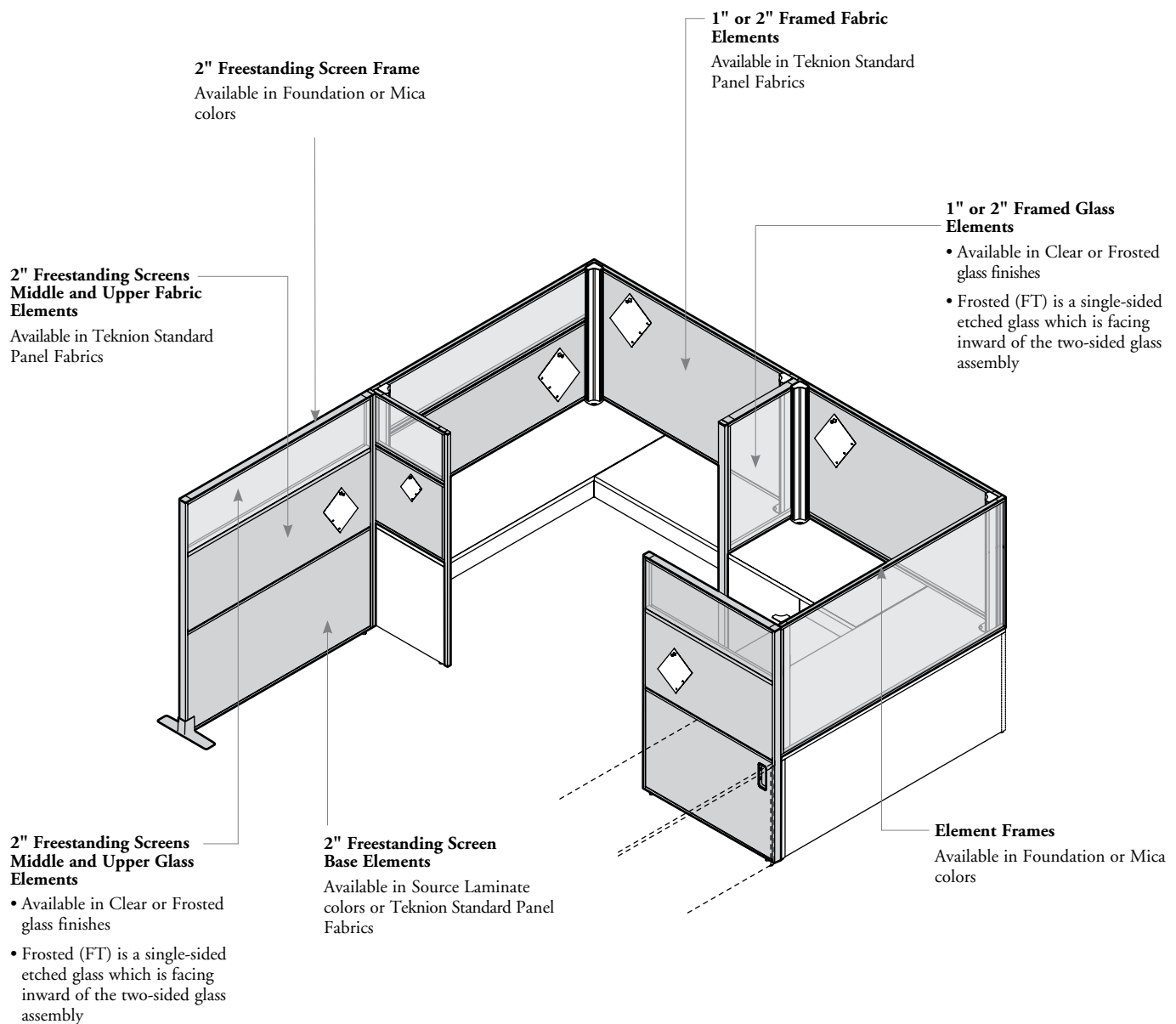

column & screen finishes (continued)

1" or 2" framed elements and 2" freestanding screens (continued)

Back Connection and Lateral Connection

- Available in Foundation, Mica or Coordinate Colors
- Hardware can be specified to match gable finish

Coordinate Color Finishes

- Coordinate colors are solid colors that can be used to match wood prints

Finishes

M8 Royal Cherry	R8 Urban Walnut
NB Ivory Birch	R9 Choice Maple
NC Provincial Oak	V1 Estate Cherry
ND Coastal Elm	VD Campus Oak
Q4 Espresso Reflect	VL Flax Reflect
Q6 Stainless	VV Pecan Reflect
Q7 Walnut Cathedralgrain	W8 Cocoa Brown Reflect
Q9 Mercurial Walnut	W9 Sycamore Reflect
R7 Java Walnut	

Lateral Stabilizer – Elements, Desk Connection, Wall Connection, and Height-Change Connection

Available in Foundation or Mica colors

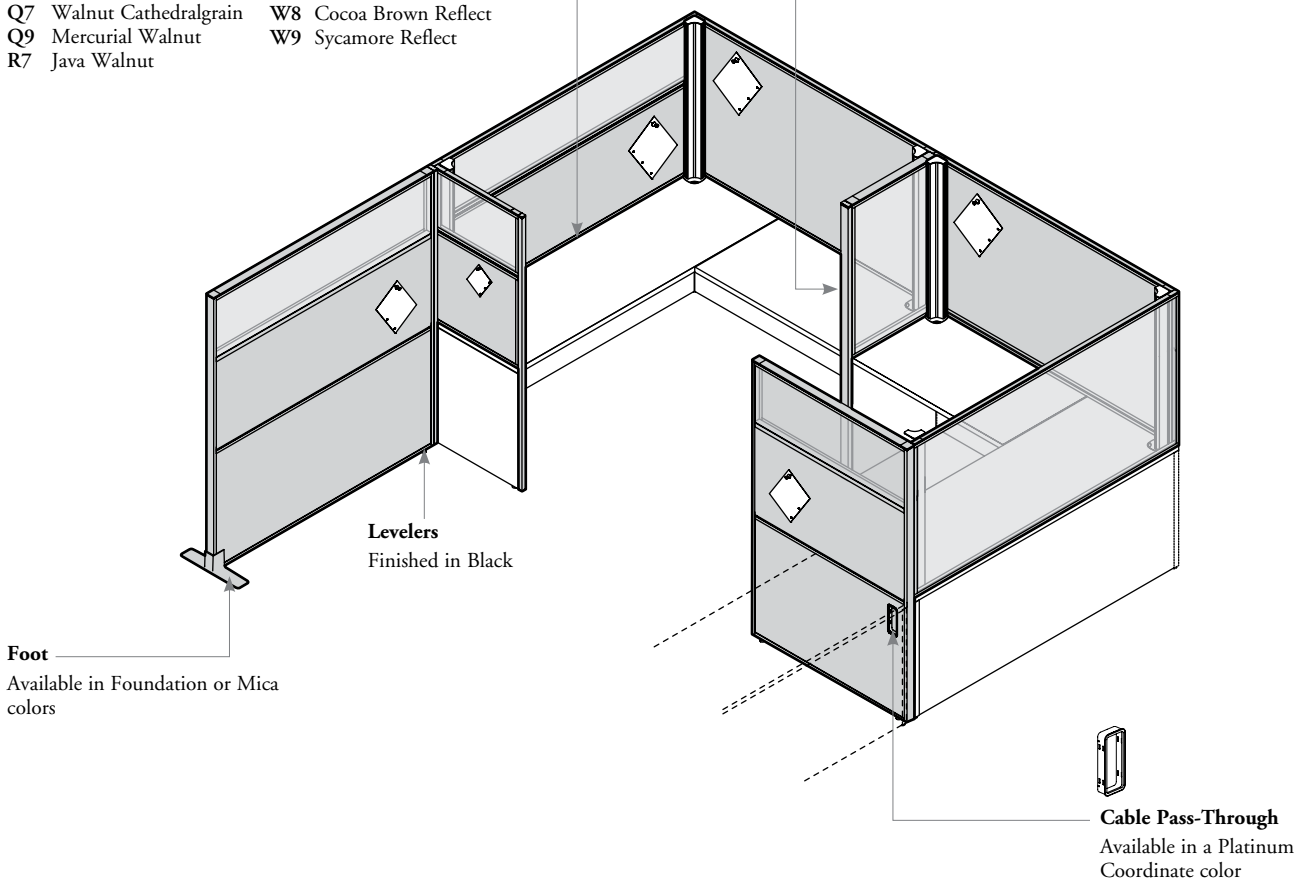

countertops

countertops

COUNTERTOP BASICS 102

countertop basics

Expansion Desking offers a wide variety of countertop surfaces. They can be used to create reception stations.

- ❗ Countertops can be installed on modular desks preferably on a straight edge
- All countertop dimensions listed are actual dimensions
- Products in this section are **not** compatible with Spine Desks
- Must be combined to 13" high elements

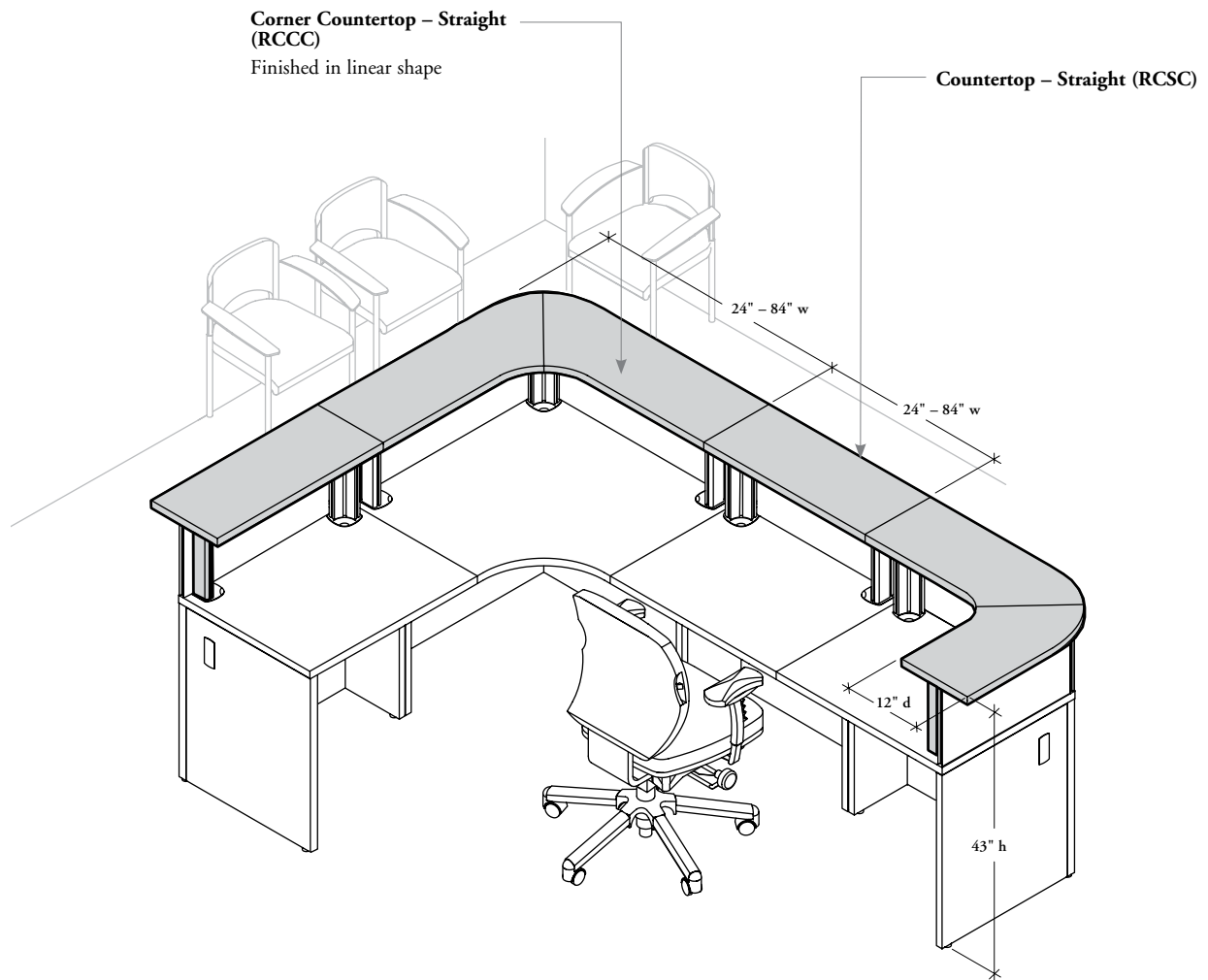

Finishes

- Available in Foundation Laminate colors or Flintwood Stains (No Cathedral)
- Edge trims available in Straight Trim (6) or Flintwood Flat Trim (9)
 - Flintwood Flat Trim is only available on Flintwood worksurfaces. Edge trims will be finished to match the Flintwood worksurface
 - Straight Trim is **not** available on Flintwood worksurfaces

countertop basics (continued)

Countertop Supports

Two support styles are available for countertop installations:

Structural Column (RPSC)

Countertops are mounted above 13" Structural Columns

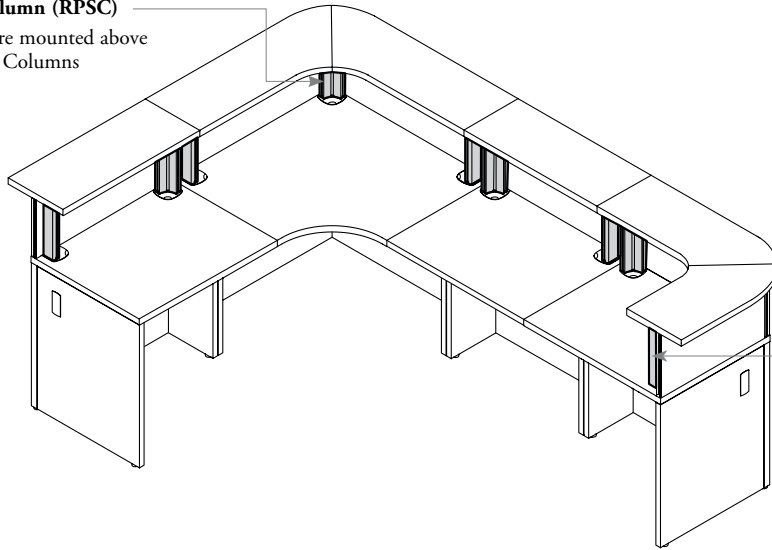

Countertop Support (RCCS)

- Allows installation of a corner countertop along the depth of a desk
- Approximate total height is 43"

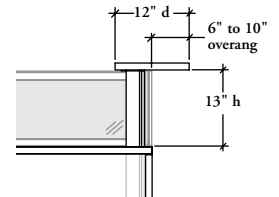

- Available in Foundation or Mica colors

Countertop Applications

Can be connected to one another

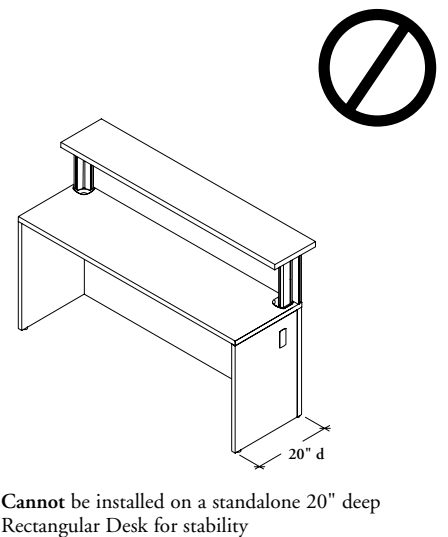
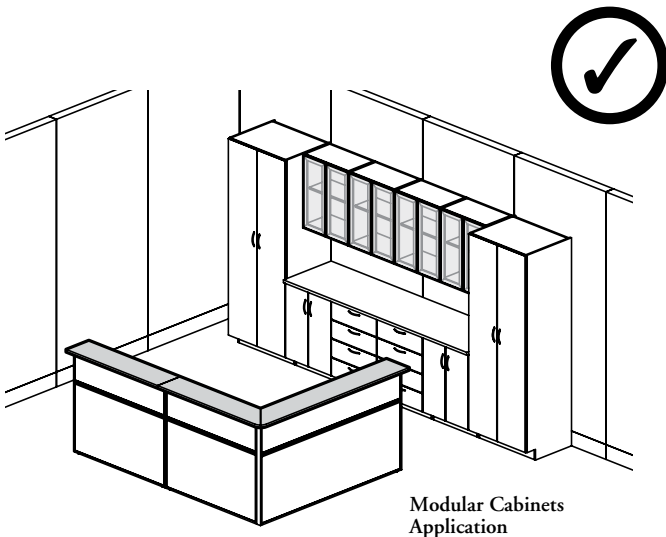

mounted storage &
accessories

mounted storage & accessories

MOUNTED STORAGE BASICS	106
STACKED COLUMN-MOUNTED STORAGE APPLICATIONS	108
ELEVATED DESKTOP CABINET BASICS	109
DESK-MOUNTED STORAGE COMPATIBILITY CHART	111
MOUNTED STORAGE LOCK CHART	112
MOUNTED STORAGE ACCESSORIES	113
MOUNTED STORAGE FINISHES	114
MOUNTED STORAGE GRAIN DIRECTION	116

mounted storage basics

Mounted Storage supplies overhead storage and provides space division between workstations. Elevated Desktop Cabinets provide storage alternatives to reduce workstation height.

- All dimensions listed are nominal
- All overheads are shipped knocked down
- An assortment of accessories and organizers (for paper, media, book and pencil) are also available
- All closed storage products, except glass hinged doors, can be specified with a lock and key set and can be keyed randomly or alike. A Key Chart must accompany every order

Overhead Cabinets

- Available in two styles: Column- and Wall-Mounted
- Column-Mounted Cabinets must be mounted on 37" high structural columns; they **cannot** be installed on column extensions
- Wall-Mounted Cabinets are supported by the supplied mounting hardware on the wall
- When used, Column-Mounted Overhead Cabinets with Receding Doors create a 19 1/2" clearance between the worksurface and the cabinet

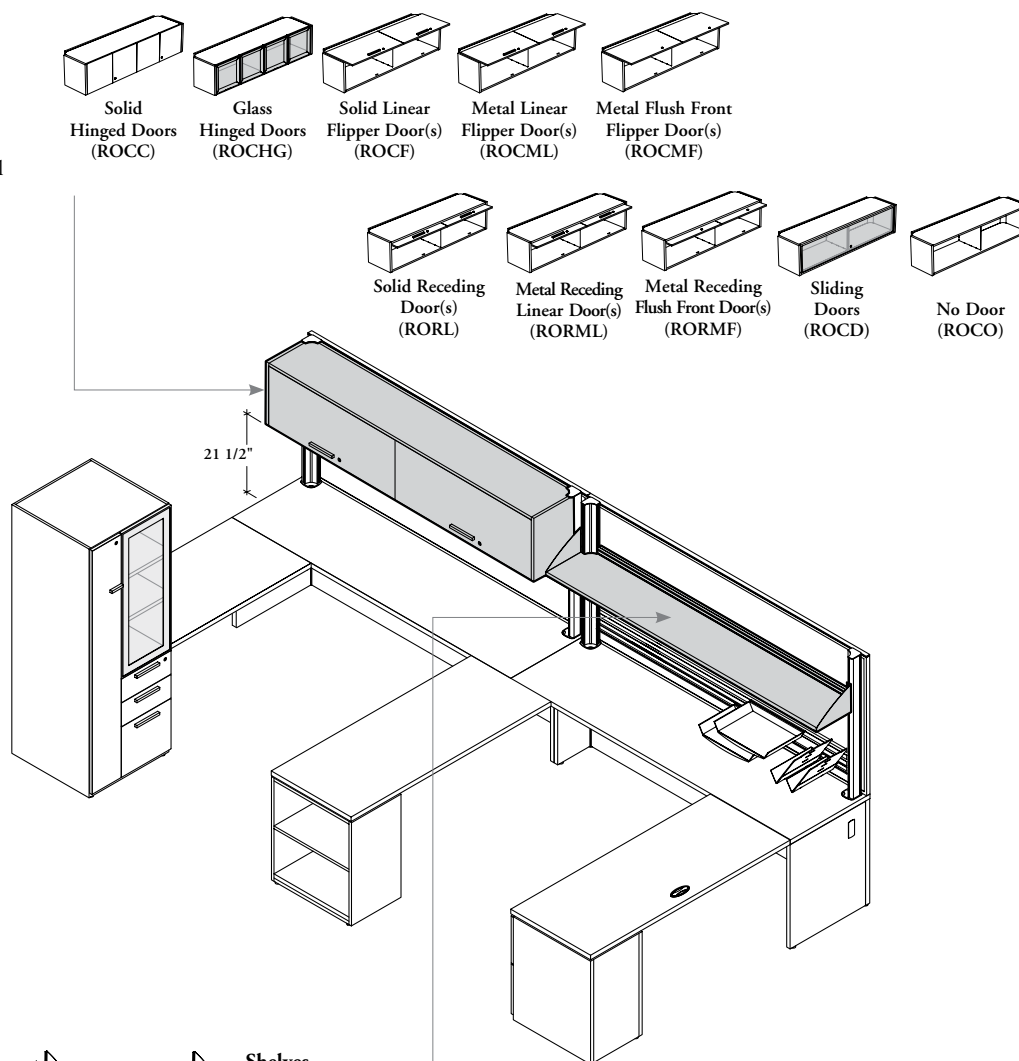

Shelves

- Mount at various heights on structural column
- Stacked shelves must be mounted on 52" high structural columns only
- **Cannot** be installed on column extensions
- 1" thick
- Measure 2.5" less in width than the worksurface above which it is installed so as **not** to interfere with column-mounted elements
- Equipped with aluminum back rail for additional strength
- Lighting accessories (RLYTU or RLED) may be installed beneath solid shelves with wood screws (RLYTU) or double face tape (RLED)

mounted storage basics (continued)

Available for Overhead and Elevated Desktop Cabinets

Solid, Metal and Glass Doors

- Laminate (Solid) and Metal door fronts are 11/16" thick
- Sliding Doors are available in:
 - 5/32" (4 mm) Standard or Back-Painted tempered glass
 - Laminate
 - Flintwood
- Glass hinged doors are **not** lockable. The lock option is available on all other overhead cabinets
- Hinged doors have no pull
- Hinges allow doors to open up to 110°

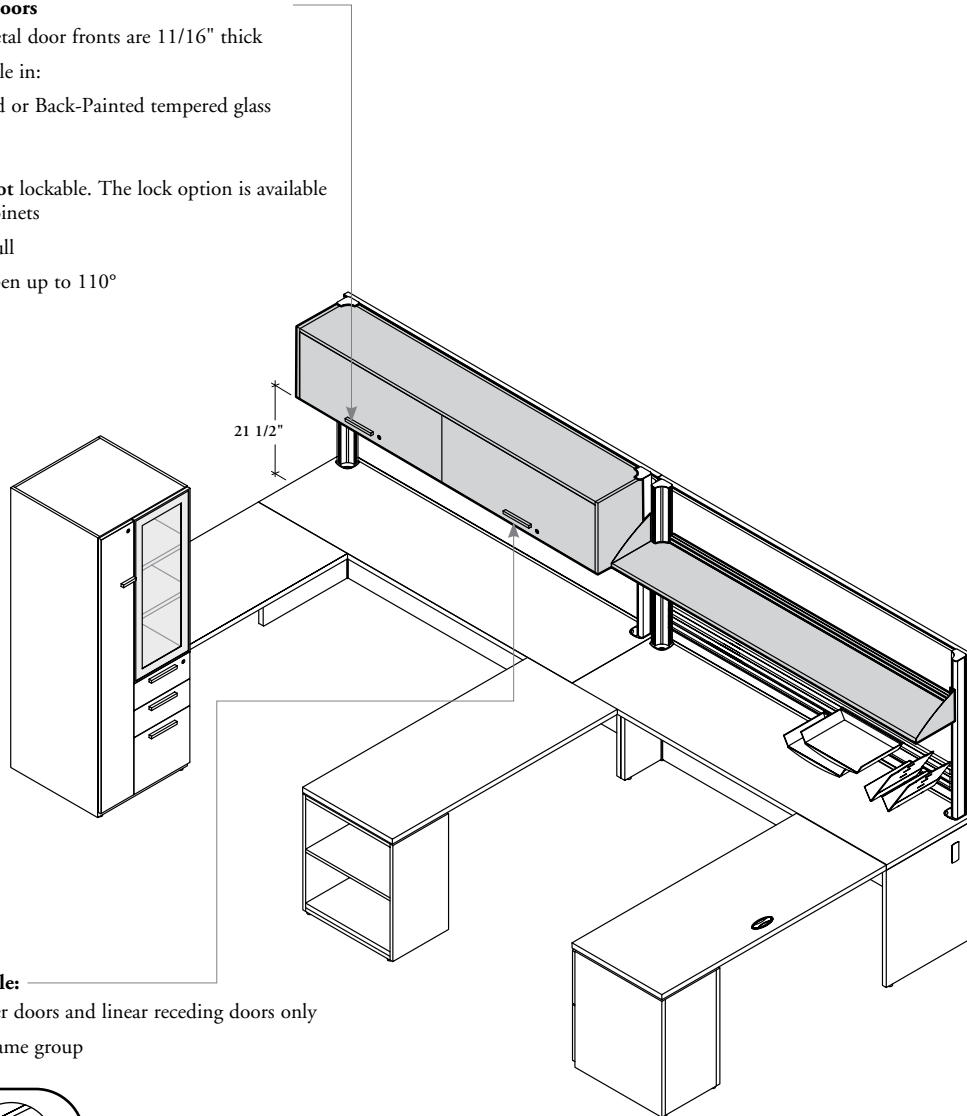

Six pull styles are available:

- Available for linear flipper doors and linear receding doors only
- Interchangeable within same group

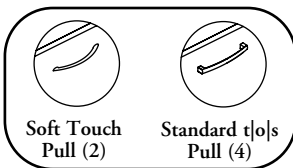

OR

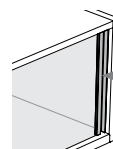
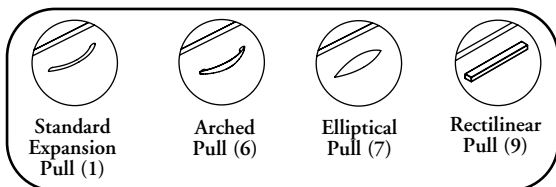

The sliding doors come with dedicated sliding door pulls

stacked column-mounted storage applications

Stacked Column-Mounted Overhead Cabinets

- Must be mounted on 52" high structural columns
- Must be specified on Modular Desks with full gable at both ends
- Full gable can be replaced with one of the following on Single Structure or Extended Corner Desks:
 - Flush-Mounted Modesty Panel (Full- or 3/4"-Height)
 - Credenza with Worksurface Support module

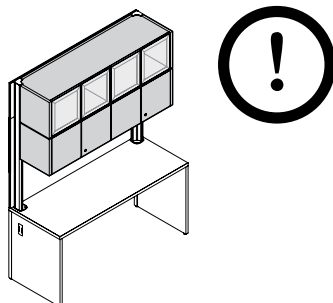
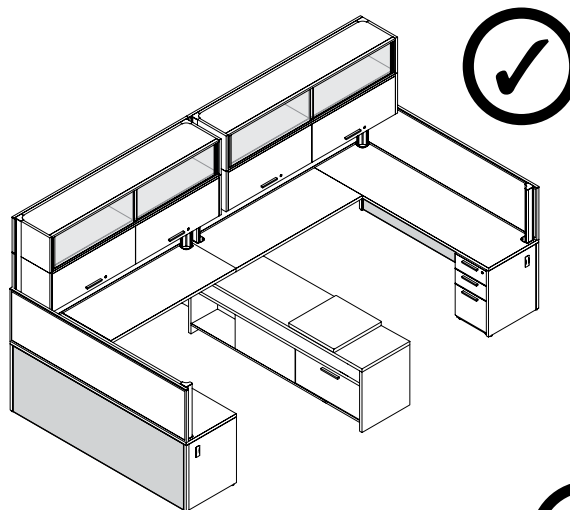
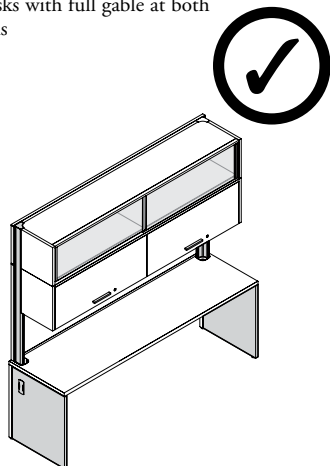

Two Mounted Overhead Cabinets with Hinged Doors can be stacked, but doors of the upper cabinet can only be opened from the top

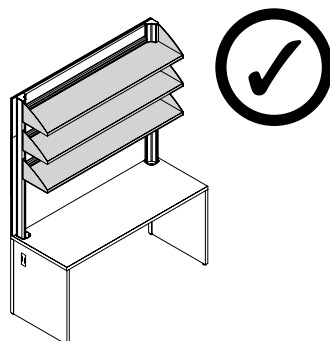
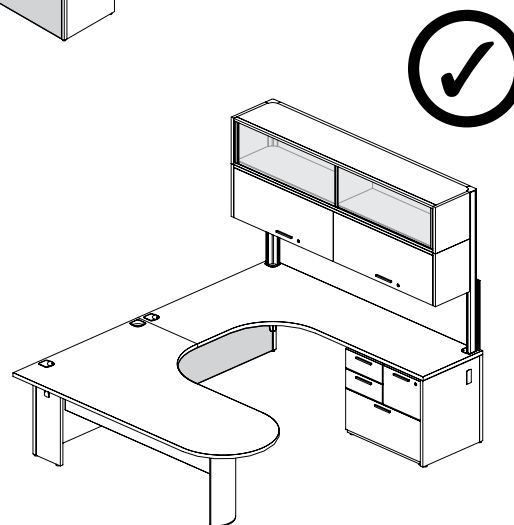

Can also stack three shelves

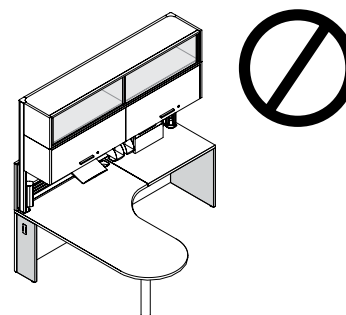

Cannot be installed on Modular Desks with full and half gables

elevated desktop cabinet basics

Elevated Desktop Cabinets

- Mount directly on a Modular or Spine Desk to achieve an overall height of 51"
- Are available single-sided or shared
- Shared configuration should be used in a collaborative space between two users, so that each user has access to half of the storage space
- A back accessory must be specified on shared configuration only:
 - Fabric Tackboard (F)
 - Laminate (L)

- Three base configuration are available:
 - Closed (C)
 - Open without Divider (O)
- Only shared configuration can be specified Open without Divider
- Allows installing the RLYTU or RLED light underneath

Single-Sided Configuration

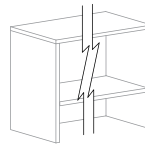

Closed (C)

Shared Configuration

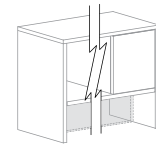

Closed (C)
(with center divider under shelf)

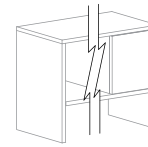

Open without Divider (O)

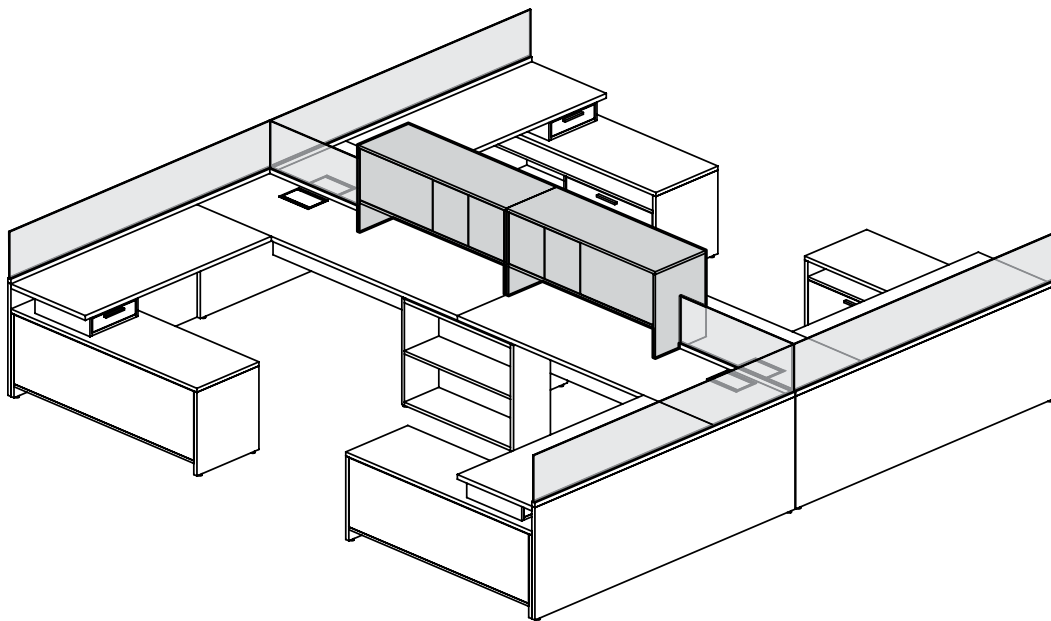

Sliding Doors



Hinged Doors

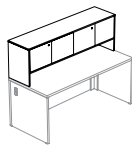

Open

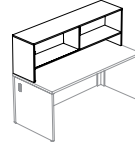

← Single-Sided
Non handed

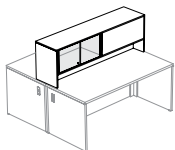

RSEDS

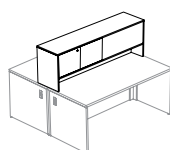

RSEHD

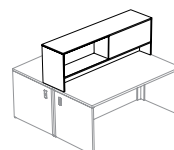

RSEOO

← Shared

- Split cabinets to provide storage on both sides
- Can be specified left or right handed. Handedness is determined by the location of the doors/opening when facing the unit (Left Shown)

Sliding Doors

Are available in Laminate, Flintwood or Glass finishes

Hinged Doors

They have no pull; a touch-latch is installed on each door for the opening

elevated desktop cabinet basics (continued)

elevated desktop cabinet applications

Rectangular Grommets

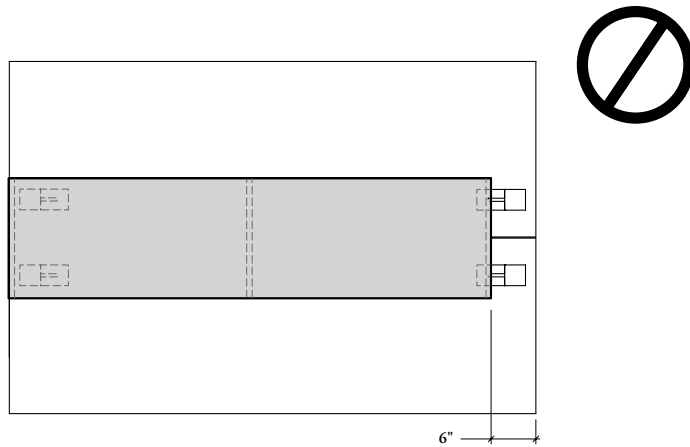

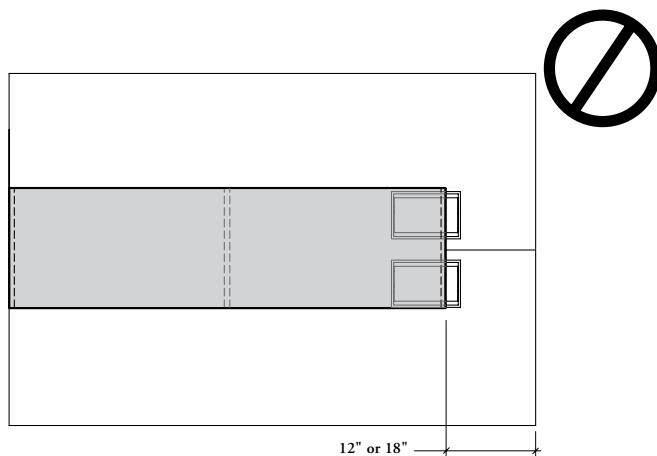

An off-module Elevated Desktop Cabinet could interfere with an access door or grommets. Use specification software appropriately

Access Doors

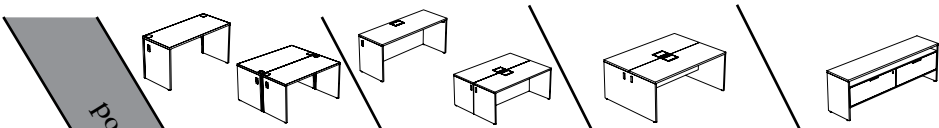

desk-mounted storage compatibility chart

⚠ Following guidelines take into account that single-sided storage are mounted on a single-sided desk and that shared storage are mounted in a shared position on a shared desk or on two back-to-back desks

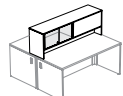
desk-mounted storage	Position				
		Modular Desks	Single-Sided Spine Desks	Shared Spine Desks	Credenzas
 RSEDSS RSEHDS RSEOOS Single-Sided	ON-Module	Yes (20" or 24" deep Desks with Full Gables, see notes 1 and 2)	Yes (See note 3)	Yes (See note 3)	Yes (See note 4)
	OFF-Module	No	No	Yes	Yes (See note 4)
 RSEDSL or R RSEHDL or R RSEOOL or R Shared	ON-Module	Yes	Yes	Yes	Yes (See note 4)
	OFF-Module	Yes	Yes	Yes	Yes (See note 4)











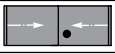

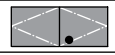
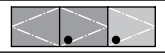
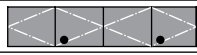
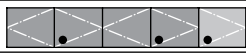



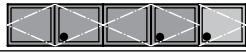

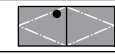

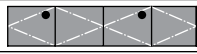
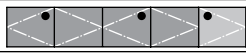

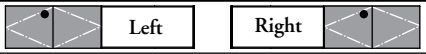
Note 1: An half gable can replace a full gable when it is used in combination with a supporting storage or a supporting module mounted on a 23" high Freestanding Credenza

Note 2: An half gable can replace a full gable when it is used in combination with a Flush-Mounted Modesty Panel (full-height only) on Single Structure L-Shaped Desks or Extended Corner Desks

Note 3: Except with centered Rectangular Grommet or middle Access Door

Note 4: Except Freestanding Credenzas with Sliding Doors

mounted storage lock chart

product code and description		mounted storage width			
		30" – 48"	54" – 84"		
	Door Configurations				
	Compartments	1	2		
	Locks	1	1		
	Door Configurations				
	Compartments	1	2	2	3
	Locks	1	2	2	3
	Door Configurations				
	Compartments	1	2	2	3
	Locks	1	2	2	3
	Door Configurations				
	Compartments	1	2	2	3
	Locks	1	2	2	3
	Door Configurations				
	Compartments	2		4	
	Locks	2		4	
	Door Configurations				
	Compartments	2		2	
	Locks	1		2	
	Door Configurations				
	Compartments	2		2	
	Locks	2		2	
	Door Configurations				
	Compartments	1		2	
	Locks	1		2	

Lockable Double Doors
 Lockable Single Door
 Not Lockable

mounted storage accessories

Expansion Desking offers a series of work tools that are designed to increase the visibility of vertical surfaces within a workstation as well as enhance the functionality of mounted storage.

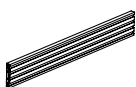

Accessory Rail (ROAR)

- Installs on structural columns to support Personal Organizers (PAX) and other accessories (e.g., YFX, see Complements products)
- Can be installed at various heights and be vertically superimposed to increase capacity
- Can be shared between desks to reduce costs
- Specify the width according to the width of the worksurface over which the rail is mounted
- Available in Foundation or Mica colors

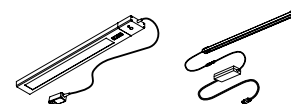

Lighting (RLYTU or RLED)

Can be mounted beneath all Expansion Desking mounted storage products

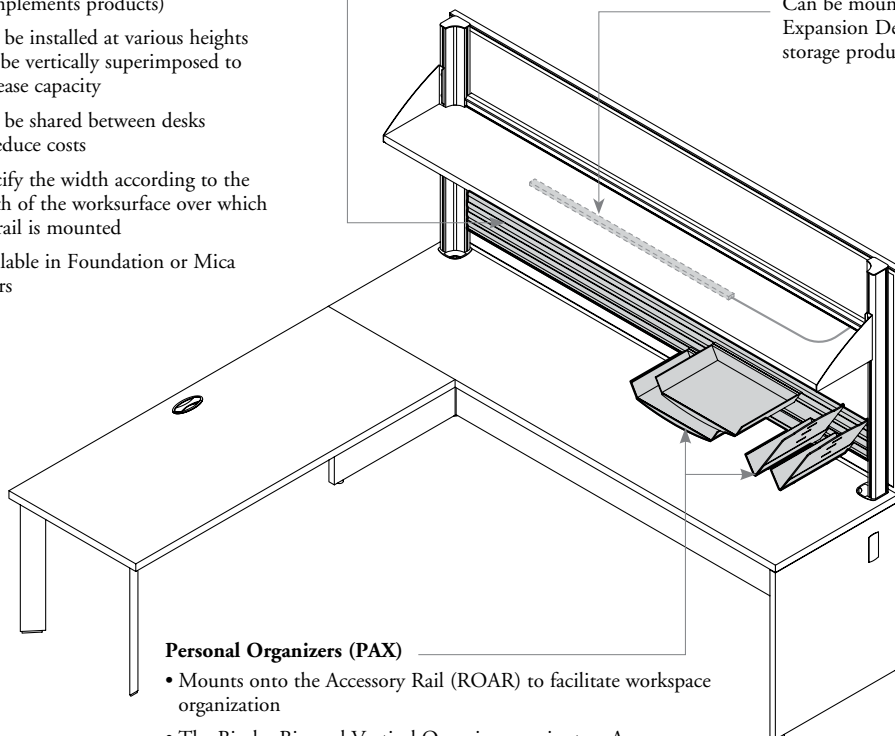

Personal Organizers (PAX)

- Mounts onto the Accessory Rail (ROAR) to facilitate workspace organization
- The Binder Bin and Vertical Organizer require two Accessory Rails for adequate support
- Available in Foundation, Mica or Accent colors

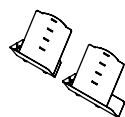

Divisional Sorter, Letter/A4 (PAX90) or Legal (PAX91)

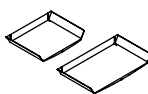

Tray, Letter/A4 (PAX92) or Legal (PAX93)



Pencil Tray (PAX94)



Binder Bin (PAX95)



Media Organizer (PAX96)

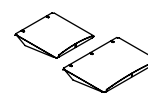

Telephone Shelf, Small (PAX97) or Large (PAX98)

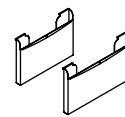

Vertical Organizer, Letter (PAX99) or Legal (PAX100)

Also available:

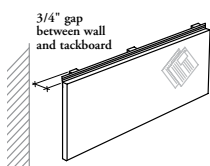

Wall-Mounted Tackboard (RPWT)

- Provides a tackable fabric surface for use under Wall-Mounted Cabinets only
- Attaches to the vertical surface between the desk and the Wall-Mounted Cabinet
- Creates a 3/4" gap between the tackboard and the wall to manage cables
- Available in Teknion Standard Panel Fabrics

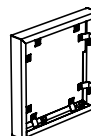
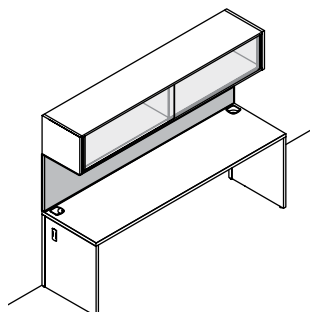

Overhead Cabinet Filler (RAGF)

- Installs between two column-mounted cabinets for an aesthetic look

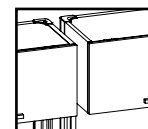

Before

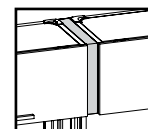

After

- Available in Foundation, Mica or Coordinate Colors

mounted storage finishes

⚠ All Laminate components are protected with a solid plastic edge

Solid Doors

- Available in Source Laminate, Foundation Laminate colors or Flintwood (No Cathedral)
- Hinged doors are **not** available in Foundation Laminate, except hinged doors for Overhead Cabinets
- Sliding doors are **not** available in Foundation Laminate

Metal Doors

Available in Foundation or Mica colors

Glass Doors

- Available in 5/32" (4 mm) Standard or Back-Painted tempered glass

Standard Glass finishes:

- Clear (CL)– Frosted (FT) is a single-sided etched tempered glass which is facing inward of storage cabinets
- Hinged door frames are available in Foundation or Mica colors

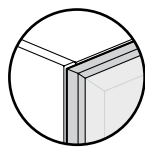

Framed

When Clear (CL) or Frosted (FT) glass finish is specified, the door is framed

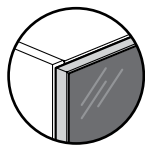

Flush Front Look

When Back-Painted glass finish is specified, the door is unframed

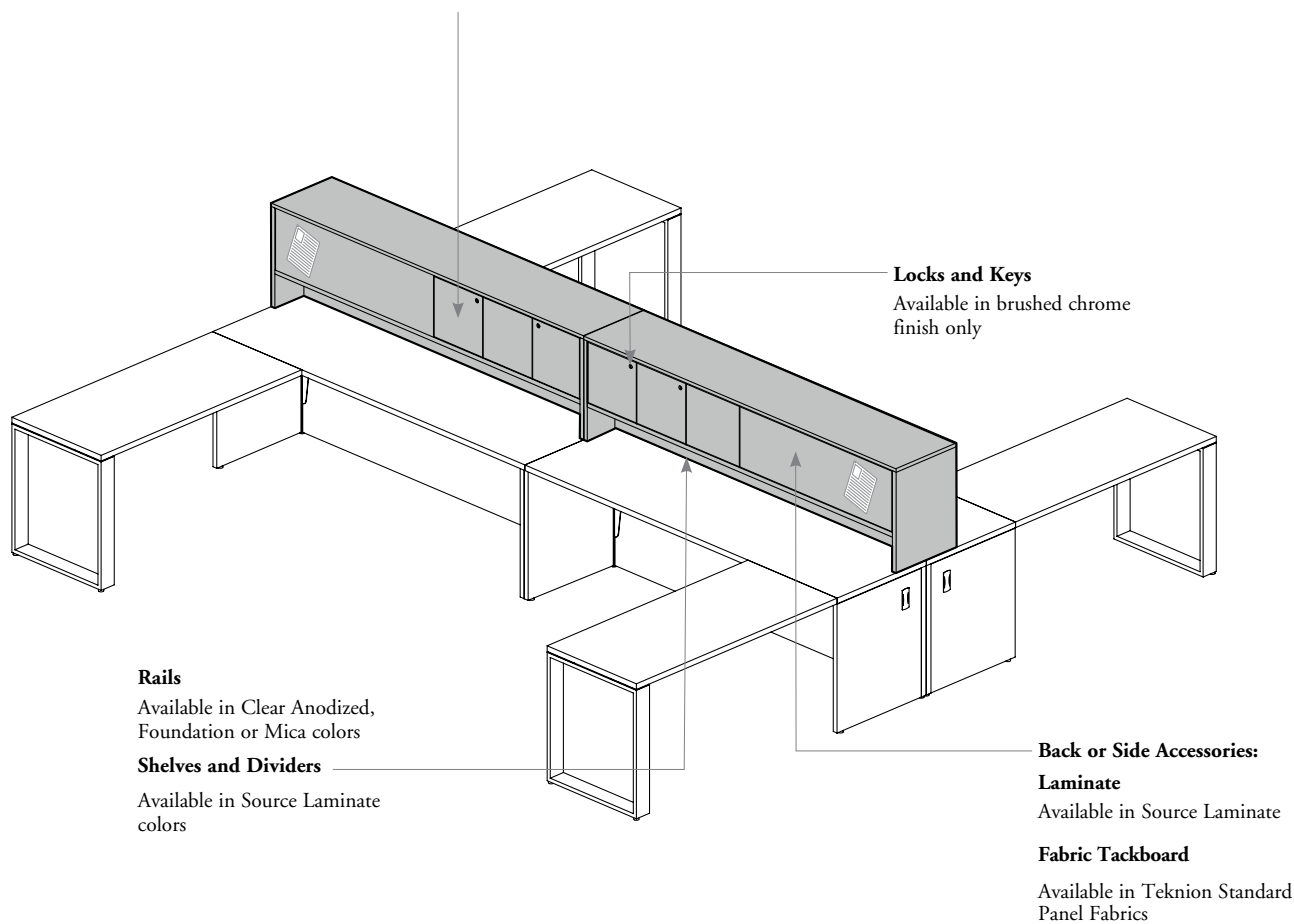

mounted storage finishes (continued)

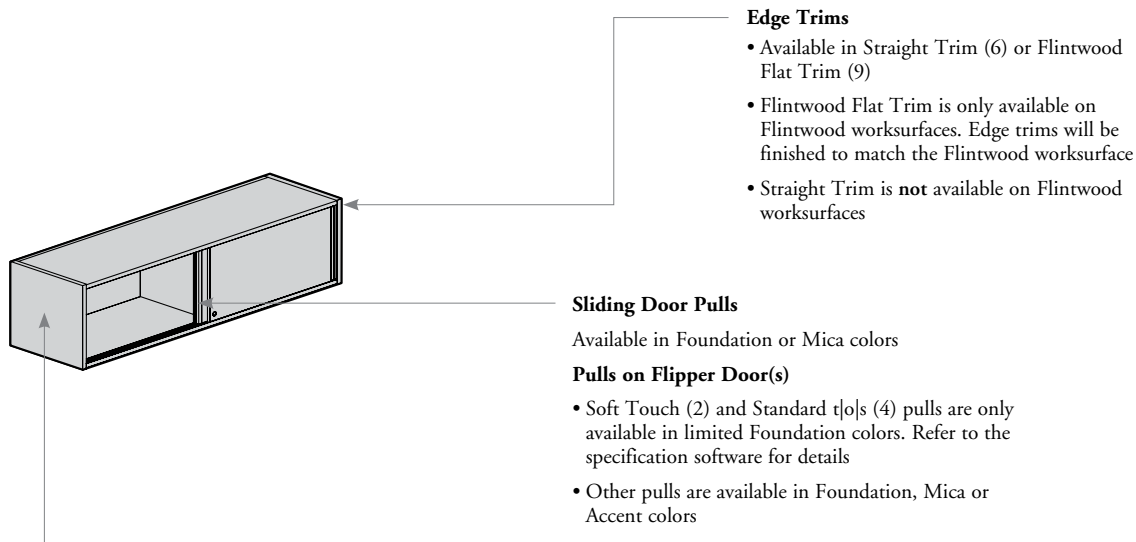
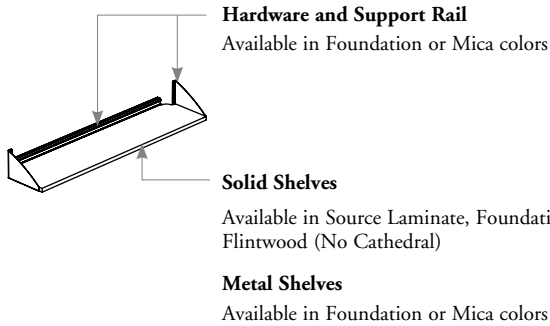

Laminate Cases

- Available in Source Laminate colors for Elevated Desktop and Overhead Cabinets
- Metal shelves and dividers are available in Foundation, Mica or Coordinate Colors (solid colors designed to match wood prints)

Metal Cases

Available in Foundation or Mica colors

Coordinate Color Finishes

- Coordinate colors are solid colors that can be used to match wood prints

Finishes

M8 Royal Cherry	R8 Urban Walnut
NB Ivory Birch	R9 Choice Maple
NC Provincial Oak	V1 Estate Cherry
ND Coastal Elm	VD Campus Oak
Q4 Espresso Reflect	VL Flax Reflect
Q6 Stainless	VV Pecan Reflect
Q7 Walnut Cathedralgrain	W8 Cocoa Brown Reflect
Q9 Mercurial Walnut	W9 Sycamore Reflect
R7 Java Walnut	

mounted storage grain direction

• Flipper, receding and sliding door front grain direction will vary depending on finish selected:

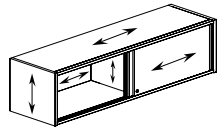

Horizontal Grain Direction for colors listed below:

- 3A – 3B – 3C – 3D – 3E – 3L – 3M – 3X – XQ – XR
Source Laminate
- 2A – 2B – 2C – 2D – 2E – 2L – 2M – 2X – RQ – YR
Foundation Laminate

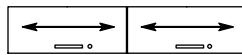
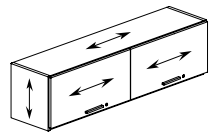
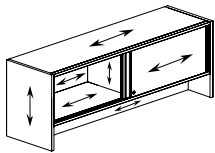

Flipper and Sliding Door Fronts

OR

Vertical Grain Direction for colors listed below:

- 3F – 3J – 3K – 3N – 3P – XJ – XK
Source Laminate
- 2F – 2J – 2K – 2N – 2P – JG – RN
Foundation Laminate
- FC – FD – FM – FN – FX – NR – NT – VA – VB – VZ – 5N – 5P – 5Q – 5R – 5S – 5T – 5V – 5W – 5Z
Flintwood (No Cathedral)

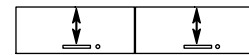
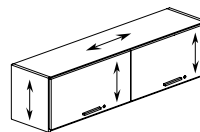

Flipper and Sliding Door Fronts

• Hinged door front grain direction will always be vertical

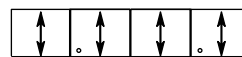
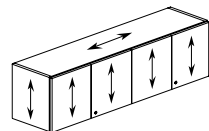

Hinged Door Fronts

credenzas

credenzas

CREDENZA BASICS	120
CREDENZA FILING DRAWER CAPACITIES	124
23" HIGH FREESTANDING CREDENZA CONFIGURATIONS	126
29" HIGH FREESTANDING CREDENZA CONFIGURATIONS	130
GROMMET & CABLE PASS-TRHOUGH APPLICATIONS	132
CREDENZA PRODUCT OFFERING	133
CREDENZA LOCK CHART	134
CREDENZA FINISHES	135
CREDENZA GRAIN DIRECTION / USER EDGE	137

credenza basics

Credenzas come in a variety of styles to complement any workstation.

❗ Storage is available with locks, keyed alike to match other storage components or keyed randomly for a dedicated lock

Credenzas

- Two heights are available in 23" or 29"
- Compartment height is the same in both versions
- Available from 36" to 84" wide depending on configurations
- Can be used alone or combined with worksurfaces, Modular and Spine Desks
- Provide enclosed and accessible areas to allow a variety of storage options
- If applicable, box drawers come with pencil tray and provide storage for furniture offices below worksurfaces
- File and letter-size binder compartments that provide a usable storage area below worksurfaces
- Grommets and Cable Pass-Through (some models only) are available on the side gables for casual wire management
- Allows 3 1/2" leveling adjustment range
- Cannot support storage products

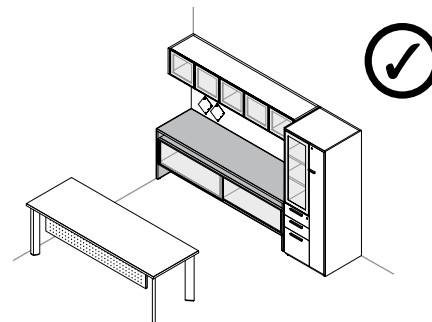

Standalone Application

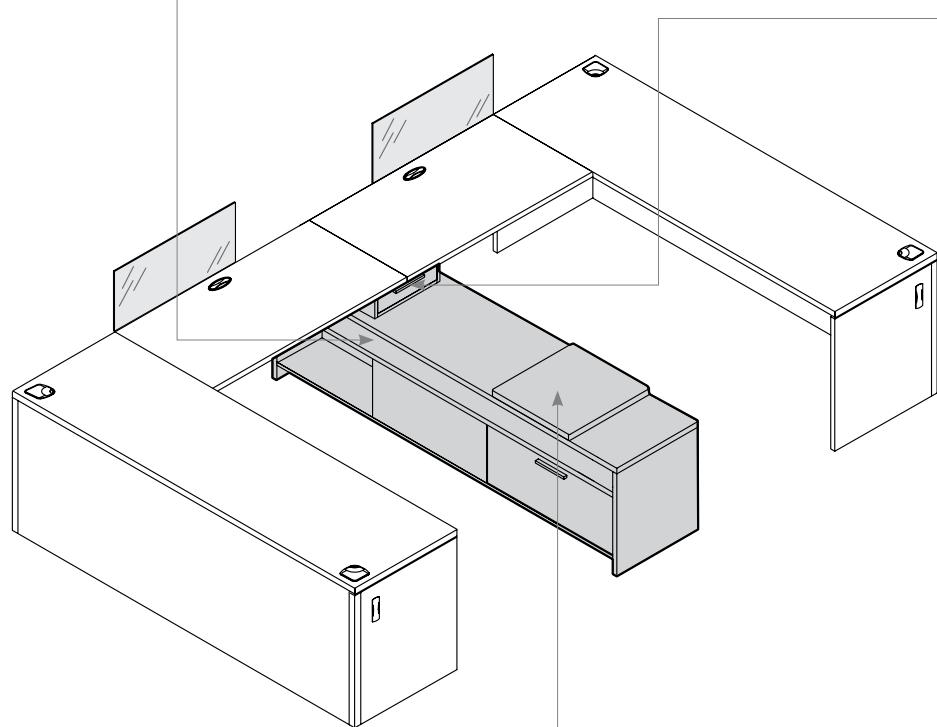
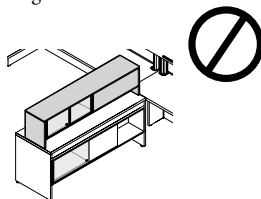

Worksurface Support – Low Credenza

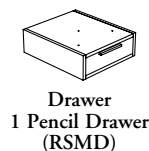

- Must be used on 23" high Credenzas
- Pencil Tray included
- Add-On Screen (RPSAG) and all Lateral Screens for Spine Desks **cannot** be installed over of a Worksurface Support

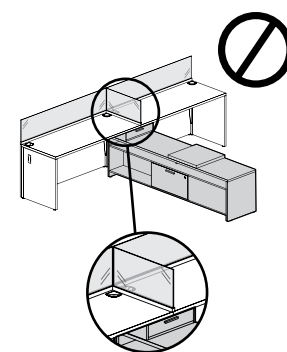

Seat Cushions (RSSC)

- For guest seating on 23" high Credenzas only
- Can be specified in 20" or 24" depth
- Can be placed anywhere along the top of the credenza
- Can be used in Single or Shared applications

credenza basics (continued)

credenza supporting applications

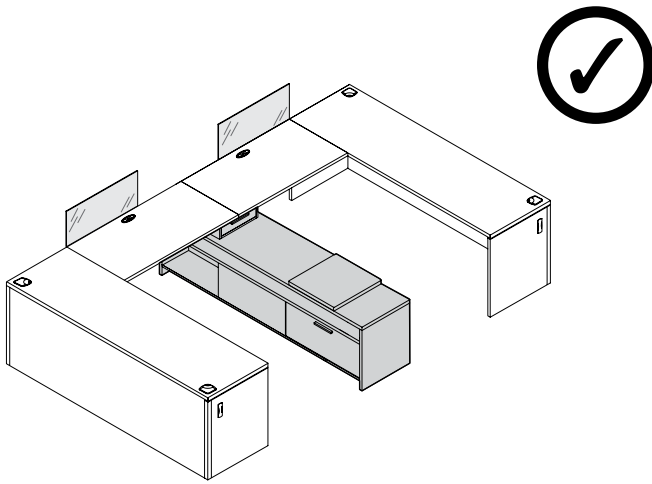

23" high Credenzas

- Require a Worksurface Support (RSMD) when rectangular worksurfaces are installed above
- Used as an occasional seating surface when Seat Cushion (RSSC) is specified

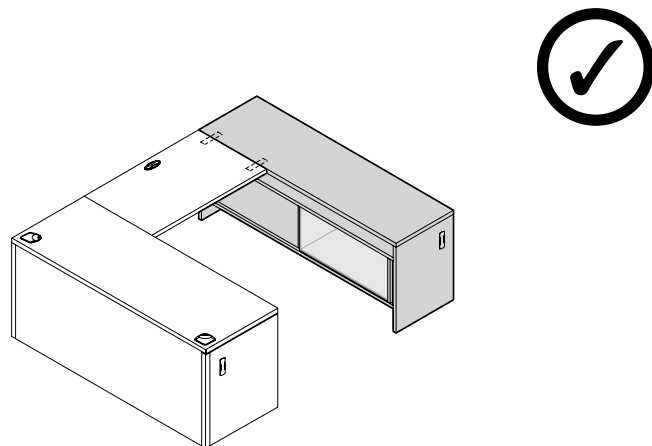

29" high Credenzas

Linking plates are included to connect a worksurface to the credenza

credenza basics (continued)

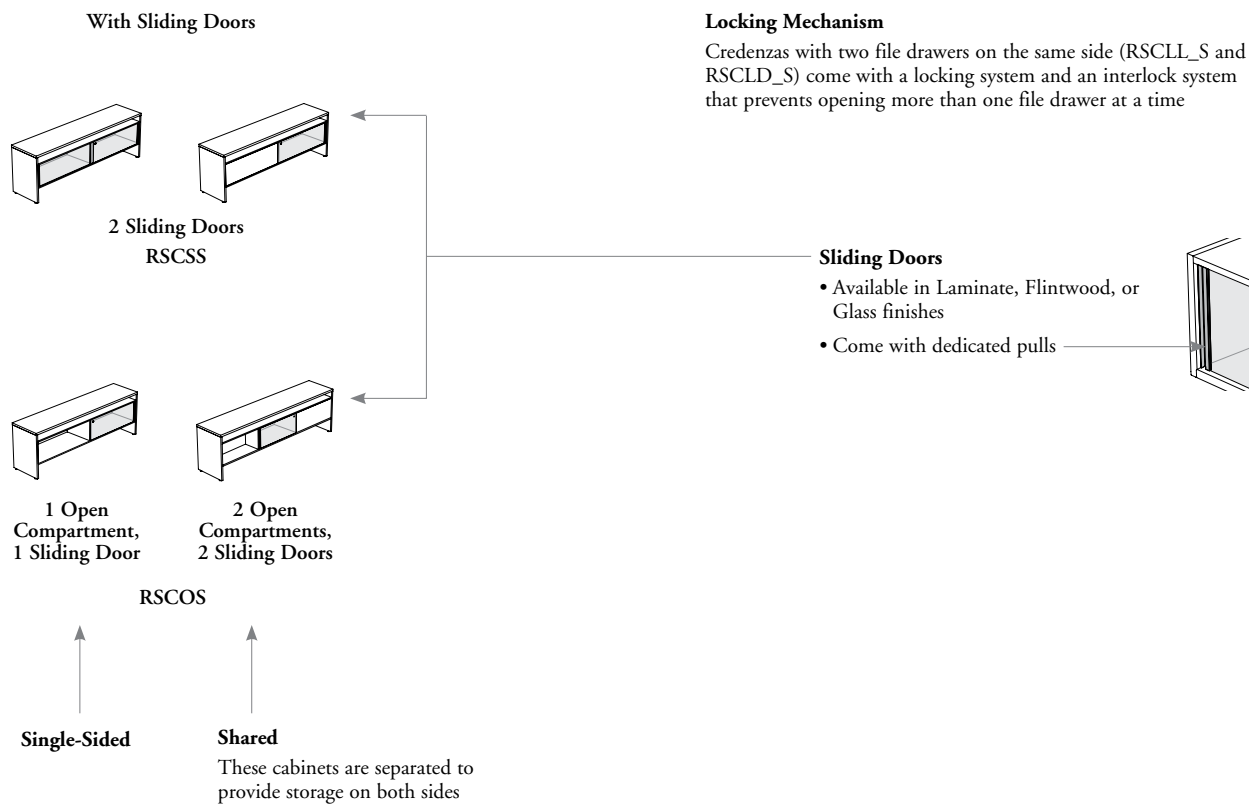
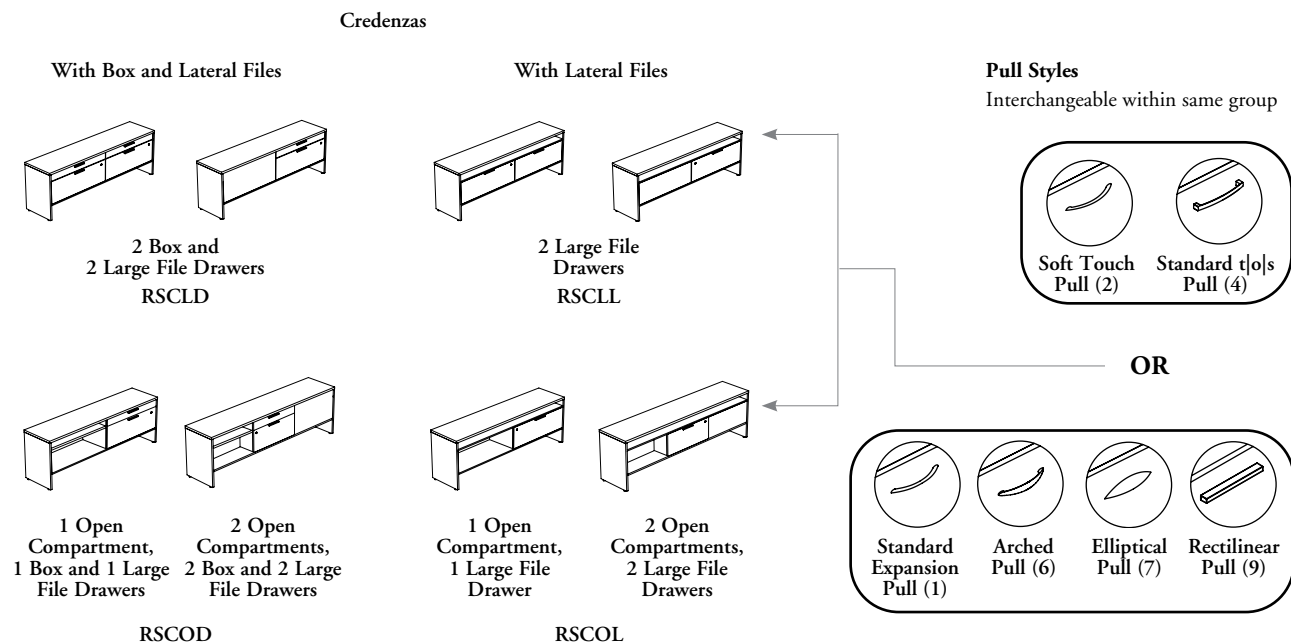

credenza basics (continued)

credenza configurations & open compartment heights

Credenzas (Single-Sided)

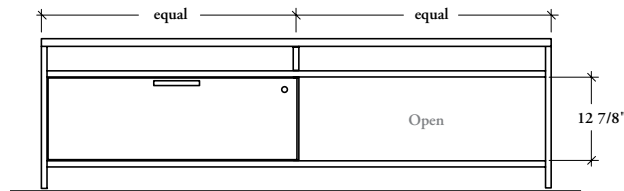

Credenzas (Shared)

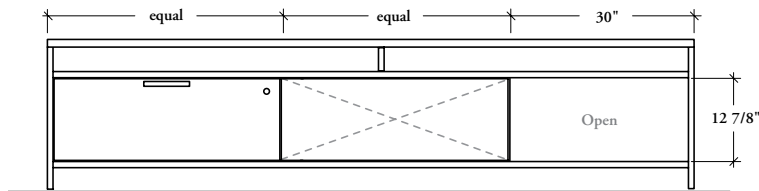

credenza filing drawer capacities

Lateral file drawer storage capacities are shown below.

⚠ The dimensions listed below are inside drawer

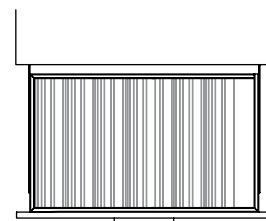
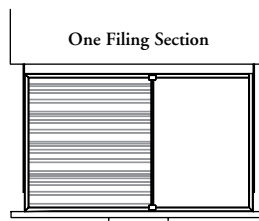

Front-to-Back

Side-to-Side

16" wide drawer

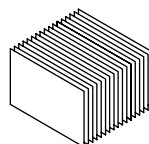
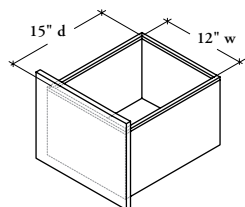

Paper Sizes Allowed:

- Letter
- A4

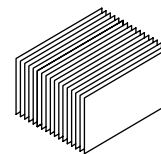

Paper Sizes Allowed:

- Letter
- A4
- Legal

18" wide drawer

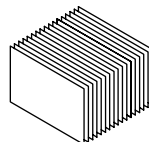
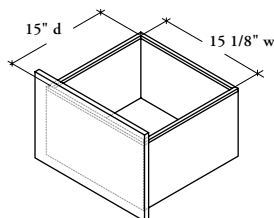

Paper Sizes Allowed:

- Letter
- A4
- Legal

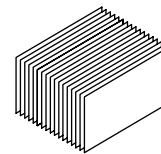

Paper Sizes Allowed:

- Letter
- A4
- Legal

21" or 27" wide drawers

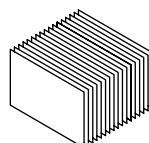
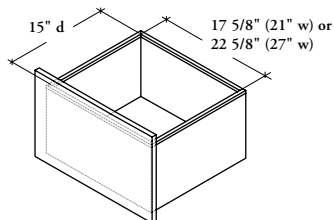

Paper Sizes Allowed:

- Letter
- A4
- Legal

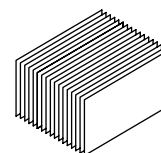

Paper Size Allowed:

- Legal

24" wide drawer

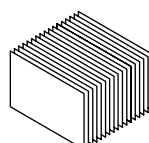
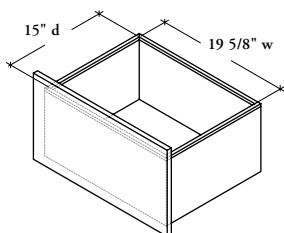

Paper Sizes Allowed:

- Letter
- A4
- Legal

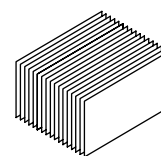

Paper Sizes Allowed:

- Letter*
- A4*
- Legal

credenza filing drawer capacities (continued)

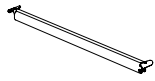

* The Letter or A4 paper size is allowed but require optional Hanging File Bar (RSLB)

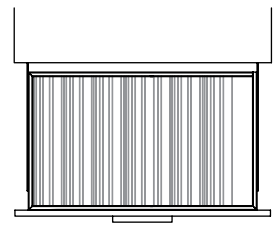
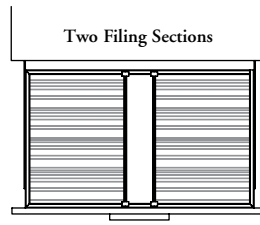
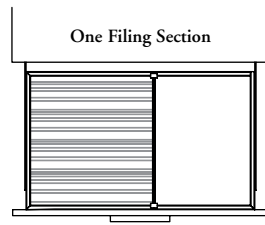

Front-to-Back

Front-to-Back

Side-to-Side

30" wide drawer

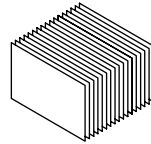
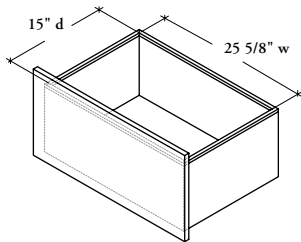

Paper Sizes Allowed:

- A4
- Legal

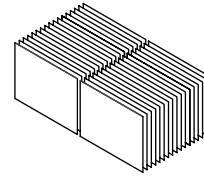

Paper Size Allowed:

- Letter

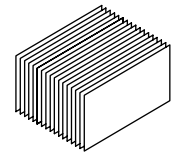

Paper Sizes Allowed:

- Letter*
- A4*
- Legal

33" wide drawer

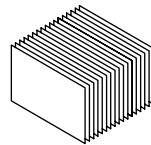
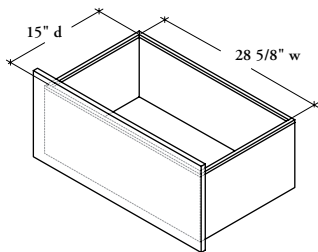

Paper Size Allowed:

- Legal

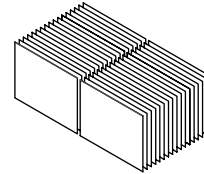

Paper Sizes Allowed:

- Letter
- A4

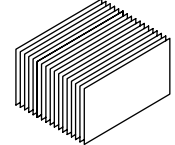

Paper Size Allowed:

- Legal

36" wide drawer

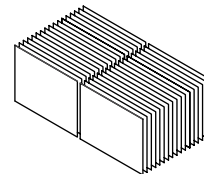
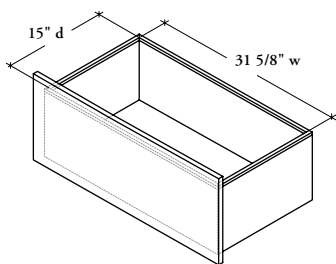

Paper Sizes Allowed:

- Letter
- A4
- Legal

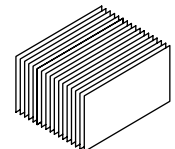

Paper Sizes Allowed:

- Letter*
- A4*
- Legal

39" or 42" wide drawers

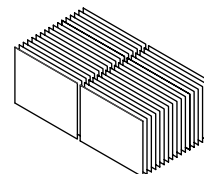
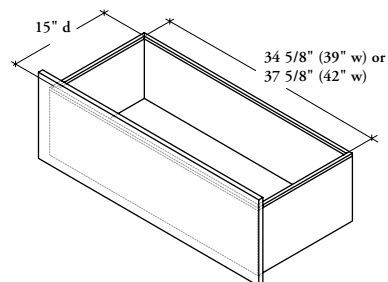

Paper Sizes Allowed:

- Letter
- A4
- Legal

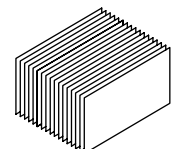

Paper Size Allowed:

- Legal

23" high freestanding credenza configurations

Information on this page should be considered when planning with 23" high Freestanding Credenzas and Worksurface Drawer Support.

- ❗ Can be used standalone or below Rectangular Worksurfaces (RTLDDL or RTLDC), using worksurface support (RSMD) with flush plate support style (F)
- It is recommended to position an open compartment below the desk. Otherwise, please ensure that appropriate clearance (drawer or door) is given to this compartment

Worksurface Support Depth Chart

Worksurface Depth		
20"	24"	30"
18"	18"	24"

single-sided standalone

Can also be installed below a Modular Desk or a Spine Desk, but always without worksurface support

Modular Desk Applications

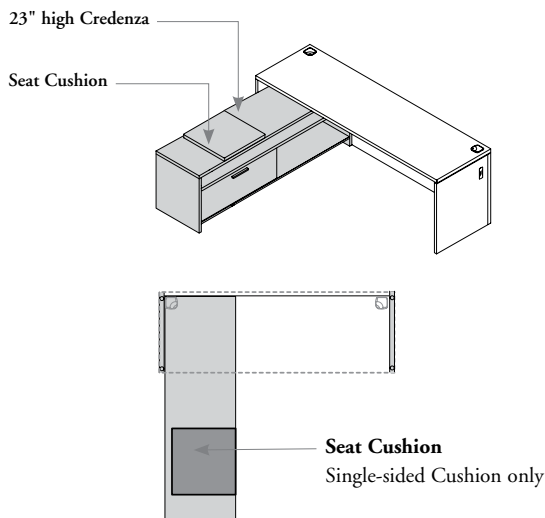

Spine Desk Applications

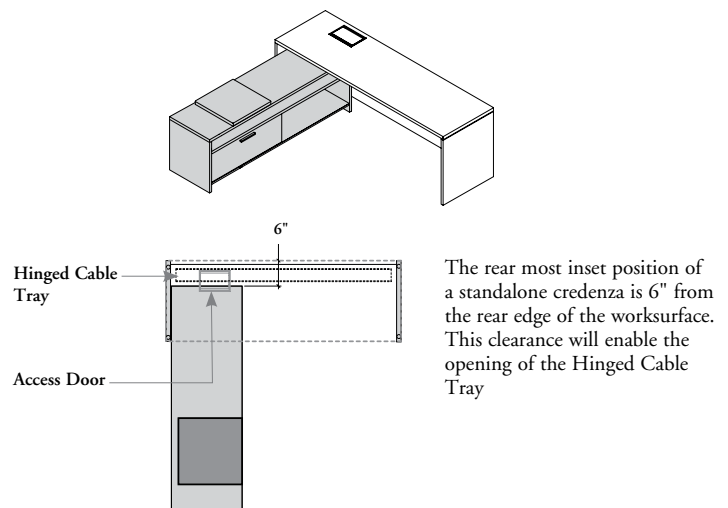

single-sided side access

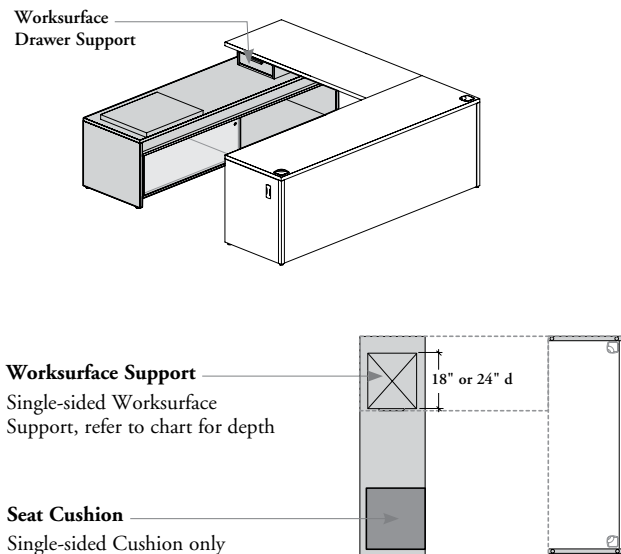

- This credenza can be used to support one end of a desk or a worksurface
- The storage support style (S) must be specified with the Rectangular Worksurfaces
- Must be installed with a worksurface support (RSMD) and hardware **not** included with desk and can be specified separately

23" high freestanding credenza configurations (continued)

shared front access

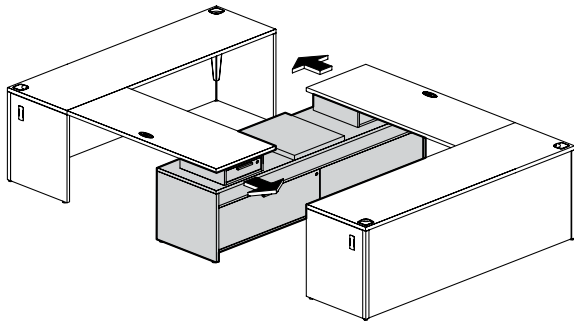

shared side access

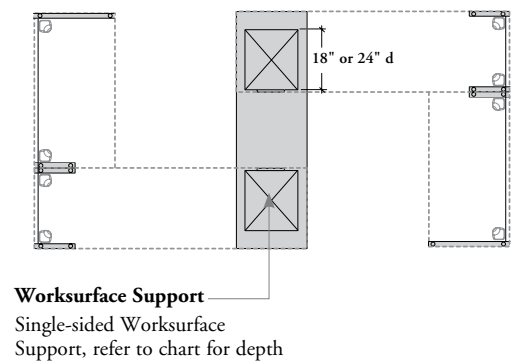
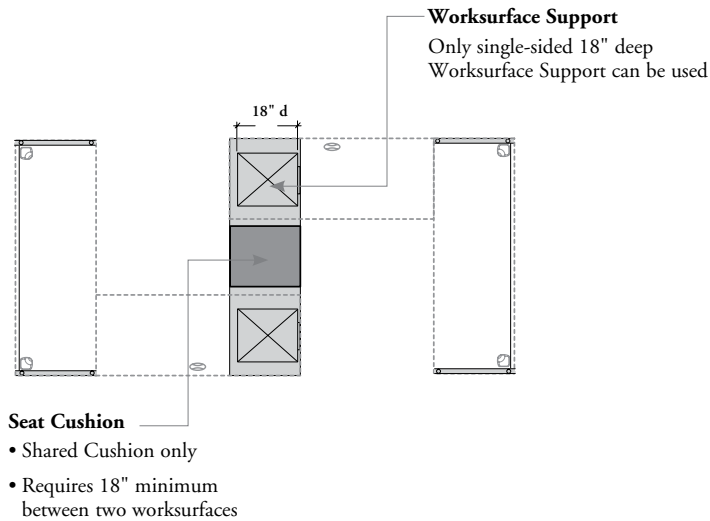
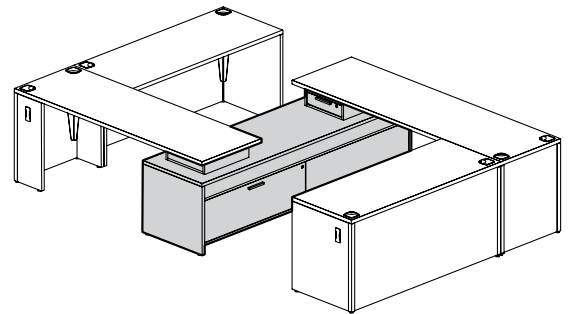

23" high freestanding credenza configurations (continued)

other applications

Between Two Rectangular Worksurfaces

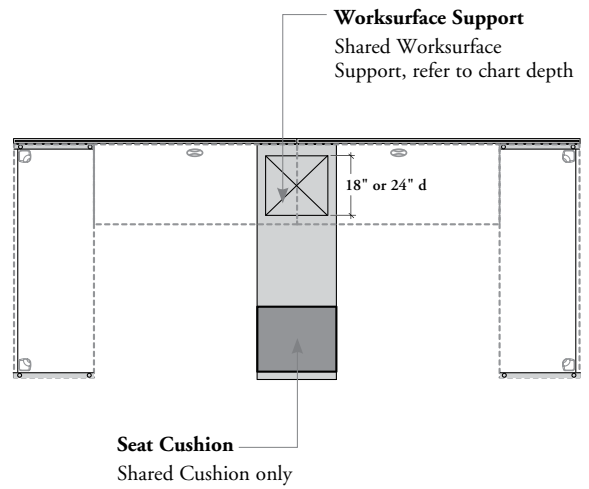
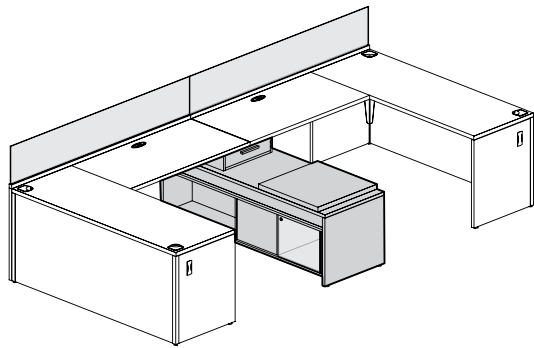

Junction of two Modular or Spine Desks with Half Gables

Cannot be installed under 20" deep desks

Modular Desk Applications

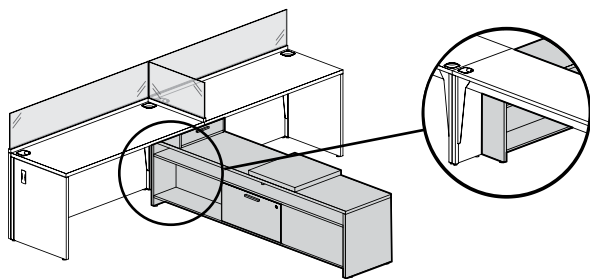

Spine Desk Applications

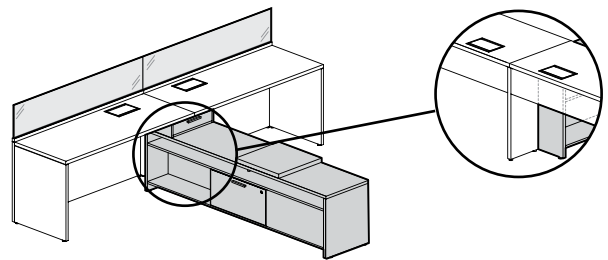

29" high freestanding credenza configurations

Information on this page should be considered when planning with 29" high Freestanding Credenzas.

- Can be used standalone or attached flush-front to a Rectangular Worksurface (RTLDDL or RLTDCC), using linking plates
- It is recommended to position an open compartment or drawer back panel below the desk. Otherwise, ensure that appropriate clearance (drawer or door) is given to this compartment
- **Cannot** be used with a Seat Cushion

single-sided standalone

Can also be installed next to the front of a Modular or Spine Desk

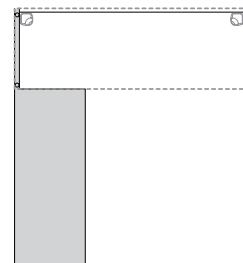
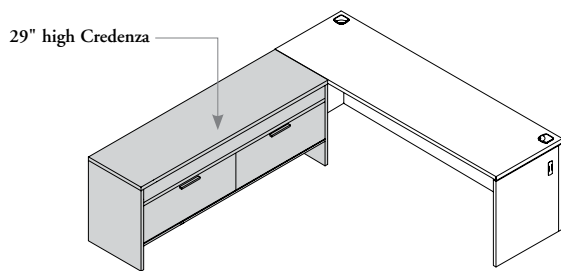

single-sided flush-front configuration

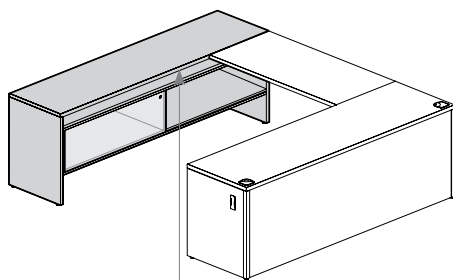

Worksurface must be attached above open compartment, **not** compatible above box drawer

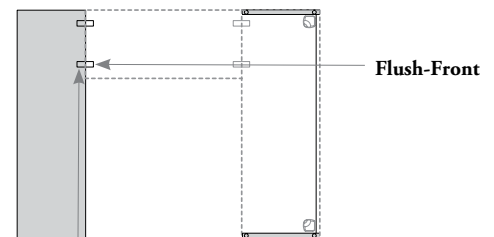

Linking Plates
Must be connected with Linking Plates

- This credenza can be used to link one end of a worksurface to a desk
- The flush plate support style (F) must be specified on the Rectangular Worksurfaces

29" high freestanding credenza configurations (continued)

shared flush-front configurations

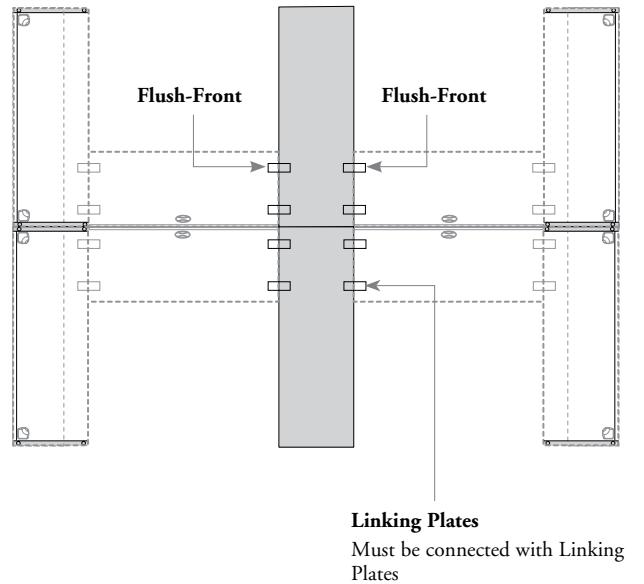
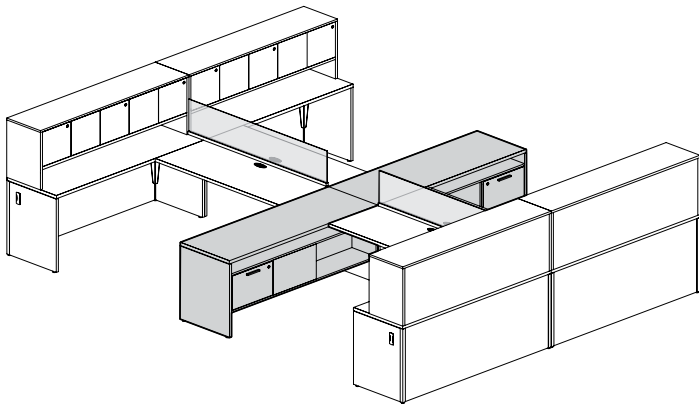
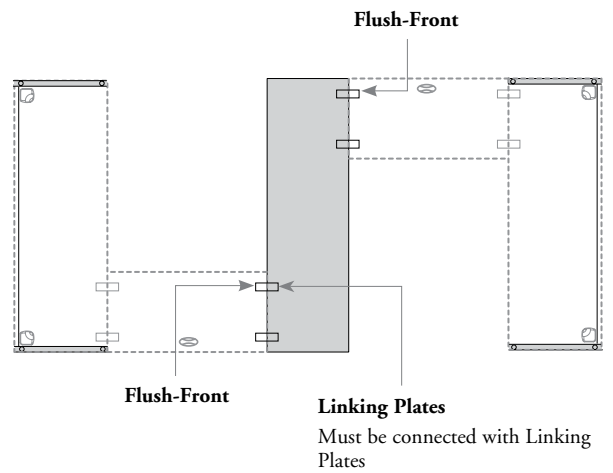
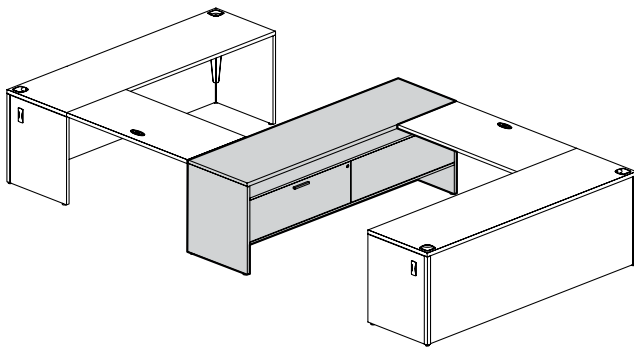

grommet & cable pass-through applications

Information on this page should be considered when planning with Grommets or Cable Pass-Through vs Credenzas.

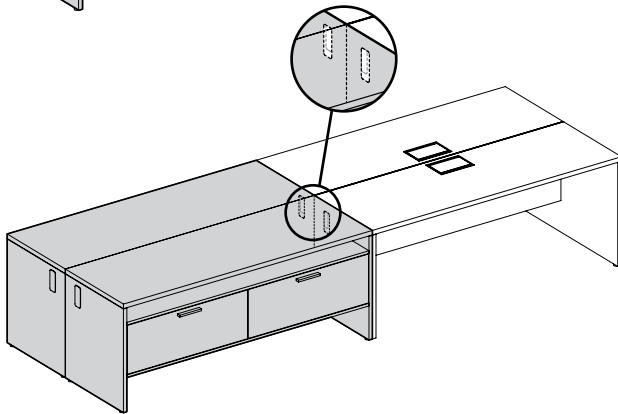
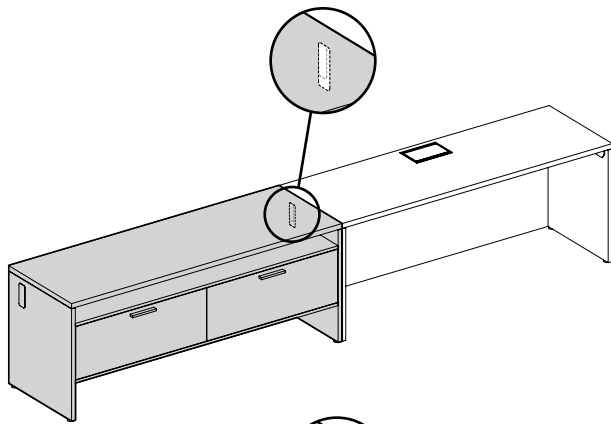

Cable Pass-Through are positioned vertically on single-sided 24" deep credenzas. They will match with gable grommets of Modular and Spine Desks

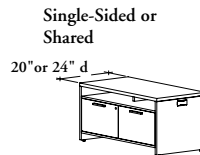

23" high Credenzas

Grommets are available in a horizontal position only

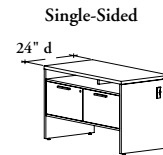

29" high Credenzas

- Grommets are positioned vertically on single-sided 24" deep credenzas to match the Modular Desk

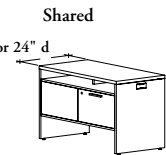

- In shared 20" or 24" deep credenzas, grommets are positioned horizontally only

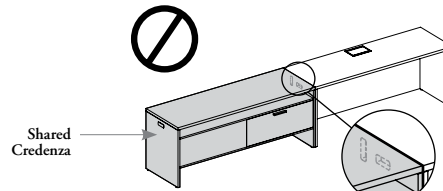

Shared credenza grommet position will **not** align with any desk gable grommet

Wire Management Clips (underneath worksurface)

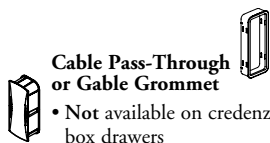
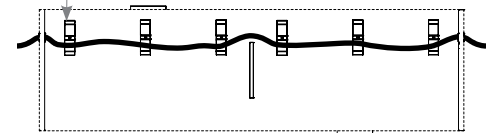

Cable Pass-Through or Gable Grommet

- Not available on credenzas with box drawers
- Credenzas can be specified with factory-made grommet or cable pass-through cut outs
- Provide openings for electrical wiring and communication cables on both sides of the credenza through pigeonhole
- Gable Grommet includes plastic ring and cover
- Cable Pass-Through Ring is made in plastic, but a Metal Cable Pass-Through (RAWPC) is **not** included and can be specified separately

- Three Cable Pass-Through/Grommet styles are available:
 - With Grommet (G) (Gable Grommet)
 - No Grommet/Pass-Through (N)
 - With Pass-Through (P)
- see chart below for detailed offering

	23" high Single-Sided Credenza		23" high Shared Credenza		29" high Single-Sided Credenza		29" high Shared Credenza	
	Credenza Depth							
	20"	24"	20"	24"	20"	24"	20"	24"
With Grommet (G)	Yes	Yes	Yes	Yes	n/a	Yes	n/a	Yes
No Grommet/Pass-Through (N)	Yes	Yes	Yes	Yes	Yes	Yes	Yes	Yes
With Pass-Through (P)	n/a	n/a	n/a	n/a	n/a	Yes *	n/a	n/a

* When a 24" deep credenza is specified beside a Spine Desk (Single-Sided or Shared), a Cable Pass-Through must be specified on the credenza if wires are to be routed through the credenza

credenza product offering

- ❗ • Nominal depths and widths are also actual dimensions for credenzas. This page provides actual dimensions in all cases
- For a list of available dimension combinations, refer to pricing tables in the price guide or specification software

Freestanding Credenza – Box/File Drawers (RSCLD)

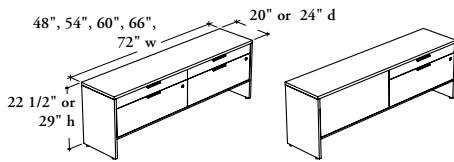

2 box drawers,
2 large file drawers

Freestanding Credenza – Open with Box/File Drawers (RSCOD)

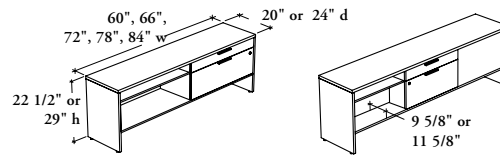

1 open compartment,
1 box drawer,
1 large file drawer

2 open compartments,
2 box drawers,
2 large file drawers

Freestanding Credenza – Lateral Files (RSCLL)

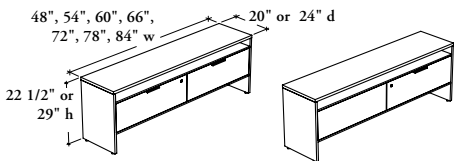

2 large file drawers

Freestanding Credenza – Open with Lateral Files (RSCOL)

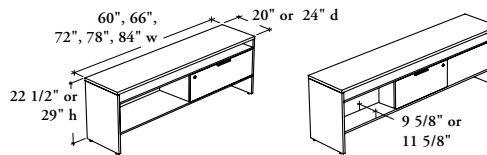

1 open compartment,
1 large file drawer

2 open compartments,
2 large file drawers

Freestanding Credenza – Sliding Doors (RSCSS)

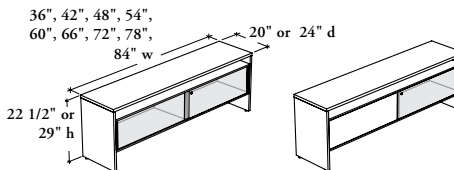

2 sliding doors

Freestanding Credenza – Open with Sliding Doors (RSCOS)

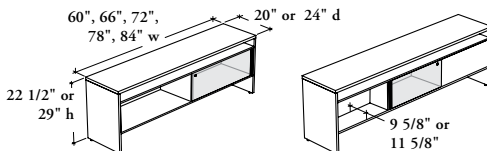

1 open compartment,
1 sliding door





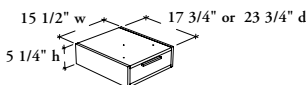





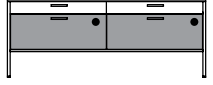

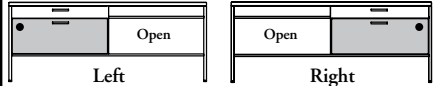

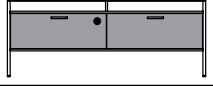

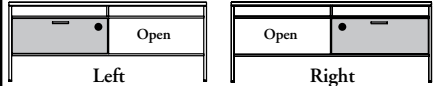

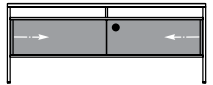

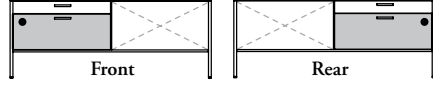

2 open compartments,
2 sliding doors

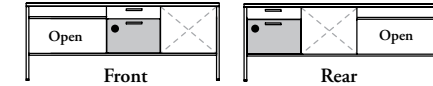
Worksurface Drawer Support – Low Credenza (RSMD)

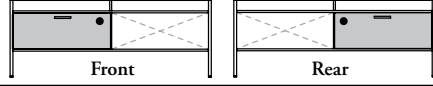

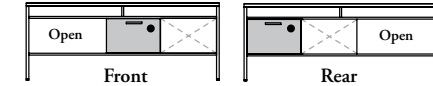
1 pencil drawer

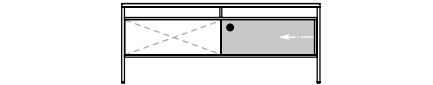
credenza lock chart

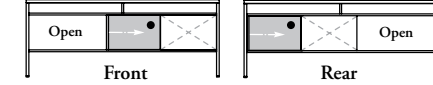
product code and description		credenza	
 RSCLD (Single-Sided)	Box/File Drawer Configurations		
	Compartments	0	
	Locks	2	
 RSCOD (Single-Sided)	Box/File Drawer Configurations		
	Compartments	2	
	Locks	1	
 RSCLL (Single-Sided)	Lateral File Drawer Configurations		
	Compartments	2	
	Locks	1	
 RSCOL (Single-Sided)	Lateral File Drawer Configurations		
	Compartments	2	
	Locks	1	
 RSCSS (Single-Sided)	Lateral File Drawer Configurations		
	Compartments	2	
	Locks	1	
 RSCOS (Single-Sided)	Lateral File Drawer Configurations		
	Compartments	2	
	Locks	1	
 RSCLD (Shared)			
	Compartments	0	
	Locks	2	
 RSCOD (Shared)			
	Compartments	4	
	Locks	2	
 RSCLL (Shared)			
	Compartments	2	
	Locks	2	
 RSCOL (Shared)			
	Compartments	4	
	Locks	2	
 RSCSS (Shared)			
	Compartments	2	
	Locks	2	
 RSCOS (Shared)			
	Compartments	4	
	Locks	2	

Lockable Double Drawer/Door
 Lockable Single Drawer/Door
 Not Lockable

credenza finishes

⚠ All Laminate components are protected with a solid plastic edge

Solid Sliding Doors

Available in Source Laminate colors or Flintwood (No Cathedral)

Glass Sliding Doors

Available in 5/32" (4 mm) Standard or Back-Painted tempered glass:

Standard Glass Finishes:

- Clear (CL)
- Frosted (FT) is a single-sided etched tempered glass which is facing inward of credenza

Drawer Front and Back

Available in Source Laminate colors or Flintwood (No Cathedral)

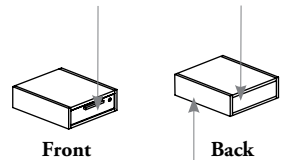

Laminate Case and Gables

Available in Source Laminate colors

Grommets

- Available in Source Laminate colors
- Are finished to match the gable

Levelers
Finished in Black

Seat Cushion

Available in Teknion Standard Seating Fabrics

Hardware

Available in Foundation, Accent or Mica colors

Credenza Top

Available in Source Laminate (23" high), Foundation Laminate colors or Flintwood (No Cathedral) (29" high)

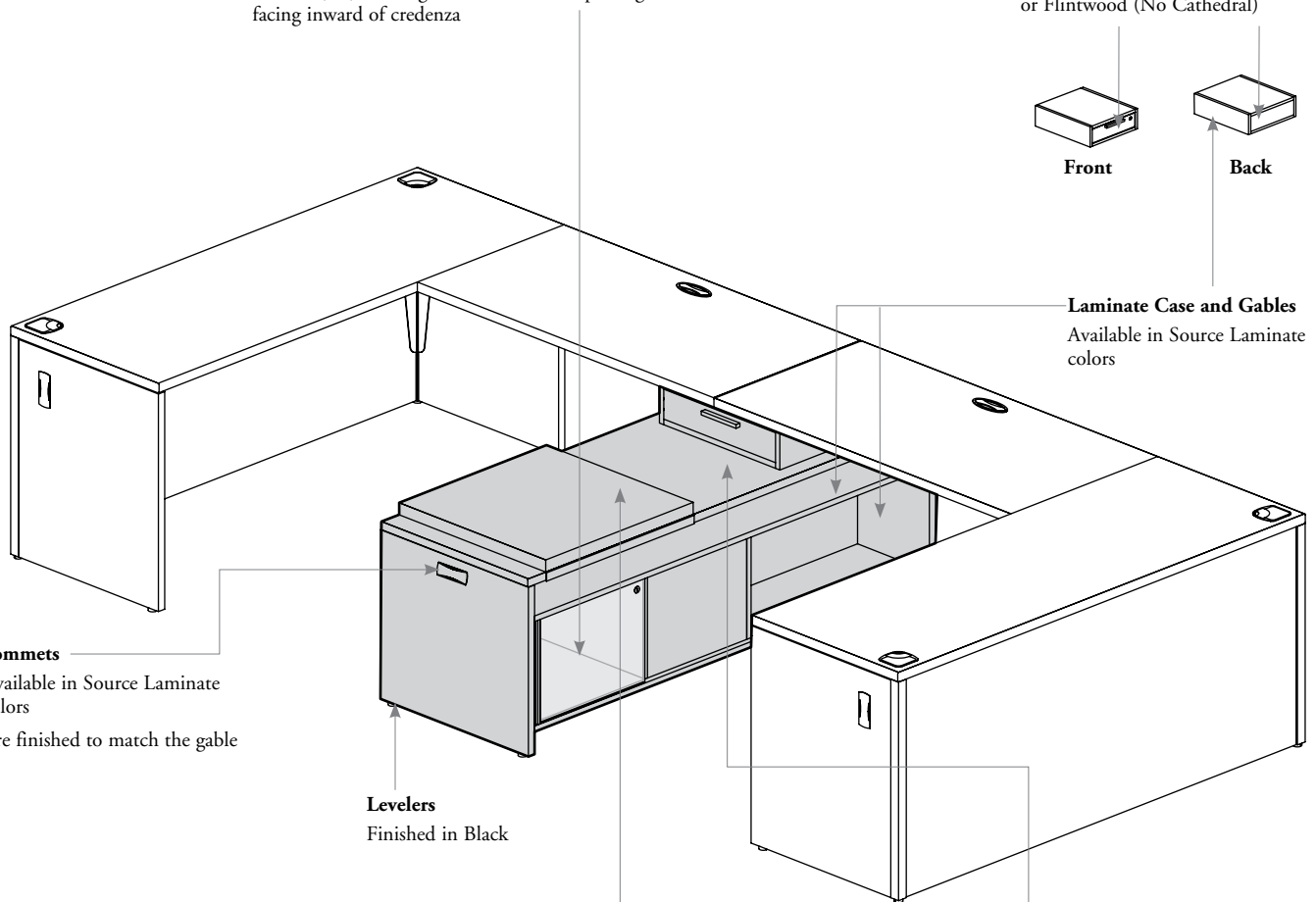

credenza finishes (continued)

Edge Trims

- Available in Straight Trim (6) or Flintwood Flat Trim (9) (29" high)
- Edge Trim colors are available in Straight Trim (6) only
- Flintwood Flat Trim is only available on Flintwood worksurfaces. Edge trims will be finished to match the Flintwood worksurface
- Straight Trim is **not** available on Source Laminate and Flintwood worksurfaces

Locks and Keys

Available in brushed chrome finish only

Cable Pass-Through Ring
Available in a Platinum Coordinate

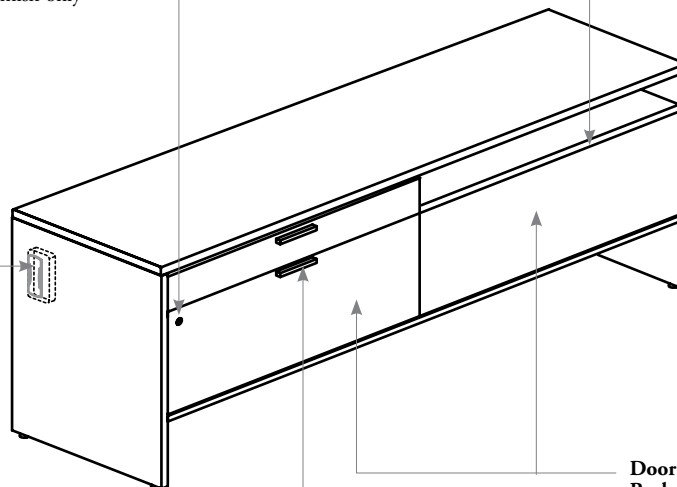

Pulls

- Available in Foundation, Accent or Mica colors
- Soft Touch (2) and Standard (4) pulls are only available in limited Foundation colors. Refer to the specification software for details

Door or Drawer Front and Back

- Available in Source Laminate colors or Flintwood (No Cathedral)
- Edge Trim colors are available with laminate door or drawer front only

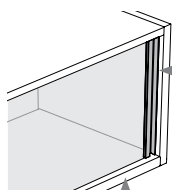

Sliding Door Pulls

Available in Foundation or Mica colors

Sliding Rails

Available in Foundation or Mica colors

credenza grain direction / user edge

Attention to grain/pattern direction is important when planning credenzas. The following examples demonstrate this.

- ❗ • Worksurface user edge is indicated with a shaded line
- Grain/patterns are **not** "centered" on storage units
- Includes Source or Foundation Laminate (Standard, Finegrain and Straightgrain)



RSCLL, RSCOL, RSCSS or RSCOS

Drawer and door fronts grain direction will vary depending on finish selected

Horizontal Grain Direction for colors listed below:

- 3A – 3B – 3C – 3D – 3E – 3L – 3M – 3X – XQ – XR
Source Laminate
- 2A – 2B – 2C – 2D – 2E – 2L – 2M – 2X – RQ – YR
Foundation Laminate

OR

Vertical Grain Direction for colors listed below:

- 3F – 3J – 3K – 3N – 3P – XJ – XK
Source Laminate
- 2F – 2J – 2K – 2N – 2P – JG – RN
Foundation Laminate
- FC – FD – FM – FN – FX – NR – NT –
VA – VB – VZ – 5N – 5P – 5Q – 5R – 5S –
5T – 5V – 5W – 5Z
Flintwood (No Cathedral)

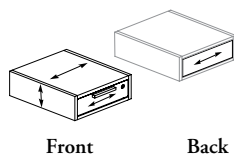
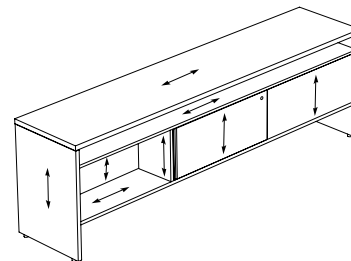
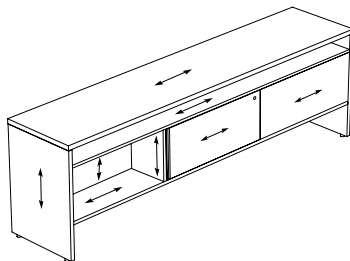
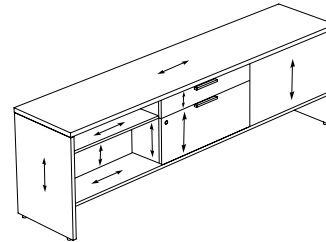
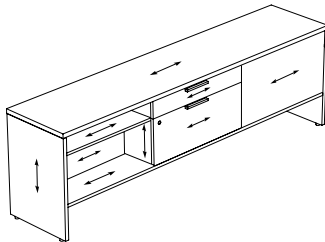

Front Back

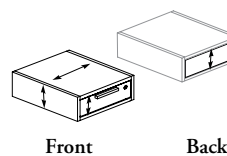

Front Back

freestanding storage &
accessories

freestanding storage & accessories

FREESTANDING STORAGE BASICS	140
LAMINATE FREESTANDING STORAGE – FILING DRAWER CAPACITIES	148
METAL FREESTANDING STORAGE – FILING DRAWER CAPACITIES	149
FREESTANDING STORAGE INSIDE CLEARANCE	150
MARKERBOARD – FREESTANDING STORAGE MOUNTED BASICS . . .	152
FREESTANDING STORAGE COMPATIBILITY	154
FREESTANDING STORAGE LOCK CHART	155
FREESTANDING STORAGE PRODUCT OFFERING	156
FREESTANDING STORAGE ACCESSORIES	158
FREESTANDING STORAGE FINISHES	160
FREESTANDING STORAGE GRAIN DIRECTION	162

freestanding storage basics

Freestanding Storage is an extensive storage system that responds to a variety of information management needs whether personal, group, team or archival. Freestanding Storage is equally proficient in private office or shared workstation settings and as a standalone storage solution.

- ❗ • All storage dimensions listed are nominal
- Most closed storage products come with a lock and key set and can be keyed alike or randomly
- All Freestanding Storage products include levelers with a minimum adjustment range of 1"
- Come with a central locking system and full extension drawers that can accommodate both letter- and legal-size paper
- Storage and desk must be carefully specified to fit together. Refer to the Compatibility Chart on page 154

Pedestals

- Types of stationary pedestals:
 - 1 box drawer + 1 file drawer (suspended)
 - 2 box drawers + 1 file drawer
 - 2 file drawers
 - 2 box drawers + 2 file drawers
- Mobile Pedestal with Seat (RBTPS)
 - 1 box drawer + 1 file drawer
- Available with either:
 - laminate or metal case
 - laminate, Flintwood, or metal drawer fronts
- Can be specified with levelers or casters (standard pedestal only)
- Casters are lockable on laminate pedestal only
- Only metal pedestals specified with counterweights do **not** have to be located directly under a worksurface; counterweights are included with mobile metal pedestals

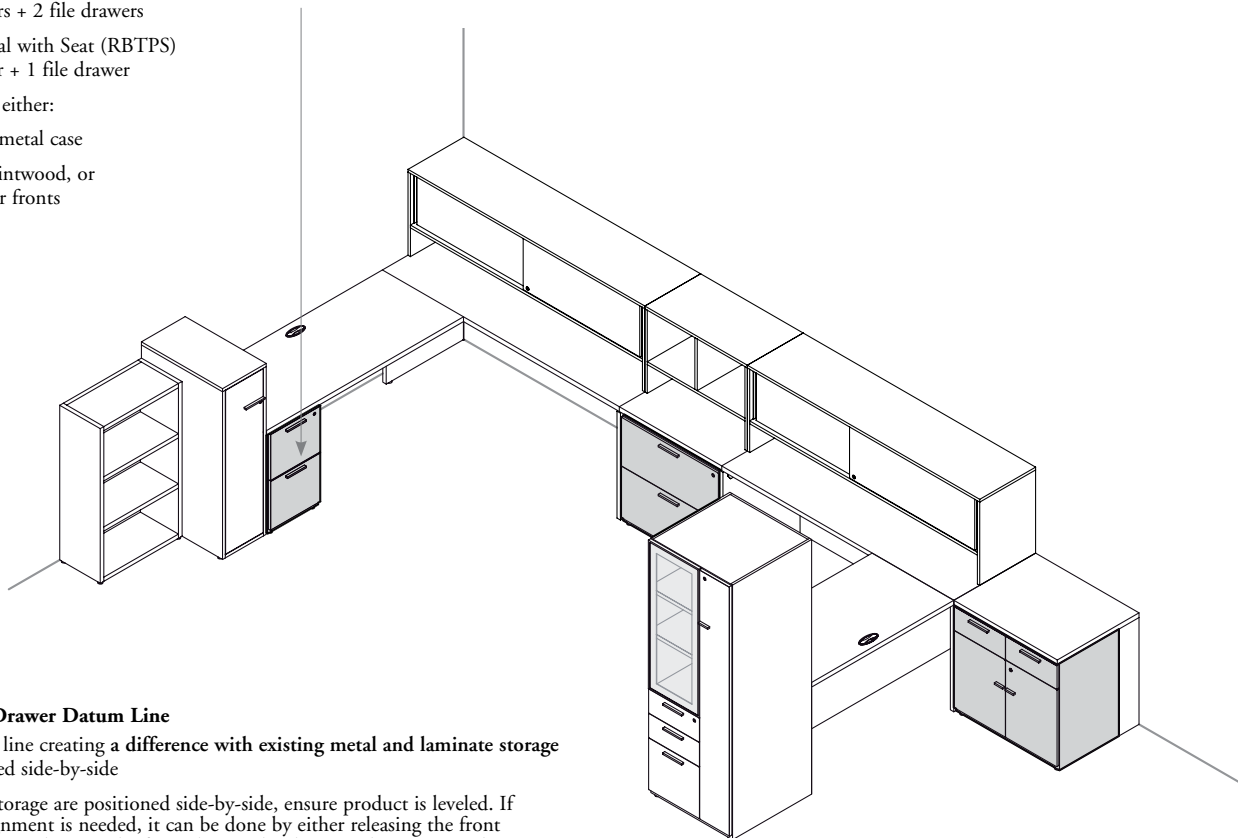

Metal Storage Drawer Datum Line

- Drawer datum line creating a difference with existing metal and laminate storage when positioned side-by-side
- When Metal Storage are positioned side-by-side, ensure product is leveled. If front/door alignment is needed, it can be done by either releasing the front mounting screws, adjusting the front/door and tightening the screws, or by using hinge adjustments to ensure an equal gap

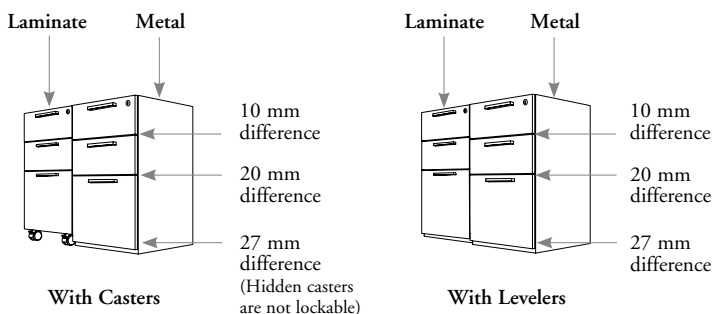

freestanding storage basics (continued)

- ❗ • 28" high storage with drawers must be installed under a desk; other 28" high storage can be installed under a desk or fitted with a top (RSNRT or RSRT)
- All 28" high storage can be used to support one end of a semi-supported desk or worksurface, using the Supported Pedestal Kit (included with desk) to maintain stability

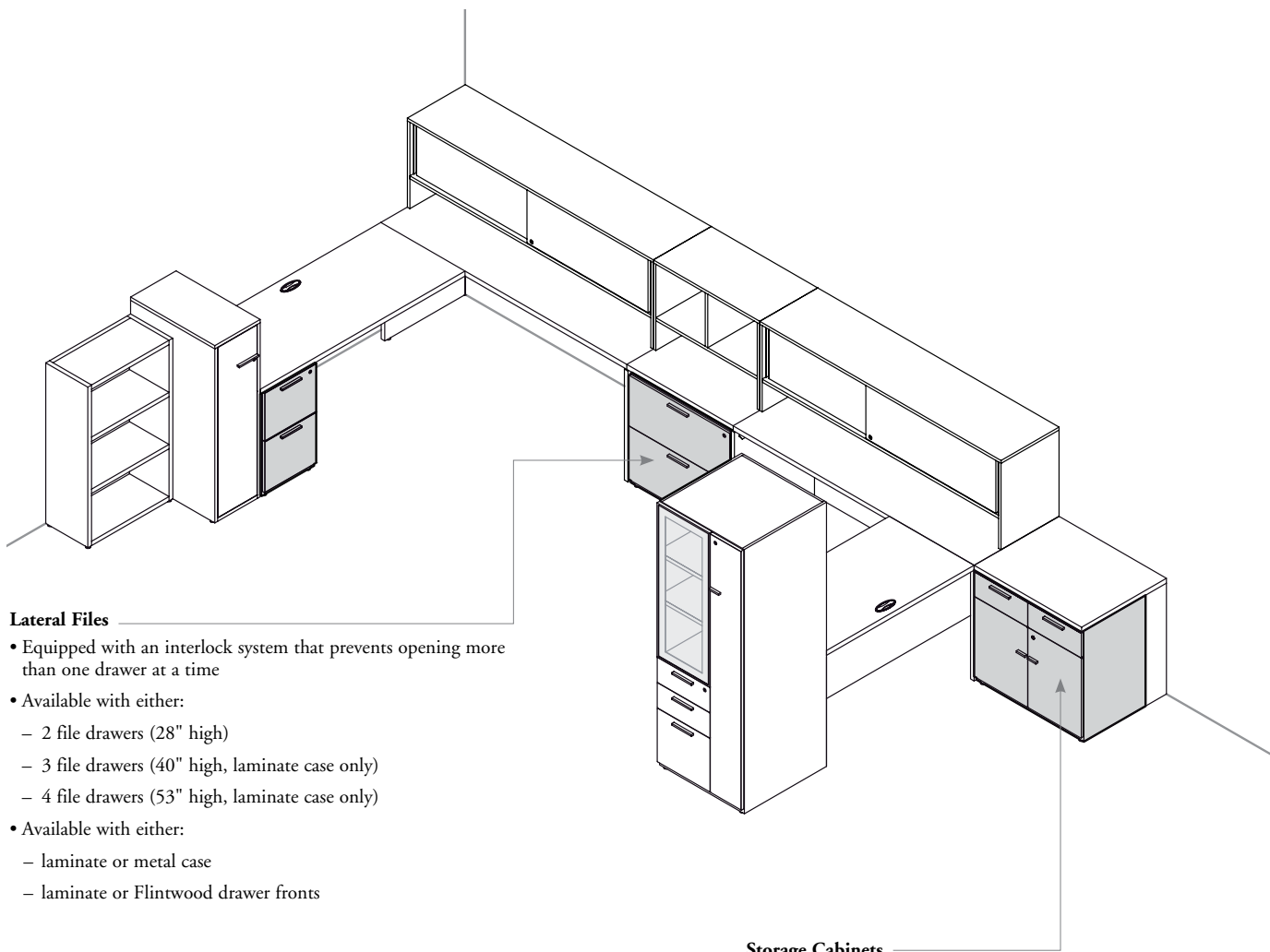

Lateral Files

- Equipped with an interlock system that prevents opening more than one drawer at a time
- Available with either:
 - 2 file drawers (28" high)
 - 3 file drawers (40" high, laminate case only)
 - 4 file drawers (53" high, laminate case only)
- Available with either:
 - laminate or metal case
 - laminate or Flintwood drawer fronts

Storage Cabinets

- Offered with or without drawers
- Additional shelves (RSHE) can be specified separately
- Box drawers are **not** lockable

freestanding storage basics (continued)

- ❗ Storage higher than 28" can also be used to support one end of a semi-supported desk or worksurface, using the Hang-On Kit (included with desk) to maintain stability

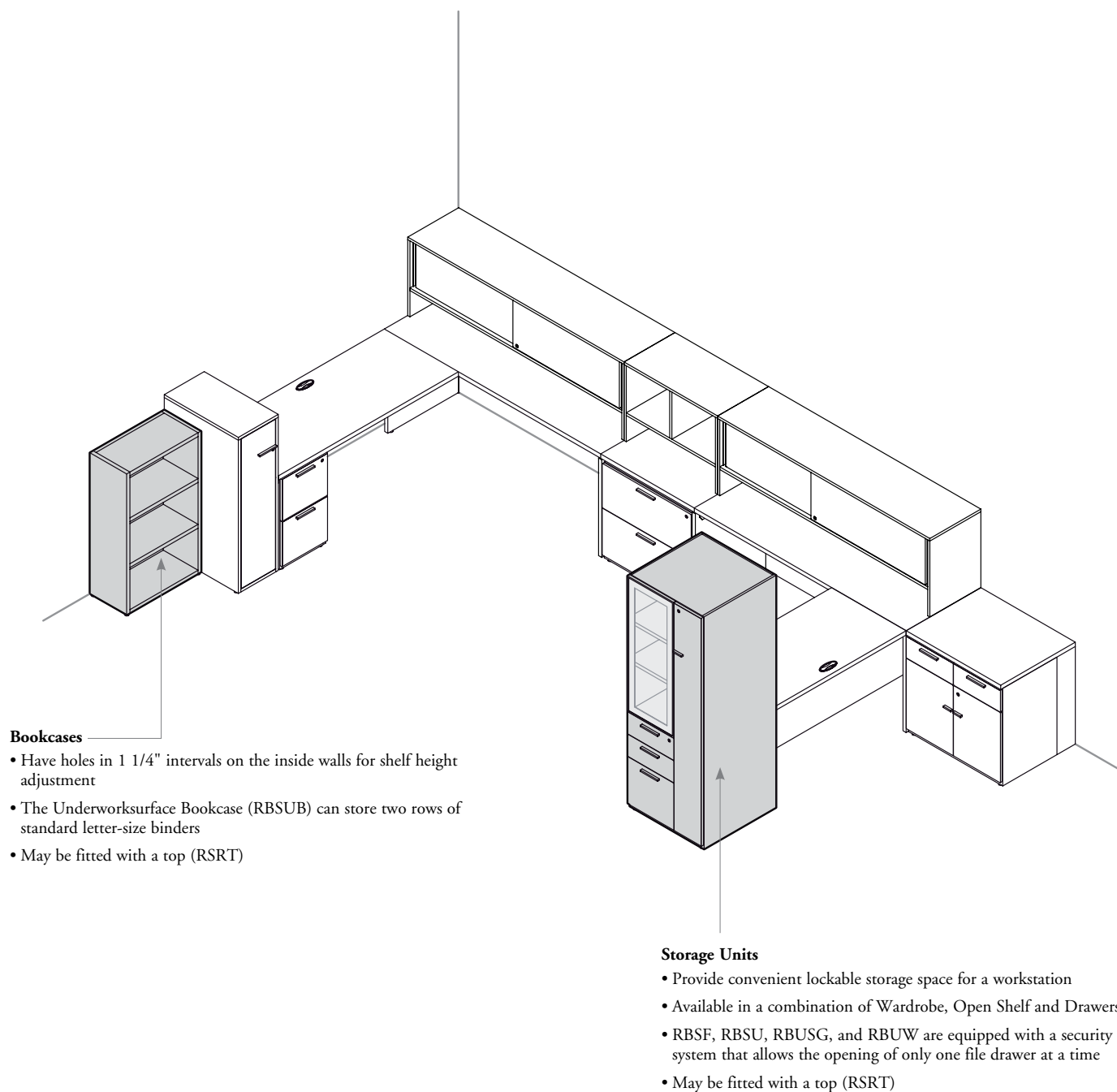

freestanding storage basics (continued)

The following illustrates Expansion Desking Storage Units door & drawer nominal widths.

storage units – door & drawer widths

Half Wardrobe Filing Cabinet (RBSF)

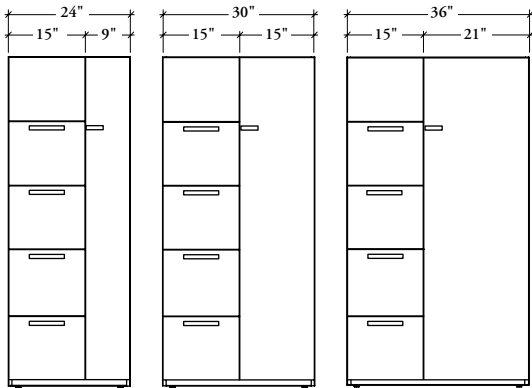

- The 24" to 36" wide half wardrobe filing cabinets are complete with 15" wide file drawers and have one door on the secured storage section
- The 24" wide cabinet has a 9" wide wardrobe, the 30" wide cabinet has a 15" wide wardrobe and the 36" wide cabinet has a 21" wide wardrobe

Half Wardrobe Unit with Drawers – Open Shelves (RBSCO6612) (Shown) or (RBSCO1212)

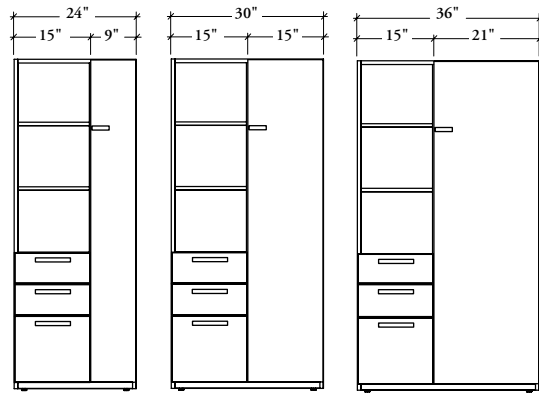

- The 24" to 36" wide half wardrobe units are complete with 15" wide pedestal and no door on open shelves section
- The 24" wide cabinet has a 9" wide wardrobe, the 30" wide cabinet has a 15" wide wardrobe and the 36" wide cabinet has a 21" wide wardrobe

Half Wardrobe Unit with Drawers – Solid Doors (RBSCCL6612) (Shown) or (RBSCCL1212), Half Wardrobe Unit with Drawers – Glass Doors (RBCGB) or (RBCGF)

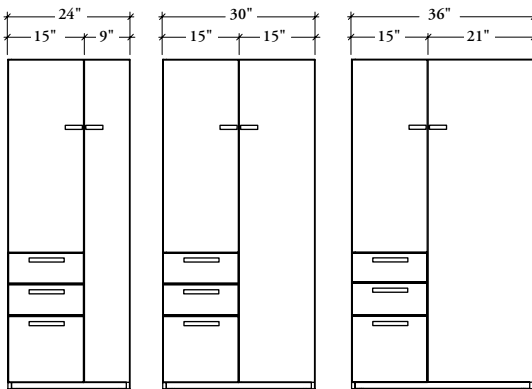

- The 24" to 36" wide half wardrobe units are complete with 15" wide pedestal and have one door on the secured storage section
- The 24" wide cabinet has a 9" wide wardrobe, the 30" wide cabinet has a 15" wide wardrobe and the 36" wide cabinet has a 21" wide wardrobe

Storage Unit with Wardrobe – Solid Doors (RBUW)

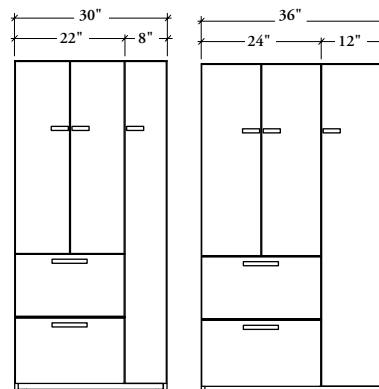

- The 30" wide storage unit has a 22" wide lateral file drawers and the 36" wide storage unit has a 24" wide lateral file drawers
- The 30" wide cabinet has an 8" wide wardrobe and the 36" wide cabinet has a 12" wide wardrobe

freestanding storage basics (continued)

Glass Doors

- Have **no** pull; a touch-latch on each door is installed for the opening
- Two finishes are available:
Standard or Back-Painted glass

Drawers

- All drawers have full extension slides
- File bars are included in each file drawer; quantity is indicated on individual product pages
- Box drawers include pencil tray and divider

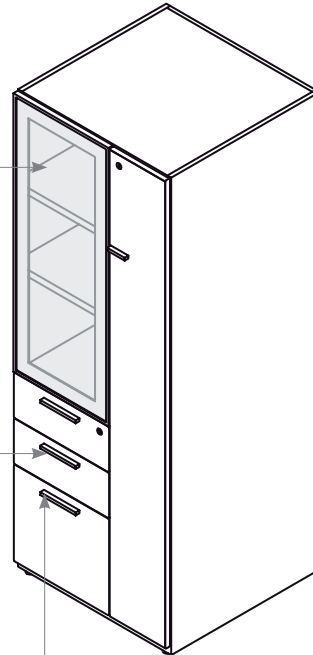

Pull Styles

- Interchangeable within same group
- Pull styles #2 and #4 are **not** available with metal case units

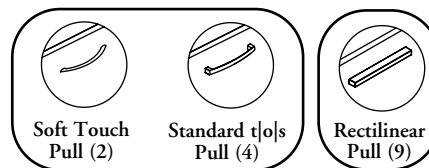

OR

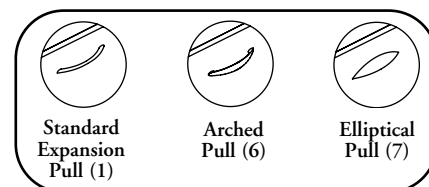

Cable Pass-Through

- Provide openings for electrical wiring and communication cables
- **Cannot** be specified on Freestanding Storage smaller than 24" deep
- Can only be specified with:
 - Supporting Towers (RBHAT or RBHSC)
 - Extended Supporting Towers (RBXT or RBXTC)
 - Stationary Pedestals (RBSPS)
 - Freestanding Towers (RBAT)
 - 28" high Lateral File (RBLF); for details, see individual product pages
- Metal Cable Pass-Through Covers (RAWPC) can be specified separately

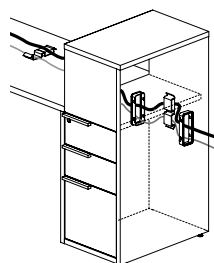

freestanding storage basics (continued)

- ❗ Supporting Storage must be used with a semi-supported desk or worksurface, using the Hang-On Kit (included with desk) to maintain stability
- 15 1/2" dimension must be used with odd widths of Rectangular Worksurfaces or Semi-Supported Desks to provide actual footprints in 6" increments

Supporting Storage

- Available in 29" to 66" heights
- Available in Box, Box, File (6612), File, File (1212), Wardrobe or Shelves configurations
- Must be specified left or right
- Upper section allows letter-size binders
- Rectilinear Pull (#9) is handed

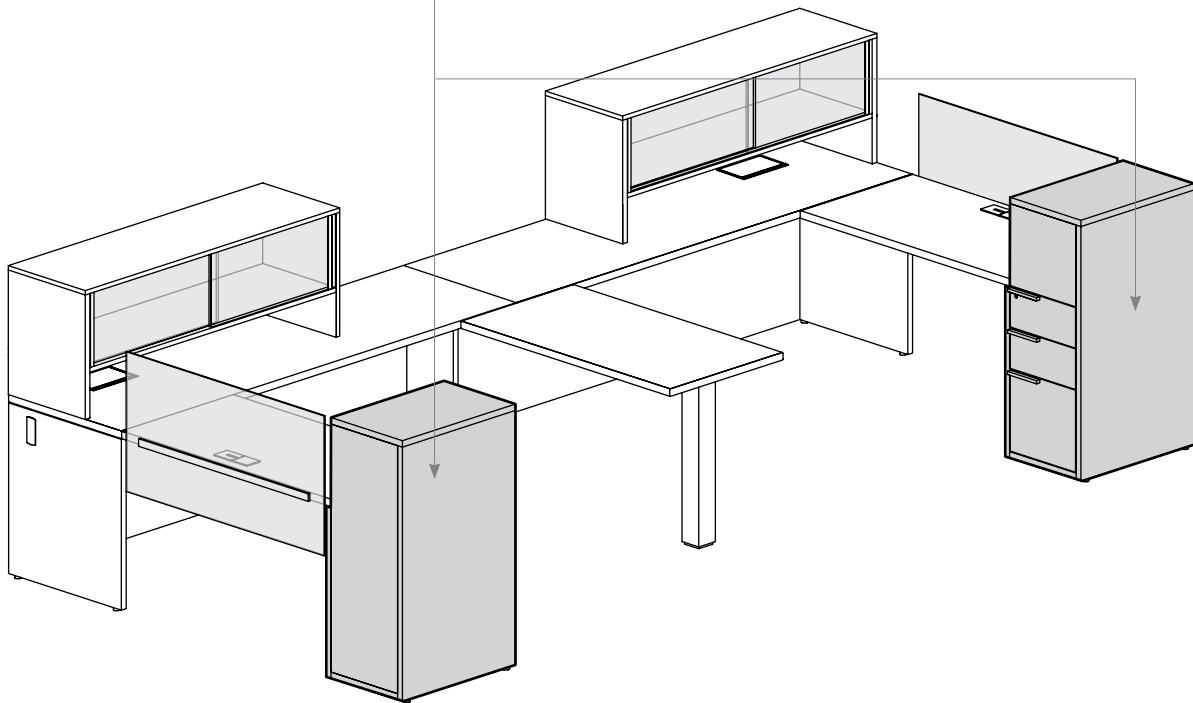
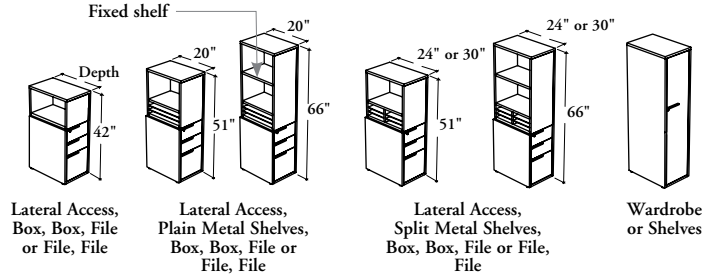

Also available:

Freestanding Tower with Lateral Access and Drawers (RBAT and RBATW)

- Available in 42", 51" and 66" heights
- Available in Box, Box, File (6612) or File, File (1212) configurations
- Must be specified left or right
- Upper section allows letter-size binders
- All pulls on drawers are centered
- Only RBATW comes with a wardrobe

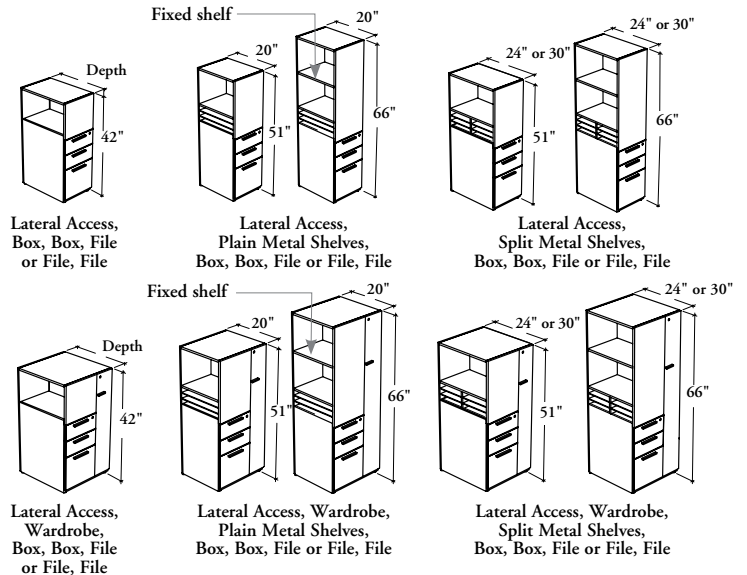

freestanding storage basics (continued)

Extended Supporting Tower with Drawers or Full Door (RBXT and RBXTC)

- Available in 42" and 51" heights
- Available with drawers and full door
- Must be specified left or right
- Upper and lower sections allows letter-size binders
- All pulls on drawers are centered
- **Not** all combinations are available; see individual product pages

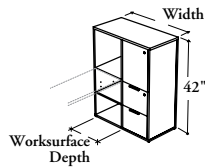

42" w X 24" wd or 48" w X 30" wd, Lateral Access, Door, File, File (Shown) or Box, Box, File

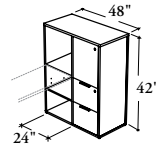

Lateral Access, Doors, File, File (Shown) or Box, Box, File

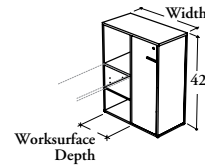

42" w X 24" wd or 48" w X 30" wd, Lateral Access, Full Door

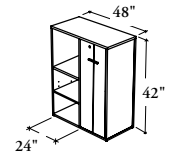

Lateral Access, Full Doors

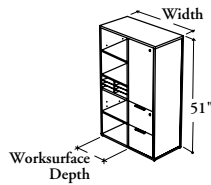

42" w X 24" wd or 48" w X 30" wd, Lateral Access, Door, Split Metal Shelves, File, File (Shown) or Box, Box, File

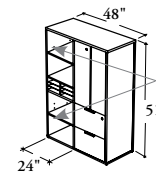

Lateral Access, Doors, Split Metal Shelves, File, File (Shown) or Box, Box, File

Adjustable Shelves

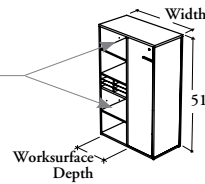

42" w X 24" wd or 48" w X 30" wd, Lateral Access, Full Door

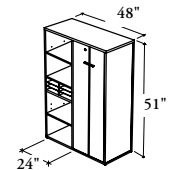

Lateral Access, Full Doors

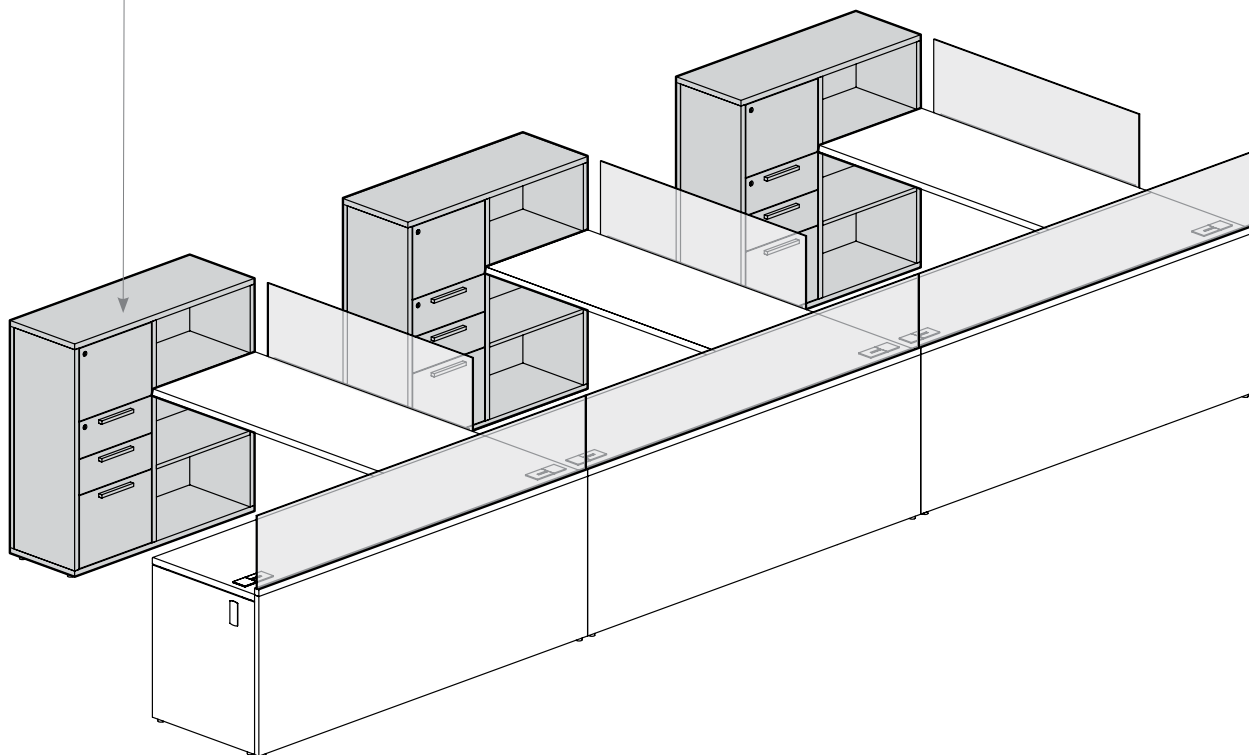

freestanding storage basics (continued)

The following illustrates Expansion Desking Tower door & drawer nominal widths.

towers – door & drawer widths

Freestanding Tower with Lateral Access, Drawers and Wardrobe (RBATW)

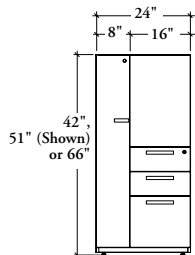

- The 24" wide freestanding towers are complete with 16" wide pedestal and have one fixed front panel
- The 24" wide cabinet has a 8" wide wardrobe

Extended Supporting Tower with Drawers (RBXTB (Shown) or RBXTL)

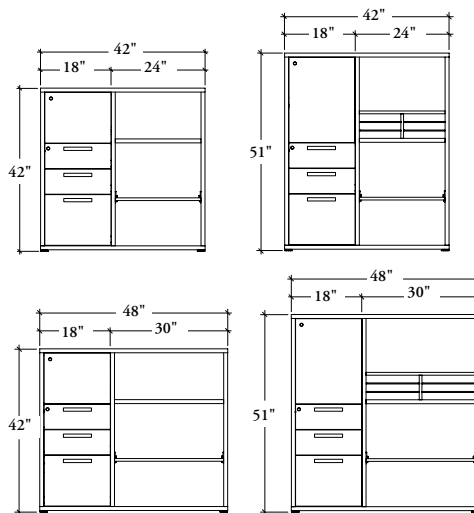

The 42" or 48" wide Extended Supporting Tower with Drawer are complete with 18" wide pedestal and have one door on the secured storage section

Extended Supporting Tower with Full Door (RBXTS or RBXTW)

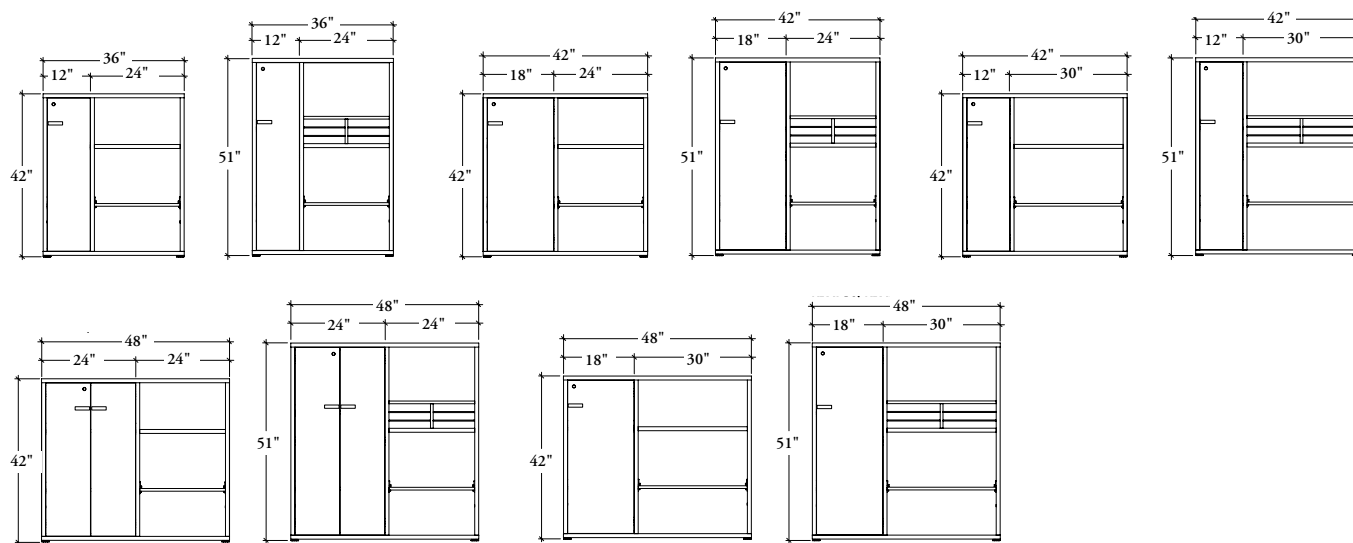

- The 36" to 48" wide Extended Supporting tower with Full Door are complete with 12" to 24" wide wardrobe (W)/shelves (S)
- The 36" wide cabinet has a 12" wide wardrobe, the 42" wide cabinet has a 12" or 18" wide wardrobe and the 48" wide cabinet has a 18" or 24" wide wardrobe

lamine freestanding storage – filing drawer capacities

Lateral file drawer laminate storage capacities are shown below.

❗ The dimensions listed below are inside drawer

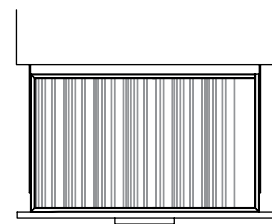
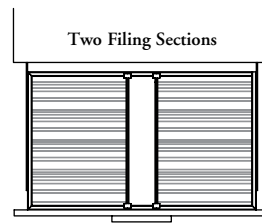
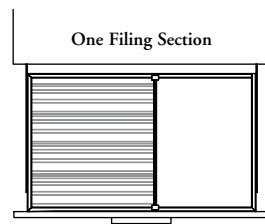

Front-to-Back

Front-to-Back

Side-to-Side

22" wide drawer

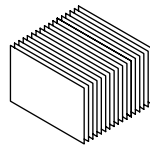
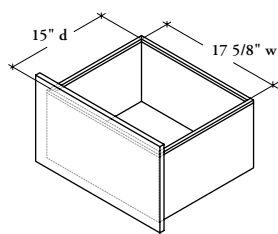

Paper Sizes Allowed:

- Letter
- A4
- Legal

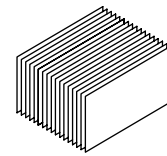

Paper Size Allowed:

- Legal

24" wide drawer

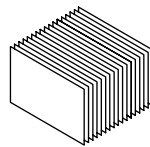
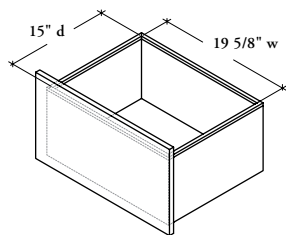

Paper Sizes Allowed:

- Letter
- A4
- Legal

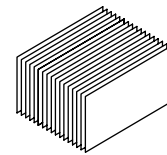

Paper Sizes Allowed:

- Letter*
- A4*
- Legal

30" wide drawer

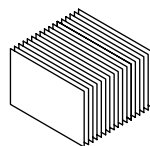
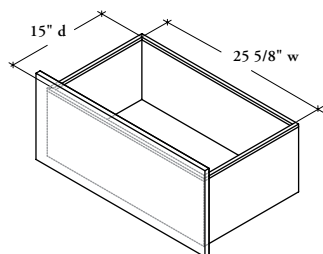

Paper Sizes Allowed:

- A4
- Legal

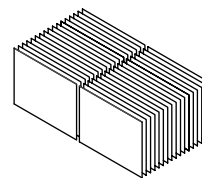

Paper Size Allowed:

- Letter

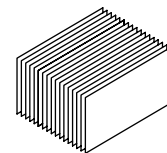

Paper Sizes Allowed:

- Letter*
- A4*
- Legal

36" wide drawer

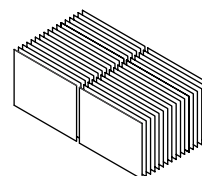
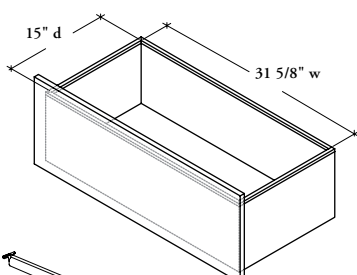

Paper Sizes Allowed:

- Letter
- A4
- Legal

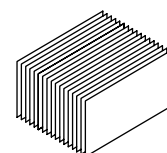

Paper Sizes Allowed:

- Letter*
- A4*
- Legal

* The Letter or A4 paper size is allowed but require optional Hanging File Bar (RSLB)

metal freestanding storage – filing storage capacities

Lateral file drawer metal storage capacities are shown below.

⚠ The dimensions listed below are inside drawer

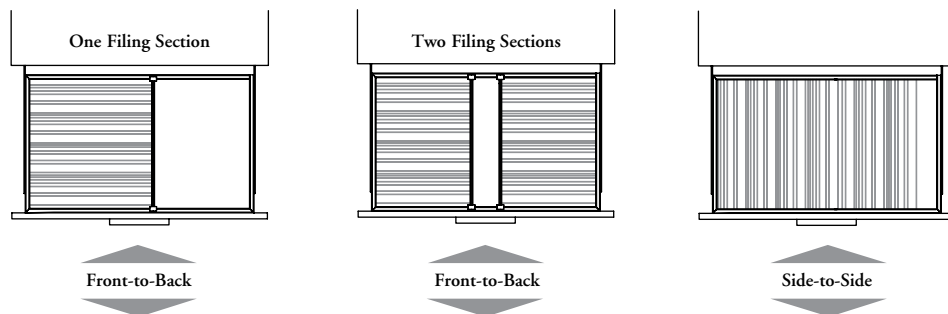

30" wide drawer

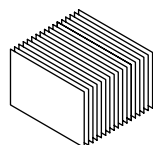
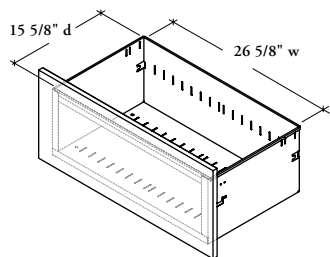

Paper Sizes Allowed:

- A4*
- Legal*

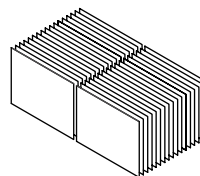

Paper Size Allowed:

- Letter**

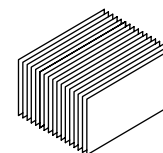

Paper Sizes Allowed:

- Letter
- A4
- Legal

36" wide drawer

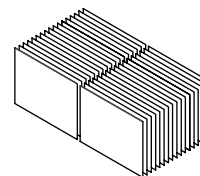
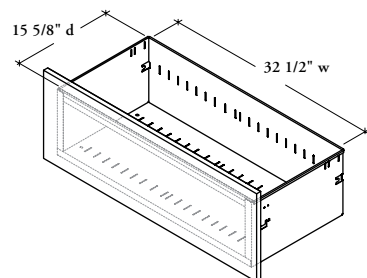

Paper Sizes Allowed:

- Letter**
- A4**
- Legal**

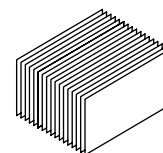

Paper Sizes Allowed:

- Letter
- A4
- Legal

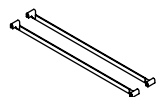

* For front-to-back application, the optional Cross File Bars (RBNSA03) are required (1 kit) or ** (2 kits)

freestanding storage inside clearance

The following outlines the freestanding storage inside clearance available.

⚠ Dimensions listed below are open compartments

42" high towers with lateral access

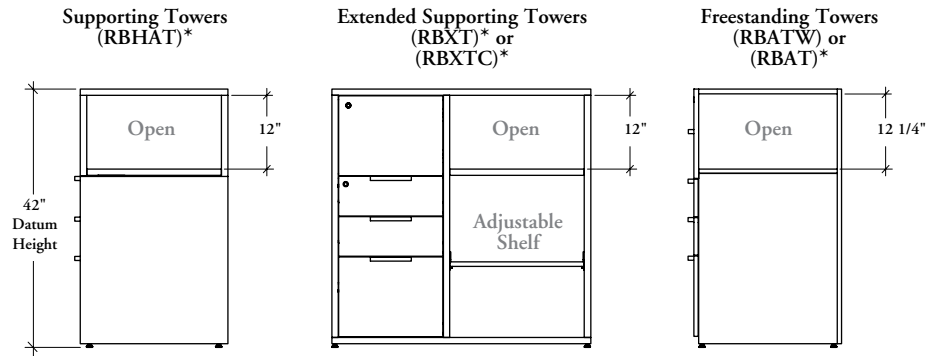

51" high towers with lateral access

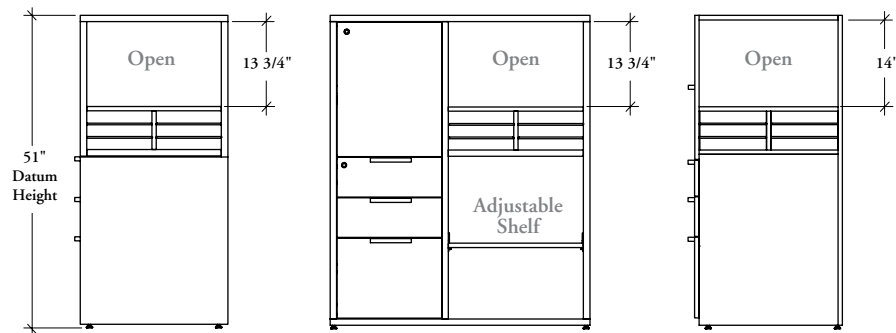

* When Cable Pass-Through option is specified, the open dimensions are the same

66" high towers with lateral access

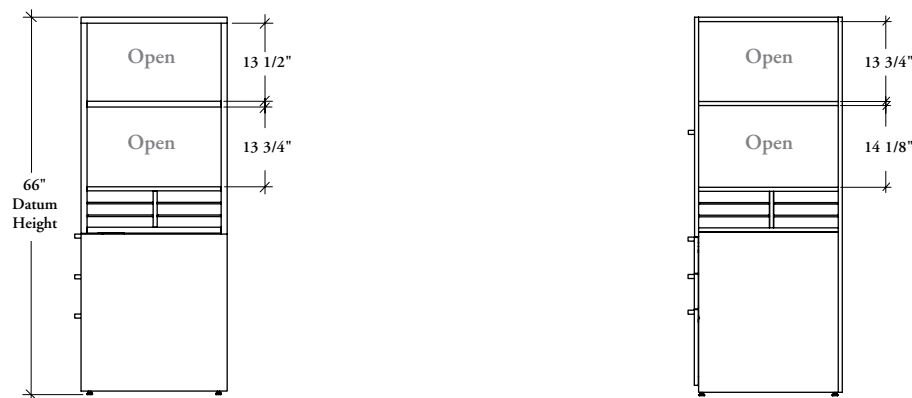

markerboard – freestanding storage mounted basics

Expansion Desking offers a wide range of markerboards that can be mounted on Freestanding Storage.

- Attach to the solid vertical surface of a Freestanding Storage
- Cannot be used on building wall or rear of the Elevated Desktop Cabinets
- Match 42" or 51" high datum line
- A Marker Holder for Markerboard can be installed, refer to page 70 for details

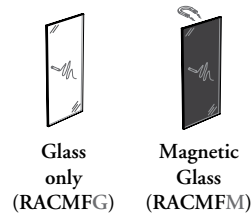

Glass Markerboard – Freestanding Storage Mounted (RACMF)

- Are available in two glass markerboard styles:
 - Glass only (G):**
Provides erasable message board
 - Magnetic Glass (M):**
Provides erasable message board and accepts rare earth magnets
- Only dry erase markers can be used
- Are available in 5/32" (4 mm) Back-Painted tempered glass
- Mounting Extrusion will match the glass finish

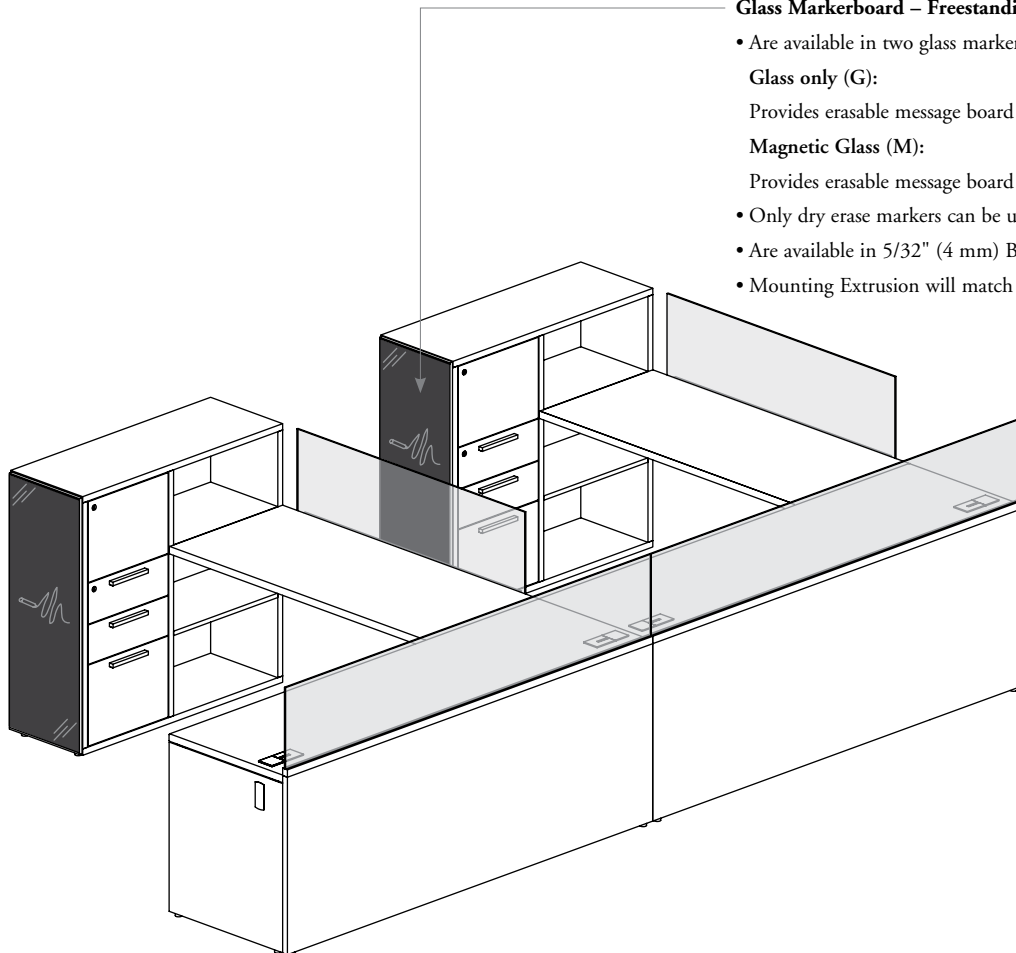

markerboard – freestanding storage mounted basics (continued)

markerboard for freestanding storage mounted applications

- Can be mounted onto a single Freestanding Storage
- All Markerboards are 1/8" smaller than the storage on which it is mounted
- Widths/heights combinations are **not** all available, see the product guide for details
- Can be mounted on the side or rear of the:
 - Supporting Towers (RBHAT, RBHSC)
 - Exrended Supporting Towers (RBXT, RBXTC)
 - Freestanding Towers (RBAT, RBATW)

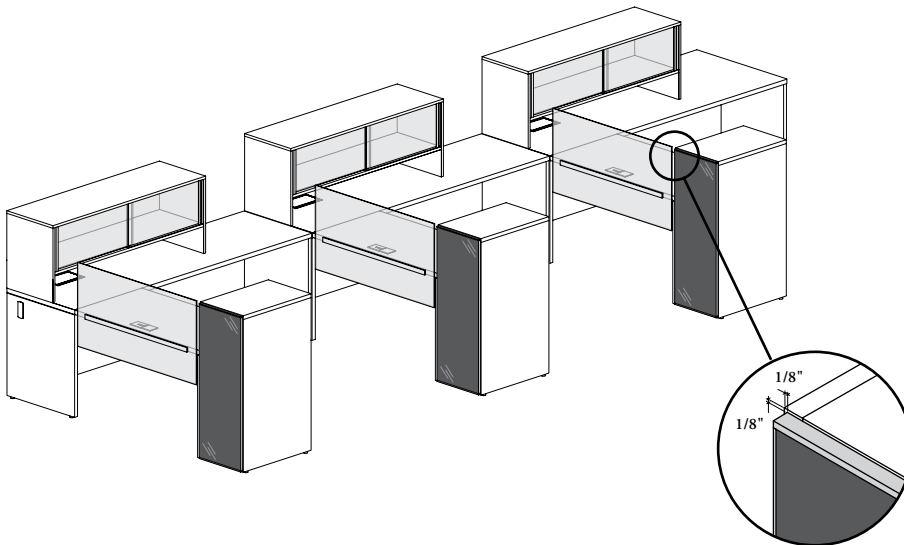

**Above Floor (01)
(Rear Application (Shown))**
Markerboard starts at 1/8" (3 mm)
from bottom edge of storage

- Can be mounted on the rear of the:
 - 53" high Lateral File only (RBLF)
 - Half Wardrobe Units (RBSF, RBSCO, RBSCCL, RBCG)
 - Storage Units (RDCL, RBSU, RBUSG, RBUSW, RBSW)
 - Bookcase (RBOB)

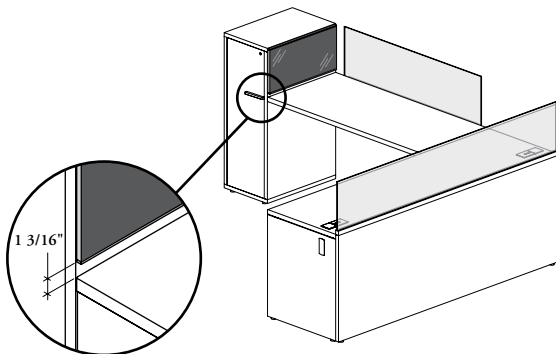

**Above Worksurface (30)
(Side Application (Shown))**
Markerboard starts at 1 3/16" (30 mm)
above worksurface

freestanding storage compatibility

clearance
(with structural beam or structural column)

clearance
(with hinged cable tray with or without power outlet)

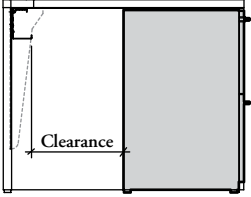
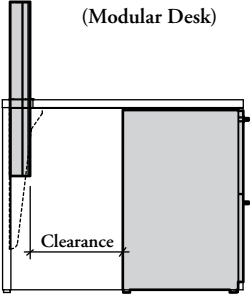
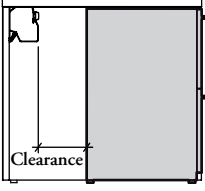

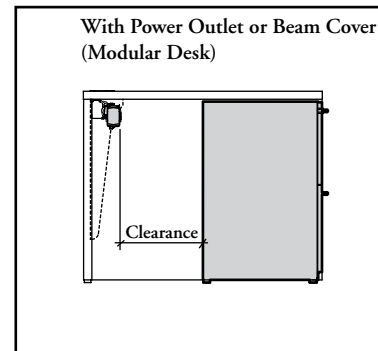
		With Structural Beam (Modular Desk)		With Structural Column (Modular Desk)		With Hinged Cable Tray (Spine Desk)		
								
Storage Depth	Desk Depth	20"		24"		30"		36"
		Modular Desks	Spine Desks	Modular Desks	Spine Desks	Modular Desks	Spine Desks	Modular Desks
18"		Does not fit		1"	5/16"	7"	6 5/16"	13"
20"		Does not fit		Does not fit		5"	4 5/16"	11"
22"		Does not fit		Does not fit		3"	2 5/16"	9"
24"		Does not fit		Does not fit		1"	5/16"	7"
30"		Does not fit		Does not fit		Does not fit		1"



clearance
(with power outlet or beam cover)

Storage Depth	Desk Depth	20"	24"	30"	36"
18"		Does not fit	No Clearance	6"	12"
20"		Does not fit	Does not fit	4"	10"
22"		Does not fit	Does not fit	2"	8"
24"		Does not fit	Does not fit	No Clearance	6"
30"		Does not fit	Does not fit	Does not fit	No Clearance

storage width compatibility

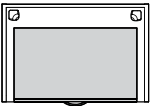
<p>36" Wide Desk</p>  <p>30" Wide Lateral File</p>	<p>36" Wide Desk</p>  <p>Two 15" Wide Pedestals</p>	<p>42" Wide Desk</p>  <p>36" Wide Lateral File</p>
---	--	---

freestanding storage lock chart

❗ If specified, all closed storage products, except those with glass doors, come with a lock and key set and can be keyed alike or randomly. A Key Chart must accompany every order, otherwise orders will be shipped keyed randomly

freestanding storage					
Product Codes	RBHAT	RBHSC	RBXTC	RBNSP	
Locks	1				
Product Codes	RBSP	RBTPS	RBSS	RBAT	
Locks	1				
Product Codes	RBNCP	RBCP	RBNLF	RBLF	RBCD
Locks	1				
Product Codes	RBSD	RBSW	RBATW	RBXT	
Locks	1		2		
Product Codes	RBSF	RBSCO	RBUSG	RBSU	
Locks	2				
Product Codes	RBSCL	RBCG	RBUW		
Locks	3				

Lockable Double Doors
 Lockable Single Door
 Lockable Drawers
 Not Lockable

freestanding storage product offering

! All dimensions on this page are actual

Supporting Tower with Lateral Access and Drawers (RBHAT)

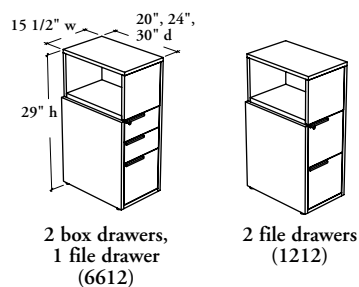

Supporting Tower with Door (RBHSC)

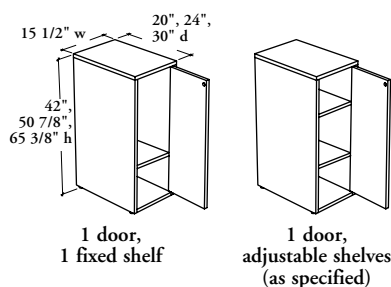

Extended Supporting Tower with Drawers (RBXT)

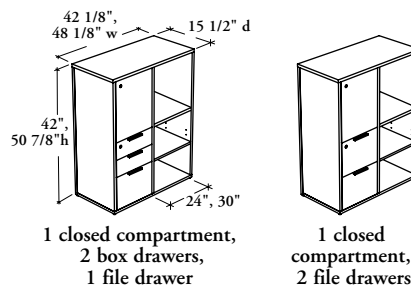

Extended Supporting Tower with Full Door (RBXTC)

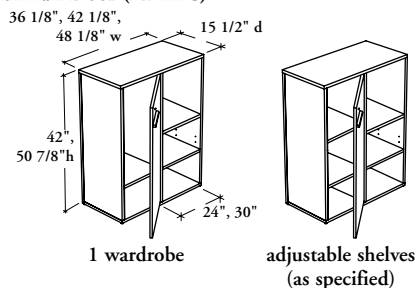

Metal Pedestal (RBNSP)

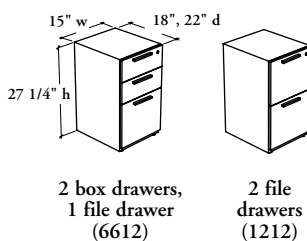

Pedestal (RBSP)

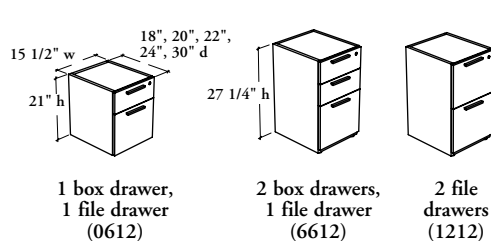

Mobile Pedestal with Seat (RBTPS)

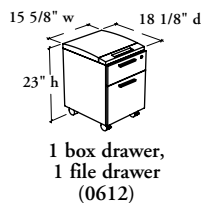

Suspended Pedestal (RBSS)

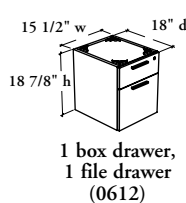

Tower with Lateral Access and Drawers (RBAT)

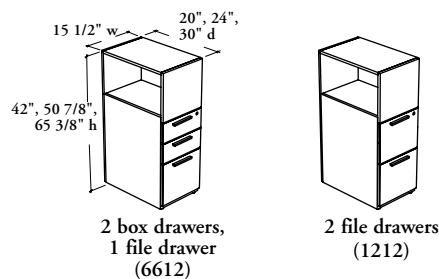

Freestanding Tower with Lateral Access, Drawers and Wardrobe (RBATW)

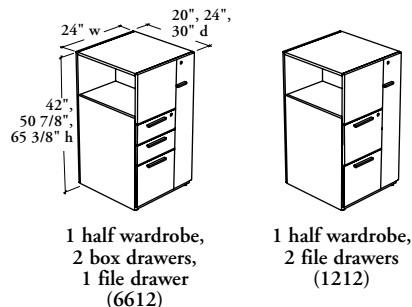

Metal Combo Pedestal (RBNCP)

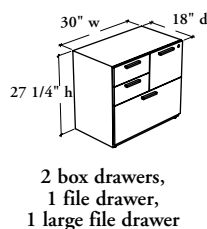

Combo Pedestal (RBCP)

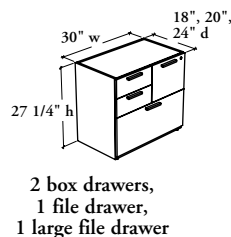

Metal Lateral File (RBNLF)

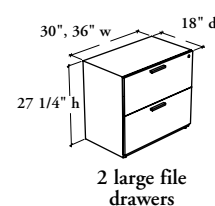

freestanding storage product offering (continued)

Lateral File (RBLF)

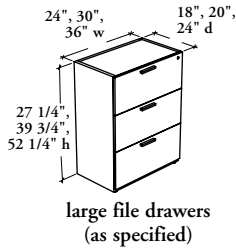

Storage Cabinet (RBCD)

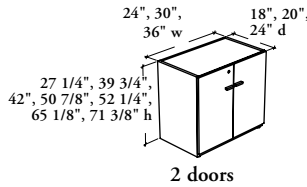

Storage Cabinet with Drawer(s) (RBSD)

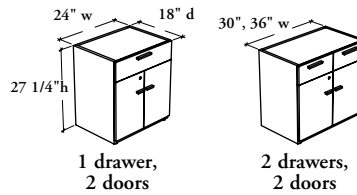

Underworksurface Bookcase (RBSUB)

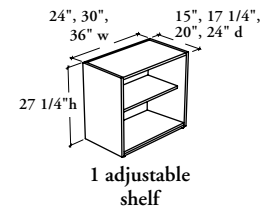

Half Wardrobe Filing Cabinet (RBSF)

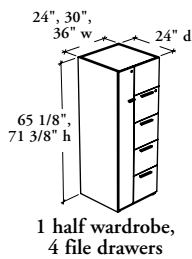

Half Wardrobe Unit with Drawers – Open Shelves (RBSO)

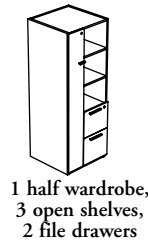
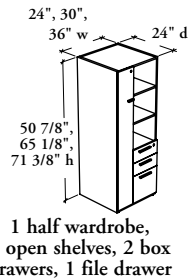

Half Wardrobe Unit with Drawers – Solid Doors (RBSC)

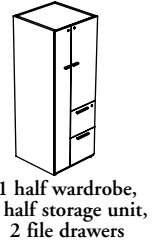
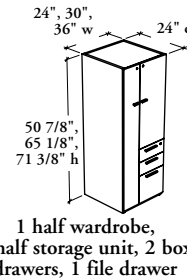

Half Wardrobe Unit with Drawers – Glass Door (RBCG)

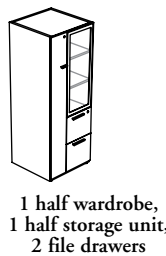
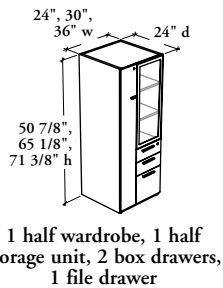

Storage Unit (RBSU)

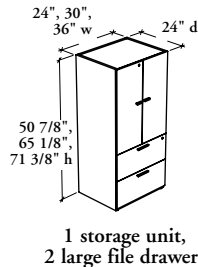

Storage Unit – Glass Doors (RBUG)

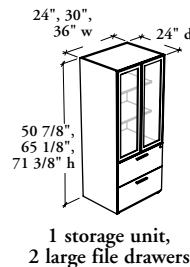

Storage Unit with Wardrobe – Solid Doors (RBUW)

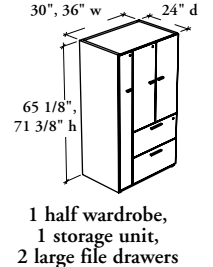

Wardrobe Cabinet – Solid Doors (RBSW)

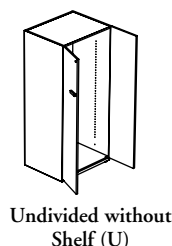
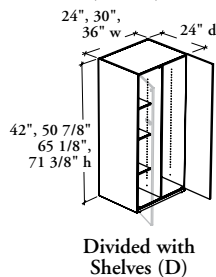

Bookcase (RBOB)

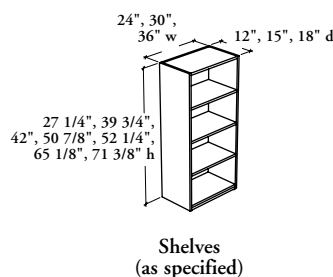

freestanding storage accessories

Expansion Desking offers a wide variety of accessories to add functionality to freestanding storage units.

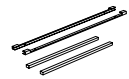

Supported Pedestal Kit (RBXSK)

- Attaches a 28" high storage under a semi-supported desk or worksurface
- Finished in Black

Top for Metal or Solid Storage Cabinet (RSNRT, RSRT)

- Provides additional worksurface space
- Must be firmly attached to the storage unit using the supplied mounting hardware
- Specify RSNRT for metal case units and RSRT for solid case units
- The Top for Solid Storage Cabinet (RSRT) has been design to fit in a continuous datum line. However, if the top is used on a storage with no door (RBSUB, RBSCO, RBOB, RBSUO) a 3/4" brown backing can be visible underneath

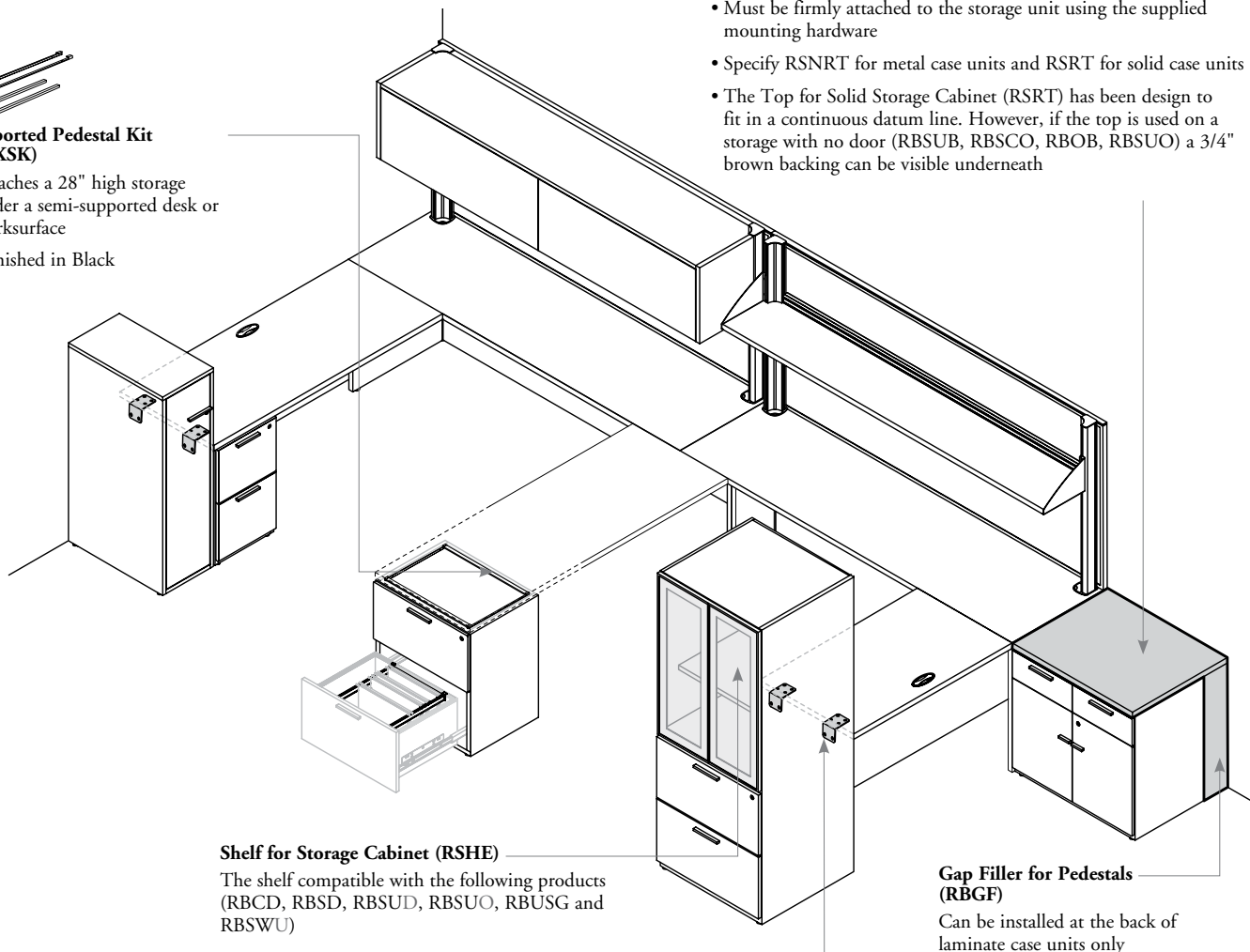

Shelf for Storage Cabinet (RSHE)

The shelf compatible with the following products (RBCD, RBSD, RBSUD, RBSUO, RBUSG and RBSWU)

Gap Filler for Pedestals (RBGF)

Can be installed at the back of laminate case units only

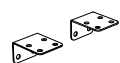

Hang-On Kit (RBXHK)

- Attaches a semi-supported desk or worksurface to a Freestanding Storage higher than 28" or Supporting Storage
- Finished in Black

freestanding storage accessories (continued)

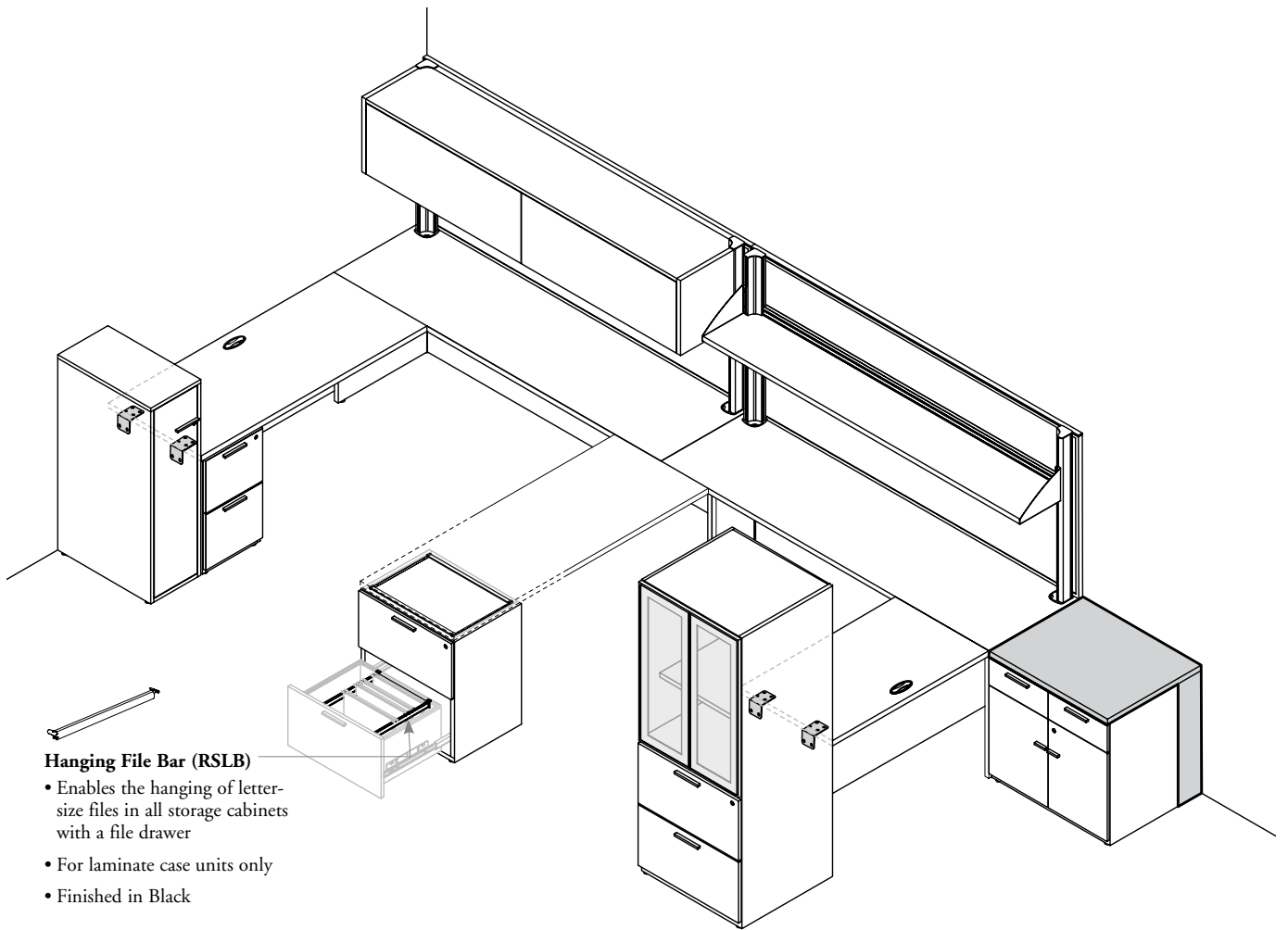

- Hanging File Bar (RSLB)**
- Enables the hanging of letter-size files in all storage cabinets with a file drawer
 - For laminate case units only
 - Finished in Black

Also available:

Metal Storage Accessories (RBNSA)

- For metal case units only
- Finished in Black

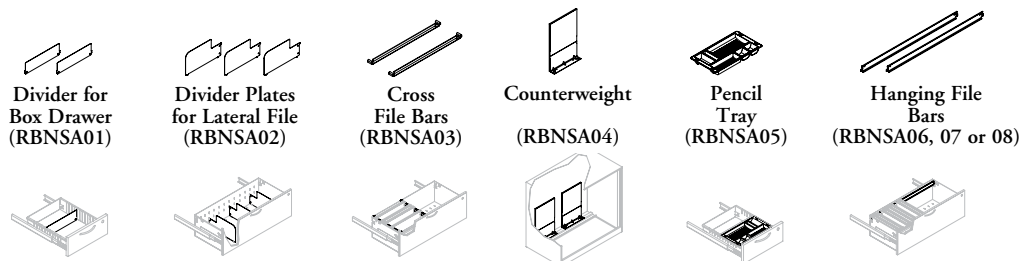

freestanding storage finishes

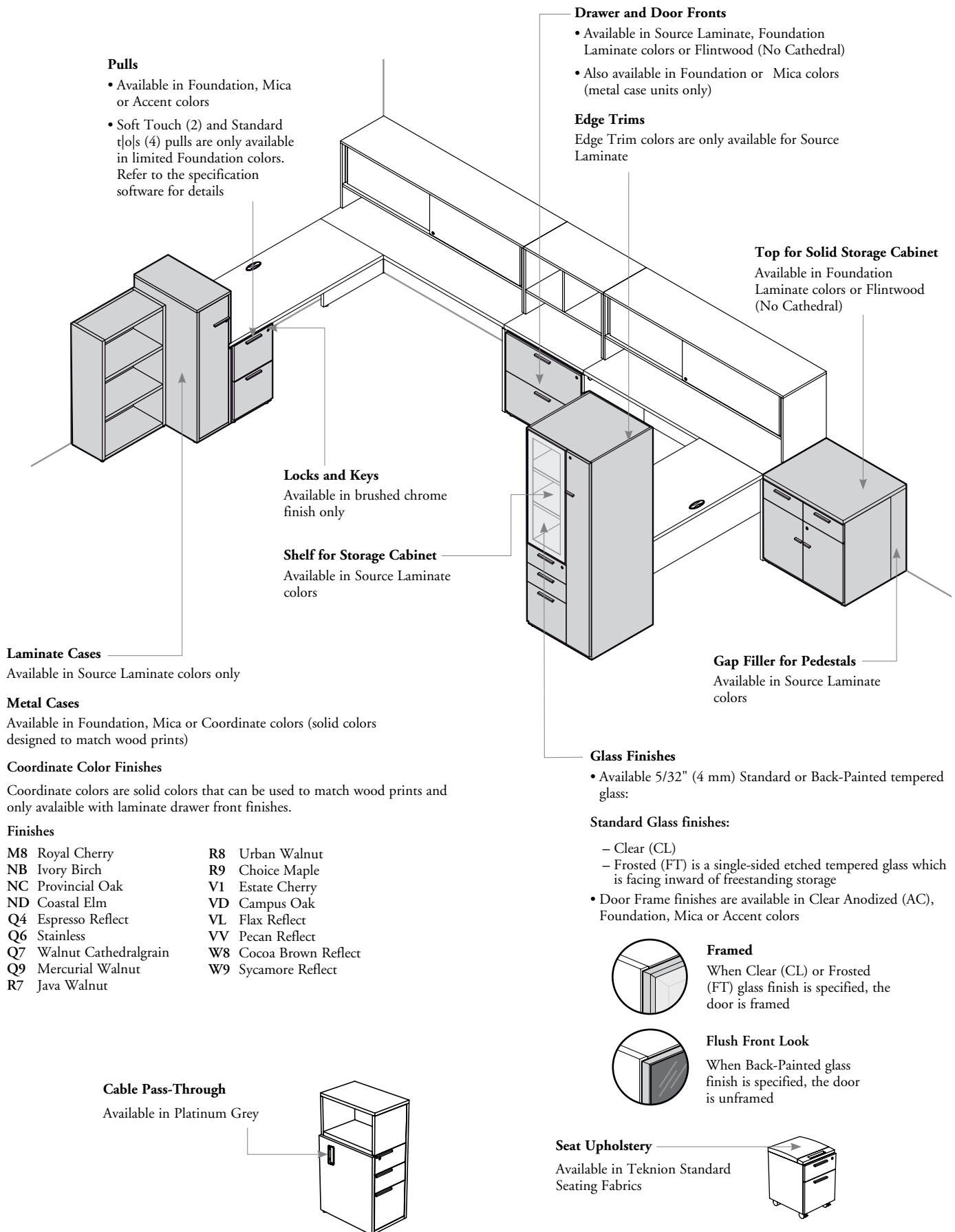

freestanding storage finishes (continued)

Supporting Tower with Full Door (RBHSC)

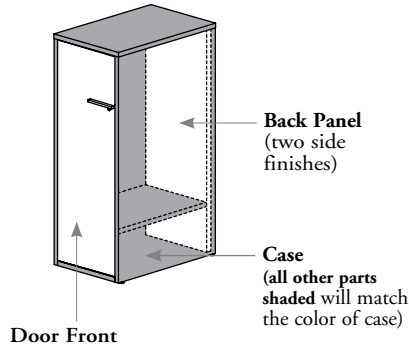

Freestanding Tower with Lateral Access, Drawers and Wardrobe (RBATW)

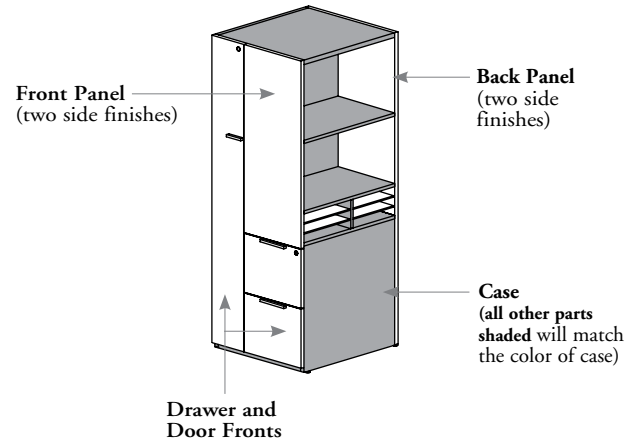

Supporting Towers with Lateral Access and Drawers (RBHAT) and Freestanding Tower with Lateral Access and Drawers (RBAT)

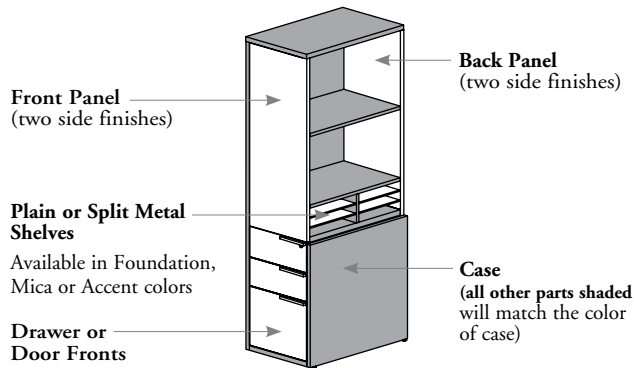

Extended Supporting Towers (RBXT and RBXTC)

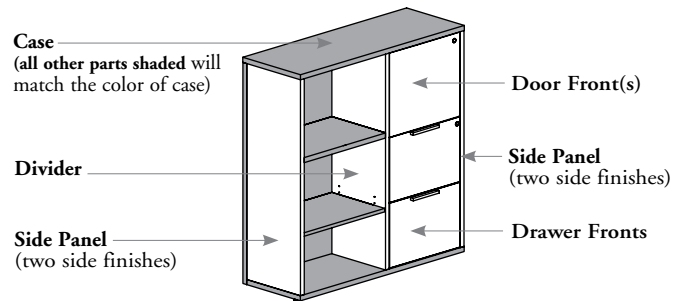

PART FINISHES

Product Codes	Worksurface Finish	Door/Drawer Front and Back Panel Finish	Door/Drawer Front, Front Panel and Back Panel Finish	Door/Drawer Front, Divider and Side Panel Finish	Case Finish
RBHSC	N/A	Source Laminate or Flintwood (No Cathedral)	N/A	N/A	Source Laminate
RBAT or RBATW	N/A	N/A	Source Laminate, Foundation Laminate or Flintwood (No Cathedral)	N/A	Source Laminate
RBHAT	N/A	N/A	Source Laminate or Flintwood (No Cathedral)	N/A	Source Laminate
RBXT or RBXTC	N/A	N/A	N/A	Source Laminate or Flintwood (No Cathedral)	Source Laminate

freestanding storage grain direction

- Door front grain direction will always be vertical
- Drawer front grain direction will vary depending on finish selected:

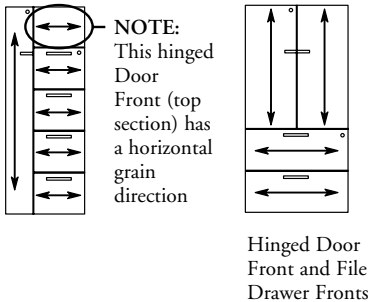
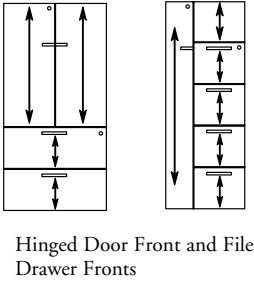
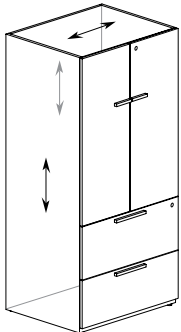
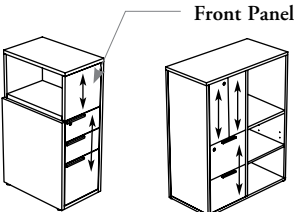
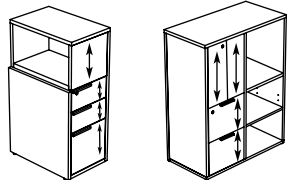
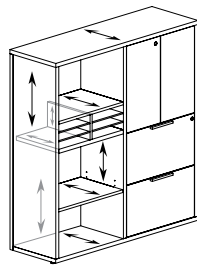
	Drawer Fronts		Case
Freestanding Storage – Standard	<p>Horizontal Grain Direction for colors listed below:</p> <ul style="list-style-type: none"> • 3A – 3B – 3C – 3D – 3E – 3L – 3M – 3X – XQ – XR Source Laminate • 2A – 2B – 2C – 2D – 2E – 2L – 2M – 2X – RQ – YR Foundation Laminate 	<p>Vertical Grain Direction for colors listed below:</p> <ul style="list-style-type: none"> • 3F – 3J – 3K – 3N – 3P – XJ – XK Source Laminate • 2F – 2J – 2K – 2N – 2P – JG – RN Foundation Laminate • FC – FD – FM – FN – FX – NR – NT – VA – VB – VZ – 5N – 5P – 5Q – 5R – 5S – 5T – 5V – 5W – 5Z Flintwood (No Cathedral) 	<p>All finishes</p>
<ul style="list-style-type: none"> • Pedestals – RBNSP, RBSP, RBTPS, RBSS, RBNCP, RBCP • Towers – RBAT, RBATW • Lateral Files – RBNLF, RBLF • Storage Cabinets – RBCD, RBSD • Half-Wardrobe Units – RBSF, RBSCO, RBSCL, RBCG • Storage Units – RBSU, RBSUG, RBUW • Wardrobe Cabinet – RBSW • Bookcases – RBSUB, RBOB 	 <p>NOTE: This hinged Door Front (top section) has a horizontal grain direction</p> <p>Hinged Door Front and File Drawer Fronts</p>	 <p>Hinged Door Front and File Drawer Fronts</p>	
Freestanding Storage – Supporting	Foundation Laminate is not available		
<ul style="list-style-type: none"> • Supporting Towers – RBHAT, RBHSC • Extended Supporting Towers – RBXT, RBXTC 	 <p>Front Panel</p> <p>Only drawer fronts will have a continuous grain direction</p>		

lighting, electrics &
communications

lighting, electrics & communications

LIGHTING, ELECTRICS & COMMUNICATIONS OVERVIEW	167
LIGHTING BASICS	168
MODULAR DESKS APPLICATIONS:	
POWER & DATA DISTRIBUTION	170
SPECIFYING CORRECT POWER HARNESS LENGTH	173
SPINE DESKS APPLICATIONS:	
POWER & DATA DISTRIBUTION	178
SPECIFYING CORRECT POWER HARNESS LENGTH	184
MODULAR & SPINE DESKS APPLICATIONS:	
POWER & DATA DISTRIBUTION	192
WIRING SYSTEMS	194

lighting, electrics & communications overview

Particular attention should be paid to the correct selection of electrical components. You should follow the steps given on this page.

- 1 Select the workstation configuration (Modular Desks or Spine Desks)
- 2 Select the appropriate power outlets and plug-ins for your particular workstation configuration. A variety of products are available to provide access to power and communications under or above the worksurface
- 3 Choose between the six shielded wiring systems:
 - The four-wire system (4B) has two standard circuits.
 - The five-wire system (5D) has three standard circuits.
 - The seven-wire system (7G) has two standard circuits and one isolated circuit.
 - The eight-wire system (8N) has two standard circuits with separate neutrals and one isolated circuit.
 - The eight-wire system (8T) has three standard circuits and one isolated circuit.
 - The eight-wire system (8K) has two standard circuits and two isolated circuits.
- 4 Determine the number of power sources required and their location, then select the required feed (base or ceiling)
- 5 Select the required products to connect power components

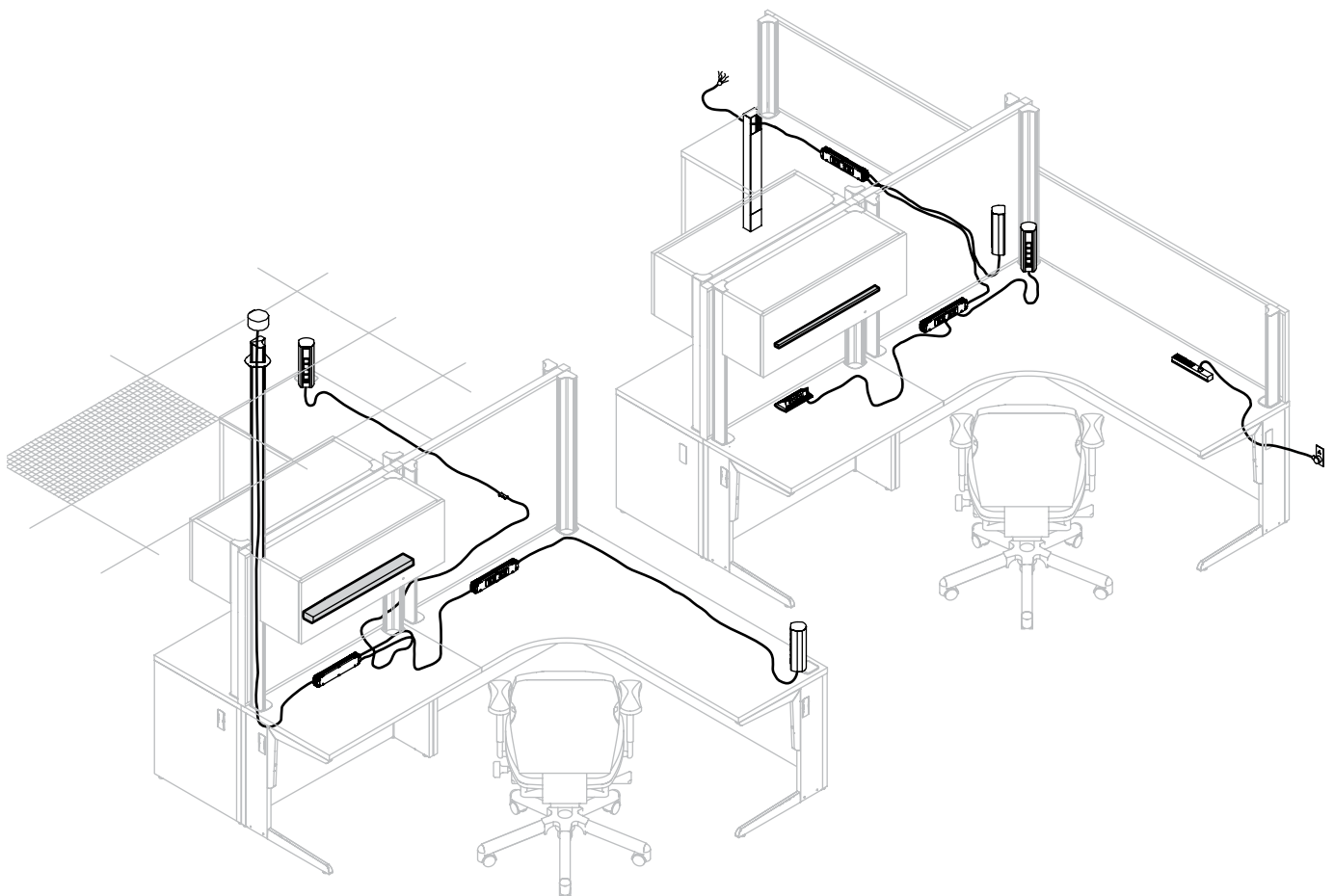

lighting basics

Expansion Desking's lighting solutions answer all task illumination needs. LED strips provide high quality lighting over the worksurface.

- All dimensions are actual, except for Linear LED Light
- To route power to the worksurface of a Modular Desk, light cords can be affixed to the mounted storage underside using wire clips and then be concealed in the structural column with the provided plastic extrusion
- Check local codes for potential limits or restrictions on products and local authority approval may be required prior to use
- Some jurisdictions require Resettable Breakers. Check local codes

tangent undercabinet light

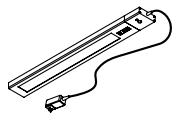
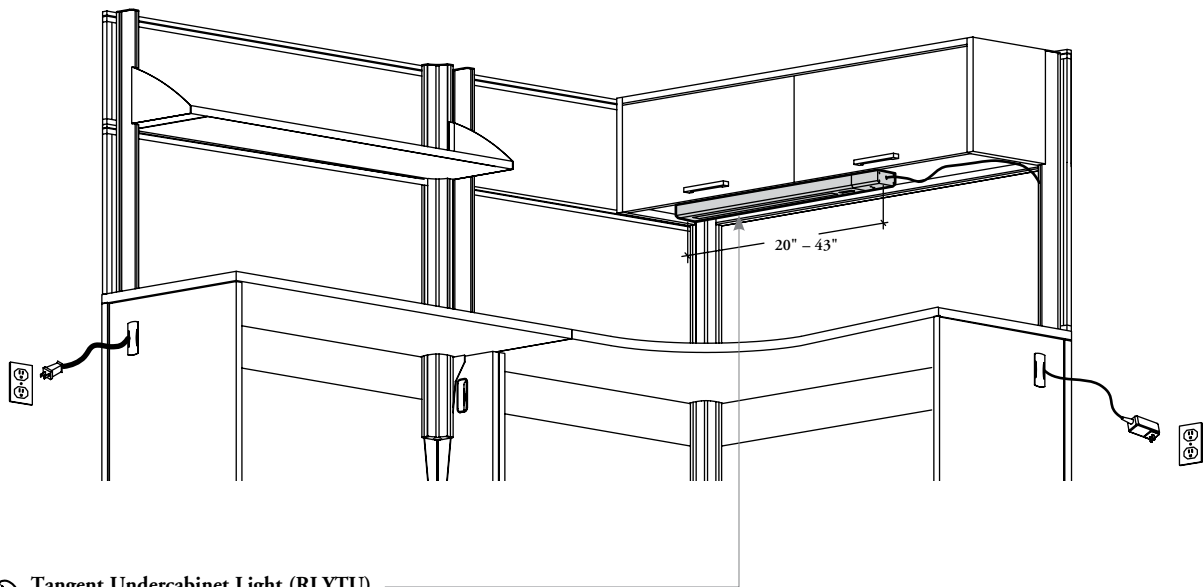

Tangent Undercabinet Light (RLYTU)

- Mounts to the underside of Overhead Cabinets (Shown), Solid and Metal Shelves or Elevated Desktop Cabinets
- Can be mounted under the metal shelf of mounted storage, except for solid shelves, magnetic plates with wood screws are provided for non-magnetic application
- This product includes two cord management adhesive clips
- Tangent Light is compatible with controlled wall outlets
- Finished in Clear Anodized (AC) only

lighting basics (continued)

tangent undercabinet light (continued)

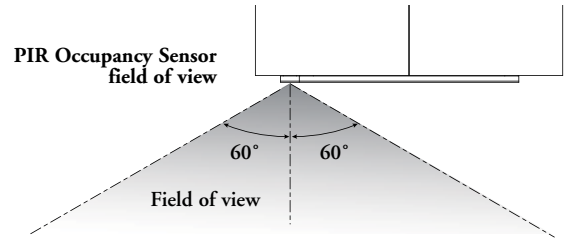
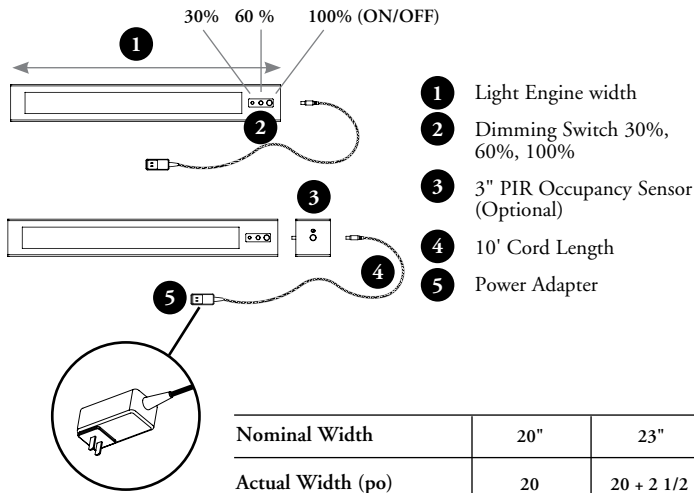

When a temperature change is detected in the field of view, the PIR shut-off timer resets to 20 minutes

Nominal Width	20"	23"	30"	33"	40"	43"
Actual Width (po)	20	20 + 2 1/2	30	30 + 2 1/2	40	40 + 2 1/2
3" PIR Occupancy Sensor	n/a	Yes	n/a	Yes	n/a	Yes
Use with Cabinet Width	24" to 84"	30" to 84"	42" to 84"	42" to 84"	48" to 84"	54" to 84"
Luminosity (lm)	500	500	750	750	900	900
Power Consumption (w)	10	10	15	15	18	18

linear LED light

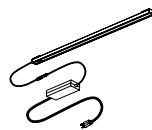
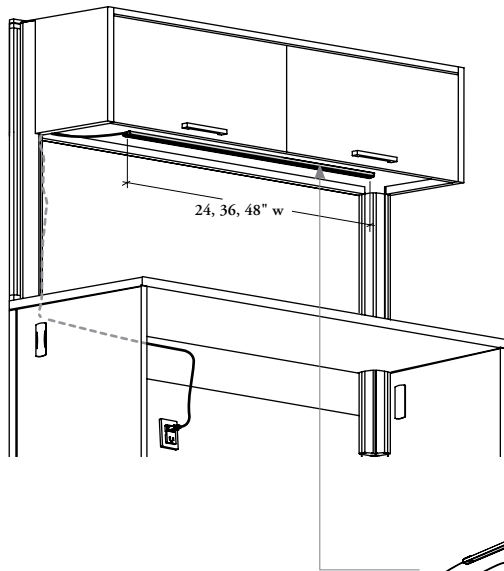

Linear LED Light (RLED)

- Equipped with an energy-efficient strip of LEDs
- Can be magnetically mounted to the underside of Overhead (Shown), Elevated Desktop Cabinets or Shelves
- For storage products, the specified width should be one size smaller than the width of the cabinet to which it will be attached
- This product includes a 216" cord length
- Made with 95 % of recycled material. Life expectancy of 50 000 hours
- Magnetic plates with shelf-adhesive foam tape are provided for non-magnetic application
- Finished in Clear Anodized (AC) only

power & data distribution – modular desks

Expansion Desking offers a wide variety of components for efficient and discreet management of electrical wiring and communication cables. Components can be installed to run cables from the ceiling, the floor or the wall, and power outlets and data jacks can be installed on top or under the worksurface.

- Cable Pass-Through or grommets on the gables, full-height modesty panels, 1" Floor or 2" Freestanding Screens, freestanding storage, credenzas, and worksurfaces provide openings for routing cables from one desk to another. A structural beam under the worksurface allows cable management
- Desks and Credenzas must be linked together with appropriate hardware when sharing hard wiring
- In a Modular Desk workstation, the Modular Desk mounting option (M) must be specified for each product to get appropriate harness length or mounting hardware

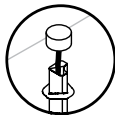

Ceiling Feed – Modular Desk (RLDFM)

- Used in conjunction with the Power Pole (RLSP or RLPS)
- Feeds building power from the ceiling down to the workstation cluster
- Power Pole height and desk width to which it is being attached must be specified to ensure that correct length of feed is provided
- 48" and 54" lengths are adapted to the Column-Mounted Power Pole, other lengths must be used in a Lateral Power Pole attached to a gable through its grommet hole

Column-Mounted Power Pole (RLSP)

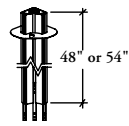

Power Pole Divider (RLSD)

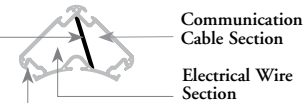
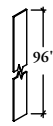

Column-Mounted Power Pole and Power Pole Divider

- Is a channel through which building electrical and communication cables can be fed from the ceiling to workstations
- Divider can be used to separate electrical wires and communication cables
- Available in Foundation or Mica colors

Data/Communication Cable Capacity

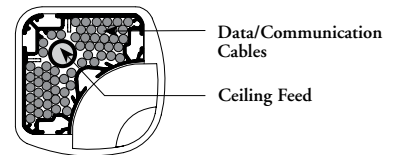

36 Data Cables Cat5 @ 60% Filling Rate

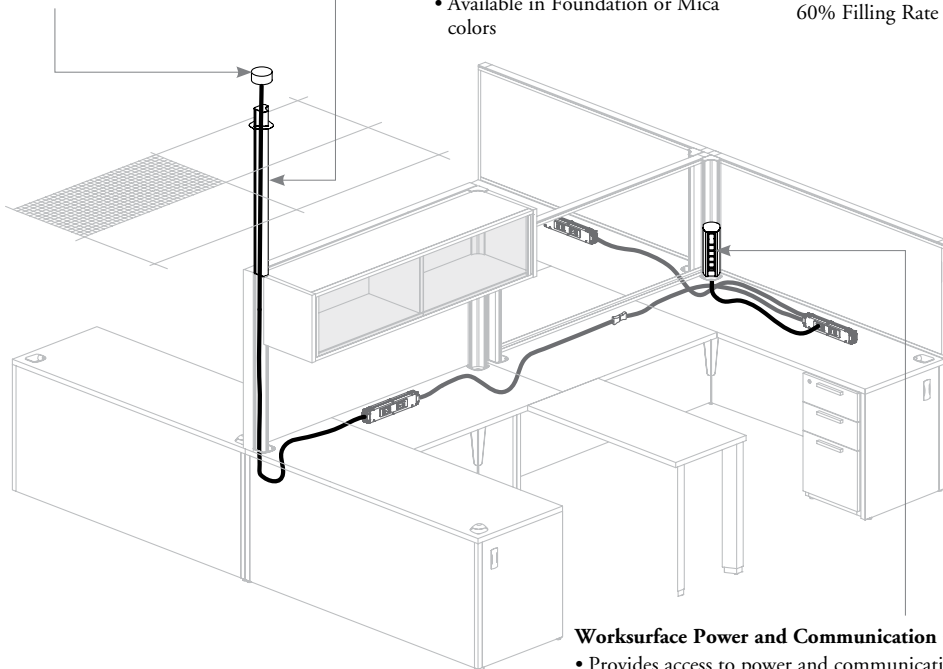

Worksurface Power and Communication Center (RLDCC)

- Provides access to power and communications above worksurface
- Mounts to a desking column grommet only
- Equipped with communication opening (2.71" x 1.38"), blank faceplate and also comes with four power outlets
- The 3P option is a low-cost alternative to the 4B-, 5D-, 7G-, 8N-, 8T- and 8K-wire systems. It plugs directly into standard receptacles
- Voice/data faceplates and jacks are **not** included and must be field supplied and installed
- The 3P option comes with 72", 108" or 144" long cord. The 4B- to 8K-wire option comes with 21" to 144" long shielded wire
- Finished in Anodized Aluminum (top cap is Black)

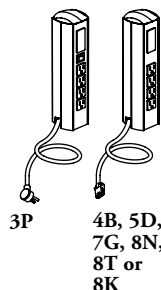

power & data distribution – modular desks (continued)

Power Box – Modular Desks (RLDUM, RLCUM)

- Provides power access to the workstation
- Compatible with 36" to 84" wide desks
- Available with two grey duplexes on each side (as specified). Connects up to four pieces of electrical equipment on each side
- Comes with metal brackets to mount centered on the structural beam
- Available in single- and double-sided versions for individual or shared positioning

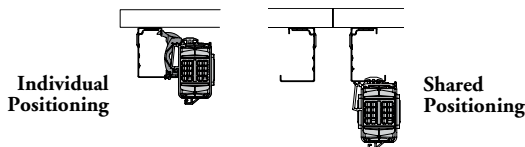

- Shared positioning allows shared power between back-to-back desk application
- Full- or 3/4-Height Modesty Panel in top position **cannot** be used when using shared Power Box
- Finished in a Platinum Coordinate

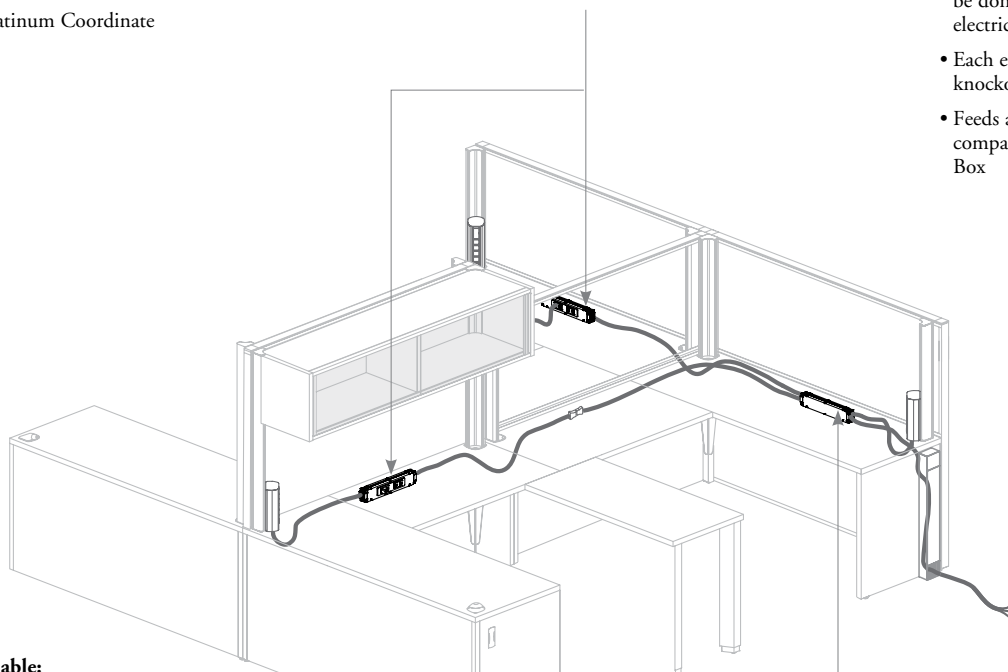

Also available:

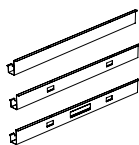

- No Power or Data Access
- With Data Access and No Power
- Power and Data Access

Beam Cover (RLDEC)

- Used to hide electrical wires and communication cables
- Available with Data Access and No Power, with Power and Data Access, or No Power or Data Access
 - With Data Access and No Power is available with worksurfaces from 24" to 84" widths
 - Power and Data Access option is available from 36" to 84", but 36" width has No Data Access cut-outs
 - No Power or Data Access is available with worksurfaces from 24" to 84" widths
- Two communication openings (2.71" x 1.38") are included on 42" wide and over when specified, blank faceplates are included
- Voice/data faceplates and jacks are **not** included and must be field supplied and installed
- **Cannot** be installed in shared positioning
- Available in Foundation or Mica colors or Coordinate Colors

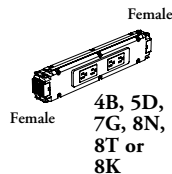

Power Box – Modular Desks (RLDUM)

Equipped with four female connectors in order to facilitate 1 "in" and up to 3 "outs" in a non-directional configuration

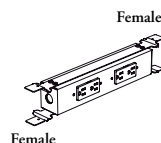

Chicago Power Box – Modular Desks (RLCUM)

- Includes the outlets but does **not** include any connectors
- Electrical connections must be done on-site by a certified electrician
- Each end has a 1/2" trade size knockout
- Feeds and Harnesses are **not** compatible with Chicago Power Box

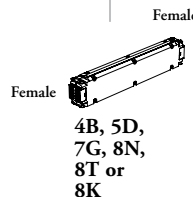

Distribution Box (RLDSB) (See configuration 2 on page 174)

- Fits on electrical clips centered on the structural beam
- Equipped with four female connectors in order to facilitate 1 "in" and up to 3 "outs" in a non-directional configuration
- May be used as an alternative to the Power Box – Modular Desks (RLDUM) when only worksurface outlets are required (using multiple circuit Worksurface Power and Communication Center (RLDCC))
- Finished in a Platinum Coordinate

power & data distribution – modular desks (continued)

⚠ Do not energize from more than one source, it may cause serious injury

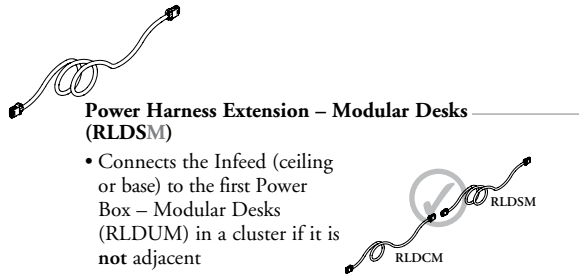

Power Harness Extension – Modular Desks (RLDSM)

- Connects the Infeed (ceiling or base) to the first Power Box – Modular Desks (RLDUM) in a cluster if it is not adjacent
- Could be used as an extension with Power Harness – Modular Desks (RLDCM), if two Power Box – Modular Desks (RLDUM) are not adjacent and total length exceeds maximum length available
- Available in 3" increments up to a maximum length of 138"

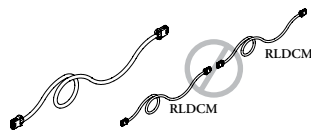
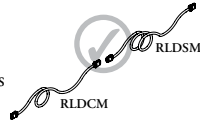

Power Harness – Modular Desks (RLDCM)

- Connects two Power Box – Modular Desks (RLDUM)
- Available in 3" increments up to a maximum length of 156"

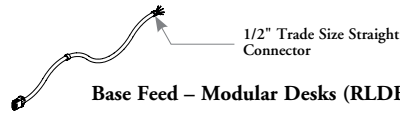

Base Feed – Modular Desks (RLDBM)

- Used alone or in conjunction with the Lateral Power Pole (RLPS)
- Feeds building power from the floor or wall to the workstation
- Desk width to which it is being attached must be specified to ensure that correct length of feed is provided

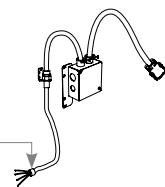

NYC Split Base Feed – Modular Desks (RLBSM)

- Same as the Base Feed, except that its hard wire is split in a Junction Box for New York City wiring restrictions
- Junction Box comes with mounting bracket which must be installed underneath the desk
- Allows routing hard wire through a Lateral Power Pole mounted on the outside of the gable
- Does not allow routing hard wire through a storage or credenza product
- For use in the United States only

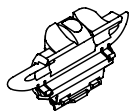
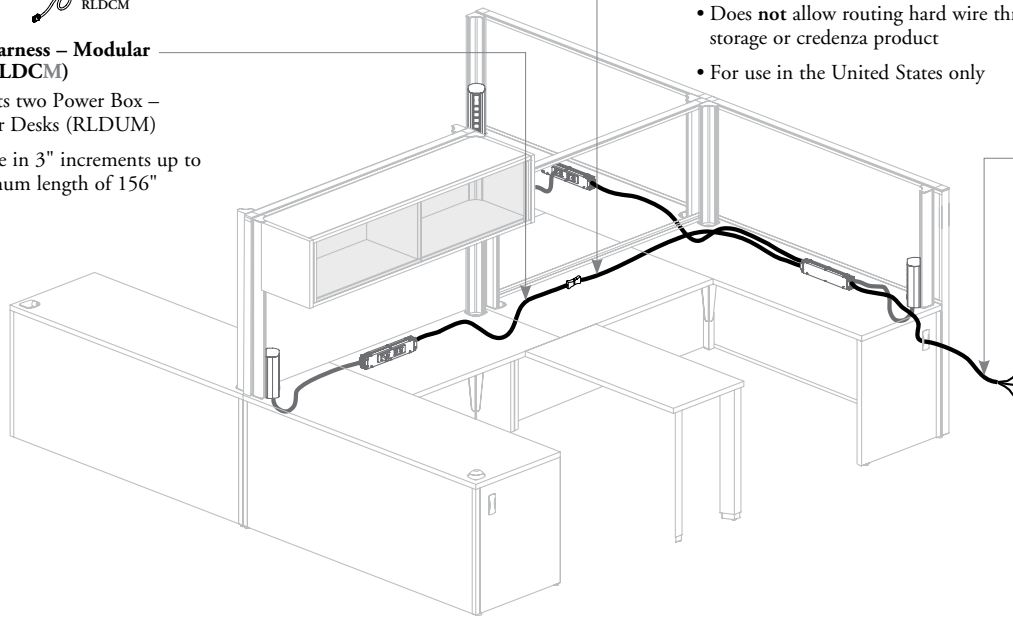

Electrical Clips

- Come with structural beam that is provided with the desks
- Quantity varies according to the beam width:
 - 24" = 1 clip
 - 30" to 42" = 2 clips
 - 48" to 72" = 4 clips
 - 78" or 84" = 6 clips

- Allow attachment of the Power Box – Modular Desks (RLDUM) or Underworksurface Plug-In Power Bar (RLPP) on the structural beam

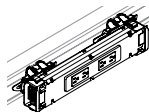

Power Box

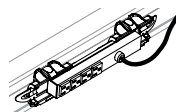

Underworksurface Plug-In Power Bar

- Feature a provision to wrap the user/data cables

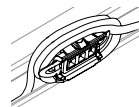

- The communication opening measures 2.71" x 1.38" to accommodate Voice/Data faceplates and jacks (not included)

- Finished in Black

Clip

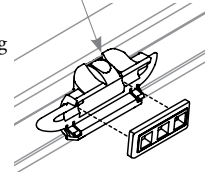

specifying correct power harness length – modular desks

- ◆ All harnesses can be specified in 4B, 5D, 7G, 8N, 8T and 8K shielded wiring systems
- All Power Harnesses have a nominal length for ease of specification
- When determining the proper length of Power Harness, always calculate from center to center of desk. A nominal sized harness will take into consideration the width of the Power Box
- When determining the proper length of infeed, always specify desk length

configuration 1 – single-sided power box – modular desks

- 4B, 5D, 7G, 8N, 8T and 8K Power Box – Modular Desks
- 4B, 5D, 7G, 8N, 8T and 8K Worksurface Power and Communication Center

Worksurface Power and Communication Center (RLDCC)

- Power Harness is **not** required to connect the Worksurface Power and Communication Center to the Power Box as this product includes the following cord length: 3P = 72", 108" or 144"; 4B, 5D, 7G, 8N, 8T and 8K = 21" to 144"
- To specify the correct length, calculate the distance from the worksurface Power and Communication Center (RLDCC) to the center of the desk where the Power Box – Modular Desks (RLDUM) is located

- If the cable has to pass through gables grommets, add 6" for every loop
- example:**
- $$(36 + 48) \div 2 = 42$$
- (RLDCC_42)
- For 36" or 39" wide desks, the 21" cord length (RLDCC_21) must be specified

Power Harness – Modular Desks (RLDCM)

- Connects two Power Box together
- example:**
- $$(48 + 36) \div 2 = 42$$
- $$(48 + 36) \div 2 = 42$$
- 84
(RLDCM_84)
- To specify the correct length, calculate the dimension from the center of the desk to the center of the adjacent desk

- The center-to-center length calculation rule is also used when bending around corners

example:

$$48 \div 2 = 24$$

$$72 \div 2 = 36$$

60
(RLDCM_60)

- For back-to-back applications with single-sided power box, use Power Harness (RLDCM_36) to pass from one desk to the other
- When 1" Floor Screens or 2" Freestanding Screens with Center Pass-Through are used in back-to-back, Power Harness must be specified 60" long (RLDCM_60)

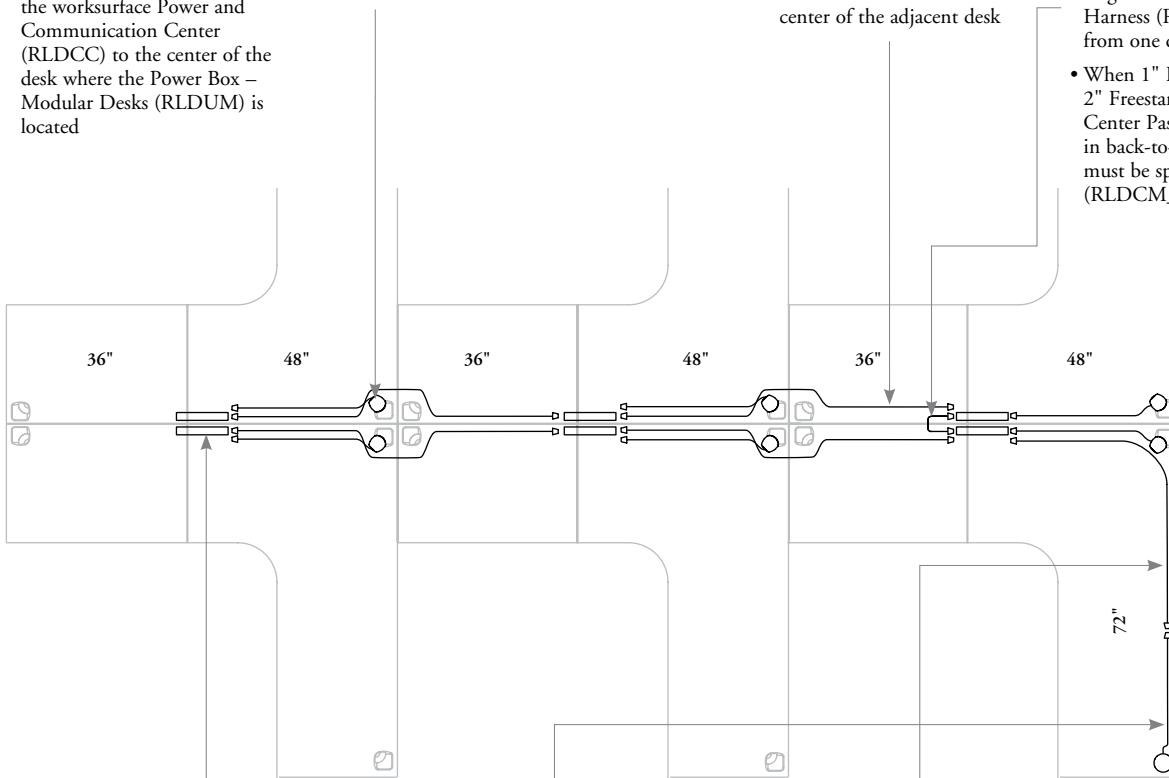
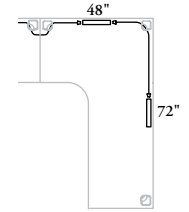

Power Box – Modular Desks (RLDUMS)

Single-Sided Outlet Configuration

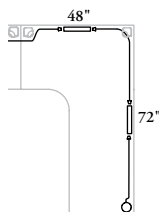

Ceiling Feed – Modular Desks (RLDFM), Base Feed – Modular Desks (RLDBM), or NYC Split Base Feed – Modular Desks (RLBSM)

- When specifying the Ceiling or Base Feed, the length of the first desk must also be specified (RLDFM_72, RLDBM_72 or RLBSM_72)
- Will plug directly in Power Box (RLDUM) when power bar is located on the first desk; no Power Harness Extension (RLDSM) is required

Power Harness Extension – Modular Desks (RLDSM)

- Must be specified to connect the Ceiling or Base Feed to the first Power Box (RLDUM) if not adjacent

- To specify the correct length, calculate the dimension from the center of the desk to the center of the adjacent desk

example:

$$(36 + 48) \div 2 = 42$$

$$72 \div 2 = 36$$

78
(RLDSH_78)

specifying correct power harness length – modular desks (continued)

configuration 2 – distribution box

- 4B, 5D, 7G, 8N, 8T and 8K Distribution Box – Modular Desks
- 4B, 5D, 7G, 8N, 8T and 8K Power Box – Modular Desks (Shared Back-to-Back)
- 4B, 5D, 7G, 8N, 8T and 8K Worksurface Power and Communication Center

Worksurface Power and Communication Center (RLDCC4B to 8K)

Calculating the length example:

$$\begin{array}{r} 72 \div 2 = 36 \\ \text{(RLDCC_36)} \end{array}$$

Power Harness – Modular Desks (RLDCM_156)

Calculating the length example:

$$\begin{array}{r} 72 \div 2 = 36 \\ 48 = 48 \\ 48 = 48 \\ 48 \div 2 = 24 \\ \hline 156 \\ \text{(RLDCM_156)} \end{array}$$

Power Box – Modular Desks (RLDUMD)

Double-Sided Outlet Configuration

Power Harness Extension – Modular Desks (RLDSM_72)

Calculating the length example:

$$\begin{array}{r} 72 \div 2 = 36 \\ 72 \div 2 = 36 \\ \hline 72 \\ \text{(RLDSM_72)} \end{array}$$

Distribution Box – Modular Desks (RLDSM)

If access to power is **not** required, the Power Box (RLDUM) may be replaced with a Distribution Box

Base Feed – Modular Desks (RLDBM_72) or

NYC Split Base Feed – Modular Desks (RLBSM_72)

Worksurface Power and Communication Center (RLDCC4B to 8K)

Calculating the length example:

$$\begin{array}{r} 72 \div 2 = 36 \\ \text{(RLDCC_36)} \end{array}$$

Power Harness Extension – Modular Desks (RLDSM)

Calculating the length example:

$$\begin{array}{r} 72 \div 2 = 36 \\ 48 = 48 \\ 48 \div 2 = 24 \\ \hline 108 \\ \text{(RLDSM_108)} \end{array}$$

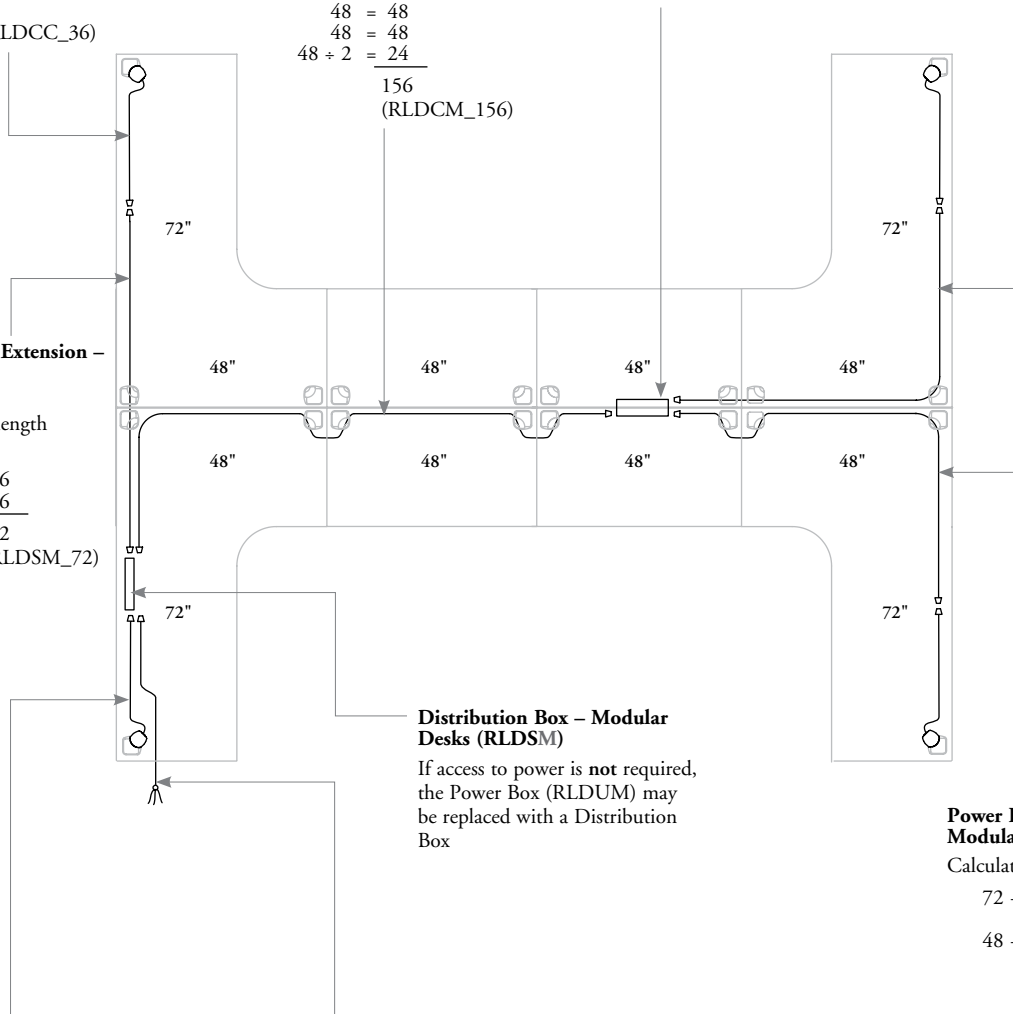

specifying correct power harness length – modular desks (continued)

configuration 3 – double-sided power box – modular desks

- 4B, 5D, 7G, 8N, 8T and 8K Power Box – Modular Desks (Shared Back-to-Back)
- 3P, 4B, 5D, 7G, 8N, 8T and 8K Worksurface Power and Communication Center

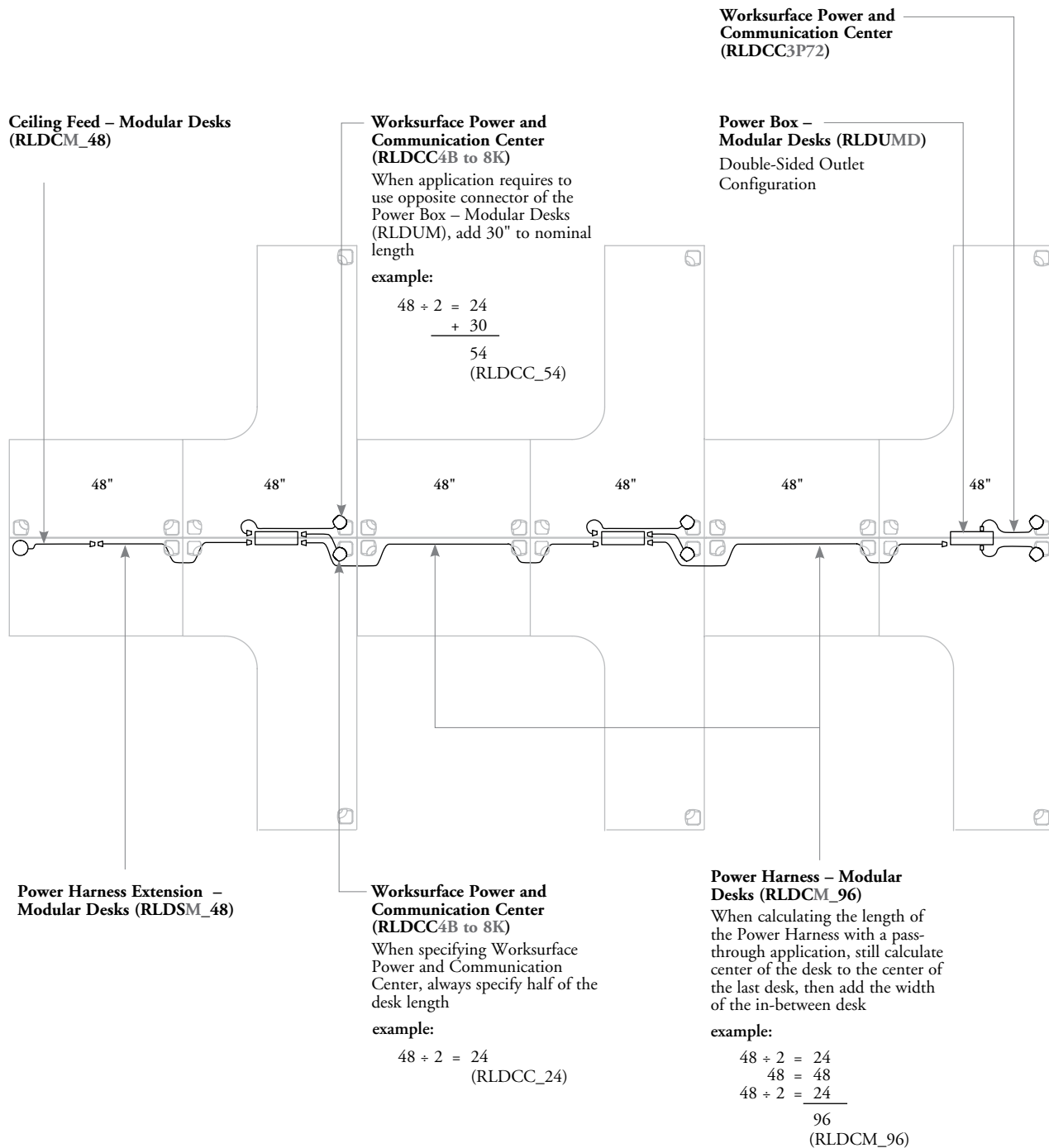

specifying correct power harness length – modular desks (continued)

⚡ Wiring through credenzas or freestanding storage will require adding 3" for every loop

configuration 4 – power harness length for credenzas or freestanding storage with grommets/ cable pass-through option

- 4B, 5D, 7G, 8N, 8T and 8K Power Box – Modular Desks
- 3P, 4B, 5D, 7G, 8N, 8T and 8K Worksurface Power and Communication Center

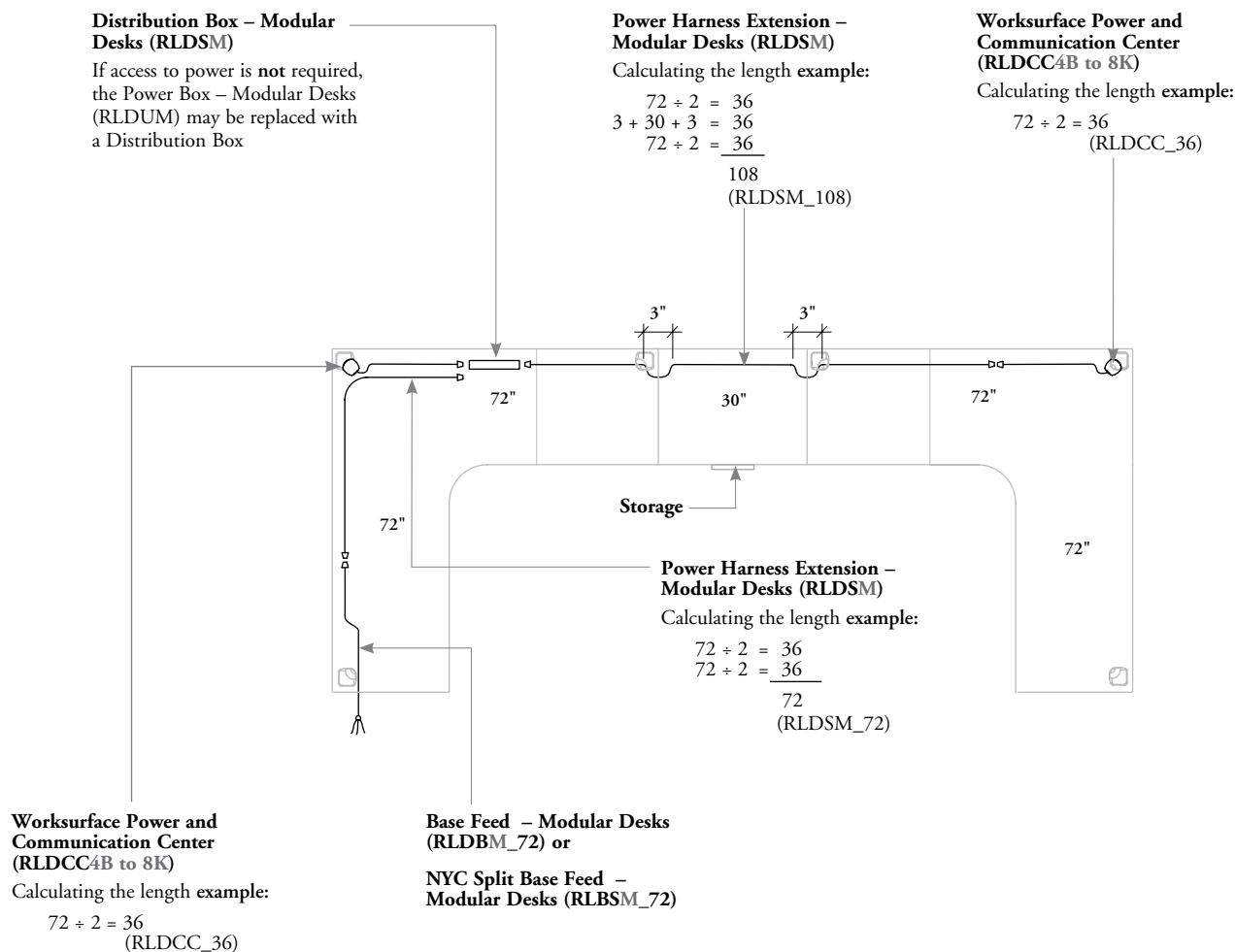

power & data distribution – spine desks

Expansion Desking offers a wide variety of components for efficient and discreet management of electrical wiring and communication cables. Components can be installed to run cables from the ceiling, floor or wall. Power outlets and data jacks can be installed under the worksurface and still be reachable from above the worksurface through the Access Door.

- Cable Pass-Through or grommets on gables, 1" Floor or 2" Freestanding Screens, freestanding storage, and credenzas provide openings for routing cables from one desk to another. Cable tray under the worksurface allows cable management
- Desks and Credenzas must be linked together with appropriate hardware when sharing hard wiring
- In a Spine Desk workstation, the Spine Desk mounting option (S) must be specified for each product to select appropriate harness length or mounting hardware

Power Box – Spine Desks (RLDUS, RLCUS)

- Available in single- and double-sided versions for individual or shared positioning
- Single- or double-sided configuration always comes with two shared brackets to fit on shared desks. However the single-sided configuration also comes with two additional single brackets to fit on single-sided desks

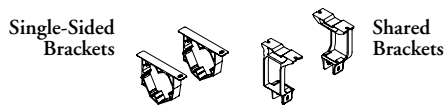

- Finished in a Platinum Coordinate

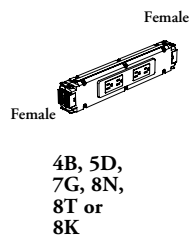

Power Box – Spine Desks (RLDUS)

This Power Box – Spine Desks (RLDUS) comes with the same electrical configurations than the Power Box – Modular Desks (RLDUM). For details, see page 171

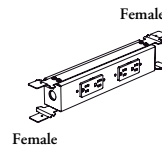

Chicago Power Box – Spine Desks (RLCUS)

- Includes the outlets but does not include any connectors
- Electrical connections must be done on-site by a certified electrician
- Each end has a 1/2" trade size knockout
- Feeds and Harnesses are not compatible with Chicago Power Box

power box position on spine desks

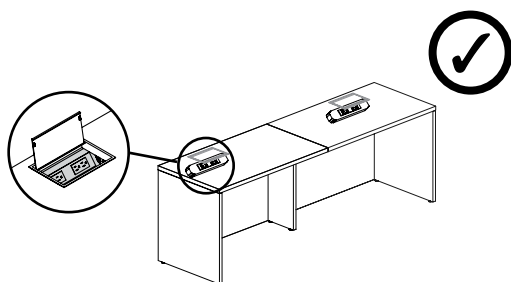

Spine Desks with Access Doors (D, E, R, L or M)

The Power Box position must correspond with the Access Door position

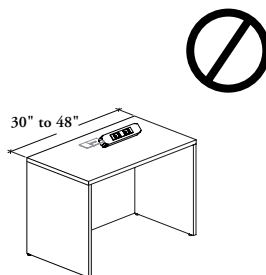

Spine Desks with Rectangular Grommets (B or C)

Power Box must be centered for desks from 30" to 48" with a centered (C) Rectangular Grommet. Other configurations do not limit the Power Box position

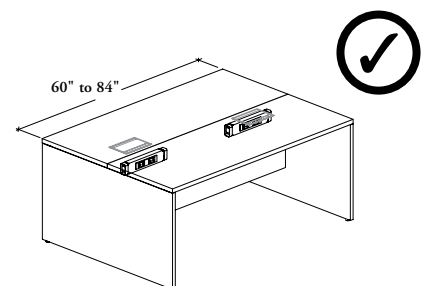

Spine Desks with multiple Power Boxes

A Power Box can be mounted at each end of desks from 60" to 84"

power & data distribution – spine desks (continued)

single-sided spine desk application – individual position

For this application, the Power Box (RLDU or RLCU) must be specified with Spine Desk (S) mounting option and single-sided application (S)



Single-Sided Brackets

- Only the single-sided brackets must be used for this configuration
- Must be fixed on a full or wall access modesty panel and under the worksurface
- The single-sided brackets allows mounting the Power Box in two orientations:
 - Facing upward (ideal position for Access Doors)
 - Facing downward (ideal position for Rectangular Grommets)
- Finished in a Platinum Coordinate

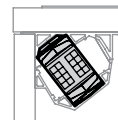

Up-Mounted Position

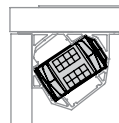

Down-Mounted Position

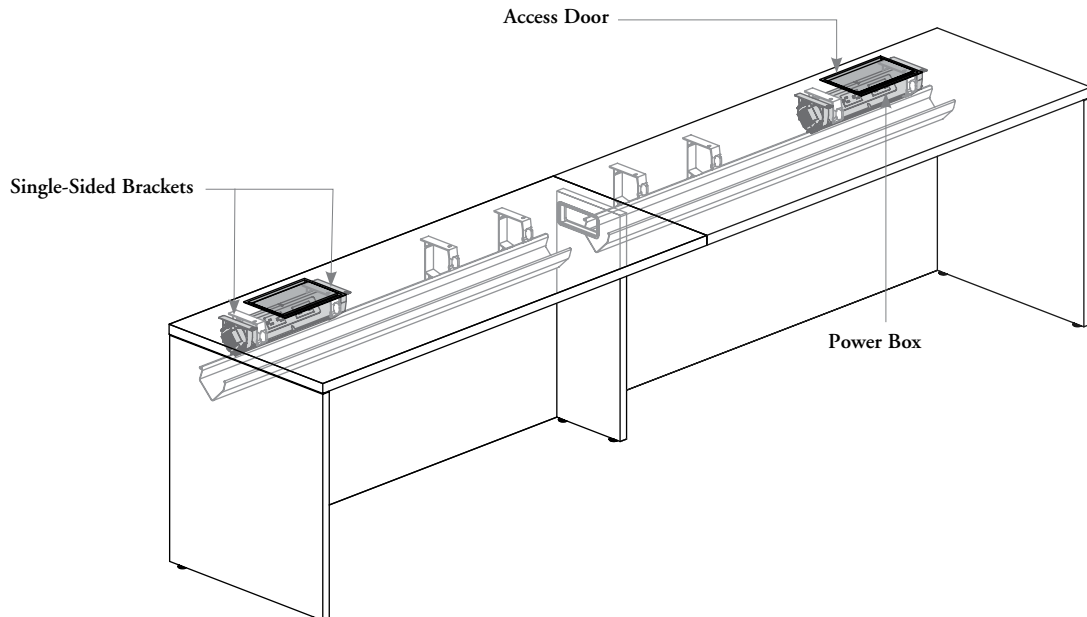

power & data distribution – spine desks (continued)

shared spine desk application – shared position

For this application, the Power Box (RLDU or RLCU) must be specified with Spine Desk (S) mounting option and double-sided application (D)

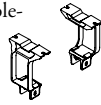

Shared Brackets

- Only the shared brackets must be used for this configuration
- Must be fixed on a raised modesty panel and under the worksurface
- The shared brackets allow mounting the Power Box in one orientation only

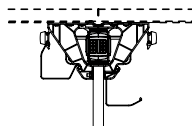

- Available in a Platinum Coordinate

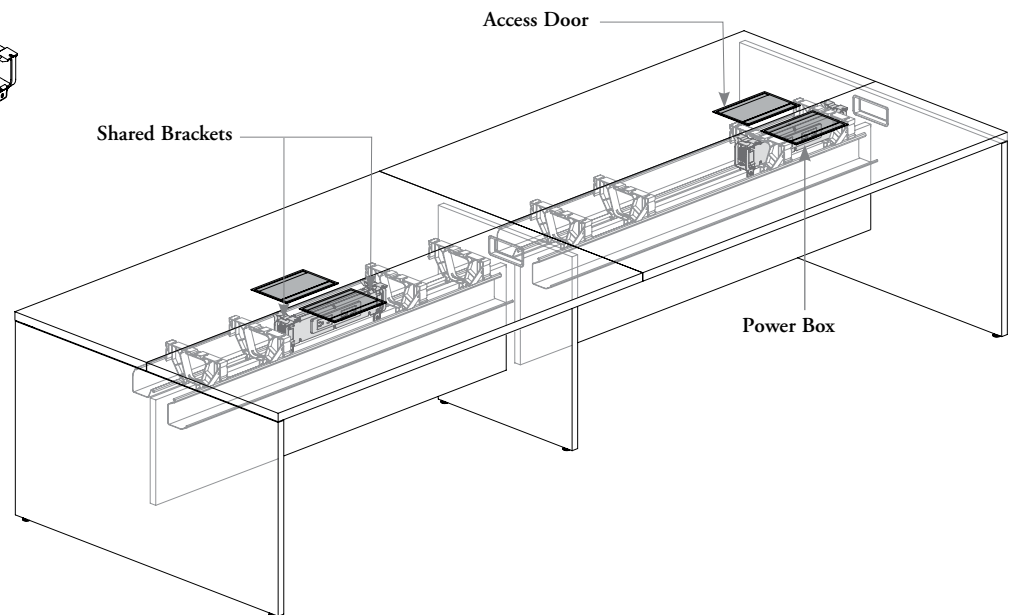

shared spine desk application – shared position and offset access doors

For this application, the Power Box (RLDU or RLCU) must be specified with Spine Desk (S) mounting option and single-sided application (S)

- The single-sided Power Box also comes with shared brackets allowing to mount single-sided Power Box onto Shared Spine Desks

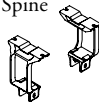

Shared Brackets

- Only the shared brackets must be used for the configuration where offset Access Doors (Left or Right) are specified
- Must be fixed on a raised modesty panel and under the worksurface
- Available in a Platinum Coordinate

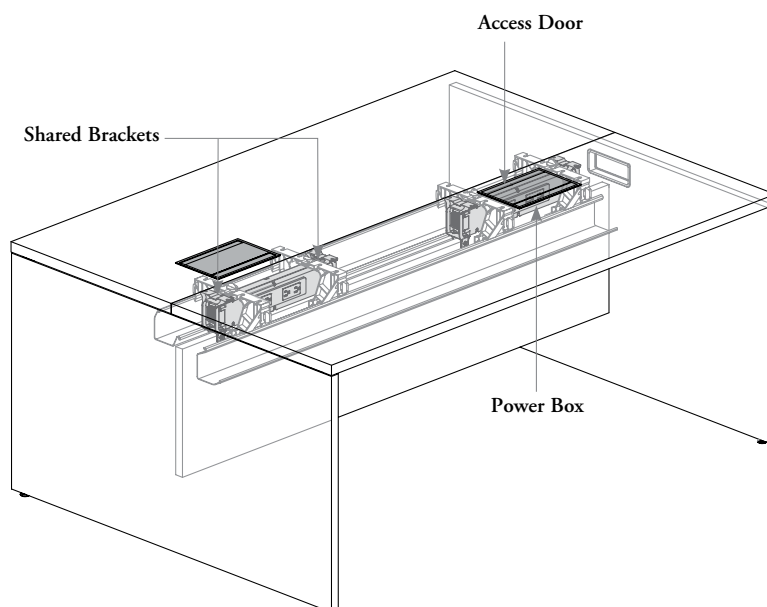

power & data distribution – spine desks (continued)

⚠ Do not energize from more than one source, it may cause serious injury

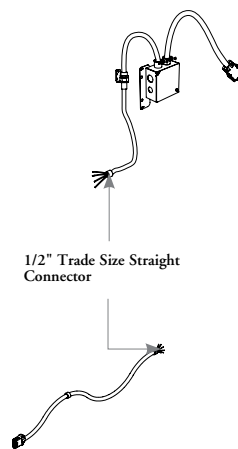

- NYC Split Base Feed – Spine Desks (RLBSA/C/O)**
- Same as the Base Feed, except that its hard wire is split in a Junction Box for New York City wiring restrictions
 - Junction Box comes with mounting bracket which must be installed underneath the desk
 - Allows routing hard wire through a Lateral Power Pole mounted on the outside of the gable
 - Does **not** allow routing hard wire through a storage or credenza product
 - For use in the United States only
 - **Not** compatible with a Lateral Power Pole mounted under the desk

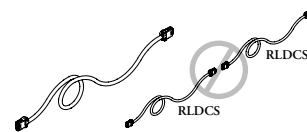

- Power Harness – Spine Desks (RLDCS)**
- Connects two Power Box – Spine Desks (RLDUS)
 - Available in 3" increments up to a maximum length of 156"

- Base Feed – Spine Desks (RLDBA/C/O)**
- Used alone or in conjunction with the Lateral Power Pole (RLPS)
 - Feeds building power from the floor or wall to the workstation
 - Desk width to which it is being attached and Power Box location (adjacent, center, opposite) from in-feed must be specified to ensure that correct length of feed is provided

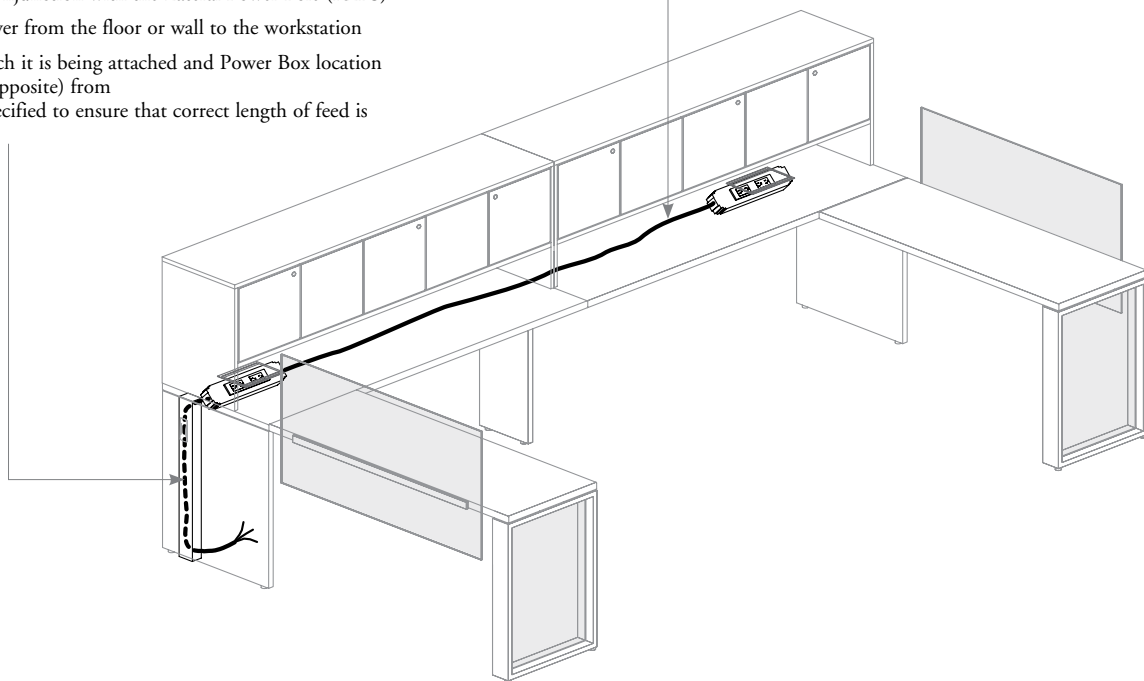

Cantilevers and Hinged Cable Tray

- Cantilevers come with Spine Desks and are used primarily for desk structure but can also be used for cable management
- Two cantilever styles are available:
 - for Single-Sided Spine Desks
 - for Shared Spine Desks
- A Hinged Cable Tray also comes with Spine Desks to provide cable management and hide electrical wires and communication cables

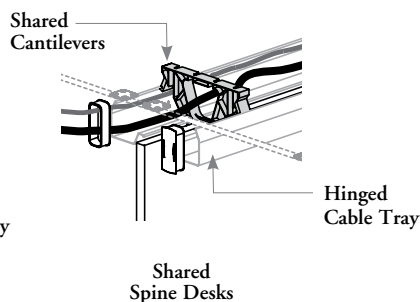
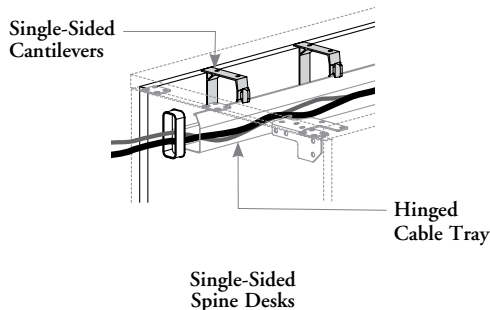

power & data distribution – spine desks (continued)

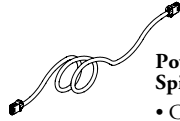

Power Harness Extension – Spine Desks (RLDS)

- Connects the Infeed (ceiling or base) to the first Power Box – Spine Desks (RLDUS) in a cluster if it is **not** adjacent
- Could be used as an extension with Power Harness – Spine Desks (RLDCS), if two Power Box (RLDUS) are **not** adjacent and total length exceeds maximum length available
- Available in 3" increments up to a maximum length of 138"

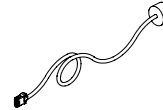
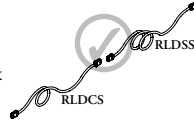

Ceiling Feed – Spine Desks (RLDFA/C/O)

- Used in conjunction with the Lateral Power Pole (RLPS)
- Feeds building power from the ceiling down to the workstation cluster
- Power Pole height, desk width to which it is being attached and Power Box location (adjacent, center, opposite) from in-feed must be specified to ensure that correct length of feed is provided

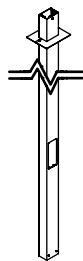
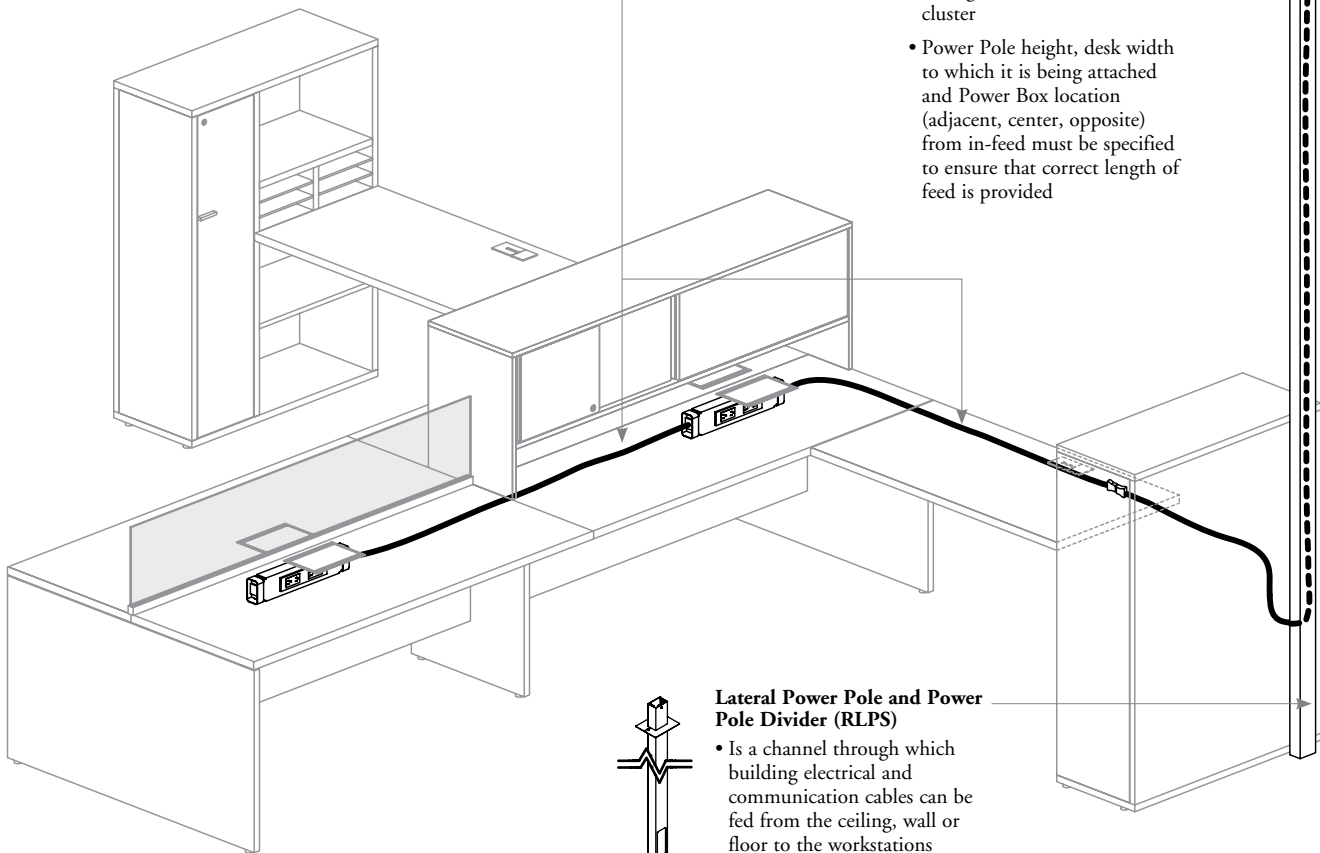

Lateral Power Pole and Power Pole Divider (RLPS)

- Is a channel through which building electrical and communication cables can be fed from the ceiling, wall or floor to the workstations
- Included divider can be used to separate electrical wires and communication cables
- 29" high Lateral Power Pole can only be installed against a gable when mounted under a desk

specifying correct power harness length – spine desks

- All harnesses can be specified in 4B, 5D, 7G, 8N, 8T and 8K shielded wiring systems
- All Power Harnesses have a nominal length for ease of specification
- When determining the proper length of Power Harness, always calculate from center to center of Power Box. A nominal sized harness will take into consideration the width of the power box
- When determining the proper length of infeed, always specify desk length, except when specifying an adjacent configuration (Base Feed and Ceiling Feed)
- Each Power Box can be located centered or at 15" from the worksurface edge of each end

configuration 1 – single-sided spine desks & power box

- 4B, 5D, 7G, 8N, 8T and 8K Single-Sided Power Box – Spine Desks

Power Harness – Spine Desks (RLDCS)

- Connects two Single-Sided Power Box – Spine Desks
- To specify the correct length, calculate the dimension between two Power Box, taking into account that a Power Box is located at 15" from an end when **not** centered

Linear Power Pole – 29" Base Configuration (RLPS)

Can be specified separately

example 1:

$$15 + (84 - 15) = 84 \quad (\text{RLDCS}_{84})$$

example 2:

$$15 + 15 = 30 \quad (\text{RLDCS}_{30})$$

example 3:

$$(84 - 15) + (84 - 15) = 138 \quad (\text{RLDCS}_{138})$$

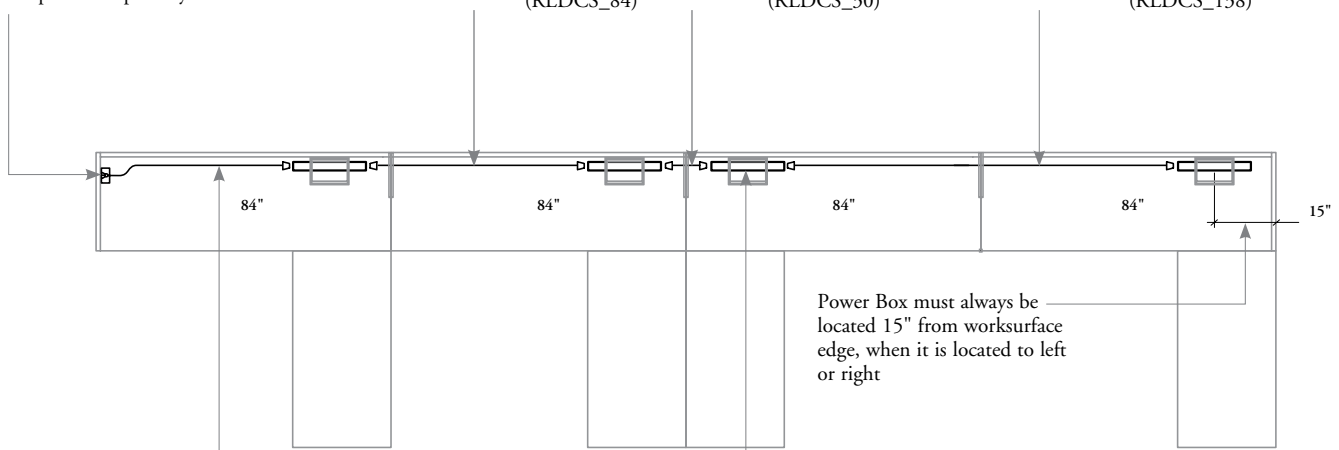

Power Box must always be located 15" from worksurface edge, when it is located to left or right

Base Feed – Spine Desks (RLDBO_84) or

NYC Split Base Feed – Spine Desks (RLBSO_84)

- Three Spine Desk mounting options are available:
 - Adjacent Power Position (A)
 - Centered Power Position (C)
 - Opposite Power Position (O)
 and must be specify to get the correct Base Feed harness length
- Centered and Opposite Power Positions require to specify the desk width for in-feeds

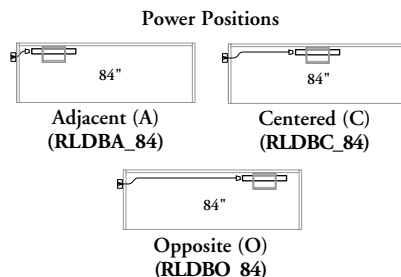

Single-Sided Power Box – Spine Desks (RLDUSS_)

Only the single-sided brackets must be used for this configuration

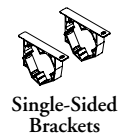

specifying correct power harness length – spine desks (continued)

configuration 2 – shared spine desks & single-sided power box

- 4B, 5D, 7G, 8N, 8T and 8K Single-Sided Power Box – Spine Desks

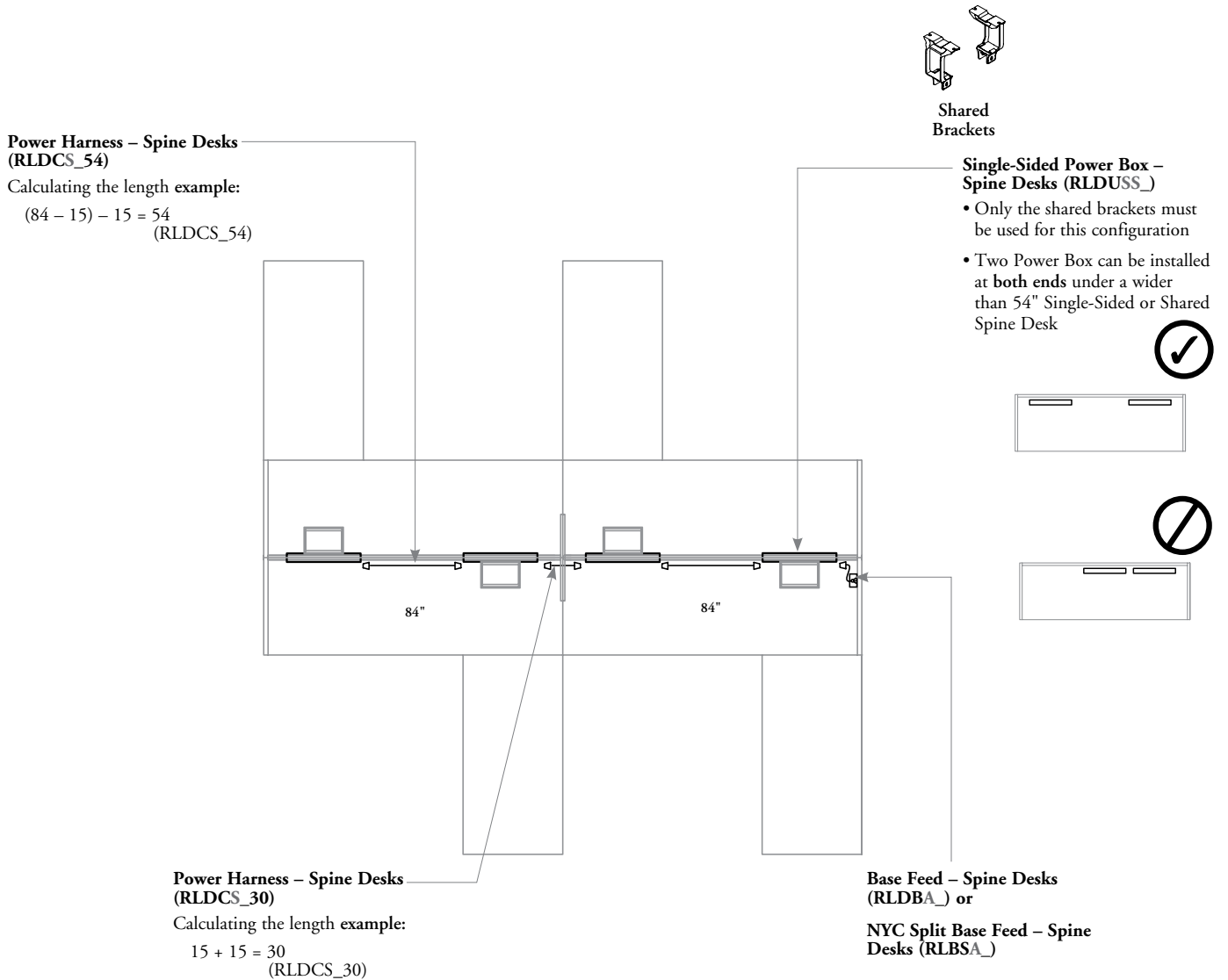

specifying correct power harness length – spine desks (continued)

configuration 3 – shared spine desks & double-sided power box

- 4B, 5D, 7G, 8N, 8T and 8K Shared Power Box – Spine Desks (Back-to-Back)

Ceiling Feed – Spine Desks (RLDFO_144_78)

- Three Spine Desk mounting options are available:
 - Adjacent Power Position (A)
 - Centered Power Position (C)
 - Opposite Power Position (O)
- and must specify to get the correct Ceiling Feed harness length

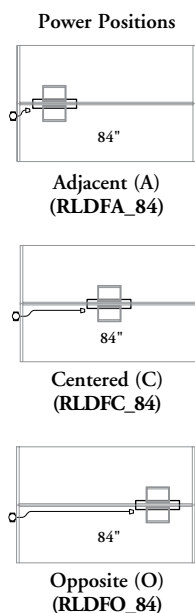

- The ceiling height must also be specified (96", 120", 144")
- Centered and Opposite Power Positions require to specify the desk width for in-feeds

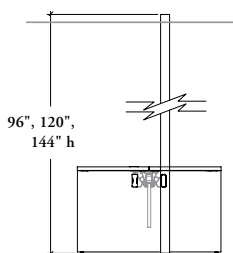

Power Harness – Spine Desks (RLDCS_)

Calculating the length

example 1:

$$(78 - 15) - 15 = 48$$

(RLDCS_48)

example 2:

$$15 + (78 - 15) = 78$$

(RLDCS_78)

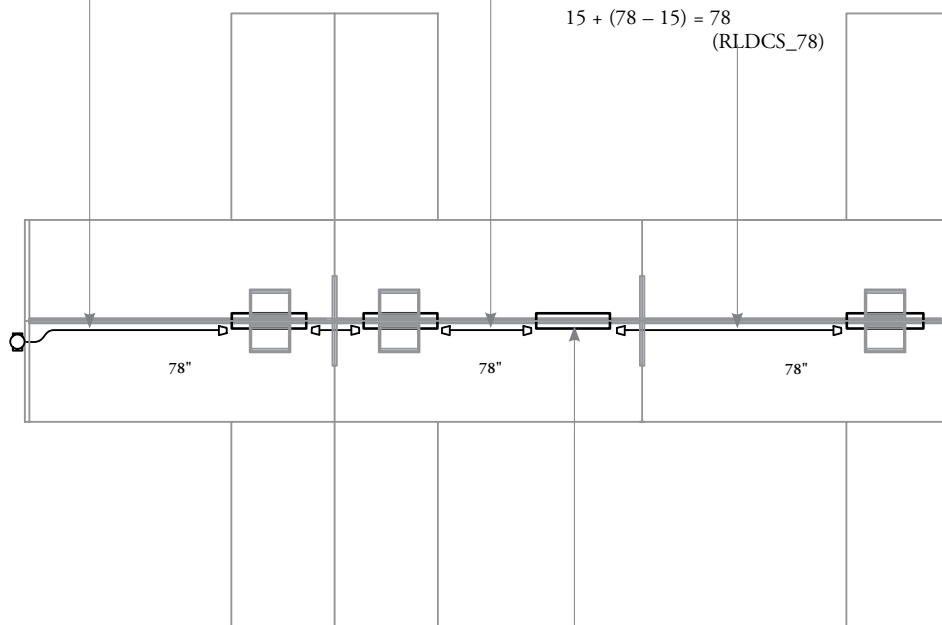

Shared Power Box – Spine Desks (RLDUSD_)

Only the shared brackets must be used for this configuration

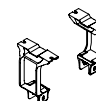

Shared Brackets

specifying correct power harness length – spine desks (continued)

configuration 4 – shared spine desks & double-sided power box

- 4B, 5D, 7G, 8N, 8T and 8K Shared Power Box – Spine Desks (Back-to-Back)

Power Harness – Spine Desks (RLDCS_96)

If a Power Harness is going through a "non-electrical" desk, then add the width of the in-between desk(s)

example:

$$(60 \div 2) + 48 + (60 \div 2) = 108$$

(RLDCS_108)

Shared Power Box – Spine Desks (RLDUSD_)

Only the shared brackets must be used for this configuration

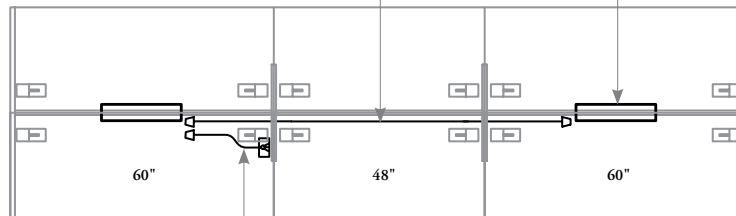
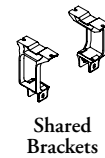

Base Feed – Spine Desks (RLDBC_60) or

NYC Split Base Feed – Spine Desks (RLBSO_60)

Centered and Opposite Power Positions require to specify the desk width for in-feeds

specifying correct power harness length – spine desks (continued)

⚠ Wiring through credenzas or freestanding storage will require adding a different loop length in Single-Sided Spine Desks than in Shared Spine Desks

configuration 5 – single-sided spine desks & storage with cable pass-through

- 4B, 5D, 7G, 8N, 8T and 8K Single-Sided Power Box – Spine Desks

Power Harness – Spine Desks (RLDCS_138)

Add 3" for every loop when a Power Harness (RLDCS_) or Power Harness Extension (RLDSS_) has to pass through storage in a Single-Sided Spine Desk application

example:

$$(66 - 15) + 3 + 30 + 3 + (66 - 15) = 138$$

(RLDCS_138)

Ceiling Feed – Spine Desks (RLDFA_)

- Is **not** necessary to add extra harness length when a Power Pole is connected to a 1" Floor Screen, a 2" Freestanding Screen, a Freestanding Storage or a Credenza
- Ceiling or Base Feed must be specified with Adjacent Power Position (A) mounting option when the harness starts directly from a storage

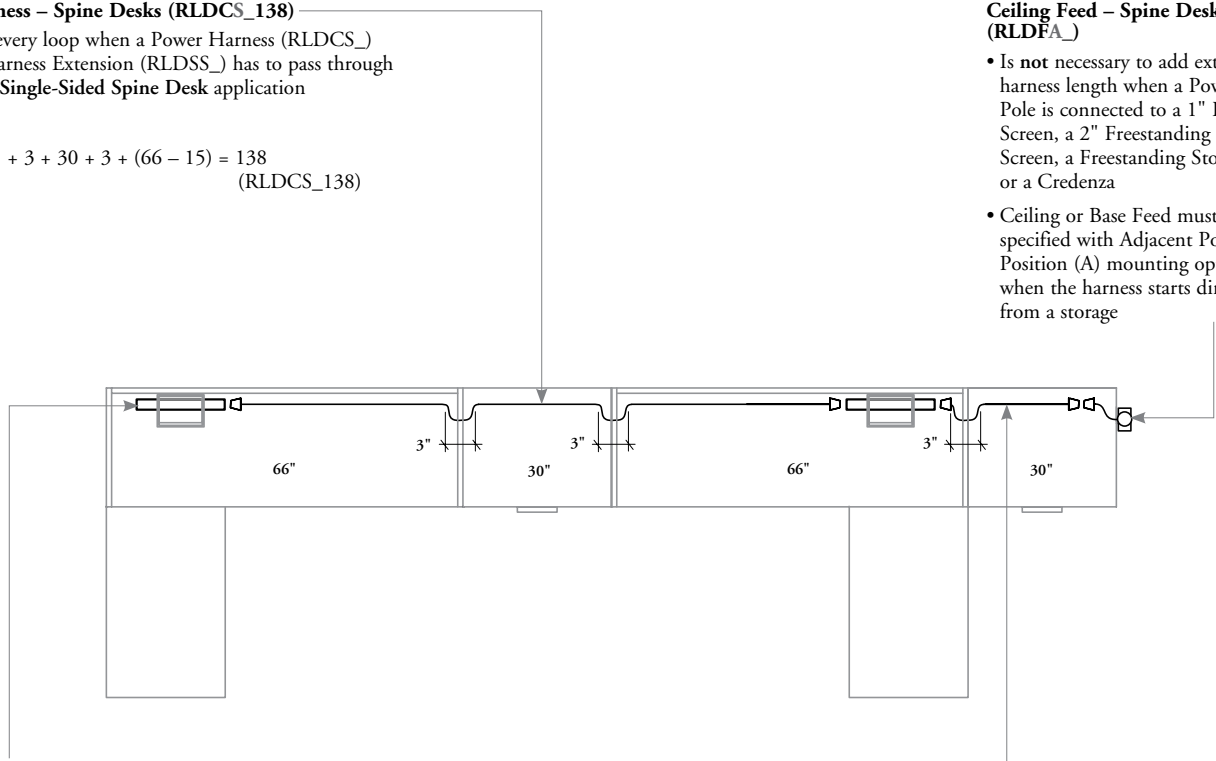

Single-Sided Power Box – Spine Desks (RLDUSS_)

Only the single brackets must be used for this configuration

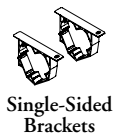

Single-Sided Brackets

Power Harness Extension – Spine Desks (RLDSS_33)

- Power Harness Extension is used to connect Ceiling or Base Feed to first Power Box (RLDUS) when it is **not** located in the first furniture unit
- Correct length is specified the same way than a Power Harness for a desk with an adjacent Power Box

example:

$$15 + 3 + (30 - 15) = 33$$

(RLDSS_33)

specifying correct power harness length – spine desks (continued)

configuration 6 – shared spine desks & storage with cable pass-through

- 4B, 5D, 7G, 8N, 8T and 8K Shared Power Box – Spine Desks

Power Harness – Spine Desks (RLDCS_108)

Add 6" for every loop when a Power Harness (RLDCS_) or Power Harness Extension (RLDSS_) has to pass through storage in a Shared Spine Desk application

example:

$$(66 \div 2) + 6 + 30 + 6 + (66 \div 2) = 108$$

(RLDCS_108)

Power Harness Extension – Spine Desks (RLDSS_108)

To specify correct Power Harness Extension length, calculate the distance between in-feed connector and first Power Box

example:

$$(66 \div 2) + 24 + 42 + (24 - 15) = 108$$

(RLDCS_108)

Shared Power Box – Spine Desks (RLDUSD_)

Only the shared brackets must be used for this configuration

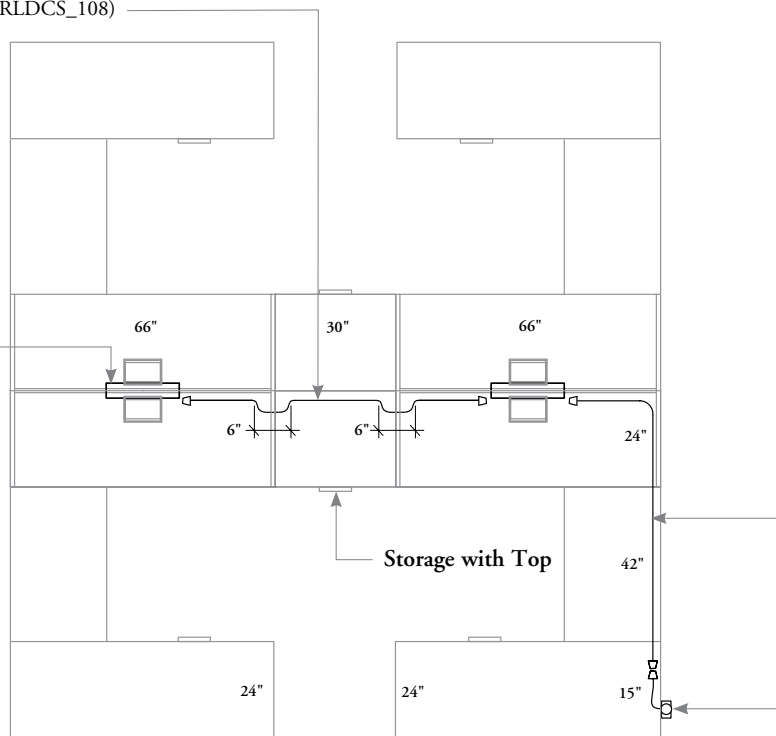
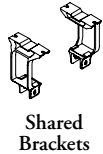

Ceiling Feed – Spine Desks (RLDFA_)

Always specified with Adjacent Power Position (A) when the Power Box is **not** located in the first furniture unit

Worksurface Wire Management Clips (YESW)

- Used to easily manage wires underneath the worksurface, must be specified separately
- Data and power cables can be managed separately without tools
- Available from Complements: *Teknion's Ergonomic & Accessories* program

specifying correct power harness length – spine desks (continued)

⚠ Wiring through end gables will require adding a different loop length in Single-Sided Spine Desks than in Shared Spine Desks

configuration 7 – single-sided spine desks & cable pass-through

- 4B, 5D, 7G, 8N, 8T and 8K Single-Sided Power Box – Spine Desks

Power Harness or Power Harness Extension – Spine Desks (RLDCS_ or RLDSS_)

Add 3" for every loop when a harness has to pass through an End Gable, a 1" Floor Screen or a 2" Freestanding Screen in a Single-Sided Spine Desk application

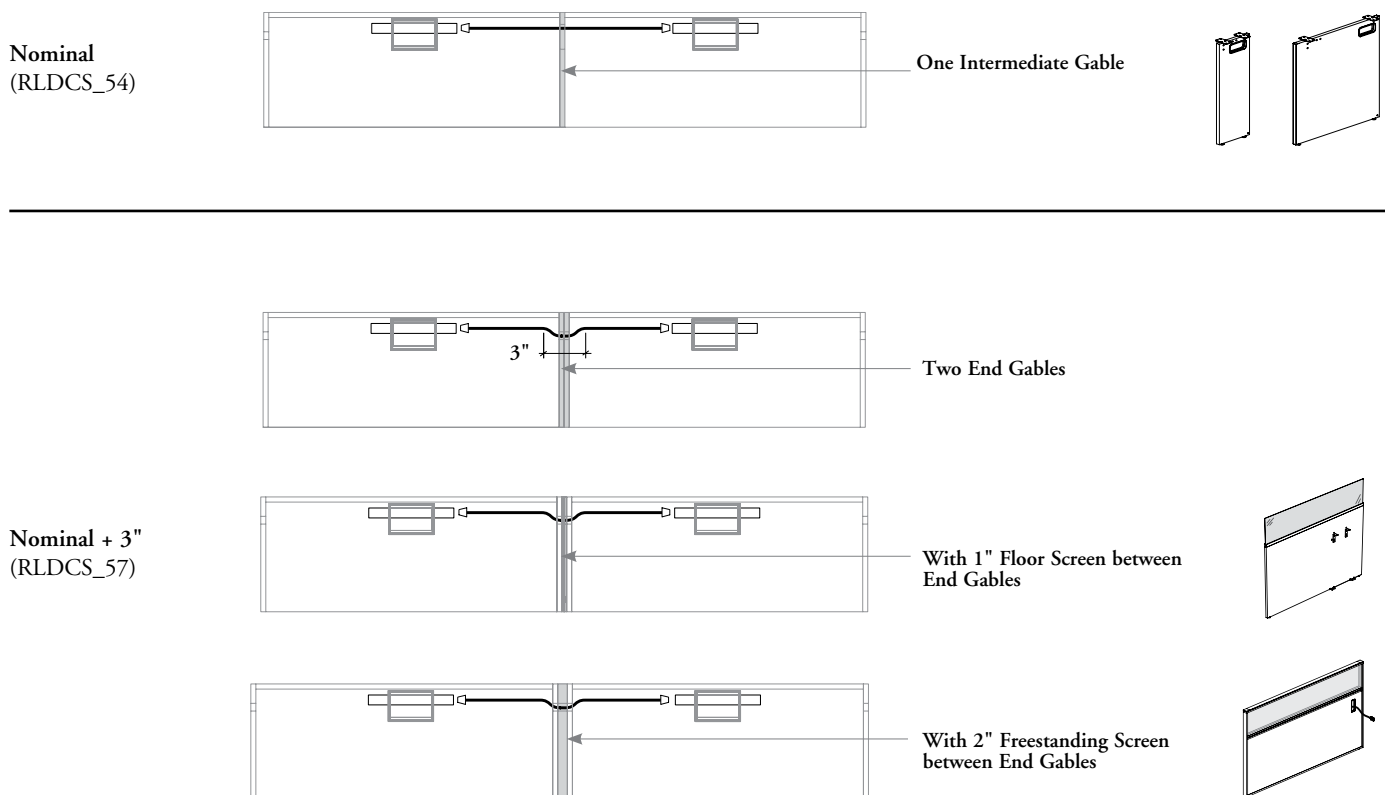

specifying correct power harness length – spine desks (continued)

configuration 8 – shared spine desks & cable pass-through

- 4B, 5D, 7G, 8N, 8T and 8K Shared Power Box – Spine Desks

Power Harness or Power Harness Extension – Spine Desks (RLDCS_ or RLDSS_)

Add 6" for every loop when a harness has to pass through an End Gable, a 1" Floor Screen or a 2" Freestanding Screen in a Shared Spine Desk application

Nominal
(RLDCS_54)

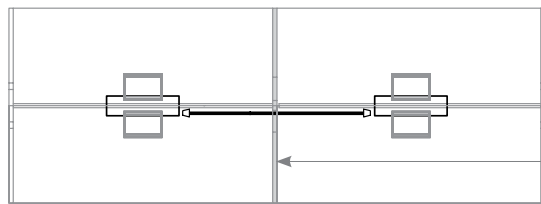

One Intermediate Gable

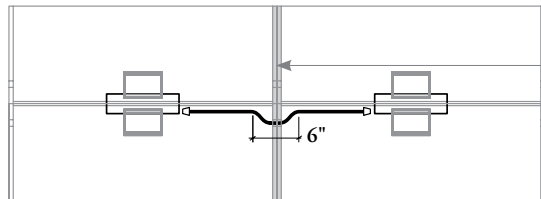
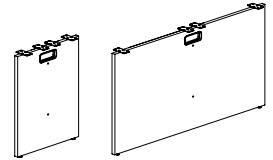

Two End Gables

Nominal + 6"
(RLDCS_60)

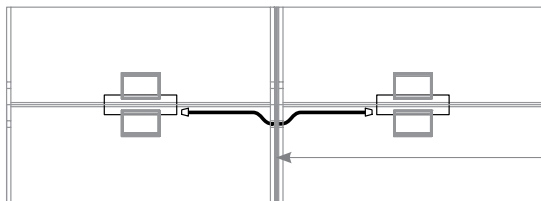

With 1" Floor Screen between End Gables

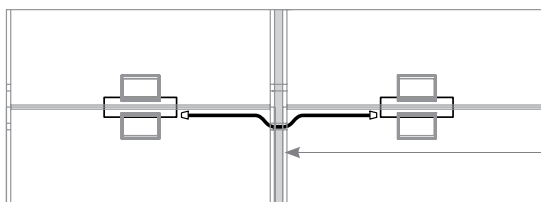
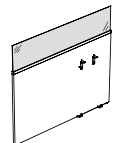

With 2" Freestanding Screen between End Gables

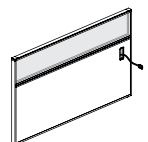

power & data distribution – modular & spine desks

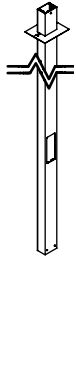

Lateral Power Pole (RLPS)

- May be used for two applications:
 - **Ceiling Feed:** is a channel through which building electrical and communication cables can be fed from the ceiling to workstations
 - **Base Feed:** feeds building power from the floor or wall to the workstation
- In-feeds are **not** included
- Included divider can be used to separate electrical wires and communication cables
- Can be mounted on gables using the Cable Pass-Through or vertical grommet
- Only base feed application can be mounted to the inner side of a gable
- **Cannot** be mounted along a modesty panel
- Can also be mounted on credenzas, freestanding storage, 1" Floor Screen and 2" Freestanding Screen with the Cable Pass-Through option
- Available in Foundation or Mica colors

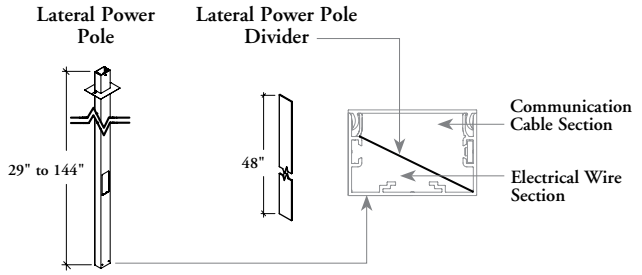

Data/Communication Cable Capacity

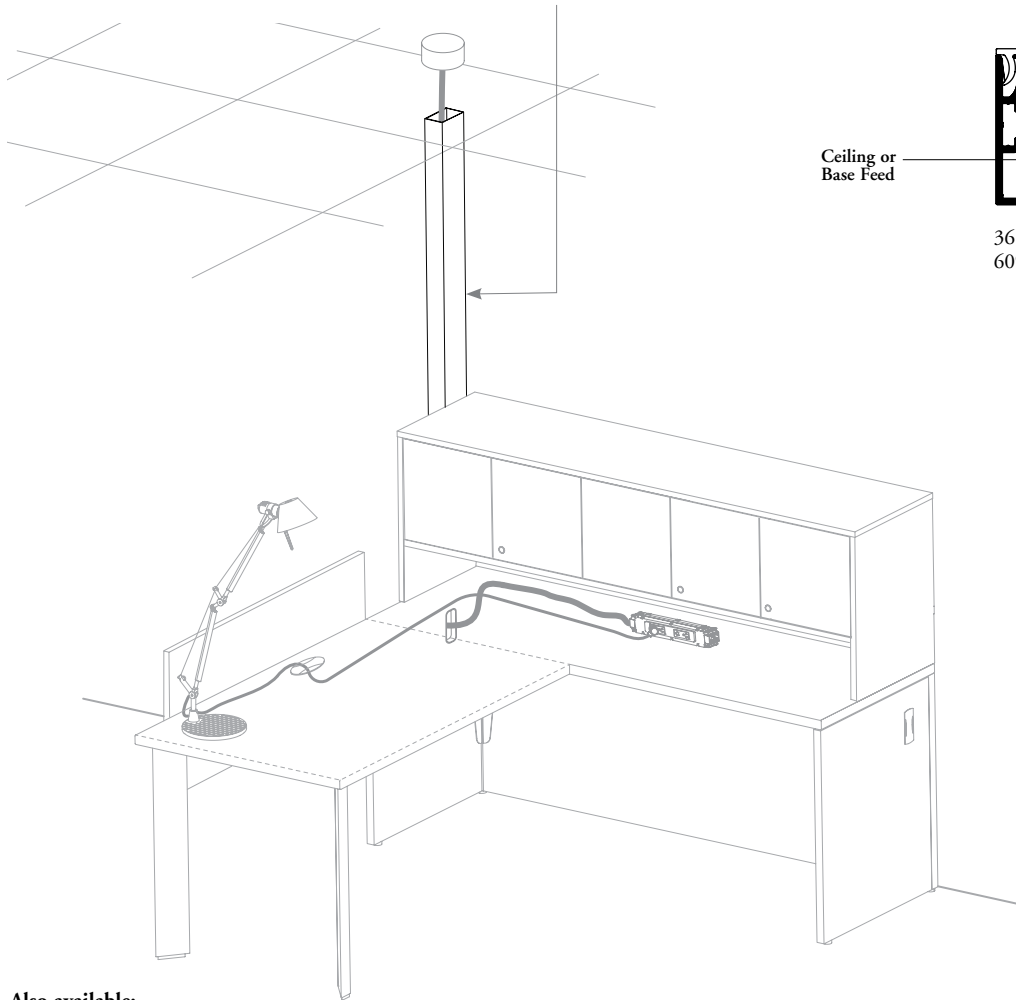
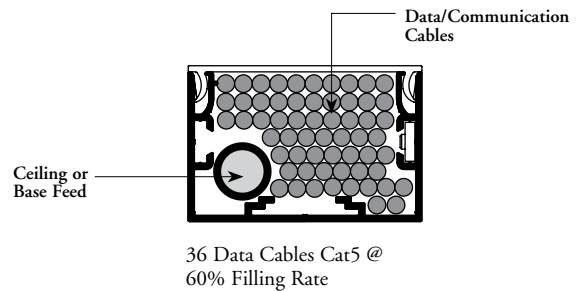

Also available:

Power/Data Center (RLDMC)

- Opens up through the worksurface to provide power, data and USB access. It closes to allow the use of the entire worksurface
- Must be field-installed as per template included
- Voice/Data jacks are **not** included and must be field supplied and installed
- Plugs directly into standard receptacles
- This product includes a 72" or 120" cord length
- Finished in Ebony (E) or Soft Gris (B)



Power Simplex Receptacle	USB	Communication Opening	Configuration
2	2	1	221
3	0	1	301



Communication Box (RLUDB)

- The communication opening measures 2.71" x 1.38" to accommodate Voice/data jacks and faceplates (**not** included)
- Finished in a Platinum Coordinate

power & data distribution – modular & spine desks (continued)

- All products below can be specified separately
- Can also be specified as an option on desks. The surface will come with pre-drilled holes for easy installation on-site
- Only Desking Worksurface Grommet (RAG3) can be interchangeable with Rectangular Grommet (RAGC) and vice versa

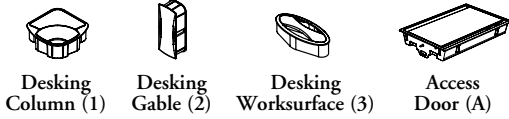

Desking Grommets (RAG)

- Can be specified separately and four styles are available:
 - Desking Column (1)
 - Desking Gable (2)
 - Desking Worksurface (3)
 - Access Door (A)
- Grommets are available in Foundation, Mica or Source Laminate colors. Access Doors are available in Foundation or Mica colors only
- Access Doors can only be specified with Spine Desks



Rectangular Grommets (RAGC)

- Are available in Foundation or Mica cover finishes
- Rectangular Grommet Ring is finished in Ebony only
- Rectangular Grommet Applications:

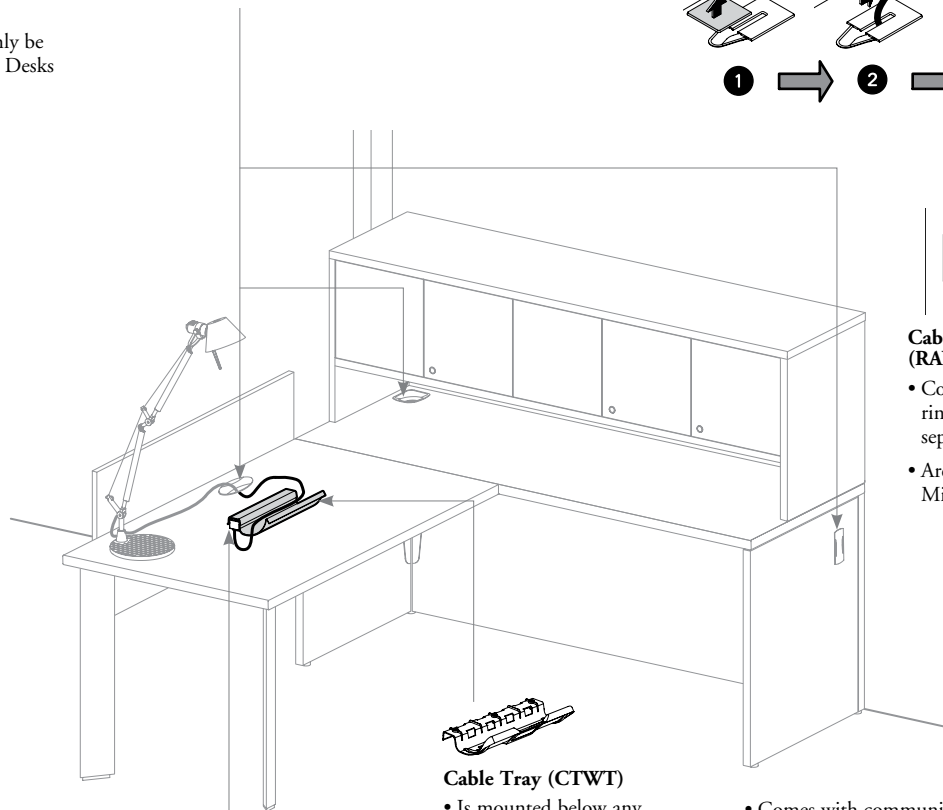
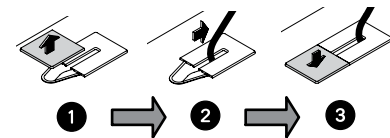

Cable Pass-Through Covers (RAWPC)

- Covers the Cable Pass-Through ring and can be specified separately
- Are available in Foundation, Mica or Coordinate Colors



Cable Tray (CTWT)

- Is mounted below any worksurface to manage cables coming from the worksurface level
- Allows installation of Underworksurface Plug-In Power Bar (RLPP) only
- Comes with communication opening measures 2.71" x 1.38" to accommodate Voice/data jacks and faceplates (not included)
- Finished in Black



Underworksurface Plug-In Power Bar (RLPP)



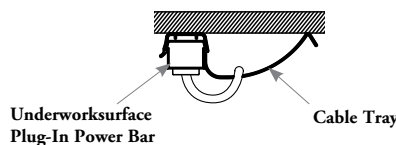



- This product can be clipped on the Structural Beam of Modular Desks or can be dropped in the Hinged Cable Tray of Spine Desks. It can also be mounted underneath worksurfaces using a Cable Tray (ordered separately)
- Provides a 3-wire system that can be used to connect up to four pieces of electrical equipment and includes a resettable breaker
- This product includes a 72" or 180" cord length
- Finished in Clear Anodized

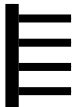

wiring systems

The following provides general information on the wiring system offering in Expansion Desking.

⚠ It is important to specify each power and cable management product according to the wire system in use; see example below

	No. Regular Circuits	No. Isolated Circuits
3-Wire (Plug-in) [3P]  Circuit 1 (Black) Neutral (White) Ground (Green)	1	0
4-Wire (4B)  Circuit 1 (Black) Circuit 2 (Red) Neutral (White) Ground (Green)	2	0
5-Wire (5D)  Circuit 1 (Black) Circuit 2 (Red) Circuit 3 (Blue) Neutral (White) Ground (Green)	3	0
7-Wire Isolated (7G)  Circuit 1 (Black) Circuit 2 (Red) Neutral (White) Ground (Green) Isolated Circuit 5 (Orange) Isolated Neutral (White/Orange) Isolated Ground (Green/Orange)	2	1
8-Wire Isolated – Separate Neutral (8N)  Circuit 1 (Black) Neutral (White) Circuit 2 (Red) Neutral (White/Red) Ground (Green) Isolated Circuit 5 (Orange) Isolated Neutral (White/Orange) Isolated Ground (Green/Orange)	2	1
8-Wire Isolated (8T)  Circuit 1 (Black) Circuit 2 (Red) Circuit 3 (Blue) Neutral (White) Ground (Green) Isolated Circuit 5 (Orange) Isolated Neutral (White/Orange) Isolated Ground (Green/Orange)	3	1
8-Wire Dual Isolated (8K)  Circuit 1 (Black) Circuit 2 (Red) Neutral (White) Ground (Green) Isolated Circuit 5 (Orange) Isolated Circuit 6 (Blue) Isolated Neutral (White/Orange) Isolated Ground (Green/Orange)	2	2

• Example, if the system in use is 7-Wire Isolated (7G), each Base Feed, Ceiling Feed, Power of Harnesses and Distribution Box must be specified for 7G, as follows:

System	Product Name	Product Code
7G	Base Feed	RLDBM7G
	Power Harnesses and Extension	RLDCM7G, RLDSM7G
	Distribution Box	RLDSB7G
	Power Box	RLDUM7G
	Worksurface Power and Communication Center	RLDCC7G

- This specification is **not** required for lighting products. However, **not** all products are available for all wire systems
- Desks include electrical wire and communication cable routing capabilities
- There is a standard color coding for each wiring system and for the connector patterns in conjunction with these:
 - Standard Circuit 1, Hot Wire: Black
 - Standard Circuit 2, Hot Wire: Red
 - Standard Circuit 3, Hot Wire: Blue
 - Isolated Circuit 5, Hot Wire: Orange
 - Isolated Circuit 6, Hot Wire: Blue
 - Standard Neutral Wire: White
 - Standard Ground Wire: Green
 - Isolated Neutral Wire: White/Orange stripe
 - Isolated Ground Wire: Green/Orange stripe
- In wiring systems with more than one incoming hot wire, some or all of the hot wires use the same neutral and ground. For example, in the 5-Wire (5D) system, there are three hot wires. All three hot wires use the same neutral/return wire and the same ground wire. The 8-Wire Separate Neutral (8N) system provides one neutral wire for each hot wire

international electricians



international electrics

INTERNATIONAL ELECTRICS BASICS 198

international electrics basics

Expansion Desking utilizes standard International Electric components, as well as Expansion Desking – specific components.

- International Electrics are made with a single circuit, 3-wire directional system
- Power outlet types are available for different regions and have options for fuses and switches

Outlet Types	Country of Installation
 I	Australia & Argentina
 F	Germany
 G	U.K. & Ireland

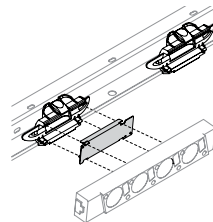

Desking Adapter for International Electrics (RLI_B)

- Used to attach an Outlet Box (VED) or Voice and Data Box (VVD) to a desk
- Three mounting options are available:
 - Modular Desks (M) (Shown)
 - Spine Desks – Double-Sided (D)
 - Spine Desks – Single-Sided (S)
- Mounting option must be specified according to the desk configuration under which the adapter is installed
- One adapter must be ordered for each outlet or Voice and Data Box, even with the Spine Desks – Shared (D) mounting option

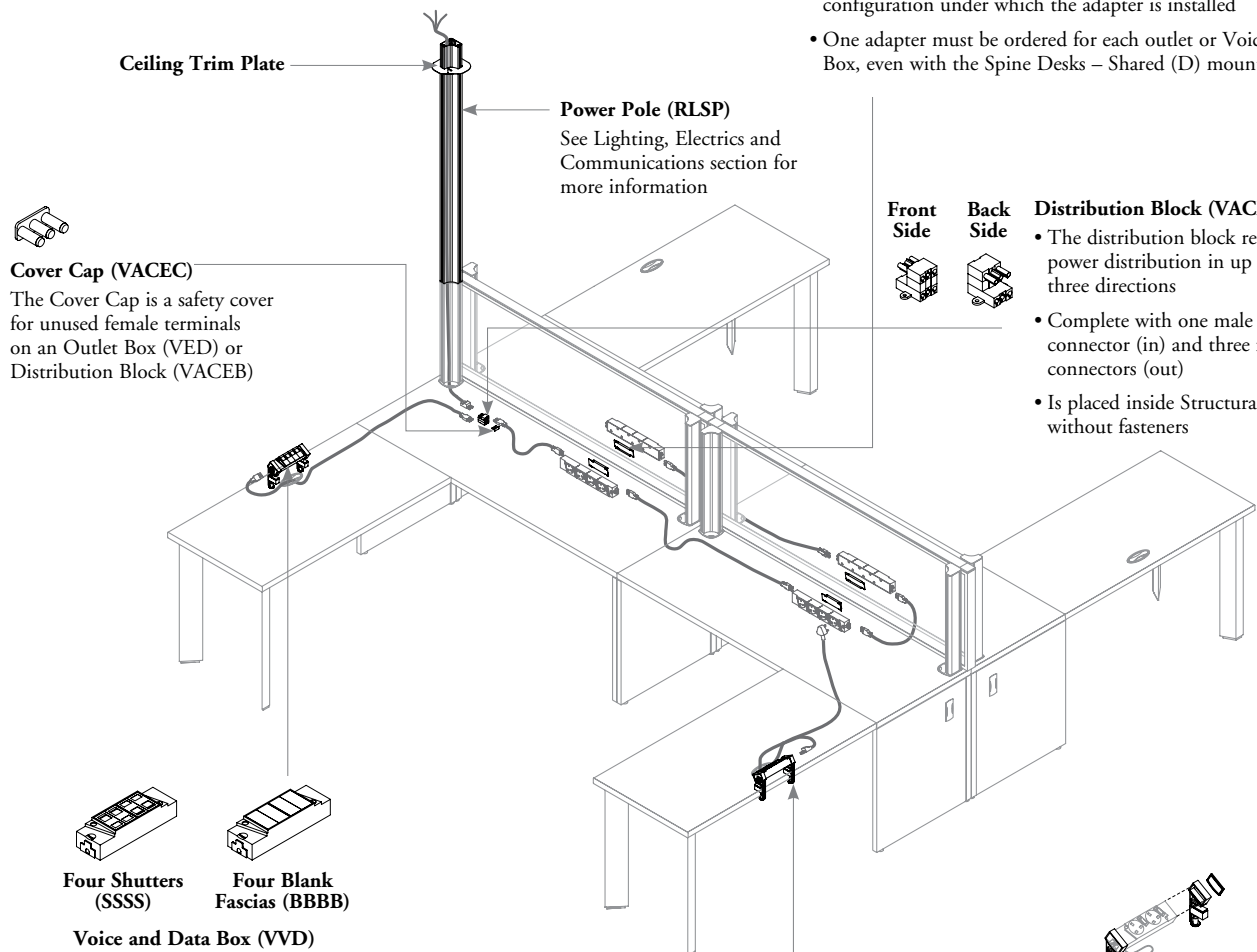

Cover Cap (VACEC)
The Cover Cap is a safety cover for unused female terminals on an Outlet Box (VED) or Distribution Block (VACEB)

Front Side **Back Side** **Distribution Block (VACEB)**

- The distribution block redirects power distribution in up to three directions
- Complete with one male connector (in) and three female connectors (out)
- Is placed inside Structural Beam without fasteners

Four Shutters (SSSS) **Four Blank Fascias (BBBB)**

Voice and Data Box (VVD)

- Provides the user with access to communications and data cables
- Comes with blanks or shutters
- Can be mounted below a desk with a Desking Adapter for International Electrics (RLI_B) or to the edge of a worksurface with Desk Mounting Clips (VACB6)

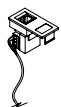
 **Voice and Data Outlets (VDO)**
The data box outlets are inserted into the Voice and Data Box (VVD) and are ordered separately

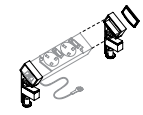
 **Desk-Mounting Clips for Outlet Box (VACB6)**

- Can only be used on the side of the worksurface that is semi-supported
- Used to attach an Outlet Box (VED) or Voice and Data Box (VVD) above the worksurface; fits all sizes

international electrics basics (continued)

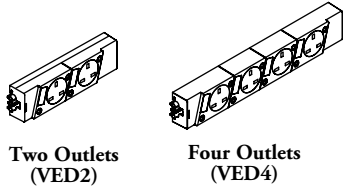

Two Outlets (VED2)

Four Outlets (VED4)

Outlet Box (VED)

- Provides access to power above and below worksurface
- Can be mounted below a desk with a Desking Adapter for International Electrics (RLI_B) or below a worksurface with Desk Mounting Clips (VACB6)
- Power outlets have a socket angle of 15°
- Faceplates are included with outlets and voice/data boxes
- Two configuration are available:
 - Two outlets (2)
 - Four outlets (4)
- Only three of the Four Outlets (4) configuration will be reachable through an Access Door

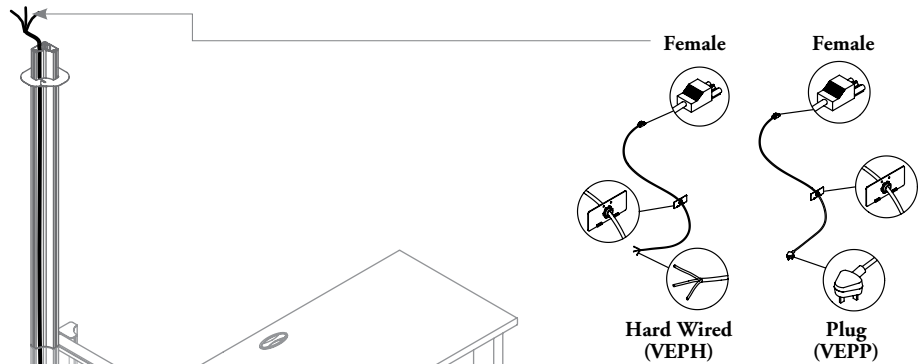

Female

Female

Hard Wired (VEPH)

Plug (VEPP)

Input Power Cable (VEP)

- Brings power from the building to an Outlets Box (VED)
- Available with two plugs types, hard wired or plug

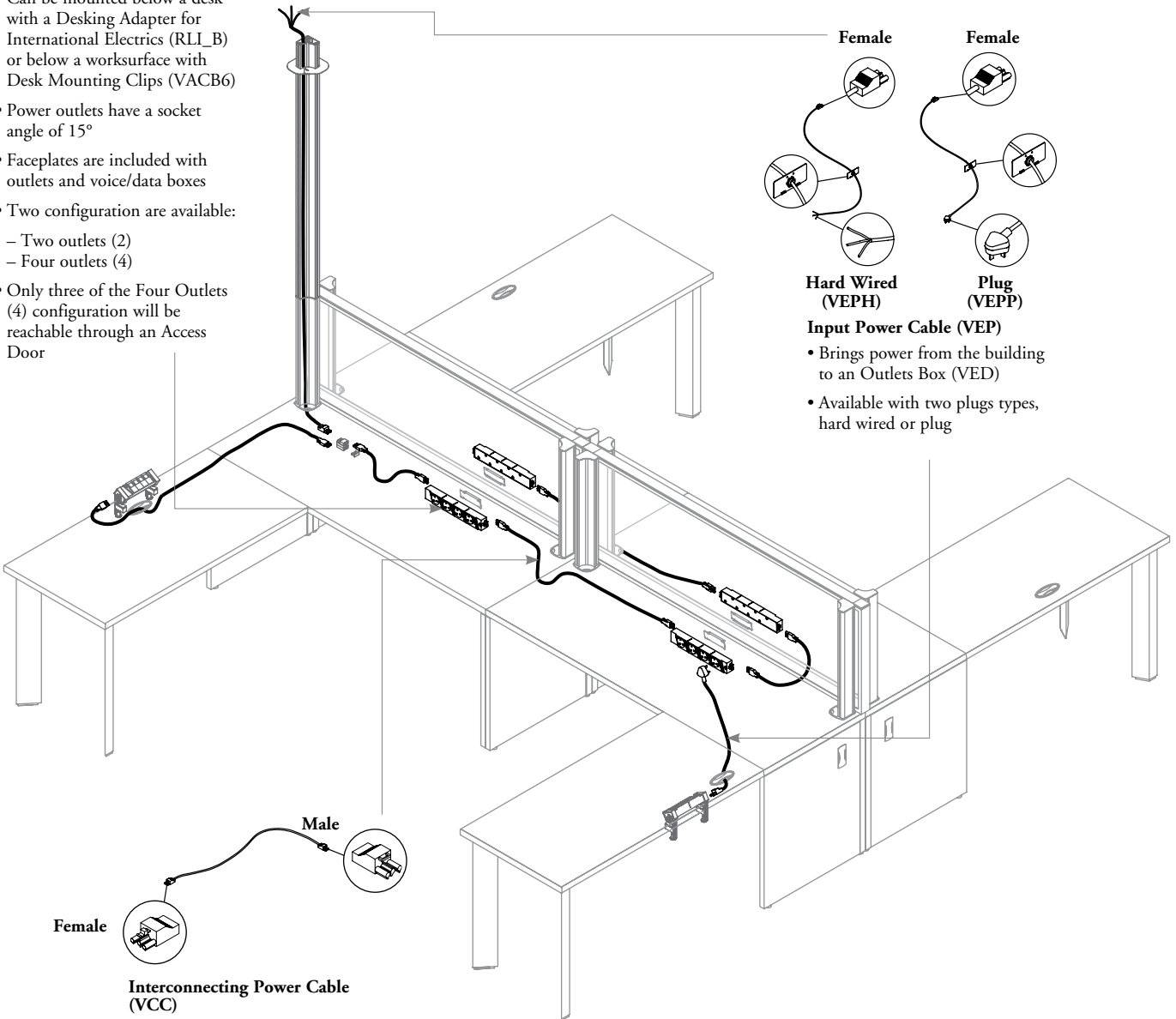

Male

Female

Interconnecting Power Cable (VCC)

Routes power between outlet boxes or distribution block under a desk and carries to next desk

price & product guide

price & product guide

MODULAR DESKS	203
SPINES DESKS	251
DESK ACCESSORIES	285
COLUMNS & SCREENS	309
COUNTERTOPS	391
MOUNTED STORAGE & ACCESSORIES	397
CREDENZAS	425
FREESTANDING STORAGE & ACCESSORIES	445
LIGHTING, ELECTRICS & COMMUNICATIONS	493
INTERNATIONAL ELECTRICS	527

modular desks

modular desks product map

R U D R Single Structure L-Shaped Desk – Full Gables

Page 206

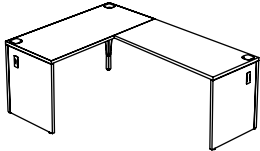

R U R R Single Structure L-Shaped Desk with Radius Corner – Full Gables

Page 210

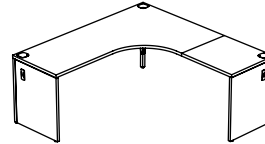

R D A R Rectangular Desk with Visitor Access – Full Gables

Page 212

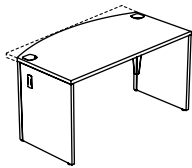

R D R R Rectangular Desk – Full Gables

Page 214

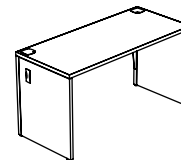

R D R S Rectangular Desk – Full and Half Gables

Page 216

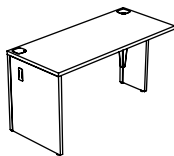

R D R D Rectangular Desk – Half Gables

Page 218

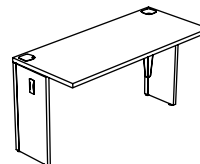

R D F S Cross Grain Rectangular Desk with – Full and Half Gables

Page 220

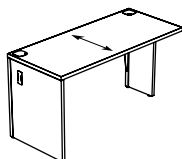

R D F D Cross Grain Rectangular Desk with – Half Gables

Page 222

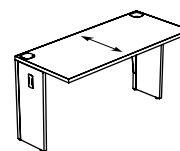

modular desks product map

R V S S Concave Transition Desk – Full and Half Gables

Page 224

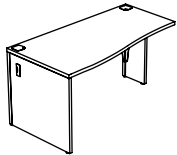

R V R D Radius Corner Desk – Half Gables

Page 225

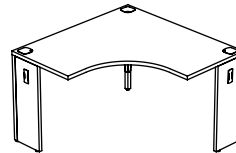

R D S D Standard Corner Desk – Half Gables

Page 226

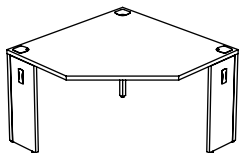

R T S R Standard Radius Corner Desk – Half Gables

Page 227

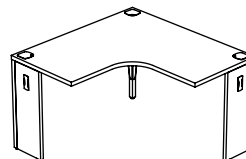

R V U R Extended Corner Desk – Full Gables

Page 228

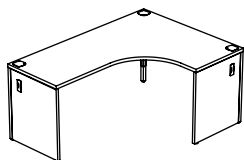

R V U S Extended Corner Desk – Full and Half Gables

Page 230

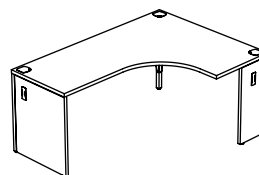

R V U D Extended Corner Desk – Half Gables

Page 232

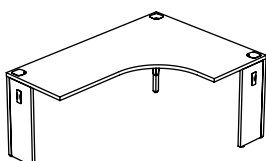

R T L D L Rectangular Worksurface

Page 234

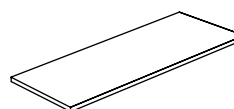

modular desks product map

R T L D C Cross Grain Rectangular Worksurface

Page 236

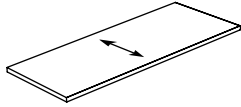

R D R P Rectangular Peninsula Desk – Half Gables

Page 238

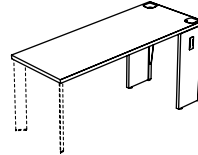

R D B N D-Shaped Peninsula Worksurface

Page 239

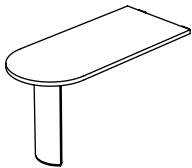

R D B U D-Shaped Peninsula Desk – Half Gables

Page 240

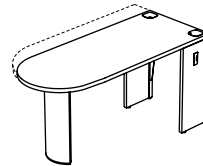

R V D D Extended D-Shaped Peninsula Desk – Half Gables

Page 242

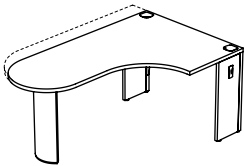

R V X D Extended P-Shaped Peninsula Desk – Half Gables

Page 244

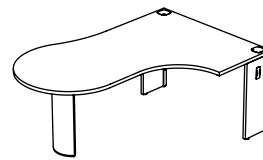

R D P D P-Shaped Peninsula Desk – Half Gables

Page 246

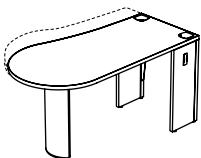

R T R T Rectangular Table

Page 248

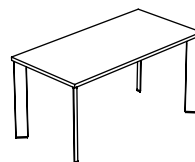

modular desks

Xpress

R U D R

Single Structure L-Shaped Desk – Full Gables

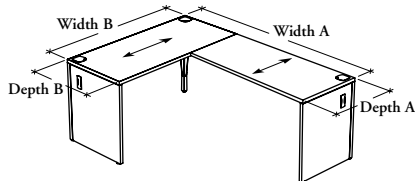

This fixed-height desk combines two rectangular worksurfaces allowing users to work on either side of the workstation.

WHAT'S INCLUDED

2 worksurfaces, 3 metal corner posts with levelers, 2 structural beams, 2 full gables with levelers, 1 assembly plate, wire management clips, grommets, and hardware.

WHAT'S EXCLUDED

Flush-Mounted Modesty Panels.

NOTES

Worksurfaces **cannot** be used individually.

PRODUCT OPTIONS

Gable Style	Depth A	Depth B	Width A	Width B	Return Configuration	Worksurface Finish	Edge Trim Style	Edge Trim Finish	Gable and Grommet Finish
L Laminate	24, 30	24, 30	66, 72, 78, 84	66, 72, 78, 84	L Left	Foundation Laminate	6 Straight Trim	Edge Trim Colors (for trim style 6)	Source Laminate
M Metal					R Right (Shown)	Flintwood	9 Flintwood Flat Trim		Foundation (for metal gables) Mica (for metal gables)

SAMPLE ORDER CODE

RUDR L	24	30	66	72	R	2D	6	4D	3D
---------------	-----------	-----------	-----------	-----------	----------	-----------	----------	-----------	-----------

**DIMENSIONS – INCHES
FOR MM X BY 25.4**

Da	Db	Wa	Wb
24	24	66	66
24	24	66	72
24	24	66	78
24	24	66	84
24	24	72	66
24	24	72	72
24	24	72	78
24	24	72	84
24	24	78	66
24	24	78	72
24	24	78	78
24	24	78	84
24	24	84	66
24	24	84	72
24	24	84	78
24	24	84	84

PRICING

LAMINATE GABLES (L)

Foundation Laminate	Flintwood
2022	3154
2045	3190
2158	3344
2228	3443
2045	3190
2093	3268
2184	3403
2265	3518
2158	3344
2184	3403
2300	3557
2368	3654
2228	3443
2265	3518
2368	3654
2446	3776

METAL GABLES (M)

Foundation Laminate	Flintwood
2674	4104
2696	4144
2812	4297
2878	4389
2696	4144
2745	4213
2839	4351
2922	4465
2812	4297
2839	4351
2950	4504
3019	4602
2878	4389
2922	4465
3019	4602
3104	4721

If Mica Gables are specified, add 89.

Pricing is continued on the following page.

R U D R
Single Structure L-Shaped Desk
– Full Gables (Continued)

DIMENSIONS – INCHES
FOR MM X BY 25.4

PRICING

				LAMINATE GABLES (L)		METAL GABLES (M)	
Da	Db	Wa	Wb	Foundation Laminate	Flintwood	Foundation Laminate	Flintwood
24	30	66	66	2069	3234	2738	4192
24	30	66	72	2141	3333	2807	4295
24	30	66	78	2236	3478	2901	4440
24	30	66	84	2326	3611	2992	4574
24	30	72	66	2096	3271	2765	4232
24	30	72	72	2169	3372	2829	4331
24	30	72	78	2264	3515	2929	4476
24	30	72	84	2356	3651	3019	4610
24	30	78	66	2155	3341	2820	4299
24	30	78	72	2228	3444	2892	4401
24	30	78	78	2322	3586	2986	4548
24	30	78	84	2413	3718	3076	4677
24	30	84	66	2240	3463	2901	4422
24	30	84	72	2311	3565	2970	4523
24	30	84	78	2406	3707	3067	4668
24	30	84	84	2495	3838	3158	4799
30	24	66	66	2069	3234	2738	4192
30	24	66	72	2096	3271	2765	4232
30	24	66	78	2155	3341	2820	4299
30	24	66	84	2240	3463	2901	4422
30	24	72	66	2141	3333	2807	4295
30	24	72	72	2169	3372	2829	4331
30	24	72	78	2228	3444	2892	4401
30	24	72	84	2311	3565	2970	4523
30	24	78	66	2236	3478	2901	4440
30	24	78	72	2264	3515	2929	4476
30	24	78	78	2322	3586	2986	4548
30	24	78	84	2406	3707	3067	4668
30	24	84	66	2326	3611	2992	4574
30	24	84	72	2356	3651	3019	4610
30	24	84	78	2413	3718	3076	4677
30	24	84	84	2495	3838	3158	4799

If Mica Gables are specified, add 89.

Pricing is continued on the following page.

modular desks

Xpress

R U D R

Single Structure L-Shaped Desk – Full Gables (Continued)

DIMENSIONS – INCHES
FOR MM X BY 25.4

PRICING

Da	Db	Wa	Wb	LAMINATE GABLES (L)		METAL GABLES (M)	
				Foundation Laminate	Flintwood	Foundation Laminate	Flintwood
30	30	66	66	2173	3378	2847	4351
30	30	66	72	2228	3459	2902	4434
30	30	66	78	2323	3591	3000	4559
30	30	66	84	2350	3627	3028	4596
30	30	72	66	2228	3459	2902	4434
30	30	72	72	2297	3562	2972	4533
30	30	72	78	2398	3692	3069	4661
30	30	72	84	2417	3732	3095	4698
30	30	78	66	2323	3591	3000	4559
30	30	78	72	2398	3692	3069	4661
30	30	78	78	2453	3783	3132	4751
30	30	78	84	2513	3872	3192	4842
30	30	84	66	2350	3627	3028	4596
30	30	84	72	2417	3732	3095	4698
30	30	84	78	2513	3872	3192	4842
30	30	84	84	2605	4007	3285	4976

If Mica Gables are specified, add 89.

modular desks

Xpress

RURR

Single Structure L-Shaped Desk with Radius Corner – Full Gables

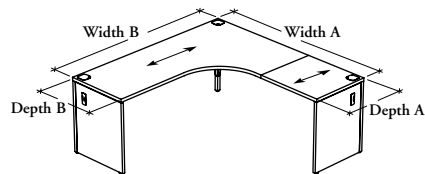

This fixed-height desk combines an extended corner desk and a rectangular worksurface allowing users to work on either side of the workstation.

WHAT'S INCLUDED

2 worksurfaces, 3 metal corner posts with levelers, 2 structural beams, 2 full gables with levelers, 1 assembly plate, wire management clips, grommets, and hardware.

WHAT'S EXCLUDED

Flush-Mounted Modesty Panels.

NOTES

Worksurfaces **cannot** be used individually.

PRODUCT OPTIONS

Gable Style	Depth A	Depth B	Width A	Width B	Return Configuration	Worksurface Finish	Edge Trim Style	Edge Trim Finish	Gable and Grommet Finish
L Laminate	24, 30	24, 30	66, 72, 78, 84	66, 72, 78, 84	L Left	Foundation Laminate	6 Straight Trim	Edge Trim Colors (for trim style 6)	Source Laminate
M Metal					R Right (Shown)	Flintwood	9 Flintwood Flat Trim		Foundation (for metal gables) Mica (for metal gables)

SAMPLE ORDER CODE

RURR L	24	24	66	66	R	2D	6	4D	3D
---------------	-----------	-----------	-----------	-----------	----------	-----------	----------	-----------	-----------

DIMENSIONS – INCHES FOR MM X BY 25.4

Da	Db	Wa	Wb
24	24	66	66
24	24	66	72
24	24	66	78
24	24	66	84
24	24	72	66
24	24	72	72
24	24	72	78
24	24	72	84
24	24	78	66
24	24	78	72
24	24	78	78
24	24	78	84
24	24	84	66
24	24	84	72
24	24	84	78
24	24	84	84
24	30	66	66
24	30	66	72
24	30	66	78
24	30	66	84

PRICING

LAMINATE GABLES (L)

Foundation Laminate	Flintwood
2343	3734
2368	3765
2426	3833
2474	3909
2368	3765
2449	3889
2504	3957
2554	4032
2426	3833
2504	3957
2586	4069
2633	4146
2474	3909
2554	4032
2633	4146
2719	4270
2368	3753
2453	3887
2538	4009
2617	4133

METAL GABLES (M)

Foundation Laminate	Flintwood
2995	4688
3021	4714
3083	4784
3147	4878
3021	4714
3106	4838
3168	4906
3231	5002
3083	4784
3168	4906
3242	5022
3306	5119
3147	4878
3231	5002
3306	5119
3387	5242
3028	4721
3113	4856
3200	4976
3285	5097

If Mica Gables are specified, add 89.

Pricing is continued on the following page.

RURR

Single Structure L-Shaped Desk
with Radius Corner – Full Gables (Continued)

DIMENSIONS – INCHES
FOR MM X BY 25.4

PRICING

				LAMINATE GABLES (L)		METAL GABLES (M)	
				Foundation Laminate	Flintwood	Foundation Laminate	Flintwood
24	30	72	66	2427	3851	3091	4815
24	30	72	72	2513	3981	3176	4947
24	30	72	78	2598	4103	3263	5072
24	30	72	84	2678	4231	3347	5193
24	30	78	66	2525	3980	3189	4944
24	30	78	72	2612	4112	3272	5075
24	30	78	78	2695	4234	3362	5197
24	30	78	84	2775	4357	3444	5319
24	30	84	66	2525	3980	3261	5047
24	30	84	72	2683	4218	3347	5179
24	30	84	78	2769	4342	3432	5305
24	30	84	84	2848	4467	3515	5430
30	24	66	66	2368	3753	3028	4721
30	24	66	72	2453	3887	3113	4856
30	24	66	78	2538	4009	3200	4976
30	24	66	84	2617	4133	3285	5097
30	24	72	66	2427	3851	3091	4815
30	24	72	72	2513	3981	3176	4947
30	24	72	78	2598	4103	3263	5072
30	24	72	84	2678	4231	3347	5193
30	24	78	66	2525	3980	3189	4944
30	24	78	72	2612	4112	3272	5075
30	24	78	78	2695	4234	3362	5197
30	24	78	84	2775	4357	3444	5319
30	24	84	66	2525	3980	3261	5047
30	24	84	72	2683	4218	3347	5179
30	24	84	78	2769	4342	3432	5305
30	24	84	84	2848	4467	3515	5430
30	30	66	66	2375	3775	3048	4747
30	30	66	72	2464	3902	3135	4874
30	30	66	78	2546	4024	3219	5000
30	30	66	84	2638	4159	3311	5134
30	30	72	66	2464	3902	3135	4874
30	30	72	72	2590	4089	3264	5069
30	30	72	78	2681	4217	3356	5196
30	30	72	84	2749	4314	3429	5291
30	30	78	66	2546	4072	3219	5000
30	30	78	72	2681	4217	3356	5196
30	30	78	78	2777	4357	3453	5334
30	30	78	84	2843	4451	3518	5425
30	30	84	66	2638	4159	3311	5134
30	30	84	72	2749	4314	3429	5291
30	30	84	78	2843	4451	3518	5425
30	30	84	84	2943	4606	3618	5574

If Mica Gables are specified, add 89.

modular desks

Xpress

R D A R

Rectangular Desk with Visitor Access – Full Gables

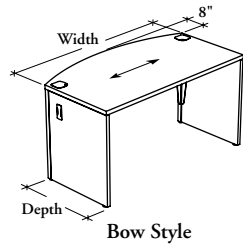

Bow Style

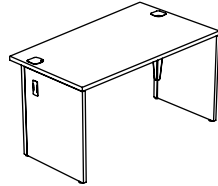

Rectangular Style

This fixed-height desk may be used alone or in combination with other desks to create a variety of workstation configurations.

WHAT'S INCLUDED

1 worksurface, 2 metal corner posts with levelers, 1 structural beam, 2 full gables with levelers, wire management clips, grommets, and hardware.

WHAT'S EXCLUDED

Flush-Mounted Modesty Panel.

NOTES

This desk has an 8" overhang on visitor side for additional kneespace clearance. This overhang is added to the specified depth.

PRODUCT OPTIONS

Worksurface Style	Gable Style	Depth	Width	Worksurface Finish	Edge Trim Style	Edge Trim Finish	Gable and Grommet Finish
B Bow	L Laminate	24, 30, 36	60, 66, 72, 78, 84	Foundation Laminate Flintwood	6 Straight Trim 9 Flintwood Flat Trim	Edge Trim Colors (for trim style 6)	Source Laminate Foundation (for metal gables and metal c-legs) Mica (for metal gables and metal c-legs)
R Rectangular	M Metal C Metal C-Leg						

SAMPLE ORDER CODE

RDAR B	M	30	60	2D	6	4D	J
---------------	----------	-----------	-----------	-----------	----------	-----------	----------

DIMENSIONS INCHES / MM

D	W
24 / 610	60 / 1524
24 / 610	66 / 1676
24 / 610	72 / 1829
24 / 610	78 / 1981
24 / 610	84 / 2134
30 / 762	60 / 1524
30 / 762	66 / 1676
30 / 762	72 / 1829
30 / 762	78 / 1981
30 / 762	84 / 2134
36 / 914	60 / 1524
36 / 914	66 / 1676
36 / 914	72 / 1829
36 / 914	78 / 1981
36 / 914	84 / 2134

PRICING

LAMINATE GABLES (L)

Foundation Laminate	Flintwood
1365	2207
1427	2317
1484	2404
1585	2569
1676	2718
1433	2322
1510	2444
1585	2569
1692	2745
1795	2900
1566	2537
1672	2711
1774	2871
1888	3060
2002	3246

METAL GABLES (M)

Foundation Laminate	Flintwood
1808	2932
1878	3036
1929	3129
2029	3290
2124	3443
1907	3091
1982	3212
2059	3332
2169	3511
2265	3673
2083	3373
2187	3545
2291	3709
2405	3895
2524	4087

METAL C-LEGS (C)

Foundation Laminate	Flintwood
1808	2932
1878	3036
1929	3129
2029	3290
2124	3443
1907	3091
1982	3212
2059	3332
2169	3511
2265	3673
n/a	n/a
n/a	n/a
n/a	n/a
n/a	n/a
n/a	n/a

If Mica Gables or Mica C-Legs are specified, add 89.

modular desks

Xpress

R D R R

Rectangular Desk – Full Gables

This fixed-height desk can be used alone or combined with one or more desks to form a complete workstation.

WHAT'S INCLUDED

1 worksurface, 2 metal corner posts with levelers, 1 structural beam, 2 full gables with levelers, wire management clips, grommets, and hardware.

WHAT'S EXCLUDED

Flush-Mounted Modesty Panel.

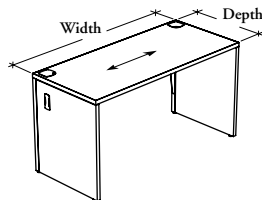

PRODUCT OPTIONS

Gable Style	Depth	Width	Worksurface Finish	Edge Trim Style	Edge Trim Finish	Gable and Grommet Finish
L Laminate	20, 24, 30, 36	24, 30, 36, 42, 48, 54, 60, 66, 72, 78, 84	Foundation Laminate	6 Straight Trim 9 Flintwood Flat Trim	Edge Trim Colors (for trim style 6)	Source Laminate
M Metal			Flintwood			Foundation (for metal gables and metal c-legs)
C Metal C-Leg						Mica (for metal gables and metal c-legs)

SAMPLE ORDER CODE

RDRR L	36	60	2D	6	4D	3D
---------------	-----------	-----------	-----------	----------	-----------	-----------

**DIMENSIONS
INCHES / MM**

D	W
20 / 454	24 / 610
20 / 454	30 / 762
20 / 454	36 / 914
20 / 454	42 / 1067
20 / 454	48 / 1219
20 / 454	54 / 1372
20 / 454	60 / 1524
20 / 454	66 / 1676
20 / 454	72 / 1829
20 / 454	78 / 1981
20 / 454	84 / 2134
24 / 610	24 / 610
24 / 610	30 / 762
24 / 610	36 / 914
24 / 610	42 / 1067
24 / 610	48 / 1219
24 / 610	54 / 1372
24 / 610	60 / 1524
24 / 610	66 / 1676
24 / 610	72 / 1829
24 / 610	78 / 1981
24 / 610	84 / 2134

PRICING

LAMINATE GABLES (L)	
Foundation Laminate	Flintwood
897	1336
930	1382
966	1434
1000	1487
1039	1539
1057	1569
1081	1605
1155	1717
1237	1834
1326	1964
1406	2091
957	1424
981	1458
1032	1531
1057	1569
1081	1605
1163	1725
1231	1822
1288	1907
1336	1982
1427	2120
1510	2240

METAL GABLES (M)	
Foundation Laminate	Flintwood
1296	1924
1327	1970
1365	2024
1394	2072
1430	2126
1456	2154
1474	2189
1554	2304
1631	2422
1717	2550
1801	2676
1404	2085
1427	2120
1480	2197
1505	2234
1527	2267
1608	2387
1674	2488
1734	2572
1781	2645
1876	2781
1955	2901

METAL C-LEGS (C)	
Foundation Laminate	Flintwood
n/a	n/a
n/a	n/a
n/a	n/a
n/a	n/a
n/a	n/a
n/a	n/a
n/a	n/a
n/a	n/a
n/a	n/a
n/a	n/a
n/a	n/a
1404	2085
1427	2120
1480	2197
1505	2234
1527	2267
1608	2387
1674	2488
1734	2572
1781	2645
1876	2781
1955	2901

If Mica Gables or Mica C-Legs are specified, add 89.

Pricing is continued on the following page.

R D R R
Rectangular Desk – Full Gables
(Continued)

DIMENSIONS
INCHES / MM

PRICING

		LAMINATE GABLES (L)		METAL GABLES (M)		METAL C-LEGS (C)	
		Foundation Laminate	Flintwood	Foundation Laminate	Flintwood	Foundation Laminate	Flintwood
D	W						
30 / 762	24 / 610	996	1477	1469	2181	1469	2181
30 / 762	30 / 762	1057	1569	1529	2272	1529	2272
30 / 762	36 / 914	1130	1679	1605	2381	1605	2381
30 / 762	42 / 1067	1188	1759	1660	2464	1660	2464
30 / 762	48 / 1219	1250	1855	1720	2555	1720	2555
30 / 762	54 / 1372	1276	1888	1748	2590	1748	2590
30 / 762	60 / 1524	1293	1920	1766	2622	1766	2622
30 / 762	66 / 1676	1356	2016	1833	2720	1833	2720
30 / 762	72 / 1829	1427	2120	1898	2823	1898	2823
30 / 762	78 / 1981	1523	2263	1999	2966	1999	2966
30 / 762	84 / 2134	1612	2399	2086	3096	2086	3096
36 / 914	24 / 610	1081	1605	1597	2370	n/a	n/a
36 / 914	30 / 762	1165	1728	1680	2495	n/a	n/a
36 / 914	36 / 914	1234	1828	1750	2595	n/a	n/a
36 / 914	42 / 1067	1337	1985	1855	2754	n/a	n/a
36 / 914	48 / 1219	1368	2027	1884	2798	n/a	n/a
36 / 914	54 / 1372	1387	2062	1904	2828	n/a	n/a
36 / 914	60 / 1524	1411	2093	1928	2862	n/a	n/a
36 / 914	66 / 1676	1505	2234	2022	3001	n/a	n/a
36 / 914	72 / 1829	1597	2369	2114	3135	n/a	n/a
36 / 914	78 / 1981	1699	2525	2216	3291	n/a	n/a
36 / 914	84 / 2134	1801	2678	2320	3446	n/a	n/a

If Mica Gables or Mica C-Legs are specified, add 89.

modular desks

Xpress

R D R S

Rectangular Desk – Full and Half Gables

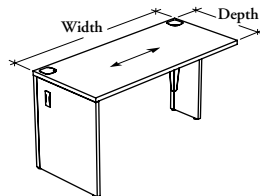

This fixed-height desk is ideal for completing a variety of workstation configurations.

WHAT'S INCLUDED

1 worksurface, 2 metal corner posts with levelers, 1 structural beam, 1 full gable and 1 half gable with levelers, 1 flush plate, wire management clips, grommets, and hardware.

WHAT'S EXCLUDED

Flush-Mounted Modesty Panel.

NOTES

This desk is semi-supported and must be connected to another desk on the half gable side.

PRODUCT OPTIONS

Gable Style	Depth	Width	Worksurface Configuration	Worksurface Finish	Edge Trim Style	Edge Trim Finish	Gable and Grommet Finish
L Laminate	20, 24, 30, 36	24, 30, 36, 42, 48, 54, 60, 66, 72, 78, 84	L Left (Shown)	Foundation Laminate Flintwood	6 Straight Trim 9 Flintwood Flat Trim	Edge Trim Colors (for trim style 6)	Source Laminate
M Metal			R Right				Foundation (for metal gables and metal c-leg)
C Metal C-Leg			Mica (for metal gables and metal c-leg)				

SAMPLE ORDER CODE

RDRS L	36	60	L	3E	6	4E	3E
---------------	-----------	-----------	----------	-----------	----------	-----------	-----------

DIMENSIONS INCHES / MM

D	W
20 / 454	24 / 610
20 / 454	30 / 762
20 / 454	36 / 914
20 / 454	42 / 1067
20 / 454	48 / 1219
20 / 454	54 / 1372
20 / 454	60 / 1524
20 / 454	66 / 1676
20 / 454	72 / 1829
20 / 454	78 / 1981
20 / 454	84 / 2134
24 / 610	24 / 610
24 / 610	30 / 762
24 / 610	36 / 914
24 / 610	42 / 1067
24 / 610	48 / 1219
24 / 610	54 / 1372
24 / 610	60 / 1524
24 / 610	66 / 1676
24 / 610	72 / 1829
24 / 610	78 / 1981
24 / 610	84 / 2134

PRICING

LAMINATE GABLES (L)

Foundation Laminate	Flintwood
897	1336
930	1382
966	1434
1000	1487
1039	1539
1057	1569
1081	1605
1155	1717
1237	1834
1326	1964
1406	2091
957	1424
981	1458
1032	1531
1057	1569
1081	1605
1163	1725
1231	1822
1288	1907
1336	1982
1427	2120
1510	2240

METAL GABLES (M)

Foundation Laminate	Flintwood
1252	1857
1284	1900
1318	1956
1351	2006
1385	2059
1406	2091
1430	2125
1506	2236
1586	2356
1672	2487
1757	2613
1335	1980
1355	2015
1406	2091
1431	2127
1457	2167
1537	2282
1604	2380
1660	2465
1709	2544
1800	2676
1885	2799

METAL C-LEGS (C)

Foundation Laminate	Flintwood
n/a	n/a
n/a	n/a
n/a	n/a
n/a	n/a
n/a	n/a
n/a	n/a
n/a	n/a
n/a	n/a
n/a	n/a
n/a	n/a
n/a	n/a
1335	1980
1355	2015
1406	2091
1431	2127
1457	2167
1537	2282
1604	2380
1660	2465
1709	2544
1800	2676
1885	2799

If Mica Gables or Mica C-Leg are specified, add 74.

Pricing is continued on the following page.

R D R S
Rectangular Desk –
Full and Half Gables (Continued)

DIMENSIONS
INCHES / MM

PRICING

DIMENSIONS INCHES / MM		LAMINATE GABLES (L)		METAL GABLES (M)		METAL C-LEGS (C)	
		Foundation Laminate	Flintwood	Foundation Laminate	Flintwood	Foundation Laminate	Flintwood
D	W						
30 / 762	24 / 610	996	1477	1384	2057	1384	2057
30 / 762	30 / 762	1057	1569	1448	2148	1448	2148
30 / 762	36 / 914	1130	1679	1517	2257	1517	2257
30 / 762	42 / 1067	1188	1759	1574	2342	1574	2342
30 / 762	48 / 1219	1250	1855	1634	2431	1634	2431
30 / 762	54 / 1372	1276	1888	1662	2465	1662	2465
30 / 762	60 / 1524	1293	1920	1680	2495	1680	2495
30 / 762	66 / 1676	1356	2016	1750	2591	1750	2591
30 / 762	72 / 1829	1427	2120	1817	2696	1817	2696
30 / 762	78 / 1981	1523	2263	1915	2842	1915	2842
30 / 762	84 / 2134	1612	2399	2002	2972	2002	2972
36 / 914	24 / 610	1081	1605	1491	2214	n/a	n/a
36 / 914	30 / 762	1165	1728	1574	2340	n/a	n/a
36 / 914	36 / 914	1234	1828	1641	2441	n/a	n/a
36 / 914	42 / 1067	1337	1985	1750	2591	n/a	n/a
36 / 914	48 / 1219	1368	2027	1778	2638	n/a	n/a
36 / 914	54 / 1372	1387	2062	1799	2671	n/a	n/a
36 / 914	60 / 1524	1411	2093	1821	2703	n/a	n/a
36 / 914	66 / 1676	1505	2234	1919	2844	n/a	n/a
36 / 914	72 / 1829	1597	2369	2006	2981	n/a	n/a
36 / 914	78 / 1981	1699	2525	2112	3134	n/a	n/a
36 / 914	84 / 2134	1801	2678	2214	3287	n/a	n/a

If Mica Gables or Mica C-Leg are specified, add 74.

modular desks

Xpress

R D R D

Rectangular Desk – Half Gables

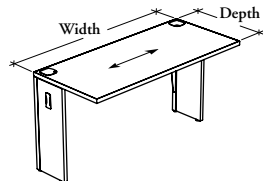

This fixed-height desk is used as a bridge between other semi-supported desks.

WHAT'S INCLUDED

1 worksurface, 2 metal corner posts with levelers, 1 structural beam, 2 half gables with levelers, 2 flush plates, wire management clips, grommets, and hardware.

WHAT'S EXCLUDED

Flush-Mounted Modesty Panel.

NOTES

This desk is semi-supported and must be connected to other desks on both sides.

PRODUCT OPTIONS

Gable Style	Depth	Width	Worksurface Finish	Edge Trim Style	Edge Trim Finish	Gable and Grommet Finish
L Laminate	20, 24, 30, 36	24, 30, 36, 42, 48, 54, 60, 66, 72, 78, 84	Foundation Laminate Flintwood	6 Straight Trim	Edge Trim Colors (for trim style 6)	Source Laminate
M Metal				9 Flintwood Flat Trim		Foundation (for metal gables) Mica (for metal gables)

SAMPLE ORDER CODE

RDRD M	36	60	2D	6	4D	Q
---------------	-----------	-----------	-----------	----------	-----------	----------

DIMENSIONS INCHES / MM

D	W
20 / 454	24 / 610
20 / 454	30 / 762
20 / 454	36 / 914
20 / 454	42 / 1067
20 / 454	48 / 1219
20 / 454	54 / 1372
20 / 454	60 / 1524
20 / 454	66 / 1676
20 / 454	72 / 1829
20 / 454	78 / 1981
20 / 454	84 / 2134
24 / 610	24 / 610
24 / 610	30 / 762
24 / 610	36 / 914
24 / 610	42 / 1067
24 / 610	48 / 1219
24 / 610	54 / 1372
24 / 610	60 / 1524
24 / 610	66 / 1676
24 / 610	72 / 1829
24 / 610	78 / 1981
24 / 610	84 / 2134

PRICING

LAMINATE GABLES (L)

Foundation Laminate	Flintwood
897	1336
930	1382
966	1434
1000	1487
1039	1539
1057	1569
1081	1605
1155	1717
1237	1834
1326	1964
1406	2091
957	1424
981	1458
1032	1531
1057	1569
1081	1605
1163	1725
1231	1822
1288	1907
1336	1982
1427	2120
1510	2240

METAL GABLES (M)

Foundation Laminate	Flintwood
1205	1791
1237	1835
1276	1888
1303	1938
1340	1994
1364	2023
1384	2058
1460	2173
1540	2289
1625	2416
1712	2545
1259	1878
1288	1907
1337	1985
1364	2023
1384	2058
1464	2178
1531	2272
1589	2362
1639	2438
1732	2572
1815	2692

If Mica Gables are specified, add 43.

Pricing is continued on the following page.

R D R D
Rectangular Desk – Half Gables
(Continued)

DIMENSIONS
INCHES / MM

D	W
30 / 762	24 / 610
30 / 762	30 / 762
30 / 762	36 / 914
30 / 762	42 / 1067
30 / 762	48 / 1219
30 / 762	54 / 1372
30 / 762	60 / 1524
30 / 762	66 / 1676
30 / 762	72 / 1829
30 / 762	78 / 1981
30 / 762	84 / 2134
36 / 914	24 / 610
36 / 914	30 / 762
36 / 914	36 / 914
36 / 914	42 / 1067
36 / 914	48 / 1219
36 / 914	54 / 1372
36 / 914	60 / 1524
36 / 914	66 / 1676
36 / 914	72 / 1829
36 / 914	78 / 1981
36 / 914	84 / 2134

PRICING

LAMINATE GABLES (L)	
Foundation Laminate	Flintwood
996	1477
1057	1569
1130	1679
1188	1759
1250	1855
1276	1888
1293	1920
1356	2016
1427	2120
1523	2263
1612	2399
1081	1605
1165	1728
1234	1828
1337	1985
1368	2027
1387	2062
1411	2093
1505	2234
1597	2369
1699	2525
1801	2678

METAL GABLES (M)	
Foundation Laminate	Flintwood
1299	1929
1364	2023
1433	2130
1491	2214
1554	2306
1579	2344
1597	2369
1662	2468
1732	2572
1828	2717
1920	2847
1384	2058
1465	2181
1537	2282
1641	2439
1670	2485
1695	2517
1713	2546
1808	2688
1900	2823
2004	2980
2109	3132

If Mica Gables are specified, add 43.

modular desks

Xpress

R D F S

Cross Grain Rectangular Desk – Full and Half Gables

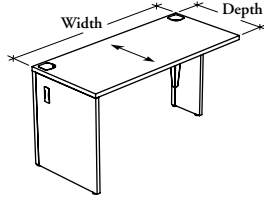

This fixed-height desk is ideal for completing a variety of workstation configurations.

WHAT'S INCLUDED

1 worksurface, 2 metal corner posts with levelers, 1 structural beam, 1 full gable and 1 half gable with levelers, 1 flush plate, wire management clips, grommets, and hardware.

WHAT'S EXCLUDED

Flush-Mounted Modesty Panel.

NOTES

This desk is semi-supported and must be connected to another desk on the half gable side.

PRODUCT OPTIONS

Gable Style	Depth	Width	Worksurface Configuration	Worksurface Finish	Edge Trim Style	Edge Trim Finish	Gable and Grommet Finish
L Laminate	20, 24, 30, 36	24, 30, 36, 42, 48, 54, 60	L Left (Shown)	Foundation Laminate Flintwood	6 Straight Trim	Edge Trim Colors (for trim style 6)	Source Laminate
M Metal			R Right		9 Flintwood Flat Trim		Foundation (for metal gables and metal c-leg)
C Metal C-Leg							Mica (for metal gables and metal c-leg)

SAMPLE ORDER CODE

RDFS L	30	54	L	2D	6	4D	3D
---------------	-----------	-----------	----------	-----------	----------	-----------	-----------

DIMENSIONS INCHES / MM

D	W
20 / 454	24 / 610
20 / 454	30 / 762
20 / 454	36 / 914
20 / 454	42 / 1067
20 / 454	48 / 1219
20 / 454	54 / 1372
20 / 454	60 / 1524
24 / 610	24 / 610
24 / 610	30 / 762
24 / 610	36 / 914
24 / 610	42 / 1067
24 / 610	48 / 1219
24 / 610	54 / 1372
24 / 610	60 / 1524

PRICING

LAMINATE GABLES (L)

Foundation Laminate	Flintwood
897	1336
930	1382
966	1434
1000	1487
1039	1539
1057	1569
1081	n/a
957	1424
981	1458
1032	1531
1057	1569
1081	1605
1163	1725
1231	n/a

METAL GABLES (M)

Foundation Laminate	Flintwood
1252	1857
1284	1900
1318	1956
1351	2006
1385	2059
1406	2091
1430	n/a
1335	1980
1355	2015
1406	2091
1431	2127
1457	2167
1537	2282
1604	n/a

METAL C-LEGS (C)

Foundation Laminate	Flintwood
n/a	n/a
n/a	n/a
n/a	n/a
n/a	n/a
n/a	n/a
n/a	n/a
n/a	n/a
1335	1980
1355	2015
1406	2091
1431	2127
1457	2167
1537	2282
1604	n/a

If Mica Gables or Mica C-Leg are specified, add 74.

Pricing is continued on the following page

R D F S

Cross Grain Rectangular Desk – Full and Half Gables (Continued)

**DIMENSIONS
INCHES / MM**

PRICING

DIMENSIONS INCHES / MM		LAMINATE GABLES (L)		METAL GABLES (M)		METAL C-LEGS (C)	
		Foundation Laminate	Flintwood	Foundation Laminate	Flintwood	Foundation Laminate	Flintwood
D	W						
30 / 762	24 / 610	996	1477	1384	2057	1384	2057
30 / 762	30 / 762	1057	1569	1448	2148	1448	2148
30 / 762	36 / 914	1130	1679	1517	2257	1517	2257
30 / 762	42 / 1067	1188	1759	1574	2342	1574	2342
30 / 762	48 / 1219	1250	1855	1634	2431	1634	2431
30 / 762	54 / 1372	1276	1888	1662	2465	1662	2465
30 / 762	60 / 1524	1293	n/a	1680	n/a	1680	n/a
36 / 914	24 / 610	1081	1605	1491	2214	n/a	n/a
36 / 914	30 / 762	1165	1728	1574	2340	n/a	n/a
36 / 914	36 / 914	1234	1828	1641	2441	n/a	n/a
36 / 914	42 / 1067	1337	1985	1750	2591	n/a	n/a
36 / 914	48 / 1219	1368	2027	1778	2638	n/a	n/a
36 / 914	54 / 1372	1387	2062	1799	2671	n/a	n/a
36 / 914	60 / 1524	1411	n/a	1821	n/a	n/a	n/a

If Mica Gables or Mica C-Leg are specified, add 74.

modular desks

Xpress

R D F D

Cross Grain Rectangular Desk – Half Gables

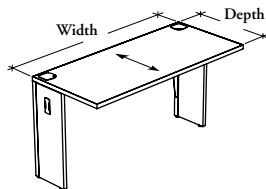

This fixed-height desk is used as a bridge between other semi-supported desks.

WHAT'S INCLUDED

1 worksurface, 2 metal corner posts with levelers, 1 structural beam, 2 half gables with levelers, 2 flush plates, wire management clips, grommets, and hardware.

WHAT'S EXCLUDED

Flush-Mounted Modesty Panel.

NOTES

This desk is semi-supported and must be connected to other desks on both sides.

PRODUCT OPTIONS

Gable Style	Depth	Width	Worksurface Finish	Edge Trim Style	Edge Trim Finish	Gable and Grommet Finish
L Laminate M Metal	20, 24, 30, 36	24, 30, 36, 42, 48, 54, 60	Foundation Laminate Flintwood	6 Straight Trim 9 Flintwood Flat Trim	Edge Trim Colors (for trim style 6)	Source Laminate Foundation (for metal gables) Mica (for metal gables)

SAMPLE ORDER CODE

RDFD M	36	60	2D	6	4D	Q
---------------	-----------	-----------	-----------	----------	-----------	----------

**DIMENSIONS
INCHES / MM**

D	W
20 / 454	24 / 610
20 / 454	30 / 762
20 / 454	36 / 914
20 / 454	42 / 1067
20 / 454	48 / 1219
20 / 454	54 / 1372
20 / 454	60 / 1524
24 / 610	24 / 610
24 / 610	30 / 762
24 / 610	36 / 914
24 / 610	42 / 1067
24 / 610	48 / 1219
24 / 610	54 / 1372
24 / 610	60 / 1524

PRICING

LAMINATE GABLES (L)	
Foundation Laminate	Flintwood
897	1336
930	1382
966	1434
1000	1487
1039	1539
1057	1569
1081	n/a
957	1424
981	1458
1032	1531
1057	1569
1081	1605
1163	1725
1231	n/a

METAL GABLES (M)	
Foundation Laminate	Flintwood
1205	1791
1237	1835
1276	1888
1303	1938
1340	1994
1364	2023
1384	n/a
1259	1878
1288	1907
1337	1985
1364	2023
1384	2058
1464	2178
1531	n/a

If Mica Gables are specified, add 43.

Pricing is continued on the following page.

R D F D

Cross Grain Rectangular Desk – Half Gables (Continued)

DIMENSIONS
INCHES / MM

D	W
30 / 762	24 / 610
30 / 762	30 / 762
30 / 762	36 / 914
30 / 762	42 / 1067
30 / 762	48 / 1219
30 / 762	54 / 1372
30 / 762	60 / 1524
36 / 914	24 / 610
36 / 914	30 / 762
36 / 914	36 / 914
36 / 914	42 / 1067
36 / 914	48 / 1219
36 / 914	54 / 1372
36 / 914	60 / 1524

PRICING

LAMINATE GABLES (L)	
Foundation Laminate	Flintwood
996	1477
1057	1569
1130	1679
1188	1759
1250	1855
1276	1888
1293	n/a
1081	1605
1165	1728
1234	1828
1337	1985
1368	2027
1387	2062
1411	n/a

METAL GABLES (M)	
Foundation Laminate	Flintwood
1299	1929
1364	2023
1433	2130
1491	2214
1554	2306
1579	2344
1597	n/a
1384	2058
1465	2181
1537	2282
1641	2439
1670	2485
1695	2517
1713	n/a

If Mica Gables are specified, add 43.

modular desks

Xpress

RVSS

Concave Transition Desk – Full and Half Gables

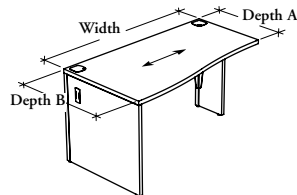

This fixed-height desk provides an ideal secondary surface within a workstation.

WHAT'S INCLUDED

1 worksurface, 2 metal corner posts with levelers, 1 structural beam, 1 full gable and 1 half gable with levelers, 1 flush plate, wire management clips, grommets, and hardware.

WHAT'S EXCLUDED

Flush-Mounted Modesty Panel.

NOTES

This desk is semi-supported and must be connected to another desk on the half gable side.

The full gable is always on the deepest side (Depth B).

PRODUCT OPTIONS

Gable Style	Depth A	Width	Depth B	Worksurface Configuration	Worksurface Finish	Edge Trim Style	Edge Trim Finish	Gable and Grommet Finish
L Laminate M Metal C Metal C-Leg	24, 30	36, 42, 48, 54, 60, 66, 72, 78, 84	30, 36	L Left (Shown) R Right	Foundation Laminate Flintwood	6 Straight Trim 9 Flintwood Flat Trim	Edge Trim Colors (for trim style 6)	Source Laminate Foundation (for metal gables and metal c-leg) Mica (for metal gables and metal c-leg)

SAMPLE ORDER CODE

RVSS L	30	36	36	L	FX	9	LE
--------	----	----	----	---	----	---	----

DIMENSIONS INCHES / MM

Da	W	Db
24 / 610	36 / 914	30 / 762
24 / 610	42 / 1067	30 / 762
24 / 610	48 / 1219	30 / 762
24 / 610	54 / 1372	30 / 762
24 / 610	60 / 1524	30 / 762
24 / 610	66 / 1676	30 / 762
24 / 610	72 / 1829	30 / 762
24 / 610	78 / 1981	30 / 762
24 / 610	84 / 2134	30 / 762
30 / 762	36 / 914	36 / 914
30 / 762	42 / 1067	36 / 914
30 / 762	48 / 1219	36 / 914
30 / 762	54 / 1372	36 / 914
30 / 762	60 / 1524	36 / 914
30 / 762	66 / 1676	36 / 914
30 / 762	72 / 1829	36 / 914
30 / 762	78 / 1981	36 / 914
30 / 762	84 / 2134	36 / 914

PRICING

LAMINATE GABLES (L)	
Foundation Laminate	Flintwood
1166	1732
1234	1828
1293	1920
1306	1946
1339	1989
1411	2093
1484	2199
1585	2355
1651	2446
1255	1864
1326	1964
1387	2062
1421	2109
1456	2155
1554	2306
1636	2431
1752	2595
1844	2741

METAL GABLES (M)	
Foundation Laminate	Flintwood
1556	2308
1622	2406
1680	2495
1699	2525
1730	2569
1799	2670
1873	2777
1972	2929
2035	3025
1665	2480
1735	2576
1799	2671
1833	2719
1862	2767
1964	2917
2052	3043
2156	3209
2257	3354

METAL C-LEGS (C)	
Foundation Laminate	Flintwood
1556	2308
1622	2406
1680	2495
1699	2525
1730	2569
1799	2670
1873	2777
1972	2929
2035	3025
n/a	n/a
n/a	n/a
n/a	n/a
n/a	n/a
n/a	n/a
n/a	n/a
n/a	n/a
n/a	n/a
n/a	n/a
n/a	n/a

If Mica Gables or Mica C-Leg are specified, add 74.

This fixed-height desk is for use in corners between two semi-supported desks.

RVRD

Radius Corner Desk – Half Gables

WHAT'S INCLUDED

1 worksurface, 3 metal corner posts with levelers, 2 structural beams, 2 half gables with levelers, 2 flush plates, wire management clips, grommets, and hardware.

WHAT'S EXCLUDED

Flush-Mounted Modesty Panels.

NOTES

This desk is semi-supported and must be connected to other desks on both sides.

This product does **not** accept a keyboard shelf.

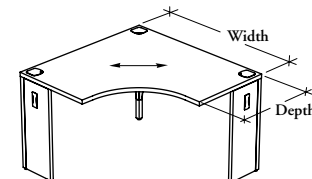

PRODUCT OPTIONS

Gable Style	Depth	Width	Worksurface Finish	Edge Trim Style	Edge Trim Finish	Gable and Grommet Finish
L Laminate	24, 30	36, 42, 48, 54	Foundation Laminate	6 Straight Trim	Edge Trim Colors (for trim style 6)	Source Laminate
M Metal			Flintwood	9 Flintwood Flat Trim		Foundation (for metal gables)
						Mica (for metal gables)

SAMPLE ORDER CODE

RVRD M	30	36	XG	6	SS	J
--------	----	----	----	---	----	---

DIMENSIONS INCHES / MM

D	W
24 / 610	36 / 914
24 / 610	42 / 1067
24 / 610	48 / 1219
30 / 762	36 / 914
30 / 762	42 / 1067
30 / 762	48 / 1219
30 / 762	54 / 1372

PRICING

LAMINATE GABLES (L)

Foundation Laminate	Flintwood
1516	2255
1609	2397
1719	2554
1531	2275
1625	2416
1738	2581
1855	2754

METAL GABLES (M)

Foundation Laminate	Flintwood
1822	2704
1919	2844
2024	3009
1836	2727
1931	2868
2044	3031
2155	3203

If Mica Gables are specified, add 43.

modular desks

Xpress

R D S D

Standard Corner Desk – Half Gables

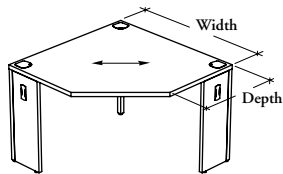

This fixed-height desk is for use in corners between two semi-supported desks. It is designed to enable the application of a keyboard shelf.

WHAT'S INCLUDED

1 worksurface, 3 metal corner posts with levelers, 2 structural beams, 2 half gables with levelers, 2 flush plates, wire management clips, grommets, and hardware.

WHAT'S EXCLUDED

Flush-Mounted Modesty Panels and Keyboard Shelf.

NOTES

This desk is semi-supported and must be connected to other desks on both sides.

PRODUCT OPTIONS

Gable Style	Depth	Width	Worksurface Finish	Edge Trim Style	Edge Trim Finish	Gable and Grommet Finish
L Laminate M Metal	24, 30	36, 42, 48, 54	Foundation Laminate Flintwood	6 Straight Trim 9 Flintwood Flat Trim	Edge Trim Colors (for trim style 6)	Source Laminate Foundation (for metal gables) Mica (for metal gables)

SAMPLE ORDER CODE

RDS D L	24	36	2D	6	4D	LE
----------------	-----------	-----------	-----------	----------	-----------	-----------

DIMENSIONS INCHES / MM

D	W
24 / 610	36 / 914
24 / 610	42 / 1067
24 / 610	48 / 1219
30 / 762	36 / 914
30 / 762	42 / 1067
30 / 762	48 / 1219
30 / 762	54 / 1372

PRICING

LAMINATE GABLES (L)

Foundation Laminate	Flintwood
1516	2255
1609	2397
1719	2554
1531	2275
1625	2416
1738	2581
1855	2754

METAL GABLES (M)

Foundation Laminate	Flintwood
1822	2704
1919	2844
2024	3009
1836	2727
1931	2868
2044	3031
2155	3203

If Mica Gables are specified, add 43.

This fixed-height desk is for use between two semi-supported desks.

WHAT'S INCLUDED

1 worksurface, 3 metal corner posts with levelers, 2 structural beams, 2 half gables with levelers, 2 flush plates, wire management clips, grommets, and hardware.

WHAT'S EXCLUDED

Flush-Mounted Modesty Panels.

NOTES

This desk is semi-supported and must be connected to other desks on both sides.

This product does **not** accept a keyboard shelf.

RTSR
Standard Radius Corner Desk – Half Gables

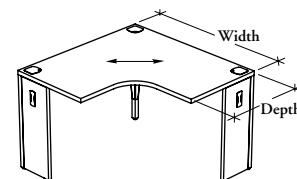

PRODUCT OPTIONS

Gable Style	Depth	Width	Worksurface Finish	Edge Trim Style	Edge Trim Finish	Gable and Grommet Finish
L Laminate	24, 30	36, 42, 48, 54	Foundation Laminate	6 Straight Trim	Edge Trim Colors (for trim style 6)	Source Laminate
M Metal			Flintwood	9 Flintwood Flat Trim		Foundation (for metal gables)

SAMPLE ORDER CODE

RTSR L	24	42	2D	6	4D	3D
---------------	-----------	-----------	-----------	----------	-----------	-----------

DIMENSIONS
INCHES / MM

D	W
24 / 610	36 / 914
24 / 610	42 / 1067
24 / 610	48 / 1219
30 / 762	42 / 1067
30 / 762	48 / 1219
30 / 762	54 / 1372

PRICING

LAMINATE GABLES (L)

Foundation Laminate	Flintwood
1235	1833
1373	2035
1515	2247
1384	2059
1529	2270
1682	2499

METAL GABLES (M)

Foundation Laminate	Flintwood
1539	2284
1679	2492
1821	2703
1691	2511
1835	2723
1987	2952

If Mica Gables are specified, add 43.

modular desks

Xpress

RVUR

Extended Corner Desk – Full Gables

This fixed-height desk is designed to maximize workspace space in confined areas.

WHAT'S INCLUDED

1 worksurface, 3 metal corner posts with levelers, 2 structural beams, 2 full gables with levelers, wire management clips, grommets, and hardware.

WHAT'S EXCLUDED

Flush-Mounted Modesty Panels.

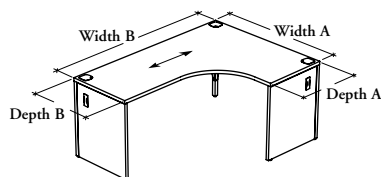

PRODUCT OPTIONS

Gable Style	Depth A	Depth B	Width A	Width B	Worksurface Configuration	Worksurface Finish	Edge Trim Style	Edge Trim Finish	Gable and Grommet Finish
L Laminate	24, 30	24, 30	42, 48, 54	60, 66, 72, 78, 84	L Left (Shown)	Foundation Laminate	6 Straight Trim	Edge Trim Colors (for trim style 6)	Source Laminate
M Metal					R Right	Flintwood	9 Flintwood Flat Trim		Foundation (for metal gables and metal c-legs)
C Metal C-Leg							Mica (for metal gables and metal c-legs)		

SAMPLE ORDER CODE

RVUR C	24	30	48	78	R	XS	6	ST	Q
---------------	-----------	-----------	-----------	-----------	----------	-----------	----------	-----------	----------

**DIMENSIONS – INCHES
FOR MM X BY 25.4**

PRICING

Da	Db	Wa	Wb	LAMINATE GABLES (L)		METAL GABLES (M)		METAL C-LEGS (C)	
				Foundation Laminate	Flintwood	Foundation Laminate	Flintwood	Foundation Laminate	Flintwood
24	24	42	60	1728	2567	2174	3160	2174	3160
24	24	42	66	1807	2683	2257	3282	2257	3282
24	24	42	72	1888	2805	2335	3402	2335	3402
24	24	42	78	1960	2912	2409	3511	2409	3511
24	24	42	84	2044	3031	2493	3630	2493	3630
24	24	48	60	1819	2699	2265	3298	2265	3298
24	24	48	66	1926	2857	2373	3454	2373	3454
24	24	48	72	2006	2982	2458	3575	2458	3575
24	24	48	78	2083	3093	2531	3691	2531	3691
24	24	48	84	2169	3217	2615	3814	2615	3814
24	24	54	60	1937	2871	2381	3471	2381	3471
24	24	54	66	2032	3019	2484	3616	2484	3616
24	24	54	72	2132	3163	2581	3764	2581	3764
24	24	54	78	2224	3303	2670	3898	2670	3898
24	24	54	84	2322	3448	2771	4044	2771	4044
24	30	48	60	1862	2767	2322	3372	2322	3372
24	30	48	66	1946	2892	2406	3495	2406	3495
24	30	48	72	2033	3021	2491	3628	2491	3628
24	30	48	78	2118	3141	2578	3749	2578	3749
24	30	48	84	2199	3268	2661	3873	2661	3873

If Mica Gables or Mica C-Legs are specified, add 89.

Pricing is continued on the following page.

RVUR

**Extended Corner Desk – Full Gables
(Continued)**

**DIMENSIONS – INCHES
FOR MM X BY 25.4**

PRICING

Da	Db	Wa	Wb	LAMINATE GABLES (L)		METAL GABLES (M)		METAL C-LEGS (C)	
				Foundation Laminate	Flintwood	Foundation Laminate	Flintwood	Foundation Laminate	Flintwood
24	30	54	60	1953	2901	2413	3511	2413	3511
24	30	54	66	2057	3048	2511	3657	2511	3657
24	30	54	72	2153	3198	2613	3805	2613	3805
24	30	54	78	2245	3332	2705	3941	2705	3941
24	30	54	84	2346	3483	2805	4089	2805	4089
30	24	42	60	1747	2590	2205	3199	2205	3199
30	24	42	66	1826	2714	2286	3315	2286	3315
30	24	42	72	1906	2829	2369	3441	2369	3441
30	24	42	78	1982	2944	2441	3550	2441	3550
30	24	42	84	2064	3066	2524	3669	2524	3669
30	24	48	60	1859	2762	2320	3369	2320	3369
30	24	48	66	1943	2887	2402	3489	2402	3489
30	24	48	72	2031	3016	2491	3618	2491	3618
30	24	48	78	2116	3135	2575	3742	2575	3742
30	24	48	84	2197	3261	2656	3867	2656	3867
30	24	54	60	1949	2897	2409	3503	2409	3503
30	24	54	66	2052	3043	2507	3652	2507	3652
30	24	54	72	2149	3192	2605	3797	2605	3797
30	24	54	78	2241	3328	2702	3935	2702	3935
30	24	54	84	2342	3477	2801	4083	2801	4083
30	30	48	60	1880	2787	2349	3407	2349	3407
30	30	48	66	1955	2902	2426	3524	2426	3524
30	30	48	72	2044	3033	2511	3654	2511	3654
30	30	48	78	2126	3158	2596	3778	2596	3778
30	30	48	84	2216	3292	2687	3912	2687	3912
30	30	54	60	1971	2924	2439	3541	2439	3541
30	30	54	66	2068	3074	2540	3691	2540	3691
30	30	54	72	2173	3220	2641	3838	2641	3838
30	30	54	78	2263	3362	2729	3979	2729	3979
30	30	54	84	2366	3512	2834	4127	2834	4127

If Mica Gables or Mica C-Legs are specified, add 89.

modular desks

Xpress

RVUS

Extended Corner Desk – Full and Half Gables

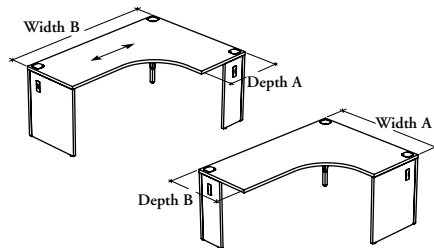

Configuration 1

Configuration 3

This fixed-height desk is designed to maximize workspace space in confined areas.

WHAT'S INCLUDED

1 worksurface, 3 metal corner posts with levelers, 2 structural beams, 1 full gable and 1 half gable with levelers, 1 flush plate, wire management clips, grommets, and hardware.

WHAT'S EXCLUDED

Flush-Mounted Modesty Panels.

NOTES

This desk is semi-supported and must be connected to another desk on the half gable side.

PRODUCT OPTIONS

Gable Style	Depth A	Depth B	Width A	Width B	Worksurface Configuration	Worksurface Finish	Edge Trim Style	Edge Trim Finish	Gable and Grommet Finish
L Laminate	24, 30	24, 30	42, 48, 54	60, 66, 72, 78, 84	1 Left handed worksurface, left full gable (Shown)	Foundation Laminate Flintwood	6 Straight Trim	Edge Trim Colors (for trim style 6)	Source Laminate Foundation (for metal gables and metal c-leg) Mica (for metal gables and metal c-leg)
M Metal					2 Right handed worksurface, right full gable		9 Flintwood Flat Trim		
C Metal C-Leg					3 Left handed worksurface, right full gable (Shown)				
					4 Right handed worksurface, left full gable				

SAMPLE ORDER CODE

RVUS L	30	30	48	66	4	2D	6	4D	3D
--------	----	----	----	----	---	----	---	----	----

DIMENSIONS – INCHES FOR MM X BY 25.4

Da	Db	Wa	Wb
24	24	42	60
24	24	42	66
24	24	42	72
24	24	42	78
24	24	42	84
24	24	48	60
24	24	48	66
24	24	48	72
24	24	48	78
24	24	48	84
24	24	54	60
24	24	54	66
24	24	54	72
24	24	54	78
24	24	54	84

PRICING

LAMINATE GABLES (L)		METAL GABLES (M)		METAL C-LEGS (C)	
Foundation Laminate	Flintwood	Foundation Laminate	Flintwood	Foundation Laminate	Flintwood
1728	2567	2079	3084	2079	3084
1807	2681	2152	3196	2152	3196
1887	2804	2230	3313	2230	3313
1960	2912	2299	3413	2299	3413
2044	3030	2373	3528	2373	3528
1819	2699	2173	3222	2173	3222
1924	2856	2257	3354	2257	3354
2006	2981	2344	3478	2344	3478
2083	3093	2419	3591	2419	3591
2169	3217	2501	3717	2501	3717
1935	2871	2270	3376	2270	3376
2032	3018	2366	3514	2366	3514
2132	3162	2459	3655	2459	3655
2224	3303	2546	3782	2546	3782
2321	3448	2638	3920	2638	3920

If Mica Gables or Mica C-Leg are specified, add 48.

Pricing is continued on the following page.

RVUS
Extended Corner Desk –
Full and Half Gables (Continued)

DIMENSIONS – INCHES
FOR MM X BY 25.4

PRICING

				LAMINATE GABLES (L)		METAL GABLES (M)		METAL C-LEGS (C)	
Da	Db	Wa	Wb	Foundation Laminate	Flintwood	Foundation Laminate	Flintwood	Foundation Laminate	Flintwood
24	30	48	60	1862	2765	2213	3285	2213	3285
24	30	48	66	1946	2891	2298	3409	2298	3409
24	30	48	72	2033	3019	2381	3537	2381	3537
24	30	48	78	2117	3141	2459	3655	2459	3655
24	30	48	84	2198	3268	2546	3780	2546	3780
24	30	54	60	1953	2900	2317	3436	2317	3436
24	30	54	66	2056	3048	2406	3574	2406	3574
24	30	54	72	2152	3196	2500	3712	2500	3712
24	30	54	78	2243	3330	2587	3838	2587	3838
24	30	54	84	2346	3483	2680	3980	2680	3980
30	24	42	60	1747	2589	2093	3111	2093	3111
30	24	42	66	1826	2712	2173	3220	2173	3220
30	24	42	72	1906	2829	2247	3335	2247	3335
30	24	42	78	1980	2943	2319	3444	2319	3444
30	24	42	84	2062	3065	2399	3557	2399	3557
30	24	48	60	1859	2761	2187	3248	2187	3248
30	24	48	66	1941	2886	2272	3377	2272	3377
30	24	48	72	2029	3015	2362	3504	2362	3504
30	24	48	78	2114	3135	2441	3623	2441	3623
30	24	48	84	2196	3261	2526	3748	2526	3748
30	24	54	60	1949	2895	2294	3405	2294	3405
30	24	54	66	2052	3043	2386	3543	2386	3543
30	24	54	72	2148	3191	2485	3686	2485	3686
30	24	54	78	2240	3327	2569	3814	2569	3814
30	24	54	84	2342	3477	2663	3952	2663	3952
30	30	48	60	1880	2787	2231	3314	2231	3314
30	30	48	66	1955	2901	2318	3443	2318	3443
30	30	48	72	2044	3031	2402	3568	2402	3568
30	30	48	78	2126	3155	2485	3686	2485	3686
30	30	48	84	2216	3291	2569	3813	2569	3813
30	30	54	60	1970	2924	2332	3463	2332	3463
30	30	54	66	2067	3073	2428	3609	2428	3609
30	30	54	72	2173	3220	2524	3744	2524	3744
30	30	54	78	2263	3362	2612	3877	2612	3877
30	30	54	84	2364	3511	2703	4014	2703	4014

If Mica Gables or Mica C-Leg are specified, add 48.

modular desks

Xpress

RVUD

Extended Corner Desk – Half Gables

This fixed-height desk is designed to maximize workspace space in confined areas.

WHAT'S INCLUDED

1 worksurface, 3 metal corner posts with levelers, 2 structural beams, 2 half gables with levelers, 2 flush plates, wire management clips, grommets, and hardware.

WHAT'S EXCLUDED

Flush-Mounted Modesty Panels.

NOTES

This desk is semi-supported and must be connected to other desks on both sides.

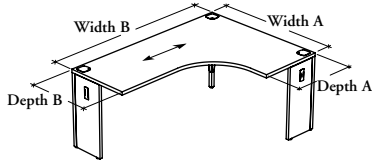

PRODUCT OPTIONS

Gable Style	Depth A	Depth B	Width A	Width B	Worksurface Configuration	Worksurface Finish	Edge Trim Style	Edge Trim Finish	Gable and Grommet Finish
L Laminate	24, 30	24, 30	42, 48, 54	60, 66, 72, 78, 84	L Left (Shown)	Foundation Laminate	6 Straight Trim	Edge Trim Colors (for trim style 6)	Source Laminate
M Metal					R Right	Flintwood	9 Flintwood Flat Trim		Foundation (for metal gables) Mica (for metal gables)

SAMPLE ORDER CODE

RVUD L	24	24	42	60	L	2D	6	4D	3D
---------------	-----------	-----------	-----------	-----------	----------	-----------	----------	-----------	-----------

DIMENSIONS – INCHES FOR MM X BY 25.4

Da	Db	Wa	Wb
24	24	42	60
24	24	42	66
24	24	42	72
24	24	42	78
24	24	42	84
24	24	48	60
24	24	48	66
24	24	48	72
24	24	48	78
24	24	48	84
24	24	54	60
24	24	54	66
24	24	54	72
24	24	54	78
24	24	54	84
24	30	48	60
24	30	48	66
24	30	48	72
24	30	48	78
24	30	48	84

PRICING

LAMINATE GABLES (L)

Foundation Laminate	Flintwood
1728	2567
1807	2681
1887	2804
1960	2912
2044	3030
1819	2699
1924	2856
2006	2981
2083	3093
2169	3217
1935	2871
2032	3018
2132	3162
2224	3303
2321	3448
1862	2765
1946	2891
2033	3019
2117	3141
2198	3268

METAL GABLES (M)

Foundation Laminate	Flintwood
2029	3016
2114	3135
2192	3258
2265	3365
2349	3488
2124	3152
2230	3312
2315	3432
2387	3545
2470	3666
2240	3327
2340	3473
2439	3618
2528	3751
2627	3898
2170	3218
2253	3343
2333	3477
2422	3597
2502	3720

If Mica Gables are specified, add 43.

Pricing is continued on the following page.

RVUD
Extended Corner Desk – Half Gables
(Continued)

DIMENSIONS – INCHES
FOR MM X BY 25.4

PRICING

				LAMINATE GABLES (L)		METAL GABLES (M)	
Da	Db	Wa	Wb	Foundation Laminate	Flintwood	Foundation Laminate	Flintwood
24	30	54	60	1953	2900	2259	3357
24	30	54	66	2056	3048	2358	3502
24	30	54	72	2152	3196	2458	3654
24	30	54	78	2243	3330	2550	3785
24	30	54	84	2346	3483	2648	3935
30	24	42	60	1747	2589	2052	3045
30	24	42	66	1826	2712	2130	3160
30	24	42	72	1906	2829	2213	3285
30	24	42	78	1980	2943	2284	3395
30	24	42	84	2062	3065	2368	3518
30	24	48	60	1859	2761	2168	3214
30	24	48	66	1941	2886	2245	3333
30	24	48	72	2029	3015	2333	3465
30	24	48	78	2114	3135	2417	3587
30	24	48	84	2196	3261	2499	3712
30	24	54	60	1949	2895	2256	3351
30	24	54	66	2052	3043	2356	3494
30	24	54	72	2148	3191	2451	3646
30	24	54	78	2240	3327	2546	3780
30	24	54	84	2342	3477	2645	3927
30	30	48	60	1880	2787	2182	3242
30	30	48	66	1955	2901	2261	3359
30	30	48	72	2044	3031	2349	3488
30	30	48	78	2126	3155	2431	3611
30	30	48	84	2216	3291	2524	3744
30	30	54	60	1970	2924	2272	3376
30	30	54	66	2067	3073	2373	3528
30	30	54	72	2173	3220	2480	3676
30	30	54	78	2263	3362	2569	3814
30	30	54	84	2364	3511	2669	3963

If Mica Gables are specified, add 43.

modular desks

Xpress

RTL DL Rectangular Worksurface

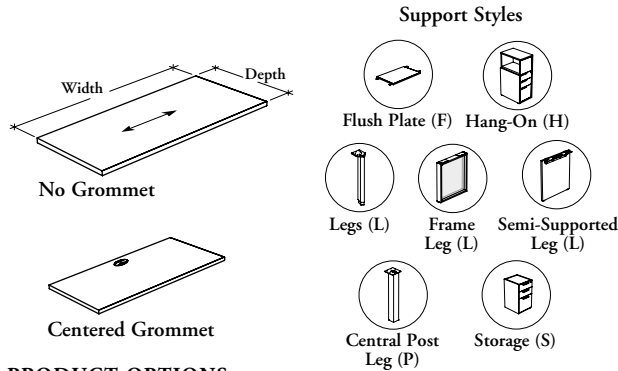

This worksurface may be used as a peninsula, a bridge or as a collaborative worksurface.

WHAT'S INCLUDED

1 worksurface, grommet and 1 cable tray (as specified), and hardware.

WHAT'S EXCLUDED

Supports and Worksurface Suspended Modesty Panel.

NOTES

Central Post Leg option (P) **cannot** be specified on both sides.

Some support style combinations require to be attached to other desk products. For stability see Application Guide for details.

When Centered Grommet Option (C) is specified, a Cable Tray is included.

Hardware is finished in Black.

PRODUCT OPTIONS

Depth	Width	Grommet Option	Support (Left Side)	Support (Right Side)	Worksurface Finish	Edge Trim Style	Edge Trim Finish	Grommet Finish (If applicable)
20, 24, 30	24, 27, 30, 33, 34, 36, 37, 39, 40, 42, 43, 45, 46, 48, 49, 51, 52, 54, 55, 57, 58, 60, 63, 64, 66, 69, 72, 78, 84	C Centered N No Grommet	F Flush Plate H Hang-On L Legs/Frame Leg/Semi-Supported Leg P Central Post Leg S Storage	F Flush Plate H Hang-On L Legs/Frame Leg/Semi-Supported Leg P Central Post Leg S Storage	Foundation Laminate Flintwood	6 Straight Trim 9 Flintwood Flat Trim	Edge Trim Colors (for trim style 6)	Source Laminate Foundation Mica

SAMPLE ORDER CODE

RTL DL 24	60	N	L	H	2D	6	4D	
------------------	-----------	----------	----------	----------	-----------	----------	-----------	--

DIMENSIONS INCHES / MM

D	W
20 / 454	24 / 610
20 / 454	27 / 686
20 / 454	30 / 762
20 / 454	33 / 838
20 / 454	34 / 864
20 / 454	36 / 914
20 / 454	37 / 940
20 / 454	39 / 991
20 / 454	40 / 1016
20 / 454	42 / 1067
20 / 454	43 / 1092
20 / 454	45 / 1143
20 / 454	46 / 1168
20 / 454	48 / 1219
20 / 454	49 / 1245

PRICING

Foundation Laminate	Flintwood
211	528
226	541
252	565
293	607
297	625
309	658
319	677
340	720
349	733
370	792
375	814
398	855
406	876
426	918
434	935

DIMENSIONS INCHES / MM

D	W
20 / 454	51 / 1295
20 / 454	52 / 1321
20 / 454	54 / 1372
20 / 454	55 / 1397
20 / 454	57 / 1448
20 / 454	60 / 1524
20 / 454	63 / 1600
20 / 454	64 / 1626
20 / 454	66 / 1676
20 / 454	69 / 1753
20 / 454	72 / 1829
20 / 454	78 / 1981
20 / 454	84 / 2134

PRICING

Foundation Laminate	Flintwood
456	974
465	996
480	1036
493	1053
506	1089
515	1110
532	1139
560	1180
572	1202
589	1257
602	1295
618	1334
654	1404
698	1506

If Right Support Style H are specified, add 44.

If Right Support Style S are specified, add 84.

If Left Support Style H are specified, add 44.

If Left Support Style S are specified, add 84.

Pricing is continued on the following page.

RTLDL
Rectangular Worksurface
(Continued)

DIMENSIONS INCHES / MM		PRICING		DIMENSIONS INCHES / MM		PRICING	
D	W	Foundation Laminate	Flintwood	D	W	Foundation Laminate	Flintwood
24 / 610	24 / 610	252	632	24 / 610	51 / 1295	512	1100
24 / 610	27 / 686	278	639	24 / 610	52 / 1321	520	1122
24 / 610	30 / 762	303	683	24 / 610	54 / 1372	542	1166
24 / 610	33 / 838	345	723	24 / 610	55 / 1397	550	1190
24 / 610	34 / 864	349	742	24 / 610	57 / 1448	572	1234
24 / 610	36 / 914	361	774	24 / 610	58 / 1473	582	1253
24 / 610	37 / 940	370	795	24 / 610	60 / 1524	600	1293
24 / 610	39 / 991	390	838	24 / 610	63 / 1600	633	1358
24 / 610	40 / 1016	401	861	24 / 610	64 / 1626	640	1380
24 / 610	42 / 1067	419	900	24 / 610	66 / 1676	661	1424
24 / 610	43 / 1092	429	923	24 / 610	69 / 1753	693	1488
24 / 610	45 / 1143	451	966	24 / 610	72 / 1829	723	1556
24 / 610	46 / 1168	461	991	24 / 610	78 / 1981	783	1682
24 / 610	48 / 1219	480	1036	24 / 610	84 / 2134	839	1807
24 / 610	49 / 1245	491	1057				
30 / 762	24 / 610	312	684	30 / 762	51 / 1295	637	1375
30 / 762	27 / 686	349	764	30 / 762	52 / 1321	648	1400
30 / 762	30 / 762	383	833	30 / 762	54 / 1372	674	1453
30 / 762	33 / 838	416	897	30 / 762	55 / 1397	687	1478
30 / 762	34 / 864	427	923	30 / 762	57 / 1448	715	1531
30 / 762	36 / 914	451	965	30 / 762	58 / 1473	725	1558
30 / 762	37 / 940	462	994	30 / 762	60 / 1524	752	1614
30 / 762	39 / 991	490	1050	30 / 762	63 / 1600	790	1696
30 / 762	40 / 1016	499	1079	30 / 762	64 / 1626	802	1723
30 / 762	42 / 1067	527	1132	30 / 762	66 / 1676	828	1777
30 / 762	43 / 1092	541	1161	30 / 762	69 / 1753	864	1857
30 / 762	45 / 1143	564	1211	30 / 762	72 / 1829	898	1935
30 / 762	46 / 1168	574	1241	30 / 762	78 / 1981	974	2098
30 / 762	48 / 1219	600	1293	30 / 762	84 / 2134	1053	2264
30 / 762	49 / 1245	612	1321				

If Right Support Style H are specified, add 44.

If Right Support Style S are specified, add 84.

If Left Support Style H are specified, add 44.

If Left Support Style S are specified, add 84.

modular desks

Xpress

RTLDC

Cross Grain Rectangular Worksurface

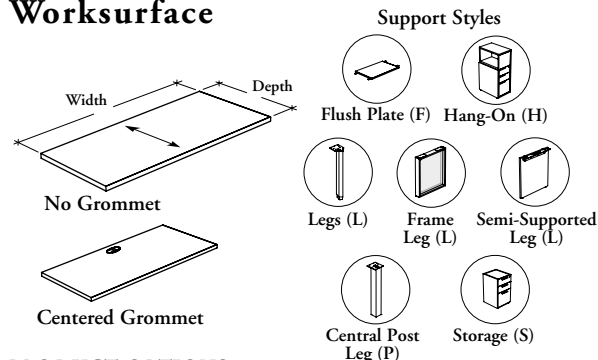

This worksurface may be used as a peninsula, a bridge or as a collaborative worksurface.

WHAT'S INCLUDED

1 worksurface, grommet and 1 cable tray (as specified), and hardware.

WHAT'S EXCLUDED

Supports and Worksurface Suspended Modesty Panel.

NOTES

Central Post Leg option (P) **cannot** be specified on both sides.

Some support style combinations require to be attached to other desk products. For stability see Application Guide for details.

When Centered Grommet Option (C) is specified, a Cable Tray is included.

Hardware is finished in Black.

PRODUCT OPTIONS

Depth	Width	Grommet Option	Support (Left Side)	Support (Right Side)	Worksurface Finish	Edge Trim Style	Edge Trim Finish	Grommet Finish (If applicable)
20, 24, 30	24, 27, 30, 33, 34, 36, 37, 39, 40, 42, 43, 45, 46, 48, 49, 51, 52, 54, 55, 57, 58, 60	C Centered N No Grommet	F Flush Plate	F Flush Plate	Foundation Laminate Flintwood	6 Straight Trim 9 Flintwood Flat Trim	Edge Trim Colors (for trim style 6)	Source Laminate Foundation Mica
			H Hang-On	H Hang-On				
			L Legs/Frame Leg/Semi-Supported Leg	L Legs/Frame Leg/Semi-Supported Leg				
			P Central Post Leg	P Central Post Leg				
			S Storage	S Storage				

SAMPLE ORDER CODE

RTLDC 24	51	C	L	H	2D	6	4D	E
-----------------	-----------	----------	----------	----------	-----------	----------	-----------	----------

DIMENSIONS INCHES / MM

D	W
20 / 454	24 / 610
20 / 454	27 / 686
20 / 454	30 / 762
20 / 454	33 / 838
20 / 454	34 / 864
20 / 454	36 / 914
20 / 454	37 / 940
20 / 454	39 / 991
20 / 454	40 / 1016
20 / 454	42 / 1067
20 / 454	43 / 1092

PRICING

Foundation Laminate	Flintwood
211	528
226	541
252	565
253	523
297	625
309	658
319	677
340	720
349	733
370	792
375	814

DIMENSIONS INCHES / MM

D	W
20 / 454	45 / 1143
20 / 454	46 / 1168
20 / 454	48 / 1219
20 / 454	49 / 1245
20 / 454	51 / 1295
20 / 454	52 / 1321
20 / 454	54 / 1372
20 / 454	55 / 1397
20 / 454	57 / 1448
20 / 454	58 / 1473
20 / 454	60 / 1524

PRICING

Foundation Laminate	Flintwood
398	855
406	876
426	918
434	935
456	974
465	996
480	1036
493	1053
506	1089
515	1110
532	n/a

If Right Support Style H are specified, add 44.

If Right Support Style S are specified, add 84.

If Left Support Style H are specified, add 44.

If Left Support Style S are specified, add 84.

Pricing is continued on the following page.

RTLDC
Cross Grain Rectangular
Worksurface (Continued)

DIMENSIONS INCHES / MM		PRICING		DIMENSIONS INCHES / MM		PRICING	
D	W	Foundation Laminate	Flintwood	D	W	Foundation Laminate	Flintwood
24 / 610	24 / 610	252	632	24 / 610	45 / 1143	451	966
24 / 610	27 / 686	278	639	24 / 610	46 / 1168	461	991
24 / 610	30 / 762	303	683	24 / 610	48 / 1219	480	1036
24 / 610	33 / 838	297	623	24 / 610	49 / 1245	491	1057
24 / 610	34 / 864	349	742	24 / 610	51 / 1295	512	1100
24 / 610	36 / 914	361	774	24 / 610	52 / 1321	520	1122
24 / 610	37 / 940	370	795	24 / 610	54 / 1372	542	1166
24 / 610	39 / 991	390	838	24 / 610	55 / 1397	550	1190
24 / 610	40 / 1016	401	861	24 / 610	57 / 1448	572	1234
24 / 610	42 / 1067	419	900	24 / 610	58 / 1473	582	1253
24 / 610	43 / 1092	429	923	24 / 610	60 / 1524	600	n/a
30 / 762	24 / 610	312	684	30 / 762	45 / 1143	564	1211
30 / 762	27 / 686	349	764	30 / 762	46 / 1168	574	1241
30 / 762	30 / 762	383	833	30 / 762	48 / 1219	600	1293
30 / 762	33 / 838	359	773	30 / 762	49 / 1245	612	1321
30 / 762	34 / 864	427	923	30 / 762	51 / 1295	637	1375
30 / 762	36 / 914	451	965	30 / 762	52 / 1321	648	1400
30 / 762	37 / 940	462	994	30 / 762	54 / 1372	674	1453
30 / 762	39 / 991	490	1050	30 / 762	55 / 1397	687	1478
30 / 762	40 / 1016	499	1079	30 / 762	57 / 1448	715	1531
30 / 762	42 / 1067	527	1132	30 / 762	58 / 1473	725	1558
30 / 762	43 / 1092	541	1161	30 / 762	60 / 1524	752	n/a

If Right Support Style H are specified, add 44.

If Right Support Style S are specified, add 84.

If Left Support Style H are specified, add 44.

If Left Support Style S are specified, add 84.

modular desks

Xpress

RDRP

Rectangular Peninsula Desk – Half Gables

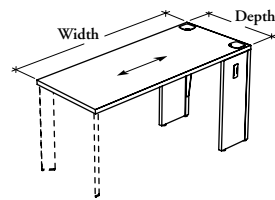

Support Styles

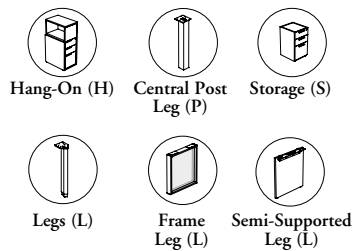

This fixed-height desk is ideal for small meeting spaces or team workstations.

WHAT'S INCLUDED

1 worksurface, 2 metal corner posts with levelers, 1 structural beam, 2 half gables with levelers, 2 flush plates, grommets, wire management clips, and mounting hardware.

WHAT'S EXCLUDED

Supports.

NOTES

Support styles L, S and P are not available for widths 51", 57", 63", and 69".

Hang-On brackets are finished in Black.

PRODUCT OPTIONS

Gable Style	Depth	Width	Support Style	Worksurface Finish	Edge Trim Style	Edge Trim Finish	Gable and Grommet Finish
L Laminate	24, 30	48, 51, 54, 57, 60, 63, 66, 69, 72, 78, 84	H Hang-On	Foundation Laminate Flintwood	6 Straight Trim 9 Flintwood Flat Trim	Edge Trim Colors (for trim style 6)	Source Laminate (for metal gables) Mica (for metal gables)
M Metal			L Legs (Shown)/ Frame Leg/ Semi-Supported Leg P Central Post Leg S Storage				

SAMPLE ORDER CODE

RDRP L	24	84	L	2D	6	4D	3D
---------------	-----------	-----------	----------	-----------	----------	-----------	-----------

DIMENSIONS INCHES / MM

D	W
24 / 610	48 / 1219
24 / 610	51 / 1295
24 / 610	54 / 1372
24 / 610	57 / 1448
24 / 610	60 / 1524
24 / 610	63 / 1600
24 / 610	66 / 1676
24 / 610	69 / 1753
24 / 610	72 / 1829
24 / 610	78 / 1981
24 / 610	84 / 2134
30 / 762	48 / 1219
30 / 762	51 / 1295
30 / 762	54 / 1372
30 / 762	57 / 1448
30 / 762	60 / 1524
30 / 762	63 / 1600
30 / 762	66 / 1676
30 / 762	69 / 1753
30 / 762	72 / 1829
30 / 762	78 / 1981
30 / 762	84 / 2134

PRICING

LAMINATE GABLES (L)

Foundation Laminate	Flintwood
1053	1464
1082	1529
1115	1597
1144	1661
1172	1723
1205	1791
1237	1855
1254	1887
1278	1926
1327	2016
1397	2129
1086	1487
1122	1568
1161	1648
1201	1725
1239	1811
1278	1890
1310	1972
1342	2021
1375	2066
1429	2170
1513	2292

METAL GABLES (M)

Foundation Laminate	Flintwood
1355	1921
1384	1985
1416	2052
1444	2117
1477	2178
1507	2243
1537	2311
1558	2344
1579	2375
1631	2468
1706	2581
1392	1938
1427	2021
1464	2095
1506	2177
1543	2261
1580	2343
1617	2422
1650	2470
1679	2518
1734	2619
1815	2745

If Hang-On Support (H) are specified, add 36.

If Storage Support (S) are specified, add 72.

If Mica Gables are specified, add 43.

This fixed-height worksurface mounts to another desk at one end and is supported by a single support at the other. This worksurface is ideal for small meeting spaces or team workstations.

R D B N D-Shaped Peninsula Worksurface

WHAT'S INCLUDED

1 worksurface, 1 support with leveler, 4 flush plates, and hardware.

WHAT'S EXCLUDED

Inset Modesty Panel.

NOTES

This desk is semi-supported and must be connected to another desk.

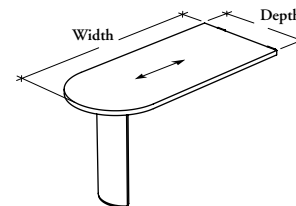

PRODUCT OPTIONS

Support Style	Depth	Width	Worksurface Finish	Edge Trim Style	Edge Trim Finish	Support Finish
P Central Post Leg – 3 1/2" Round	24, 30, 36	48, 54, 60, 66, 72, 78, 84	Foundation Laminate	6 Straight Trim	Edge Trim Colors (for trim style 6)	Foundation Mica
S Camber Base (Shown)			9 Flintwood Flat Trim			

SAMPLE ORDER CODE

RDBN P	36	60	2D	6	4D	Q
---------------	-----------	-----------	-----------	----------	-----------	----------

DIMENSIONS INCHES / MM

D	W
24 / 610	48 / 1219
24 / 610	54 / 1372
24 / 610	60 / 1524
24 / 610	66 / 1676
24 / 610	72 / 1829
24 / 610	78 / 1981
24 / 610	84 / 2134
30 / 762	48 / 1219
30 / 762	54 / 1372
30 / 762	60 / 1524
30 / 762	66 / 1676
30 / 762	72 / 1829
30 / 762	78 / 1981
30 / 762	84 / 2134
36 / 914	48 / 1219
36 / 914	54 / 1372
36 / 914	60 / 1524
36 / 914	66 / 1676
36 / 914	72 / 1829
36 / 914	78 / 1981
36 / 914	84 / 2134

PRICING

CENTRAL POST LEG – 3 1/2" ROUND (P)	
Foundation Laminate	Flintwood
689	1169
718	1217
742	1257
782	1328
820	1392
861	1460
897	1528
756	1285
795	1351
835	1421
864	1465
933	1586
977	1663
1023	1748
847	1440
887	1510
928	1576
986	1674
1043	1772
1099	1865
1155	1965

CAMBER BASE (S)	
Foundation Laminate	Flintwood
860	1339
887	1387
911	1429
952	1498
991	1564
1028	1631
1067	1697
925	1456
964	1520
1006	1587
1032	1634
1102	1755
1148	1834
1195	1919
1015	1609
1057	1679
1095	1748
1154	1842
1210	1941
1263	2035
1327	2136

If Mica Support is specified, add 14.

modular desks

Xpress

R D B U

D-Shaped Peninsula Desk – Half Gables

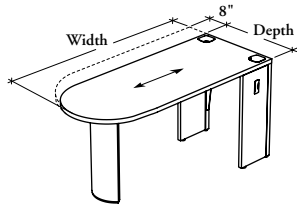

This fixed-height desk is ideal for small meeting spaces or team workstations.

WHAT'S INCLUDED

1 worksurface, 2 metal corner posts with levelers, 1 structural beam, 2 half gables with levelers, 1 support with leveler, 2 flush plates, wire management clips, grommets, and hardware.

WHAT'S EXCLUDED

Flush-Mounted Modesty Panel and Inset Modesty Panel.

NOTES

This desk is semi-supported and must be connected to another desk.

If Recessed visitor option (R) is specified, width 54" is **not** available.

When Flush visitor option (F) is specified, Worksurface Configuration is **not** applicable.

When Recessed visitor option (R) is specified, an additional 8" kneespace clearance is provided.

PRODUCT OPTIONS

Visitor Option	Gable Style	Support Style	Depth	Width	Worksurface Configuration (If applicable)	Worksurface Finish	Edge Trim Style	Edge Trim Finish	Gable and Grommet Finish	Support Finish
F Flush R Recessed	L Laminate M Metal	P Central Post Leg – 3 1/2" Round S Camber Base (Shown)	24, 30, 36	48, 54, 60, 66, 72, 78, 84	L Left (Shown) R Right	Foundation Laminate Flintwood	6 Straight Trim 9 Flintwood Flat Trim	Edge Trim Colors (for trim style 6)	Source Laminate Foundation (for metal gables) Mica (for metal gables)	Foundation Mica

SAMPLE ORDER CODE

RDBU F	L	P	36	60	L	2D	6	4D	3D	P
---------------	----------	----------	-----------	-----------	----------	-----------	----------	-----------	-----------	----------

DIMENSIONS INCHES / MM

D	W
24 / 610	48 / 1219
24 / 610	54 / 1372
24 / 610	60 / 1524
24 / 610	66 / 1676
24 / 610	72 / 1829
24 / 610	78 / 1981
24 / 610	84 / 2134
30 / 762	48 / 1219
30 / 762	54 / 1372
30 / 762	60 / 1524
30 / 762	66 / 1676
30 / 762	72 / 1829
30 / 762	78 / 1981
30 / 762	84 / 2134
36 / 914	48 / 1219
36 / 914	54 / 1372
36 / 914	60 / 1524
36 / 914	66 / 1676
36 / 914	72 / 1829
36 / 914	78 / 1981
36 / 914	84 / 2134

PRICING

FLUSH VISITOR OPTION (F)

CENTRAL POST LEG – 3 1/2" ROUND (P)

LAMINATE GABLES (L)		METAL GABLES (M)	
Foundation Laminate	Flintwood	Foundation Laminate	Flintwood
1192	1931	1498	2427
1226	1985	1529	2484
1259	2044	1566	2537
1303	2116	1609	2612
1349	2185	1654	2680
1377	2231	1682	2723
1402	2270	1708	2765
1252	2024	1556	2523
1276	2062	1579	2555
1296	2096	1601	2590
1346	2182	1653	2676
1413	2284	1714	2781
1441	2340	1750	2829
1477	2397	1781	2887
1318	2136	1623	2629
1370	2219	1674	2714
1421	2299	1725	2796
1477	2397	1781	2887
1528	2482	1834	2968
1566	2537	1873	3030
1607	2603	1913	3095

CAMBER BASE (S)

LAMINATE GABLES (L)		METAL GABLES (M)	
Foundation Laminate	Flintwood	Foundation Laminate	Flintwood
1364	2102	1665	2591
1393	2153	1699	2647
1430	2213	1737	2705
1474	2283	1779	2777
1517	2357	1825	2848
1549	2401	1854	2894
1572	2443	1880	2937
1421	2196	1725	2689
1441	2233	1750	2725
1464	2267	1771	2762
1516	2355	1822	2845
1580	2456	1885	2950
1612	2503	1920	3001
1650	2561	1951	3057
1487	2304	1795	2799
1539	2387	1842	2884
1587	2465	1892	2961
1650	2561	1951	3057
1697	2646	2002	3139
1737	2705	2042	3199
1775	2770	2082	3268

If Mica Gables are specified, add 43.

If Mica Supports are specified, add 14.

Pricing is continued on the following page.

R D B U

D-Shaped Peninsula Desk – Half Gables (Continued)

DIMENSIONS
INCHES / MM

PRICING

		RECESSED VISITOR OPTION (R)							
		CENTRAL POST LEG – 3 1/2" ROUND (P)				CAMBER BASE (S)			
D		LAMINATE GABLES (L)		METAL GABLES (M)		LAMINATE GABLES (L)		METAL GABLES (M)	
		Foundation Laminate	Flintwood	Foundation Laminate	Flintwood	Foundation Laminate	Flintwood	Foundation Laminate	Flintwood
24 / 610	48 / 1219	1295	2094	1600	2589	1464	2264	1771	2761
24 / 610	54 / 1372	1318	2132	1624	2629	1487	2301	1796	2799
24 / 610	60 / 1524	1340	2170	1646	2663	1510	2340	1813	2829
24 / 610	66 / 1676	1392	2255	1696	2748	1559	2424	1864	2914
24 / 610	72 / 1829	1458	2356	1760	2852	1625	2528	1929	3021
24 / 610	78 / 1981	1487	2408	1796	2901	1656	2578	1964	3072
24 / 610	84 / 2134	1520	2463	1826	2957	1691	2631	1998	3126
30 / 762	48 / 1219	1364	2205	1666	2699	1535	2375	1837	2868
30 / 762	54 / 1372	1415	2291	1719	2783	1585	2459	1887	2952
30 / 762	60 / 1524	1464	2370	1771	2863	1633	2538	1938	3031
30 / 762	66 / 1676	1520	2463	1826	2957	1691	2631	1998	3126
30 / 762	72 / 1829	1572	2549	1879	3039	1740	2719	2045	3211
30 / 762	78 / 1981	1609	2605	1915	3101	1779	2776	2085	3270
30 / 762	84 / 2134	1652	2674	1956	3168	1819	2843	2125	3335
36 / 914	48 / 1219	1427	2317	1735	2812	1601	2487	1902	2981
36 / 914	54 / 1372	1513	2444	1812	2941	1680	2615	1980	3110
36 / 914	60 / 1524	1589	2572	1897	3066	1757	2734	2062	3231
36 / 914	66 / 1676	1650	2670	1955	3163	1822	2841	2125	3334
36 / 914	72 / 1829	1690	2741	1995	3225	1858	2906	2167	3400
36 / 914	78 / 1981	1735	2807	2037	3303	1902	2978	2207	3471
36 / 914	84 / 2134	1781	2887	2087	3376	1946	3050	2255	3550

If Mica Gables are specified, add 43.

If Mica Supports are specified, add 14.

modular desks

Xpress

R V D D

Extended D-Shaped Peninsula Desk – Half Gables

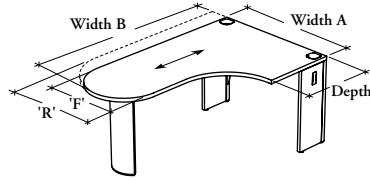

If 42" Width A:
'F' = 24"
'R' = 32"

If 48" or 54" Width A:
'F' = 30"
'R' = 38"

This fixed-height desk combines an extended corner with the rounded end of a bullet top.

WHAT'S INCLUDED

1 worksurface, 2 metal corner posts with levelers, 1 structural beam, 2 half gables with levelers, 1 support with leveler, 2 flush plates, wire management clips, grommets, and hardware.

WHAT'S EXCLUDED

Flush-Mounted Modesty Panel and Inset Modesty Panel.

NOTES

This desk is semi-supported and must be connected to another desk.

This product does **not** accept a keyboard shelf.

When Recessed visitor option (R) is specified, an additional 8" kneespace clearance is provided.

If Recessed visitor option (R) is specified, 54" width 'A' is **not** available.

PRODUCT OPTIONS

Visitor Option	Gable Style	Support Style	Depth	Width A	Width B	Worksurface Configuration	Worksurface Finish	Edge Trim Style	Edge Trim Finish	Gable and Grommet Finish	Support Finish
F Flush	L Laminate	P Central Post Leg – 3 1/2" Round	24, 30	42, 48, 54	54, 60, 66, 72, 78, 84	L Left (Shown) R Right	Foundation Laminate Flintwood	6 Straight Trim 9 Flintwood Flat Trim	Edge Trim Colors (for trim style 6)	Source Laminate Foundation (for metal gables) Mica (for metal gables)	Foundation Mica

SAMPLE ORDER CODE

RVDD F	M	P	24	42	54	R	2D	6	4D	E	E
---------------	----------	----------	-----------	-----------	-----------	----------	-----------	----------	-----------	----------	----------

DIMENSIONS INCHES / MM

PRICING

FLUSH VISITOR OPTION (F)

CENTRAL POST LEG – 3 1/2" ROUND (P)

LAMINATE GABLES (L)		METAL GABLES (M)	
Foundation Laminate	Flintwood	Foundation Laminate	Flintwood
1384	2805	1691	3420
1441	2922	1748	3537
1499	3033	1801	3654
1556	3149	1859	3765
1612	3262	1920	3880
1666	3377	1972	4000
1527	3091	1833	3707
1607	3249	1913	3871
1672	3386	1978	4007
1713	3473	2021	4089
1763	3572	2067	4189
1690	3417	1995	4033
1735	3512	2039	4130
1774	3591	2081	4208
1834	3712	2138	4330
1623	3286	1928	3902
1690	3419	1995	4038
1734	3504	2035	4124
1781	3610	2086	4227
1691	3422	1998	4045
1753	3546	2058	4160
1795	3626	2095	4247
1854	3749	2154	4372

CAMBER BASE (S)

LAMINATE GABLES (L)		METAL GABLES (M)	
Foundation Laminate	Flintwood	Foundation Laminate	Flintwood
1556	2973	1859	3591
1612	3089	1919	3706
1666	3203	1972	3822
1725	3319	2027	3937
1781	3432	2086	4051
1836	3546	2143	4162
1696	3261	2001	3879
1775	3420	2082	4043
1839	3557	2147	4176
1884	3645	2187	4256
1933	3742	2236	4358
1858	3586	2167	4206
1902	3685	2207	4298
1945	3762	2247	4379
2002	3884	2308	4500
1795	3454	2095	4072
1858	3587	2167	4207
1900	3676	2203	4293
1951	3778	2257	4394
1859	3593	2168	4210
1923	3717	2228	4331
1960	3797	2265	4415
2022	3922	2323	4538

If Mica Gables are specified, add 43.
If Mica Supports are specified, add 14.

Pricing is continued on the following page.

R V D D

**Extended D-Shaped Peninsula Desk –
Half Gables (Continued)**

**DIMENSIONS
INCHES / MM**

D	Wa	Wb
24 / 610	42 / 1067	54 / 1372
24 / 610	42 / 1067	60 / 1524
24 / 610	42 / 1067	66 / 1676
24 / 610	42 / 1067	72 / 1829
24 / 610	42 / 1067	78 / 1981
24 / 610	42 / 1067	84 / 2134
24 / 610	48 / 1219	60 / 1524
24 / 610	48 / 1219	66 / 1676
24 / 610	48 / 1219	72 / 1829
24 / 610	48 / 1219	78 / 1981
24 / 610	48 / 1219	84 / 2134
30 / 762	48 / 1219	66 / 1676
30 / 762	48 / 1219	72 / 1829
30 / 762	48 / 1219	78 / 1981
30 / 762	48 / 1219	84 / 2134

PRICING

RECESSED VISITOR OPTION (R)									
CENTRAL POST LEG – 3 1/2" ROUND (P)					CAMBER BASE (S)				
LAMINATE GABLES (L)			METAL GABLES (M)		LAMINATE GABLES (L)			METAL GABLES (M)	
Foundation Laminate	Flintwood		Foundation Laminate	Flintwood	Foundation Laminate	Flintwood	Foundation Laminate	Flintwood	
1491	2999		1796	3616	1662	3169	1965	3789	
1569	3160		1878	3780	1739	3330	2044	3952	
1652	3325		1956	3942	1819	3492	2125	4112	
1717	3457		2024	4075	1885	3627	2192	4247	
1759	3543		2064	4157	1928	3711	2234	4328	
1807	3646		2114	4260	1978	3814	2283	4429	
1689	3395		1994	4011	1858	3562	2167	4185	
1734	3489		2037	4104	1902	3657	2207	4276	
1778	3583		2083	4202	1946	3750	2253	4372	
1817	3661		2124	4278	1987	3831	2293	4449	
1879	3784		2181	4401	2045	3954	2354	4573	
1735	3493		2039	4116	1904	3662	2209	4284	
1798	3617		2103	4234	1967	3786	2270	4402	
1837	3698		2140	4319	2004	3867	2311	4487	
1898	3823		2201	4442	2066	3995	2370	4610	

If Mica Gables are specified, add 43.

If Mica Supports are specified, add 14.

modular desks

Xpress

R V X D

Extended P-Shaped Peninsula Desk – Half Gables

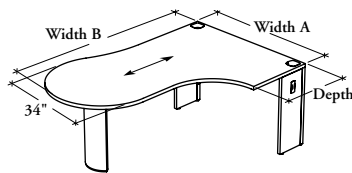

This fixed-height desk combines the large end of a Peninsula Desk with the curved corner of a D-Shaped Peninsula Desk.

WHAT'S INCLUDED

1 worksurface, 2 metal corner posts with levelers, 1 structural beam, 2 half gables with levelers, 1 support with leveler, 2 flush plates, wire management clips, grommets, and hardware.

WHAT'S EXCLUDED

Flush-Mounted Modesty Panel and Inset Modesty Panel.

NOTES

This desk is semi-supported and must be connected to another desk.

This product does **not** accept a keyboard shelf.

PRODUCT OPTIONS

Visitor Option	Gable Style	Support Style	Depth	Width A	Width B	Worksurface Configuration	Worksurface Finish	Edge Trim Style	Edge Trim Finish	Gable and Grommet Finish	Support Finish
F Flush	L Laminate M Metal	P Central Post Leg – 3 1/2" Round S Camber Base (Shown)	24, 30	48, 54	60, 66, 72, 78, 84	L Left (Shown) R Right	Foundation Laminate Flintwood	6 Straight Trim 9 Flintwood Flat Trim	Edge Trim Colors (for trim style 6)	Source Laminate Foundation (for metal gables) Mica (for metal gables)	Foundation Mica

SAMPLE ORDER CODE

RVXD F	M	S	24	48	72	L	2D	6	4D	N	N
---------------	----------	----------	-----------	-----------	-----------	----------	-----------	----------	-----------	----------	----------

DIMENSIONS INCHES / MM

D	Wa	Wb
24 / 610	48 / 1219	60 / 1524
24 / 610	48 / 1219	66 / 1676
24 / 610	48 / 1219	72 / 1829
24 / 610	48 / 1219	78 / 1981
24 / 610	48 / 1219	84 / 2134
24 / 610	54 / 1372	66 / 1676
24 / 610	54 / 1372	72 / 1829
24 / 610	54 / 1372	78 / 1981
24 / 610	54 / 1372	84 / 2134
30 / 762	48 / 1219	66 / 1676
30 / 762	48 / 1219	72 / 1829
30 / 762	48 / 1219	78 / 1981
30 / 762	48 / 1219	84 / 2134
30 / 762	54 / 1372	66 / 1676
30 / 762	54 / 1372	72 / 1829
30 / 762	54 / 1372	78 / 1981
30 / 762	54 / 1372	84 / 2134

PRICING

CENTRAL POST LEG – 3 1/2" ROUND (P)			
LAMINATE GABLES (L)		METAL GABLES (M)	
Foundation Laminate	Flintwood	Foundation Laminate	Flintwood
1696	2748	2001	3242
1788	2892	2091	3386
1858	3011	2167	3502
1904	3086	2210	3580
1957	3176	2264	3666
1797	2910	2102	3405
1878	3042	2181	3532
1928	3122	2233	3616
1971	3192	2275	3689
1801	2922	2109	3414
1880	3042	2182	3533
1933	3129	2235	3617
1979	3205	2283	3702
1882	3045	2184	3537
1946	3152	2253	3651
1994	3222	2298	3718
2059	3332	2364	3829

CAMBER BASE (S)			
LAMINATE GABLES (L)		METAL GABLES (M)	
Foundation Laminate	Flintwood	Foundation Laminate	Flintwood
1864	2917	2173	3409
1955	3061	2261	3557
2025	3181	2327	3675
2072	3257	2380	3748
2127	3344	2437	3837
1965	3082	2269	3574
2045	3209	2354	3702
2095	3290	2402	3784
2140	3363	2445	3859
1972	3089	2278	3582
2050	3209	2355	3703
2103	3293	2408	3789
2148	3376	2451	3871
2052	3214	2356	3706
2116	3322	2419	3819
2156	3395	2464	3888
2230	3502	2531	4001

If Mica Gables are specified, add 43.

If Mica Supports are specified, add 14.

modular desks

Xpress

RDPD

P-Shaped Peninsula Desk – Half Gables

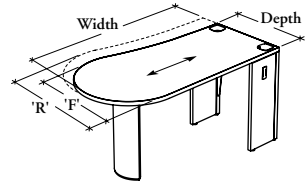

If 24" Depth:
'F' = 28"
'R' = 36"

If 30" Depth:
'F' = 34"
'R' = 42"

If 36" Depth:
'F' = 40"
'R' = 48"

This fixed-height desk has a circular end that is wider than the worksurface depth.

WHAT'S INCLUDED

1 worksurface, 2 metal corner posts with levelers, 1 structural beam, 2 half gables with levelers, 1 support with leveler, 2 flush plates, wire management clips, grommets, and hardware.

WHAT'S EXCLUDED

Flush-Mounted Modesty Panel and Inset Modesty Panel.

NOTES

This desk is semi-supported and must be connected to another desk.

When Recessed visitor option (R) is specified, an additional 8" kneespace clearance is provided.

PRODUCT OPTIONS

Visitor Option	Gable Style	Support Style	Depth	Width	Worksurface Configuration	Worksurface Finish	Edge Trim Style	Edge Trim Finish	Gable and Grommet Finish	Support Finish
F Flush R Recessed	L Laminate M Metal	P Central Post Leg – 3 1/2" Round S Camber Base (Shown)	24, 30, 36	48, 54, 60, 66, 72, 78, 84	L Left (Shown) R Right	Foundation Laminate Flintwood	6 Straight Trim 9 Flintwood Flat Trim	Edge Trim Colors (for trim style 6)	Source Laminate Foundation (for metal gables) Mica (for metal gables)	Foundation Mica

SAMPLE ORDER CODE

RDPD F	M	S	36	60	L	2D	6	4D	N	7
--------	---	---	----	----	---	----	---	----	---	---

DIMENSIONS INCHES / MM

PRICING

FLUSH VISITOR OPTION (F)

CENTRAL POST LEG – 3 1/2" ROUND (P)

LAMINATE GABLES (L)

FOUNDATION LAMINATE

FLINTWOOD

FOUNDATION LAMINATE

FLINTWOOD

FOUNDATION LAMINATE

FLINTWOOD

FOUNDATION LAMINATE

FLINTWOOD

FOUNDATION LAMINATE

FLINTWOOD

FOUNDATION LAMINATE

FLINTWOOD

FOUNDATION LAMINATE

FLINTWOOD

FOUNDATION LAMINATE

FLINTWOOD

FOUNDATION LAMINATE

FLINTWOOD

FOUNDATION LAMINATE

FLINTWOOD

FOUNDATION LAMINATE

FLINTWOOD

FOUNDATION LAMINATE

FLINTWOOD

FOUNDATION LAMINATE

FLINTWOOD

CAMBER BASE (S)

LAMINATE GABLES (L)

FOUNDATION LAMINATE

FLINTWOOD

FOUNDATION LAMINATE

FLINTWOOD

FOUNDATION LAMINATE

FLINTWOOD

FOUNDATION LAMINATE

FLINTWOOD

FOUNDATION LAMINATE

FLINTWOOD

FOUNDATION LAMINATE

FLINTWOOD

FOUNDATION LAMINATE

FLINTWOOD

FOUNDATION LAMINATE

FLINTWOOD

FOUNDATION LAMINATE

FLINTWOOD

FOUNDATION LAMINATE

FLINTWOOD

FOUNDATION LAMINATE

FLINTWOOD

FOUNDATION LAMINATE

FLINTWOOD

FOUNDATION LAMINATE

FLINTWOOD

METAL GABLES (M)

FOUNDATION LAMINATE

FLINTWOOD

FOUNDATION LAMINATE

FLINTWOOD

FOUNDATION LAMINATE

FLINTWOOD

FOUNDATION LAMINATE

FLINTWOOD

FOUNDATION LAMINATE

FLINTWOOD

FOUNDATION LAMINATE

FLINTWOOD

FOUNDATION LAMINATE

FLINTWOOD

FOUNDATION LAMINATE

FLINTWOOD

FOUNDATION LAMINATE

FLINTWOOD

FOUNDATION LAMINATE

FLINTWOOD

FOUNDATION LAMINATE

FLINTWOOD

FOUNDATION LAMINATE

FLINTWOOD

FOUNDATION LAMINATE

FLINTWOOD

If Mica Gables are specified, add 43.

If Mica Supports are specified, add 14.

Pricing is continued on the following page.

R D P D

P-Shaped Peninsula Desk – Half Gables (Continued)

DIMENSIONS

INCHES / MM

PRICING

DIMENSIONS		RECESSED VISITOR OPTION (R)							
		CENTRAL POST LEG – 3 1/2" ROUND (P)				CAMBER BASE (S)			
INCHES / MM		LAMINATE GABLES (L)		METAL GABLES (M)		LAMINATE GABLES (L)		METAL GABLES (M)	
		Foundation Laminate	Flintwood	Foundation Laminate	Flintwood	Foundation Laminate	Flintwood	Foundation Laminate	Flintwood
D	W								
24 / 610	48 / 1219	1376	2333	1680	3828	1544	2502	1851	3999
24 / 610	54 / 1372	1406	2380	1711	3889	1572	2550	1879	4060
24 / 610	60 / 1524	1429	2427	1735	3952	1600	2595	1904	4120
24 / 610	66 / 1676	1510	2561	1813	4132	1679	2729	1982	4300
24 / 610	72 / 1829	1594	2699	1898	4321	1760	2868	2066	4492
24 / 610	78 / 1981	1625	2760	1929	4399	1797	2926	2102	4567
24 / 610	84 / 2134	1672	2834	1975	4503	1840	3003	2147	4670
30 / 762	48 / 1219	1433	2438	1739	3963	1604	2603	1908	4132
30 / 762	54 / 1372	1478	2507	1782	4062	1651	2680	1951	4233
30 / 762	60 / 1524	1520	2584	1826	4159	1691	2753	1998	4330
30 / 762	66 / 1676	1592	2697	1897	4319	1759	2866	2064	4487
30 / 762	72 / 1829	1662	2819	1967	4479	1833	2989	2136	4650
30 / 762	78 / 1981	1711	2900	2013	4589	1879	3071	2181	4756
30 / 762	84 / 2134	1747	2963	2051	4677	1915	3134	2224	4844
36 / 914	48 / 1219	1496	2538	1801	4098	1663	2703	1971	4270
36 / 914	54 / 1372	1553	2638	1858	4235	1725	2812	2027	4405
36 / 914	60 / 1524	1609	2738	1919	4372	1782	2909	2086	4538
36 / 914	66 / 1676	1674	2834	1978	4503	1839	3003	2145	4668
36 / 914	72 / 1829	1732	2942	2033	4639	1902	3111	2205	4812
36 / 914	78 / 1981	1796	3043	2095	4780	1957	3214	2264	4952
36 / 914	84 / 2134	1821	3093	2124	4857	1989	3264	2299	5023

If Mica Gables are specified, add 43.

If Mica Supports are specified, add 14.

modular desks

Xpress

R T R T Rectangular Table

This fixed-height table can be used alone or gathered with other tables for team meetings.

WHAT'S INCLUDED

1 worksurface, 4 legs with levelers, and hardware.

NOTES

This table is freestanding but can be linked with another desk.

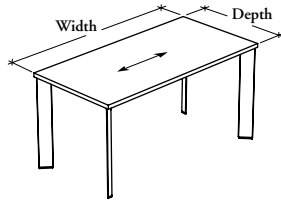

PRODUCT OPTIONS

Leg Style	Depth	Width	Worksurface Finish	Edge Trim Style	Edge Trim Finish	Leg Finish
A Angled Legs (Shown)	24, 30	36, 42, 48, 54, 60, 66, 72, 78, 84	Foundation Laminate Flintwood	6 Straight Trim	Edge Trim Colors (for trim style 6)	Foundation Mica
P 2" Post Legs – Adjustable				9 Flintwood Flat Trim		

SAMPLE ORDER CODE

RTRT A	30	60	2D	6	4D	G
---------------	-----------	-----------	-----------	----------	-----------	----------

DIMENSIONS INCHES / MM

D	W
24 / 610	36 / 914
24 / 610	42 / 1067
24 / 610	48 / 1219
24 / 610	54 / 1372
24 / 610	60 / 1524
24 / 610	66 / 1676
24 / 610	72 / 1829
24 / 610	78 / 1981
24 / 610	84 / 2134
30 / 762	36 / 914
30 / 762	42 / 1067
30 / 762	48 / 1219
30 / 762	54 / 1372
30 / 762	60 / 1524
30 / 762	66 / 1676
30 / 762	72 / 1829
30 / 762	78 / 1981
30 / 762	84 / 2134

PRICING

	Foundation Laminate	Flintwood
	1268	1682
	1329	1811
	1387	1944
	1453	2074
	1511	2202
	1569	2332
	1633	2464
	1691	2590
	1752	2719
	1360	1878
	1434	2042
	1511	2202
	1585	2362
	1662	2526
	1735	2687
	1808	2845
	1886	3009
	1964	3174

If Mica Legs are specified, add 70.

spine desks

spine desks product map

R M S R L Spine Desk – Single-Sided – Freestanding

Page 252

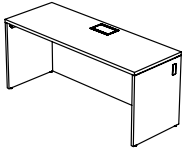

R M S S L Spine Desk – Single-Sided – Left-End Position

Page 256

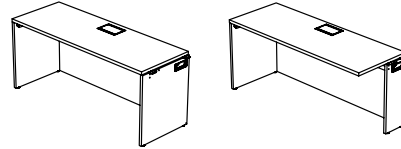

R M S D L Spine Desk – Single-Sided – In-Line Position

Page 262

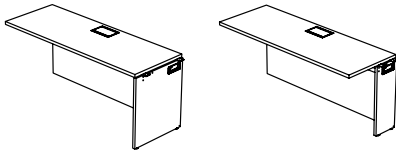

R M S E L Spine Desk – Single-Sided – Right-End Position

Page 268

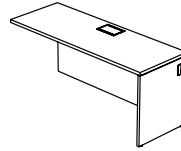

R M D R L Spine Desk – Shared – Freestanding

Page 272

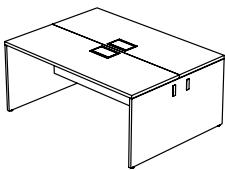

R M D S L Spine Desk – Shared – Left-End Position

Page 274

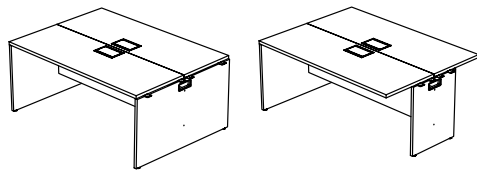

R M D D L Spine Desk – Shared – In-Line Position

Page 278

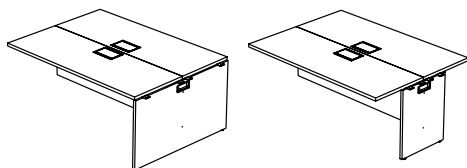

R M D E L Spine Desk – Shared – Right-End Position

Page 282

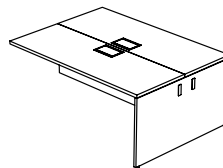

spine desks

Xpress

RMSRL

Spine Desk – Single-Sided – Freestanding

The freestanding module of Spine Desk – Single-Sided is specified alone or beside another Spine Desk in applications along corridor or wall.

WHAT'S INCLUDED

1 worksurface, 2 full end gables with levelers, 1 modesty panel (as specified), 1 cable tray with cantilever brackets, 1 communication box, hardware, grommets and/or access door (as specified).

WHAT'S EXCLUDED

Power Box and Harness.

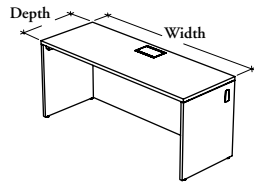

PRODUCT OPTIONS

Modesty Panel Height	Worksurface Grommet Style and Location	Depth	Width	Full End Gable Grommet Style	Worksurface Finish	Edge Trim Style	Full End Gable Finish	Worksurface Grommet/ Access Door Finish
F Full-Height (Shown)	Rectangular Grommet(s): B Both Ends C Centered Access Door: L Left M Middle (Shown) R Right	24, 30	30, 36, 42, 48, 54, 60, 66, 72, 78, 84	B Left and Right (Shown) L Left only N No Grommet R Right only	Foundation Laminate Flintwood	6 Straight Trim	Source Laminate Flintwood	Foundation Mica
W Wall-Access						9 Flintwood Flat Trim		
						Edge Trim Finish Edge Trim Colors (for trim style 6)	Modesty Panel Finish Source Laminate	

SAMPLE ORDER CODE

RMSRL	M	24	72	B	2D	6	4D	3D	3D	E
F										

DIMENSIONS
INCHES / MM

D	W
24 / 610	30 / 762
24 / 610	36 / 914
24 / 610	42 / 1067
24 / 610	48 / 1219
24 / 610	54 / 1372
24 / 610	60 / 1524
24 / 610	66 / 1676
24 / 610	72 / 1829
24 / 610	78 / 1981
24 / 610	84 / 2134
30 / 762	30 / 762
30 / 762	36 / 914
30 / 762	42 / 1067
30 / 762	48 / 1219
30 / 762	54 / 1372
30 / 762	60 / 1524
30 / 762	66 / 1676
30 / 762	72 / 1829
30 / 762	78 / 1981
30 / 762	84 / 2134

PRICING

WALL-ACCESS MODESTY PANEL (W)

RECTANGULAR GROMMET – BOTH ENDS (B)

FOUNDATION LAMINATE WORKSURFACE	FLINTWOOD WORKSURFACE
---------------------------------	-----------------------

FULL END GABLE FINISH

Source Laminate	Source Laminate	Flintwood
n/a	n/a	n/a
n/a	n/a	n/a
n/a	n/a	n/a
950	1564	2444
1017	1659	2540
1072	1757	2638
1126	1840	2721
1180	1921	2801
1237	2035	2917
1286	2118	2999
n/a	n/a	n/a
n/a	n/a	n/a
n/a	n/a	n/a
1078	1723	2698
1154	1826	2799
1213	1915	2891
1279	2039	3014
1339	2129	3104
1402	2252	3225
1462	2341	3314

RECTANGULAR GROMMET – CENTERED (C)

FOUNDATION LAMINATE WORKSURFACE	FLINTWOOD WORKSURFACE
---------------------------------	-----------------------

Source Laminate	Source Laminate	Flintwood
786	1260	2143
841	1368	2247
896	1452	2329
950	1564	2444
1017	1659	2540
1072	1757	2638
1126	1840	2721
1180	1921	2801
1237	2035	2917
1286	2118	2999
890	1406	2378
952	1496	2468
1014	1616	2589
1078	1723	2698
1154	1826	2799
1213	1915	2891
1279	2039	3014
1339	2129	3104
1402	2252	3225
1462	2341	3314

Pricing is continued on the following page.

RMSRL
Spine Desk – Single-Sided –
Freestanding (Continued)

DIMENSIONS
INCHES / MM

PRICING

		WALL-ACCESS MODESTY PANEL (W) (CONTINUED)							
		ACCESS DOOR – LEFT OR RIGHT (L OR R)			ACCESS DOOR – MIDDLE (M)				
		FOUNDATION LAMINATE WORKSURFACE		FLINTWOOD WORKSURFACE		FOUNDATION LAMINATE WORKSURFACE		FLINTWOOD WORKSURFACE	
FULL END GABLE FINISH									
D	W	Source Laminate	Source Laminate	Flintwood	Source Laminate	Source Laminate	Source Laminate	Source Laminate	Flintwood
24 / 610	30 / 762	n/a	n/a	n/a	906	1379	1379	1379	2259
24 / 610	36 / 914	n/a	n/a	n/a	958	1484	1484	1484	2366
24 / 610	42 / 1067	n/a	n/a	n/a	1013	1566	1566	1566	2446
24 / 610	48 / 1219	1068	1681	2561	1068	1681	1681	1681	2561
24 / 610	54 / 1372	1133	1776	2658	1133	1776	1776	1776	2658
24 / 610	60 / 1524	1190	1873	2753	1190	1873	1873	1873	2753
24 / 610	66 / 1676	1244	1956	2839	1244	1956	1956	1956	2839
24 / 610	72 / 1829	1296	2036	2919	1296	2036	2036	2036	2919
24 / 610	78 / 1981	1351	2152	3031	1351	2152	2152	2152	3031
24 / 610	84 / 2134	1404	2234	3113	1404	2234	2234	2234	3113
30 / 762	30 / 762	n/a	n/a	n/a	1006	1522	1522	1522	2495
30 / 762	36 / 914	n/a	n/a	n/a	1070	1612	1612	1612	2587
30 / 762	42 / 1067	n/a	n/a	n/a	1130	1734	1734	1734	2709
30 / 762	48 / 1219	1195	1839	2814	1195	1839	1839	1839	2814
30 / 762	54 / 1372	1267	1943	2917	1267	1943	1943	1943	2917
30 / 762	60 / 1524	1329	2033	3009	1329	2033	2033	2033	3009
30 / 762	66 / 1676	1394	2156	3132	1394	2156	2156	2156	3132
30 / 762	72 / 1829	1456	2246	3219	1456	2246	2246	2246	3219
30 / 762	78 / 1981	1517	2369	3341	1517	2369	2369	2369	3341
30 / 762	84 / 2134	1579	2457	3430	1579	2457	2457	2457	3430

		FULL-HEIGHT MODESTY PANEL (F)							
		RECTANGULAR GROMMET – BOTH ENDS (B)			RECTANGULAR GROMMET – CENTERED (C)				
		FOUNDATION LAMINATE WORKSURFACE		FLINTWOOD WORKSURFACE		FOUNDATION LAMINATE WORKSURFACE		FLINTWOOD WORKSURFACE	
FULL END GABLE FINISH									
D	W	Source Laminate	Source Laminate	Flintwood	Source Laminate	Source Laminate	Source Laminate	Source Laminate	Flintwood
24 / 610	30 / 762	n/a	n/a	n/a	889	1364	1364	1364	2243
24 / 610	36 / 914	n/a	n/a	n/a	962	1487	1487	1487	2369
24 / 610	42 / 1067	n/a	n/a	n/a	1036	1587	1587	1587	2467
24 / 610	48 / 1219	1110	1721	2603	1110	1721	1721	1721	2603
24 / 610	54 / 1372	1195	1835	2717	1195	1835	1835	1835	2717
24 / 610	60 / 1524	1264	1952	2834	1264	1952	1952	1952	2834
24 / 610	66 / 1676	1342	2057	2938	1342	2057	2057	2057	2938
24 / 610	72 / 1829	1416	2156	3039	1416	2156	2156	2156	3039
24 / 610	78 / 1981	1492	2293	3174	1492	2293	2293	2293	3174
24 / 610	84 / 2134	1564	2398	3274	1564	2398	2398	2398	3274
30 / 762	30 / 762	n/a	n/a	n/a	992	1506	1506	1506	2482
30 / 762	36 / 914	n/a	n/a	n/a	1072	1614	1614	1614	2588
30 / 762	42 / 1067	n/a	n/a	n/a	1155	1755	1755	1755	2728
30 / 762	48 / 1219	1237	1882	2854	1237	1882	1882	1882	2854
30 / 762	54 / 1372	1328	2002	2977	1328	2002	2002	2002	2977
30 / 762	60 / 1524	1411	2114	3087	1411	2114	2114	2114	3087
30 / 762	66 / 1676	1492	2255	3231	1492	2255	2255	2255	3231
30 / 762	72 / 1829	1576	2369	3341	1576	2369	2369	2369	3341
30 / 762	78 / 1981	1659	2507	3485	1659	2507	2507	2507	3485
30 / 762	84 / 2134	1739	2618	3591	1739	2618	2618	2618	3591

Pricing is continued on the following page.

spine desks

Xpress

RMSRL

Spine Desk – Single-Sided – Freestanding (Continued)

DIMENSIONS
INCHES / MM

PRICING

		FULL-HEIGHT MODESTY PANEL (F) (CONTINUED)					
		ACCESS DOOR – LEFT OR RIGHT (L OR R)			ACCESS DOOR – MIDDLE (M)		
		FOUNDATION LAMINATE WORKSURFACE	FLINTWOOD WORKSURFACE		FOUNDATION LAMINATE WORKSURFACE	FLINTWOOD WORKSURFACE	
		FULL END GABLE FINISH					
D	W	Source Laminate	Source Laminate	Flintwood	Source Laminate	Source Laminate	Flintwood
24 / 610	30 / 762	n/a	n/a	n/a	1005	1480	2359
24 / 610	36 / 914	n/a	n/a	n/a	1079	1603	2485
24 / 610	42 / 1067	n/a	n/a	n/a	1154	1706	2586
24 / 610	48 / 1219	1223	1837	2719	1223	1837	2719
24 / 610	54 / 1372	1310	1952	2834	1310	1952	2834
24 / 610	60 / 1524	1383	2068	2949	1383	2068	2949
24 / 610	66 / 1676	1459	2173	3053	1459	2173	3053
24 / 610	72 / 1829	1535	2275	3155	1535	2275	3155
24 / 610	78 / 1981	1608	2409	3290	1608	2409	3290
24 / 610	84 / 2134	1681	2508	3390	1681	2508	3390
30 / 762	30 / 762	n/a	n/a	n/a	1109	1623	2596
30 / 762	36 / 914	n/a	n/a	n/a	1190	1732	2705
30 / 762	42 / 1067	n/a	n/a	n/a	1268	1873	2845
30 / 762	48 / 1219	1351	1998	2970	1351	1998	2970
30 / 762	54 / 1372	1444	2119	3093	1444	2119	3093
30 / 762	60 / 1524	1527	2230	3203	1527	2230	3203
30 / 762	66 / 1676	1609	2373	3347	1609	2373	3347
30 / 762	72 / 1829	1692	2485	3457	1692	2485	3457
30 / 762	78 / 1981	1776	2624	3599	1776	2624	3599
30 / 762	84 / 2134	1857	2734	3709	1857	2734	3709

spine desks

Xpress

RMSSL

Spine Desk – Single-Sided – Left-End Position

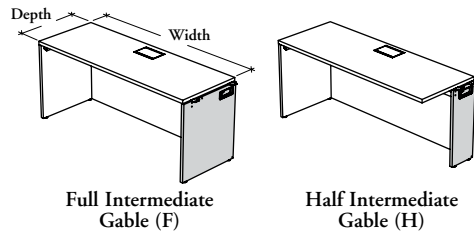

The left-end module of Spine Desk – Single-Sided is specified next to an in-line or right-end module in applications along corridor or wall.

WHAT'S INCLUDED

1 worksurface, 1 full left-end gable with levelers, 1 full or half intermediate gable with levelers (as specified), 1 modesty panel (as specified), 1 cable tray with cantilever brackets, 1 communication box, hardware, grommets and/or access door (as specified).

WHAT'S EXCLUDED

Power Box and Harness.

NOTES

This desk is semi-supported and must be connected to another desk.

PRODUCT OPTIONS

Intermediate Gable Config.	Modesty Panel Height	Worksurface Grommet Style and Location	Depth	Width	Full End Gable Grommet Style	Worksurface Finish	Edge Trim Style	Full End Gable Finish	Worksurface Grommet/ Access Door Finish
F Full H Half	F Full-Height (Shown) W Wall-Access	Rectangular Grommet(s): B Both Ends C Centered Access Door: L Left M Middle (Shown) R Right	24, 30	30, 36, 42, 48, 54, 60, 66, 72, 78, 84	G With Grommet (Shown) N No Grommet	Foundation Laminate Flintwood	6 Straight Trim 9 Flintwood Flat Trim Edge Trim Finish Edge Trim Colors (for trim style 6)	Source Laminate Flintwood Modesty Panel and Intermediate Gable Finish Source Laminate	Foundation Mica

SAMPLE ORDER CODE

RMSSL F	W	B	30	84	G	2D	6	4D	3D	3D	7
------------	---	---	----	----	---	----	---	----	----	----	---

DIMENSIONS INCHES / MM

		HALF INTERMEDIATE GABLE (H)							
		WALL-ACCESS MODESTY PANEL (W)			RECTANGULAR GROMMET – CENTERED (C)				
		RECTANGULAR GROMMET – BOTH ENDS (B)			RECTANGULAR GROMMET – CENTERED (C)				
		FOUNDATION LAMINATE WORKSURFACE		FLINTWOOD WORKSURFACE		FOUNDATION LAMINATE WORKSURFACE		FLINTWOOD WORKSURFACE	
		FULL END GABLE FINISH							
D	W	Source Laminate	Source Laminate	Flintwood	Source Laminate	Source Laminate	Flintwood	Source Laminate	Flintwood
24 / 610	30 / 762	n/a	n/a	n/a	749	1223	1663		
24 / 610	36 / 914	n/a	n/a	n/a	805	1329	1771		
24 / 610	42 / 1067	n/a	n/a	n/a	860	1412	1851		
24 / 610	48 / 1219	912	1527	1967	912	1527	1967		
24 / 610	54 / 1372	973	1614	2056	973	1614	2056		
24 / 610	60 / 1524	1029	1713	2153	1029	1713	2153		
24 / 610	66 / 1676	1083	1798	2239	1083	1798	2239		
24 / 610	72 / 1829	1136	1879	2319	1136	1879	2319		
24 / 610	78 / 1981	1192	1994	2430	1192	1994	2430		
24 / 610	84 / 2134	1242	2073	2513	1242	2073	2513		
30 / 762	30 / 762	n/a	n/a	n/a	849	1366	1854		
30 / 762	36 / 914	n/a	n/a	n/a	912	1457	1944		
30 / 762	42 / 1067	n/a	n/a	n/a	974	1578	2064		
30 / 762	48 / 1219	1038	1682	2170	1038	1682	2170		
30 / 762	54 / 1372	1109	1779	2267	1109	1779	2267		
30 / 762	60 / 1524	1168	1873	2359	1168	1873	2359		
30 / 762	66 / 1676	1235	1996	2484	1235	1996	2484		
30 / 762	72 / 1829	1293	2085	2574	1293	2085	2574		
30 / 762	78 / 1981	1358	2205	2695	1358	2205	2695		
30 / 762	84 / 2134	1416	2294	2783	1416	2294	2783		

R M S S L

Spine Desk – Single-Sided – Left-End Position (Continued)

**DIMENSIONS
INCHES / MM**

PRICING

HALF INTERMEDIATE GABLE (H) (CONTINUED)

WALL-ACCESS MODESTY PANEL (W)

ACCESS DOOR – LEFT OR RIGHT (L OR R) ACCESS DOOR – MIDDLE (M)

FOUNDATION LAMINATE WORKSURFACE FLINTWOOD WORKSURFACE FOUNDATION LAMINATE WORKSURFACE FLINTWOOD WORKSURFACE

FULL END GABLE FINISH

D	W	Source Laminate	Source Laminate	Flintwood	Source Laminate	Source Laminate	Flintwood
24 / 610	30 / 762	n/a	n/a	n/a	868	1341	1781
24 / 610	36 / 914	n/a	n/a	n/a	921	1448	1886
24 / 610	42 / 1067	n/a	n/a	n/a	974	1529	1970
24 / 610	48 / 1219	1031	1641	2082	1031	1641	2082
24 / 610	54 / 1372	1089	1732	2173	1089	1732	2173
24 / 610	60 / 1524	1144	1830	2270	1144	1830	2270
24 / 610	66 / 1676	1201	1913	2355	1201	1913	2355
24 / 610	72 / 1829	1253	1996	2437	1253	1996	2437
24 / 610	78 / 1981	1306	2109	2547	1306	2109	2547
24 / 610	84 / 2134	1360	2189	2629	1360	2189	2629
30 / 762	30 / 762	n/a	n/a	n/a	965	1482	1970
30 / 762	36 / 914	n/a	n/a	n/a	1031	1575	2061
30 / 762	42 / 1067	n/a	n/a	n/a	1090	1695	2181
30 / 762	48 / 1219	1155	1800	2289	1155	1800	2289
30 / 762	54 / 1372	1221	1898	2383	1221	1898	2383
30 / 762	60 / 1524	1286	1987	2474	1286	1987	2474
30 / 762	66 / 1676	1349	2114	2600	1349	2114	2600
30 / 762	72 / 1829	1412	2202	2689	1412	2202	2689
30 / 762	78 / 1981	1473	2322	2808	1473	2322	2808
30 / 762	84 / 2134	1535	2413	2899	1535	2413	2899

FULL-HEIGHT MODESTY PANEL (F)

RECTANGULAR GROMMET – BOTH ENDS (B) RECTANGULAR GROMMET – CENTERED (C)

FOUNDATION LAMINATE WORKSURFACE FLINTWOOD WORKSURFACE FOUNDATION LAMINATE WORKSURFACE FLINTWOOD WORKSURFACE

FULL END GABLE FINISH

D	W	Source Laminate	Source Laminate	Flintwood	Source Laminate	Source Laminate	Flintwood
24 / 610	30 / 762	n/a	n/a	n/a	849	1326	1766
24 / 610	36 / 914	n/a	n/a	n/a	922	1451	1888
24 / 610	42 / 1067	n/a	n/a	n/a	996	1550	1989
24 / 610	48 / 1219	1071	1682	2123	1071	1682	2123
24 / 610	54 / 1372	1152	1792	2233	1152	1792	2233
24 / 610	60 / 1524	1221	1908	2349	1221	1908	2349
24 / 610	66 / 1676	1299	2011	2453	1299	2011	2453
24 / 610	72 / 1829	1373	2117	2554	1373	2117	2554
24 / 610	78 / 1981	1451	2250	2690	1451	2250	2690
24 / 610	84 / 2134	1520	2350	2790	1520	2350	2790
30 / 762	30 / 762	n/a	n/a	n/a	950	1464	1952
30 / 762	36 / 914	n/a	n/a	n/a	1032	1576	2062
30 / 762	42 / 1067	n/a	n/a	n/a	1114	1716	2203
30 / 762	48 / 1219	1195	1840	2327	1195	1840	2327
30 / 762	54 / 1372	1284	1956	2444	1284	1956	2444
30 / 762	60 / 1524	1365	2067	2552	1365	2067	2552
30 / 762	66 / 1676	1451	2210	2699	1451	2210	2699
30 / 762	72 / 1829	1534	2322	2808	1534	2322	2808
30 / 762	78 / 1981	1614	2464	2950	1614	2464	2950
30 / 762	84 / 2134	1696	2575	3061	1696	2575	3061

Pricing is continued on the following page.

spine desks

Xpress

R M S S L

Spine Desk – Single-Sided – Left-End Position (Continued)

DIMENSIONS
INCHES / MM

		HALF INTERMEDIATE GABLE (H) (CONTINUED)					
		FULL-HEIGHT MODESTY PANEL (F)					
		ACCESS DOOR – LEFT OR RIGHT (L OR R)			ACCESS DOOR – MIDDLE (M)		
		FOUNDATION LAMINATE WORKSURFACE	FLINTWOOD WORKSURFACE		FOUNDATION LAMINATE WORKSURFACE	FLINTWOOD WORKSURFACE	
		FULL END GABLE FINISH					
D	W	Source Laminate	Source Laminate	Flintwood	Source Laminate	Source Laminate	Flintwood
24 / 610	30 / 762	n/a	n/a	n/a	965	1441	1883
24 / 610	36 / 914	n/a	n/a	n/a	1041	1565	2006
24 / 610	42 / 1067	n/a	n/a	n/a	1114	1666	2109
24 / 610	48 / 1219	1188	1800	2241	1188	1800	2241
24 / 610	54 / 1372	1264	1908	2349	1264	1908	2349
24 / 610	60 / 1524	1340	2025	2465	1340	2025	2465
24 / 610	66 / 1676	1415	2129	2572	1415	2129	2572
24 / 610	72 / 1829	1491	2233	2670	1491	2233	2670
24 / 610	78 / 1981	1565	2368	2805	1565	2368	2805
24 / 610	84 / 2134	1637	2467	2909	1637	2467	2909
30 / 762	30 / 762	n/a	n/a	n/a	1068	1583	2069
30 / 762	36 / 914	n/a	n/a	n/a	1151	1692	2180
30 / 762	42 / 1067	n/a	n/a	n/a	1232	1833	2320
30 / 762	48 / 1219	1312	1956	2444	1312	1956	2444
30 / 762	54 / 1372	1400	2074	2561	1400	2074	2561
30 / 762	60 / 1524	1481	2184	2670	1481	2184	2670
30 / 762	66 / 1676	1565	2327	2815	1565	2327	2815
30 / 762	72 / 1829	1650	2441	2926	1650	2441	2926
30 / 762	78 / 1981	1731	2580	3067	1731	2580	3067
30 / 762	84 / 2134	1812	2690	3176	1812	2690	3176

		FULL INTERMEDIATE GABLE (F)					
		WALL-ACCESS MODESTY PANEL (W)					
		RECTANGULAR GROMMET – BOTH ENDS (B)			RECTANGULAR GROMMET – CENTERED (C)		
		FOUNDATION LAMINATE WORKSURFACE	FLINTWOOD WORKSURFACE		FOUNDATION LAMINATE WORKSURFACE	FLINTWOOD WORKSURFACE	
		FULL END GABLE FINISH					
D	W	Source Laminate	Source Laminate	Flintwood	Source Laminate	Source Laminate	Flintwood
24 / 610	30 / 762	n/a	n/a	n/a	810	1285	1724
24 / 610	36 / 914	n/a	n/a	n/a	864	1387	1828
24 / 610	42 / 1067	n/a	n/a	n/a	919	1472	1912
24 / 610	48 / 1219	971	1586	2027	971	1586	2027
24 / 610	54 / 1372	1034	1676	2117	1034	1676	2117
24 / 610	60 / 1524	1086	1774	2211	1086	1774	2211
24 / 610	66 / 1676	1141	1857	2297	1141	1857	2297
24 / 610	72 / 1829	1196	1938	2377	1196	1938	2377
24 / 610	78 / 1981	1250	2052	2492	1250	2052	2492
24 / 610	84 / 2134	1302	2130	2574	1302	2130	2574
30 / 762	30 / 762	n/a	n/a	n/a	911	1426	1913
30 / 762	36 / 914	n/a	n/a	n/a	973	1517	2006
30 / 762	42 / 1067	n/a	n/a	n/a	1037	1638	2125
30 / 762	48 / 1219	1099	1743	2233	1099	1743	2233
30 / 762	54 / 1372	1167	1842	2328	1167	1842	2328
30 / 762	60 / 1524	1232	1933	2419	1232	1933	2419
30 / 762	66 / 1676	1293	2057	2544	1293	2057	2544
30 / 762	72 / 1829	1356	2146	2631	1356	2146	2631
30 / 762	78 / 1981	1416	2265	2753	1416	2265	2753
30 / 762	84 / 2134	1480	2357	2843	1480	2357	2843

Pricing is continued on the following page.

R M S S L

Spine Desk – Single-Sided – Left-End Position (Continued)

**DIMENSIONS
INCHES / MM**

PRICING

FULL INTERMEDIATE GABLE (F) (CONTINUED)							
WALL-ACCESS MODESTY PANEL (W)							
ACCESS DOOR – LEFT OR RIGHT (L OR R)			ACCESS DOOR – MIDDLE (M)				
FOUNDATION LAMINATE WORKSURFACE		FLINTWOOD WORKSURFACE		FOUNDATION LAMINATE WORKSURFACE		FLINTWOOD WORKSURFACE	
FULL END GABLE FINISH							
D	W	Source Laminate	Source Laminate	Flintwood	Source Laminate	Source Laminate	Flintwood
24 / 610	30 / 762	n/a	n/a	n/a	925	1402	1840
24 / 610	36 / 914	n/a	n/a	n/a	981	1506	1946
24 / 610	42 / 1067	n/a	n/a	n/a	1036	1587	2028
24 / 610	48 / 1219	1087	1703	2143	1087	1703	2143
24 / 610	54 / 1372	1152	1792	2233	1152	1792	2233
24 / 610	60 / 1524	1205	1888	2328	1205	1888	2328
24 / 610	66 / 1676	1259	1973	2414	1259	1973	2414
24 / 610	72 / 1829	1313	2054	2494	1313	2054	2494
24 / 610	78 / 1981	1368	2169	2610	1368	2169	2610
24 / 610	84 / 2134	1419	2250	2690	1419	2250	2690
30 / 762	30 / 762	n/a	n/a	n/a	1029	1543	2031
30 / 762	36 / 914	n/a	n/a	n/a	1089	1634	2122
30 / 762	42 / 1067	n/a	n/a	n/a	1155	1755	2242
30 / 762	48 / 1219	1215	1859	2347	1215	1859	2347
30 / 762	54 / 1372	1285	1957	2445	1285	1957	2445
30 / 762	60 / 1524	1344	2051	2537	1344	2051	2537
30 / 762	66 / 1676	1412	2173	2661	1412	2173	2661
30 / 762	72 / 1829	1472	2263	2749	1472	2263	2749
30 / 762	78 / 1981	1535	2381	2871	1535	2381	2871
30 / 762	84 / 2134	1596	2471	2960	1596	2471	2960

FULL-HEIGHT MODESTY PANEL (F)							
RECTANGULAR GROMMET – BOTH ENDS (B)			RECTANGULAR GROMMET – CENTERED (C)				
FOUNDATION LAMINATE WORKSURFACE		FLINTWOOD WORKSURFACE		FOUNDATION LAMINATE WORKSURFACE		FLINTWOOD WORKSURFACE	
FULL END GABLE FINISH							
D	W	Source Laminate	Source Laminate	Flintwood	Source Laminate	Source Laminate	Flintwood
24 / 610	30 / 762	n/a	n/a	n/a	909	1383	1825
24 / 610	36 / 914	n/a	n/a	n/a	984	1507	1948
24 / 610	42 / 1067	n/a	n/a	n/a	1057	1609	2052
24 / 610	48 / 1219	1129	1741	2182	1129	1741	2182
24 / 610	54 / 1372	1209	1851	2292	1209	1851	2292
24 / 610	60 / 1524	1284	1969	2408	1284	1969	2408
24 / 610	66 / 1676	1360	2073	2513	1360	2073	2513
24 / 610	72 / 1829	1433	2174	2615	1433	2174	2615
24 / 610	78 / 1981	1507	2308	2748	1507	2308	2748
24 / 610	84 / 2134	1580	2412	2849	1580	2412	2849
30 / 762	30 / 762	n/a	n/a	n/a	1010	1528	2013
30 / 762	36 / 914	n/a	n/a	n/a	1092	1637	2124
30 / 762	42 / 1067	n/a	n/a	n/a	1173	1777	2264
30 / 762	48 / 1219	1255	1900	2386	1255	1900	2386
30 / 762	54 / 1372	1342	2021	2503	1342	2021	2503
30 / 762	60 / 1524	1424	2127	2616	1424	2127	2616
30 / 762	66 / 1676	1510	2272	2760	1510	2272	2760
30 / 762	72 / 1829	1593	2381	2871	1593	2381	2871
30 / 762	78 / 1981	1676	2525	3011	1676	2525	3011
30 / 762	84 / 2134	1757	2633	3122	1757	2633	3122

Pricing is continued on the following page.

spine desks

Xpress

R M S S L

Spine Desk – Single-Sided – Left-End Position (Continued)

DIMENSIONS
INCHES / MM

		FULL INTERMEDIATE GABLE (F) (CONTINUED)					
		FULL-HEIGHT MODESTY PANEL (F)					
		ACCESS DOOR – LEFT OR RIGHT (L OR R)			ACCESS DOOR – MIDDLE (M)		
		FOUNDATION LAMINATE WORKSURFACE	FLINTWOOD WORKSURFACE		FOUNDATION LAMINATE WORKSURFACE	FLINTWOOD WORKSURFACE	
		FULL END GABLE FINISH					
D	W	Source Laminate	Source Laminate	Flintwood	Source Laminate	Source Laminate	Flintwood
24 / 610	30 / 762	n/a	n/a	n/a	1028	1501	1943
24 / 610	36 / 914	n/a	n/a	n/a	1099	1625	2066
24 / 610	42 / 1067	n/a	n/a	n/a	1172	1725	2168
24 / 610	48 / 1219	1247	1858	2298	1247	1858	2298
24 / 610	54 / 1372	1327	1969	2408	1327	1969	2408
24 / 610	60 / 1524	1400	2085	2526	1400	2085	2526
24 / 610	66 / 1676	1477	2189	2629	1477	2189	2629
24 / 610	72 / 1829	1550	2292	2731	1550	2292	2731
24 / 610	78 / 1981	1625	2426	2866	1625	2426	2866
24 / 610	84 / 2134	1696	2528	2967	1696	2528	2967
30 / 762	30 / 762	n/a	n/a	n/a	1128	1643	2129
30 / 762	36 / 914	n/a	n/a	n/a	1209	1754	2241
30 / 762	42 / 1067	n/a	n/a	n/a	1290	1894	2379
30 / 762	48 / 1219	1371	2021	2503	1371	2021	2503
30 / 762	54 / 1372	1460	2136	2622	1460	2136	2622
30 / 762	60 / 1524	1542	2245	2731	1542	2245	2731
30 / 762	66 / 1676	1627	2386	2876	1627	2386	2876
30 / 762	72 / 1829	1711	2499	2986	1711	2499	2986
30 / 762	78 / 1981	1792	2641	3130	1792	2641	3130
30 / 762	84 / 2134	1873	2752	3240	1873	2752	3240

spine desks

Xpress

RMSDL

Spine Desk – Single-Sided – In-Line Position

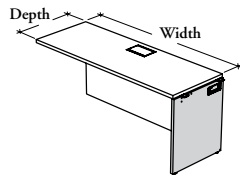

Full Intermediate Gable (F)

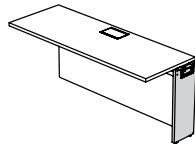

Half Intermediate Gable (H)

The in-line module of Spine Desk – Single-Sided is specified between a left-end and a right-end modules in applications along corridor or wall. Multiple in-line modules can be added to create a longer Spine Desk.

WHAT'S INCLUDED

1 worksurface, 1 full or half intermediate gable with levelers (as specified), 1 modesty panel (as specified), 1 cable tray with cantilever brackets, 1 communication box, hardware, grommets and/or access door (as specified).

WHAT'S EXCLUDED

Power Box and Harness.

NOTES

Foundation and Mica worksurface grommet finishes are available with worksurface grommet style and location (L), (M) or (R) only.

This desk is semi-supported and must be connected to other desks on both sides.

PRODUCT OPTIONS

Intermediate Gable Config.	Modesty Panel Height	Worksurface Grommet Style and Location	Depth	Width	Worksurface Finish	Edge Trim Style	Edge Trim Finish	Modesty Panel and Intermediate Gable Finish	Worksurface Grommet/ Access Door Finish
F Full	F Full-Height (Shown)	Rectangular Grommet(s): B Both Ends C Centered	24, 30	30, 36, 42, 48, 54, 60, 66, 72, 78, 84	Foundation Laminate Flintwood	6 Straight Trim 9 Flintwood Flat Trim	Edge Trim Colors (for trim style 6)	Source Laminate	Foundation Mica
H Half	W Wall-Access	Access Door: L Left M Middle (Shown) R Right							

SAMPLE ORDER CODE

RMSDL H	F	C	24	36	2E	6	4E	3E	Q
------------	---	---	----	----	----	---	----	----	---

DIMENSIONS INCHES / MM

D	W
24 / 610	30 / 762
24 / 610	36 / 914
24 / 610	42 / 1067
24 / 610	48 / 1219
24 / 610	54 / 1372
24 / 610	60 / 1524
24 / 610	66 / 1676
24 / 610	72 / 1829
24 / 610	78 / 1981
24 / 610	84 / 2134
30 / 762	30 / 762
30 / 762	36 / 914
30 / 762	42 / 1067
30 / 762	48 / 1219
30 / 762	54 / 1372
30 / 762	60 / 1524
30 / 762	66 / 1676
30 / 762	72 / 1829
30 / 762	78 / 1981
30 / 762	84 / 2134

PRICING

HALF INTERMEDIATE GABLE (H)

WALL-ACCESS MODESTY PANEL (W)

RECTANGULAR GROMMET – BOTH ENDS (B)

Foundation Laminate	Flintwood
n/a	n/a
n/a	n/a
n/a	n/a
752	1366
813	1455
868	1551
922	1636
974	1716
1031	1830
1081	1912
n/a	n/a
n/a	n/a
n/a	n/a
848	1493
918	1592
980	1682
1043	1805
1105	1895
1167	2015
1226	2105

RECTANGULAR GROMMET – CENTERED (C)

Foundation Laminate	Flintwood
590	1065
643	1168
697	1252
752	1366
813	1455
868	1551
922	1636
974	1716
1031	1830
1081	1912
661	1177
723	1267
786	1387
848	1493
918	1592
980	1682
1043	1805
1105	1895
1167	2015
1226	2105

Pricing is continued on the following page.

RMSDL
Spine Desk – Single-Sided –
In-Line Position (Continued)

DIMENSIONS
INCHES / MM

D	W
24 / 610	30 / 762
24 / 610	36 / 914
24 / 610	42 / 1067
24 / 610	48 / 1219
24 / 610	54 / 1372
24 / 610	60 / 1524
24 / 610	66 / 1676
24 / 610	72 / 1829
24 / 610	78 / 1981
24 / 610	84 / 2134
30 / 762	30 / 762
30 / 762	36 / 914
30 / 762	42 / 1067
30 / 762	48 / 1219
30 / 762	54 / 1372
30 / 762	60 / 1524
30 / 762	66 / 1676
30 / 762	72 / 1829
30 / 762	78 / 1981
30 / 762	84 / 2134
30 / 762	30 / 762
30 / 762	36 / 914
30 / 762	42 / 1067
30 / 762	48 / 1219
30 / 762	54 / 1372
30 / 762	60 / 1524
30 / 762	66 / 1676
30 / 762	72 / 1829
30 / 762	78 / 1981
30 / 762	84 / 2134

PRICING

HALF INTERMEDIATE GABLE (H) (CONTINUED)			
WALL-ACCESS MODESTY PANEL (W)			
ACCESS DOOR – LEFT OR RIGHT (L OR R)		ACCESS DOOR – MIDDLE (M)	
Foundation Laminate	Flintwood	Foundation Laminate	Flintwood
n/a	n/a	706	1180
n/a	n/a	761	1286
n/a	n/a	814	1369
869	1482	869	1482
929	1572	929	1572
984	1670	984	1670
1039	1753	1039	1753
1090	1833	1090	1833
1147	1946	1147	1946
1197	2028	1197	2028
n/a	n/a	777	1293
n/a	n/a	841	1383
n/a	n/a	904	1506
964	1611	964	1611
1034	1709	1034	1709
1095	1799	1095	1799
1161	1923	1161	1923
1220	2010	1220	2010
1284	2130	1284	2130
1342	2224	1342	2224
FULL-HEIGHT MODESTY PANEL (F)			
RECTANGULAR GROMMET – BOTH ENDS (B)		RECTANGULAR GROMMET – CENTERED (C)	
Foundation Laminate	Flintwood	Foundation Laminate	Flintwood
n/a	n/a	691	1166
n/a	n/a	763	1289
n/a	n/a	836	1391
909	1523	909	1523
991	1631	991	1631
1063	1748	1063	1748
1137	1851	1137	1851
1211	1953	1211	1953
1288	2087	1288	2087
1360	2189	1360	2189
n/a	n/a	762	1279
n/a	n/a	842	1385
n/a	n/a	923	1528
1006	1653	1006	1653
1092	1767	1092	1767
1173	1879	1173	1879
1257	2023	1257	2023
1341	2130	1341	2130
1424	2274	1424	2274
1506	2381	1506	2381

Pricing is continued on the following page.

spine desks

Xpress

R M S D L

Spine Desk – Single-Sided – In-Line Position (Continued)

DIMENSIONS
INCHES / MM

PRICING

		HALF INTERMEDIATE GABLE (H) (CONTINUED)			
		FULL-HEIGHT MODESTY PANEL (F)			
		ACCESS DOOR – LEFT OR RIGHT (L OR R)		ACCESS DOOR – MIDDLE (M)	
D	W	Foundation Laminate	Flintwood	Foundation Laminate	Flintwood
24 / 610	30 / 762	n/a	n/a	807	1283
24 / 610	36 / 914	n/a	n/a	880	1406
24 / 610	42 / 1067	n/a	n/a	954	1506
24 / 610	48 / 1219	1028	1639	1028	1639
24 / 610	54 / 1372	1108	1748	1108	1748
24 / 610	60 / 1524	1179	1862	1179	1862
24 / 610	66 / 1676	1254	1969	1254	1969
24 / 610	72 / 1829	1329	2069	1329	2069
24 / 610	78 / 1981	1405	2204	1405	2204
24 / 610	84 / 2134	1477	2306	1477	2306
30 / 762	30 / 762	n/a	n/a	879	1394
30 / 762	36 / 914	n/a	n/a	960	1505
30 / 762	42 / 1067	n/a	n/a	1042	1643
30 / 762	48 / 1219	1123	1769	1123	1769
30 / 762	54 / 1372	1209	1885	1209	1885
30 / 762	60 / 1524	1290	1996	1290	1996
30 / 762	66 / 1676	1375	2138	1375	2138
30 / 762	72 / 1829	1458	2250	1458	2250
30 / 762	78 / 1981	1540	2387	1540	2387
30 / 762	84 / 2134	1623	2499	1623	2499

		FULL INTERMEDIATE GABLE (F)			
		WALL-ACCESS MODESTY PANEL (W)			
		RECTANGULAR GROMMET – BOTH ENDS (B)		RECTANGULAR GROMMET – CENTERED (C)	
D	W	Foundation Laminate	Flintwood	Foundation Laminate	Flintwood
24 / 610	30 / 762	n/a	n/a	650	1124
24 / 610	36 / 914	n/a	n/a	704	1231
24 / 610	42 / 1067	n/a	n/a	760	1312
24 / 610	48 / 1219	813	1424	813	1424
24 / 610	54 / 1372	871	1514	871	1514
24 / 610	60 / 1524	925	1611	925	1611
24 / 610	66 / 1676	983	1696	983	1696
24 / 610	72 / 1829	1036	1776	1036	1776
24 / 610	78 / 1981	1087	1888	1087	1888
24 / 610	84 / 2134	1138	1971	1138	1971
30 / 762	30 / 762	n/a	n/a	722	1239
30 / 762	36 / 914	n/a	n/a	785	1329
30 / 762	42 / 1067	n/a	n/a	847	1452
30 / 762	48 / 1219	909	1556	909	1556
30 / 762	54 / 1372	977	1653	977	1653
30 / 762	60 / 1524	1041	1741	1041	1741
30 / 762	66 / 1676	1105	1865	1105	1865
30 / 762	72 / 1829	1166	1955	1166	1955
30 / 762	78 / 1981	1226	2076	1226	2076
30 / 762	84 / 2134	1289	2168	1289	2168

Pricing is continued on the following page.

R M S D L
Spine Desk – Single-Sided –
In-Line Position (Continued)

DIMENSIONS
INCHES / MM

PRICING

DIMENSIONS		PRICING			
INCHES / MM		FULL INTERMEDIATE GABLE (F) (CONTINUED)			
		WALL-ACCESS MODESTY PANEL (W)		ACCESS DOOR – MIDDLE (M)	
		ACCESS DOOR – LEFT OR RIGHT (L OR R)			
D	W	Foundation Laminate	Flintwood	Foundation Laminate	Flintwood
24 / 610	30 / 762	n/a	n/a	766	1241
24 / 610	36 / 914	n/a	n/a	820	1343
24 / 610	42 / 1067	n/a	n/a	875	1427
24 / 610	48 / 1219	929	1542	929	1542
24 / 610	54 / 1372	991	1631	991	1631
24 / 610	60 / 1524	1043	1728	1043	1728
24 / 610	66 / 1676	1099	1812	1099	1812
24 / 610	72 / 1829	1154	1892	1154	1892
24 / 610	78 / 1981	1206	2007	1206	2007
24 / 610	84 / 2134	1256	2087	1256	2087
30 / 762	30 / 762	n/a	n/a	839	1356
30 / 762	36 / 914	n/a	n/a	900	1448
30 / 762	42 / 1067	n/a	n/a	963	1566
30 / 762	48 / 1219	1028	1673	1028	1673
30 / 762	54 / 1372	1093	1769	1093	1769
30 / 762	60 / 1524	1158	1858	1158	1858
30 / 762	66 / 1676	1220	1982	1220	1982
30 / 762	72 / 1829	1283	2073	1283	2073
30 / 762	78 / 1981	1342	2196	1342	2196
30 / 762	84 / 2134	1406	2284	1406	2284
		FULL-HEIGHT MODESTY PANEL (F)		RECTANGULAR GROMMET – CENTERED (C)	
		RECTANGULAR GROMMET – BOTH ENDS (B)			
D	W	Foundation Laminate	Flintwood	Foundation Laminate	Flintwood
24 / 610	30 / 762	n/a	n/a	749	1223
24 / 610	36 / 914	n/a	n/a	822	1346
24 / 610	42 / 1067	n/a	n/a	896	1452
24 / 610	48 / 1219	969	1583	969	1583
24 / 610	54 / 1372	1047	1690	1047	1690
24 / 610	60 / 1524	1122	1806	1122	1806
24 / 610	66 / 1676	1197	1912	1197	1912
24 / 610	72 / 1829	1276	2011	1276	2011
24 / 610	78 / 1981	1344	2147	1344	2147
24 / 610	84 / 2134	1419	2250	1419	2250
30 / 762	30 / 762	n/a	n/a	822	1339
30 / 762	36 / 914	n/a	n/a	906	1451
30 / 762	42 / 1067	n/a	n/a	987	1587
30 / 762	48 / 1219	1068	1713	1068	1713
30 / 762	54 / 1372	1155	1828	1155	1828
30 / 762	60 / 1524	1237	1940	1237	1940
30 / 762	66 / 1676	1319	2082	1319	2082
30 / 762	72 / 1829	1404	2196	1404	2196
30 / 762	78 / 1981	1485	2332	1485	2332
30 / 762	84 / 2134	1566	2444	1566	2444

Pricing is continued on the following page.

spine desks

Xpress

R M S D L

Spine Desk – Single-Sided – In-Line Position (Continued)

DIMENSIONS
INCHES / MM

PRICING

		FULL INTERMEDIATE GABLE (F) (CONTINUED)			
		FULL-HEIGHT MODESTY PANEL (F)			
		ACCESS DOOR – LEFT OR RIGHT (L OR R)		ACCESS DOOR – MIDDLE (M)	
D	W	Foundation Laminate	Flintwood	Foundation Laminate	Flintwood
24 / 610	30 / 762	n/a	n/a	868	1341
24 / 610	36 / 914	n/a	n/a	940	1464
24 / 610	42 / 1067	n/a	n/a	1013	1566
24 / 610	48 / 1219	1085	1699	1085	1699
24 / 610	54 / 1372	1166	1806	1166	1806
24 / 610	60 / 1524	1239	1924	1239	1924
24 / 610	66 / 1676	1315	2028	1315	2028
24 / 610	72 / 1829	1387	2129	1387	2129
24 / 610	78 / 1981	1463	2264	1463	2264
24 / 610	84 / 2134	1536	2368	1536	2368
30 / 762	30 / 762	n/a	n/a	940	1456
30 / 762	36 / 914	n/a	n/a	1021	1565
30 / 762	42 / 1067	n/a	n/a	1102	1706
30 / 762	48 / 1219	1182	1830	1182	1830
30 / 762	54 / 1372	1273	1945	1273	1945
30 / 762	60 / 1524	1353	2056	1353	2056
30 / 762	66 / 1676	1437	2199	1437	2199
30 / 762	72 / 1829	1520	2311	1520	2311
30 / 762	78 / 1981	1601	2451	1601	2451
30 / 762	84 / 2134	1682	2561	1682	2561

spine desks

Xpress

R M S E L

Spine Desk – Single-Sided – Right-End Position

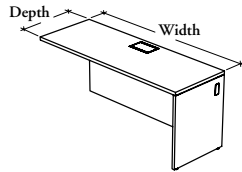

The right-end module of Spine Desk – Single-Sided is specified with a left-end or an in-line module in applications along corridor or wall.

WHAT'S INCLUDED

1 worksurface, 1 full right-end gable with levelers, 1 modesty panel (as specified), 1 cable tray with cantilever brackets, 1 communication box, hardware, grommets and/or access door (as specified).

WHAT'S EXCLUDED

Power Box and Harness.

NOTES

This desk is semi-supported and must be connected to another desk.

PRODUCT OPTIONS

Modesty Panel Height	Worksurface Grommet Style and Location	Depth	Width	Full End Gable Grommet Style	Worksurface Finish	Edge Trim Style	Full End Gable Finish	Worksurface Grommet/ Access Door Finish
F Full-Height (Shown)	Rectangular Grommet(s): B Both Ends	24, 30	30, 36, 42, 48, 54, 60, 66, 72, 78, 84	G With Grommet (Shown) N No Grommet	Foundation Laminate Flintwood	6 Straight Trim	Source Laminate Flintwood	Foundation Mica
W Wall-Access	C Centered Access Door: L Left M Middle (Shown) R Right					9 Flintwood Flat Trim		
						Edge Trim Finish Edge Trim Colors (for trim style 6)	Modesty Panel Finish Source Laminate	

SAMPLE ORDER CODE

RMSEL F	R	24	72	N	2D	6	4D	3D	3D	7
--------------------------	----------	-----------	-----------	----------	-----------	----------	-----------	-----------	-----------	----------

DIMENSIONS INCHES / MM

D	W
24 / 610	30 / 762
24 / 610	36 / 914
24 / 610	42 / 1067
24 / 610	48 / 1219
24 / 610	54 / 1372
24 / 610	60 / 1524
24 / 610	66 / 1676
24 / 610	72 / 1829
24 / 610	78 / 1981
24 / 610	84 / 2134
30 / 762	30 / 762
30 / 762	36 / 914
30 / 762	42 / 1067
30 / 762	48 / 1219
30 / 762	54 / 1372
30 / 762	60 / 1524
30 / 762	66 / 1676
30 / 762	72 / 1829
30 / 762	78 / 1981
30 / 762	84 / 2134

PRICING

WALL-ACCESS MODESTY PANEL (W)

RECTANGULAR GROMMET – BOTH ENDS (B)

FOUNDATION LAMINATE WORKSURFACE	FLINTWOOD WORKSURFACE
---------------------------------	-----------------------

FULL END GABLE FINISH

Source Laminate	Source Laminate	Flintwood
n/a	n/a	n/a
n/a	n/a	n/a
n/a	n/a	n/a
813	1424	1864
871	1514	1953
925	1611	2053
983	1696	2137
1036	1776	2214
1087	1888	2328
1138	1971	2412
n/a	n/a	n/a
n/a	n/a	n/a
n/a	n/a	n/a
909	1556	2043
977	1653	2140
1041	1741	2231
1105	1865	2355
1166	1955	2443
1226	2076	2565
1289	2168	2654

RECTANGULAR GROMMET – CENTERED (C)

FOUNDATION LAMINATE WORKSURFACE	FLINTWOOD WORKSURFACE
---------------------------------	-----------------------

Source Laminate	Source Laminate	Flintwood
650	1124	1565
704	1231	1670
760	1312	1753
813	1424	1864
871	1514	1953
925	1611	2053
983	1696	2137
1036	1776	2214
1087	1888	2328
1138	1971	2412
722	1239	1724
785	1329	1817
847	1452	1938
909	1556	2043
977	1653	2140
1041	1741	2231
1105	1865	2355
1166	1955	2443
1226	2076	2565
1289	2168	2654

Pricing is continued on the following page.

RMSEL

Spine Desk – Single-Sided – Right-End Position (Continued)

**DIMENSIONS
INCHES / MM**

PRICING

		WALL-ACCESS MODESTY PANEL (W) (CONTINUED)							
		ACCESS DOOR – LEFT OR RIGHT (L OR R)			ACCESS DOOR – MIDDLE (M)				
		FOUNDATION LAMINATE WORKSURFACE		FLINTWOOD WORKSURFACE		FOUNDATION LAMINATE WORKSURFACE		FLINTWOOD WORKSURFACE	
		FULL END GABLE FINISH							
D	W	Source Laminate	Source Laminate	Flintwood	Source Laminate	Source Laminate	Flintwood		
24 / 610	30 / 762	n/a	n/a	n/a	766	1241	1681		
24 / 610	36 / 914	n/a	n/a	n/a	820	1343	1783		
24 / 610	42 / 1067	n/a	n/a	n/a	875	1427	1868		
24 / 610	48 / 1219	929	1542	1982	929	1542	1982		
24 / 610	54 / 1372	991	1631	2069	991	1631	2069		
24 / 610	60 / 1524	1043	1728	2169	1043	1728	2169		
24 / 610	66 / 1676	1099	1812	2253	1099	1812	2253		
24 / 610	72 / 1829	1154	1892	2330	1154	1892	2330		
24 / 610	78 / 1981	1206	2007	2446	1206	2007	2446		
24 / 610	84 / 2134	1256	2087	2529	1256	2087	2529		
30 / 762	30 / 762	n/a	n/a	n/a	839	1356	1842		
30 / 762	36 / 914	n/a	n/a	n/a	900	1448	1933		
30 / 762	42 / 1067	n/a	n/a	n/a	963	1566	2054		
30 / 762	48 / 1219	1028	1673	2158	1028	1673	2158		
30 / 762	54 / 1372	1093	1769	2255	1093	1769	2255		
30 / 762	60 / 1524	1158	1858	2346	1158	1858	2346		
30 / 762	66 / 1676	1220	1982	2468	1220	1982	2468		
30 / 762	72 / 1829	1283	2073	2559	1283	2073	2559		
30 / 762	78 / 1981	1342	2196	2680	1342	2196	2680		
30 / 762	84 / 2134	1406	2284	2770	1406	2284	2770		

		FULL-HEIGHT MODESTY PANEL (F)							
		RECTANGULAR GROMMET – BOTH ENDS (B)			RECTANGULAR GROMMET – CENTERED (C)				
		FOUNDATION LAMINATE WORKSURFACE		FLINTWOOD WORKSURFACE		FOUNDATION LAMINATE WORKSURFACE		FLINTWOOD WORKSURFACE	
		FULL END GABLE FINISH							
D	W	Source Laminate	Source Laminate	Flintwood	Source Laminate	Source Laminate	Flintwood		
24 / 610	30 / 762	n/a	n/a	n/a	749	1223	1663		
24 / 610	36 / 914	n/a	n/a	n/a	822	1346	1788		
24 / 610	42 / 1067	n/a	n/a	n/a	896	1452	1890		
24 / 610	48 / 1219	969	1583	2024	969	1583	2024		
24 / 610	54 / 1372	1047	1690	2129	1047	1690	2129		
24 / 610	60 / 1524	1122	1806	2246	1122	1806	2246		
24 / 610	66 / 1676	1197	1912	2354	1197	1912	2354		
24 / 610	72 / 1829	1276	2011	2453	1276	2011	2453		
24 / 610	78 / 1981	1344	2147	2587	1344	2147	2587		
24 / 610	84 / 2134	1419	2250	2690	1419	2250	2690		
30 / 762	30 / 762	n/a	n/a	n/a	822	1339	1826		
30 / 762	36 / 914	n/a	n/a	n/a	906	1451	1937		
30 / 762	42 / 1067	n/a	n/a	n/a	987	1587	2074		
30 / 762	48 / 1219	1068	1713	2201	1068	1713	2201		
30 / 762	54 / 1372	1155	1828	2318	1155	1828	2318		
30 / 762	60 / 1524	1237	1940	2426	1237	1940	2426		
30 / 762	66 / 1676	1319	2082	2571	1319	2082	2571		
30 / 762	72 / 1829	1404	2196	2680	1404	2196	2680		
30 / 762	78 / 1981	1485	2332	2820	1485	2332	2820		
30 / 762	84 / 2134	1566	2444	2931	1566	2444	2931		

Pricing is continued on the following page.

spine desks

Xpress

R M S E L

Spine Desk – Single-Sided – Right-End Position (Continued)

DIMENSIONS
INCHES / MM

PRICING

		FULL-HEIGHT MODESTY PANEL (F) (CONTINUED)					
		ACCESS DOOR – LEFT OR RIGHT (L OR R)			ACCESS DOOR – MIDDLE (M)		
		FOUNDATION LAMINATE WORKSURFACE	FLINTWOOD WORKSURFACE		FOUNDATION LAMINATE WORKSURFACE	FLINTWOOD WORKSURFACE	
		FULL END GABLE FINISH					
D	W	Source Laminate	Source Laminate	Flintwood	Source Laminate	Source Laminate	Flintwood
24 / 610	30 / 762	n/a	n/a	n/a	868	1341	1781
24 / 610	36 / 914	n/a	n/a	n/a	940	1464	1906
24 / 610	42 / 1067	n/a	n/a	n/a	1013	1566	2007
24 / 610	48 / 1219	1085	1699	2140	1085	1699	2140
24 / 610	54 / 1372	1166	1806	2246	1166	1806	2246
24 / 610	60 / 1524	1239	1924	2366	1239	1924	2366
24 / 610	66 / 1676	1315	2028	2467	1315	2028	2467
24 / 610	72 / 1829	1387	2129	2572	1387	2129	2572
24 / 610	78 / 1981	1463	2264	2704	1463	2264	2704
24 / 610	84 / 2134	1536	2368	2805	1536	2368	2805
30 / 762	30 / 762	n/a	n/a	n/a	940	1456	1943
30 / 762	36 / 914	n/a	n/a	n/a	1021	1565	2053
30 / 762	42 / 1067	n/a	n/a	n/a	1102	1706	2195
30 / 762	48 / 1219	1182	1830	2319	1182	1830	2319
30 / 762	54 / 1372	1273	1945	2430	1273	1945	2430
30 / 762	60 / 1524	1353	2056	2543	1353	2056	2543
30 / 762	66 / 1676	1437	2199	2687	1437	2199	2687
30 / 762	72 / 1829	1520	2311	2797	1520	2311	2797
30 / 762	78 / 1981	1601	2451	2939	1601	2451	2939
30 / 762	84 / 2134	1682	2561	3048	1682	2561	3048

spine desks

Xpress

RMDRL

Spine Desk – Shared – Freestanding

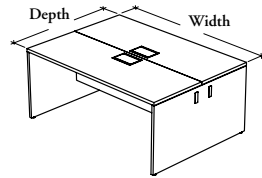

The freestanding module of Spine Desk – Shared provides maximum sharing in back-to-back application and is specified alone or beside another Spine Desk.

WHAT'S INCLUDED

2 worksurfaces, 2 full end gables with levelers, 1 raised modesty panel, 2 cable trays with cantilever brackets, 2 communication box, mounting hardware, grommets and/or access doors (as specified).

WHAT'S EXCLUDED

Power Box and Harness.

PRODUCT OPTIONS

Modesty Panel Height	Worksurface Grommet Style and Location	Depth	Width	Full End Gable Grommet Style	Worksurface Finish	Edge Trim Style	Full End Gable Finish	Worksurface Grommet/ Access Door Finish
R Raised (Shown)	Rectangular Grommet(s): B Both Ends C Centered Access Door: D Offset Left E Offset Right L Left M Middle (Shown) R Right	48, 60	30, 36, 42, 48, 54, 60, 66, 72, 78, 84	B Left and Right (Shown) L Left only N No Grommet R Right only	Foundation Laminate Flintwood	6 Straight Trim 9 Flintwood Flat Trim Edge Trim Finish Edge Trim Colors (for trim style 6)	Source Laminate Flintwood Modesty Panel Finish Source Laminate	Foundation Mica

SAMPLE ORDER CODE

RMDRL	M	60	72	B	2D	6	4D	3D	3D	E
R										

DIMENSIONS
INCHES / MM

D	W
48 / 1219	30 / 762
48 / 1219	36 / 914
48 / 1219	42 / 1067
48 / 1219	48 / 1219
48 / 1219	54 / 1372
48 / 1219	60 / 1524
48 / 1219	66 / 1676
48 / 1219	72 / 1829
48 / 1219	78 / 1981
48 / 1219	84 / 2134
60 / 1524	30 / 762
60 / 1524	36 / 914
60 / 1524	42 / 1067
60 / 1524	48 / 1219
60 / 1524	54 / 1372
60 / 1524	60 / 1524
60 / 1524	66 / 1676
60 / 1524	72 / 1829
60 / 1524	78 / 1981
60 / 1524	84 / 2134

PRICING

RECTANGULAR GROMMET – BOTH ENDS (B)			RECTANGULAR GROMMET – CENTERED (C)		
FOUNDATION LAMINATE WORKSURFACE		FLINTWOOD WORKSURFACE	FOUNDATION LAMINATE WORKSURFACE		FLINTWOOD WORKSURFACE
FULL END GABLE FINISH					
Source Laminate	Source Laminate	Flintwood	Source Laminate	Source Laminate	Flintwood
n/a	n/a	n/a	1313	2263	3872
n/a	n/a	n/a	1420	2468	4080
n/a	n/a	n/a	1528	2633	4246
1633	2861	4471	1633	2861	4471
1766	3050	4661	1766	3050	4661
1873	3243	4853	1873	3243	4853
1980	3408	5018	1980	3408	5018
2086	3569	5178	2086	3569	5178
2195	3792	5403	2195	3792	5403
2294	3956	5566	2294	3956	5566
n/a	n/a	n/a	1514	2545	4363
n/a	n/a	n/a	1637	2725	4545
n/a	n/a	n/a	1761	2966	4784
1884	3175	4993	1884	3175	4993
2032	3379	5198	2032	3379	5198
2154	3561	5379	2154	3561	5379
2282	3804	5623	2282	3804	5623
2404	3982	5802	2404	3982	5802
2525	4220	6039	2525	4220	6039
2646	4401	6219	2646	4401	6219

Pricing is continued on the following page.

RMDRL Spine Desk – Shared – Freestanding (Continued)

DIMENSIONS
INCHES / MM

D	W
48 / 1219	30 / 762
48 / 1219	36 / 914
48 / 1219	42 / 1067
48 / 1219	48 / 1219
48 / 1219	54 / 1372
48 / 1219	60 / 1524
48 / 1219	66 / 1676
48 / 1219	72 / 1829
48 / 1219	78 / 1981
48 / 1219	84 / 2134
60 / 1524	30 / 762
60 / 1524	36 / 914
60 / 1524	42 / 1067
60 / 1524	48 / 1219
60 / 1524	54 / 1372
60 / 1524	60 / 1524
60 / 1524	66 / 1676
60 / 1524	72 / 1829
60 / 1524	78 / 1981
60 / 1524	84 / 2134

PRICING

ACCESS DOOR – LEFT OR RIGHT (L OR R)			ACCESS DOOR – MIDDLE (M)		
FOUNDATION LAMINATE WORKSURFACE	FLINTWOOD WORKSURFACE		FOUNDATION LAMINATE WORKSURFACE	FLINTWOOD WORKSURFACE	
FULL END GABLE FINISH			FULL END GABLE FINISH		
Source Laminate	Source Laminate	Flintwood	Source Laminate	Source Laminate	Flintwood
n/a	n/a	n/a	1546	2496	4105
n/a	n/a	n/a	1654	2703	4314
n/a	n/a	n/a	1761	2868	4478
1865	3094	4704	1865	3094	4704
2000	3285	4896	2000	3285	4896
2105	3477	5085	2105	3477	5085
2211	3644	5251	2211	3644	5251
2321	3801	5411	2321	3801	5411
2426	4028	5636	2426	4028	5636
2529	4189	5801	2529	4189	5801
n/a	n/a	n/a	1748	2779	4596
n/a	n/a	n/a	1871	2959	4778
n/a	n/a	n/a	1996	3199	5018
2118	3408	5225	2118	3408	5225
2265	3615	5433	2265	3615	5433
2386	3792	5612	2386	3792	5612
2511	4037	5857	2511	4037	5857
2633	4217	6035	2633	4217	6035
2756	4456	6274	2756	4456	6274
2878	4634	6452	2878	4634	6452

ACCESS DOOR – OFFSET LEFT (D)			ACCESS DOOR – OFFSET RIGHT (E)		
FOUNDATION LAMINATE WORKSURFACE	FLINTWOOD WORKSURFACE		FOUNDATION LAMINATE WORKSURFACE	FLINTWOOD WORKSURFACE	
FULL END GABLE FINISH			FULL END GABLE FINISH		
Source Laminate	Source Laminate	Flintwood	Source Laminate	Source Laminate	Flintwood
2105	3477	5085	2105	3477	5085
2211	3644	5251	2211	3644	5251
2321	3801	5411	2321	3801	5411
2426	4028	5636	2426	4028	5636
2529	4189	5801	2529	4189	5801
2386	3792	5612	2386	3792	5612
2511	4037	5857	2511	4037	5857
2633	4217	6035	2633	4217	6035
2756	4456	6274	2756	4456	6274
2878	4634	6452	2878	4634	6452

spine desks

Xpress

R M D S L

Spine Desk – Shared – Left-End Position

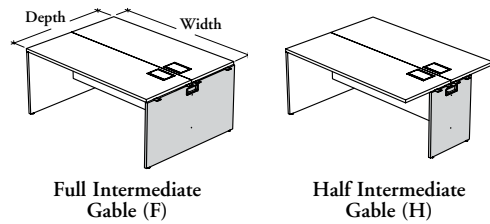

The left-end module of Spine Desk – Shared provides maximum sharing in back-to-back application and is specified next to an in-line or right-end module.

WHAT'S INCLUDED

2 worksurfaces 1 full left-end gable with levelers, 1 full or half intermediate gable with levelers (as specified), 1 raised modesty panel, 2 cable trays with cantilever brackets, 2 communication box, hardware, grommets and/or access doors (as specified).

WHAT'S EXCLUDED

Power Box and Harness.

NOTES

This desk is semi-supported and must be connected to another desk.

PRODUCT OPTIONS

Intermediate Gable Config.	Modesty Panel Height	Worksurface Grommet Style and Location	Depth	Width	Full End Gable Grommet Style	Worksurface Finish	Edge Trim Style	Full End Gable Finish	Worksurface Grommet/ Access Door Finish
F Full H Half	R Raised (Shown)	Rectangular Grommet(s): B Both Ends C Centered Access Door: D Offset Left E Offset Right L Left M Middle R Right (Shown)	48, 60	30, 36, 42, 48, 54, 60, 66, 72, 78, 84	G With Grommet N No Grommet (Shown)	Foundation Laminate Flintwood	6 Straight Trim 9 Flintwood Flat Trim Edge Trim Finish Edge Trim Colors (for trim style 6)	Source Laminate Flintwood Modesty Panel and Intermediate Gable Finish Source Laminate	Foundation Mica

SAMPLE ORDER CODE

RMDSL H	R	C	48	84	G	2D	6	4D	3D	3D	7
--------------------------	----------	----------	-----------	-----------	----------	-----------	----------	-----------	-----------	-----------	----------

DIMENSIONS INCHES / MM

D	W
48 / 1219	30 / 762
48 / 1219	36 / 914
48 / 1219	42 / 1067
48 / 1219	48 / 1219
48 / 1219	54 / 1372
48 / 1219	60 / 1524
48 / 1219	66 / 1676
48 / 1219	72 / 1829
48 / 1219	78 / 1981
48 / 1219	84 / 2134
60 / 1524	30 / 762
60 / 1524	36 / 914
60 / 1524	42 / 1067
60 / 1524	48 / 1219
60 / 1524	54 / 1372
60 / 1524	60 / 1524
60 / 1524	66 / 1676
60 / 1524	72 / 1829
60 / 1524	78 / 1981
60 / 1524	84 / 2134

PRICING

HALF INTERMEDIATE GABLE (H)

RECTANGULAR GROMMET – BOTH ENDS (B)

FOUNDATION LAMINATE WORKSURFACE	FLINTWOOD WORKSURFACE
---------------------------------	-----------------------

FULL END GABLE FINISH

Source Laminate	Source Laminate	Flintwood
n/a	n/a	n/a
n/a	n/a	n/a
n/a	n/a	n/a
1506	2731	3537
1638	2922	3728
1743	3115	3920
1854	3282	4087
1957	3442	4247
2064	3664	4471
2169	3829	4633
n/a	n/a	n/a
n/a	n/a	n/a
n/a	n/a	n/a
1757	3048	3957
1906	3256	4163
2028	3432	4343
2153	3676	4585
2275	3858	4768
2400	4096	5004
2521	4273	5185

RECTANGULAR GROMMET – CENTERED (C)

FOUNDATION LAMINATE WORKSURFACE	FLINTWOOD WORKSURFACE
---------------------------------	-----------------------

Source Laminate	Source Laminate	Flintwood
1184	2136	2941
1291	2343	3147
1400	2504	3313
1506	2731	3537
1638	2922	3728
1743	3115	3920
1854	3282	4087
1957	3442	4247
2064	3664	4471
2169	3829	4633
1385	2417	3328
1511	2600	3507
1634	2840	3748
1757	3048	3957
1906	3256	4163
2028	3432	4343
2153	3676	4585
2275	3858	4768
2400	4096	5004
2521	4273	5185

R M D S L
Spine Desk – Shared –
Left-End Position (Continued)

DIMENSIONS
INCHES / MM

PRICING

		HALF INTERMEDIATE GABLE (H) (CONTINUED)					
		ACCESS DOOR – LEFT OR RIGHT (L OR R)			ACCESS DOOR – MIDDLE (M)		
		FOUNDATION LAMINATE WORKSURFACE	FLINTWOOD WORKSURFACE		FOUNDATION LAMINATE WORKSURFACE	FLINTWOOD WORKSURFACE	
		FULL END GABLE FINISH					
D	W	Source Laminate	Source Laminate	Flintwood	Source Laminate	Source Laminate	Flintwood
48 / 1219	30 / 762	n/a	n/a	n/a	1419	2370	3174
48 / 1219	36 / 914	n/a	n/a	n/a	1527	2578	3383
48 / 1219	42 / 1067	n/a	n/a	n/a	1633	2741	3545
48 / 1219	48 / 1219	1738	2966	3773	1738	2966	3773
48 / 1219	54 / 1372	1873	3155	3959	1873	3155	3959
48 / 1219	60 / 1524	1978	3348	4153	1978	3348	4153
48 / 1219	66 / 1676	2086	3514	4320	2086	3514	4320
48 / 1219	72 / 1829	2195	3674	4479	2195	3674	4479
48 / 1219	78 / 1981	2297	3900	4704	2297	3900	4704
48 / 1219	84 / 2134	2404	4062	4867	2404	4062	4867
60 / 1524	30 / 762	n/a	n/a	n/a	1622	2653	3562
60 / 1524	36 / 914	n/a	n/a	n/a	1743	2834	3742
60 / 1524	42 / 1067	n/a	n/a	n/a	1868	3072	3981
60 / 1524	48 / 1219	1989	3284	4191	1989	3284	4191
60 / 1524	54 / 1372	2140	3488	4395	2140	3488	4395
60 / 1524	60 / 1524	2261	3666	4576	2261	3666	4576
60 / 1524	66 / 1676	2384	3912	4820	2384	3912	4820
60 / 1524	72 / 1829	2507	4090	5000	2507	4090	5000
60 / 1524	78 / 1981	2630	4328	5239	2630	4328	5239
60 / 1524	84 / 2134	2753	4507	5418	2753	4507	5418
		ACCESS DOOR – OFFSET LEFT (D)			ACCESS DOOR – OFFSET RIGHT (E)		
		FOUNDATION LAMINATE WORKSURFACE	FLINTWOOD WORKSURFACE		FOUNDATION LAMINATE WORKSURFACE	FLINTWOOD WORKSURFACE	
		FULL END GABLE FINISH					
D	W	Source Laminate	Source Laminate	Flintwood	Source Laminate	Source Laminate	Flintwood
48 / 1219	60 / 1524	1978	3348	4153	1978	3348	4153
48 / 1219	66 / 1676	2086	3514	4320	2086	3514	4320
48 / 1219	72 / 1829	2195	3674	4479	2195	3674	4479
48 / 1219	78 / 1981	2297	3900	4704	2297	3900	4704
48 / 1219	84 / 2134	2404	4062	4867	2404	4062	4867
60 / 1524	60 / 1524	2261	3666	4576	2261	3666	4576
60 / 1524	66 / 1676	2384	3912	4820	2384	3912	4820
60 / 1524	72 / 1829	2507	4090	5000	2507	4090	5000
60 / 1524	78 / 1981	2630	4328	5239	2630	4328	5239
60 / 1524	84 / 2134	2753	4507	5418	2753	4507	5418

Pricing is continued on the following page.

spine desks

Xpress

R M D S L

Spine Desk – Shared – Left-End Position (Continued)

DIMENSIONS
INCHES / MM

PRICING

		FULL INTERMEDIATE GABLE (F)					
		RECTANGULAR GROMMET – BOTH ENDS (B)			RECTANGULAR GROMMET – CENTERED (C)		
		FOUNDATION LAMINATE WORKSURFACE	FLINTWOOD WORKSURFACE		FOUNDATION LAMINATE WORKSURFACE	FLINTWOOD WORKSURFACE	
		FULL END GABLE FINISH					
D	W	Source Laminate	Source Laminate	Flintwood	Source Laminate	Source Laminate	Flintwood
48 / 1219	30 / 762	n/a	n/a	n/a	1313	2263	3068
48 / 1219	36 / 914	n/a	n/a	n/a	1420	2468	3274
48 / 1219	42 / 1067	n/a	n/a	n/a	1528	2633	3441
48 / 1219	48 / 1219	1633	2861	3664	1633	2861	3664
48 / 1219	54 / 1372	1766	3050	3856	1766	3050	3856
48 / 1219	60 / 1524	1873	3243	4047	1873	3243	4047
48 / 1219	66 / 1676	1980	3408	4212	1980	3408	4212
48 / 1219	72 / 1829	2086	3569	4376	2086	3569	4376
48 / 1219	78 / 1981	2195	3792	4598	2195	3792	4598
48 / 1219	84 / 2134	2294	3956	4761	2294	3956	4761
60 / 1524	30 / 762	n/a	n/a	n/a	1514	2545	3454
60 / 1524	36 / 914	n/a	n/a	n/a	1637	2725	3633
60 / 1524	42 / 1067	n/a	n/a	n/a	1761	2966	3873
60 / 1524	48 / 1219	1884	3175	4086	1884	3175	4086
60 / 1524	54 / 1372	2032	3379	4292	2032	3379	4292
60 / 1524	60 / 1524	2154	3561	4469	2154	3561	4469
60 / 1524	66 / 1676	2282	3804	4713	2282	3804	4713
60 / 1524	72 / 1829	2404	3982	4895	2404	3982	4895
60 / 1524	78 / 1981	2525	4220	5132	2525	4220	5132
60 / 1524	84 / 2134	2646	4401	5310	2646	4401	5310
		ACCESS DOOR – LEFT OR RIGHT (L OR R)			ACCESS DOOR – MIDDLE (M)		
		FOUNDATION LAMINATE WORKSURFACE	FLINTWOOD WORKSURFACE		FOUNDATION LAMINATE WORKSURFACE	FLINTWOOD WORKSURFACE	
		FULL END GABLE FINISH					
D	W	Source Laminate	Source Laminate	Flintwood	Source Laminate	Source Laminate	Flintwood
48 / 1219	30 / 762	n/a	n/a	n/a	1546	2496	3303
48 / 1219	36 / 914	n/a	n/a	n/a	1654	2703	3507
48 / 1219	42 / 1067	n/a	n/a	n/a	1761	2868	3673
48 / 1219	48 / 1219	1865	3094	3900	1865	3094	3900
48 / 1219	54 / 1372	2000	3285	4089	2000	3285	4089
48 / 1219	60 / 1524	2105	3477	4278	2105	3477	4278
48 / 1219	66 / 1676	2211	3644	4446	2211	3644	4446
48 / 1219	72 / 1829	2321	3801	4608	2321	3801	4608
48 / 1219	78 / 1981	2426	4028	4831	2426	4028	4831
48 / 1219	84 / 2134	2529	4189	4994	2529	4189	4994
60 / 1524	30 / 762	n/a	n/a	n/a	1748	2779	3689
60 / 1524	36 / 914	n/a	n/a	n/a	1871	2959	3866
60 / 1524	42 / 1067	n/a	n/a	n/a	1996	3199	4108
60 / 1524	48 / 1219	2118	3408	4318	2118	3408	4318
60 / 1524	54 / 1372	2265	3615	4523	2265	3615	4523
60 / 1524	60 / 1524	2386	3792	4701	2386	3792	4701
60 / 1524	66 / 1676	2511	4037	4947	2511	4037	4947
60 / 1524	72 / 1829	2633	4217	5126	2633	4217	5126
60 / 1524	78 / 1981	2756	4456	5365	2756	4456	5365
60 / 1524	84 / 2134	2878	4634	5545	2878	4634	5545

Pricing is continued on the following page.

R M D S L
Spine Desk – Shared –
Left-End Position (Continued)

DIMENSIONS
INCHES / MM

PRICING

DIMENSIONS INCHES / MM		FULL INTERMEDIATE GABLE (F) (CONTINUED)					
		ACCESS DOOR – OFFSET LEFT (D)			ACCESS DOOR – OFFSET RIGHT (E)		
		FOUNDATION LAMINATE WORKSURFACE	FLINTWOOD WORKSURFACE		FOUNDATION LAMINATE WORKSURFACE	FLINTWOOD WORKSURFACE	
		FULL END GABLE FINISH					
D	W	Source Laminate	Source Laminate	Flintwood	Source Laminate	Source Laminate	Flintwood
48 / 1219	60 / 1524	2105	3477	4278	2105	3477	4278
48 / 1219	66 / 1676	2211	3644	4446	2211	3644	4446
48 / 1219	72 / 1829	2321	3801	4608	2321	3801	4608
48 / 1219	78 / 1981	2426	4028	4831	2426	4028	4831
48 / 1219	84 / 2134	2529	4189	4994	2529	4189	4994
60 / 1524	60 / 1524	2386	3792	4701	2386	3792	4701
60 / 1524	66 / 1676	2511	4037	4947	2511	4037	4947
60 / 1524	72 / 1829	2633	4217	5126	2633	4217	5126
60 / 1524	78 / 1981	2756	4456	5365	2756	4456	5365
60 / 1524	84 / 2134	2878	4634	5545	2878	4634	5545

spine desks

Xpress

R M D D L

Spine Desk – Shared – In-Line Position

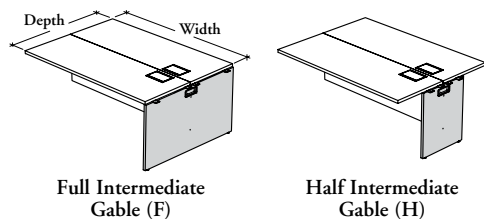

The in-line module of Spine Desk – Shared provides maximum sharing in back-to-back application and is specified between a left-end and a right-end modules.

WHAT'S INCLUDED

2 worksurfaces, 1 full or half intermediate gable with levelers (as specified), 1 raised modesty panel, 2 cable trays with cantilever brackets, 2 communication box, mounting hardware, grommets and/or access door (as specified).

WHAT'S EXCLUDED

Power Box and Harness.

NOTES

This desk is semi-supported and must be connected to other desks on both sides.

PRODUCT OPTIONS

Intermediate Gable Config.	Modesty Panel Height	Worksurface Grommet Style and Location	Depth	Width	Worksurface Finish	Edge Trim Style	Edge Trim Finish	Modesty Panel and Intermediate Gable Finish	Worksurface Grommet/ Access Door Finish
F Full	R Raised	Rectangular Grommet(s):	48, 60	30, 36, 42, 48, 54, 60, 66, 72, 78, 84	Foundation Laminate Flintwood	6 Straight Trim 9 Flintwood Flat Trim	Edge Trim Colors (for trim style 6)	Source Laminate	Foundation Mica
H Half	(Shown)	B Both Ends C Centered Access Door: D Offset Left E Offset Right L Left M Middle R Right (Shown)							

SAMPLE ORDER CODE

RMDDL	R	M	48	36	2E	6	4E	3E	E
F									

DIMENSIONS INCHES / MM

D	W
48 / 1219	30 / 762
48 / 1219	36 / 914
48 / 1219	42 / 1067
48 / 1219	48 / 1219
48 / 1219	54 / 1372
48 / 1219	60 / 1524
48 / 1219	66 / 1676
48 / 1219	72 / 1829
48 / 1219	78 / 1981
48 / 1219	84 / 2134
60 / 1524	30 / 762
60 / 1524	36 / 914
60 / 1524	42 / 1067
60 / 1524	48 / 1219
60 / 1524	54 / 1372
60 / 1524	60 / 1524
60 / 1524	66 / 1676
60 / 1524	72 / 1829
60 / 1524	78 / 1981
60 / 1524	84 / 2134

PRICING

HALF INTERMEDIATE GABLE (H)			
RECTANGULAR GROMMET – BOTH ENDS (B)		RECTANGULAR GROMMET – CENTERED (C)	
Foundation Laminate	Flintwood	Foundation Laminate	Flintwood
n/a	n/a	933	1883
n/a	n/a	1039	2090
n/a	n/a	1147	2253
1252	2480	1252	2480
1383	2668	1383	2668
1491	2862	1491	2862
1600	3025	1600	3025
1706	3188	1706	3188
1811	3413	1811	3413
1913	3575	1913	3575
n/a	n/a	1079	2110
n/a	n/a	1202	2291
n/a	n/a	1326	2530
1450	2740	1450	2740
1597	2944	1597	2944
1719	3125	1719	3125
1844	3369	1844	3369
1967	3546	1967	3546
2087	3785	2087	3785
2209	3965	2209	3965

Pricing is continued on the following page.

RMDDL
Spine Desk – Shared –
In-Line Position (Continued)

DIMENSIONS
INCHES / MM

D	W
48 / 1219	30 / 762
48 / 1219	36 / 914
48 / 1219	42 / 1067
48 / 1219	48 / 1219
48 / 1219	54 / 1372
48 / 1219	60 / 1524
48 / 1219	66 / 1676
48 / 1219	72 / 1829
48 / 1219	78 / 1981
48 / 1219	84 / 2134
60 / 1524	30 / 762
60 / 1524	36 / 914
60 / 1524	42 / 1067
60 / 1524	48 / 1219
60 / 1524	54 / 1372
60 / 1524	60 / 1524
60 / 1524	66 / 1676
60 / 1524	72 / 1829
60 / 1524	78 / 1981
60 / 1524	84 / 2134

PRICING

HALF INTERMEDIATE GABLE (H) (CONTINUED)			
ACCESS DOOR – LEFT OR RIGHT (L OR R)		ACCESS DOOR – MIDDLE (M)	
	Foundation Laminate	Flintwood	
	n/a	n/a	1166
	n/a	n/a	1276
	n/a	n/a	1379
	1485	2712	1485
	1617	2901	1617
	1723	3094	1723
	1833	3260	1833
	1940	3419	1940
	2044	3648	2044
	2147	3807	2147
	n/a	n/a	1312
	n/a	n/a	1434
	n/a	n/a	1558
	1681	2971	1681
	1830	3180	1830
	1952	3359	1952
	2076	3604	2076
	2199	3782	2199
	2321	4021	2321
	2443	4199	2443

D	W
48 / 1219	60 / 1524
48 / 1219	66 / 1676
48 / 1219	72 / 1829
48 / 1219	78 / 1981
48 / 1219	84 / 2134
60 / 1524	60 / 1524
60 / 1524	66 / 1676
60 / 1524	72 / 1829
60 / 1524	78 / 1981
60 / 1524	84 / 2134

ACCESS DOOR – OFFSET LEFT (D)				ACCESS DOOR – OFFSET RIGHT (E)			
	Foundation Laminate	Flintwood			Foundation Laminate	Flintwood	
	1723	3094			1723	3094	
	1833	3260			1833	3260	
	1940	3419			1940	3419	
	2044	3648			2044	3648	
	2147	3807			2147	3807	
	1952	3359			1952	3359	
	2076	3604			2076	3604	
	2199	3782			2199	3782	
	2321	4021			2321	4021	
	2443	4199			2443	4199	

Pricing is continued on the following page.

spine desks

Xpress

R M D D L

Spine Desk – Shared – In-Line Position (Continued)

DIMENSIONS
INCHES / MM

PRICING

D		W		FULL INTERMEDIATE GABLE (F)		RECTANGULAR GROMMET – CENTERED (C)	
				RECTANGULAR GROMMET – BOTH ENDS (B)			
				Foundation Laminate	Flintwood	Foundation Laminate	Flintwood
48 / 1219	30 / 762	n/a	n/a	1058	2008		
48 / 1219	36 / 914	n/a	n/a	1167	2214		
48 / 1219	42 / 1067	n/a	n/a	1277	2379		
48 / 1219	48 / 1219	1379	2605	1379	2605		
48 / 1219	54 / 1372	1513	2796	1513	2796		
48 / 1219	60 / 1524	1617	2988	1617	2988		
48 / 1219	66 / 1676	1725	3154	1725	3154		
48 / 1219	72 / 1829	1833	3314	1833	3314		
48 / 1219	78 / 1981	1940	3540	1940	3540		
48 / 1219	84 / 2134	2042	3704	2042	3704		
60 / 1524	30 / 762	n/a	n/a	1205	2236		
60 / 1524	36 / 914	n/a	n/a	1328	2415		
60 / 1524	42 / 1067	n/a	n/a	1453	2658		
60 / 1524	48 / 1219	1575	2865	1575	2865		
60 / 1524	54 / 1372	1723	3071	1723	3071		
60 / 1524	60 / 1524	1846	3249	1846	3249		
60 / 1524	66 / 1676	1970	3494	1970	3494		
60 / 1524	72 / 1829	2091	3674	2091	3674		
60 / 1524	78 / 1981	2211	3913	2211	3913		
60 / 1524	84 / 2134	2333	4091	2333	4091		
		ACCESS DOOR – LEFT OR RIGHT (L OR R)		ACCESS DOOR – MIDDLE (M)			
		Foundation Laminate	Flintwood	Foundation Laminate	Flintwood		
48 / 1219	30 / 762	n/a	n/a	1291	2242		
48 / 1219	36 / 914	n/a	n/a	1400	2450		
48 / 1219	42 / 1067	n/a	n/a	1506	2615		
48 / 1219	48 / 1219	1612	2840	1612	2840		
48 / 1219	54 / 1372	1747	3028	1747	3028		
48 / 1219	60 / 1524	1851	3220	1851	3220		
48 / 1219	66 / 1676	1960	3387	1960	3387		
48 / 1219	72 / 1829	2066	3546	2066	3546		
48 / 1219	78 / 1981	2172	3775	2172	3775		
48 / 1219	84 / 2134	2275	3936	2275	3936		
60 / 1524	30 / 762	n/a	n/a	1438	2468		
60 / 1524	36 / 914	n/a	n/a	1559	2648		
60 / 1524	42 / 1067	n/a	n/a	1683	2891		
60 / 1524	48 / 1219	1806	3097	1806	3097		
60 / 1524	54 / 1372	1955	3305	1955	3305		
60 / 1524	60 / 1524	2079	3486	2079	3486		
60 / 1524	66 / 1676	2203	3731	2203	3731		
60 / 1524	72 / 1829	2325	3908	2325	3908		
60 / 1524	78 / 1981	2446	4147	2446	4147		
60 / 1524	84 / 2134	2571	4326	2571	4326		

Pricing is continued on the following page.

RMDDL
Spine Desk – Shared –
In-Line Position (Continued)

DIMENSIONS
INCHES / MM

PRICING

DIMENSIONS INCHES / MM		FULL INTERMEDIATE GABLE (F) (CONTINUED)			
		ACCESS DOOR – OFFSET LEFT (D)		ACCESS DOOR – OFFSET RIGHT (E)	
D	W	Foundation Laminate	Flintwood	Foundation Laminate	Flintwood
48 / 1219	60 / 1524	1851	3220	1851	3220
48 / 1219	66 / 1676	1960	3387	1960	3387
48 / 1219	72 / 1829	2066	3546	2066	3546
48 / 1219	78 / 1981	2172	3775	2172	3775
48 / 1219	84 / 2134	2275	3936	2275	3936
60 / 1524	60 / 1524	2079	3486	2079	3486
60 / 1524	66 / 1676	2203	3731	2203	3731
60 / 1524	72 / 1829	2325	3908	2325	3908
60 / 1524	78 / 1981	2446	4147	2446	4147
60 / 1524	84 / 2134	2571	4326	2571	4326

spine desks

Xpress

R M D E L

Spine Desk – Shared – Right-End Position

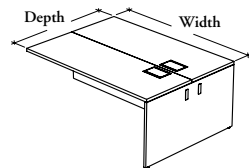

The right-end module of Spine Desk – Shared provides maximum sharing in back-to-back application and is specified next to a left-end or an in-line module.

WHAT'S INCLUDED

2 worksurfaces, 1 full right-end gable with levelers, 1 raised modesty panel, 2 cable trays with cantilever brackets, 2 communication box, hardware, grommets and/or access door (as specified).

WHAT'S EXCLUDED

Power Box and Harness.

NOTES

This desk is semi-supported and must be connected to another desk.

PRODUCT OPTIONS

Modesty Panel Height	Worksurface Grommet Style and Location	Depth	Width	Full End Gable Grommet Style	Worksurface Finish	Edge Trim Style	Full End Gable Finish	Worksurface Grommet/ Access Door Finish
R Raised (Shown)	B Both Ends C Centered Access Door: D Offset Left E Offset Right L Left M Middle R Right (Shown)	48, 60	30, 36, 42, 48, 54, 60, 66, 72, 78, 84	G With Grommet (Shown) N No Grommet	Foundation Laminate Flintwood	6 Straight Trim 9 Flintwood Flat Trim Edge Trim Finish Edge Trim Colors (for trim style 6)	Source Laminate Flintwood Modesty Panel Finish Source Laminate	Foundation Mica

SAMPLE ORDER CODE

RMDEL	D	60	84	N	2D	6	4D	3D	3D	E
R										

DIMENSIONS INCHES / MM

PRICING

		RECTANGULAR GROMMET – BOTH ENDS (B)			RECTANGULAR GROMMET – CENTERED (C)		
		FOUNDATION LAMINATE WORKSURFACE		FLINTWOOD WORKSURFACE	FOUNDATION LAMINATE WORKSURFACE		FLINTWOOD WORKSURFACE
		FULL END GABLE FINISH					
D	W	Source Laminate	Source Laminate	Flintwood	Source Laminate	Source Laminate	Flintwood
48 / 1219	30 / 762	n/a	n/a	n/a	1058	2008	2814
48 / 1219	36 / 914	n/a	n/a	n/a	1167	2214	3021
48 / 1219	42 / 1067	n/a	n/a	n/a	1277	2379	3187
48 / 1219	48 / 1219	1379	2605	3412	1379	2605	3412
48 / 1219	54 / 1372	1513	2796	3603	1513	2796	3603
48 / 1219	60 / 1524	1617	2988	3792	1617	2988	3792
48 / 1219	66 / 1676	1725	3154	3958	1725	3154	3958
48 / 1219	72 / 1829	1833	3314	4120	1833	3314	4120
48 / 1219	78 / 1981	1940	3540	4345	1940	3540	4345
48 / 1219	84 / 2134	2042	3704	4507	2042	3704	4507
60 / 1524	30 / 762	n/a	n/a	n/a	1205	2236	3145
60 / 1524	36 / 914	n/a	n/a	n/a	1328	2415	3325
60 / 1524	42 / 1067	n/a	n/a	n/a	1453	2658	3567
60 / 1524	48 / 1219	1575	2865	3776	1575	2865	3776
60 / 1524	54 / 1372	1723	3071	3980	1723	3071	3980
60 / 1524	60 / 1524	1846	3249	4159	1846	3249	4159
60 / 1524	66 / 1676	1970	3494	4405	1970	3494	4405
60 / 1524	72 / 1829	2091	3674	4582	2091	3674	4582
60 / 1524	78 / 1981	2211	3913	4822	2211	3913	4822
60 / 1524	84 / 2134	2333	4091	5001	2333	4091	5001

Pricing is continued on the following page.

R M D E L

**Spine Desk – Shared –
Right-End Position (Continued)**

**DIMENSIONS
INCHES / MM**

D	W
48 / 1219	30 / 762
48 / 1219	36 / 914
48 / 1219	42 / 1067
48 / 1219	48 / 1219
48 / 1219	54 / 1372
48 / 1219	60 / 1524
48 / 1219	66 / 1676
48 / 1219	72 / 1829
48 / 1219	78 / 1981
48 / 1219	84 / 2134
60 / 1524	30 / 762
60 / 1524	36 / 914
60 / 1524	42 / 1067
60 / 1524	48 / 1219
60 / 1524	54 / 1372
60 / 1524	60 / 1524
60 / 1524	66 / 1676
60 / 1524	72 / 1829
60 / 1524	78 / 1981
60 / 1524	84 / 2134

PRICING

ACCESS DOOR – LEFT OR RIGHT (L OR R)		
FOUNDATION LAMINATE WORKSURFACE	FLINTWOOD WORKSURFACE	
FULL END GABLE FINISH		
Source Laminate	Source Laminate	Flintwood
n/a	n/a	n/a
n/a	n/a	n/a
n/a	n/a	n/a
1612	2840	3646
1747	3028	3834
1851	3220	4028
1960	3387	4192
2066	3546	4353
2172	3775	4577
2275	3936	4741
n/a	n/a	n/a
n/a	n/a	n/a
n/a	n/a	n/a
1806	3097	4008
1955	3305	4213
2079	3486	4393
2203	3731	4638
2325	3908	4817
2446	4147	5053
2571	4326	5236

ACCESS DOOR – MIDDLE (M)		
FOUNDATION LAMINATE WORKSURFACE	FLINTWOOD WORKSURFACE	
FULL END GABLE FINISH		
Source Laminate	Source Laminate	Flintwood
1291	2242	3047
1400	2450	3256
1506	2615	3419
1612	2840	3646
1747	3028	3834
1851	3220	4028
1960	3387	4192
2066	3546	4353
2172	3775	4577
2275	3936	4741
1438	2468	3378
1559	2648	3560
1683	2891	3799
1806	3097	4008
1955	3305	4213
2079	3486	4393
2203	3731	4638
2325	3908	4817
2446	4147	5053
2571	4326	5236

ACCESS DOOR – OFFSET LEFT (D)		
FOUNDATION LAMINATE WORKSURFACE	FLINTWOOD WORKSURFACE	
FULL END GABLE FINISH		
Source Laminate	Source Laminate	Flintwood
1851	3220	4028
1960	3387	4192
2066	3546	4353
2172	3775	4577
2275	3936	4741
2079	3486	4393
2203	3731	4638
2325	3908	4817
2446	4147	5053
2571	4326	5236

ACCESS DOOR – OFFSET RIGHT (E)		
FOUNDATION LAMINATE WORKSURFACE	FLINTWOOD WORKSURFACE	
FULL END GABLE FINISH		
Source Laminate	Source Laminate	Flintwood
1851	3220	4028
1960	3387	4192
2066	3546	4353
2172	3775	4577
2275	3936	4741
2079	3486	4393
2203	3731	4638
2325	3908	4817
2446	4147	5053
2571	4326	5236

desk accessories

desk accessories product map

R D M L Flush-Mounted Modesty Panel – Solid

Page 288

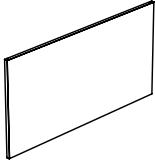

R D M O Flush-Mounted Modesty Panel – Metal

Page 289

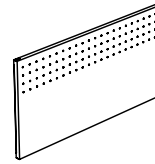

R A M L Inset Modesty Panel – Solid

Page 290

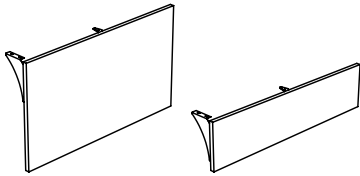

R A M O Inset Modesty Panel – Metal

Page 291

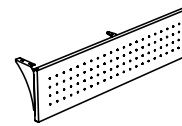

R E V L Worksurface Suspended Modesty Panel – Solid

Page 292

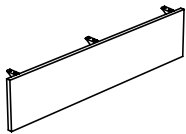

R E V O Worksurface Suspended Modesty Panel – Metal

Page 294

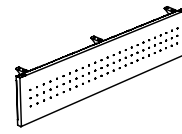

R E V G Worksurface Suspended Modesty Panel – Glass

Page 296

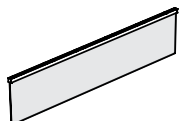

R A P C Corner Post Cover

Page 297



desk accessories product map

R A V G Semi-Supported Leg – Solid

Page 298

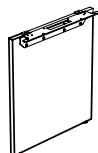

R W W O Frame Leg – Open

Page 299



R W W F Frame Leg – Full Infill

Page 300

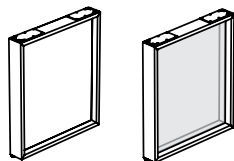

R W L A Angled Leg

Page 301



R W S Q Central Post Leg – Square

Page 302



R W L D Central Post Leg – 3 1/2" Round

Page 303



R A D M F Multi-Functional Drawer

Page 304

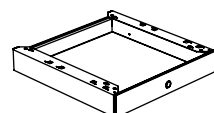

R A K B Retractable Keyboard Shelf

Page 305

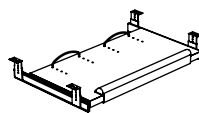

desk accessories product map

R A X Accessories

Page 306

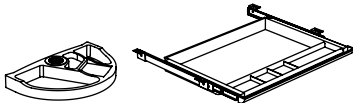

Xpress

R D M L

Flush-Mounted Modesty Panel – Solid

This modesty panel provides seated privacy for a variety of desking configurations.

WHAT'S INCLUDED

1 modesty panel, 2 grommets (if specified), and hardware.

NOTES

Width of modesty panel must equal width of desk.

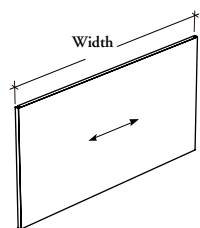

PRODUCT OPTIONS

Modesty Panel Height	Width	Modesty Panel Finish	Grommet Option
F Full-Height T 3/4 Height	24, 30, 36, 42, 48, 54, 60, 66, 72, 78, 84	Source Laminate	G Grommet (Full-Height only)

SAMPLE ORDER CODE

RDML T	30	3D	
---------------	-----------	-----------	--

**DIMENSIONS
INCHES / MM**

W
24 / 610
30 / 762
36 / 914
42 / 1067
48 / 1219
54 / 1372
60 / 1524
66 / 1676
72 / 1829
78 / 1981
84 / 2134

PRICING

	3/4 Height (T)	Full-Height (F)
	95	124
	122	150
	138	175
	167	203
	183	232
	205	258
	229	288
	252	312
	269	340
	293	368
	314	396

This modesty panel provides seated privacy for a variety of desking configurations.

R D M O

WHAT'S INCLUDED

1 modesty panel, 2 grommets (if specified), and hardware.

Flush-Mounted Modesty Panel – Metal

NOTES

Width of modesty panel must equal width of desk.

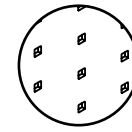

Square Solo (201)

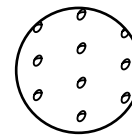

Dot Solo (401)

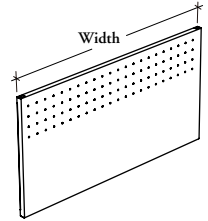

PRODUCT OPTIONS

Modesty Panel Height	Width	Modesty Panel Style	Pattern (Embossed Style only)	Modesty Panel Finish	Grommet Option
F Full-Height	24, 30, 36, 42, 48, 54, 60, 66, 72, 78, 84	E Embossed	201 Square Solo	Foundation	G Grommet (Full-Height only)
T 3/4 Height		N Solid	401 Dot Solo	Mica	

SAMPLE ORDER CODE

RDMO F	24	E	401	N	G
---------------	-----------	----------	------------	----------	----------

**DIMENSIONS
INCHES / MM**

W
24 / 610
30 / 762
36 / 914
42 / 1067
48 / 1219
54 / 1372
60 / 1524
66 / 1676
72 / 1829
78 / 1981
84 / 2134

PRICING

3/4 HEIGHT (T) SOLID (N)	FULL-HEIGHT (F)	
	Foundation	Mica
Foundation	182	203
Mica	203	217
Foundation	202	225
Mica	225	253
Foundation	220	244
Mica	244	275
Foundation	239	264
Mica	264	299
Foundation	262	293
Mica	293	321
Foundation	287	314
Mica	314	351
Foundation	299	333
Mica	333	383
Foundation	320	360
Mica	360	405
Foundation	343	383
Mica	383	440
Foundation	364	403
Mica	403	476
Foundation	383	426
Mica	426	505

EMBOSSED (E)	FULL-HEIGHT (F)	
	Foundation	Mica
Foundation	204	227
Mica	227	241
Foundation	225	248
Mica	248	280
Foundation	245	271
Mica	271	303
Foundation	264	295
Mica	295	333
Foundation	293	324
Mica	324	362
Foundation	312	348
Mica	348	391
Foundation	333	372
Mica	372	426
Foundation	360	398
Mica	398	454
Foundation	383	426
Mica	426	491
Foundation	404	451
Mica	451	528
Foundation	426	473
Mica	473	560

desk accessories

Xpress

R A M L

Inset Modesty Panel – Solid

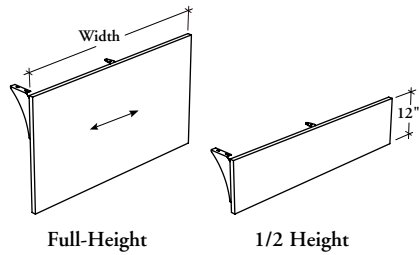

This modesty panel is used to provide privacy at the front of peninsula desks.

WHAT'S INCLUDED

1 modesty panel with hardware.

NOTES

This Inset Modesty Panel can only be used under desks with central post legs, with the following restriction:

- D-Shaped Peninsula Worksurface (RDBN) – Flush visitor option only

Width of modesty panel must equal width of desk, except RDBN where modesty panel must be 6" wider.

PRODUCT OPTIONS

Desk Visitor Option	Desk Support Style	Modesty Panel Height	Peninsula Worksurface Width	Modesty Panel Finish	Hardware Finish
F Flush	P Central Post Leg	F Full-Height	48, 54, 60, 66, 72, 78, 84	Source Laminate	Foundation Mica
R Recessed	S Camber Base	H 1/2 Height			

SAMPLE ORDER CODE

RAML F	P	F	48	XS	K
---------------	----------	----------	-----------	-----------	----------

**DIMENSIONS
INCHES / MM**

W
48 / 1219
54 / 1372
60 / 1524
66 / 1676
72 / 1829
78 / 1981
84 / 2134

PRICING

RECESSED VISITOR OPTION (R)	
1/2 Height (H)	Full-Height (F)
90	157
103	176
121	203
131	229
142	253
161	277
171	303

FLUSH VISITOR OPTION (F)	
1/2 Height (H)	Full-Height (F)
95	169
115	193
124	217
135	241
167	292
175	314
191	339

This modesty panel is used to provide privacy at the front of peninsula desks.

R A M O

Inset Modesty Panel – Metal

WHAT'S INCLUDED

1 modesty panel with hardware.

NOTES

This Inset Modesty Panel can only be used under desks with central post legs, with the following restriction:

- D-Shaped Peninsula Worksurface (RDBN) – Flush visitor option only

Width of modesty panel must equal width of desk, except RDBN where modesty panel must be 6" wider.

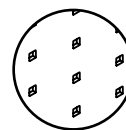

Square Solo (201)

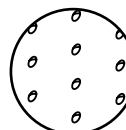

Dot Solo (401)

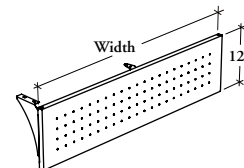

PRODUCT OPTIONS

Desk Visitor Option	Desk Support Style	Modesty Panel Height	Peninsula Worksurface Width	Modesty Panel Style	Pattern (Embossed Style only)	Modesty and Hardware Finish
F Flush	P Central Post Leg	H 1/2 Height	48, 54, 60, 66, 72, 78, 84	E Embossed	201 Square Solo	Foundation
R Recessed	S Camber Base			N Solid	401 Dot Solo	Mica

SAMPLE ORDER CODE

RAMO F	P	H	48	E	201	E
---------------	----------	----------	-----------	----------	------------	----------

**DIMENSIONS
INCHES / MM**

W
48 / 1219
54 / 1372
60 / 1524
66 / 1676
72 / 1829
78 / 1981
84 / 2134

PRICING

RECESSED VISITOR OPTION (R)			
SOLID (N)		EMBOSSSED (E)	
Foundation	Mica	Foundation	Mica
118	126	129	142
142	165	165	175
169	183	187	205
191	211	211	235
204	227	227	253
213	239	239	264
226	252	252	278

FLUSH VISITOR OPTION (F)			
SOLID (N)		EMBOSSSED (E)	
Foundation	Mica	Foundation	Mica
129	142	142	165
157	172	173	198
182	203	204	227
200	222	222	245
211	235	233	258
220	244	245	271
229	255	255	287

desk accessories

Xpress

REVL

Worksurface Suspended Modesty Panel – Solid

The modesty panel provides seated privacy for the following specific Expansion Desking worksurfaces: Rectangular Worksurfaces (RTLDL and RTLDC).

WHAT'S INCLUDED

1 modesty panel with hardware.

NOTES

Hardware is finished in Black.

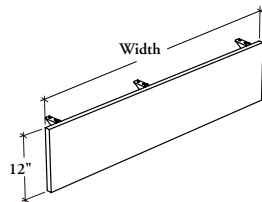

PRODUCT OPTIONS

Modesty Panel Height	Width	Modesty Panel Finish
H 1/2 Height	30, 31, 32, 33, 34, 35, 36, 37, 38, 39, 40, 41, 42, 43, 44, 45, 46, 47, 48, 49, 50, 51, 52, 53, 54, 55, 56, 57, 58, 59, 60, 61, 62, 63, 64, 65, 66, 67, 68, 69, 70, 71, 72, 73, 74, 75, 76, 77, 78, 79, 80, 81, 82, 83, 84	Source Laminate

SAMPLE ORDER CODE

REVL H	66	LE
---------------	-----------	-----------

**DIMENSIONS
INCHES / MM**

PRICING

W	
30 / 762	93
31 / 787	94
32 / 813	95
33 / 838	96
34 / 864	99
35 / 889	103
36 / 914	108
37 / 940	110
38 / 965	115
39 / 991	116
40 / 1016	118
41 / 1041	119
42 / 1067	122
43 / 1092	123
44 / 1118	124
45 / 1143	125
46 / 1168	126
47 / 1194	129
48 / 1219	132
49 / 1245	133
50 / 1270	135
51 / 1295	138
52 / 1321	142
53 / 1346	144
54 / 1372	150
55 / 1397	153
56 / 1422	167
57 / 1448	168

**DIMENSIONS
INCHES / MM**

PRICING

W	
58 / 1473	169
59 / 1499	171
60 / 1524	172
61 / 1549	173
62 / 1575	175
63 / 1600	176
64 / 1626	179
65 / 1651	181
66 / 1676	183
67 / 1702	187
68 / 1727	191
69 / 1753	193
70 / 1778	194
71 / 1803	197
72 / 1829	198
73 / 1854	202
74 / 1880	203
75 / 1905	205
76 / 1390	209
77 / 1956	212
78 / 1981	213
79 / 2007	217
80 / 2032	219
81 / 2057	222
82 / 2083	224
83 / 2108	226
84 / 2134	227

desk accessories

Xpress

REVO Worksurface Suspended Modesty Panel – Metal

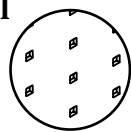
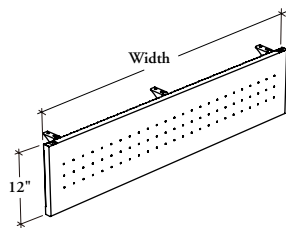

Square Solo
(201)

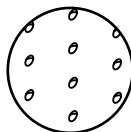

Dot Solo
(401)

The modesty panel provides seated privacy for the following specific Expansion Desking workspaces: Rectangular Workspaces (RTLTL and RTLDC).

WHAT'S INCLUDED

1 modesty panel and hardware.

PRODUCT OPTIONS

Modesty Panel Height	Width	Modesty Panel Style	Pattern (Embossed Style only)	Modesty Panel and Hardware Finish
H 1/2 Height	30, 31, 32, 33, 34, 35, 36, 37, 38, 39, 40, 41, 42, 43, 44, 45, 46, 47, 48, 49, 50, 51, 52, 53, 54, 55, 56, 57, 58, 59, 60, 61, 62, 63, 64, 65, 66, 67, 68, 69, 70, 71, 72, 73, 74, 75, 76, 77, 78, 79, 80, 81, 82, 83, 84	E Embossed N Solid	201 Square Solo 401 Dot Solo	Foundation Mica

SAMPLE ORDER CODE

REVO H	67	E	201	7
---------------	-----------	----------	------------	----------

DIMENSIONS INCHES / MM

W
30 / 762
31 / 787
32 / 813
33 / 838
34 / 864
35 / 889
36 / 914
37 / 940
38 / 965
39 / 991
40 / 1016
41 / 1041
42 / 1067
43 / 1092
44 / 1118
45 / 1143
46 / 1168
47 / 1194
48 / 1219
49 / 1245
50 / 1270
51 / 1295
52 / 1321
53 / 1346
54 / 1372
55 / 1397
56 / 1422
57 / 1448

PRICING

SOLID (N)	
Foundation	Mica
108	119
109	120
111	122
114	125
118	129
122	133
128	139
132	143
135	146
142	153
145	156
148	159
150	161
153	170
157	174
161	178
165	182
166	183
169	186
170	187
172	189
174	191
175	192
176	193
177	194
180	204
182	206
183	207

DIMENSIONS INCHES / MM

W
58 / 1473
59 / 1499
60 / 1524
61 / 1549
62 / 1575
63 / 1600
64 / 1626
65 / 1651
66 / 1676
67 / 1702
68 / 1727
69 / 1753
70 / 1778
71 / 1803
72 / 1829
73 / 1854
74 / 1880
75 / 1905
76 / 1390
77 / 1956
78 / 1981
79 / 2007
80 / 2032
81 / 2057
82 / 2083
83 / 2108
84 / 2134

PRICING

Foundation	Mica
213	241
216	244
217	245
219	247
220	248
222	250
224	252
225	253
226	254
227	259
229	261
232	264
233	265
237	269
239	271
241	273
244	276
245	277
248	280
251	283
252	284
255	287
256	288
260	292
262	294
264	296
267	299

Pricing is continued on the following page.

REVO
Worksurface Suspended
Modesty Panel – Metal (Continued)

DIMENSIONS INCHES / MM	PRICING		DIMENSIONS INCHES / MM	PRICING	
W	Foundation	Mica	W	Foundation	Mica
30 / 762	138	151	58 / 1473	237	265
31 / 787	139	152	59 / 1499	239	267
32 / 813	142	155	60 / 1524	241	269
33 / 838	148	161	61 / 1549	244	272
34 / 864	153	166	62 / 1575	245	273
35 / 889	159	172	63 / 1600	248	276
36 / 914	166	179	64 / 1626	249	277
37 / 940	169	182	65 / 1651	251	279
38 / 965	173	186	66 / 1676	252	280
39 / 991	176	189	67 / 1702	253	285
40 / 1016	182	195	68 / 1727	255	287
41 / 1041	191	204	69 / 1753	256	288
42 / 1067	196	209	70 / 1778	258	290
43 / 1092	200	220	71 / 1803	262	294
44 / 1118	204	224	72 / 1829	263	295
45 / 1143	209	229	73 / 1854	267	299
46 / 1168	212	232	74 / 1880	268	300
47 / 1194	213	233	75 / 1905	269	301
48 / 1219	217	237	76 / 1930	271	303
49 / 1245	219	239	77 / 1956	277	309
50 / 1270	222	242	78 / 1981	278	310
51 / 1295	224	244	79 / 2007	282	314
52 / 1321	226	246	80 / 2032	283	315
53 / 1346	227	247	81 / 2057	287	319
54 / 1372	229	249	82 / 2083	288	320
55 / 1397	232	260	83 / 2108	291	323
56 / 1422	233	261	84 / 2134	292	324
57 / 1448	235	263			

REVG Worksurface Suspended Modesty Panel – Glass

The modesty panel provides seated privacy for the following specific Expansion Desking workspaces: Rectangular Workspaces (RTLTL and RTLDC).

WHAT'S INCLUDED

1 modesty panel and hardware.

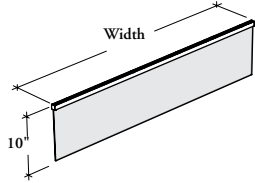

PRODUCT OPTIONS

Modesty Panel Height	Width	Glass Finish	Hardware Finish
H 1/2 Height	30, 31, 32, 33, 34, 35, 36, 37, 38, 39, 40, 41, 42, 43, 44, 45, 46, 47, 48, 49, 50, 51, 52, 53, 54, 55, 56, 57, 58, 59, 60, 61, 62, 63, 64, 65, 66, 67, 68, 69, 70, 71, 72, 73, 74, 75, 76, 77, 78, 79, 80, 81, 82, 83, 84	Standard: FT Frosted Back-Painted	Foundation Mica

SAMPLE ORDER CODE

REVG H	67	FT	7
--------	----	----	---

DIMENSIONS INCHES / MM

W	Frosted Glass (FT)/ Back-Painted Glass
30 / 762	365
31 / 787	376
32 / 813	376
33 / 838	376
34 / 864	391
35 / 889	391
36 / 914	391
37 / 940	414
38 / 965	414
39 / 991	414
40 / 1016	437
41 / 1041	437
42 / 1067	437
43 / 1092	459
44 / 1118	459
45 / 1143	459
46 / 1168	481
47 / 1194	481
48 / 1219	481
49 / 1245	506
50 / 1270	506
51 / 1295	506
52 / 1321	527
53 / 1346	527
54 / 1372	527
55 / 1397	551
56 / 1422	551
57 / 1448	551

DIMENSIONS INCHES / MM

W	Frosted Glass (FT)/ Back-Painted Glass
58 / 1473	574
59 / 1499	574
60 / 1524	574
61 / 1549	599
62 / 1575	599
63 / 1600	599
64 / 1626	619
65 / 1651	619
66 / 1676	619
67 / 1702	646
68 / 1727	646
69 / 1753	646
70 / 1778	668
71 / 1803	668
72 / 1829	668
73 / 1854	693
74 / 1880	693
75 / 1905	693
76 / 1930	717
77 / 1956	717
78 / 1981	717
79 / 2007	738
80 / 2032	738
81 / 2057	738
82 / 2083	763
83 / 2108	763
84 / 2134	763

The Corner Post Cover provides an aesthetic look and hides the Corner Post.

R A P C

Corner Post Cover

WHAT'S INCLUDED

1 cover.

NOTES

Compatible with all desks.

Coordinate colors are solid colors that can be used to match wood prints such as those of gable and modesty panel.

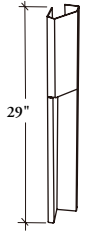

PRODUCT OPTIONS

Height	Finish
29	Foundation Mica Coordinate Colors

SAMPLE ORDER CODE

RAPC 29	R8
----------------	-----------

**DIMENSIONS
INCHES / MM**

H
29 / 737

PRICING

Foundation/Coordinate Colors	Mica
78	84

Xpress

RAVG

Semi-Supported Leg – Solid

This Semi-Supported Leg is a support alternative to legs for worksurfaces and Semi-Supported Desks. It can be used in left or right position.

WHAT'S INCLUDED

1 semi-supported leg with levelers, mounting bracket, and hardware.

WHAT'S EXCLUDED

Expansion Desking Worksurfaces and Rectangular Peninsula Desks.

Base height is 29" from finished floor to the top of the finished worksurface with a leveling range of 3".

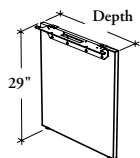

PRODUCT OPTIONS

Gable Style	Depth	Gable Finish
L Solid	14, 18, 20, 24, 30	Source Laminate Flintwood

SAMPLE ORDER CODE

RAVG L	18	LE
---------------	-----------	-----------

**DIMENSIONS
INCHES / MM**

D
14 / 356
18 / 457
20 / 508
24 / 610
30 / 762

PRICING

	Source Laminate	Flintwood
	183	676
	233	724
	258	793
	296	833
	351	955

This Frame Leg is a support alternative to legs for worksurfaces and Semi-Supported Desks. It can be used in left or right position.

WHAT'S INCLUDED

1 frame leg with levelers and hardware.

NOTES

Base height is 29" from the finished floor to the top of the finished worksurface with a leveling range of 3".

Support brackets are finished in black.

R W W O
Frame Leg – Open

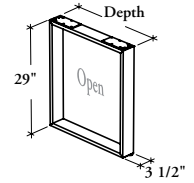

PRODUCT OPTIONS

Depth	Frame Finish
20, 24, 30	AC Clear Anodized Foundation Mica

SAMPLE ORDER CODE

RWWO 30	AC
----------------	-----------

DIMENSIONS
INCHES / MM

D
20 / 508
24 / 610
30 / 762

PRICING

442
455
471

desk accessories

Xpress

R W W F

Frame Leg – Full Infill

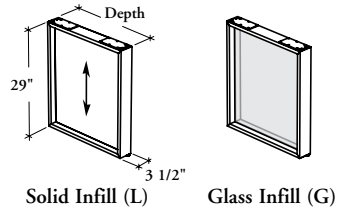

This Frame Leg is a support alternative to legs for worksurfaces and Semi-Supported Desks. It can be used in left or right position.

WHAT'S INCLUDED

1 frame leg with full infill, levelers, and hardware.

NOTES

Base height is 29" from the finished floor to the top of the finished worksurface with a leveling range of 3".

Support brackets are finished in black.

The centered solid infill is 11/16" thick.

The centered glass infill is 4 mm thick.

Not all finishes and glass infill finishes are **not** available as Xpress, Please see Xpress catalogue and/or specification software for details.

PRODUCT OPTIONS

Infill Style	Depth	Frame Finish	Infill Finish
G Glass Infill L Solid Infill	20, 24, 30	AC Clear Anodized Foundation Mica	Glass Infill: Standard: FT Frosted Back-Painted Solid Infill: Source Laminate Flintwood

SAMPLE ORDER CODE

RWWF L	24	AC	XS
---------------	-----------	-----------	-----------

DIMENSIONS
INCHES / MM

D
20 / 508
24 / 610
30 / 762

PRICING

SOLID INFILL (L)	
Source Laminate	Flintwood
586	998
633	1112
683	1302

GLASS INFILL (G)
Frosted Glass (FT)/ Back-Painted Glass
752
846
918

R W L A
Angled Leg

This leg is available for Desks and Tables and is included as an option with specific products.

WHAT'S INCLUDED

1 pair of legs (one left and one right) with leveler and hardware.

NOTES

Leg height is 29" from the finished floor to the top of the finished worksurface.

Provides leveling range of 3".

Levelers are finished in Black.

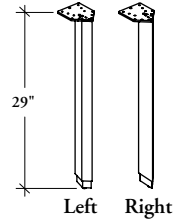

PRODUCT OPTIONS

Height	Finish
29	Foundation Mica

SAMPLE ORDER CODE

RWLA 29	7
---------	---

DIMENSIONS
INCHES / MM

H
29 / 737

PRICING

Foundation	Mica
457	473

Xpress

RWSQ

Central Post Leg – Square

This leg is available for Peninsula Desks and is included as an option with specific products.

WHAT'S INCLUDED

1 central square post leg with leveler, and hardware.

NOTES

Leg height is 29" from the finished floor to the top of the finished worksurface with a leveling range of 3".

The leveler is finished in Black.

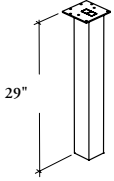

PRODUCT OPTIONS

Height	Support Finish
29	AC Clear Anodized Foundation Mica

SAMPLE ORDER CODE

RWSQ 29	AC
----------------	-----------

**DIMENSIONS
INCHES / MM**

H
29 / 737

PRICING

245

This leg is available for Peninsula Desks and is included as an option with specific products.

R W L D

Central Post Leg – 3 1/2" Round

WHAT'S INCLUDED

1 central round post leg with leveler and hardware.

NOTES

Leg height is 29" from the finished floor to the top of the finished worksurface.

Provides leveling range of 3".

The leveler is finished in Black.

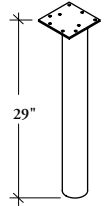

PRODUCT OPTIONS

Height	Finish
29	Foundation Mica

SAMPLE ORDER CODE

RWLD 29	E
----------------	----------

**DIMENSIONS
INCHES / MM**

H
29 / 737

PRICING

Foundation	Mica
227	248

desk accessories

Xpress

RADMF

Multi-Functional Drawer

This drawer enhances the function and organizational ability of a workstation. They provide compartmentalized storage under the worksurface.

WHAT'S INCLUDED

1 drawer, 1 pencil tray, 1 black inlay, hardware, locks and keys (as specified).

NOTES

This product can be installed underneath the worksurface along a Frame Leg, storage or gable of any type.

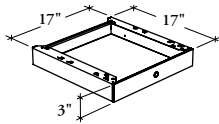

PRODUCT OPTIONS

Depth	Width	Height	Front Finish	Case Finish	Key Style
17	17	03	AC Clear Anodized	8 Arctic	N No Lock K Keyed Alike R Keyed Randomly

SAMPLE ORDER CODE

RADMF 17	17	03	AC	8	R
-----------------	-----------	-----------	-----------	----------	----------

**DIMENSIONS
INCHES / MM**

D	W	H
17 / 432	17 / 432	3 / 76

PRICING

No Lock (N)	Keyed Alike (K) / Keyed Randomly (R)
445	486

This Retractable Keyboard Shelf fits under worksurfaces and can accommodate a keyboard and a mouse.

RAKB

Retractable Keyboard Shelf

WHAT'S INCLUDED

1 keyboard shelf, wrist support, 2 retaining rods, and mounting hardware.

NOTES

Both shelf widths can accommodate a keyboard and a mouse on the same surface, but the 30" wide model is more suitable for this application.

The 26" wide shelf can be installed on any desk or worksurface wider than 30".

The 30" wide shelf can be installed on any desk or worksurface wider than 33".

The wrist support and retaining rods are finished in Black.

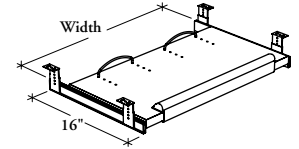

PRODUCT OPTIONS

Depth	Width	Keyboard Shelf Finish
16	26, 30	Source Laminate

SAMPLE ORDER CODE

RAKB 16	30	LE
----------------	-----------	-----------

**DIMENSIONS
INCHES / MM**

D	W
16 / 406	26 / 660
16 / 406	30 / 762

PRICING

390
442

desk accessories

Xpress

R A X Accessories

Accessories enhance the function and organizational ability of a workstation by providing compartmentalized storage under the worksurface.

WHAT'S INCLUDED

1 desk accessory.

NOTES

Available in Black only.

Not all configurations are available as Xpress. Please see Xpress catalogue and/or specification software for details.

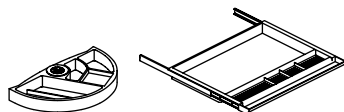

Half-Moon
Pencil Tray

Center Pencil
Drawer

PRODUCT OPTIONS

Style
01 Half-Moon Pencil Tray
05 Center Pencil Drawer

SAMPLE ORDER CODE

RAX 01

STYLE	PRICING
Xpress 01	45
05	152

columns & screens

columns & screens product map

R P S C Structural Column

Page 314



R P C E Column Extension

Page 315



R P S F Unframed Element – Fabric

Page 316

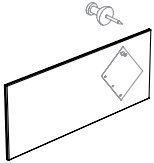

R P A J Element Connector Kit – Unframed

Page 318



R Y E F 1" Framed Element – Fabric

Page 320

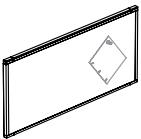

R Y E G 1" Framed Element – Glass

Page 322

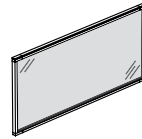

R Y S F 2" Framed Element – Fabric

Page 324

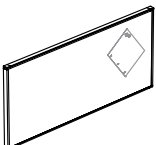

R Y S G 2" Framed Element – Glass

Page 326

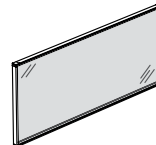

columns & screens product map

R Y C E Lateral Stabilizer – Elements

Page 328

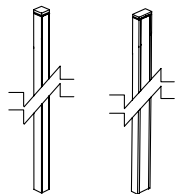

R P S A G Add-On Screen for Modular Desk – Glass

Page 330

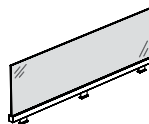

R C S B L N Central Screen for Spine Desk – Solid

Page 334

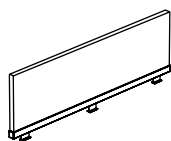

R C S L L N Lateral Screen for Spine Desk – Solid

Page 336

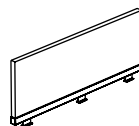

R C S B G Central Screen for Spine Desk – Glass

Page 338

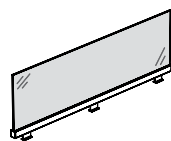

R C S L G Lateral Screen for Spine Desk – Glass

Page 340

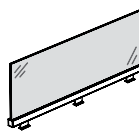

R C F B F Central Framed Screen for Spine Desk – Fabric

Page 342

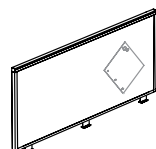

R C F L F Lateral Framed Screen for Spine Desk – Fabric

Page 344

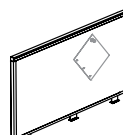

columns & screens product map

R C F B G Central Framed Screen for Spine Desk
– Glass

Page 346

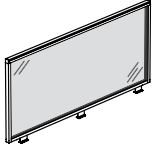

R C F L G Lateral Framed Screen for Spine Desk
– Glass

Page 348

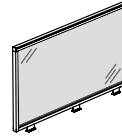

R C F B M Central Framed Screen for Spine Desk – Magnetic Glass

Page 350

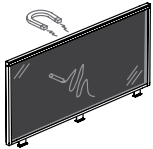

R C F L M Lateral Framed Screen for Spine Desk – Magnetic Glass

Page 352

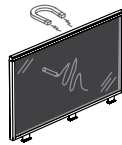

R A C M T Marker Holder for Markerboard

Page 354



R P S W G Worksurface Edge Screen – Glass

Page 356

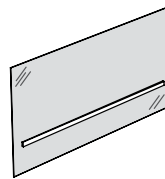

R P S W L Worksurface Edge Screen – Solid

Page 357

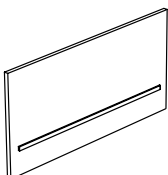

R P S B L 1" Floor Screen – Back Connection

Page 358

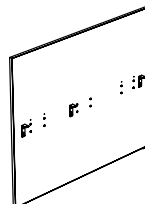

columns & screens product map

R P S L L 1" Floor Screen – Lateral Connection

Page 360

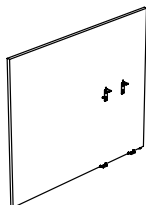

R P S B G 1" Floor Screen with Glass – Back Connection

Page 362

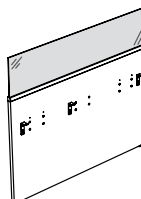

R P S L G 1" Floor Screen with Glass – Lateral Connection

Page 364

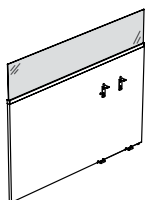

R A C M S Glass Markerboard – Screen Mounted

Page 368

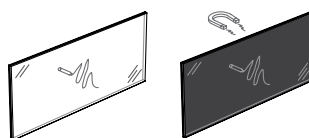

R Y _ F 2" Freestanding Screen – Upper Fabric Element

Page 372

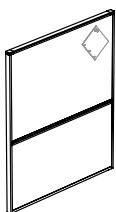

R Y _ G 2" Freestanding Screen – Upper Glass Element

Page 376

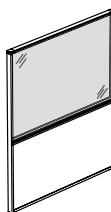

R Y _ F G 2" Freestanding Screen – Middle Fabric and Upper Glass Elements

Page 380

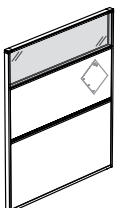

R Y C _ Back Connection Kit – 2" Freestanding Screen

Page 384

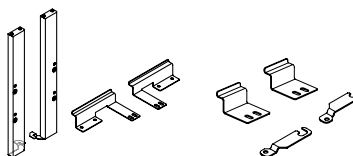

columns & screens product map

**R Y C L Lateral Connection Kit –
2" Freestanding Screen**

Page 385

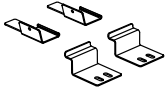

**R Y C W Wall Connection Kit –
2" Freestanding Screen**

Page 386



**R Y C D Desk Connection Kit –
2" Freestanding Screen**

Page 387

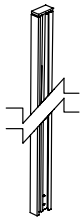

**R Y C H Height-Change Connection Kit –
2" Freestanding Screen**

Page 388



R Y C F Foot – 2" Freestanding Screen

Page 389

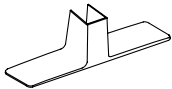

Xpress

R P S C

Structural Column

The Structural Column is used to support overhead cabinets, shelves, countertops, screens and accessory rails.

WHAT'S INCLUDED

1 structural column and 1 top cap.

WHAT'S EXCLUDED

Wire management extrusion.

NOTES

Listed dimensions are nominal. The specified height excludes the underworksurface part of the column.

Specifying a 52" high column is the only way to allow stacked overhead storage.

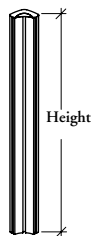

PRODUCT OPTIONS

Height	Finish
13, 15, 22, 37, 52	Foundation Mica

SAMPLE ORDER CODE

RPSC 37	E
----------------	----------

**DIMENSIONS
INCHES / MM**

H
13 / 330
15 / 381
22 / 559
37 / 940
52 / 1321

PRICING

	Foundation	Mica
	81	89
	89	96
	115	124
	157	172
	245	268

The Column Extension can be applied on top of a Structural Column (RPSC) to increase its height.

WHAT'S INCLUDED

1 column extension and 2 mounting brackets.

WHAT'S EXCLUDED

Top cap and wire management extrusion.

NOTES

Overhead cabinets and shelves **cannot** be installed on column extensions.

RPCE
Column Extension

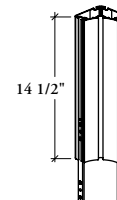

PRODUCT OPTIONS

Height	Finish
15	Foundation Mica

SAMPLE ORDER CODE

RPCE 15	E
----------------	----------

DIMENSIONS
INCHES / MM

H
15 / 381

PRICING

Foundation	Mica
80	87

columns & screens

Xpress

R P S F

Unframed Element – Fabric

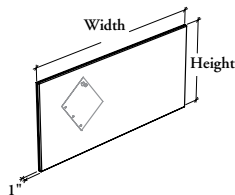

The Unframed Element – Fabric is fabric-wrapped, tackable element with acoustical properties.

WHAT'S INCLUDED

1 unframed fabric element with mounting hardware.

WHAT'S EXCLUDED

Structural Column.

NOTES

All fabric elements have the same fabric on both sides.

All dimensions come in one piece.

Listed dimensions are nominal. Elements should be specified according to column height and worksurface width.

PRODUCT OPTIONS

Height	Width	Element Finish
13, 15, 22, 37	19, 20, 22, 23, 24, 28, 29, 30, 34, 35, 36, 40, 41, 42, 46, 47, 48, 52, 53, 54, 58, 59, 60, 64, 65, 66, 70, 71, 72, 76, 77, 78, 82, 83, 84	Panel Fabric

SAMPLE ORDER CODE

RPSF 13	22	C502
----------------	-----------	-------------

**DIMENSIONS – INCHES
FOR MM X BY 25.4**

PRICING

H	W	13" HIGH ELEMENT								15" HIGH ELEMENT							
		A/COM	Gr. 1	Gr. 2	Gr. 3	Gr. 4	Gr. 5	Gr. 6	Gr. 7	A/COM	Gr. 1	Gr. 2	Gr. 3	Gr. 4	Gr. 5	Gr. 6	Gr. 7
13 / 15	19	138	150	169	176	208	235	255	278	150	165	175	194	224	253	278	298
13 / 15	20	142	154	172	182	213	245	268	290	154	167	177	198	229	260	284	309
13 / 15	22	150	165	175	194	224	253	278	298	165	172	187	203	234	267	291	316
13 / 15	23	154	167	177	198	229	260	284	309	166	173	194	205	240	274	297	321
13 / 15	24	157	169	183	202	234	268	292	318	167	175	198	211	247	282	307	332
13 / 15	28	171	177	202	220	260	299	328	356	176	194	212	232	271	311	340	368
13 / 15	29	173	183	204	225	263	304	332	361	182	198	220	235	277	316	345	371
13 / 15	30	175	191	211	229	267	307	336	364	187	202	225	239	282	319	349	376
13 / 15	34	191	203	226	245	287	326	355	387	203	217	239	258	302	345	375	406
13 / 15	35	194	204	229	248	290	332	364	394	204	222	245	262	306	348	378	412
13 / 15	36	211	227	253	271	316	360	393	425	225	239	264	289	339	389	423	457
13 / 15	40	226	239	264	289	339	389	423	457	237	253	280	306	358	412	451	487
13 / 15	41	227	245	269	292	342	393	428	464	244	258	289	311	362	413	452	490
13 / 15	42	233	251	277	297	347	396	430	466	245	260	291	312	368	418	456	493
13 / 15	46	245	260	291	312	364	414	454	491	258	277	307	332	387	442	485	523
13 / 15	47	248	262	295	319	377	434	473	514	262	287	312	339	393	448	488	528
13 / 15	48	252	268	297	321	380	438	478	519	264	288	319	343	399	455	495	538
13 / 15	52	264	288	314	340	393	445	486	524	280	299	332	362	423	484	525	571
13 / 15	53	268	289	320	348	408	469	513	552	287	303	338	364	427	487	532	575
13 / 15	54	269	291	321	350	412	471	516	557	291	309	343	372	434	498	545	590
13 / 15	58	288	307	339	368	426	485	527	572	303	324	361	390	456	519	567	612
13 / 15	59	291	309	343	372	434	498	545	590	306	326	364	391	459	523	572	617
13 / 15	60	309	331	368	399	465	534	580	630	326	351	390	420	488	554	607	658
13 / 15	64	321	348	383	413	477	544	593	641	340	365	404	435	507	577	630	683
13 / 15	65	324	350	389	418	485	550	601	651	343	368	408	440	515	589	641	695
13 / 15	66	328	354	391	423	490	557	608	659	350	374	413	449	524	600	654	710
13 / 15	70	340	368	405	440	515	589	641	695	362	389	429	462	535	609	665	719

Pricing is continued on the following page.

R P S F
Unframed Element – Fabric
(Continued)

DIMENSIONS – INCHES
FOR MM X BY 25.4

PRICING

H	W
13 / 15	71
13 / 15	72
13 / 15	76
13 / 15	77
13 / 15	78
13 / 15	82
13 / 15	83
13 / 15	84

13" HIGH ELEMENT (CONTINUED)							
A/COM	Gr. 1	Gr. 2	Gr. 3	Gr. 4	Gr. 5	Gr. 6	Gr. 7
348	370	411	442	517	592	646	698
350	374	413	449	524	600	654	710
364	390	430	464	536	610	666	720
365	391	434	469	548	628	686	741
370	398	437	474	552	633	690	748
383	408	455	491	575	658	718	776
385	412	457	493	578	660	720	780
390	418	462	498	583	666	725	786

15" HIGH ELEMENT (CONTINUED)							
A/COM	Gr. 1	Gr. 2	Gr. 3	Gr. 4	Gr. 5	Gr. 6	Gr. 7
365	391	434	469	548	628	686	741
370	398	437	474	552	633	690	748
383	408	455	491	575	658	718	776
385	412	457	493	578	660	720	780
391	420	464	499	582	665	724	785
404	432	480	519	606	691	755	815
408	437	488	525	614	704	767	832
412	440	491	528	618	709	773	836

22 / 37	19
22 / 37	20
22 / 37	22
22 / 37	23
22 / 37	24
22 / 37	28
22 / 37	29
22 / 37	30
22 / 37	34
22 / 37	35
22 / 37	36
22 / 37	40
22 / 37	41
22 / 37	42
22 / 37	46
22 / 37	47
22 / 37	48
22 / 37	52
22 / 37	53
22 / 37	54
22 / 37	58
22 / 37	59
22 / 37	60
22 / 37	64
22 / 37	65
22 / 37	66
22 / 37	70
22 / 37	71
22 / 37	72
22 / 37	76
22 / 37	77
22 / 37	78
22 / 37	82
22 / 37	83
22 / 37	84

22" HIGH ELEMENT							
A/COM	Gr. 1	Gr. 2	Gr. 3	Gr. 4	Gr. 5	Gr. 6	Gr. 7
176	194	212	232	271	311	340	368
183	200	222	237	277	316	345	371
196	205	232	251	293	339	369	400
200	211	235	255	302	347	377	409
203	220	244	260	306	350	383	414
220	235	260	287	336	385	419	455
225	239	264	289	339	389	423	457
229	245	271	295	347	399	435	470
248	262	292	314	365	416	455	492
252	268	297	321	377	430	470	512
269	291	321	350	412	471	516	557
289	309	340	370	429	490	535	578
292	312	350	375	438	501	549	594
297	320	355	383	442	509	552	599
312	333	372	403	471	542	592	639
319	340	376	408	477	548	599	647
324	350	389	418	487	554	607	658
340	365	404	435	507	577	630	683
348	370	411	442	517	592	646	698
351	375	418	451	525	601	657	712
365	391	434	473	554	639	697	756
370	399	440	476	560	643	701	761
394	423	469	506	588	670	732	792
411	440	490	528	617	708	771	835
413	442	492	532	622	710	774	838
420	451	498	538	628	715	777	842
435	465	519	564	660	760	828	896
440	474	525	567	664	763	834	900
449	477	532	574	670	767	838	907
464	496	552	597	697	795	869	940
469	499	559	604	708	813	887	960
473	506	564	608	709	813	887	960
490	525	582	632	734	838	913	991
492	528	588	637	745	849	928	1006
496	535	593	639	748	855	934	1009

37" HIGH ELEMENT							
A/COM	Gr. 1	Gr. 2	Gr. 3	Gr. 4	Gr. 5	Gr. 6	Gr. 7
333	362	401	432	505	574	628	676
348	370	411	442	517	592	646	698
362	385	429	462	538	614	669	724
368	394	435	473	552	635	691	749
376	404	451	488	573	658	718	776
408	434	487	523	611	699	764	828
413	442	492	532	622	710	774	838
428	456	506	550	646	741	809	875
455	488	541	585	677	774	843	913
462	496	552	594	691	786	860	929
499	536	597	641	748	854	933	1008
535	571	636	687	803	919	1000	1083
541	578	641	696	814	933	1015	1100
552	592	657	706	821	935	1020	1105
578	625	690	752	879	1008	1099	1191
588	633	699	757	886	1013	1108	1197
597	639	710	767	897	1023	1118	1209
629	672	746	806	938	1071	1168	1263
638	686	760	820	955	1090	1190	1288
641	693	767	831	965	1105	1205	1303
675	723	803	868	1009	1155	1257	1363
687	733	815	882	1031	1180	1286	1393
727	777	867	934	1087	1244	1357	1469
760	813	898	973	1134	1296	1414	1531
766	821	915	989	1154	1319	1440	1558
777	834	925	999	1166	1332	1453	1573
806	864	960	1039	1213	1387	1514	1638
813	871	966	1049	1226	1406	1534	1659
822	884	981	1058	1235	1409	1537	1662
855	919	1014	1095	1276	1453	1583	1714
864	925	1023	1110	1290	1473	1605	1738
869	933	1039	1121	1307	1498	1633	1769
897	964	1068	1161	1354	1549	1689	1828
911	973	1085	1169	1366	1563	1703	1842
921	986	1093	1180	1376	1574	1716	1857

Xpress

R P A J

Element Connector Kit – Unframed

The Element Connector Kit – Unframed is used to connect different types of elements in a variety of configurations (side-by-side and vertical).

WHAT'S INCLUDED

1 connector kit (as specified).

NOTES

The Element Connector Kit – Unframed can only be used with RPSF.

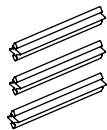

Standard

PRODUCT OPTIONS

Style
S Standard

SAMPLE ORDER CODE

RPAJ S

STYLE	PRICING
S	16

columns & screens

Xpress

RYEF

1" Framed Element – Fabric

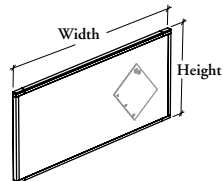

The 1" Framed Element – Fabric is fabric-wrapped, tackable element with acoustical properties and a frame finished look.

WHAT'S INCLUDED

1 framed fabric element and mounting hardware.

WHAT'S EXCLUDED

Structural Column.

NOTES

All fabric elements have the same fabric on both sides.

All dimensions come in one piece.

Listed dimensions are nominal. Elements should be specified according to column height and worksurface width.

PRODUCT OPTIONS

Height	Width	Element Finish	Frame Finish
13, 15, 22, 37	19, 20, 22, 23, 24, 28, 29, 30, 34, 35, 36, 40, 41, 42, 46, 47, 48, 52, 53, 54, 58, 59, 60, 64, 65, 66, 70, 71, 72, 76, 77, 78, 82, 83, 84	Panel Fabric	Foundation Mica

SAMPLE ORDER CODE

RYEF 37	60	C502	E
----------------	-----------	-------------	----------

**DIMENSIONS – INCHES
FOR MM X BY 25.4**

H	W
13 / 15	19
13 / 15	20
13 / 15	22
13 / 15	23
13 / 15	24
13 / 15	28
13 / 15	29
13 / 15	30
13 / 15	34
13 / 15	35
13 / 15	36
13 / 15	40
13 / 15	41
13 / 15	42
13 / 15	46
13 / 15	47
13 / 15	48
13 / 15	52
13 / 15	53
13 / 15	54
13 / 15	58
13 / 15	59

PRICING

13" HIGH ELEMENT									15" HIGH ELEMENT							
A/COM	Gr. 1	Gr. 2	Gr. 3	Gr. 4	Gr. 5	Gr. 6	Gr. 7		A/COM	Gr. 1	Gr. 2	Gr. 3	Gr. 4	Gr. 5	Gr. 6	Gr. 7
179	196	219	232	269	307	327	349		211	225	248	269	316	361	385	406
183	202	224	240	278	316	339	361		217	229	252	278	326	374	399	423
196	211	229	252	292	333	356	378		225	240	263	284	332	377	403	427
202	213	233	256	302	346	369	394		227	241	269	289	336	379	406	430
203	219	241	262	306	349	374	400		229	248	278	293	341	389	413	438
220	233	262	287	338	389	414	442		232	252	277	299	350	401	429	457
225	241	267	292	343	396	423	451		240	256	287	306	355	405	434	462
229	248	275	297	349	401	429	456		245	262	292	311	358	406	436	465
248	263	295	319	376	430	462	491		263	283	311	338	390	445	476	509
252	267	297	320	379	435	466	495		267	289	319	341	396	449	481	514
262	287	318	341	398	454	486	519		283	297	332	362	426	488	523	557
284	297	332	362	426	488	523	557		295	318	349	383	448	514	550	588
287	307	339	368	429	492	528	565		304	324	362	389	455	517	553	593
292	312	345	374	434	496	535	571		307	326	364	391	458	522	560	597
307	326	364	391	457	520	557	596		324	345	385	416	488	560	601	640
309	327	370	401	474	549	589	629		327	360	391	420	492	567	607	647
317	338	374	404	480	552	594	635		332	361	401	428	501	573	614	657
332	361	394	426	501	574	614	654		349	375	416	454	529	607	650	694
338	362	403	434	507	578	619	662		360	376	419	455	534	610	657	698
339	364	404	437	512	586	630	670		364	387	428	466	546	628	670	717
361	385	420	459	532	607	650	694		376	405	451	488	572	654	701	749
364	387	428	466	546	628	670	717		383	408	455	490	577	659	708	753

Pricing is continued on the following page.

R Y E F

1" Framed Element – Fabric (Continued)

**DIMENSIONS – INCHES
FOR MM X BY 25.4**

PRICING

H	W
13 / 15	60
13 / 15	64
13 / 15	65
13 / 15	66
13 / 15	70
13 / 15	71
13 / 15	72
13 / 15	76
13 / 15	77
13 / 15	78
13 / 15	82
13 / 15	83
13 / 15	84

13" HIGH ELEMENT (CONTINUED)							
A/COM	Gr. 1	Gr. 2	Gr. 3	Gr. 4	Gr. 5	Gr. 6	Gr. 7
387	413	459	496	582	666	715	762
404	434	477	517	600	684	733	782
405	437	487	522	607	691	742	791
412	445	490	528	612	697	749	797
426	459	506	550	641	734	789	840
434	462	513	551	647	738	792	846
437	469	517	560	654	746	800	854
455	488	541	579	672	764	820	876
456	490	545	588	684	780	836	892
462	495	548	594	693	790	847	906
477	512	570	612	718	821	883	941
480	515	572	617	722	826	887	947
488	522	578	625	725	831	890	950

15" HIGH ELEMENT (CONTINUED)							
A/COM	Gr. 1	Gr. 2	Gr. 3	Gr. 4	Gr. 5	Gr. 6	Gr. 7
408	442	488	527	611	696	748	796
426	456	505	546	637	725	780	833
428	459	512	550	641	734	789	840
437	469	517	560	654	746	800	854
454	487	538	578	670	763	819	875
456	490	545	588	684	780	836	892
462	495	548	594	693	790	847	906
477	512	570	612	718	821	883	941
480	515	572	617	722	826	887	947
490	527	579	629	725	826	887	948
505	544	600	648	754	861	923	986
512	548	610	658	767	877	940	1005
515	550	612	661	775	886	950	1013

22 / 37	19
22 / 37	20
22 / 37	22
22 / 37	23
22 / 37	24
22 / 37	28
22 / 37	29
22 / 37	30
22 / 37	34
22 / 37	35
22 / 37	36
22 / 37	40
22 / 37	41
22 / 37	42
22 / 37	46
22 / 37	47
22 / 37	48
22 / 37	52
22 / 37	53
22 / 37	54
22 / 37	58
22 / 37	59
22 / 37	60
22 / 37	64
22 / 37	65
22 / 37	66
22 / 37	70
22 / 37	71
22 / 37	72
22 / 37	76
22 / 37	77
22 / 37	78
22 / 37	82
22 / 37	83
22 / 37	84

22" HIGH ELEMENT							
A/COM	Gr. 1	Gr. 2	Gr. 3	Gr. 4	Gr. 5	Gr. 6	Gr. 7
232	252	277	299	350	401	429	457
241	260	289	307	355	405	434	462
253	268	299	326	382	440	471	499
260	275	306	332	389	447	477	510
263	287	318	340	398	455	487	519
287	306	340	371	434	499	536	572
292	311	345	375	440	506	541	575
297	319	354	385	449	515	550	588
320	341	378	408	476	545	582	619
327	349	389	419	488	557	597	637
339	364	404	437	512	586	630	670
362	387	426	462	536	611	658	699
368	391	437	470	550	632	676	722
374	403	447	477	556	638	686	731
391	418	466	501	586	670	720	768
401	426	471	512	594	677	727	777
405	437	487	522	607	691	742	791
426	456	505	546	637	725	780	833
434	462	513	551	641	733	786	840
442	470	522	564	655	747	802	855
456	490	545	593	695	797	858	915
462	496	550	596	703	806	864	922
492	528	588	633	734	836	896	957
513	550	611	661	775	886	950	1013
517	551	614	662	776	887	952	1014
527	564	625	672	782	892	958	1022
546	582	648	704	826	949	1017	1085
550	594	658	708	831	954	1021	1090
560	597	662	719	841	963	1032	1100
579	619	695	748	875	1000	1073	1144
588	629	698	756	884	1010	1085	1159
593	633	704	761	889	1015	1090	1165
611	658	725	789	920	1050	1126	1202
614	661	732	795	930	1065	1141	1219
619	668	742	800	935	1070	1147	1223

37" HIGH ELEMENT							
A/COM	Gr. 1	Gr. 2	Gr. 3	Gr. 4	Gr. 5	Gr. 6	Gr. 7
418	454	499	544	633	723	775	828
434	462	513	551	641	733	786	840
454	480	538	578	677	777	834	889
459	492	546	593	693	791	848	907
471	505	564	610	718	825	886	944
512	545	607	657	767	879	941	1006
517	551	614	662	776	887	952	1014
536	571	633	689	806	922	991	1056
570	610	674	727	846	963	1034	1102
578	619	695	746	869	993	1064	1134
629	670	748	805	937	1070	1147	1223
668	713	793	860	1005	1152	1235	1317
674	722	805	871	1022	1169	1254	1339
695	741	820	882	1024	1166	1250	1335
722	781	864	940	1097	1255	1346	1438
732	790	876	949	1108	1263	1357	1450
748	800	889	960	1122	1284	1376	1469
783	839	930	1008	1177	1344	1442	1539
797	858	950	1023	1192	1360	1458	1556
805	867	960	1036	1203	1371	1473	1573
843	907	1006	1082	1257	1434	1538	1643
860	919	1021	1102	1286	1470	1576	1682
912	971	1081	1167	1363	1556	1666	1779
950	1015	1124	1216	1419	1617	1737	1854
957	1027	1141	1237	1444	1654	1774	1892
971	1042	1159	1250	1458	1665	1786	1907
1008	1080	1201	1297	1516	1735	1859	1985
1015	1087	1209	1308	1529	1750	1878	2003
1031	1108	1226	1326	1545	1766	1893	2022
1068	1148	1264	1370	1594	1817	1948	2080
1080	1159	1284	1384	1612	1840	1974	2108
1085	1166	1297	1400	1633	1865	2002	2137
1123	1206	1336	1452	1695	1940	2080	2217
1138	1216	1356	1463	1712	1957	2097	2240
1152	1235	1369	1477	1723	1971	2114	2255

columns & screens

Xpress

RYEG

1" Framed Element – Glass

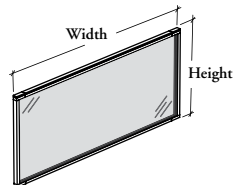

The 1" Framed Element – Glass provides a complete or partial view of adjacent workstations depending on the finish specified.

WHAT'S INCLUDED

1 framed glass element and mounting hardware.

WHAT'S EXCLUDED

Structural Column.

NOTES

Tempered glass elements are two-sided for a flush look.

Frosted (FT) is a single-sided etched glass which is facing inward of the two-sided glass assembly.

All dimensions come in one piece.

Listed dimensions are nominal. Elements should be specified according to column height and worksurface width.

All glass finishes are available as Xpress. Please see Xpress catalogue and/or specification software for details.

PRODUCT OPTIONS

Height	Width	Frame Finish	Glass Finish
13, 15, 22, 37	19, 20, 22, 23, 24, 28, 29, 30, 34, 35, 36, 40, 41, 42, 46, 47, 48, 52, 53, 54, 58, 59, 60, 64, 65, 66, 70, 71, 72, 76, 77, 78, 82, 83, 84	Foundation Mica	CL Clear FT Frosted

SAMPLE ORDER CODE

RYEG 13	58	G	FT
----------------	-----------	----------	-----------

DIMENSIONS – INCHES FOR MM X BY 25.4

H	W
13 / 15	19
13 / 15	20
13 / 15	22
13 / 15	23
13 / 15	24
13 / 15	28
13 / 15	29
13 / 15	30
13 / 15	34
13 / 15	35
13 / 15	36
13 / 15	40
13 / 15	41
13 / 15	42
13 / 15	46
13 / 15	47
13 / 15	48
13 / 15	52
13 / 15	53
13 / 15	54
13 / 15	58
13 / 15	59

PRICING

13" HIGH ELEMENT

Clear Glass (CL)	Frosted Glass (FT)
202	252
211	262
224	277
227	282
232	288
256	320
263	329
271	344
297	375
303	381
326	408
355	444
360	449
364	454
394	490
396	492
403	500
429	537
434	544
440	553
470	589
471	590

15" HIGH ELEMENT

Clear Glass (CL)	Frosted Glass (FT)
227	282
233	289
252	316
256	320
263	329
293	370
303	381
309	388
346	433
348	435
371	463
406	505
411	510
413	516
449	564
454	569
461	579
492	615
495	619
506	631
544	679
546	681

Pricing is continued on the following page.

RYEG 1" Framed Element – Glass (Continued)

**DIMENSIONS – INCHES
FOR MM X BY 25.4**

PRICING

H	W
13 / 15	60
13 / 15	64
13 / 15	65
13 / 15	66
13 / 15	70
13 / 15	71
13 / 15	72
13 / 15	76
13 / 15	77
13 / 15	78
13 / 15	82
13 / 15	83
13 / 15	84

13" HIGH ELEMENT (CONTINUED)	
Clear Glass (CL)	Frosted Glass (FT)
490	613
519	648
519	648
532	664
554	692
559	697
567	706
604	756
607	759
616	770
640	805
643	808
657	824

15" HIGH ELEMENT (CONTINUED)	
Clear Glass (CL)	Frosted Glass (FT)
560	699
597	747
599	749
608	761
640	805
643	808
657	824
698	872
699	873
708	883
747	930
748	931
755	942

22 / 37	19
22 / 37	20
22 / 37	22
22 / 37	23
22 / 37	24
22 / 37	28
22 / 37	29
22 / 37	30
22 / 37	34
22 / 37	35
22 / 37	36
22 / 37	40
22 / 37	41
22 / 37	42
22 / 37	46
22 / 37	47
22 / 37	48
22 / 37	52
22 / 37	53
22 / 37	54
22 / 37	58
22 / 37	59
22 / 37	60
22 / 37	64
22 / 37	65
22 / 37	66
22 / 37	70
22 / 37	71
22 / 37	72
22 / 37	76
22 / 37	77
22 / 37	78
22 / 37	82
22 / 37	83
22 / 37	84

22" HIGH ELEMENT	
Clear Glass (CL)	Frosted Glass (FT)
297	375
307	386
327	409
338	422
349	436
390	485
399	495
411	510
454	569
461	579
487	609
534	666
538	671
549	686
593	741
597	747
608	761
657	824
662	830
674	843
717	894
720	897
747	930
789	986
792	990
811	1014
849	1062
860	1076
867	1084
921	1150
923	1155
935	1168
984	1232
989	1237
999	1250

37" HIGH ELEMENT	
Clear Glass (CL)	Frosted Glass (FT)
536	669
552	690
590	738
607	759
629	786
698	872
717	894
733	914
814	1017
821	1025
868	1085
952	1191
957	1197
973	1217
1056	1319
1065	1332
1081	1350
1165	1456
1169	1461
1191	1487
1268	1586
1279	1598
1319	1647
1404	1754
1412	1763
1426	1781
1511	1887
1517	1895
1536	1921
1631	2039
1634	2042
1656	2070
1739	2173
1748	2183
1766	2208

RYSF

2" Framed Element – Fabric

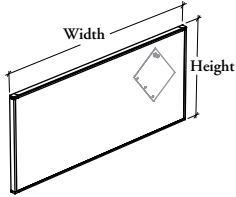

The 2" Framed Element – Fabric is fabric-wrapped, tackable element with acoustical properties and a frame finished look.

WHAT'S INCLUDED

1 framed fabric element and mounting hardware.

WHAT'S EXCLUDED

Structural Column.

NOTES

All fabric elements have the same fabric on both sides.

Must be used either in back or lateral position between two workstations.

Can be used with Structural Column on one side or both sides.

All dimensions come in one piece.

Listed dimensions are nominal. Elements should be specified according to column height and worksurface width.

PRODUCT OPTIONS

Height	Width	Element Finish	Frame Finish
13, 15, 22, 37	19, 20, 22, 23, 24, 28, 29, 30, 34, 35, 36, 40, 41, 42, 46, 47, 48, 52, 53, 54, 58, 59, 60, 64, 65, 66, 70, 71, 72, 76, 77, 78, 82, 83, 84	Panel Fabric	Foundation Mica

SAMPLE ORDER CODE

RYSF 37	60	C502	E
----------------	-----------	-------------	----------

**DIMENSIONS – INCHES
FOR MM X BY 25.4**

H	W
13 / 15	19
13 / 15	20
13 / 15	22
13 / 15	23
13 / 15	24
13 / 15	28
13 / 15	29
13 / 15	30
13 / 15	34
13 / 15	35
13 / 15	36
13 / 15	40
13 / 15	41
13 / 15	42
13 / 15	46
13 / 15	47
13 / 15	48
13 / 15	52
13 / 15	53
13 / 15	54
13 / 15	58
13 / 15	59

PRICING

13" HIGH ELEMENT

A/COM	Gr. 1	Gr. 2	Gr. 3	Gr. 4	Gr. 5	Gr. 6	Gr. 7
271	292	327	348	404	461	481	501
282	303	338	362	420	480	501	524
292	317	346	376	437	496	522	545
303	320	350	387	451	516	541	565
306	327	364	394	461	525	551	575
331	350	394	428	506	582	610	638
339	364	403	437	515	592	618	647
346	371	412	449	527	607	636	661
371	398	445	477	557	640	670	699
376	403	449	481	565	646	676	708
394	428	476	513	594	676	712	744
427	449	498	544	637	731	766	800
428	462	509	549	637	723	761	795
437	469	517	564	657	749	785	820
462	490	545	589	687	783	821	861
464	492	552	599	704	810	848	889
473	505	564	604	713	818	860	897
498	541	590	638	735	834	875	913
505	544	602	654	766	877	920	962
509	545	604	659	775	889	933	973
541	578	635	689	795	906	949	993
545	579	641	699	822	942	989	1034

15" HIGH ELEMENT

A/COM	Gr. 1	Gr. 2	Gr. 3	Gr. 4	Gr. 5	Gr. 6	Gr. 7
317	339	371	406	476	546	571	593
326	346	376	416	487	557	582	607
339	362	398	427	493	567	590	612
343	364	406	432	503	572	597	619
346	371	416	442	516	589	612	639
348	376	413	454	527	602	633	660
362	387	428	459	531	602	633	660
369	394	437	466	538	610	640	668
398	423	466	505	585	666	697	727
403	432	477	513	593	674	708	738
423	449	498	544	637	731	766	800
445	476	523	574	672	771	809	843
457	488	544	585	677	774	812	848
462	490	545	589	687	783	821	861
488	517	578	628	734	842	884	923
492	538	589	635	742	849	891	933
498	541	599	641	749	860	899	941
523	565	628	677	792	908	952	995
538	570	632	681	802	915	960	1005
545	579	641	699	822	942	989	1034
570	608	675	731	851	973	1021	1070
574	612	681	733	861	983	1031	1078

Pricing is continued on the following page.

R Y S F 2" Framed Element – Fabric (Continued)

**DIMENSIONS – INCHES
FOR MM X BY 25.4**

PRICING

H	W
13 / 15	60
13 / 15	64
13 / 15	65
13 / 15	66
13 / 15	70
13 / 15	71
13 / 15	72
13 / 15	76
13 / 15	77
13 / 15	78
13 / 15	82
13 / 15	83
13 / 15	84

13" HIGH ELEMENT (CONTINUED)							
A/COM	Gr. 1	Gr. 2	Gr. 3	Gr. 4	Gr. 5	Gr. 6	Gr. 7
579	618	689	747	872	999	1047	1095
604	654	719	775	897	1015	1067	1116
608	659	727	785	912	1039	1089	1138
617	665	733	793	923	1053	1104	1155
638	689	760	828	966	1110	1163	1215
654	695	768	832	977	1116	1169	1223
659	704	775	841	984	1123	1179	1234
681	731	810	871	1013	1157	1210	1264
684	733	815	880	1028	1176	1234	1289
695	746	821	891	1038	1182	1240	1297
719	766	849	921	1076	1234	1291	1353
720	771	858	928	1083	1241	1302	1362
731	785	868	935	1090	1248	1310	1369

15" HIGH ELEMENT (CONTINUED)							
A/COM	Gr. 1	Gr. 2	Gr. 3	Gr. 4	Gr. 5	Gr. 6	Gr. 7
612	662	731	791	920	1047	1097	1148
638	684	756	820	957	1093	1147	1199
641	689	766	828	966	1110	1163	1215
659	704	775	841	980	1116	1170	1225
677	727	806	868	1006	1144	1201	1255
684	733	815	880	1028	1176	1234	1289
695	746	821	891	1038	1182	1240	1297
719	766	849	921	1076	1234	1291	1353
720	771	858	928	1083	1241	1302	1362
733	791	871	940	1096	1253	1313	1373
756	814	900	971	1130	1289	1354	1414
766	821	918	986	1148	1310	1373	1437
771	828	921	994	1161	1326	1392	1455

22 / 37	19
22 / 37	20
22 / 37	22
22 / 37	23
22 / 37	24
22 / 37	28
22 / 37	29
22 / 37	30
22 / 37	34
22 / 37	35
22 / 37	36
22 / 37	40
22 / 37	41
22 / 37	42
22 / 37	46
22 / 37	47
22 / 37	48
22 / 37	52
22 / 37	53
22 / 37	54
22 / 37	58
22 / 37	59
22 / 37	60
22 / 37	64
22 / 37	65
22 / 37	66
22 / 37	70
22 / 37	71
22 / 37	72
22 / 37	76
22 / 37	77
22 / 37	78
22 / 37	82
22 / 37	83
22 / 37	84

22" HIGH ELEMENT							
A/COM	Gr. 1	Gr. 2	Gr. 3	Gr. 4	Gr. 5	Gr. 6	Gr. 7
348	376	413	454	527	602	633	660
364	391	432	462	535	610	639	667
379	404	454	490	577	661	693	722
391	412	459	498	586	674	708	737
398	428	476	510	594	683	715	747
428	459	510	554	655	752	786	821
437	466	517	565	661	761	795	832
449	477	534	578	679	781	818	854
481	513	571	612	717	819	858	893
492	523	585	632	737	843	884	923
509	545	604	659	775	889	933	973
544	579	638	695	810	923	967	1012
549	589	659	706	824	941	989	1034
564	602	668	719	835	952	998	1043
589	630	699	755	878	1005	1053	1100
599	638	709	766	893	1022	1072	1122
608	659	727	785	912	1039	1089	1138
638	684	756	820	957	1093	1147	1199
654	695	768	832	965	1102	1158	1210
662	706	785	843	984	1122	1177	1232
684	733	815	890	1045	1203	1261	1319
695	747	828	893	1053	1210	1269	1327
741	793	880	949	1102	1255	1315	1376
768	828	919	994	1161	1326	1392	1455
775	832	922	996	1167	1334	1399	1460
791	843	935	1008	1174	1340	1405	1470
820	872	971	1057	1241	1424	1492	1563
828	891	986	1063	1249	1431	1501	1572
841	896	996	1079	1259	1442	1513	1580
871	933	1042	1122	1312	1501	1575	1648
880	940	1049	1133	1328	1523	1597	1670
890	949	1057	1141	1337	1534	1605	1680
919	986	1092	1182	1382	1581	1658	1734
922	994	1099	1195	1394	1596	1673	1750
933	1005	1112	1201	1404	1603	1681	1757

37" HIGH ELEMENT							
A/COM	Gr. 1	Gr. 2	Gr. 3	Gr. 4	Gr. 5	Gr. 6	Gr. 7
630	677	751	814	950	1085	1137	1190
654	695	768	832	965	1102	1158	1210
677	720	806	868	1013	1161	1216	1270
689	741	820	890	1039	1190	1247	1303
709	756	843	918	1078	1240	1300	1360
766	815	911	983	1148	1313	1376	1440
775	832	922	996	1163	1328	1394	1457
805	855	949	1034	1210	1387	1456	1523
849	918	1010	1093	1274	1452	1522	1592
868	933	1042	1118	1302	1488	1560	1632
940	1007	1122	1208	1409	1608	1687	1763
1005	1068	1194	1289	1511	1732	1815	1898
1010	1082	1208	1303	1527	1748	1833	1917
1042	1110	1232	1326	1535	1755	1839	1924
1082	1168	1295	1413	1656	1900	1995	2083
1099	1184	1312	1421	1665	1908	2001	2091
1122	1201	1335	1438	1676	1914	2007	2097
1172	1257	1394	1513	1766	2021	2118	2211
1199	1286	1424	1537	1786	2036	2136	2234
1208	1297	1438	1553	1807	2062	2166	2261
1264	1358	1507	1625	1894	2161	2265	2371
1289	1376	1531	1653	1928	2204	2311	2416
1370	1460	1623	1753	2042	2332	2445	2557
1424	1525	1689	1828	2132	2439	2555	2671
1434	1540	1713	1854	2166	2479	2600	2718
1460	1563	1737	1878	2189	2501	2623	2743
1513	1622	1799	1948	2275	2603	2727	2852
1525	1633	1813	1967	2298	2631	2760	2886
1544	1656	1839	1985	2319	2653	2781	2908
1603	1721	1902	2056	2386	2721	2852	2984
1622	1737	1924	2081	2424	2769	2900	3033
1629	1750	1948	2102	2456	2807	2943	3080
1688	1808	2004	2176	2543	2909	3050	3189
1709	1828	2035	2197	2560	2927	3068	3210
1725	1849	2052	2214	2584	2952	3095	3239

columns & screens

Xpress

R Y S G

2" Framed Element – Glass

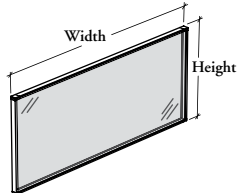

The 2" Framed Element – Glass provides a complete or partial view of adjacent workstations depending on the finish specified.

WHAT'S INCLUDED

1 framed glass element and mounting hardware.

WHAT'S EXCLUDED

Structural Column.

NOTES

Tempered glass elements are two-sided for a flush look.

Frosted (FT) is a single-sided etched glass which is facing inward of the two-sided glass assembly.

Must be used either in back or lateral position between two workstations.

Can be used with Structural Column on one side or both sides.

All dimensions come in one piece.

Listed dimensions are nominal. Elements should be specified according to column height and worksurface width.

PRODUCT OPTIONS

Height	Width	Frame Finish	Glass Finish
13, 15, 22, 37	19, 20, 22, 23, 24, 28, 29, 30, 34, 35, 36, 40, 41, 42, 46, 47, 48, 52, 53, 54, 58, 59, 60, 64, 65, 66, 70, 71, 72, 76, 77, 78, 82, 83, 84	Foundation Mica	CL Clear FT Frosted

SAMPLE ORDER CODE

R Y S G 13	58	G	FT
-------------------	-----------	----------	-----------

**DIMENSIONS – INCHES
FOR MM X BY 25.4**

H	W
13 / 15	19
13 / 15	20
13 / 15	22
13 / 15	23
13 / 15	24
13 / 15	28
13 / 15	29
13 / 15	30
13 / 15	34
13 / 15	35
13 / 15	36
13 / 15	40
13 / 15	41
13 / 15	42
13 / 15	46
13 / 15	47
13 / 15	48
13 / 15	52
13 / 15	53
13 / 15	54
13 / 15	58
13 / 15	59

PRICING

13" HIGH ELEMENT

Clear Glass (CL)	Frosted Glass (FT)
303	381
317	397
338	422
343	428
348	435
387	482
398	494
408	507
449	564
455	571
490	613
535	668
538	671
545	680
590	738
593	741
602	754
643	808
654	820
660	827
706	881
709	885

15" HIGH ELEMENT

Clear Glass (CL)	Frosted Glass (FT)
343	428
350	437
376	469
387	482
398	494
442	555
455	571
464	582
519	648
522	653
554	692
610	763
614	768
618	772
674	843
677	848
690	863
741	923
746	929
760	951
814	1017
820	1024

Pricing is continued on the following page.

R Y S G 2" Framed Element – Glass (Continued)

**DIMENSIONS – INCHES
FOR MM X BY 25.4**

H	W
13 / 15	60
13 / 15	64
13 / 15	65
13 / 15	66
13 / 15	70
13 / 15	71
13 / 15	72
13 / 15	76
13 / 15	77
13 / 15	78
13 / 15	82
13 / 15	83
13 / 15	84

PRICING

13" HIGH ELEMENT (CONTINUED)

Clear Glass (CL)	Frosted Glass (FT)
733	914
781	977
781	977
795	995
836	1047
839	1050
848	1061
908	1134
911	1138
925	1157
963	1203
966	1207
983	1228

15" HIGH ELEMENT (CONTINUED)

Clear Glass (CL)	Frosted Glass (FT)
841	1052
896	1121
898	1123
912	1139
963	1203
966	1207
983	1228
1049	1311
1052	1315
1063	1327
1119	1401
1122	1404
1132	1416

22" HIGH ELEMENT

	Clear Glass (CL)	Frosted Glass (FT)
22 / 37	449	564
22 / 37	462	580
22 / 37	492	615
22 / 37	505	630
22 / 37	523	654
22 / 37	586	730
22 / 37	597	747
22 / 37	614	768
22 / 37	677	848
22 / 37	690	863
22 / 37	727	908
22 / 37	800	1000
22 / 37	806	1008
22 / 37	826	1031
22 / 37	890	1114
22 / 37	896	1121
22 / 37	912	1139
22 / 37	983	1228
22 / 37	996	1245
22 / 37	1010	1263
22 / 37	1073	1341
22 / 37	1081	1350
22 / 37	1119	1401
22 / 37	1182	1477
22 / 37	1191	1487
22 / 37	1216	1520
22 / 37	1281	1600
22 / 37	1289	1610
22 / 37	1297	1621
22 / 37	1380	1726
22 / 37	1384	1730
22 / 37	1404	1754
22 / 37	1477	1847
22 / 37	1481	1852
22 / 37	1501	1875

37" HIGH ELEMENT

Clear Glass (CL)	Frosted Glass (FT)
805	1007
833	1042
886	1108
911	1138
940	1175
1049	1311
1073	1341
1102	1379
1220	1526
1235	1544
1299	1625
1426	1781
1434	1795
1462	1830
1581	1979
1598	1999
1623	2029
1748	2183
1757	2197
1782	2230
1904	2380
1915	2392
1978	2473
2108	2635
2116	2644
2140	2676
2265	2832
2278	2849
2301	2876
2444	3055
2451	3063
2489	3108
2612	3266
2619	3276
2647	3308

Xpress

RYCE

Lateral Stabilizer – Elements

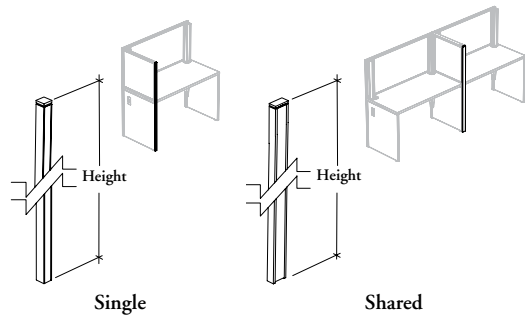

The Lateral Stabilizer – Elements is used to stabilize elements mounted on the side of a desk. It also acts as a finished covering.

WHAT'S INCLUDED

1 aluminum extrusion, 1 finishing cover, 1 end caps, and hardware.

WHAT'S EXCLUDED

Elements.

NOTES

Listed dimensions are nominal. The height of the Lateral Stabilizer – Elements specified must equal the height of the elements onto which it is attached.

Must be installed on all unframed elements.

PRODUCT OPTIONS

Configuration	Height	Finish
S Single	13, 15, 22, 37	Foundation
D Shared		Mica

SAMPLE ORDER CODE

RYCE S	22	E
---------------	-----------	----------

**DIMENSIONS
INCHES / MM**

H
13 / 330
15 / 381
22 / 559
37 / 940

PRICING

SINGLE CONFIGURATION (S)

Foundation	Mica
78	84
84	92
92	97
119	125

SHARED CONFIGURATION (D)

Foundation	Mica
142	152
152	161
169	175
219	226

columns & screens

Xpress

R P S A G

Add-On Screen for Modular Desk – Glass

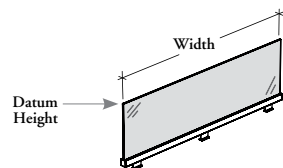

This screen provides central or lateral space division and desktop privacy in no column applications. It provides a lighter, frameless alternative to Framed Elements.

WHAT'S INCLUDED

1 glass screen, support frame, and mounting hardware.

NOTES

Must be used either in back or lateral position between two workstations.

Can be mounted on the top of the junction of two modular desks.

Frosted (FT) is a single-sided etched tempered glass.

All glass finishes are available as Xpress. Please see Xpress catalogue and/or specification software for details.

PRODUCT OPTIONS

Height	Width	Glass Finish	Supporting Frame Finish	Mounting Option
06 (42" high datum line with Shelf-Mounted option (S))	19, 20, 21, 22, 23, 24, 25, 26, 27, 28, 29, 30, 31, 32, 33, 34, 35, 36, 37, 38, 39, 40, 41, 42, 43, 44, 45, 46, 47, 48, 49, 50, 51, 52, 53, 54, 55, 56, 57, 58, 59, 60, 61, 62, 63, 64, 65, 66, 67, 68, 69, 70, 71, 72, 73, 74, 75, 76, 77, 78, 79, 80, 81, 82, 83, 84	CL Clear	Foundation	D Desk-Mounted
07 (Desk-Mounted Shelf Height with Desk-Mounted option (D))		FT Frosted	Mica	
13 (42" high datum line with Desk-Mounted option (D))				
15 (51" high datum line with Shelf-Mounted option (S))				
22 (51" high datum line with Desk-Mounted option (D))				

SAMPLE ORDER CODE

RPSAG 13	51	CL	9	D
-----------------	-----------	-----------	----------	----------

DIMENSIONS INCHES / MM

H	W
6 / 152	21 / 533
6 / 152	24 / 610
6 / 152	27 / 686
6 / 152	30 / 762
6 / 152	33 / 838
6 / 152	36 / 914
6 / 152	39 / 991
6 / 152	42 / 1067
6 / 152	45 / 1143
6 / 152	48 / 1219
6 / 152	51 / 1295
7 / 178	19 / 483
7 / 178	20 / 508
7 / 178	21 / 533
7 / 178	22 / 559
7 / 178	23 / 584
7 / 178	24 / 610
7 / 178	25 / 635
7 / 178	26 / 660
7 / 178	27 / 686
7 / 178	28 / 737
7 / 178	29 / 737
7 / 178	30 / 762
7 / 178	31 / 787
7 / 178	32 / 813

PRICING

Clear (CL)	Frosted (FT)
177	213
187	230
197	240
204	254
217	269
226	284
235	295
244	312
254	322
263	339
274	350
195	247
195	247
195	247
197	252
200	258
203	264
209	270
212	277
216	282
222	288
225	292
227	295
231	304
235	311

DIMENSIONS INCHES / MM

H	W
6 / 152	54 / 1372
6 / 152	57 / 1448
6 / 152	60 / 1524
6 / 152	63 / 1600
6 / 152	66 / 1676
6 / 152	69 / 1753
6 / 152	72 / 1829
6 / 152	75 / 1905
6 / 152	78 / 1981
6 / 152	81 / 2057
6 / 152	84 / 2134
7 / 178	52 / 1321
7 / 178	53 / 1346
7 / 178	54 / 1372
7 / 178	55 / 1397
7 / 178	56 / 1422
7 / 178	57 / 1448
7 / 178	58 / 1473
7 / 178	59 / 1499
7 / 178	60 / 1524
7 / 178	61 / 1549
7 / 178	62 / 1575
7 / 178	63 / 1600
7 / 178	64 / 1626
7 / 178	65 / 1651

PRICING

Clear (CL)	Frosted (FT)
283	367
291	377
299	396
316	406
328	420
345	435
360	449
371	462
385	478
399	490
413	509
306	419
309	426
313	429
317	435
319	440
321	447
324	452
328	457
332	464
339	470
347	477
350	484
355	490
364	495

Pricing is continued on the following page.

R P S A G

Add-On Screen for Modular Desk – Glass (Continued)

DIMENSIONS INCHES / MM		PRICING		DIMENSIONS INCHES / MM		PRICING	
H	W	Clear (CL)	Frosted (FT)	H	W	Clear (CL)	Frosted (FT)
7 / 178	33 / 838	238	316	7 / 178	66 / 1676	368	501
7 / 178	34 / 864	240	320	7 / 178	67 / 1702	374	510
7 / 178	35 / 889	244	324	7 / 178	68 / 1727	377	516
7 / 178	36 / 914	247	331	7 / 178	69 / 1753	383	522
7 / 178	37 / 940	252	339	7 / 178	70 / 1778	393	528
7 / 178	38 / 965	255	345	7 / 178	71 / 1803	397	536
7 / 178	39 / 991	258	348	7 / 178	72 / 1829	400	542
7 / 178	40 / 1016	263	353	7 / 178	73 / 1854	406	549
7 / 178	41 / 1041	268	360	7 / 178	74 / 1880	412	554
7 / 178	42 / 1067	270	364	7 / 178	75 / 1905	416	563
7 / 178	43 / 1092	274	370	7 / 178	76 / 1390	425	568
7 / 178	44 / 1118	277	374	7 / 178	77 / 1956	428	575
7 / 178	45 / 1143	280	379	7 / 178	78 / 1981	432	582
7 / 178	46 / 1168	284	389	7 / 178	79 / 2007	440	589
7 / 178	47 / 1194	288	394	7 / 178	80 / 2032	445	596
7 / 178	48 / 1219	290	398	7 / 178	81 / 2057	449	601
7 / 178	49 / 1245	293	401	7 / 178	82 / 2083	456	608
7 / 178	50 / 1270	298	406	7 / 178	83 / 2108	462	614
7 / 178	51 / 1295	303	412	7 / 178	84 / 2134	467	622
13 / 330	19 / 483	200	268	13 / 330	52 / 1321	333	481
13 / 330	20 / 508	203	274	13 / 330	53 / 1346	338	486
13 / 330	21 / 533	209	280	13 / 330	54 / 1372	340	492
13 / 330	22 / 559	212	288	13 / 330	55 / 1397	347	498
13 / 330	23 / 584	217	292	13 / 330	56 / 1422	349	509
13 / 330	24 / 610	224	297	13 / 330	57 / 1448	351	515
13 / 330	25 / 635	226	306	13 / 330	58 / 1473	360	520
13 / 330	26 / 660	229	313	13 / 330	59 / 1499	362	524
13 / 330	27 / 686	232	320	13 / 330	60 / 1524	365	532
13 / 330	28 / 737	237	324	13 / 330	61 / 1549	371	539
13 / 330	29 / 737	240	331	13 / 330	62 / 1575	377	549
13 / 330	30 / 762	245	340	13 / 330	63 / 1600	383	559
13 / 330	31 / 787	248	346	13 / 330	64 / 1626	393	567
13 / 330	32 / 813	252	350	13 / 330	65 / 1651	398	573
13 / 330	33 / 838	256	360	13 / 330	66 / 1676	405	585
13 / 330	34 / 864	260	365	13 / 330	67 / 1702	409	592
13 / 330	35 / 889	267	370	13 / 330	68 / 1727	416	601
13 / 330	36 / 914	270	376	13 / 330	69 / 1753	425	608
13 / 330	37 / 940	274	383	13 / 330	70 / 1778	428	617
13 / 330	38 / 965	277	390	13 / 330	71 / 1803	434	628
13 / 330	39 / 991	283	399	13 / 330	72 / 1829	441	635
13 / 330	40 / 1016	287	403	13 / 330	73 / 1854	447	641
13 / 330	41 / 1041	289	408	13 / 330	74 / 1880	456	650
13 / 330	42 / 1067	292	416	13 / 330	75 / 1905	462	661
13 / 330	43 / 1092	296	423	13 / 330	76 / 1390	469	668
13 / 330	44 / 1118	299	428	13 / 330	77 / 1956	473	676
13 / 330	45 / 1143	304	436	13 / 330	78 / 1981	478	687
13 / 330	46 / 1168	311	441	13 / 330	79 / 2007	487	695
13 / 330	47 / 1194	314	448	13 / 330	80 / 2032	491	701
13 / 330	48 / 1219	317	455	13 / 330	81 / 2057	499	712
13 / 330	49 / 1245	320	461	13 / 330	82 / 2083	509	720
13 / 330	50 / 1270	324	467	13 / 330	83 / 2108	513	726
13 / 330	51 / 1295	328	476	13 / 330	84 / 2134	519	737

Pricing is continued on the following page.

R P S A G

Add-On Screen for Modular Desk – Glass (Continued)

DIMENSIONS INCHES / MM		PRICING		DIMENSIONS INCHES / MM		PRICING	
H	W	Clear (CL)	Frostd (FT)	H	W	Clear (CL)	Frosted (FT)
15 / 381	21 / 533	220	297	15 / 381	54 / 1372	360	528
15 / 381	24 / 610	230	320	15 / 381	57 / 1448	371	550
15 / 381	27 / 686	244	341	15 / 381	60 / 1524	383	572
15 / 381	30 / 762	255	362	15 / 381	63 / 1600	405	601
15 / 381	33 / 838	269	379	15 / 381	66 / 1676	426	630
15 / 381	36 / 914	283	404	15 / 381	69 / 1753	445	660
15 / 381	39 / 991	292	426	15 / 381	72 / 1829	467	688
15 / 381	42 / 1067	307	447	15 / 381	75 / 1905	487	716
15 / 381	45 / 1143	319	467	15 / 381	78 / 1981	510	747
15 / 381	48 / 1219	332	487	15 / 381	81 / 2057	528	775
15 / 381	51 / 1295	347	510	15 / 381	84 / 2134	550	803
22 / 559	19 / 483	239	347	22 / 559	52 / 1321	406	640
22 / 559	20 / 508	244	355	22 / 559	53 / 1346	412	647
22 / 559	21 / 533	248	365	22 / 559	54 / 1372	416	659
22 / 559	22 / 559	254	372	22 / 559	55 / 1397	423	667
22 / 559	23 / 584	256	379	22 / 559	56 / 1422	427	674
22 / 559	24 / 610	263	393	22 / 559	57 / 1448	430	686
22 / 559	25 / 635	269	401	22 / 559	58 / 1473	437	695
22 / 559	26 / 660	274	408	22 / 559	59 / 1499	441	701
22 / 559	27 / 686	278	418	22 / 559	60 / 1524	447	712
22 / 559	28 / 737	284	427	22 / 559	61 / 1549	457	723
22 / 559	29 / 737	289	436	22 / 559	62 / 1575	465	738
22 / 559	30 / 762	292	445	22 / 559	63 / 1600	473	751
22 / 559	31 / 787	298	454	22 / 559	64 / 1626	484	766
22 / 559	32 / 813	304	462	22 / 559	65 / 1651	490	777
22 / 559	33 / 838	311	473	22 / 559	66 / 1676	499	791
22 / 559	34 / 864	316	481	22 / 559	67 / 1702	510	806
22 / 559	35 / 889	319	488	22 / 559	68 / 1727	517	819
22 / 559	36 / 914	324	496	22 / 559	69 / 1753	523	832
22 / 559	37 / 940	331	510	22 / 559	70 / 1778	534	846
22 / 559	38 / 965	336	517	22 / 559	71 / 1803	542	860
22 / 559	39 / 991	340	523	22 / 559	72 / 1829	551	871
22 / 559	40 / 1016	347	532	22 / 559	73 / 1854	560	886
22 / 559	41 / 1041	350	542	22 / 559	74 / 1880	568	899
22 / 559	42 / 1067	354	550	22 / 559	75 / 1905	577	913
22 / 559	43 / 1092	362	560	22 / 559	76 / 1930	586	928
22 / 559	44 / 1118	367	568	22 / 559	77 / 1956	596	940
22 / 559	45 / 1143	371	577	22 / 559	78 / 1981	602	955
22 / 559	46 / 1168	376	588	22 / 559	79 / 2007	610	966
22 / 559	47 / 1194	379	596	22 / 559	80 / 2032	618	981
22 / 559	48 / 1219	387	603	22 / 559	81 / 2057	630	994
22 / 559	49 / 1245	394	611	22 / 559	82 / 2083	638	1008
22 / 559	50 / 1270	397	622	22 / 559	83 / 2108	646	1020
22 / 559	51 / 1295	400	632	22 / 559	84 / 2134	652	1036

columns & screens

Xpress

RCSBLN

Central Screen for Spine Desk – Solid

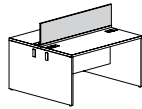
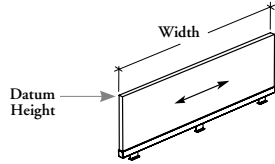

Spine Desk-Mounted (D)

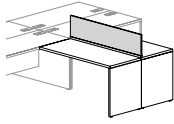

Worksurface-Mounted (W)

This screen provides central space division and desktop privacy in Spine Desk applications.

WHAT'S INCLUDED

1 solid screen, support frame, and mounting hardware.

NOTES

The laminate panel is 11/16" thick.

Must be used in back position between two workstations.

Can be mounted on the top of:

- The junction of two Single-Sided Spine Desks in back-to-back position or between two worksurfaces on a Shared Spine Desk
- The junction of two Rectangular Worksurfaces in back-to-back position (RTLDL and RTLDC)

PRODUCT OPTIONS

Mounting Option	Height	Width	Supporting Frame Finish	Screen Finish
D Spine Desk-Mounted	13 (42" high datum line with Desk-Mounted option (D or W))	21, 24, 27, 30, 33, 36, 39, 42, 45, 48, 51, 54, 57, 60, 63, 66, 69, 72, 75, 78, 81, 84	Foundation Mica	Source Laminate
W Worksurface-Mounted				

SAMPLE ORDER CODE

RCSBLN D	13	51	7	XS
-----------------	-----------	-----------	----------	-----------

**DIMENSIONS
INCHES / MM**

W
21 / 533
24 / 610
27 / 686
30 / 762
33 / 838
36 / 914
39 / 991
42 / 1067
45 / 1143
48 / 1219
51 / 1295
54 / 1372
57 / 1448
60 / 1524
63 / 1600
66 / 1676
69 / 1753
72 / 1829
75 / 1905
78 / 1981
81 / 2057
84 / 2134

PRICING

SPINE DESK MOUNTED (D) OR WORKSURFACE MOUNTED (W)	
Height (13)	Height (22)
203	235
217	248
227	262
238	280
248	290
258	304
269	319
283	331
292	347
303	362
314	375
336	393
347	405
355	416
365	428
372	441
379	454
393	466
401	476
409	488
419	501
428	514

columns & screens

Xpress

RCSLLN

Lateral Screen for Spine Desk – Solid

This screen provides lateral space division and desktop privacy in Spine Desk applications.

WHAT'S INCLUDED

1 solid screen, support frame, and mounting hardware.

NOTES

The laminate panel is 11/16" thick.

Must be used in lateral position between two workstations.

Can be mounted on the top of the junction of two Single-Sided or Shared Spine Desks in side-by-side position.

The mounting option (M) is only compatible with Elevated Desktop Cabinets.

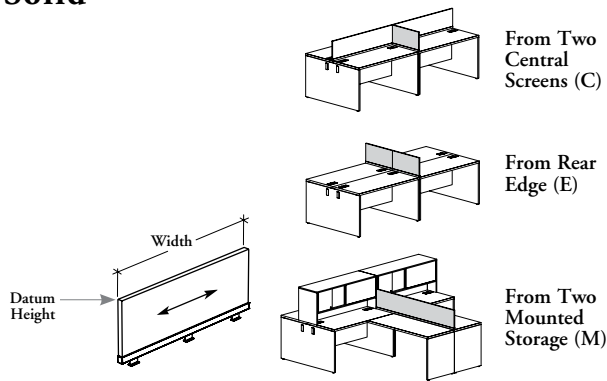

PRODUCT OPTIONS

Mounting Option	Height	Width	Supporting Frame Finish	Screen Finish
C From Two Central Screens	13 (42" high datum line)	From Two Central Screens (C): 20, 23, 26, 29, 47, 50, 53, 56, 59, 62, 65, 68, 71, 74, 77, 80, 83 From Rear Edge (E): 21, 24, 27, 30, 48, 51, 54, 57, 60, 63, 66, 69, 72, 75, 78, 81, 84 From Two Mounted Storage (M): 32, 35, 38, 40, 41, 43, 44, 46, 47, 49, 50, 52, 53, 55, 56, 58, 59, 61, 62, 64, 65, 67, 68, 70, 73, 76	Foundation	Source Laminate
E From Rear Edge	22 (51" high datum line)		Mica	
M From Two Mounted Storage				

SAMPLE ORDER CODE

RCSLLN C	22	74	7	XS
-----------------	-----------	-----------	----------	-----------

**DIMENSIONS
INCHES / MM**

W
20 / 508
23 / 584
26 / 660
29 / 737
47 / 1194
50 / 1270
53 / 1346
56 / 1422
59 / 1499
62 / 1575
65 / 1651
68 / 1727
71 / 1803
74 / 1880
77 / 1956
80 / 2032
83 / 2108

PRICING

FROM TWO CENTRAL SCREENS (C)	
Height (13)	Height (22)
201	244
212	244
224	256
235	269
297	356
309	370
320	385
345	401
351	413
362	425
370	435
377	451
389	461
400	471
408	486
416	496
426	512

Pricing is continued on the following page.

RCSLLN
Lateral Screen for Spine Desk –
Solid (Continued)

DIMENSIONS
INCHES / MM

W
21 / 533
24 / 610
27 / 686
30 / 762
48 / 1219
51 / 1295
54 / 1372
57 / 1448
60 / 1524
63 / 1600
66 / 1676
69 / 1753
72 / 1829
75 / 1905
78 / 1981
81 / 2057
84 / 2134

PRICING

FROM REAR EDGE (E)		
	Height (13)	Height (22)
	203	235
	217	248
	227	262
	238	280
	303	362
	n/a	375
	336	393
	347	405
	355	416
	365	428
	372	441
	379	454
	393	466
	401	476
	409	488
	419	501
	428	514

FROM TWO MOUNTED STORAGE (M)		
	Height (13)	Height (22)
	245	287
	254	298
	264	316
	275	322
	280	326
	284	340
	289	345
	295	350
	297	356
	306	367
	309	370
	317	378
	320	385
	340	399
	345	401
	348	408
	351	413
	356	419
	362	425
	368	432
	370	435
	375	447
	377	451
	385	457
	398	469
	405	481

RCSBG

Central Screen for Spine Desk – Glass

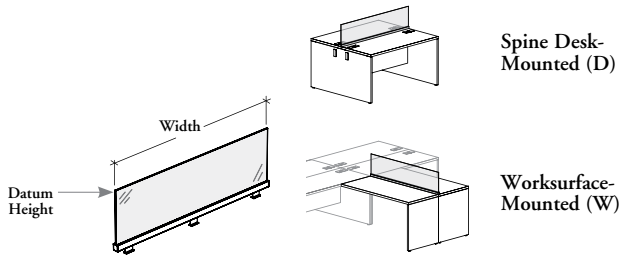

This screen provides central space division and desktop privacy in Spine Desk applications. It provides a lighter, frameless alternative to Framed Screens for Spine Desk.

WHAT'S INCLUDED

1 glass screen, support frame, and mounting hardware.

NOTES

Must be used in back position between two workstations.

Can be mounted on the top of:

- The junction of two Single-Sided Spine Desks in back-to-back position or between two worksurfaces on a Shared Spine Desk
- The junction of two Rectangular Worksurfaces in back-to-back position (RTLDL and RTLDC)

Frosted (FT) is a single-sided etched tempered glass.

All glass finishes are available as Xpress. Please see Xpress catalogue and/or specification software for details.

PRODUCT OPTIONS

Mounting Option	Height	Width	Glass Finish	Supporting Frame Finish
D Desk-Mounted W Worksurface-Mounted	07 (Desk-Mounted Shelf Height with Desk-Mounted option (D or W)) 13 (42" high datum line with Desk-Mounted option (D or W)) 22 (51" high datum line with Desk-Mounted option (D or W))	21, 24, 27, 30, 33, 36, 39, 42, 45, 48, 51, 54, 57, 60, 63, 66, 69, 72, 75, 78, 81, 84	CL Clear FT Frosted	Foundation Mica

SAMPLE ORDER CODE

RCSBG D	13	51	CL	7
----------------	-----------	-----------	-----------	----------

DIMENSIONS INCHES / MM

W
21 / 533
24 / 610
27 / 686
30 / 762
33 / 838
36 / 914
39 / 991
42 / 1067
45 / 1143
48 / 1219
51 / 1295
54 / 1372
57 / 1448
60 / 1524
63 / 1600
66 / 1676
69 / 1753
72 / 1829
75 / 1905
78 / 1981
81 / 2057
84 / 2134

PRICING

DESK-MOUNTED (D) OR WORKSURFACE-MOUNTED (W)

HEIGHT (07)	HEIGHT (13)		HEIGHT (22)		
	Clear (CL)	Frosted (FT)	Clear (CL)	Frosted (FT)	
195	247	209	280	248	365
203	264	224	297	263	393
216	282	232	320	278	418
227	295	245	340	292	445
238	316	256	360	311	473
247	331	270	376	324	496
258	348	283	399	340	523
270	364	292	416	354	550
280	379	304	436	371	577
290	398	317	455	387	603
303	412	328	476	400	632
313	429	340	492	416	659
321	447	351	515	430	686
332	464	365	532	447	712
350	484	383	559	473	751
368	501	405	585	499	791
383	522	425	608	523	832
400	542	441	635	551	871
416	563	462	661	577	913
432	582	478	687	602	955
449	601	499	712	630	994
467	622	519	737	652	1036

columns & screens

Xpress

RCSLG

Lateral Screen for Spine Desk – Glass

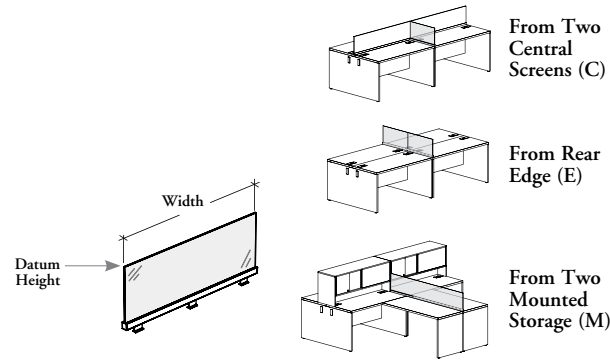

This screen provides lateral space division and desktop privacy in Spine Desk applications.

WHAT'S INCLUDED

1 glass screen, support frame, and mounting hardware.

NOTES

Must be used in lateral position between two workstations.

Can be mounted on the top of the junction of two Single-Sided or Shared Spine Desks in side-by-side position.

The mounting option (M) is only compatible Elevated Desktop Cabinets.

Frosted (FT) is a single-sided etched tempered glass.

All glass finishes are available as Xpress. Please see Xpress catalogue and/or specification software for details.

PRODUCT OPTIONS

Mounting Option	Height	Width	Glass Finish	Supporting Frame Finish
C From Two Central Screens	07 (Desk-Mounted Shelf Height)	From Two Central Screens (C): 20, 23, 26, 29, 47, 50, 53, 56, 59, 62, 65, 68, 71, 74, 77, 80, 83 From Rear Edge (E): 21, 24, 27, 30, 48, 51, 54, 57, 60, 63, 66, 69, 72, 75, 78, 81, 84 From Two Mounted Storage (M): 32, 35, 38, 40, 41, 43, 44, 46, 47, 49, 50, 52, 53, 55, 56, 58, 59, 61, 62, 64, 65, 67, 68, 70, 73, 76	CL Clear	Foundation Mica
E From Rear Edge	13 (42" high datum line)		FT Frosted	
M From Two Mounted Storage	22 (51" high datum line)			

SAMPLE ORDER CODE

RCSLG C	13	74	FT	XS
----------------	-----------	-----------	-----------	-----------

**DIMENSIONS
INCHES / MM**

W
20 / 508
23 / 584
26 / 660
29 / 737
47 / 1194
50 / 1270
53 / 1346
56 / 1422
59 / 1499
62 / 1575
65 / 1651
68 / 1727
71 / 1803
74 / 1880
77 / 1956
80 / 2032
83 / 2108

PRICING

FROM TWO CENTRAL SCREENS (C)						
W	HEIGHT (07)		HEIGHT (13)		HEIGHT (22)	
	Clear (CL)	Frosted (FT)	Clear (CL)	Frosted (FT)	Clear (CL)	Frosted (FT)
20	195	247	203	274	244	355
23	200	258	217	292	256	379
26	212	277	229	313	274	408
29	225	292	240	331	289	436
47	288	394	314	448	379	596
50	298	406	324	467	397	622
53	309	426	338	486	412	647
56	319	440	349	509	427	674
59	328	457	362	524	441	701
62	347	477	377	549	465	738
65	364	495	398	573	490	777
68	377	516	416	601	517	819
71	397	536	434	628	542	860
74	412	554	456	650	568	899
77	428	575	473	676	596	940
80	445	596	491	701	618	981
83	462	614	513	726	646	1020

Pricing is continued on the following page.

RCSLG
Lateral Screen for Spine Desk –
Glass (Continued)

DIMENSIONS
INCHES / MM

PRICING

W	FROM REAR EDGE (E)					
	HEIGHT (07)		HEIGHT (13)		HEIGHT (22)	
	Clear (CL)	Frosted (FT)	Clear (CL)	Frosted (FT)	Clear (CL)	Frosted (FT)
21 / 533	195	247	209	280	248	365
24 / 610	203	264	224	297	263	393
27 / 686	216	282	232	320	278	418
30 / 762	227	295	245	340	292	445
48 / 1219	290	398	317	455	387	603
51 / 1295	303	412	328	476	400	632
54 / 1372	313	429	340	492	416	659
57 / 1448	321	447	351	515	430	686
60 / 1524	332	464	365	532	447	712
63 / 1600	350	484	383	559	473	751
66 / 1676	368	501	405	585	499	791
69 / 1753	383	522	425	608	523	832
72 / 1829	400	542	441	635	551	871
75 / 1905	416	563	462	661	577	913
78 / 1981	432	582	478	687	602	955
81 / 2057	449	601	499	712	630	994
84 / 2134	467	622	519	737	652	1036

	FROM TWO MOUNTED STORAGE (M)					
	HEIGHT (07)		HEIGHT (13)		HEIGHT (22)	
	Clear (CL)	Frosted (FT)	Clear (CL)	Frosted (FT)	Clear (CL)	Frosted (FT)
32 / 813	235	311	252	350	304	462
35 / 889	244	324	267	370	319	488
38 / 965	255	345	277	390	336	517
40 / 1016	263	353	287	403	347	532
41 / 1041	268	360	289	408	350	542
43 / 1092	274	370	296	423	362	560
44 / 1118	277	374	299	428	367	568
46 / 1168	284	389	311	441	376	588
47 / 1194	288	394	314	448	379	596
49 / 1245	293	401	320	461	394	611
50 / 1270	298	406	324	467	397	622
52 / 1321	306	419	333	481	406	640
53 / 1346	309	426	338	486	412	647
55 / 1397	317	435	347	498	423	667
56 / 1422	319	440	349	509	427	674
58 / 1473	324	452	360	520	437	695
59 / 1499	328	457	362	524	441	701
61 / 1549	339	470	371	539	457	723
62 / 1575	347	477	377	549	465	738
64 / 1626	355	490	393	567	484	766
65 / 1651	364	495	398	573	490	777
67 / 1702	374	510	409	592	510	806
68 / 1727	377	516	416	601	517	819
70 / 1778	393	528	428	617	534	846
73 / 1854	406	549	447	641	560	886
76 / 1390	425	568	469	668	586	928

columns & screens

Xpress

R C F B F

Central Framed Screen for Spine Desk – Fabric

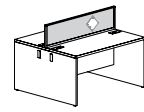
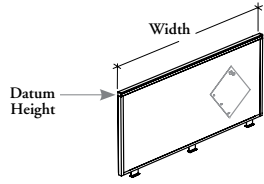

Spine Desk-Mounted (D)

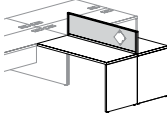

Worksurface-Mounted (W)

This screen provides central space division, desktop privacy and vertical tackable surface in Spine Desk.

WHAT'S INCLUDED

2 fabric infills, extrusions, and mounting hardware.

NOTES

All fabric screens have the same fabric on both sides.

Must be used in back position between two workstations.

Can be mounted on the top of:

- The junction of two Single-Sided Spine Desks in back-to-back position or between two worksurfaces on a Shared Spine Desk
- The junction of two Rectangular Worksurfaces in back-to-back position (RTL DL and RTL DC)

PRODUCT OPTIONS

Mounting Option	Height	Width	Frame Finish	Infill Finish
D Desk-Mounted W Worksurface-Mounted	13 (42" high datum line with Desk-Mounted option (D or W)) 22 (51" high datum line with Desk-Mounted option (D or W))	21, 24, 27, 30, 33, 36, 39, 42, 45, 48, 51, 54, 57, 60, 63, 66, 69, 72, 75, 78, 81, 84	Foundation Mica	Fabric

SAMPLE ORDER CODE

RCFBF W	13	51	E	C502
----------------	-----------	-----------	----------	-------------

**DIMENSIONS
INCHES / MM**

W
21 / 533
24 / 610
27 / 686
30 / 762
33 / 838
36 / 914
39 / 991
42 / 1067
45 / 1143
48 / 1219
51 / 1295
54 / 1372
57 / 1448
60 / 1524
63 / 1600
66 / 1676
69 / 1753
72 / 1829
75 / 1905
78 / 1981
81 / 2057
84 / 2134

PRICING

DESK-MOUNTED (D)/WORKSURFACE-MOUNTED (W)															
HEIGHT (13)								HEIGHT (22)							
A/COM	Gr. 1	Gr. 2	Gr. 3	Gr. 4	Gr. 5	Gr. 6	Gr. 7	A/COM	Gr. 1	Gr. 2	Gr. 3	Gr. 4	Gr. 5	Gr. 6	Gr. 7
319	332	348	364	396	427	452	476	354	371	394	411	449	488	521	551
328	341	356	372	404	435	461	486	365	379	404	420	461	498	532	565
339	349	369	385	419	455	480	505	376	394	418	437	481	524	557	589
346	360	377	398	433	471	498	527	390	404	429	454	501	549	586	622
351	368	390	403	438	474	501	529	401	416	445	466	516	567	602	638
360	375	400	418	461	501	536	570	408	428	461	487	546	604	648	691
370	385	408	432	481	528	563	594	423	438	470	496	554	614	659	699
377	394	419	440	487	534	571	604	428	451	485	512	570	629	674	719
387	403	429	454	503	551	589	625	438	464	495	524	586	648	695	741
394	411	438	464	516	570	609	648	448	473	510	538	602	668	719	768
403	419	448	471	524	577	617	658	461	486	520	550	614	681	731	781
454	471	505	529	590	648	693	734	517	541	579	611	686	757	812	868
461	481	515	544	606	666	710	752	525	551	594	630	705	782	838	891
467	488	523	552	617	684	732	780	535	565	608	643	723	805	864	925
474	496	532	565	631	696	746	792	548	574	619	658	741	822	884	944
484	509	542	573	639	706	756	806	557	588	635	670	755	839	904	967
492	516	551	586	655	723	774	825	571	599	648	689	777	867	930	995
501	524	564	597	669	742	796	849	582	609	661	701	795	890	960	1029
512	532	572	608	684	760	813	869	592	619	674	717	811	907	974	1044
516	542	579	616	693	767	825	883	600	633	687	731	828	925	999	1072
523	550	592	629	704	781	839	896	610	643	698	744	842	942	1015	1089
529	559	601	638	717	793	854	915	618	657	713	757	860	958	1037	1114

columns & screens

Xpress

RCFLF

Lateral Framed Screen for Spine Desk – Fabric

This screen provides lateral space division, desktop privacy and vertical tackable surface in Spine Desk applications.

WHAT'S INCLUDED

2 fabric infills, extrusions, and mounting hardware.

NOTES

All fabric screens have the same fabric on both sides.

Must be used in lateral position between two workstations.

Can be mounted on the top of the junction of two Single-Sided or Shared Spine Desks in side-by-side position.

The mounting option (M) is only compatible with Elevated Desktop Cabinets.

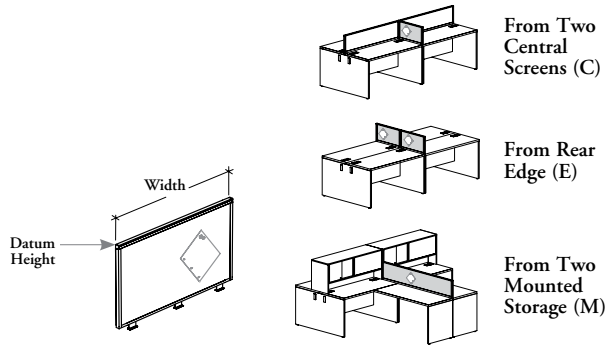

PRODUCT OPTIONS

Mounting Option	Height	Width	Frame Finish	Infill Finish
C From Two Central Screens	13 (42" high datum line)	From Two Central Screens (C): 20, 23, 26, 29, 47, 50, 53, 56, 59, 62, 65, 68, 71, 74, 77, 80, 83 From Rear Edge (E): 21, 24, 27, 30, 48, 51, 54, 57, 60, 63, 66, 69, 72, 75, 78, 81, 84 From Two Mounted Storage (M): 32, 35, 38, 40, 41, 43, 44, 46, 47, 49, 50, 52, 53, 55, 56, 58, 59, 61, 62, 64, 65, 67, 68, 70, 73, 76	Foundation	Fabric
E From Rear Edge	22 (51" high datum line)		Mica	
M From Two Mounted Storage				

SAMPLE ORDER CODE

RCFLF C	22	74	E	C502
----------------	-----------	-----------	----------	-------------

**DIMENSIONS
INCHES / MM**

W
20 / 508
23 / 584
26 / 660
29 / 737
47 / 1194
50 / 1270
53 / 1346
56 / 1422
59 / 1499
62 / 1575
65 / 1651
68 / 1727
71 / 1803
74 / 1880
77 / 1956
80 / 2032
83 / 2108

PRICING

FROM TWO CENTRAL SCREENS (C)

HEIGHT (13)									HEIGHT (22)							
A/ COM	Gr. 1	Gr. 2	Gr. 3	Gr. 4	Gr. 5	Gr. 6	Gr. 7		A/ COM	Gr. 1	Gr. 2	Gr. 3	Gr. 4	Gr. 5	Gr. 6	Gr. 7
317	328	346	356	385	414	437	461		351	368	389	403	438	474	509	538
327	339	350	370	401	432	457	481		362	377	403	419	461	499	534	565
338	347	364	379	416	451	474	496		374	390	414	434	480	524	554	588
345	355	374	394	430	469	495	524		389	401	427	449	498	546	580	616
393	406	438	464	519	574	612	652		448	470	510	538	607	674	724	774
399	416	445	469	522	574	612	652		461	481	519	548	612	681	731	780
405	426	457	484	541	597	639	683		471	492	532	565	635	706	761	813
459	477	512	541	601	662	706	748		520	548	589	622	698	774	828	882
467	487	519	549	610	672	718	763		532	559	600	636	709	785	843	900
473	493	528	559	625	690	734	780		544	572	614	651	732	811	870	928
477	505	538	570	633	697	749	797		552	582	632	668	754	839	904	966
490	514	550	579	648	717	767	818		568	594	646	687	778	870	935	998
499	522	560	593	662	734	789	841		573	607	657	694	781	869	937	1007
510	529	572	602	675	748	803	855		586	616	670	713	807	900	970	1041
515	538	579	612	690	764	821	879		597	630	686	727	828	928	1003	1076
522	548	592	628	704	782	840	896		608	640	696	742	842	944	1017	1090
528	554	600	637	717	795	855	915		616	651	708	756	861	963	1041	1118

Pricing is continued on the following page.

R C F L F

Lateral Framed Screen for Spine Desk – Fabric (Continued)

**DIMENSIONS
INCHES / MM**

W
21 / 533
24 / 610
27 / 686
30 / 762
48 / 1219
51 / 1295
54 / 1372
57 / 1448
60 / 1524
63 / 1600
66 / 1676
69 / 1753
72 / 1829
75 / 1905
78 / 1981
81 / 2057
84 / 2134

PRICING

FROM REAR EDGE (E)															
HEIGHT (13)								HEIGHT (22)							
A/ COM	Gr. 1	Gr. 2	Gr. 3	Gr. 4	Gr. 5	Gr. 6	Gr. 7	A/ COM	Gr. 1	Gr. 2	Gr. 3	Gr. 4	Gr. 5	Gr. 6	Gr. 7
319	332	348	364	396	427	452	476	354	371	394	411	449	488	521	551
328	341	356	372	404	435	461	486	365	379	404	420	461	498	532	565
339	349	369	385	419	455	480	505	376	394	418	437	481	524	557	589
346	360	377	398	433	471	498	527	390	404	429	454	501	549	586	622
394	411	438	464	516	570	609	648	448	473	510	538	602	668	719	768
403	419	448	471	524	577	617	658	461	486	520	550	614	681	731	781
454	471	505	529	590	648	693	734	517	541	579	611	686	757	812	868
461	481	515	544	606	666	710	752	525	551	594	630	705	782	838	891
467	488	523	552	617	684	732	780	535	565	608	643	723	805	864	925
474	496	532	565	631	696	746	792	548	574	619	658	741	822	884	944
484	509	542	573	639	706	756	806	557	588	635	670	755	839	904	967
492	516	551	586	655	723	774	825	571	599	648	689	777	867	930	995
501	524	564	597	669	742	796	849	582	609	661	701	795	890	960	1029
512	532	572	608	684	760	813	869	592	619	674	717	811	907	974	1044
516	542	579	616	693	767	825	883	600	633	687	731	828	925	999	1072
523	550	592	629	704	781	839	896	610	643	698	744	842	942	1015	1089
529	559	601	638	717	793	854	915	618	657	713	757	860	958	1037	1114

FROM TWO MOUNTED STORAGE (M)															
HEIGHT (13)								HEIGHT (22)							
A/ COM	Gr. 1	Gr. 2	Gr. 3	Gr. 4	Gr. 5	Gr. 6	Gr. 7	A/ COM	Gr. 1	Gr. 2	Gr. 3	Gr. 4	Gr. 5	Gr. 6	Gr. 7
351	364	390	403	441	481	514	542	399	413	441	464	513	564	602	640
360	372	398	413	456	493	524	553	406	425	454	476	529	582	622	661
365	379	404	425	465	510	539	571	416	435	464	490	545	599	638	676
371	389	412	432	477	523	559	593	425	442	471	501	560	618	665	709
374	391	414	435	481	525	563	597	427	447	485	510	571	633	677	723
378	398	420	441	487	532	568	602	432	456	490	516	577	637	684	727
385	400	428	449	499	549	586	619	438	459	496	524	592	658	704	749
391	405	434	456	506	553	593	632	445	466	505	532	599	665	715	762
393	406	438	464	519	572	610	650	448	470	510	538	607	674	724	774
396	413	441	466	520	573	611	651	454	477	515	545	610	676	726	776
399	416	445	469	522	574	612	652	461	481	519	548	612	681	731	780
404	423	451	474	527	579	619	660	464	488	525	554	625	693	746	796
405	426	457	484	541	597	639	683	471	492	532	565	635	706	761	813
455	474	509	536	599	660	701	746	520	548	589	622	698	774	828	882
459	477	512	541	601	662	706	748	523	550	592	628	701	776	832	884
465	485	516	545	606	665	709	752	528	554	597	633	706	782	841	898
467	487	519	549	610	672	718	763	532	559	600	636	709	785	843	900
470	491	523	552	614	676	722	767	538	568	609	646	723	803	862	920
473	493	528	559	625	690	734	780	544	572	614	651	732	811	870	928
476	499	534	565	629	691	741	790	550	578	629	665	751	836	899	964
477	505	538	570	633	697	749	797	552	582	632	668	754	839	904	966
485	512	545	575	641	709	760	809	559	590	638	676	764	850	918	981
490	514	550	579	648	717	767	818	568	594	646	687	778	870	935	998
495	519	554	590	660	732	785	838	573	601	652	695	786	882	950	1017
505	527	568	599	669	741	793	846	582	612	666	709	804	898	967	1037
513	535	575	608	679	752	809	863	592	625	677	720	818	913	986	1057

columns & screens

Xpress

RCFBG

Central Framed Screen for Spine Desk – Glass

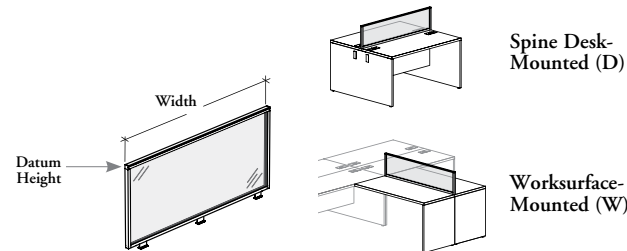

This screen provides central space division, desktop privacy and vertical writable surface in Spine Desk applications.

WHAT'S INCLUDED

2 glass infills, extrusions, and mounting hardware.

NOTES

Use only dry-erase markers with this board.

Tempered glass infills are doubled for a flush look.

Frosted (FT) is a single-sided etched glass which is facing inward of the screen assembly.

Must be used in back position between two workstations.

Can be mounted on the top of:

- The junction of two Single-Sided Spine Desks in back-to-back position or between two worksurfaces on a Shared Spine Desk
- The junction of two Rectangular Worksurfaces in back-to-back position (RTLDL and RTLDC)

Not all glass finishes are available as Xpress, Please see Xpress catalogue and/or specification software for details.

PRODUCT OPTIONS

Mounting Option	Height	Width	Frame Finish	Glass Finish
D Desk-Mounted	13 (42" high datum line with Desk-Mounted option (D or W))	21, 24, 27, 30, 33, 36, 39, 42, 45, 48, 51, 54, 57, 60, 63, 66, 69, 72, 75, 78, 81, 84	Foundation Mica	Standard Glass: FT Frosted Back-Painted Glass
W Worksurface-Mounted				

SAMPLE ORDER CODE

RCFBG D	13	51	E	FT
----------------	-----------	-----------	----------	-----------

DIMENSIONS INCHES / MM

W
21 / 533
24 / 610
27 / 686
30 / 762
33 / 838
36 / 914
39 / 991
42 / 1067
45 / 1143
48 / 1219
51 / 1295
54 / 1372
57 / 1448
60 / 1524
63 / 1600
66 / 1676
69 / 1753
72 / 1829
75 / 1905
78 / 1981
81 / 2057
84 / 2134

PRICING

DESK-MOUNTED (D) OR WORKSURFACE-MOUNTED (W)

	Height (13)	Height (22)
	427	515
	429	560
	437	608
	457	654
	486	698
	515	747
	544	792
	572	839
	600	887
	630	933
	658	980
	734	1073
	763	1121
	792	1167
	821	1213
	849	1257
	879	1305
	908	1353
	937	1400
	964	1448
	994	1491
	1022	1538

columns & screens

Xpress

RCFLG

Lateral Framed Screen for Spine Desk – Glass

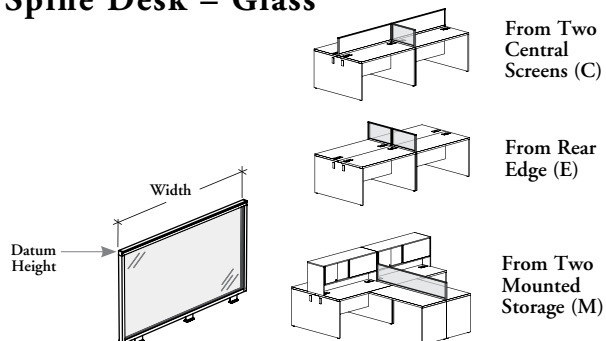

This screen provides lateral space division, desktop privacy and vertical writable surface in Spine Desk applications.

WHAT'S INCLUDED

2 glass infills, extrusions, and mounting hardware.

NOTES

Use only dry-erase markers with this board.

Tempered glass are doubled for a flush look.

Frosted (FT) is a single-sided etched glass which is facing inward of the screen assembly.

Must be used in lateral position between two workstations.

Can be mounted on the top of the junction of two Single-Sided or Shared Spine Desks in side-by-side position.

The mounting option (M) is only available with Elevated Desktop Cabinet.

Not all glass finishes are available as Xpress, Please see Xpress catalogue and/or specification software for details.

PRODUCT OPTIONS

Mounting Option	Height	Width	Frame Finish	Glass Finish
C From Two Central Screens	13 (42" high datum line)	From Two Central Screens (C): 20, 23, 26, 29, 47, 50, 53, 56, 59, 62, 65, 68, 71, 74, 77, 80, 83 From Rear Edge (E): 21, 24, 27, 30, 48, 51, 54, 57, 60, 63, 66, 69, 72, 75, 78, 81, 84 From Two Mounted Storage (M): 32, 35, 38, 40, 41, 43, 44, 46, 47, 49, 50, 52, 53, 55, 56, 58, 59, 61, 62, 64, 65, 67, 68, 70, 73, 76	Foundation Mica	Standard Glass: FT Frosted Back-Painted Glass
E From Rear Edge	22 (51" high datum line)			
M From Two Mounted Storage				

SAMPLE ORDER CODE

RCFLG C	13	74	7	K1
----------------	-----------	-----------	----------	-----------

DIMENSIONS INCHES / MM

W
20 / 508
23 / 584
26 / 660
29 / 737
47 / 1194
50 / 1270
53 / 1346
56 / 1422
59 / 1499
62 / 1575
65 / 1651
68 / 1727
71 / 1803
74 / 1880
77 / 1956
80 / 2032
83 / 2108

PRICING

FROM TWO CENTRAL SCREENS (C)

Height (13)	Height (22)
426	498
429	546
437	592
456	638
618	918
648	963
676	1009
755	1108
782	1154
811	1197
839	1244
869	1290
898	1337
928	1383
956	1429
986	1477
1013	1523

Pricing is continued on the following page.

RCFLG
Lateral Framed Screen for
Spine Desk – Glass (Continued)

DIMENSIONS
INCHES / MM

W
21 / 533
24 / 610
27 / 686
30 / 762
48 / 1219
51 / 1295
54 / 1372
57 / 1448
60 / 1524
63 / 1600
66 / 1676
69 / 1753
72 / 1829
75 / 1905
78 / 1981
81 / 2057
84 / 2134

PRICING

FROM REAR EDGE (E)		
	Height (13)	Height (22)
	427	515
	429	560
	437	608
	457	654
	630	933
	658	980
	734	1073
	763	1121
	792	1167
	821	1213
	849	1257
	879	1305
	908	1353
	937	1400
	964	1448
	994	1491
	1022	1538

32 / 813
35 / 889
38 / 965
40 / 1016
41 / 1041
43 / 1092
44 / 1118
46 / 1168
47 / 1194
49 / 1245
50 / 1270
52 / 1321
53 / 1346
55 / 1397
56 / 1422
58 / 1473
59 / 1499
61 / 1549
62 / 1575
64 / 1626
65 / 1651
67 / 1702
68 / 1727
70 / 1778
73 / 1854
76 / 1390

FROM TWO MOUNTED STORAGE (M)		
	Height (13)	Height (22)
	474	686
	505	732
	532	777
	551	809
	564	822
	579	855
	592	870
	609	900
	618	918
	638	949
	648	963
	666	994
	676	1009
	746	1087
	755	1108
	774	1134
	782	1154
	803	1181
	811	1197
	832	1231
	839	1244
	861	1278
	869	1290
	889	1324
	918	1368
	947	1414

RCFBM

Central Framed Screen for Spine Desk – Magnetic Glass

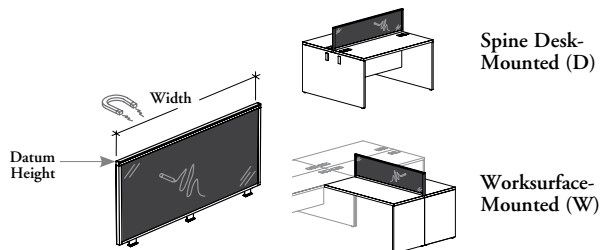

This screen provides central space division, desktop privacy and vertical magnetic writable surface in Spine Desk applications.

WHAT'S INCLUDED

2 magnetic glass infills, extrusions, mounting hardware, and element listed below:

Width	
21" to 48"	51" to 84"
Rare Earth Magnet	8 16

Rare Earth Magnet 8 16

NOTES

Use only dry-erase markers and magnets with this board.

Back-Painted tempered glass infills are doubled for a flush look.

Must be used in back position between two workstations.

Can be mounted on the top of:

- The junction of two Single-Sided Spine Desks in back-to-back position or between two worksurfaces on a Shared Spine Desk
- The junction of two Rectangular Worksurfaces in back-to-back position (RTL DL and RTL DC)

PRODUCT OPTIONS

Mounting Option	Height	Width	Frame Finish	Infill Finish
D Desk-Mounted W Worksurface-Mounted	13 (42" high datum line with Desk-Mounted option (D or W)) 22 (51" high datum line with Desk-Mounted option (D or W))	21, 24, 27, 30, 33, 36, 39, 42, 45, 48, 51, 54, 57, 60, 63, 66, 69, 72, 75, 78, 81, 84	Foundation Mica	Back-Painted Glass

SAMPLE ORDER CODE

RCFBM D	22	84	7	K7
----------------	-----------	-----------	----------	-----------

DIMENSIONS INCHES / MM

W
21 / 533
24 / 610
27 / 686
30 / 762
33 / 838
36 / 914
39 / 991
42 / 1067
45 / 1143
48 / 1219
51 / 1295
54 / 1372
57 / 1448
60 / 1524
63 / 1600
66 / 1676
69 / 1753
72 / 1829
75 / 1905
78 / 1981
81 / 2057
84 / 2134

PRICING

DESK-MOUNTED (D) OR WORKSURFACE-MOUNTED (W)

	Height (13)	Height (22)
	514	616
	516	672
	524	727
	548	783
	582	839
	616	896
	651	952
	687	1007
	719	1064
	755	1119
	789	1173
	882	1289
	918	1343
	952	1400
	986	1456
	1020	1511
	1053	1566
	1087	1623
	1123	1679
	1159	1734
	1194	1791
	1226	1846

RCFLM

Lateral Framed Screen for Spine Desk – Magnetic Glass

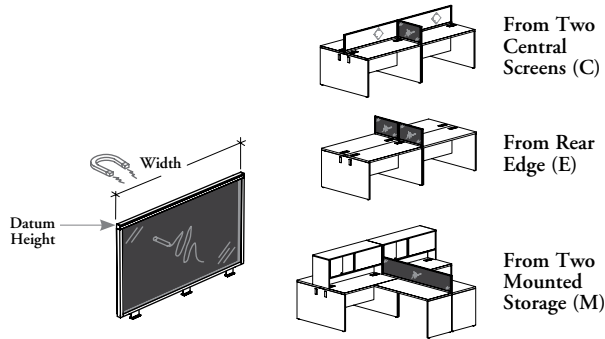

This screen provides central space division, desktop privacy and vertical magnetic writable surface in Spine Desk applications.

WHAT'S INCLUDED

2 magnetic glass infills, extrusions, mounting hardware, and element listed below:

Width	
20" to 48"	49" to 84"
Rare Earth Magnet	8 16

Rare Earth Magnet 8 16

NOTES

Use only dry-erase markers and magnets with this board.

Back-Painted tempered glass infills are doubled for a flush look.

Must be used in lateral position between two workstations.

Can be mounted on the top of the junction of two Single-Sided or Shared Spine Desks in side-by-side position.

The mounting option (M) is only available with Elevated Desktop Cabinets.

PRODUCT OPTIONS

Mounting Option	Height	Width	Frame Finish	Infill Finish
C From Two Central Screens	13 (42" high datum line)	From Two Central Screens (C): 20, 23, 26, 29, 47, 50, 53, 56, 59, 62, 65, 68, 71, 74, 77, 80, 83 From Rear Edge (E): 21, 24, 27, 30, 48, 51, 54, 57, 60, 63, 66, 69, 72, 75, 78, 81, 84 From Two Mounted Storage (M): 32, 35, 38, 40, 41, 43, 44, 46, 47, 49, 50, 52, 53, 55, 56, 58, 59, 61, 62, 64, 65, 67, 68, 70, 73, 76	Foundation	Back-Painted Glass
E From Rear Edge	22 (51" high datum line)		Mica	
M From Two Mounted Storage				

SAMPLE ORDER CODE

RCFLM E	22	48	7	K1
----------------	-----------	-----------	----------	-----------

DIMENSIONS INCHES / MM

W
20 / 508
23 / 584
26 / 660
29 / 737
47 / 1194
50 / 1270
53 / 1346
56 / 1422
59 / 1499
62 / 1575
65 / 1651
68 / 1727
71 / 1803
74 / 1880
77 / 1956
80 / 2032
83 / 2108

PRICING

FROM TWO CENTRAL SCREENS (C)		
	Height (13)	Height (22)
	513	599
	515	654
	523	710
	546	766
	744	1100
	777	1158
	813	1211
	906	1326
	940	1380
	973	1437
	1008	1492
	1043	1549
	1079	1604
	1112	1660
	1147	1716
	1180	1772
	1215	1827

Pricing is continued on the following page.

R C F L M

Lateral Framed Screen for Spine Desk – Magnetic Glass (Continued)

**DIMENSIONS
INCHES / MM**

W
21 / 533
24 / 610
27 / 686
30 / 762
48 / 1219
51 / 1295
54 / 1372
57 / 1448
60 / 1524
63 / 1600
66 / 1676
69 / 1753
72 / 1829
75 / 1905
78 / 1981
81 / 2057
84 / 2134

PRICING

FROM REAR EDGE (E)		
	Height (13)	Height (22)
	514	616
	516	672
	524	727
	548	783
	755	1119
	789	1173
	882	1289
	918	1343
	952	1400
	986	1456
	1020	1511
	1053	1566
	1087	1623
	1123	1679
	1159	1734
	1194	1791
	1226	1846

FROM TWO MOUNTED STORAGE (M)		
	Height (13)	Height (22)
32 / 813	571	821
35 / 889	604	877
38 / 965	639	934
40 / 1016	661	969
41 / 1041	674	991
43 / 1092	696	1027
44 / 1118	709	1044
46 / 1168	732	1081
47 / 1194	744	1100
49 / 1245	766	1136
50 / 1270	777	1158
52 / 1321	802	1194
53 / 1346	813	1211
55 / 1397	892	1306
56 / 1422	906	1326
58 / 1473	928	1364
59 / 1499	940	1380
61 / 1549	962	1419
62 / 1575	973	1437
64 / 1626	996	1474
65 / 1651	1008	1492
67 / 1702	1032	1531
68 / 1727	1043	1549
70 / 1778	1067	1586
73 / 1854	1100	1641
76 / 1390	1134	1697

Xpress

RACMT

Marker Holder for Markerboard

WHAT'S INCLUDED

1 marker holder and Velcro® attachment.

WHAT'S EXCLUDED

Markerboard, Marker, and Eraser.

NOTES

Can be installed on a Glass Markerboard.

Can also be used freestanding on a worksurface, etc.

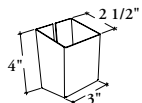

PRODUCT OPTIONS

Finish

Foundation

Accent

Mica

SAMPLE ORDER CODE

RACMT E

PRICING

Foundation	Mica/Accent
60	73

columns & screens

Xpress

R P S W G

Worksurface Edge Screen – Glass

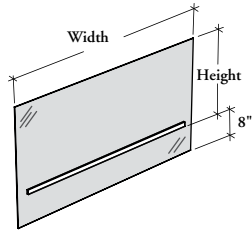

This screen attaches to the worksurface edge to provide space division and desktop privacy. It also provides a half-height modesty panel.

WHAT'S INCLUDED

1 glass screen and attachment bracket.

NOTES

Worksurface Edge Screen can only be mounted on suspended worksurface with Straight Trim.

Frosted (FT) is a 1/4" (6 mm) single-sided etched tempered glass which is facing inward of the workstation.

PRODUCT OPTIONS

Height	Width	Glass Finish	Hardware Finish
13 (42" high datum line) 22 (51" high datum line)	24, 27, 30, 33, 36, 39, 42, 45, 48, 51, 54, 57, 60	FT Frosted	Foundation Mica

SAMPLE ORDER CODE

RPSWG 13	60	FT	D
-----------------	-----------	-----------	----------

**DIMENSIONS
INCHES / MM**

PRICING

H	W
13 / 330	24 / 610
13 / 330	27 / 686
13 / 330	30 / 762
13 / 330	33 / 838
13 / 330	36 / 914
13 / 330	39 / 991
13 / 330	42 / 1067
13 / 330	45 / 1143
13 / 330	48 / 1219
13 / 330	51 / 1295
13 / 330	54 / 1372
13 / 330	57 / 1448
13 / 330	60 / 1524

361
401
440
481
521
563
600
640
681
720
761
802
841

**DIMENSIONS
INCHES / MM**

PRICING

H	W
22 / 559	24 / 610
22 / 559	27 / 686
22 / 559	30 / 762
22 / 559	33 / 838
22 / 559	36 / 914
22 / 559	39 / 991
22 / 559	42 / 1067
22 / 559	45 / 1143
22 / 559	48 / 1219
22 / 559	51 / 1295
22 / 559	54 / 1372
22 / 559	57 / 1448
22 / 559	60 / 1524

456
505
551
600
647
694
746
790
839
886
935
983
1031

This screen attaches to the edge worksurface to provide space division and desktop privacy. It also provides a half-height modesty panel.

WHAT'S INCLUDED

1 solid screen and attachment bracket.

NOTES

Worksurface Edge Screen can only be mounted on suspended worksurface with Straight Trim.

The laminate panel is 11/16" thick.

RPSWL
Worksurface Edge Screen – Solid

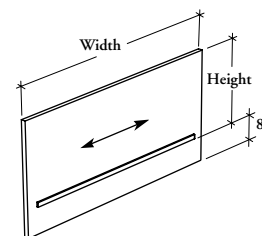

PRODUCT OPTIONS

Height	Width	Screen Finish	Hardware Finish
13 (42" high datum line)	24, 27, 30, 33, 36, 39, 42, 45, 48, 51, 54, 57, 60	Source Laminate	Foundation Mica
22 (51" high datum line)			

SAMPLE ORDER CODE

RPSWL 22	60	XS	E
-----------------	-----------	-----------	----------

**DIMENSIONS
INCHES / MM**

PRICING

H	W
13 / 330	24 / 610
13 / 330	27 / 686
13 / 330	30 / 762
13 / 330	33 / 838
13 / 330	36 / 914
13 / 330	39 / 991
13 / 330	42 / 1067
13 / 330	45 / 1143
13 / 330	48 / 1219
13 / 330	51 / 1295
13 / 330	54 / 1372
13 / 330	57 / 1448
13 / 330	60 / 1524

183
203
220
239
255
271
291
307
324
343
361
375
396

**DIMENSIONS
INCHES / MM**

PRICING

H	W
22 / 559	24 / 610
22 / 559	27 / 686
22 / 559	30 / 762
22 / 559	33 / 838
22 / 559	36 / 914
22 / 559	39 / 991
22 / 559	42 / 1067
22 / 559	45 / 1143
22 / 559	48 / 1219
22 / 559	51 / 1295
22 / 559	54 / 1372
22 / 559	57 / 1448
22 / 559	60 / 1524

212
232
252
269
291
311
331
349
370
390
411
428
449

columns & screens

Xpress

RPSBL

1" Floor Screen – Back Connection

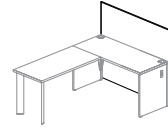
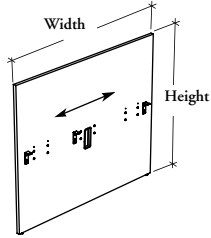

Modular Desk (M)
Flush Application

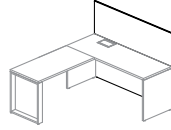

Single-Sided Spine Desk (S)
Flush Application

This Floor Screen attaches to the back of a Modular or Single-Sided Spine Desk to provide space division.

WHAT'S INCLUDED

1 solid floor screen, 1 cable pass-through ring (as specified), modular desk or spine desk mounting hardware (as specified), and levelers.

WHAT'S EXCLUDED

Cable Pass-Through Cover (if applicable).

NOTES

Hardware Finish should be specified to match with the gable or base.

When Spine Desk mounting hardware option (S) is specified, the Cable Pass-Through option (C) is **not** available.

Pass-Through ring comes in a Platinum Coordinate.

Three width applications are available: flush, extended one side and extended both sides. For details on these applications, see Application Guide of this section.

PRODUCT OPTIONS

Height	Width	Screen Finish	Mounting Hardware Option	Cable Pass-Through	Hardware Finish
42, 51	Flush Application: 24, 30, 36, 42, 48, 54, 60, 66, 72, 78, 84 Extended One Side Application: 25, 31, 37, 43, 49, 55, 61, 67, 73, 79, 85 Extended Both Sides Application: 26, 32, 38, 44, 50, 56, 62, 68, 74, 80, 86	Source Laminate	M Modular Desk S Spine Desk	C Center Pass-Through (Shown) N None	Foundation Mica Coordinate Colors

SAMPLE ORDER CODE

RPSBL 51	84	3D	M	C	E
-----------------	-----------	-----------	----------	----------	----------

DIMENSIONS INCHES / MM

H	W
42 / 1067	24 / 610
42 / 1067	25 / 635
42 / 1067	26 / 660
42 / 1067	30 / 762
42 / 1067	31 / 787
42 / 1067	32 / 813
42 / 1067	36 / 914
42 / 1067	37 / 940
42 / 1067	38 / 965
42 / 1067	42 / 1067
42 / 1067	43 / 1092
42 / 1067	44 / 1118
42 / 1067	48 / 1219
42 / 1067	49 / 1245
42 / 1067	50 / 1270
42 / 1067	54 / 1372
42 / 1067	55 / 1397

PRICING

311
316
320
346
350
356
379
389
394
418
425
428
454
459
467
490
495

DIMENSIONS INCHES / MM

H	W
42 / 1067	56 / 1422
42 / 1067	60 / 1524
42 / 1067	61 / 1549
42 / 1067	62 / 1575
42 / 1067	66 / 1676
42 / 1067	67 / 1702
42 / 1067	68 / 1727
42 / 1067	72 / 1829
42 / 1067	73 / 1854
42 / 1067	74 / 1880
42 / 1067	78 / 1981
42 / 1067	79 / 2007
42 / 1067	80 / 2032
42 / 1067	84 / 2134
42 / 1067	85 / 2159
42 / 1067	86 / 2184

PRICING

501
571
574
578
602
611
617
640
647
652
675
684
690
715
719
723

Pricing is continued on the following page.

R P S B L
1" Floor Screen – Back Connection (Continued)

DIMENSIONS INCHES / MM		PRICING	DIMENSIONS INCHES / MM		PRICING
H	W		H	W	
51 / 1295	24 / 610	345	51 / 1295	56 / 1422	573
51 / 1295	25 / 635	349	51 / 1295	60 / 1524	641
51 / 1295	26 / 660	356	51 / 1295	61 / 1549	650
51 / 1295	30 / 762	389	51 / 1295	62 / 1575	659
51 / 1295	31 / 787	394	51 / 1295	66 / 1676	687
51 / 1295	32 / 813	403	51 / 1295	67 / 1702	693
51 / 1295	36 / 914	428	51 / 1295	68 / 1727	697
51 / 1295	37 / 940	437	51 / 1295	72 / 1829	731
51 / 1295	38 / 965	442	51 / 1295	73 / 1854	737
51 / 1295	42 / 1067	471	51 / 1295	74 / 1880	744
51 / 1295	43 / 1092	481	51 / 1295	78 / 1981	771
51 / 1295	44 / 1118	487	51 / 1295	79 / 2007	780
51 / 1295	48 / 1219	516	51 / 1295	80 / 2032	785
51 / 1295	49 / 1245	524	51 / 1295	84 / 2134	813
51 / 1295	50 / 1270	529	51 / 1295	85 / 2159	822
51 / 1295	54 / 1372	559	51 / 1295	86 / 2184	832
51 / 1295	55 / 1397	567			

columns & screens

Xpress

RPSLL

1" Floor Screen – Lateral Connection

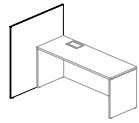
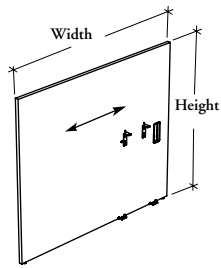

Left Config. (L)
Flush Application

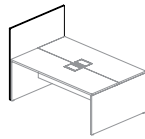

Shared Config. (S)
Flush Application

This Floor Screen attaches to the side of a Modular, or Spine Desk (Single-Sided or Shared) to provide space division.

WHAT'S INCLUDED

1 solid floor screen, 1 (left or right) or 2 (shared) cable pass-through ring (as specified), mounting hardware, and levelers.

WHAT'S EXCLUDED

Cable Pass-Through Cover (if applicable).

NOTES

Hardware Finish should be specified to match with the gable or base.

Configuration is determined by the side of the desk to which the screen is mounted.

Pass-Through ring comes in a Platinum Coordinate.

Two width applications are available: flush or back extended. For details on these applications, see Application Guide of this section.

PRODUCT OPTIONS

Height	Width	Configuration	Screen Finish	Cable Pass-Through	Hardware Finish
42, 51	Flush Application: 20, 24, 30, 36, 40, 42, 48, 54, 57, 60, 63, 66, 69, 72, 78, 84 Back Extended Application: 21, 25, 31, 37, 41, 43, 49, 55, 58, 61, 64, 67, 70, 73, 79, 85	L Left R Right S Shared	Source Laminate	E End Pass-Through (Shown) N None	Foundation Mica Coordinate Colors

SAMPLE ORDER CODE

RPSLL 42	60	L	3D	N	E
-----------------	-----------	----------	-----------	----------	----------

DIMENSIONS INCHES / MM

H	W
42 / 1067	20 / 508
42 / 1067	21 / 533
42 / 1067	24 / 610
42 / 1067	25 / 635
42 / 1067	30 / 762
42 / 1067	31 / 787
42 / 1067	36 / 914
42 / 1067	37 / 940
42 / 1067	40 / 1016
42 / 1067	41 / 1041
42 / 1067	42 / 1067
42 / 1067	43 / 1092
42 / 1067	48 / 1219
42 / 1067	49 / 1245
42 / 1067	54 / 1372
42 / 1067	55 / 1397

PRICING

LEFT OR RIGHT CONFIGURATION (L or R)	SHARED CONFIGURATION (S)
284	n/a
290	n/a
311	n/a
316	n/a
346	n/a
350	n/a
379	n/a
389	n/a
n/a	406
n/a	411
418	n/a
425	n/a
454	454
459	459
490	n/a
495	n/a

DIMENSIONS INCHES / MM

H	W
42 / 1067	57 / 1448
42 / 1067	58 / 1473
42 / 1067	60 / 1524
42 / 1067	61 / 1549
42 / 1067	63 / 1600
42 / 1067	64 / 1626
42 / 1067	66 / 1676
42 / 1067	67 / 1702
42 / 1067	69 / 1753
42 / 1067	70 / 1778
42 / 1067	72 / 1829
42 / 1067	73 / 1854
42 / 1067	78 / 1981
42 / 1067	79 / 2007
42 / 1067	84 / 2134
42 / 1067	85 / 2159

PRICING

LEFT OR RIGHT CONFIGURATION (L or R)	SHARED CONFIGURATION (S)
512	n/a
516	n/a
571	571
574	574
586	n/a
592	n/a
602	602
611	611
622	n/a
629	n/a
640	640
647	647
675	675
684	684
715	715
719	719

Pricing is continued on the following page.

R P S L L
1" Floor Screen – Lateral Connection (Continued)

**DIMENSIONS
 INCHES / MM**

PRICING

H	W	LEFT OR RIGHT CONFIGURATION (L or R)	SHARED CONFIGURATION (S)
		51 / 1295	20 / 508
51 / 1295	21 / 533	321	n/a
51 / 1295	24 / 610	345	n/a
51 / 1295	25 / 635	349	n/a
51 / 1295	30 / 762	389	n/a
51 / 1295	31 / 787	394	n/a
51 / 1295	36 / 914	428	n/a
51 / 1295	37 / 940	437	n/a
51 / 1295	40 / 1016	n/a	456
51 / 1295	41 / 1041	n/a	466
51 / 1295	42 / 1067	471	n/a
51 / 1295	43 / 1092	481	n/a
51 / 1295	48 / 1219	516	516
51 / 1295	49 / 1245	524	524
51 / 1295	54 / 1372	559	n/a
51 / 1295	55 / 1397	567	n/a

**DIMENSIONS
 INCHES / MM**

PRICING

H	W	LEFT OR RIGHT CONFIGURATION (L or R)	SHARED CONFIGURATION (S)
		51 / 1295	57 / 1448
51 / 1295	58 / 1473	589	n/a
51 / 1295	60 / 1524	641	641
51 / 1295	61 / 1549	650	650
51 / 1295	63 / 1600	665	n/a
51 / 1295	64 / 1626	669	n/a
51 / 1295	66 / 1676	687	687
51 / 1295	67 / 1702	693	693
51 / 1295	69 / 1753	709	n/a
51 / 1295	70 / 1778	716	n/a
51 / 1295	72 / 1829	731	731
51 / 1295	73 / 1854	737	737
51 / 1295	78 / 1981	771	771
51 / 1295	79 / 2007	780	780
51 / 1295	84 / 2134	813	813
51 / 1295	85 / 2159	822	822

columns & screens

Xpress

R P S B G

1" Floor Screen with Glass – Back Connection

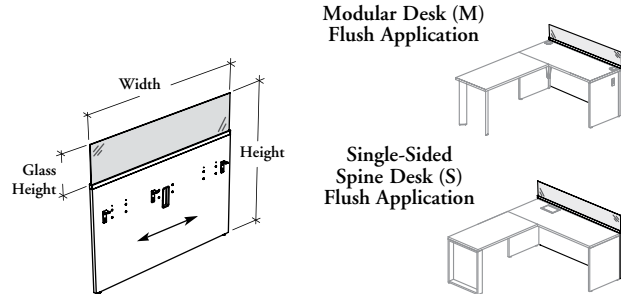

This Floor Screen attaches to the back of a Modular or Single-Sided Spine Desk to provide space division. The glass screen added on top provides a lighter, frameless alternative to 2" Freestanding Screens.

WHAT'S INCLUDED

1 solid floor screen with glass, 1 cable pass-through ring (as specified), linking device, modular desk or spine desk mounting hardware (as specified), and levelers.

WHAT'S EXCLUDED

Cable Pass-Through Cover (if applicable).

NOTES

Hardware Finish should be specified to match with the gable or base.

When Spine Desk mounting hardware option (S) is specified, the Cable Pass-Through option (C) is **not** available.

Pass-Through ring comes in a Platinum Coordinate.

Three width applications are available: flush, extended one side and extended both sides. For details on these applications, see Application Guide of this section.

Frosted (FT) is a 1/4" (6 mm) single-sided etched tempered glass which is facing inward of the workstation.

All glass finishes are available as Xpress. Please see Xpress catalogue and/or specification software for details.

PRODUCT OPTIONS

Height	Glass Height	Width	Screen Finish	Frame Finish	Mounting Hardware Option	Cable Pass-Through	Hardware Finish
42, 51	09, 13, 22	Flush Application: 24, 30, 36, 42, 48, 54, 60, 66, 72, 78, 84 Extended One Side Application: 25, 31, 37, 43, 49, 55, 61, 67, 73, 79, 85 Extended Both Side Application: 26, 32, 38, 44, 50, 56, 62, 68, 74, 80, 86	Source Laminate	Foundation Mica Glass Finish CL Clear FT Frosted	M Modular Desk S Spine Desk	C Center Pass-Through (Shown) N None	Foundation Mica Coordinate Colors

SAMPLE ORDER CODE

RPSBG 42	13	62	XS	E	FT	M	C	E
-------------	----	----	----	---	----	---	---	---

DIMENSIONS INCHES / MM

H	W
42 / 1067	24 / 610
42 / 1067	25 / 635
42 / 1067	26 / 660
42 / 1067	30 / 762
42 / 1067	31 / 787
42 / 1067	32 / 813
42 / 1067	36 / 914
42 / 1067	37 / 940
42 / 1067	38 / 965
42 / 1067	42 / 1067
42 / 1067	43 / 1092
42 / 1067	44 / 1118
42 / 1067	48 / 1219
42 / 1067	49 / 1245
42 / 1067	50 / 1270
42 / 1067	54 / 1372
42 / 1067	55 / 1397

PRICING

13" GLASS HEIGHT	
Clear (CL)	Frosted (FT)
440	529
452	541
457	551
488	594
495	604
509	614
536	658
545	666
551	677
582	719
592	731
600	741
630	782
639	793
645	805
675	846
687	858

DIMENSIONS INCHES / MM

H	W
42 / 1067	56 / 1422
42 / 1067	60 / 1524
42 / 1067	61 / 1549
42 / 1067	62 / 1575
42 / 1067	66 / 1676
42 / 1067	67 / 1702
42 / 1067	68 / 1727
42 / 1067	72 / 1829
42 / 1067	73 / 1854
42 / 1067	74 / 1880
42 / 1067	78 / 1981
42 / 1067	79 / 2007
42 / 1067	80 / 2032
42 / 1067	84 / 2134
42 / 1067	85 / 2159
42 / 1067	86 / 2184

PRICING

Clear (CL)	Frosted (FT)
693	867
761	944
771	957
781	969
820	1020
832	1032
841	1044
882	1095
892	1110
899	1122
941	1170
952	1182
963	1196
999	1247
1012	1257
1021	1276

Pricing is continued on the following page.

R P S B G

1" Floor Screen with Glass – Back Connection (Continued)

DIMENSIONS
INCHES / MM

H	W
51 / 1295	24 / 610
51 / 1295	25 / 635
51 / 1295	26 / 660
51 / 1295	30 / 762
51 / 1295	31 / 787
51 / 1295	32 / 813
51 / 1295	36 / 914
51 / 1295	37 / 940
51 / 1295	38 / 965
51 / 1295	42 / 1067
51 / 1295	43 / 1092
51 / 1295	44 / 1118
51 / 1295	48 / 1219
51 / 1295	49 / 1245
51 / 1295	50 / 1270
51 / 1295	54 / 1372
51 / 1295	55 / 1397

PRICING

9" GLASS HEIGHT	
Clear (CL)	Frosted (FT)
470	534
480	544
487	553
523	599
529	609
542	618
577	662
585	674
597	686
630	725
639	738
647	749
686	792
693	805
698	814
735	858
746	868

DIMENSIONS
INCHES / MM

H	W
51 / 1295	56 / 1422
51 / 1295	60 / 1524
51 / 1295	61 / 1549
51 / 1295	62 / 1575
51 / 1295	66 / 1676
51 / 1295	67 / 1702
51 / 1295	68 / 1727
51 / 1295	72 / 1829
51 / 1295	73 / 1854
51 / 1295	74 / 1880
51 / 1295	78 / 1981
51 / 1295	79 / 2007
51 / 1295	80 / 2032
51 / 1295	84 / 2134
51 / 1295	85 / 2159
51 / 1295	86 / 2184

PRICING

Clear (CL)	Frosted (FT)
755	880
826	957
839	970
847	983
891	1029
899	1041
911	1052
954	1099
965	1112
974	1123
1018	1169
1029	1180
1039	1195
1081	1242
1090	1253
1102	1261

22" GLASS HEIGHT

51 / 1295	24 / 610
51 / 1295	25 / 635
51 / 1295	26 / 660
51 / 1295	30 / 762
51 / 1295	31 / 787
51 / 1295	32 / 813
51 / 1295	36 / 914
51 / 1295	37 / 940
51 / 1295	38 / 965
51 / 1295	42 / 1067
51 / 1295	43 / 1092
51 / 1295	44 / 1118
51 / 1295	48 / 1219
51 / 1295	49 / 1245
51 / 1295	50 / 1270
51 / 1295	54 / 1372
51 / 1295	55 / 1397

Clear (CL)	Frosted (FT)
481	622
488	637
496	650
535	699
544	716
552	725
588	777
597	792
604	806
640	858
648	869
659	884
694	935
701	948
713	962
749	1013
756	1027

51 / 1295	56 / 1422
51 / 1295	60 / 1524
51 / 1295	61 / 1549
51 / 1295	62 / 1575
51 / 1295	66 / 1676
51 / 1295	67 / 1702
51 / 1295	68 / 1727
51 / 1295	72 / 1829
51 / 1295	73 / 1854
51 / 1295	74 / 1880
51 / 1295	78 / 1981
51 / 1295	79 / 2007
51 / 1295	80 / 2032
51 / 1295	84 / 2134
51 / 1295	85 / 2159
51 / 1295	86 / 2184

Clear (CL)	Frosted (FT)
763	1039
839	1126
848	1144
862	1163
908	1234
922	1250
934	1264
983	1337
994	1355
1006	1373
1054	1442
1067	1460
1079	1478
1126	1549
1137	1566
1148	1585

columns & screens

Xpress

R P S L G

1" Floor Screen with Glass – Lateral Connection

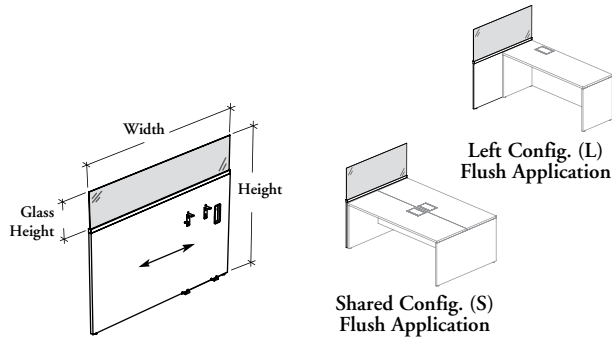

This Floor Screen attaches to the side of a Modular, or Spine Desk (Single-Sided or Shared) to provide space division. The glass screen added on top provides a lighter, frameless alternative to 2" Freestanding Screens.

WHAT'S INCLUDED

1 solid floor screen with glass, 1 (left or right) or 2 (shared) cable pass-through ring (as specified), linking devices, mounting hardware, and levelers.

WHAT'S EXCLUDED

Cable Pass-Through Cover (if applicable).

NOTES

Hardware Finish should be specified to match with the gable or base.

Configuration is determined by the side of the desk to which the screen is mounted.

Pass-Through ring comes in a Platinum Coordinate.

Two width applications are available: flush or back extended. For details on these applications, see Application Guide of this section.

Frosted (FT) is a 1/4" (6 mm) single-sided etched tempered glass which is facing inward of the workstation.

All glass finishes are available as Xpress. Please see Xpress catalogue and/or specification software for details.

PRODUCT OPTIONS

Height	Glass Height	Width	Configuration	Screen Finish	Frame Finish	Cable Pass-Through	Hardware Finish
42, 51	09, 13, 22	Flush Application: 20, 24, 30, 36, 40, 42, 48, 54, 57, 60, 63, 66, 69, 72, 78, 84 Back Extended Application: 21, 25, 31, 37, 41, 43, 49, 55, 58, 61, 64, 67, 70, 73, 79, 85	L Left R Right S Shared	Source Laminate	Foundation Mica Glass Finish CL Clear FT Frosted	E End Pass-Through (Shown) N None	Foundation Mica Coordinate Colors

SAMPLE ORDER CODE

RPSLG 51	22	48	S	3E	7	CL	E	E
--------------------	-----------	-----------	----------	-----------	----------	-----------	----------	----------

DIMENSIONS INCHES / MM

PRICING

DIMENSIONS INCHES / MM

PRICING

13" GLASS HEIGHT

LEFT OR RIGHT CONFIGURATION (L or R)

H	W	Clear (CL) Frosted (FT)		H	W	Clear (CL) Frosted (FT)	
		Clear (CL)	Frosted (FT)			Clear (CL)	Frosted (FT)
42 / 1067	20 / 508	411	488	42 / 1067	57 / 1448	697	877
42 / 1067	21 / 533	419	498	42 / 1067	58 / 1473	709	889
42 / 1067	24 / 610	440	529	42 / 1067	60 / 1524	761	944
42 / 1067	25 / 635	452	541	42 / 1067	61 / 1549	771	957
42 / 1067	30 / 762	488	594	42 / 1067	63 / 1600	792	983
42 / 1067	31 / 787	495	604	42 / 1067	64 / 1626	803	995
42 / 1067	36 / 914	536	658	42 / 1067	66 / 1676	820	1020
42 / 1067	37 / 940	545	666	42 / 1067	67 / 1702	832	1032
42 / 1067	40 / 1016	n/a	n/a	42 / 1067	69 / 1753	849	1058
42 / 1067	41 / 1041	n/a	n/a	42 / 1067	70 / 1778	862	1071
42 / 1067	42 / 1067	582	719	42 / 1067	72 / 1829	882	1095
42 / 1067	43 / 1092	592	731	42 / 1067	73 / 1854	892	1110
42 / 1067	48 / 1219	630	782	42 / 1067	78 / 1981	941	1170
42 / 1067	49 / 1245	639	793	42 / 1067	79 / 2007	952	1182
42 / 1067	54 / 1372	675	846	42 / 1067	84 / 2134	999	1247
42 / 1067	55 / 1397	687	858	42 / 1067	85 / 2159	1012	1257

Pricing is continued on the following page.

R P S L G

1" Floor Screen with Glass – Lateral Connection (Continued)

DIMENSIONS
INCHES / MM

PRICING

DIMENSIONS
INCHES / MM

PRICING

9" GLASS HEIGHT

LEFT OR RIGHT CONFIGURATION (L or R)

H	W
51 / 1295	20 / 508
51 / 1295	21 / 533
51 / 1295	24 / 610
51 / 1295	25 / 635
51 / 1295	30 / 762
51 / 1295	31 / 787
51 / 1295	36 / 914
51 / 1295	37 / 940
51 / 1295	40 / 1016
51 / 1295	41 / 1041
51 / 1295	42 / 1067
51 / 1295	43 / 1092
51 / 1295	48 / 1219
51 / 1295	49 / 1245
51 / 1295	54 / 1372
51 / 1295	55 / 1397

Clear (CL)	Frosted (FT)
435	490
441	499
470	534
480	544
523	599
529	609
577	662
585	674
n/a	n/a
n/a	n/a
630	725
639	738
686	792
693	805
735	858
746	868

H	W
51 / 1295	57 / 1448
51 / 1295	58 / 1473
51 / 1295	60 / 1524
51 / 1295	61 / 1549
51 / 1295	63 / 1600
51 / 1295	64 / 1626
51 / 1295	66 / 1676
51 / 1295	67 / 1702
51 / 1295	69 / 1753
51 / 1295	70 / 1778
51 / 1295	72 / 1829
51 / 1295	73 / 1854
51 / 1295	78 / 1981
51 / 1295	79 / 2007
51 / 1295	84 / 2134
51 / 1295	85 / 2159

Clear (CL)	Frosted (FT)
762	890
771	899
826	957
839	970
858	993
870	1006
891	1029
899	1041
923	1065
934	1078
954	1099
965	1112
1018	1169
1029	1180
1081	1242
1090	1253

22" GLASS HEIGHT

LEFT OR RIGHT CONFIGURATION (L or R)

H	W
51 / 1295	20 / 508
51 / 1295	21 / 533
51 / 1295	24 / 610
51 / 1295	25 / 635
51 / 1295	30 / 762
51 / 1295	31 / 787
51 / 1295	36 / 914
51 / 1295	37 / 940
51 / 1295	40 / 1016
51 / 1295	41 / 1041
51 / 1295	42 / 1067
51 / 1295	43 / 1092
51 / 1295	48 / 1219
51 / 1295	49 / 1245
51 / 1295	54 / 1372
51 / 1295	55 / 1397

Clear (CL)	Frosted (FT)
442	572
456	585
481	622
488	637
535	699
544	716
588	777
597	792
n/a	n/a
n/a	n/a
640	858
648	869
694	935
701	948
749	1013
756	1027

H	W
51 / 1295	57 / 1448
51 / 1295	58 / 1473
51 / 1295	60 / 1524
51 / 1295	61 / 1549
51 / 1295	63 / 1600
51 / 1295	64 / 1626
51 / 1295	66 / 1676
51 / 1295	67 / 1702
51 / 1295	69 / 1753
51 / 1295	70 / 1778
51 / 1295	72 / 1829
51 / 1295	73 / 1854
51 / 1295	78 / 1981
51 / 1295	79 / 2007
51 / 1295	84 / 2134
51 / 1295	85 / 2159

Clear (CL)	Frosted (FT)
773	1052
781	1065
839	1126
848	1144
872	1179
886	1199
908	1234
922	1250
944	1286
956	1302
983	1337
994	1355
1054	1442
1067	1460
1126	1549
1137	1566

Pricing is continued on the following page.

Xpress

R P S L G

1" Floor Screen with Glass – Lateral Connection (Continued)

DIMENSIONS INCHES / MM		PRICING		DIMENSIONS INCHES / MM		PRICING	
13" GLASS HEIGHT							
SHARED CONFIGURATION (S)							
H	W	Clear (CL)	Frosted (FT)	H	W	Clear (CL)	Frosted (FT)
42 / 1067	20 / 508	n/a	n/a	42 / 1067	57 / 1448	n/a	n/a
42 / 1067	21 / 533	n/a	n/a	42 / 1067	58 / 1473	n/a	n/a
42 / 1067	24 / 610	n/a	n/a	42 / 1067	60 / 1524	761	944
42 / 1067	25 / 635	n/a	n/a	42 / 1067	61 / 1549	771	957
42 / 1067	30 / 762	n/a	n/a	42 / 1067	63 / 1600	n/a	n/a
42 / 1067	31 / 787	n/a	n/a	42 / 1067	64 / 1626	n/a	n/a
42 / 1067	36 / 914	n/a	n/a	42 / 1067	66 / 1676	820	1020
42 / 1067	37 / 940	n/a	n/a	42 / 1067	67 / 1702	832	1032
42 / 1067	40 / 1016	567	697	42 / 1067	69 / 1753	n/a	n/a
42 / 1067	41 / 1041	574	709	42 / 1067	70 / 1778	n/a	n/a
42 / 1067	42 / 1067	n/a	n/a	42 / 1067	72 / 1829	882	1095
42 / 1067	43 / 1092	n/a	n/a	42 / 1067	73 / 1854	892	1110
42 / 1067	48 / 1219	630	782	42 / 1067	78 / 1981	941	1170
42 / 1067	49 / 1245	639	793	42 / 1067	79 / 2007	952	1182
42 / 1067	54 / 1372	n/a	n/a	42 / 1067	84 / 2134	999	1247
42 / 1067	55 / 1397	n/a	n/a	42 / 1067	85 / 2159	1012	1257

9" GLASS HEIGHT							
SHARED CONFIGURATION (S)							
H	W	Clear (CL)	Frosted (FT)	H	W	Clear (CL)	Frosted (FT)
51 / 1295	20 / 508	n/a	n/a	51 / 1295	57 / 1448	n/a	n/a
51 / 1295	21 / 533	n/a	n/a	51 / 1295	58 / 1473	n/a	n/a
51 / 1295	24 / 610	n/a	n/a	51 / 1295	60 / 1524	826	957
51 / 1295	25 / 635	n/a	n/a	51 / 1295	61 / 1549	839	970
51 / 1295	30 / 762	n/a	n/a	51 / 1295	63 / 1600	n/a	n/a
51 / 1295	31 / 787	n/a	n/a	51 / 1295	64 / 1626	n/a	n/a
51 / 1295	36 / 914	n/a	n/a	51 / 1295	66 / 1676	891	1029
51 / 1295	37 / 940	n/a	n/a	51 / 1295	67 / 1702	899	1041
51 / 1295	40 / 1016	611	706	51 / 1295	69 / 1753	n/a	n/a
51 / 1295	41 / 1041	619	718	51 / 1295	70 / 1778	n/a	n/a
51 / 1295	42 / 1067	n/a	n/a	51 / 1295	72 / 1829	954	1099
51 / 1295	43 / 1092	n/a	n/a	51 / 1295	73 / 1854	965	1112
51 / 1295	48 / 1219	686	792	51 / 1295	78 / 1981	1018	1169
51 / 1295	49 / 1245	693	805	51 / 1295	79 / 2007	1029	1180
51 / 1295	54 / 1372	n/a	n/a	51 / 1295	84 / 2134	1081	1242
51 / 1295	55 / 1397	n/a	n/a	51 / 1295	85 / 2159	1090	1253

Pricing is continued on the following page.

R P S L G

1" Floor Screen with Glass – Lateral Connection (Continued)

DIMENSIONS INCHES / MM		PRICING		DIMENSIONS INCHES / MM		PRICING	
22" GLASS HEIGHT							
SHARED CONFIGURATION (S)							
H	W	Clear (CL)	Frosted (FT)	H	W	Clear (CL)	Frosted (FT)
51 / 1295	20 / 508	n/a	n/a	51 / 1295	57 / 1448	n/a	n/a
51 / 1295	21 / 533	n/a	n/a	51 / 1295	58 / 1473	n/a	n/a
51 / 1295	24 / 610	n/a	n/a	51 / 1295	60 / 1524	839	1126
51 / 1295	25 / 635	n/a	n/a	51 / 1295	61 / 1549	848	1144
51 / 1295	30 / 762	n/a	n/a	51 / 1295	63 / 1600	n/a	n/a
51 / 1295	31 / 787	n/a	n/a	51 / 1295	64 / 1626	n/a	n/a
51 / 1295	36 / 914	n/a	n/a	51 / 1295	66 / 1676	908	1234
51 / 1295	37 / 940	n/a	n/a	51 / 1295	67 / 1702	922	1250
51 / 1295	40 / 1016	625	832	51 / 1295	69 / 1753	n/a	n/a
51 / 1295	41 / 1041	632	843	51 / 1295	70 / 1778	n/a	n/a
51 / 1295	42 / 1067	n/a	n/a	51 / 1295	72 / 1829	983	1337
51 / 1295	43 / 1092	n/a	n/a	51 / 1295	73 / 1854	994	1355
51 / 1295	48 / 1219	694	935	51 / 1295	78 / 1981	1054	1442
51 / 1295	49 / 1245	701	948	51 / 1295	79 / 2007	1067	1460
51 / 1295	54 / 1372	n/a	n/a	51 / 1295	84 / 2134	1126	1549
51 / 1295	55 / 1397	n/a	n/a	51 / 1295	85 / 2159	1137	1566

RACMS

Glass Markerboard – Screen Mounted

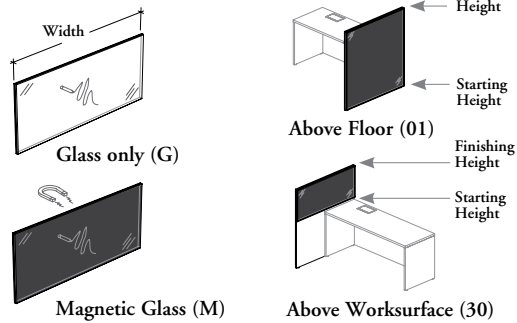

This markerboard must be installed on a 1" Floor Screen or Solid Central/Lateral Screen for Spine Desk only.

WHAT'S INCLUDED

1 glass markerboard, mounting extrusion, double face tape attachment, mounting hardware, and element listed below:

Starting Height	
01	30

Rare Earth Magnet (Magnetic Glass only) 8 4 (20" to 48" w) or 8 (49" to 86" w)

WHAT'S EXCLUDED

1" Floor Screens and Solid Central/Lateral Screens for Spine Desk.

NOTES

Cannot span across two screens.

Mounting Extrusion match the glass finish.

PRODUCT OPTIONS

Markerboard Style	Starting Height	Finishing Height	Width	Glass Finish
G Glass only	01 Above Floor	42, 51	20, 21, 24, 25, 26, 30, 31, 32, 36, 37, 38, 42, 43, 44, 45, 46, 47, 48, 49, 50, 54, 55, 56, 57, 58, 60, 61, 62, 63, 64, 66, 67, 68, 69, 70, 72, 73, 74, 78, 79, 80, 84, 85, 86	Back-Painted
M Magnetic Glass	30 Above Worksurface			

SAMPLE ORDER CODE

RACMS M	01	42	74	K8
----------------	-----------	-----------	-----------	-----------

DIMENSIONS INCHES / MM

H	W
42 / 1067	20 / 508
42 / 1067	21 / 533
42 / 1067	24 / 610
42 / 1067	25 / 635
42 / 1067	26 / 660
42 / 1067	30 / 762
42 / 1067	31 / 787
42 / 1067	32 / 813
42 / 1067	36 / 914
42 / 1067	37 / 940
42 / 1067	38 / 965
42 / 1067	42 / 1067
42 / 1067	43 / 1092
42 / 1067	44 / 1118
42 / 1067	45 / 1143
42 / 1067	46 / 1168
42 / 1067	47 / 1194
42 / 1067	48 / 1219
42 / 1067	49 / 1245
42 / 1067	50 / 1270
42 / 1067	54 / 1372
42 / 1067	55 / 1397
42 / 1067	56 / 1422
42 / 1067	57 / 1448

PRICING

ABOVE WORKSURFACE (30)		ABOVE FLOOR (01)	
GLASS ONLY (G)	MAGNETIC GLASS (M)	GLASS ONLY (G)	MAGNETIC GLASS (M)
Back-Painted Glass	Back-Painted Glass	Back-Painted Glass	Back-Painted Glass
268	401	493	694
269	403	516	716
277	411	573	781
282	414	592	828
283	418	611	848
298	438	690	938
307	447	709	960
314	455	727	983
345	488	807	1121
349	495	826	1141
356	505	846	1165
390	541	922	1253
398	549	942	1278
404	554	962	1296
412	568	983	1319
418	574	999	1340
427	585	1021	1364
434	593	1039	1383
441	640	1060	1564
449	650	1079	1586
481	686	1158	1674
488	694	1176	1695
493	701	1196	1717
501	713	1213	1738

Pricing is continued on the following page.

RACMS

**Glass Markerboard –
Screen Mounted (Continued)**

**DIMENSIONS
INCHES / MM**

PRICING

		ABOVE WORKSURFACE (30) (CONTINUED)		ABOVE FLOOR (01) (CONTINUED)	
		GLASS ONLY (G)	MAGNETIC GLASS (M)	GLASS ONLY (G)	MAGNETIC GLASS (M)
H	W	Back-Painted Glass	Back-Painted Glass	Back-Painted Glass	Back-Painted Glass
51 / 1295	68 / 1727	848	1176	n/a	n/a
51 / 1295	69 / 1753	861	1191	n/a	n/a
51 / 1295	70 / 1778	871	1202	n/a	n/a
51 / 1295	72 / 1829	893	1231	n/a	n/a
51 / 1295	73 / 1854	906	1241	n/a	n/a
51 / 1295	74 / 1880	918	1253	n/a	n/a
51 / 1295	78 / 1981	962	1303	n/a	n/a
51 / 1295	79 / 2007	971	1318	n/a	n/a
51 / 1295	80 / 2032	986	1332	n/a	n/a
51 / 1295	84 / 2134	1031	1380	n/a	n/a
51 / 1295	85 / 2159	1041	1394	n/a	n/a
51 / 1295	86 / 2184	1052	1409	n/a	n/a

R Y _ F

2" Freestanding Screen – Upper Fabric Element

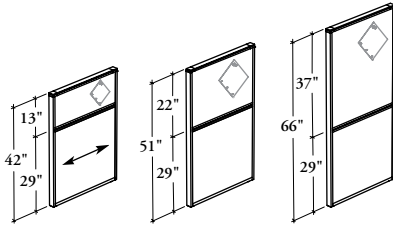

This Freestanding Screen may be connected to other Freestanding Screens, a wall or desk to divide space in a wide variety of applications.

WHAT'S INCLUDED

1 freestanding screen, 1 cable pass-through ring (as specified), and levelers.

WHAT'S EXCLUDED

Foot, Wall Connection Kit, Desk Connection Kit, Height-Change Connection Kit, Back Connection Kit, Lateral Connection Kit or Cable Pass-Through Cover (if applicable).

NOTES

All fabric elements must be specified with the same fabric grade and are two-sided.

End Pass-Through option (E) is **not** available with the following widths: 18", 28", 33", 34", 35", 37", 39", 40", 41", 43", 46", 52", 58", 64", 70", 76", 82", and 88".

Pass-Through ring comes in a Platinum Coordinate.

Two width applications are available: flush or extended. For details on these applications, see Application Guide of this section.

PRODUCT OPTIONS

Base Configuration	Height	Width	Frame Finish	Base Element Finish	Cable Pass-Through (for Laminate Base Configuration)
F Fabric	42, 51, 66	Flush Application: 20, 24, 30, 36, 40, 48, 54, 60, 66, 72, 78, 84 Extended Application: 18, 22, 26, 28, 32, 33, 34, 35, 37, 38, 39, 41, 42, 43, 44, 46, 50, 52, 56, 58, 62, 64, 68, 70, 74, 76, 80, 82, 86, 88	Foundation Mica	Panel Fabric	C Center Pass-Through E End Pass-Through N None (Shown)
L Laminate				Source Laminate	
				Upper Element Finish	
				Panel Fabric	

SAMPLE ORDER CODE

RYFF	66	60	E	C502	C502
------	----	----	---	------	------

DIMENSIONS INCHES / MM

H	W
42 / 1067	18 / 457
42 / 1067	20 / 508
42 / 1067	22 / 559
42 / 1067	24 / 610
42 / 1067	26 / 660
42 / 1067	28 / 737
42 / 1067	30 / 762
42 / 1067	32 / 813
42 / 1067	33 / 838
42 / 1067	34 / 864
42 / 1067	35 / 889
42 / 1067	36 / 914
42 / 1067	37 / 940
42 / 1067	38 / 965
42 / 1067	39 / 991
42 / 1067	40 / 1016
42 / 1067	41 / 1041
42 / 1067	42 / 1067
42 / 1067	43 / 1092
42 / 1067	44 / 1118
42 / 1067	46 / 1168
42 / 1067	48 / 1219
42 / 1067	50 / 1270
42 / 1067	52 / 1321
42 / 1067	54 / 1372
42 / 1067	56 / 1422
42 / 1067	58 / 1473
42 / 1067	60 / 1524
42 / 1067	62 / 1575
42 / 1067	64 / 1626
42 / 1067	66 / 1676
42 / 1067	68 / 1727

PRICING

SOURCE LAMINATE BASE ELEMENT

A/COM	Gr. 1	Gr. 2	Gr. 3	Gr. 4	Gr. 5	Gr. 6	Gr. 7
494	499	519	529	555	583	594	601
520	526	547	556	584	610	621	630
541	547	568	577	606	631	642	651
557	563	585	595	624	650	662	671
577	584	605	616	647	671	683	692
592	599	621	634	663	693	703	711
615	625	647	660	691	725	733	743
635	645	667	681	713	748	757	769
644	654	676	690	722	757	766	778
653	663	686	700	735	769	781	792
660	670	693	707	742	776	788	799
702	713	736	750	790	826	840	851
715	726	749	763	803	839	853	864
724	735	760	774	814	852	865	878
736	747	772	786	826	864	877	890
746	758	782	797	837	876	889	902
753	765	790	804	845	883	896	909
761	773	798	813	855	895	909	923
771	783	811	823	867	905	919	933
780	792	820	833	878	919	932	946
797	809	837	850	895	936	949	963
825	837	866	884	923	964	977	991
853	867	893	911	955	995	1011	1021
881	895	921	939	984	1023	1039	1049
897	911	939	957	1001	1044	1059	1070
924	938	966	984	1029	1071	1086	1097
946	960	988	1013	1059	1111	1129	1142
987	1001	1030	1058	1112	1163	1181	1198
1015	1035	1057	1086	1139	1185	1204	1220
1039	1059	1081	1111	1163	1214	1232	1249
1063	1083	1107	1137	1194	1250	1265	1283
1087	1106	1130	1160	1217	1273	1288	1306

FABRIC BASE ELEMENT

A/COM	Gr. 1	Gr. 2	Gr. 3	Gr. 4	Gr. 5	Gr. 6	Gr. 7
501	523	572	602	674	751	802	852
527	547	600	632	713	792	848	896
549	569	620	653	735	816	871	923
570	587	643	678	763	847	904	958
588	609	663	699	786	868	927	981
600	622	680	715	801	889	949	1006
625	651	712	754	853	954	1014	1078
642	673	732	772	867	965	1025	1092
655	687	745	790	888	988	1050	1111
662	696	755	797	897	995	1061	1126
668	702	760	805	905	1006	1073	1140
714	750	814	860	970	1081	1155	1226
725	764	828	874	989	1098	1174	1244
736	773	841	888	1001	1117	1190	1264
747	783	852	898	1015	1131	1204	1278
756	794	861	916	1034	1152	1230	1308
765	803	874	924	1042	1163	1241	1320
771	810	881	934	1057	1182	1263	1340
781	824	899	947	1072	1195	1275	1355
791	835	908	956	1084	1207	1286	1365
810	853	927	977	1102	1225	1309	1391
839	881	955	1012	1134	1260	1341	1426
867	911	986	1037	1164	1286	1374	1457
895	940	1011	1063	1184	1309	1399	1484
912	958	1032	1083	1207	1330	1422	1511
936	983	1057	1109	1234	1356	1450	1537
961	1009	1084	1144	1274	1409	1507	1603
1001	1049	1127	1193	1333	1472	1577	1680
1030	1090	1159	1226	1366	1501	1603	1704
1052	1110	1179	1249	1390	1526	1637	1746
1080	1138	1209	1282	1427	1574	1683	1793
1104	1160	1231	1312	1460	1613	1722	1831

Pricing is continued on the following page.

RY_F

2" Freestanding Screen – Upper Fabric Element (Continued)

DIMENSIONS
INCHES / MM

H	W
42 / 1067	70 / 1778
42 / 1067	72 / 1829
42 / 1067	74 / 1880
42 / 1067	76 / 1390
42 / 1067	78 / 1981
42 / 1067	80 / 2032
42 / 1067	82 / 2083
42 / 1067	84 / 2134
42 / 1067	86 / 2184
42 / 1067	88 / 2235
51 / 1295	18 / 457
51 / 1295	20 / 508
51 / 1295	22 / 559
51 / 1295	24 / 610
51 / 1295	26 / 660
51 / 1295	28 / 737
51 / 1295	30 / 762
51 / 1295	32 / 813
51 / 1295	33 / 838
51 / 1295	34 / 864
51 / 1295	35 / 889
51 / 1295	36 / 914
51 / 1295	37 / 940
51 / 1295	38 / 965
51 / 1295	39 / 991
51 / 1295	40 / 1016
51 / 1295	41 / 1041
51 / 1295	42 / 1067
51 / 1295	43 / 1092
51 / 1295	44 / 1118
51 / 1295	46 / 1168
51 / 1295	48 / 1219
51 / 1295	50 / 1270
51 / 1295	52 / 1321
51 / 1295	54 / 1372
51 / 1295	56 / 1422
51 / 1295	58 / 1473
51 / 1295	60 / 1524
51 / 1295	62 / 1575
51 / 1295	64 / 1626
51 / 1295	66 / 1676
51 / 1295	68 / 1727
51 / 1295	70 / 1778
51 / 1295	72 / 1829
51 / 1295	74 / 1880
51 / 1295	76 / 1390
51 / 1295	78 / 1981
51 / 1295	80 / 2032
51 / 1295	82 / 2083
51 / 1295	84 / 2134
51 / 1295	86 / 2184
51 / 1295	88 / 2235

PRICING

SOURCE LAMINATE BASE ELEMENT (CONTINUED)

A/COM	Gr. 1	Gr. 2	Gr. 3	Gr. 4	Gr. 5	Gr. 6	Gr. 7
1110	1130	1155	1184	1241	1298	1315	1334
1132	1152	1177	1208	1266	1324	1343	1361
1159	1179	1207	1235	1293	1351	1370	1388
1178	1198	1226	1255	1315	1373	1395	1411
1205	1226	1252	1283	1341	1400	1422	1440
1220	1241	1267	1300	1361	1420	1441	1459
1253	1274	1301	1333	1394	1453	1474	1492
1273	1294	1327	1355	1418	1479	1498	1517
1300	1321	1354	1383	1449	1510	1530	1550
1322	1343	1376	1406	1471	1537	1557	1576
567	574	596	606	632	661	673	682
602	612	631	641	673	698	709	718
607	617	642	659	700	741	754	768
638	651	677	692	736	778	790	804
653	667	692	714	760	804	819	832
684	698	723	745	791	835	850	863
702	716	745	765	813	858	873	889
712	729	755	777	824	873	885	902
727	751	774	797	841	888	900	917
740	764	787	810	854	901	913	930
751	775	798	821	864	912	924	941
798	820	843	867	911	958	970	988
815	838	860	884	928	975	987	1005
823	846	869	892	937	983	995	1013
833	858	880	902	947	994	1007	1024
844	869	891	914	958	1005	1018	1035
852	878	900	924	968	1014	1028	1044
863	890	911	937	982	1030	1048	1061
872	901	922	948	996	1043	1062	1076
887	917	938	964	1013	1059	1078	1094
913	944	964	993	1043	1091	1109	1127
928	961	980	1010	1060	1110	1126	1145
946	979	1004	1032	1084	1138	1157	1175
963	998	1025	1051	1105	1160	1182	1198
998	1033	1071	1088	1147	1204	1224	1244
1029	1065	1103	1122	1184	1242	1261	1279
1069	1108	1144	1170	1231	1292	1314	1334
1093	1133	1169	1200	1261	1327	1350	1371
1109	1150	1186	1218	1284	1353	1376	1397
1133	1175	1210	1245	1316	1386	1410	1435
1161	1205	1241	1278	1351	1428	1451	1475
1181	1225	1262	1299	1377	1453	1477	1501
1210	1255	1291	1333	1410	1489	1515	1541
1234	1282	1316	1363	1445	1522	1548	1576
1260	1309	1345	1391	1474	1555	1583	1612
1286	1336	1371	1421	1503	1587	1617	1645
1308	1365	1395	1451	1534	1620	1650	1677
1344	1401	1431	1488	1575	1662	1691	1724
1358	1417	1446	1503	1589	1675	1704	1736
1385	1449	1478	1540	1628	1720	1750	1781
1409	1474	1506	1566	1655	1748	1778	1812
1434	1501	1532	1593	1686	1779	1814	1843

FABRIC BASE ELEMENT (CONTINUED)

A/COM	Gr. 1	Gr. 2	Gr. 3	Gr. 4	Gr. 5	Gr. 6	Gr. 7
1129	1189	1259	1336	1487	1640	1755	1870
1160	1212	1287	1369	1526	1684	1800	1917
1180	1237	1311	1396	1556	1716	1833	1950
1205	1266	1340	1424	1585	1746	1873	1989
1230	1289	1362	1456	1623	1790	1917	2041
1250	1312	1383	1474	1642	1810	1936	2059
1285	1343	1419	1509	1675	1843	1971	2098
1306	1368	1447	1542	1711	1882	2012	2141
1334	1396	1476	1570	1746	1919	2048	2179
1354	1415	1495	1596	1782	1963	2094	2221
574	595	644	675	751	824	879	929
611	632	683	717	802	886	936	987
614	641	695	736	829	926	983	1039
643	673	732	772	872	971	1030	1089
662	691	748	795	893	995	1058	1116
693	723	783	827	930	1031	1095	1156
713	741	812	858	975	1088	1155	1224
721	758	821	871	982	1093	1157	1227
737	784	842	894	1004	1116	1181	1247
750	795	857	907	1014	1127	1193	1264
760	808	868	919	1027	1138	1208	1279
811	860	922	978	1091	1209	1282	1361
825	875	939	996	1116	1238	1311	1390
836	883	948	1004	1122	1246	1317	1397
843	894	960	1015	1136	1259	1334	1411
854	909	973	1032	1155	1281	1359	1438
865	918	983	1043	1170	1297	1377	1457
873	928	994	1059	1188	1316	1401	1481
882	941	1009	1072	1202	1333	1416	1495
897	958	1025	1088	1218	1345	1431	1511
925	988	1052	1119	1251	1379	1468	1555
942	1004	1070	1137	1271	1403	1491	1582
958	1023	1096	1159	1292	1432	1522	1610
977	1046	1118	1177	1314	1447	1543	1635
1012	1079	1161	1214	1352	1491	1588	1683
1044	1113	1198	1253	1395	1534	1632	1726
1084	1156	1239	1301	1445	1589	1692	1794
1114	1183	1270	1336	1485	1637	1747	1853
1125	1205	1286	1357	1508	1664	1774	1881
1148	1228	1309	1383	1544	1701	1818	1932
1176	1257	1340	1420	1588	1752	1866	1982
1203	1286	1370	1452	1623	1793	1908	2025
1227	1310	1394	1486	1659	1830	1954	2077
1260	1342	1424	1521	1703	1881	2005	2131
1287	1369	1453	1554	1743	1927	2054	2182
1307	1397	1477	1584	1771	1957	2087	2217
1337	1432	1509	1625	1816	2009	2146	2275
1373	1468	1546	1664	1862	2058	2192	2330
1386	1488	1562	1681	1871	2063	2201	2339
1417	1522	1595	1722	1923	2124	2265	2407
1439	1547	1624	1752	1955	2160	2300	2444
1469	1576	1652	1783	1992	2202	2347	2486

Pricing is continued on the following page.

RY_F

2" Freestanding Screen – Upper Fabric Element (Continued)

DIMENSIONS
INCHES / MM

PRICING

DIMENSIONS		SOURCE LAMINATE BASE ELEMENT								FABRIC BASE ELEMENT							
H	W	A/COM	Gr. 1	Gr. 2	Gr. 3	Gr. 4	Gr. 5	Gr. 6	Gr. 7	A/COM	Gr. 1	Gr. 2	Gr. 3	Gr. 4	Gr. 5	Gr. 6	Gr. 7
66 / 1676	18 / 457	763	787	830	853	924	995	1018	1039	770	807	881	923	1045	1164	1228	1291
66 / 1676	20 / 508	799	824	866	889	964	1033	1056	1079	809	846	917	966	1093	1218	1282	1347
66 / 1676	22 / 559	822	848	892	922	994	1068	1094	1113	829	870	945	999	1127	1253	1323	1384
66 / 1676	24 / 610	854	882	930	962	1040	1117	1142	1166	862	904	984	1041	1178	1314	1385	1454
66 / 1676	26 / 660	876	903	951	983	1061	1138	1163	1187	885	927	1006	1064	1196	1329	1401	1472
66 / 1676	28 / 737	899	926	977	1009	1092	1177	1203	1229	907	951	1036	1090	1233	1373	1449	1523
66 / 1676	30 / 762	944	974	1028	1064	1157	1246	1275	1303	953	999	1092	1157	1315	1472	1551	1629
66 / 1676	32 / 813	966	996	1052	1092	1189	1285	1317	1347	975	1028	1122	1187	1348	1509	1594	1675
66 / 1676	33 / 838	983	1016	1071	1112	1209	1306	1338	1368	995	1049	1139	1210	1371	1534	1618	1699
66 / 1676	34 / 864	986	1022	1076	1119	1218	1316	1346	1377	996	1054	1144	1215	1378	1545	1629	1714
66 / 1676	35 / 889	1008	1047	1102	1147	1250	1348	1378	1412	1018	1082	1174	1247	1416	1583	1667	1755
66 / 1676	36 / 914	1078	1116	1178	1227	1336	1447	1484	1520	1089	1156	1257	1335	1516	1697	1795	1892
66 / 1676	37 / 940	1095	1133	1198	1244	1355	1464	1501	1537	1106	1171	1278	1358	1544	1728	1825	1922
66 / 1676	38 / 965	1105	1144	1208	1254	1366	1478	1513	1549	1119	1181	1286	1367	1552	1739	1838	1935
66 / 1676	39 / 991	1123	1159	1225	1271	1381	1493	1528	1564	1132	1196	1306	1381	1567	1754	1851	1946
66 / 1676	40 / 1016	1132	1171	1235	1286	1399	1512	1547	1583	1142	1211	1317	1406	1597	1792	1890	1991
66 / 1676	41 / 1041	1141	1180	1246	1295	1408	1521	1556	1592	1151	1219	1328	1415	1609	1805	1907	2006
66 / 1676	42 / 1067	1161	1203	1277	1321	1439	1556	1595	1632	1172	1243	1363	1440	1639	1838	1943	2047
66 / 1676	43 / 1092	1181	1222	1296	1340	1458	1577	1616	1652	1189	1262	1383	1463	1664	1867	1971	2072
66 / 1676	44 / 1118	1196	1237	1312	1359	1482	1594	1634	1671	1210	1278	1399	1482	1684	1879	1988	2089
66 / 1676	46 / 1168	1225	1273	1342	1390	1511	1629	1670	1705	1235	1317	1430	1516	1718	1918	2029	2133
66 / 1676	48 / 1219	1263	1315	1382	1430	1550	1667	1708	1743	1273	1358	1471	1556	1760	1959	2072	2178
66 / 1676	50 / 1270	1301	1352	1419	1475	1595	1718	1757	1798	1312	1395	1510	1602	1804	2010	2123	2233
66 / 1676	52 / 1321	1330	1386	1448	1504	1624	1741	1780	1819	1345	1433	1542	1631	1838	2041	2146	2259
66 / 1676	54 / 1372	1363	1419	1481	1542	1665	1787	1830	1868	1381	1467	1575	1670	1870	2075	2196	2310
66 / 1676	56 / 1422	1399	1456	1520	1584	1715	1844	1887	1928	1414	1503	1615	1713	1926	2136	2257	2374
66 / 1676	58 / 1473	1436	1490	1560	1620	1756	1886	1931	1970	1451	1538	1657	1753	1971	2184	2312	2433
66 / 1676	60 / 1524	1501	1555	1650	1710	1866	2025	2074	2122	1518	1603	1747	1845	2091	2336	2473	2606
66 / 1676	62 / 1575	1525	1580	1680	1737	1898	2054	2105	2153	1540	1632	1779	1875	2120	2364	2502	2635
66 / 1676	64 / 1626	1557	1614	1712	1772	1933	2090	2141	2194	1573	1669	1812	1914	2163	2407	2549	2692
66 / 1676	66 / 1676	1597	1647	1746	1808	1969	2129	2180	2231	1617	1702	1849	1953	2205	2455	2598	2743
66 / 1676	68 / 1727	1632	1683	1785	1848	2009	2176	2229	2278	1651	1739	1889	1998	2254	2513	2658	2799
66 / 1676	70 / 1778	1667	1716	1818	1882	2048	2212	2266	2318	1685	1774	1921	2036	2296	2554	2708	2855
66 / 1676	72 / 1829	1703	1752	1855	1921	2088	2260	2312	2366	1727	1811	1960	2079	2347	2617	2767	2920
66 / 1676	74 / 1880	1737	1786	1897	1958	2131	2302	2356	2410	1762	1847	2004	2121	2398	2670	2824	2974
66 / 1676	76 / 1390	1770	1819	1929	1990	2165	2337	2390	2446	1796	1882	2040	2158	2438	2716	2868	3027
66 / 1676	78 / 1981	1806	1854	1966	2027	2201	2374	2430	2485	1833	1918	2078	2200	2485	2763	2925	3085
66 / 1676	80 / 2032	1839	1887	1999	2061	2238	2413	2467	2523	1868	1953	2113	2236	2524	2810	2968	3130
66 / 1676	82 / 2083	1873	1921	2033	2097	2275	2450	2506	2561	1902	1991	2150	2273	2555	2839	3002	3165
66 / 1676	84 / 2134	1911	1960	2073	2138	2314	2493	2550	2607	1941	2030	2192	2319	2606	2895	3060	3227
66 / 1676	86 / 2184	1942	1991	2103	2170	2348	2531	2589	2643	1973	2063	2222	2355	2647	2944	3111	3275
66 / 1676	88 / 2235	1979	2026	2138	2205	2386	2566	2624	2678	2011	2096	2256	2393	2692	2993	3158	3323

RY_G

2" Freestanding Screen – Upper Glass Element

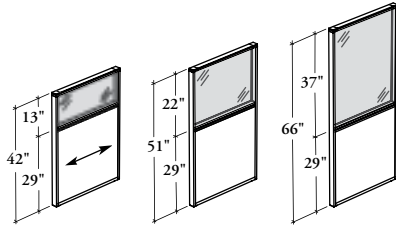

This Freestanding Screen may be connected to other Freestanding Screens, a wall or desk to provide varying degrees of visual privacy above worksurface height.

WHAT'S INCLUDED

1 freestanding screen, 1 cable pass-through ring (as specified) and levelers.

WHAT'S EXCLUDED

Foot, Wall Connection Kit, Desk Connection Kit, Height-Change Connection Kit, Back Connection Kit, Lateral Connection Kit or Cable Pass-Through Cover (if applicable).

NOTES

Tempered glass elements are two-sided for a flush look.

Frosted (FT) is a single-sided etched glass which is facing inward of the two-sided glass assembly.

All fabric elements must be specified with the same fabric grade and are two-sided.

End Pass-Through option (E) is **not** available with the following widths: 18", 28", 33", 34", 35", 37", 39", 40", 41", 43", 46", 52", 58", 64", 70", 76", 82", and 88".

Pass-Through ring comes in a Platinum Coordinate.

Two width applications are available: flush or extended. For details on these applications, see Application Guide of this section.

PRODUCT OPTIONS

Base Configuration	Height	Width	Frame Finish	Base Element Finish	Cable Pass-Through (for Laminate Base Configuration)
F Fabric	42, 51, 66	Flush Application: 20, 24, 30, 36, 40, 48, 54, 60, 66, 72, 78, 84 Extended Application: 18, 22, 26, 28, 32, 33, 34, 35, 37, 38, 39, 41, 42, 43, 44, 46, 50, 52, 56, 58, 62, 64, 68, 70, 74, 76, 80, 82, 86, 88	Foundation Mica	Panel Fabric	C Center Pass-Through E End Pass-Through N None (Shown)
L Laminate				Source Laminate	
		Glass Finish			
		CL Clear	FT Frosted		

SAMPLE ORDER CODE

RYFG	51	48	J	3E	CL
-------------	-----------	-----------	----------	-----------	-----------

DIMENSIONS – INCHES FOR MM X BY 25.4

PRICING

		CLEAR GLASS (CL)									FROSTED GLASS (FT)								
H	W	Source Laminate	A/COM	Gr. 1	Gr. 2	Gr. 3	Gr. 4	Gr. 5	Gr. 6	Gr. 7	Source Laminate	A/COM	Gr. 1	Gr. 2	Gr. 3	Gr. 4	Gr. 5	Gr. 6	Gr. 7
42	18	522	528	544	573	592	639	689	731	771	599	605	621	650	669	716	766	808	848
42	20	554	567	578	609	635	689	742	783	825	634	647	658	689	715	769	822	863	905
42	22	575	585	597	629	652	708	764	809	849	659	669	681	713	736	792	848	893	933
42	24	604	611	628	660	684	741	797	843	890	691	698	715	747	771	828	884	930	977
42	26	633	640	658	689	715	768	825	871	918	725	732	750	781	807	860	917	963	1010
42	28	646	657	670	706	727	784	842	893	942	741	752	765	801	822	879	937	988	1037
42	30	677	689	704	746	771	836	904	956	1007	776	788	803	845	870	935	1003	1055	1106
42	32	715	722	744	781	807	870	934	986	1038	823	830	852	889	915	978	1042	1094	1146
42	33	717	724	748	783	813	877	942	995	1045	827	834	858	893	923	987	1052	1105	1155
42	34	724	734	760	795	821	886	949	1003	1056	839	849	875	910	936	1001	1064	1118	1171
42	35	733	744	766	805	833	899	964	1020	1076	849	860	882	921	949	1015	1080	1136	1192
42	36	781	791	818	860	890	962	1036	1095	1157	904	914	941	983	1013	1085	1159	1218	1280
42	37	789	800	826	867	897	966	1039	1099	1161	913	924	950	991	1021	1090	1163	1223	1285
42	38	795	807	834	875	908	983	1056	1116	1177	921	933	960	1001	1034	1109	1182	1242	1303
42	39	815	828	854	896	929	1005	1080	1139	1201	944	957	983	1025	1058	1134	1209	1268	1330
42	40	822	835	862	906	938	1014	1090	1157	1219	955	968	995	1039	1071	1147	1223	1290	1352
42	41	836	847	876	919	955	1032	1112	1179	1242	969	980	1009	1052	1088	1165	1245	1312	1375
42	42	847	860	887	930	966	1049	1130	1196	1260	982	995	1022	1065	1101	1184	1265	1331	1395
42	43	864	876	904	949	987	1070	1154	1219	1284	1007	1019	1047	1092	1130	1213	1297	1362	1427
42	44	879	890	920	965	1000	1082	1165	1231	1295	1023	1034	1064	1109	1144	1226	1309	1375	1439
42	46	907	919	949	994	1031	1112	1194	1263	1334	1055	1067	1097	1142	1179	1260	1342	1411	1482
42	48	923	935	966	1013	1049	1130	1211	1284	1356	1075	1087	1118	1165	1201	1282	1363	1436	1508
42	50	962	973	1006	1050	1086	1168	1250	1321	1393	1119	1130	1163	1207	1243	1325	1407	1478	1550
42	52	989	999	1032	1080	1115	1197	1282	1356	1430	1154	1164	1197	1245	1280	1362	1447	1521	1595
42	54	1010	1027	1057	1105	1137	1220	1300	1377	1456	1177	1194	1224	1272	1304	1387	1467	1544	1623
42	56	1042	1057	1087	1133	1168	1249	1328	1406	1484	1214	1229	1259	1305	1340	1421	1500	1578	1656
42	58	1070	1082	1116	1163	1197	1281	1362	1442	1525	1245	1257	1291	1338	1372	1456	1537	1617	1700
42	60	1112	1126	1161	1206	1242	1326	1409	1496	1581	1293	1307	1342	1387	1423	1507	1590	1677	1762
42	62	1123	1138	1170	1219	1257	1346	1433	1520	1607	1314	1329	1361	1410	1448	1537	1624	1711	1798
42	64	1154	1167	1205	1253	1290	1376	1462	1554	1646	1350	1363	1401	1449	1486	1572	1658	1750	1842
42	66	1179	1199	1237	1284	1324	1411	1498	1592	1682	1379	1399	1437	1484	1524	1611	1698	1792	1882

R Y _ G

2" Freestanding Screen – Upper Glass Element (Continued)

DIMENSIONS – INCHES
FOR MM X BY 25.4

PRICING

		CLEAR GLASS (CL) (CONTINUED)										FROSTED GLASS (FT) (CONTINUED)									
H	W	Source Laminate	A/COM	Gr. 1	Gr. 2	Gr. 3	Gr. 4	Gr. 5	Gr. 6	Gr. 7	Source Laminate	A/COM	Gr. 1	Gr. 2	Gr. 3	Gr. 4	Gr. 5	Gr. 6	Gr. 7		
42	68	1040	1223	1259	1310	1351	1441	1534	1625	1717	1410	1427	1463	1514	1555	1645	1738	1829	1921		
42	70	1066	1253	1290	1339	1383	1477	1572	1666	1764	1448	1464	1501	1550	1594	1688	1783	1877	1975		
42	72	1085	1286	1321	1369	1416	1514	1609	1709	1806	1472	1499	1534	1582	1629	1727	1822	1922	2019		
42	74	1111	1313	1346	1397	1450	1546	1648	1746	1842	1509	1533	1566	1617	1670	1766	1868	1966	2062		
42	76	1132	1339	1375	1423	1478	1580	1682	1783	1886	1539	1565	1601	1649	1704	1806	1908	2009	2112		
42	78	1157	1371	1409	1457	1514	1621	1724	1830	1935	1574	1603	1641	1689	1746	1853	1956	2062	2167		
42	80	1182	1400	1437	1488	1544	1654	1763	1868	1972	1608	1637	1674	1725	1781	1891	2000	2105	2209		
42	82	1204	1424	1465	1516	1574	1679	1782	1892	2000	1637	1664	1705	1756	1814	1919	2022	2132	2240		
42	84	1229	1458	1499	1551	1608	1718	1828	1938	2050	1671	1703	1744	1796	1853	1963	2073	2183	2295		
42	86	1255	1485	1528	1581	1639	1754	1865	1975	2086	1707	1736	1779	1832	1890	2005	2116	2226	2337		
42	88	1276	1514	1553	1608	1670	1784	1900	2010	2122	1735	1769	1808	1863	1925	2039	2155	2265	2377		
51	18	641	651	665	695	715	762	810	850	892	751	761	775	805	825	872	920	960	1002		
51	20	683	690	704	733	760	813	868	909	950	801	808	822	851	878	931	986	1027	1068		
51	22	715	720	734	764	790	846	900	947	989	838	843	857	887	913	969	1023	1070	1112		
51	24	747	755	767	803	826	886	944	992	1037	878	886	898	934	957	1017	1075	1123	1168		
51	26	785	793	810	841	867	921	977	1022	1070	923	931	948	979	1005	1059	1115	1160	1208		
51	28	797	807	821	858	880	940	998	1047	1096	941	951	965	1002	1024	1084	1142	1191	1240		
51	30	841	849	867	907	934	1000	1070	1122	1172	995	1003	1021	1061	1088	1154	1224	1276	1326		
51	32	867	876	896	934	960	1025	1089	1140	1194	1033	1042	1062	1100	1126	1191	1255	1306	1360		
51	33	882	891	912	949	980	1044	1112	1165	1215	1050	1059	1080	1117	1148	1212	1280	1333	1383		
51	34	890	898	922	960	987	1052	1119	1172	1226	1061	1069	1093	1131	1158	1223	1290	1343	1397		
51	35	915	923	948	986	1013	1080	1147	1202	1256	1088	1096	1121	1159	1186	1253	1320	1375	1429		
51	36	957	969	995	1037	1068	1138	1211	1273	1334	1138	1150	1176	1218	1249	1319	1392	1454	1515		
51	37	980	991	1015	1057	1089	1165	1239	1299	1360	1163	1174	1198	1240	1272	1348	1422	1482	1543		
51	38	996	1008	1036	1078	1111	1184	1259	1319	1380	1189	1201	1229	1271	1304	1377	1452	1512	1573		
51	39	1008	1020	1044	1087	1122	1198	1278	1337	1399	1204	1216	1240	1283	1318	1394	1474	1533	1595		
51	40	1032	1042	1071	1114	1152	1231	1310	1373	1438	1232	1242	1271	1314	1352	1431	1510	1573	1638		
51	41	1050	1063	1087	1132	1169	1252	1334	1400	1463	1252	1265	1289	1334	1371	1454	1536	1602	1665		
51	42	1053	1065	1092	1137	1173	1255	1337	1404	1469	1258	1270	1297	1342	1378	1460	1542	1609	1674		
51	43	1085	1096	1126	1172	1209	1291	1375	1441	1506	1298	1309	1339	1385	1422	1504	1588	1654	1719		
51	44	1102	1114	1144	1191	1223	1303	1383	1451	1515	1321	1333	1363	1410	1442	1522	1602	1670	1734		
51	46	1137	1151	1180	1226	1260	1343	1424	1493	1565	1361	1375	1404	1450	1484	1567	1648	1717	1789		
51	48	1152	1163	1195	1240	1279	1362	1442	1515	1585	1379	1390	1422	1467	1506	1589	1669	1742	1812		
51	50	1208	1219	1252	1299	1335	1419	1500	1573	1643	1445	1456	1489	1536	1572	1656	1737	1810	1880		
51	52	1244	1256	1289	1336	1370	1453	1535	1608	1683	1489	1501	1534	1581	1615	1698	1780	1853	1928		
51	54	1260	1279	1308	1355	1387	1469	1549	1625	1703	1513	1532	1561	1608	1640	1722	1802	1878	1956		
51	56	1312	1327	1360	1407	1440	1521	1603	1681	1757	1574	1589	1622	1669	1702	1783	1865	1943	2019		
51	58	1346	1365	1397	1442	1480	1563	1646	1727	1807	1614	1633	1665	1710	1748	1831	1914	1995	2075		
51	60	1379	1394	1427	1477	1515	1603	1690	1777	1862	1661	1676	1709	1759	1797	1885	1972	2059	2144		
51	62	1420	1434	1473	1516	1558	1645	1731	1819	1904	1709	1723	1762	1805	1847	1934	2020	2108	2193		
51	64	1457	1472	1510	1557	1597	1683	1772	1862	1953	1752	1767	1805	1852	1892	1978	2067	2157	2248		
51	66	1488	1507	1543	1593	1634	1724	1815	1908	2001	1792	1811	1847	1897	1938	2028	2119	2212	2305		
51	68	1525	1543	1580	1631	1676	1771	1864	1957	2051	1837	1855	1892	1943	1988	2083	2176	2269	2363		
51	70	1559	1579	1617	1663	1713	1807	1902	2001	2095	1878	1898	1936	1982	2032	2126	2221	2320	2414		
51	72	1597	1622	1655	1704	1755	1855	1953	2053	2149	1921	1946	1979	2028	2079	2179	2277	2377	2473		
51	74	1632	1655	1691	1738	1796	1897	2000	2096	2197	1970	1993	2029	2076	2134	2235	2338	2434	2535		
51	76	1665	1691	1731	1776	1834	1937	2037	2141	2242	2010	2036	2076	2121	2179	2282	2382	2486	2587		
51	78	1703	1731	1769	1815	1878	1984	2090	2197	2299	2053	2081	2119	2165	2228	2334	2440	2547	2649		
51	80	1737	1766	1807	1855	1913	2021	2124	2230	2332	2099	2128	2169	2217	2275	2383	2486	2592	2694		
51	82	1772	1801	1840	1890	1951	2062	2172	2281	2384	2142	2171	2210	2260	2321	2432	2542	2651	2754		
51	84	1807	1837	1882	1931	1995	2109	2219	2329	2441	2181	2211	2256	2305	2369	2483	2593	2703	2815		
51	86	1837	1873	1912	1967	2025	2139	2252	2359	2470	2215	2251	2290	2345	2403	2517	2630	2737	2848		
51	88	1880	1913	1952	2008	2068	2185	2299	2412	2522	2265	2298	2337	2393	2453	2570	2684	2797	2907		

Pricing is continued on the following page.

RY_G

2" Freestanding Screen – Upper Glass Element (Continued)

DIMENSIONS – INCHES

FOR MM X BY 25.4

PRICING

H	W	CLEAR GLASS (CL)									FROSTED GLASS (FT)								
		Source Laminate	A/COM	Gr. 1	Gr. 2	Gr. 3	Gr. 4	Gr. 5	Gr. 6	Gr. 7	Source Laminate	A/COM	Gr. 1	Gr. 2	Gr. 3	Gr. 4	Gr. 5	Gr. 6	Gr. 7
66	18	880	889	900	933	950	998	1045	1087	1129	1076	1085	1096	1129	1146	1194	1241	1283	1325
66	20	941	949	963	993	1017	1071	1126	1168	1209	1150	1158	1172	1202	1226	1280	1335	1377	1418
66	22	981	989	1000	1032	1057	1112	1168	1211	1254	1203	1211	1222	1254	1279	1334	1390	1433	1476
66	24	1034	1041	1056	1087	1114	1169	1226	1273	1318	1269	1276	1291	1322	1349	1404	1461	1508	1553
66	26	1081	1089	1109	1137	1163	1219	1277	1321	1366	1330	1338	1358	1386	1412	1468	1526	1570	1615
66	28	1132	1141	1159	1194	1215	1273	1329	1379	1429	1394	1403	1421	1456	1477	1535	1591	1641	1691
66	30	1172	1182	1199	1240	1263	1332	1399	1451	1500	1449	1459	1476	1517	1540	1609	1676	1728	1777
66	32	1211	1220	1242	1282	1305	1369	1431	1484	1536	1500	1509	1531	1571	1594	1658	1720	1773	1825
66	33	1239	1247	1267	1303	1335	1402	1465	1518	1572	1532	1540	1560	1596	1628	1695	1758	1811	1865
66	34	1285	1293	1318	1355	1380	1444	1507	1563	1615	1591	1599	1624	1661	1686	1750	1813	1869	1921
66	35	1284	1291	1317	1353	1380	1448	1511	1566	1622	1593	1600	1626	1662	1689	1757	1820	1875	1931
66	36	1346	1360	1384	1426	1458	1531	1603	1662	1723	1672	1686	1710	1752	1784	1857	1929	1988	2049
66	37	1358	1369	1394	1434	1470	1546	1622	1682	1741	1691	1702	1727	1767	1803	1879	1955	2015	2074
66	38	1383	1394	1421	1463	1498	1574	1650	1709	1769	1724	1735	1762	1804	1839	1915	1991	2050	2110
66	39	1416	1427	1456	1499	1531	1604	1681	1740	1801	1762	1773	1802	1845	1877	1950	2027	2086	2147
66	40	1433	1444	1473	1515	1553	1633	1713	1777	1840	1788	1799	1828	1870	1908	1988	2068	2132	2195
66	41	1460	1472	1500	1543	1580	1660	1739	1806	1871	1821	1833	1861	1904	1941	2021	2100	2167	2232
66	42	1485	1498	1525	1569	1607	1690	1774	1839	1904	1853	1866	1893	1937	1975	2058	2142	2207	2272
66	43	1511	1522	1551	1598	1634	1717	1800	1865	1931	1886	1897	1926	1973	2009	2092	2175	2240	2306
66	44	1536	1546	1578	1623	1659	1739	1822	1887	1952	1923	1933	1965	2010	2046	2126	2209	2274	2339
66	46	1586	1597	1631	1676	1711	1791	1869	1940	2008	1984	1995	2029	2074	2109	2189	2267	2338	2406
66	48	1632	1643	1676	1720	1757	1837	1920	1994	2062	2038	2049	2082	2126	2163	2243	2326	2400	2468
66	50	1688	1699	1731	1778	1813	1897	1979	2053	2123	2108	2119	2151	2198	2233	2317	2399	2473	2543
66	52	1737	1752	1781	1828	1862	1945	2027	2101	2176	2172	2187	2216	2263	2297	2380	2462	2536	2611
66	54	1779	1796	1827	1873	1907	1986	2067	2145	2223	2227	2244	2275	2321	2355	2434	2515	2593	2671
66	56	1837	1854	1885	1931	1967	2050	2127	2205	2284	2299	2316	2347	2393	2429	2512	2589	2667	2746
66	58	1887	1904	1937	1982	2021	2102	2184	2267	2348	2363	2380	2413	2458	2497	2578	2660	2743	2824
66	60	1951	1967	2000	2050	2086	2174	2261	2349	2437	2446	2462	2495	2545	2581	2669	2756	2844	2932
66	62	1987	2004	2042	2085	2126	2211	2298	2384	2471	2500	2517	2555	2598	2639	2724	2811	2897	2984
66	64	2039	2056	2093	2141	2180	2268	2356	2446	2538	2566	2583	2620	2668	2707	2795	2883	2973	3065
66	66	2090	2109	2145	2195	2235	2325	2415	2507	2601	2626	2645	2681	2731	2771	2861	2951	3043	3137
66	68	2140	2156	2197	2243	2290	2380	2474	2567	2661	2690	2706	2747	2793	2840	2930	3024	3117	3211
66	70	2189	2207	2246	2293	2343	2439	2537	2633	2729	2756	2774	2813	2860	2910	3006	3104	3200	3296
66	72	2241	2265	2299	2349	2402	2499	2600	2697	2796	2816	2840	2874	2924	2977	3074	3175	3272	3371
66	74	2292	2319	2354	2402	2456	2555	2661	2760	2857	2886	2913	2948	2996	3050	3149	3255	3354	3451
66	76	2343	2369	2405	2451	2503	2610	2711	2814	2914	2954	2980	3016	3062	3114	3221	3322	3425	3525
66	78	2397	2419	2457	2502	2561	2667	2774	2878	2982	3016	3038	3076	3121	3180	3286	3393	3497	3601
66	80	2443	2468	2504	2557	2616	2724	2834	2939	3043	3081	3106	3142	3195	3254	3362	3472	3577	3681
66	82	2493	2523	2561	2613	2668	2776	2884	2990	3097	3147	3177	3215	3267	3322	3430	3538	3644	3751
66	84	2544	2576	2616	2668	2725	2837	2945	3057	3167	3205	3237	3277	3329	3386	3498	3606	3718	3828
66	86	2591	2624	2667	2721	2779	2891	3002	3112	3220	3265	3298	3341	3395	3453	3565	3676	3786	3894
66	88	2642	2676	2718	2774	2835	2952	3069	3181	3290	3325	3359	3401	3457	3518	3635	3752	3864	3973

RY_FG

2" Freestanding Screen – Middle Fabric and Upper Glass Elements

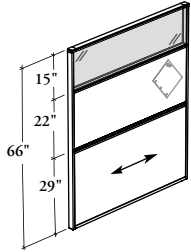

This Freestanding Screen may be connected to other Freestanding Screens, a wall or desk to provide varying degrees of visual privacy above worksurface height.

WHAT'S INCLUDED

1 freestanding screen, 1 cable pass-through ring (as specified), and levelers.

WHAT'S EXCLUDED

Foot, Wall Connection Kit, Desk Connection Kit, Height-Change Connection Kit, Back Connection Kit, Lateral Connection Kit or Cable Pass-Through Cover (if applicable).

NOTES

Tempered glass elements are two-sided for a flush look.

Frosted (FT) is a single-sided etched glass which is facing inward of the two-sided glass assembly.

All fabric elements must be specified with the same fabric grade and are two-sided.

End Pass-Through option (E) is not available with the following widths: 18", 28", 33", 34", 35", 37", 39", 40", 41", 43", 46", 52", 58", 64", 70", 76", 82", and 88".

Cable Pass-Through ring comes in a Platinum Coordinate.

Two width applications are available: flush or extended. For details on these applications, see Application Guide of this section.

PRODUCT OPTIONS

Base Configuration	Height	Width	Frame Finish	Middle Element Finish	Cable Pass-Through (for Laminate Base Configuration)
F Fabric	66	Flush Application: 20, 24, 30, 36, 40, 48, 54, 60, 66, 72, 78, 84 Extended Application: 18, 22, 26, 28, 32, 33, 34, 35, 37, 38, 39, 41, 42, 43, 44, 46, 50, 52, 56, 58, 62, 64, 68, 70, 74, 76, 80, 82, 86, 88	Foundation	Panel Fabric	C Center Pass-Through E End Pass-Through N None (Shown)
L Laminate			Mica		
			Base Element Finish Panel Fabric Source Laminate	Glass Finish CL Clear FT Frosted	

SAMPLE ORDER CODE

RYFG	66	18	E	C502	C502	FT
------	----	----	---	------	------	----

DIMENSIONS INCHES / MM

DIMENSIONS		PRICING															
H	W	FABRIC BASE ELEMENT								FROSTED GLASS (FT)							
		CLEAR GLASS (CL)								FROSTED GLASS (FT)							
		A/COM	Gr. 1	Gr. 2	Gr. 3	Gr. 4	Gr. 5	Gr. 6	Gr. 7	A/COM	Gr. 1	Gr. 2	Gr. 3	Gr. 4	Gr. 5	Gr. 6	Gr. 7
66 / 1676	18 / 457	845	881	956	996	1118	1235	1301	1363	926	962	1037	1077	1199	1316	1382	1444
66 / 1676	20 / 508	874	912	983	1032	1159	1282	1349	1413	961	999	1070	1119	1246	1369	1436	1500
66 / 1676	22 / 559	912	953	1026	1079	1207	1335	1404	1466	1005	1046	1119	1172	1300	1428	1497	1559
66 / 1676	24 / 610	943	985	1068	1123	1259	1395	1466	1536	1039	1081	1164	1219	1355	1491	1562	1632
66 / 1676	26 / 660	1023	1067	1147	1201	1333	1468	1540	1609	1130	1174	1254	1308	1440	1575	1647	1716
66 / 1676	28 / 737	1030	1073	1158	1212	1357	1498	1574	1651	1143	1186	1271	1325	1470	1611	1687	1764
66 / 1676	30 / 762	1066	1111	1207	1267	1428	1589	1668	1747	1184	1229	1325	1385	1546	1707	1786	1865
66 / 1676	32 / 813	1082	1132	1225	1294	1457	1621	1704	1789	1204	1254	1347	1416	1579	1743	1826	1911
66 / 1676	33 / 838	1114	1166	1259	1330	1490	1657	1740	1821	1239	1291	1384	1455	1615	1782	1865	1946
66 / 1676	34 / 864	1200	1256	1349	1421	1581	1746	1829	1915	1329	1385	1478	1550	1710	1875	1958	2044
66 / 1676	35 / 889	1211	1271	1363	1438	1607	1772	1859	1948	1342	1402	1494	1569	1738	1903	1990	2079
66 / 1676	36 / 914	1220	1287	1391	1467	1650	1831	1929	2025	1358	1425	1529	1605	1788	1969	2067	2163
66 / 1676	37 / 940	1265	1332	1438	1517	1699	1884	1981	2077	1407	1474	1580	1659	1841	2026	2123	2219
66 / 1676	38 / 965	1289	1351	1456	1536	1724	1908	2002	2099	1433	1495	1600	1680	1868	2052	2146	2243
66 / 1676	39 / 991	1309	1374	1483	1561	1744	1933	2027	2126	1457	1522	1631	1709	1892	2081	2175	2274
66 / 1676	40 / 1016	1334	1398	1507	1594	1789	1980	2081	2180	1487	1551	1660	1747	1942	2133	2234	2333
66 / 1676	41 / 1041	1355	1423	1533	1622	1816	2009	2111	2212	1509	1577	1687	1776	1970	2163	2265	2366
66 / 1676	42 / 1067	1371	1439	1559	1642	1841	2042	2148	2250	1525	1593	1713	1796	1995	2196	2302	2404
66 / 1676	43 / 1092	1401	1473	1594	1675	1878	2077	2183	2285	1562	1634	1755	1836	2039	2238	2344	2446
66 / 1676	44 / 1118	1425	1495	1616	1699	1902	2108	2205	2307	1591	1661	1782	1865	2068	2274	2371	2473
66 / 1676	46 / 1168	1469	1548	1662	1746	1950	2154	2260	2364	1638	1717	1831	1915	2119	2323	2429	2533
66 / 1676	48 / 1219	1523	1607	1720	1805	2010	2210	2316	2422	1696	1780	1893	1978	2183	2383	2489	2595

Pricing is continued on the following page.

RY_FG

2" Freestanding Screen – Middle Fabric and Upper Glass Elements (Continued)

DIMENSIONS
INCHES / MM

H	W
66 / 1676	50 / 1270
66 / 1676	52 / 1321
66 / 1676	54 / 1372
66 / 1676	56 / 1422
66 / 1676	58 / 1473
66 / 1676	60 / 1524
66 / 1676	62 / 1575
66 / 1676	64 / 1626
66 / 1676	66 / 1676
66 / 1676	68 / 1727
66 / 1676	70 / 1778
66 / 1676	72 / 1829
66 / 1676	74 / 1880
66 / 1676	76 / 1930
66 / 1676	78 / 1981
66 / 1676	80 / 2032
66 / 1676	82 / 2083
66 / 1676	84 / 2134
66 / 1676	86 / 2184
66 / 1676	88 / 2235

PRICING

FABRIC BASE ELEMENT (CONTINUED)															
CLEAR GLASS (CL)							FROSTED GLASS (FT)								
A/COM	Gr. 1	Gr. 2	Gr. 3	Gr. 4	Gr. 5	Gr. 6	Gr. 7	A/COM	Gr. 1	Gr. 2	Gr. 3	Gr. 4	Gr. 5	Gr. 6	Gr. 7
1557	1640	1756	1845	2048	2255	2358	2467	1734	1817	1933	2022	2225	2432	2535	2644
1593	1680	1789	1880	2085	2288	2394	2508	1775	1862	1971	2062	2267	2470	2576	2690
1651	1738	1847	1943	2143	2347	2466	2581	1842	1929	2038	2134	2334	2538	2657	2772
1693	1782	1892	1990	2202	2413	2533	2651	1890	1979	2089	2187	2399	2610	2730	2848
1740	1827	1943	2039	2256	2471	2597	2720	1943	2030	2146	2242	2459	2674	2800	2923
1784	1873	1991	2113	2356	2597	2733	2867	1995	2084	2202	2324	2567	2808	2944	3078
1827	1919	2067	2161	2406	2651	2789	2923	2046	2138	2286	2380	2625	2870	3008	3142
1871	1964	2112	2209	2459	2702	2846	2987	2096	2189	2337	2434	2684	2927	3071	3212
1926	2011	2157	2263	2514	2764	2908	3049	2153	2238	2384	2490	2741	2991	3135	3276
1971	2057	2208	2316	2573	2829	2975	3117	2206	2292	2443	2551	2808	3064	3210	3352
2015	2103	2253	2365	2625	2890	3041	3185	2255	2343	2493	2605	2865	3130	3281	3425
2066	2148	2301	2419	2689	2960	3110	3263	2311	2393	2546	2664	2934	3205	3355	3508
2110	2194	2351	2466	2745	3020	3173	3323	2363	2447	2604	2719	2998	3273	3426	3576
2154	2239	2397	2515	2793	3069	3231	3386	2416	2501	2659	2777	3055	3331	3493	3648
2203	2286	2447	2570	2849	3132	3296	3453	2467	2550	2711	2834	3113	3396	3560	3717
2244	2336	2494	2615	2898	3180	3338	3499	2519	2611	2769	2890	3173	3455	3613	3774
2289	2379	2540	2663	2943	3226	3391	3551	2571	2661	2822	2945	3225	3508	3673	3833
2335	2427	2587	2715	3002	3288	3458	3625	2619	2711	2871	2999	3286	3572	3742	3909
2382	2471	2635	2763	3054	3348	3517	3680	2671	2760	2924	3052	3343	3637	3806	3969
2435	2515	2679	2811	3108	3406	3575	3738	2730	2810	2974	3106	3403	3701	3870	4033

SOURCE LAMINATE BASE ELEMENT															
CLEAR GLASS (CL)							FROSTED GLASS (FT)								
A/COM	Gr. 1	Gr. 2	Gr. 3	Gr. 4	Gr. 5	Gr. 6	Gr. 7	A/COM	Gr. 1	Gr. 2	Gr. 3	Gr. 4	Gr. 5	Gr. 6	Gr. 7
839	863	906	929	1000	1071	1094	1115	920	944	987	1010	1081	1152	1175	1196
867	892	934	957	1032	1101	1124	1147	954	979	1021	1044	1119	1188	1211	1234
904	930	974	1004	1076	1150	1176	1195	997	1023	1067	1097	1169	1243	1269	1288
936	964	1012	1044	1121	1199	1224	1248	1032	1060	1108	1140	1217	1295	1320	1344
1015	1042	1090	1122	1199	1277	1302	1326	1122	1149	1197	1229	1306	1384	1409	1433
1019	1046	1097	1129	1212	1297	1323	1349	1132	1159	1210	1242	1325	1410	1436	1462
1054	1084	1138	1174	1267	1356	1385	1413	1172	1202	1256	1292	1385	1474	1503	1531
1074	1104	1160	1200	1297	1393	1425	1455	1196	1226	1282	1322	1419	1515	1547	1577
1102	1135	1190	1231	1328	1425	1457	1487	1227	1260	1315	1356	1453	1550	1582	1612
1188	1224	1278	1321	1419	1518	1548	1579	1317	1353	1407	1450	1548	1647	1677	1708
1203	1242	1297	1342	1443	1543	1573	1607	1334	1373	1428	1473	1574	1674	1704	1738
1211	1249	1311	1360	1469	1580	1617	1653	1349	1387	1449	1498	1607	1718	1755	1791
1255	1293	1358	1404	1514	1624	1661	1697	1397	1435	1500	1546	1656	1766	1803	1839
1273	1312	1376	1422	1532	1640	1676	1711	1417	1456	1520	1566	1676	1784	1820	1855
1299	1335	1401	1447	1556	1669	1704	1740	1447	1483	1549	1595	1704	1817	1852	1888
1321	1360	1424	1475	1588	1701	1736	1772	1474	1513	1577	1628	1741	1854	1889	1925
1347	1386	1452	1501	1614	1727	1762	1798	1501	1540	1606	1655	1768	1881	1916	1952
1357	1399	1473	1517	1636	1752	1791	1828	1511	1553	1627	1671	1790	1906	1945	1982
1392	1433	1507	1551	1669	1788	1827	1863	1553	1594	1668	1712	1830	1949	1988	2024
1413	1454	1529	1576	1696	1816	1854	1891	1579	1620	1695	1742	1862	1982	2020	2057
1456	1504	1573	1621	1742	1860	1901	1936	1625	1673	1742	1790	1911	2029	2070	2105
1512	1564	1631	1679	1798	1916	1957	1992	1685	1737	1804	1852	1971	2089	2130	2165

Pricing is continued on the following page.

RY_FG

**2" Freestanding Screen – Middle
Fabric and Upper Glass Elements (Continued)**

**DIMENSIONS
INCHES / MM**

PRICING

		SOURCE LAMINATE BASE ELEMENT (CONTINUED)															
		CLEAR GLASS (CL)							FROSTED GLASS (FT)								
H	W	A/COM	Gr. 1	Gr. 2	Gr. 3	Gr. 4	Gr. 5	Gr. 6	Gr. 7	A/COM	Gr. 1	Gr. 2	Gr. 3	Gr. 4	Gr. 5	Gr. 6	Gr. 7
66 / 1676	50 / 1270	1545	1596	1663	1719	1835	1955	1994	2033	1722	1773	1840	1896	2012	2132	2171	2210
66 / 1676	52 / 1321	1580	1636	1698	1754	1872	1991	2030	2069	1762	1818	1880	1936	2054	2173	2212	2251
66 / 1676	54 / 1372	1638	1694	1756	1817	1939	2062	2105	2143	1829	1885	1947	2008	2130	2253	2296	2334
66 / 1676	56 / 1422	1677	1734	1798	1862	1993	2122	2165	2206	1874	1931	1995	2059	2190	2319	2362	2403
66 / 1676	58 / 1473	1724	1778	1848	1908	2043	2174	2219	2258	1927	1981	2051	2111	2246	2377	2422	2461
66 / 1676	60 / 1524	1711	1765	1860	1920	2078	2235	2284	2332	1922	1976	2071	2131	2289	2446	2495	2543
66 / 1676	62 / 1575	1812	1867	1967	2024	2182	2341	2392	2440	2031	2086	2186	2243	2401	2560	2611	2659
66 / 1676	64 / 1626	1855	1912	2010	2070	2232	2388	2439	2492	2080	2137	2235	2295	2457	2613	2664	2717
66 / 1676	66 / 1676	1908	1958	2057	2119	2280	2440	2491	2542	2135	2185	2284	2346	2507	2667	2718	2769
66 / 1676	68 / 1727	1951	2002	2104	2167	2329	2495	2548	2597	2186	2237	2339	2402	2564	2730	2783	2832
66 / 1676	70 / 1778	1997	2046	2148	2212	2376	2542	2596	2648	2237	2286	2388	2452	2616	2782	2836	2888
66 / 1676	72 / 1829	2040	2089	2192	2258	2428	2597	2649	2703	2285	2334	2437	2503	2673	2842	2894	2948
66 / 1676	74 / 1880	2084	2133	2244	2305	2479	2649	2703	2757	2337	2386	2497	2558	2732	2902	2956	3010
66 / 1676	76 / 1390	2127	2176	2286	2347	2524	2696	2752	2807	2389	2438	2548	2609	2786	2958	3014	3069
66 / 1676	78 / 1981	2174	2222	2334	2395	2570	2742	2798	2853	2438	2486	2598	2659	2834	3006	3062	3117
66 / 1676	80 / 2032	2216	2264	2376	2438	2616	2790	2844	2900	2491	2539	2651	2713	2891	3065	3119	3175
66 / 1676	82 / 2083	2262	2310	2422	2486	2663	2839	2895	2950	2544	2592	2704	2768	2945	3121	3177	3232
66 / 1676	84 / 2134	2305	2354	2467	2532	2708	2887	2944	3001	2589	2638	2751	2816	2992	3171	3228	3285
66 / 1676	86 / 2184	2353	2402	2514	2581	2758	2942	3000	3054	2642	2691	2803	2870	3047	3231	3289	3343
66 / 1676	88 / 2235	2396	2443	2555	2622	2800	2983	3041	3095	2691	2738	2850	2917	3095	3278	3336	3390

Xpress

R Y C _

Back Connection Kit – 2" Freestanding Screen

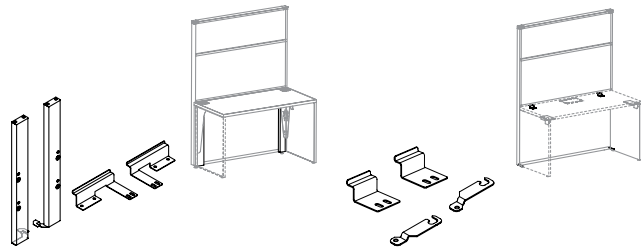

Modular Desk (M)

Spine Desk (S)

The Back Connection Kit is designed to connect a 2" Freestanding Screen to the back of a Modular Desk or a Spine Desk.

WHAT'S INCLUDED

Modular Desk (M): 2 surface brackets, 2 corner post brackets, and hardware.

Spine Desk (S): 2 surface brackets, 2 gable brackets, and hardware.

WHAT'S EXCLUDED

Corner Post Cover.

NOTES

Hardware Finish should be specified to match with the gable or base.

Freestanding screen width must be greater than or equal to the worksurface width.

Coordinate colors for connection kit are solid colors that can be used to match wood prints such as those of the modesty panel and gable.

Modular Desk mounting hardware option (M) **cannot** be installed on a desk with a modesty panel.

Spine Desk mounting hardware option(s) requires to be installed on a Spine Desk-Single-Sided with a Wall-Access modesty panel.

PRODUCT OPTIONS

Mounting Hardware Option		Hardware Finish
M	Modular Desk	Foundation Mica Coordinate Colors
S	Spine Desk	

SAMPLE ORDER CODE

RYCM	R8
-------------	-----------

PRICING

	Foundation/Coordinate Colors	Mica
Spine Desk	110	118
Modular Desk	211	222



The Lateral Connection Kit is designed to connect a 2" Freestanding Screen to a desk with gable.

WHAT'S INCLUDED

2 surface brackets, 2 gable brackets, and hardware.

NOTES

Hardware Finish should be specified to match with the gable or base.

Freestanding screen width must be greater than or equal to the worksurface depth.

Coordinate colors for connection kit are solid colors that can be used to match wood prints such as those of the modesty panel and gable.

Cannot be installed on desks with Metal C-Leg gables.

RYCL
Lateral Connection Kit –
2" Freestanding Screen

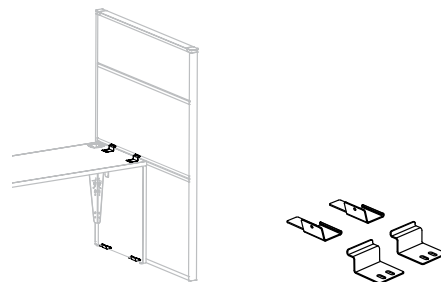

PRODUCT OPTIONS

Hardware Finish

Foundation

Mica

Coordinate Colors

SAMPLE ORDER CODE

RYCL R8

PRICING

Foundation/Coordinate Colors	Mica
110	118

columns & screens

Xpress

R Y C W

Wall Connection Kit – 2" Freestanding Screen

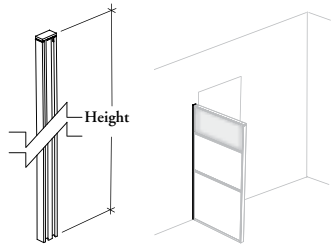

The Wall Connection Kit is designed to connect a 2" Freestanding Screen to a wall.

WHAT'S INCLUDED

1 aluminum extrusion, 1 end cap, and mounting hardware.

NOTES

The height of the Wall Connection Kit specified must equal the overall height of the Freestanding Screen.

Color should be specified to match the freestanding screen frame.

PRODUCT OPTIONS

Height	Finish
42, 51, 66	Foundation Mica

SAMPLE ORDER CODE

R Y C W 66	Q
-------------------	----------

**DIMENSIONS
INCHES / MM**

H
42 / 1067
51 / 1295
66 / 1676

PRICING

	Foundation	Mica
	90	96
	119	125
	142	152

RYCD

Desk Connection Kit – 2" Freestanding Screen

The Desk Connection Kit is designed to connect a 2" Freestanding Screen to a desk outfitted with elements.

WHAT'S INCLUDED

1 aluminum extrusion, 1 end cap, and mounting hardware.

NOTES

The height of the freestanding screen must be less than or equal to the height of the desk and elements to which it is connected.

The height of the Desk Connection Kit specified must equal the overall height of the freestanding screen.

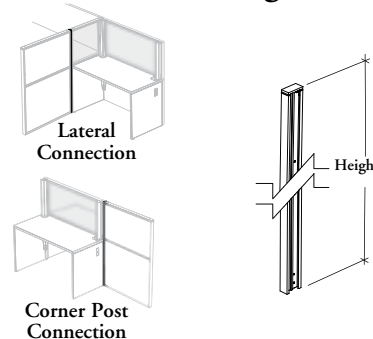

PRODUCT OPTIONS

Height	Finish
42, 51, 66	Foundation Mica

SAMPLE ORDER CODE

RYCD 66	E
----------------	----------

**DIMENSIONS
INCHES / MM**

H
42 / 1067
51 / 1295
66 / 1676

PRICING

	Foundation	Mica
	90	96
	119	125
	142	152

Xpress

RYCH

Height-Change Connection Kit – 2" Freestanding Screen

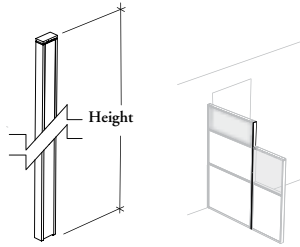

The Height-Change Connection Kit is designed to make a height change from a 2" Freestanding Screen to another.

WHAT'S INCLUDED

1 aluminum extrusion, 1 – 37" aluminum cover, 1 end cap, and mounting hardware.

NOTES

The height of the Height-Change Connection Kit specified must equal the higher Freestanding Screen to which it is connected.

Connection in 180° only.

Color should be specified to match the freestanding screen frame.

PRODUCT OPTIONS

Height	Finish
42, 51, 66	Foundation Mica

SAMPLE ORDER CODE

RYCH 66	Q
----------------	----------

**DIMENSIONS
INCHES / MM**

H
42 / 1067
51 / 1295
66 / 1676

PRICING

	Foundation	Mica
	90	96
	119	125
	142	152

The Foot is used to stabilize 2" Freestanding Screens.

WHAT'S INCLUDED

1 foot.

NOTES

Fits all screen heights and widths and is installed over levelers.

Color should be specified to match the freestanding screen finish.

The Foot must be used to stabilize screens in specific applications, refer to the Application Guide.

RYCF
Foot – 2" Freestanding Screen

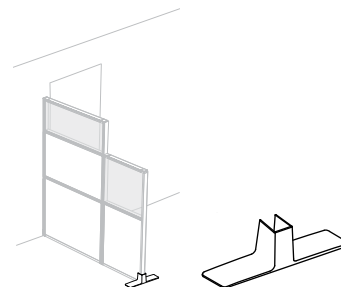

PRODUCT OPTIONS

Style	Finish
1 Basic Style	Foundation Mica

SAMPLE ORDER CODE

RYCF 1	7
---------------	----------

STYLE

PRICING

	Foundation	Mica
1	303	319

countertops

countertops product map

R C S C Countertop – Straight

Page 392

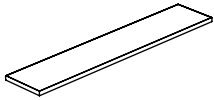

R C C C Corner Countertop – Straight

Page 393

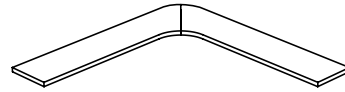

R C C S Countertop Support

Page 394

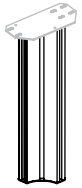

countertops

Xpress

RCSC

Countertop – Straight

This countertop mounts on structural columns and can be used alone or in combination with other countertops.

WHAT'S INCLUDED

1 countertop with mounting hardware.

WHAT'S EXCLUDED

Structural Columns, Countertop Supports and 13" high element.

NOTES

This countertop has a 6" overhang in front of the workstation.

Must be combined to 13" high element.

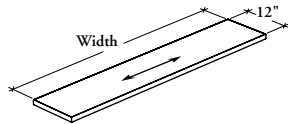

PRODUCT OPTIONS

Depth	Width	Countertop Finish	Edge Trim Style	Edge Trim Finish
12	24, 30, 36, 42, 48, 54, 60, 66, 72, 78, 84	Foundation Laminate Flintwood	6 Straight Trim 9 Flintwood Flat Trim	Edge Trim Colors (for trim style 6)

SAMPLE ORDER CODE

RCSC 12	24	2D	6	4D
----------------	-----------	-----------	----------	-----------

**DIMENSIONS
INCHES / MM**

D	W
12 / 305	24 / 610
12 / 305	30 / 762
12 / 305	36 / 914
12 / 305	42 / 1067
12 / 305	48 / 1219
12 / 305	54 / 1372
12 / 305	60 / 1524
12 / 305	66 / 1676
12 / 305	72 / 1829
12 / 305	78 / 1981
12 / 305	84 / 2134

PRICING

	Foundation Laminate	Flintwood
	191	405
	209	451
	239	515
	268	575
	303	652
	340	733
	375	810
	413	890
	454	971
	490	1052
	525	1132

The Corner Countertop – Straight mounts on structural columns and is used in combination with other countertops to create a 90° transaction surface.

WHAT'S INCLUDED

1 countertop with mounting hardware.

WHAT'S EXCLUDED

Structural Columns, Countertop Supports and 13" high element.

NOTES

The Linear (L) Corner Countertop has a 6" overhang in front of the workstation.

Must be combined to 13" high element.

RCCC
Corner Countertop – Straight

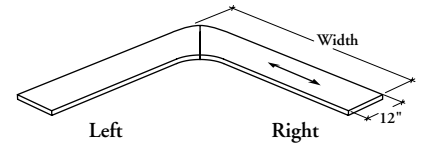

PRODUCT OPTIONS

Countertop Style	Depth	Width	Countertop Configuration	Countertop Finish	Edge Trim Style	Edge Trim Finish
L Linear	12	24, 30, 36, 42, 48, 54, 60, 66, 72, 78, 84	L Left R Right	Foundation Laminate Flintwood	6 Straight Trim 9 Flintwood Flat Trim	Edge Trim Colors (for trim style 6)

SAMPLE ORDER CODE

RCCC L	12	24	L	2D	6	4D
---------------	-----------	-----------	----------	-----------	----------	-----------

DIMENSIONS
INCHES / MM

D	W
12 / 305	24 / 610
12 / 305	30 / 762
12 / 305	36 / 914
12 / 305	42 / 1067
12 / 305	48 / 1219
12 / 305	54 / 1372
12 / 305	60 / 1524
12 / 305	66 / 1676
12 / 305	72 / 1829
12 / 305	78 / 1981
12 / 305	84 / 2134

PRICING

LINEAR STYLE (L)

Foundation Laminate	Flintwood
229	492
251	536
277	597
309	662
341	738
376	815
418	892
455	974
491	1056
527	1134
567	1216

Xpress

R C C S

Countertop Support

The Countertop Support allows countertop installation along the depth of a worksurface.

WHAT'S INCLUDED

1 countertop support, 1 plate, and hardware.

NOTES

The Countertop Support is installed on the worksurface and does **not** require pre-drilled holes for installation.

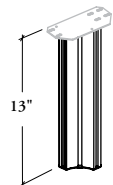

PRODUCT OPTIONS

Height	Support Finish
13	Foundation Mica

SAMPLE ORDER CODE

RCCS 13	G
---------	---

**DIMENSIONS
INCHES / MM**

H
13 / 330

PRICING

Foundation	Mica
75	80

mounted storage &
accessories

mounted storage & accessories product map

R S E D S Elevated Desktop Cabinet – Sliding Doors

Page 400

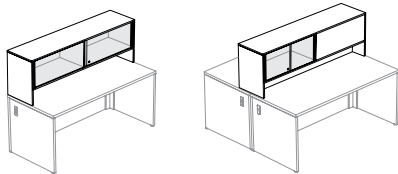

R S E H D Elevated Desktop Cabinet – Solid Hinged Doors

Page 404

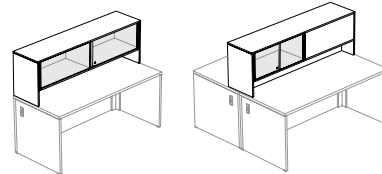

R S E O O Elevated Desktop Cabinet – Open

Page 406

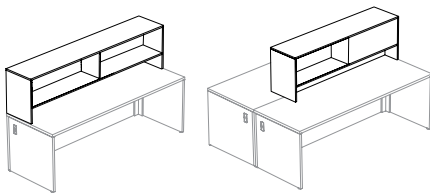

R O C C Overhead Cabinet – Solid Hinged Doors

Page 408

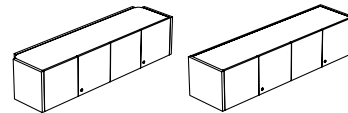

R O C H G Overhead Cabinet – Glass Hinged Doors

Page 409

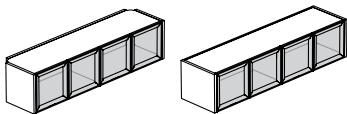

R O C F Overhead Cabinet – Solid Flipper Door(s)

Page 410

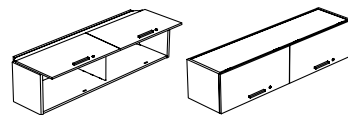

R O C M L Overhead Cabinet – Metal Flipper Door(s) – Linear Style

Page 411

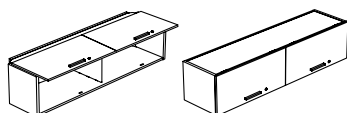

R O C M F Overhead Cabinet – Metal Flipper Door(s) – Flush Front Style

Page 412

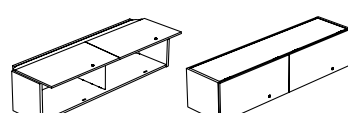

mounted storage & accessories product map

R O R L Overhead Cabinet – Solid Receding Door(s)

Page 413

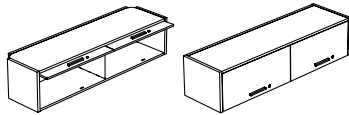

R O R M L Overhead Cabinet – Metal Receding Door(s) – Linear Style

Page 414

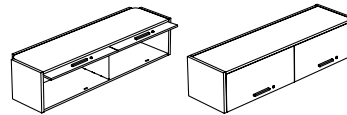

R O R M F Overhead Cabinet – Metal Receding Door(s) – Flush Front Style

Page 415

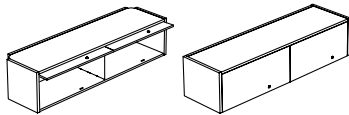

R O C D Overhead Cabinet – Sliding Doors

Page 416

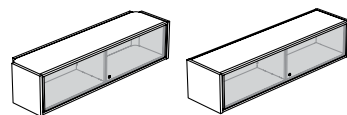

R O C O Overhead Cabinet – No Door

Page 417

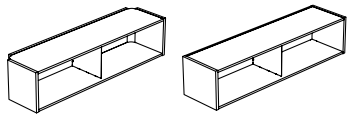

R O G F Overhead Cabinet Filler

Page 418

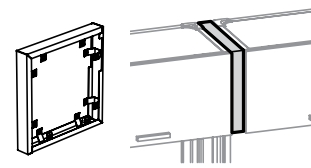

R O S L Shelf – Solid

Page 419

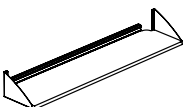

R O S M Shelf – Metal

Page 420

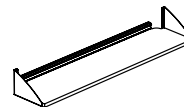

mounted storage & accessories product map

R O A R Accessory Rail

Page 421

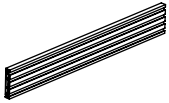

R P W T Wall-Mounted Tackboard

Page 422

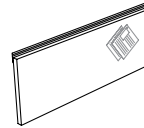

P A X Personal Organizers

Page 423

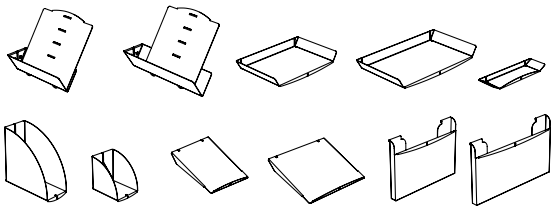

mounted storage & accessories

Xpress

RSEDS

Elevated Desktop Cabinet – Sliding Doors

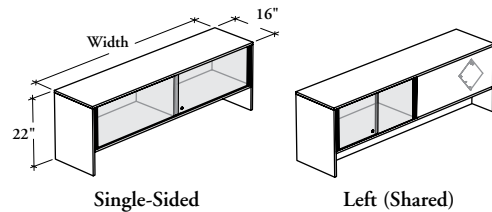

This cabinet is an elevated closed cabinet that sits directly on a Modular Desk or Spine Desk in single-sided or shared application.

WHAT'S INCLUDED

Single-Sided Configuration: 1 elevated desktop cabinet, 2 sliding doors with pulls, 1 divider (inside case), lock and keys (if specified).

Shared Configuration: 1 elevated desktop cabinet, 1 back accessory (as specified) behind each compartment, 4 sliding doors with pulls, 1 divider (inside case) 0 or 1 divider (under shelf) (as specified), locks and keys (if specified).

WHAT'S EXCLUDED

Linear LED Light and Tangent Undercabinet Light.

NOTES

Open without Divider base configuration (O) is **not** available with single-sided configuration (S).

Frosted (FT) is a single-sided etched tempered glass which is facing inward of cabinet.

Xpress Not all configurations are available as Xpress. Please see Xpress catalogue and/or specification software for details.

PRODUCT OPTIONS

Configuration (Door Side)	Accessory Option	Base Configuration	Depth	Width	Case and Divider Finish	Door Style	Door Finish	Pull Finish	Accessory Finish (If applicable)	Key Style
S Single-Sided	F Fabric Tackboard (Shown)	C Closed (Shown)	16	30, 36, 42, 48, 54, 60, 66, 72, 78, 84	Source Laminate	F Flintwood	Flintwood	Foundation	Source Laminate	K Keyed Alike
L Left (Shared)	L Laminate	O Open without Divider				G Glass	Standard Glass: CL Clear FT Frosted Back-Painted Glass Source Laminate	Mica	Panel Fabric	R Keyed Randomly
R Right (Shared)						L Laminate				N No lock

SAMPLE ORDER CODE

RSEDS	F	C	16	54	XS	L	XS	7	C502	K
L										

DIMENSIONS INCHES / MM

D	W
16 / 406	30 / 762
16 / 406	36 / 914
16 / 406	42 / 1067
16 / 406	48 / 1219
16 / 406	54 / 1372
16 / 406	60 / 1524
16 / 406	66 / 1676
16 / 406	72 / 1829
16 / 406	78 / 1981
16 / 406	84 / 2134

16 / 406	30 / 762
16 / 406	36 / 914
16 / 406	42 / 1067
16 / 406	48 / 1219
16 / 406	54 / 1372
16 / 406	60 / 1524
16 / 406	66 / 1676
16 / 406	72 / 1829
16 / 406	78 / 1981
16 / 406	84 / 2134

PRICING

SINGLE-SIDED (S)

CLOSED (C)

LAMINATE ACCESSORY (L)

LAMINATE DOORS (L) (Source Laminate)

1023
1114
1206
1317
1424
1514
1604
1695
1784
1873

GLASS DOORS (G) (Clear (CL))

1086
1163
1244
1340
1438
1516
1607
1717
1825
1928

GLASS DOORS (G) (Frosted (FT)/Back-Painted)

1231
1302
1383
1481
1579
1656
1748
1857
1965
2068

FLINTWOOD DOORS (F) (Flintwood)

1382
1543
1703
1885
2062
2228
2398
2559
2725
2863

Pricing is continued on the following page.

RSEDS

Elevated Desktop Cabinet – Sliding Doors (Continued)

DIMENSIONS
INCHES / MM

PRICING

DIMENSIONS		PRICING								
		LEFT (L) OR RIGHT (R)								
		OPEN WITHOUT DIVIDER (O)								
		FABRIC TACKBOARD (F)							LAMINATE (L)	
D	W	A/COM	Gr. 1	Gr. 2	Gr. 3	Gr. 4	Gr. 5	Gr. 6	Gr. 7	Source Laminate
LAMINATE DOORS (L) (Source Laminate)										
16 / 406	48 / 1219	1822	1832	1850	1865	1898	1931	1955	1981	1663
16 / 406	54 / 1372	1957	1967	1990	2007	2043	2081	2108	2136	1788
16 / 406	60 / 1524	2068	2085	2104	2124	2166	2206	2235	2262	1892
16 / 406	66 / 1676	2185	2200	2223	2237	2276	2316	2346	2373	1998
16 / 406	72 / 1829	2309	2324	2352	2368	2411	2457	2490	2522	2097
16 / 406	78 / 1981	2424	2441	2464	2491	2541	2591	2625	2659	2202
16 / 406	84 / 2134	2535	2552	2577	2597	2647	2693	2728	2764	2300
GLASS DOORS (G) (Clear (CL))										
16 / 406	48 / 1219	1976	1986	2004	2019	2052	2085	2109	2135	1817
16 / 406	54 / 1372	2093	2103	2126	2143	2179	2217	2244	2272	1924
16 / 406	60 / 1524	2191	2208	2227	2247	2289	2329	2358	2385	2015
16 / 406	66 / 1676	2295	2310	2333	2347	2386	2426	2456	2483	2108
16 / 406	72 / 1829	2411	2426	2454	2470	2513	2559	2592	2624	2199
16 / 406	78 / 1981	2513	2530	2553	2580	2630	2680	2714	2748	2291
16 / 406	84 / 2134	2612	2629	2654	2674	2724	2770	2805	2841	2377
GLASS DOORS (G) (Frosted (FT)/Back-Painted)										
16 / 406	48 / 1219	2255	2265	2283	2298	2331	2364	2388	2414	2096
16 / 406	54 / 1372	2373	2383	2406	2423	2459	2497	2524	2552	2204
16 / 406	60 / 1524	2473	2490	2509	2529	2571	2611	2640	2667	2297
16 / 406	66 / 1676	2573	2588	2611	2625	2664	2704	2734	2761	2386
16 / 406	72 / 1829	2694	2709	2737	2753	2796	2842	2875	2907	2482
16 / 406	78 / 1981	2796	2813	2836	2863	2913	2963	2997	3031	2574
16 / 406	84 / 2134	2896	2913	2938	2958	3008	3054	3089	3125	2661
FLINTWOOD DOORS (F) (Flintwood)										
16 / 406	48 / 1219	2398	2408	2426	2441	2474	2507	2531	2557	2239
16 / 406	54 / 1372	2595	2605	2628	2645	2681	2719	2746	2774	2426
16 / 406	60 / 1524	2781	2798	2817	2837	2879	2919	2948	2975	2605
16 / 406	66 / 1676	2972	2987	3010	3024	3063	3103	3133	3160	2785
16 / 406	72 / 1829	3178	3193	3221	3237	3280	3326	3359	3391	2966
16 / 406	78 / 1981	3362	3379	3402	3429	3479	3529	3563	3597	3140
16 / 406	84 / 2134	3527	3544	3569	3589	3639	3685	3720	3756	3292

Pricing is continued on the following page.

mounted storage & accessories

Xpress

R S E D S

Elevated Desktop Cabinet – Sliding Doors (Continued)

DIMENSIONS
INCHES / MM

PRICING

LEFT (L) OR RIGHT (R) (CONTINUED)

CLOSED (C)

FABRIC TACKBOARD (F)

LAMINATE (L)

D	W	A/COM	Gr. 1	Gr. 2	Gr. 3	Gr. 4	Gr. 5	Gr. 6	Gr. 7	Source Laminate
		LAMINATE DOORS (L) (Source Laminate)								
16 / 406	48 / 1219	1918	1928	1946	1961	1994	2027	2051	2077	1759
16 / 406	54 / 1372	2063	2073	2096	2113	2149	2187	2214	2242	1894
16 / 406	60 / 1524	2185	2202	2221	2241	2283	2323	2352	2379	2009
16 / 406	66 / 1676	2312	2327	2350	2364	2403	2443	2473	2500	2125
16 / 406	72 / 1829	2453	2468	2496	2512	2555	2601	2634	2666	2241
16 / 406	78 / 1981	2579	2596	2619	2646	2696	2746	2780	2814	2357
16 / 406	84 / 2134	2701	2718	2743	2763	2813	2859	2894	2930	2466

GLASS DOORS (G) (Clear (CL))

16 / 406	48 / 1219	2068	2078	2096	2111	2144	2177	2201	2227	1909
16 / 406	54 / 1372	2200	2210	2233	2250	2286	2324	2351	2379	2031
16 / 406	60 / 1524	2308	2325	2344	2364	2406	2446	2475	2502	2132
16 / 406	66 / 1676	2423	2438	2461	2475	2514	2554	2584	2611	2236
16 / 406	72 / 1829	2554	2569	2597	2613	2656	2702	2735	2767	2342
16 / 406	78 / 1981	2667	2684	2707	2734	2784	2834	2868	2902	2445
16 / 406	84 / 2134	2779	2796	2821	2841	2891	2937	2972	3008	2544

GLASS DOORS (G) (Frosted (FT)/Back-Painted)

16 / 406	48 / 1219	2351	2361	2379	2394	2427	2460	2484	2510	2192
16 / 406	54 / 1372	2483	2493	2516	2533	2569	2607	2634	2662	2314
16 / 406	60 / 1524	2590	2607	2626	2646	2688	2728	2757	2784	2414
16 / 406	66 / 1676	2704	2719	2742	2756	2795	2835	2865	2892	2517
16 / 406	72 / 1829	2834	2849	2877	2893	2936	2982	3015	3047	2622
16 / 406	78 / 1981	2947	2964	2987	3014	3064	3114	3148	3182	2725
16 / 406	84 / 2134	3060	3077	3102	3122	3172	3218	3253	3289	2825

FLINTWOOD DOORS (F) (Flintwood)

16 / 406	48 / 1219	2488	2498	2516	2531	2564	2597	2621	2647	2329
16 / 406	54 / 1372	2701	2711	2734	2751	2787	2825	2852	2880	2532
16 / 406	60 / 1524	2899	2916	2935	2955	2997	3037	3066	3093	2723
16 / 406	66 / 1676	3101	3116	3139	3153	3192	3232	3262	3289	2914
16 / 406	72 / 1829	3320	3335	3363	3379	3422	3468	3501	3533	3108
16 / 406	78 / 1981	3519	3536	3559	3586	3636	3686	3720	3754	3297
16 / 406	84 / 2134	3693	3710	3735	3755	3805	3851	3886	3922	3458

mounted storage & accessories

Xpress

RSEHD

Elevated Desktop Cabinet – Solid Hinged Doors

This cabinet is an elevated closed cabinet that sits directly on a Modular Desk or Spine Desk in single-sided or shared application.

WHAT'S INCLUDED

Single-Sided Configuration: 1 elevated desktop cabinet, 1 divider (inside case), lock and keys (if specified).

Shared Configuration: 1 elevated desktop cabinet, 1 back accessory (as specified) behind each compartment, 1 divider (inside case) 0 or 1 divider (under shelf) (as specified), locks and keys (if specified).

Components as listed below:

	Single-Sided Config. (S) Widths				Shared Config. (L or R) Widths	
	30" or 36"	42" or 48"	54" to 66"	72" to 84"	48" to 66"	72" to 84"
Door	2	3	4	5	4	6
Divider (inside case)	n/a	1	1	2	1	3

WHAT'S EXCLUDED

Linear LED Light and Tangent Undercabinet Light.

NOTES

Open without Divider base configuration (O) is **not** available with single-sided configuration (S).

Xpress Not all configurations are available as Xpress. Please see Xpress catalogue and/or specification software for details.

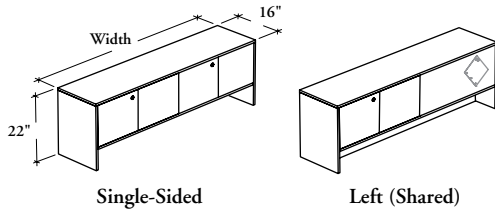

PRODUCT OPTIONS

Configuration (Door Side)	Accessory Option	Base Configuration	Depth	Width	Case and Divider Finish	Door Finish	Accessory Finish (If applicable)	Key Style
S Single-Sided	F Fabric Tackboard (Shown) L Laminate	C Closed (Shown)	16	30, 36, 42, 48, 54, 60, 66, 72, 78, 84	Source Laminate	Flintwood Source Laminate	Source Laminate Panel Fabric	K Keyed Alike R Keyed Randomly N No lock
L Left (Shared)		O Open without Divider						
R Right (Shared)								

SAMPLE ORDER CODE

RSEHD	L	C	16	72	XS	XS	XS	N
S								

DIMENSIONS INCHES / MM

D	W
16 / 406	30 / 762
16 / 406	36 / 914
16 / 406	42 / 1067
16 / 406	48 / 1219
16 / 406	54 / 1372
16 / 406	60 / 1524
16 / 406	66 / 1676
16 / 406	72 / 1829
16 / 406	78 / 1981
16 / 406	84 / 2134

PRICING

SINGLE-SIDED (S)

CLOSED (C)

LAMINATE ACCESSORY (L)

SOURCE LAMINATE DOORS

813
907
1073
1194
1312
1421
1515
1612
1779
1878

FLINTWOOD DOORS

1170
1337
1569
1764
1951
2136
2304
2480
2719
2866

Pricing is continued on the following page.

RSEHD

Elevated Desktop Cabinet – Solid Hinged Doors (Continued)

DIMENSIONS
INCHES / MM

D	W
16 / 406	48 / 1219
16 / 406	54 / 1372
16 / 406	60 / 1524
16 / 406	66 / 1676
16 / 406	72 / 1829
16 / 406	78 / 1981
16 / 406	84 / 2134

16 / 406	48 / 1219
16 / 406	54 / 1372
16 / 406	60 / 1524
16 / 406	66 / 1676
16 / 406	72 / 1829
16 / 406	78 / 1981
16 / 406	84 / 2134

16 / 406	48 / 1219
16 / 406	54 / 1372
16 / 406	60 / 1524
16 / 406	66 / 1676
16 / 406	72 / 1829
16 / 406	78 / 1981
16 / 406	84 / 2134

16 / 406	48 / 1219
16 / 406	54 / 1372
16 / 406	60 / 1524
16 / 406	66 / 1676
16 / 406	72 / 1829
16 / 406	78 / 1981
16 / 406	84 / 2134

PRICING

LEFT (L) OR RIGHT (R)									
OPEN WITHOUT DIVIDER (O)									
FABRIC TACKBOARD (F)								LAMINATE (L)	
A/COM	Gr. 1	Gr. 2	Gr. 3	Gr. 4	Gr. 5	Gr. 6	Gr. 7	Source Laminate	
SOURCE LAMINATE DOORS									
1258	1268	1286	1301	1334	1367	1391	1417	1099	
1375	1385	1408	1425	1461	1499	1526	1554	1206	
1479	1496	1515	1535	1577	1617	1646	1673	1303	
1571	1586	1609	1623	1662	1702	1732	1759	1384	
1684	1699	1727	1743	1786	1832	1865	1897	1472	
1910	1927	1950	1977	2027	2077	2111	2145	1688	
2009	2026	2051	2071	2121	2167	2202	2238	1774	

FLINTWOOD DOORS									
1829	1839	1857	1872	1905	1938	1962	1988	1670	
2013	2023	2046	2063	2099	2137	2164	2192	1844	
2192	2209	2228	2248	2290	2330	2359	2386	2016	
2363	2378	2401	2415	2454	2494	2524	2551	2176	
2545	2560	2588	2604	2647	2693	2726	2758	2333	
2847	2864	2887	2914	2964	3014	3048	3082	2625	
2998	3015	3040	3060	3110	3156	3191	3227	2763	

CLOSED (C)									
FABRIC TACKBOARD (F)								LAMINATE (L)	
A/COM	Gr. 1	Gr. 2	Gr. 3	Gr. 4	Gr. 5	Gr. 6	Gr. 7	Source Laminate	
SOURCE LAMINATE DOORS									
1353	1363	1381	1396	1429	1462	1486	1512	1194	
1481	1491	1514	1531	1567	1605	1632	1660	1312	
1597	1614	1633	1653	1695	1735	1764	1791	1421	
1702	1717	1740	1754	1793	1833	1863	1890	1515	
1824	1839	1867	1883	1926	1972	2005	2037	1612	
2062	2079	2102	2129	2179	2229	2263	2297	1840	
2173	2190	2215	2235	2285	2331	2366	2402	1938	

FLINTWOOD DOORS									
1923	1933	1951	1966	1999	2032	2056	2082	1764	
2120	2130	2153	2170	2206	2244	2271	2299	1951	
2312	2329	2348	2368	2410	2450	2479	2506	2136	
2491	2506	2529	2543	2582	2622	2652	2679	2304	
2692	2707	2735	2751	2794	2840	2873	2905	2480	
3003	3020	3043	3070	3120	3170	3204	3238	2781	
3164	3181	3206	3226	3276	3322	3357	3393	2929	

mounted storage & accessories

Xpress

RSEOO

Elevated Desktop Cabinet – Open

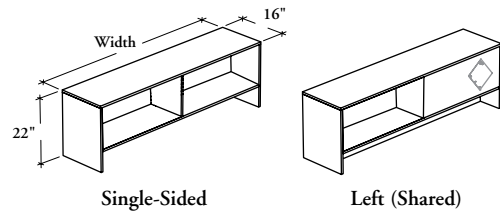

This cabinet is an elevated open cabinet that sits directly on a Modular Desk or Spine Desk in single-sided or shared application.

WHAT'S INCLUDED

Single-Sided Configuration: 1 elevated desktop cabinet, 1 divider (inside case).

Shared Configuration: 1 elevated desktop cabinet, 1 back accessory (as specified) behind each compartment, 1 divider (inside case) 0 or 1 divider (under shelf) (as specified).

WHAT'S EXCLUDED

Linear LED Light and Tangent Undercabinet Light.

NOTES

Open without Divider base configuration (O) is **not** available with single-sided configuration (S).

Xpress Not all configurations are available as Xpress. Please see Xpress catalogue and/or specification software for details.

PRODUCT OPTIONS

Configuration (Open Side)	Accessory Option	Base Configuration	Depth	Width	Case and Divider Finish	Accessory Finish (If applicable)
S Single-Sided	F Fabric Tackboard (Shown)	C Closed (Shown)	16	30, 36, 42, 48, 54, 60, 66, 72, 78, 84	Source Laminate	Source Laminate
L Left (Shared)	L Laminate	O Open without Divider				Panel Fabric
R Right (Shared)						

SAMPLE ORDER CODE

RSEOO	F	C	16	60	3E	C502
R						

DIMENSIONS INCHES / MM

D	W
16 / 406	30 / 762
16 / 406	36 / 914
16 / 406	42 / 1067
16 / 406	48 / 1219
16 / 406	54 / 1372
16 / 406	60 / 1524
16 / 406	66 / 1676
16 / 406	72 / 1829
16 / 406	78 / 1981
16 / 406	84 / 2134

PRICING

SINGLE-SIDED (S)
CLOSED (C)
LAMINATE DOORS (L) (Source Laminate)
594
643
701
773
846
898
954
1007
1063
1112

Pricing is continued on the following page.

R S E O O
Elevated Desktop Cabinet – Open
(Continued)

DIMENSIONS
INCHES / MM

D	W
16 / 406	48 / 1219
16 / 406	54 / 1372
16 / 406	60 / 1524
16 / 406	66 / 1676
16 / 406	72 / 1829
16 / 406	78 / 1981
16 / 406	84 / 2134

PRICING

LEFT (L) OR RIGHT (R)									
OPEN WITHOUT DIVIDER (O)									
FABRIC TACKBOARD (F)									
LAMINATE (L)									
A/COM	Gr. 1	Gr. 2	Gr. 3	Gr. 4	Gr. 5	Gr. 6	Gr. 7	Source Laminate	
836	846	867	880	915	950	974	999	677	
907	921	941	956	992	1027	1053	1080	741	
957	973	993	1013	1052	1090	1121	1148	782	
1010	1027	1045	1064	1100	1137	1167	1195	822	
1078	1092	1121	1134	1177	1219	1253	1285	864	
1128	1148	1168	1197	1247	1296	1332	1366	907	
1179	1199	1219	1245	1291	1339	1375	1411	947	

CLOSED (C)										
FABRIC TACKBOARD (F)										
LAMINATE (L)										
A/COM	Gr. 1	Gr. 2	Gr. 3	Gr. 4	Gr. 5	Gr. 6	Gr. 7	Source Laminate		
930	940	960	973	1008	1043	1068	1092	773	1304	
1013	1028	1045	1064	1099	1134	1163	1190	846	1443	
1076	1089	1111	1129	1168	1208	1237	1263	898	1522	
1139	1157	1176	1194	1232	1267	1296	1325	954	1605	
1217	1237	1260	1281	1324	1366	1400	1431	1007	1691	
1284	1300	1325	1351	1402	1452	1486	1522	1063	1773	
1343	1365	1384	1412	1458	1505	1540	1576	1112	1893	

mounted storage & accessories

Xpress

ROCC

Overhead Cabinet – Solid Hinged Doors

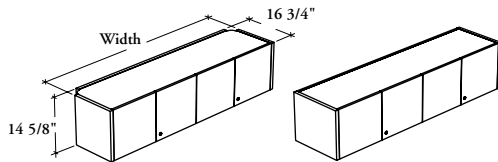

Column-Mounted

Wall-Mounted

This cabinet is a lockable mounted storage unit that supplies overhead storage and space division between workstations.

WHAT'S INCLUDED

1 overhead cabinet, column- or wall-mounting supports, lock and keys, and components as listed below:

	Widths			
	24" to 36"	42" to 54"	60" to 78"	84"
Door	2	3	4	5
Divider	n/a	1	1	2

WHAT'S EXCLUDED

Structural Columns.

NOTES

This cabinet is shipped knocked down.

This cabinet has a 21 1/2" clearance between the top of the desk to the bottom of the cabinet.

Specify the width according to the width of the desk over which the overhead cabinet is mounted. Column-Mounted Overhead Cabinet width is actually 2.5" less.

PRODUCT OPTIONS

Mounted Style	Depth	Width	Door Finish	Edge Trim Finish	Case Finish	Shelf and Divider Finish (Source Laminate Case only)	Key Style
C Column-Mounted	16	24, 30, 36, 42, 48, 54, 60, 66, 72, 78, 84	Source Laminate	Edge Trim Colors	Source Laminate	Foundation	K Keyed Alike R Keyed Randomly N No Lock
W Wall-Mounted			Foundation Laminate		Foundation	Mica	
	Flintwood	Mica	Coordinate Colors				

SAMPLE ORDER CODE

ROCC C	16	24	2D	4D	3D	E	K
---------------	-----------	-----------	-----------	-----------	-----------	----------	----------

DIMENSIONS INCHES / MM

D	W
16 / 406	24 / 610
16 / 406	30 / 762
16 / 406	36 / 914
16 / 406	42 / 1067
16 / 406	48 / 1219
16 / 406	54 / 1372
16 / 406	60 / 1524
16 / 406	66 / 1676
16 / 406	72 / 1829
16 / 406	78 / 1981
16 / 406	84 / 2134

PRICING

	Source Laminate	Foundation Laminate	Flintwood
	718	757	1134
	756	806	1210
	800	863	1293
	977	1017	1528
	999	1082	1624
	1064	1155	1735
	1169	1268	1906
	1205	1313	1972
	1260	1387	2085
	1297	1431	2149
	1440	1585	2378

If Mica case is specified, add 138.

This cabinet is a mounted storage unit that supplies overhead storage and space division between workstations.

WHAT'S INCLUDED

1 overhead cabinet, column- or wall-mounting supports, and components as listed below:

	Widths			
	24" to 36"	42" to 54"	60" to 78"	84"
Door	2	3	4	5
Divider	n/a	1	1	2

WHAT'S EXCLUDED

Structural Columns.

NOTES

This cabinet is shipped knocked down.

This cabinet has a 21 1/2" clearance between the top of the desk to the bottom of the cabinet.

Specify the width according to the width of the desk over which the overhead cabinet is mounted. Column-Mounted Overhead Cabinet width is actually 2.5" less.

Frosted (FT) is a single-sided etched tempered glass which is facing inward of cabinet.

Xpress Not all glass finishes are available as Xpress. Please see Xpress catalogue and/or specification software for details.

ROCHG
Overhead Cabinet –
Glass Hinged Doors

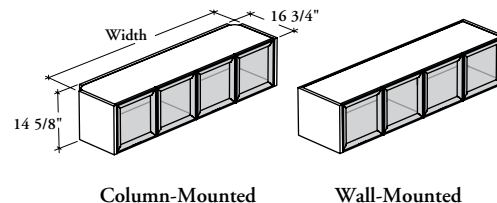

PRODUCT OPTIONS

Mounted Style	Depth	Width	Case Finish	Shelf and Divider Finish	Door Frame Finish	Glass Door Finish	Key Style
C Column-Mounted	16	24, 30, 36, 42, 48, 54, 60, 66, 72, 78, 84	Source Laminate	Foundation	Foundation	Standard Glass: CL Clear FT Frosted Back-Painted Glass	N No Lock
W Wall-Mounted			Foundation	Mica	Mica		K Keyed Alike
			Mica	Coordinate Colors	AC Clear Anodized		R Keyed Randomly

SAMPLE ORDER CODE

ROCHG W	16	84	3D	N	7	FT	N
----------------	-----------	-----------	-----------	----------	----------	-----------	----------

DIMENSIONS
INCHES / MM

D	W
16 / 406	24 / 610
16 / 406	30 / 762
16 / 406	36 / 914
16 / 406	42 / 1067
16 / 406	48 / 1219
16 / 406	54 / 1372
16 / 406	60 / 1524
16 / 406	66 / 1676
16 / 406	72 / 1829
16 / 406	78 / 1981
16 / 406	84 / 2134

PRICING

CLEAR GLASS (CL)		FROSTED GLASS (FT) / BACK-PAINTED GLASS	
Source Laminate/ Foundation	Mica	Source Laminate/ Foundation	Mica
1747	1885	1880	2018
1907	2050	2040	2183
2079	2216	2212	2349
2380	2524	2582	2726
2529	2668	2731	2870
2719	2857	2921	3059
3175	3314	3443	3582
3196	3334	3464	3602
3246	3386	3514	3654
3271	3413	3539	3681
3855	3995	4193	4333

KEY UPCHARGE

Keyed Alike or Keyed Randomly
55
55
55
115
115
115
115
115
115
115
115
171

mounted storage & accessories

Xpress

ROCF

Overhead Cabinet – Solid Flipper Door(s)

This cabinet is a mounted storage unit that provides above worksurface storage capabilities.

WHAT'S INCLUDED

1 overhead cabinet, column- or wall-mounting supports, pulls, lock and keys, and components as listed below:

	Widths	
	24" to 48"	54" to 84"
Door	1	2
Divider	n/a	1

WHAT'S EXCLUDED

Structural Columns.

NOTES

This cabinet is shipped knocked down.

This cabinet has a 19 1/2" clearance between the top of the desk to the bottom of the cabinet.

Specify the width according to the width of the desk over which the overhead cabinet is mounted. Column-Mounted Overhead Cabinet width is actually 2.5" less.

Soft Touch (2) and Standard T/O/S (4) pulls are only available in limited Foundation colors. Refer to the specification software for details.

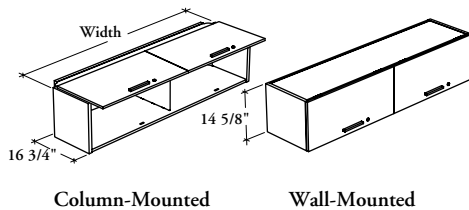

PRODUCT OPTIONS

Mounted Style	Depth	Width	Door Finish	Edge Trim Finish	Case Finish	Shelf and Divider Finish (Source Lam. Case only)	Pull Style	Pull Finish	Key Style	Motion Control Mechanism
C Column-Mounted	16	24, 30, 36, 42, 48, 54, 60, 66, 72, 78, 84	Source Laminate	Edge Trim Colors	Source Laminate	Foundation	1 Standard Expansion	Foundation	K Keyed Alike	2 With Motion Control Mechanism
W Wall-Mounted			Foundation Laminate Flintwood		Foundation Mica	Coordinate Colors	2 Soft Touch 4 Standard T/O/S 6 Arched 7 Elliptical 9 Rectilinear	Mica		

SAMPLE ORDER CODE

ROCF C	16	54	LY	JY	E	1	E	R	
---------------	-----------	-----------	-----------	-----------	----------	----------	----------	----------	--

DIMENSIONS INCHES / MM

D	W
16 / 406	24 / 610
16 / 406	30 / 762
16 / 406	36 / 914
16 / 406	42 / 1067
16 / 406	48 / 1219
16 / 406	54 / 1372
16 / 406	60 / 1524
16 / 406	66 / 1676
16 / 406	72 / 1829
16 / 406	78 / 1981
16 / 406	84 / 2134

PRICING

Source Laminate	Foundation Laminate	Flintwood
966	1023	1540
1023	1063	1594
1089	1137	1708
1151	1234	1847
1177	1278	1920
1209	1327	1989
1244	1369	2053
1291	1426	2138
1332	1482	2224
1415	1557	2333
1459	1632	2449

If Mica case is specified, add 138.

If Motion Control Mechanism is specified, add 232 (24" – 48" widths).

add 464 (54" – 84" widths).

This cabinet is a metal mounted storage unit that provides above worksurface storage capabilities.

WHAT'S INCLUDED

1 overhead cabinet, column- or wall-mounting supports, pulls, lock and keys, and components as listed below:

	Widths	
	24" to 48"	54" to 84"
Door	1	2
Divider	n/a	1

WHAT'S EXCLUDED

Structural Columns.

NOTES

This cabinet is shipped knocked down.

This cabinet has a 21 1/2" clearance between the top of the desk to the bottom of the cabinet.

Specify the width according to the width of the desk over which the overhead cabinet is mounted. Column-Mounted Overhead Cabinet width is actually 2.5" less.

Soft Touch (2) and Standard T/O/S (4) pulls are only available in limited Foundation colors. Refer to the specification software for details.

ROCML
Overhead Cabinet – Metal Flipper Door(s)– Linear Style

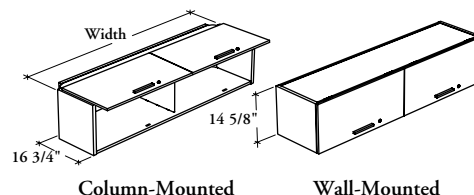

PRODUCT OPTIONS

Mounted Style	Depth	Width	Door Finish	Case Finish	Pull Style	Pull Finish	Key Style	Motion Control Mechanism
C Column-Mounted	16	24, 30, 36, 42, 48, 54, 60, 66, 72, 78, 84	Foundation	Foundation	1 Standard Expansion 2 Soft Touch 4 Standard T/O/S 6 Arched 7 Elliptical 9 Rectilinear	Foundation	K Keyed Alike R Keyed Randomly N No Lock	2 With Motion Control Mechanism
W Wall-Mounted			Mica	Mica		Accent		

SAMPLE ORDER CODE

ROCML W	16	24	E	E	9	K	N	2
----------------	-----------	-----------	----------	----------	----------	----------	----------	----------

DIMENSIONS
INCHES / MM

D	W
16 / 406	24 / 610
16 / 406	30 / 762
16 / 406	36 / 914
16 / 406	42 / 1067
16 / 406	48 / 1219
16 / 406	54 / 1372
16 / 406	60 / 1524
16 / 406	66 / 1676
16 / 406	72 / 1829
16 / 406	78 / 1981
16 / 406	84 / 2134

PRICING

DOOR FINISH	
Foundation	Mica
1023	1049
1063	1085
1137	1163
1234	1255
1278	1302
1327	1351
1369	1393
1426	1456
1482	1511
1557	1587
1632	1663

If Mica case is specified, add 138.

If Motion Control Mechanism is specified, add 262 (24" – 48" widths).
add 464 (54" – 84" widths).

mounted storage & accessories

Xpress

ROCMF

Overhead Cabinet – Metal Flipper Door(s)– Flush Front Style

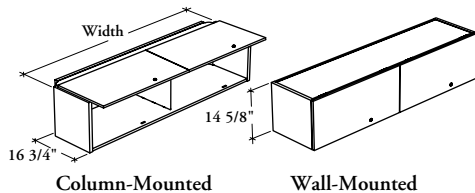

This cabinet is a metal mounted storage unit that provides above worksurface storage capabilities.

WHAT'S INCLUDED

1 overhead cabinet, column- or wall-mounting supports, lock and keys, and components as listed below:

	Widths	
	24" to 48"	54" to 84"
Door	1	2
Divider	n/a	1

WHAT'S EXCLUDED

Structural Columns.

NOTES

This cabinet is shipped knocked down.

This cabinet has a 21 1/2" clearance between the top of the desk to the bottom of the cabinet.

Specify the width according to the width of the worksurface over which the overhead cabinet is mounted. Column-Mounted Overhead Cabinet width is actually 2.5" less.

PRODUCT OPTIONS

Mounted Style	Depth	Width	Door Finish	Case Finish	Key Style	Motion Control Mechanism
C Column-Mounted	16	24, 30, 36, 42, 48, 54, 60, 66, 72, 78, 84	Foundation	Foundation	K Keyed Alike R Keyed Randomly N No Lock	2 With Motion Control Mechanism
W Wall-Mounted			Mica	Mica		

SAMPLE ORDER CODE

ROCMF W	16	24	E	E	K	2
----------------	-----------	-----------	----------	----------	----------	----------

DIMENSIONS INCHES / MM

D	W
16 / 406	24 / 610
16 / 406	30 / 762
16 / 406	36 / 914
16 / 406	42 / 1067
16 / 406	48 / 1219
16 / 406	54 / 1372
16 / 406	60 / 1524
16 / 406	66 / 1676
16 / 406	72 / 1829
16 / 406	78 / 1981
16 / 406	84 / 2134

PRICING

DOOR FINISH	
Foundation	Mica
1023	1049
1063	1085
1137	1163
1234	1255
1278	1302
1327	1351
1369	1393
1426	1456
1482	1511
1557	1587
1632	1663

If Mica case is specified, add 138.

If Motion Control Mechanism is specified, add 232 (24" – 48" widths).

add 464 (54" – 84" widths).

This cabinet is a metal mounted storage unit that provides above worksurface storage capabilities.

WHAT'S INCLUDED

1 overhead cabinet, column- or wall-mounting supports, pulls, lock and keys, and components as listed below:

	Widths	
	24" to 48"	54" to 84"
Door	1	2
Divider	n/a	1

WHAT'S EXCLUDED

Structural Columns.

NOTES

This cabinet has a 19 1/2" clearance between the top of the desk to the bottom of the cabinet.

This cabinet is shipped knocked down.

Specify the width according to the width of the desk over which the overhead cabinet is mounted. Column-Mounted Overhead Cabinet width is actually 2.5" less.

Soft Touch (2) and Standard T/O/S (4) pulls are only available in limited Foundation colors. Refer to the specification software for details.

RORL
Overhead Cabinet –
Solid Receding Door(s)

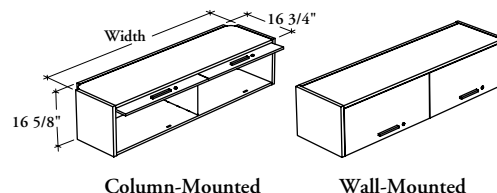

PRODUCT OPTIONS

Mounted Style	Depth	Width	Door Finish	Edge Trim Finish	Case Finish	Shelf and Divider Finish (Source Laminate Case only)	Pull Style	Pull Finish	Key Style
C Column-Mounted	16	24, 30, 36, 42, 48, 54, 60, 66, 72, 78, 84	Source Laminate	Edge Trim Colors	Source Laminate	Foundation	1 Standard Expansion	Foundation	K Keyed Alike
W Wall-Mounted			Foundation Laminate		Foundation Mica	Mica		2 Soft Touch	
			Flintwood			Coordinate Colors	4 Standard T/O/S	Mica	N No Lock
							6 Arched		
							7 Elliptical		
							9 Rectilinear		

SAMPLE ORDER CODE

RORL C	16	78	3D	4D	Q	6	E	R
---------------	-----------	-----------	-----------	-----------	----------	----------	----------	----------

DIMENSIONS
INCHES / MM

D	W
16 / 406	24 / 610
16 / 406	30 / 762
16 / 406	36 / 914
16 / 406	42 / 1067
16 / 406	48 / 1219
16 / 406	54 / 1372
16 / 406	60 / 1524
16 / 406	66 / 1676
16 / 406	72 / 1829
16 / 406	78 / 1981
16 / 406	84 / 2134

PRICING

Source Laminate	Foundation Laminate	Flintwood
1052	1110	1624
1108	1141	1674
1162	1208	1777
1215	1296	1915
1268	1369	2010
1717	1835	2496
1800	1924	2611
1884	2016	2728
1967	2118	2857
2051	2189	2970
2130	2304	3123

If Mica case is specified, add 138.

mounted storage & accessories

Xpress

R O R M L

Overhead Cabinet – Metal Receding Door(s) – Linear Style

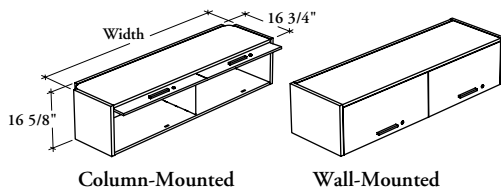

This cabinet is a metal mounted storage unit that provides above worksurface storage capabilities.

WHAT'S INCLUDED

1 overhead cabinet, column- or wall-mounting supports, pulls, lock and keys, and components as listed below:

	Widths	
	24" to 48"	54" to 84"
Door	1	2
Divider	n/a	1

WHAT'S EXCLUDED

Structural Columns.

NOTES

This cabinet has a 19 1/2" clearance between the top of the desk to the bottom of the cabinet.

This cabinet is shipped knocked down.

Specify the width according to the width of the desk over which the overhead cabinet is mounted. Column-Mounted Overhead Cabinet width is actually 2.5" less.

Soft Touch (2) and Standard T/O/S (4) pulls are only available in limited Foundation colors. Refer to the specification software for details.

PRODUCT OPTIONS

Mounted Style	Depth	Width	Door Finish	Case Finish	Pull Style	Pull Finish	Key Style
C Column-Mounted	16	24, 30, 36, 42, 48, 54, 60, 66, 72, 78, 84	Foundation Mica	Foundation Mica	1 Standard Expansion 2 Soft Touch 4 Standard T/O/S 6 Arched 7 Elliptical 9 Rectilinear	Foundation Accent Mica	K Keyed Alike R Keyed Randomly N No Lock
W Wall-Mounted							

SAMPLE ORDER CODE

RORML C	16	78	Q	Q	7	E	R
----------------	-----------	-----------	----------	----------	----------	----------	----------

DIMENSIONS INCHES / MM

D	W
16 / 406	24 / 610
16 / 406	30 / 762
16 / 406	36 / 914
16 / 406	42 / 1067
16 / 406	48 / 1219
16 / 406	54 / 1372
16 / 406	60 / 1524
16 / 406	66 / 1676
16 / 406	72 / 1829
16 / 406	78 / 1981
16 / 406	84 / 2134

PRICING

DOOR FINISH

Foundation	Mica
1110	1130
1141	1166
1208	1235
1296	1324
1369	1394
1835	1858
1924	1949
2016	2045
2118	2143
2189	2224
2304	2340

If Mica case is specified, add 138.

This cabinet is a metal mounted storage unit that provides above worksurface storage capabilities.

R O R M F

**Overhead Cabinet – Metal
Receding Door(s) – Flush Front Style**

WHAT'S INCLUDED

1 overhead cabinet, column- wall-mounting supports, lock and keys, and components as listed below:

	Widths	
	24" to 48"	54" to 84"
Door	1	2
Divider	n/a	1

WHAT'S EXCLUDED

Structural Columns.

NOTES

This cabinet has a 19 1/2" clearance between the top of the desk to the bottom of the cabinet.

This cabinet is shipped knocked down.

Specify the width according to the width of the desk over which the overhead cabinet is mounted. Column-Mounted Overhead Cabinet width is actually 2.5" less.

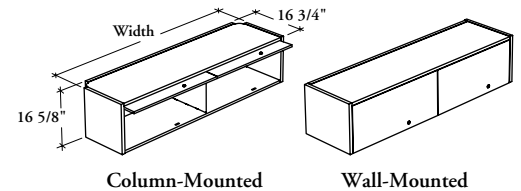

PRODUCT OPTIONS

Mounted Style	Depth	Width	Door Finish	Case Finish	Key Style
C Column-Mounted	16	24, 30, 36, 42, 48, 54, 60, 66, 72, 78, 84	Foundation	Foundation	K Keyed Alike R Keyed Randomly N No Lock
W Wall-Mounted			Mica	Mica	

SAMPLE ORDER CODE

RORMF W	16	24	E	E	K
----------------	-----------	-----------	----------	----------	----------

**DIMENSIONS
INCHES / MM**

D	W
16 / 406	24 / 610
16 / 406	30 / 762
16 / 406	36 / 914
16 / 406	42 / 1067
16 / 406	48 / 1219
16 / 406	54 / 1372
16 / 406	60 / 1524
16 / 406	66 / 1676
16 / 406	72 / 1829
16 / 406	78 / 1981
16 / 406	84 / 2134

PRICING

DOOR FINISH

Foundation	Mica
1110	1130
1141	1166
1208	1235
1296	1324
1369	1394
1835	1858
1924	1949
2016	2045
2118	2143
2189	2224
2304	2340

If Mica case is specified, add 138.

mounted storage & accessories

Xpress

ROCD

Overhead Cabinet – Sliding Doors

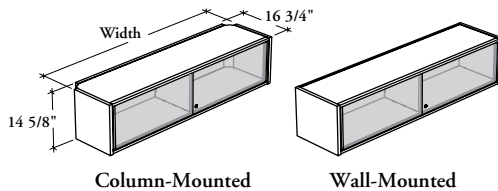

This cabinet is a mounted storage unit that provides above worksurface storage capabilities.

WHAT'S INCLUDED

1 overhead cabinet, column- or wall-mounting supports, 2 sliding doors, 2 sliding door pulls, 1 divider (54" to 84" only), lock and keys.

WHAT'S EXCLUDED

Structural Columns.

NOTES

This cabinet is shipped knocked down.

This cabinet has a 21 1/2" clearance between the top of the desk to the bottom of the cabinet.

Specify the width according to the width of the desk over which the overhead cabinet is mounted. Column-Mounted Overhead Cabinet width is actually 2.5" less.

Frosted (FT) is a single-sided etched tempered glass which is facing inward of cabinet.

Xpress Not all configurations are available as Xpress, Please see Xpress catalogue and/or specification software for details.

PRODUCT OPTIONS

Mounted Style	Depth	Case Finish	Sliding Rail and Shelf Finish (Source Laminate Case only)	Door Style	Door Finish	Edge Trim Finish	Key Style
C Column-Mounted	16	Source Laminate	Foundation	F Flintwood	Flintwood	Edge Trim Colors (for Laminate Sliding Doors)	K Keyed Alike R Keyed Randomly N No Lock
W Wall-Mounted	Width	Foundation Mica	Mica Coordinate Colors	G Glass L Laminate	Standard Glass: CL Clear FT Frosted Back-Painted Glass Source Laminate		
	30, 36, 42, 48, 54, 60, 66, 72, 78, 84					Foundation Mica	

SAMPLE ORDER CODE

ROCD C	16	48	3D	E	G	K8		E	N
---------------	-----------	-----------	-----------	----------	----------	-----------	--	----------	----------

DIMENSIONS INCHES / MM

D	W
16 / 406	30 / 762
16 / 406	36 / 914
16 / 406	42 / 1067
16 / 406	48 / 1219
16 / 406	54 / 1372
16 / 406	60 / 1524
16 / 406	66 / 1676
16 / 406	72 / 1829
16 / 406	78 / 1981
16 / 406	84 / 2134

PRICING

LAMINATE DOORS (L)		GLASS DOORS (G)		FLINTWOOD DOORS (F)
	Source Laminate	Clear (CL)	Frosted (FT)/ Back-Painted	Flintwood
	1195	1211	1296	1551
	1379	1384	1502	1812
	1472	1480	1604	1969
	1574	1580	1706	2145
	1777	1778	1920	2415
	1882	1888	2031	2591
	1978	2001	2141	2769
	2050	2083	2255	2912
	2137	2196	2368	3074
	2228	2291	2480	3218

If Mica case is specified, add 138.

This cabinet is a metal mounted storage unit that provides above worksurface storage capabilities.

WHAT'S INCLUDED

1 overhead cabinet, column- or wall-mounting supports, and 1 divider (54" to 84" only).

WHAT'S EXCLUDED

Structural Columns.

NOTES

Specify the width according to the width of the desk over which the overhead cabinet is mounted. Column-Mounted Overhead Cabinet width is actually 2.5" less.

This cabinet has a 21 1/2" clearance between the top of the desk to the bottom of the cabinet.

ROCO
Overhead Cabinet – No Door

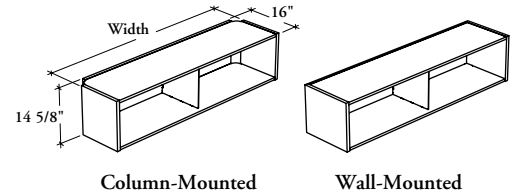

PRODUCT OPTIONS

Mounted Style	Depth	Width	Case Finish	Shelf and Divider Finish (Source Laminate Case only)
C Column-Mounted	16	24, 30, 36, 42, 48, 54, 60, 66, 72, 78, 84	Source Laminate	Foundation
W Wall-Mounted			Foundation	Mica
			Mica	Coordinate Colors

SAMPLE ORDER CODE

ROCO C	16	30	E	
---------------	-----------	-----------	----------	--

DIMENSIONS
INCHES / MM

D	W
16 / 406	24 / 610
16 / 406	30 / 762
16 / 406	36 / 914
16 / 406	42 / 1067
16 / 406	48 / 1219
16 / 406	54 / 1372
16 / 406	60 / 1524
16 / 406	66 / 1676
16 / 406	72 / 1829
16 / 406	78 / 1981
16 / 406	84 / 2134

PRICING

Source Laminate/Foundation	Mica
635	773
687	826
727	868
789	928
831	966
869	1008
890	1031
923	1063
950	1087
971	1111
1057	1195

mounted storage & accessories

Xpress

ROGF

Overhead Cabinet Filler

This Overhead Cabinet Filler is installed between two overhead cabinets for aesthetic look.

WHAT'S INCLUDED

1 overhead cabinet filler and mounting hardware.

NOTES

Must be used between two Column-Mounted Overhead Cabinets only.

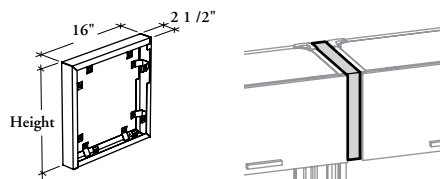

PRODUCT OPTIONS

Mounting Style	Overhead Style	Finish
C Column-Mounted	A ROCC, ROCHG, and ROCD B ROCF, ROCML, ROCMF, and ROCO C RORL, RORML, RORMF	Foundation Mica Coordinate Colors

SAMPLE ORDER CODE

ROGF C	B	7
---------------	----------	----------

STYLES

A
B
C

PRICING

	Foundation	Mica
A	304	333
B	304	333
C	304	333

This shelf provides a convenient open storage space above the worksurface.

WHAT'S INCLUDED

1 shelf, 2 shelf supports, 1 back rail, and mounting hardware.

WHAT'S EXCLUDED

Structural Columns and Shelf Adapter for Universal Light.

NOTES

Specify the width according to the width of the desk over which the shelf is mounted.
Shelf width is actually 2.5" less.

ROSL
Shelf – Solid

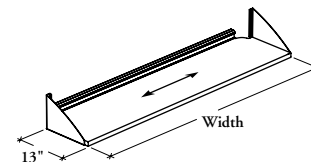

PRODUCT OPTIONS

Shelf Style	Depth	Width	Shelf Finish	Edge Trim Finish	Hardware and Support Rail Finish
L Linear	13	24, 30, 36, 42, 48, 54, 60, 66, 72, 78, 84	Source Laminate Foundation Laminate Flintwood	Edge Trim Colors	Foundation Mica

SAMPLE ORDER CODE

ROSL L	13	24	2D	4D	G
---------------	-----------	-----------	-----------	-----------	----------

DIMENSIONS
INCHES / MM

D	W
13 / 330	24 / 610
13 / 330	30 / 762
13 / 330	36 / 914
13 / 330	42 / 1067
13 / 330	48 / 1219
13 / 330	54 / 1372
13 / 330	60 / 1524
13 / 330	66 / 1676
13 / 330	72 / 1829
13 / 330	78 / 1981
13 / 330	84 / 2134

PRICING

LINEAR (L)			
	Source Laminate	Foundation Laminate	Flintwood
	404	445	956
	411	454	969
	428	471	1010
	449	493	1060
	456	499	1079
	469	515	1108
	471	517	1110
	493	542	1168
	510	559	1199
	519	571	1226
	525	578	1250

If Mica Hardware is specified, add 28.

mounted storage & accessories

Xpress

ROSM Shelf – Metal

This shelf provides a convenient open storage space above the worksurface.

WHAT'S INCLUDED

1 shelf, 2 shelf supports, 1 back rail, and mounting hardware.

WHAT'S EXCLUDED

Structural Columns.

NOTES

Specify the width according to the width of the desk over which the shelf is mounted. Shelf width is actually 2.5" less.

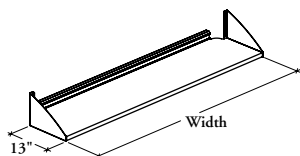

PRODUCT OPTIONS

Shelf Style	Depth	Width	Shelf Finish	Hardware and Support Rail Finish
L Linear	13	24, 30, 36, 42, 48, 54, 60, 66, 72, 78, 84	Foundation Mica	Foundation Mica

SAMPLE ORDER CODE

ROSM L	13	24	G	G
---------------	-----------	-----------	----------	----------

DIMENSIONS INCHES / MM

D	W
13 / 330	24 / 610
13 / 330	30 / 762
13 / 330	36 / 914
13 / 330	42 / 1067
13 / 330	48 / 1219
13 / 330	54 / 1372
13 / 330	60 / 1524
13 / 330	66 / 1676
13 / 330	72 / 1829
13 / 330	78 / 1981
13 / 330	84 / 2134

PRICING

	Foundation	Mica
	428	474
	490	542
	510	565
	535	594
	554	617
	567	632
	582	643
	602	670
	638	708
	643	718
	654	725

If Mica Hardware is specified, add 28.

The Accessory Rail is designed to support Personal Organizers (PAX) and fx Personal Organizers (YFX), and to facilitate workplace organization.

WHAT'S INCLUDED

1 accessory rail with mounting hardware.

WHAT'S EXCLUDED

Structural Columns and Personal Organizers.

NOTES

Dimensions are nominal. Specify the width according to the width of the desk over which the rail is mounted.

Can be shared between desks to reduce costs.

ROAR
Accessory Rail

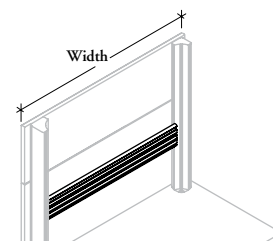

PRODUCT OPTIONS

Configuration	Mounting Style	Width	Finish
D Shared	C Column-Mounted	24, 30, 36, 42, 48, 54, 60, 66, 72, 78, 84	Foundation Mica

SAMPLE ORDER CODE

ROAR D	C	60	E
---------------	----------	-----------	----------

DIMENSIONS
INCHES / MM

W
24 / 610
30 / 762
36 / 914
42 / 1067
48 / 1219
54 / 1372
60 / 1524
66 / 1676
72 / 1829
78 / 1981
84 / 2134

PRICING

	Foundation	Mica
	95	108
	124	133
	144	166
	173	193
	198	217
	225	245
	251	275
	271	299
	297	328
	321	355
	350	385

mounted storage & accessories

Xpress

RPWT

Wall-Mounted Tackboard

This fabric-wrapped tackboard can be installed under all Wall-Mounted Overhead Cabinets.

WHAT'S INCLUDED

1 wall-mounted tackboard and hardware.

NOTES

To keep existing datum line, use 20" high Wall-Mounted Tackboard for all Wall-Mounted Overhead Cabinets – Receding Door(s). The 22" high must be specified for the other types.

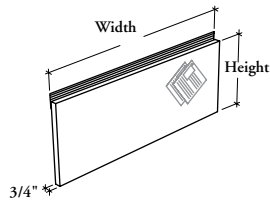

PRODUCT OPTIONS

Height	Width	Finish
20, 22	24, 30, 36, 42, 48, 54, 60, 66, 72, 78, 84	Panel Fabric

SAMPLE ORDER CODE

RPWT 20	78	P403
----------------	-----------	-------------

**DIMENSIONS
INCHES / MM**

H	W
20 / 508	24 / 610
20 / 508	30 / 762
20 / 508	36 / 914
20 / 508	42 / 1067
20 / 508	48 / 1219
20 / 508	54 / 1372
20 / 508	60 / 1524
20 / 508	66 / 1676
20 / 508	72 / 1829
20 / 508	78 / 1981
20 / 508	84 / 2134
22 / 559	24 / 610
22 / 559	30 / 762
22 / 559	36 / 914
22 / 559	42 / 1067
22 / 559	48 / 1219
22 / 559	54 / 1372
22 / 559	60 / 1524
22 / 559	66 / 1676
22 / 559	72 / 1829
22 / 559	78 / 1981
22 / 559	84 / 2134

PRICING

Gr. A/COM	Gr. 1	Gr. 2	Gr. 3	Gr. 4	Gr. 5	Gr. 6	Gr. 7
209	217	226	235	253	271	296	320
222	227	240	252	277	298	327	355
240	251	264	280	307	338	368	399
253	263	282	293	324	354	389	418
328	343	361	374	405	437	477	516
343	354	374	390	425	459	499	542
364	375	399	414	455	492	538	580
375	390	413	430	473	516	564	609
389	404	428	449	493	541	590	638
401	414	445	464	513	559	610	661
412	429	457	477	525	574	628	676
220	227	240	249	269	291	318	345
233	240	253	264	291	317	347	374
253	263	280	293	324	354	389	418
267	280	295	309	340	370	404	437
348	362	378	396	428	462	505	546
362	372	396	411	448	486	528	573
379	398	419	437	477	519	567	612
398	411	434	455	496	542	592	639
411	426	451	471	519	567	616	667
420	437	466	490	544	596	650	704
432	454	481	506	557	610	666	720

PAX

Personal Organizers

Personal Organizers can be mounted on the Accessory Rail (ROAR) to facilitate paper management and storage.

WHAT'S INCLUDED

1 personal organizer (as specified).

NOTES

The Media Organizer holds up to 10 CDs or two boxes of diskettes.

The Telephone Shelves accommodate large and small telephones. The shelves may also be used to display/support work in progress.

Vertical Organizers can be used separately or grouped together to create cascading work managers.

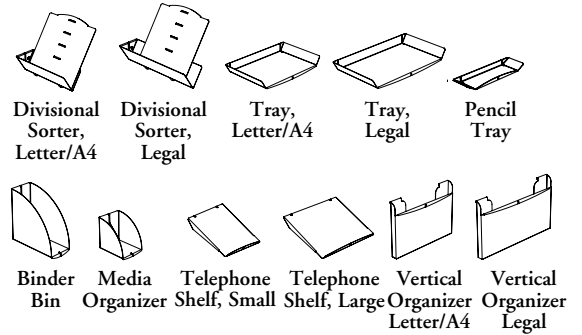

PRODUCT OPTIONS

Style	Finish
90 Divisional Sorter, Letter/A4	Foundation Accent Mica
91 Divisional Sorter, Legal	
92 Tray, Letter/A4	
93 Tray, Legal	
94 Pencil Tray	
95 Binder Bin	
96 Media Organizer	
97 Telephone Shelf, Small	
98 Telephone Shelf, Large	
99 Vertical Organizer, Letter/A4	
100 Vertical Organizer, Legal	

SAMPLE ORDER CODE

PAX 99	C
---------------	----------

STYLE

PRICING

	Foundation	Mica/Accent
90	49	77
91	51	78
92	55	79
93	56	80
94	36	49
95	56	80
96	52	59
97	81	94
98	87	100
99	85	96
100	92	100

credenzas

credenzas product map

R S C L D Freestanding Credenza – Box/File Drawers

Page 426

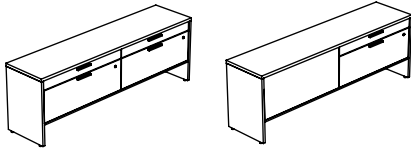

R S C O D Freestanding Credenza – Open with Box/File Drawers

Page 428

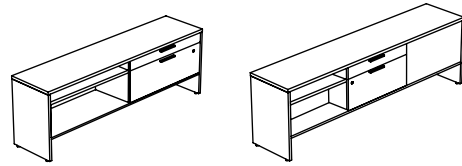

R S C L L Freestanding Credenza – Lateral Files

Page 430

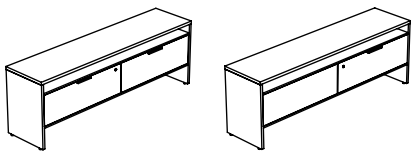

R S C O L Freestanding Credenza – Open with Lateral Files

Page 432

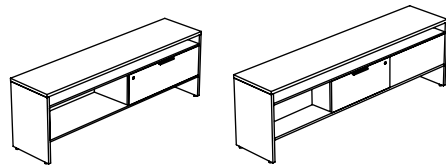

R S C S S Freestanding Credenza – Sliding Doors

Page 434

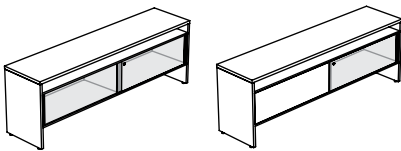

R S C O S Freestanding Credenza – Open with Sliding Doors

Page 438

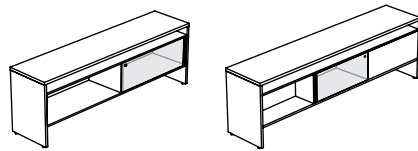

R S M D Worksurface Drawer Support – Low Credenza

Page 442

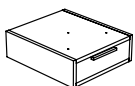

R S S C Seat Cushion

Page 443

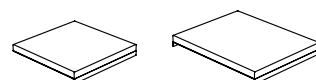

credenzas

Xpress

RSCLD

Freestanding Credenza – Box/File Drawers

This freestanding credenza provides box and file storage on one or both sides. 23" high can also support worksurfaces.

WHAT'S INCLUDED

1 credenza with gables and levelers, 2 box and 2 file drawers (as specified), 1 pencil tray (single-sided option) or 2 (shared option), 1 pull per drawer (as specified), locks and keys, counterweights (if applicable), mounting hardware, and cross file bars are listed below:

Widths	
48" or 54"	60" – 72"
1	2

15" Cross File Bar (per file drawer)

Single-Sided Configuration (S) comes with two box and two file drawers on the same side. Shared Configuration (L or R) comes with one box and one file drawer on each side.

NOTES

Each lock secures one box and one file drawer.

Soft Touch (2) and Standard T/O/S (4) pulls are only available in limited Foundation colors. Refer to the specification software for details.

Worksurface Finish Source Laminate is only available with 23" (low) credenza. In this case, Worksurface Edge Trim Style and Finish are **not** available.

Included cross file bars are to be installed along the depth only.

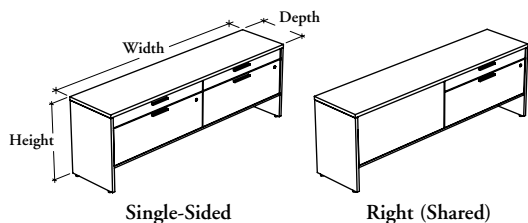

PRODUCT OPTIONS

Height	Configuration	Depth	Width	Worksurface Finish	Edge Trim Style	Edge Trim Finish
L 23" (low)	S Single-Sided	20, 24	48, 54, 60, 66, 72	Source Laminate	6 Straight Trim	Edge Trim Colors (for trim style 6)
H 29" (high) (Shown)	L Left (Shared) R Right (Shared)			Foundation Laminate Flintwood	9 Flintwood Flat Trim	

SAMPLE ORDER CODE

RSCLD H	S	24	72	LW	6	ST
----------------	----------	-----------	-----------	-----------	----------	-----------

PRODUCT OPTIONS CONTINUED

Case and Gable Finish	Drawer Front and Back Finish	Edge Trim Finish	Pull Style	Pull Finish	Cable Pass-Through/Grommet	Key Style
Source Laminate	Source Laminate Flintwood	Edge Trim Colors (for laminate drawer front)	1 Standard Expansion 2 Soft Touch 4 Standard T/O/S 6 Arched 7 Elliptical 9 Rectilinear	Foundation Accent Mica	N No Grommet/ No Cable Pass-Through	K Keyed Alike R Keyed Randomly N No Lock

SAMPLE ORDER CODE CONTINUED

XS	XS	ST	9	E	N	N
-----------	-----------	-----------	----------	----------	----------	----------

See Pricing on the following page.

R S C L D

Freestanding Credenza – Box/File Drawers (Continued)

DIMENSIONS
INCHES / MM

D	W
20 / 508	48 / 1219
20 / 508	54 / 1372
20 / 508	60 / 1524
20 / 508	66 / 1676
20 / 508	72 / 1829
24 / 610	48 / 1219
24 / 610	54 / 1372
24 / 610	60 / 1524
24 / 610	66 / 1676
24 / 610	72 / 1829

PRICING

23" (LOW)			
SINGLE-SIDED (S)		SHARED (L / R)	
Source Laminate Front and Back	Flintwood Front and Back	Source Laminate Front and Back	Flintwood Front and Back
SOURCE LAMINATE WORKSURFACE			
2010	3731	n/a	n/a
2118	3980	n/a	n/a
2209	4236	2209	4236
2333	4522	2333	4522
2459	4813	2459	4813
2108	3826	n/a	n/a
2219	4086	n/a	n/a
2322	4351	2322	4351
2456	4642	2456	4642
2587	4940	2587	4940

29" (HIGH)			
SINGLE-SIDED (S)		SHARED (L / R)	
Source Laminate Front and Back	Flintwood Front and Back	Source Laminate Front and Back	Flintwood Front and Back
FOUNDATION LAMINATE WORKSURFACE			
20 / 508	48 / 1219	n/a	n/a
20 / 508	54 / 1372	n/a	n/a
20 / 508	60 / 1524	2398	4421
20 / 508	66 / 1676	2536	4721
20 / 508	72 / 1829	2670	5023
24 / 610	48 / 1219	n/a	n/a
24 / 610	54 / 1372	n/a	n/a
24 / 610	60 / 1524	2540	4566
24 / 610	66 / 1676	2689	4875
24 / 610	72 / 1829	2841	5190

FLINTWOOD WORKSURFACE			
20 / 508	48 / 1219	n/a	n/a
20 / 508	54 / 1372	n/a	n/a
20 / 508	60 / 1524	3008	5031
20 / 508	66 / 1676	3208	5393
20 / 508	72 / 1829	3383	5736
24 / 610	48 / 1219	n/a	n/a
24 / 610	54 / 1372	n/a	n/a
24 / 610	60 / 1524	3233	5259
24 / 610	66 / 1676	3452	5638
24 / 610	72 / 1829	3674	6023

credenzas

Xpress

RSCOD Freestanding Credenza – Open with Box/File Drawers

This freestanding credenza provides box, file and open binder storage on one or both sides. 23" high can also support worksurfaces.

WHAT'S INCLUDED

1 credenza with gables and levelers, 1 or 2 open compartments, 1 or 2 box and file drawers, 1 pull per drawer (as specified), 1 pencil tray per box drawer, locks and keys, counterweights (if applicable), mounting hardware, and hanging file bar listed below:

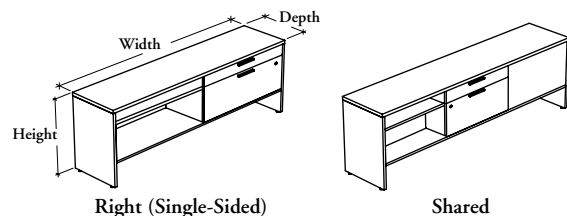

	Widths	
	Single-Sided Config.	Shared Config.
	60" – 72"	60" 66" – 84"

12" Hanging File Bar	n/a	1	n/a (per file drawer)
15" Cross File Bar	2	n/a	1 (per file drawer)

NOTES

Each lock serrures one box and one file drawer.

Soft Touch (2) and Standard T/O/S (4) pulls are only available in limited Foundation colors. Refer to the specification software for details.

Worksurface Finish Source Laminate is only available with 23" (low) credenza. In this case, Worksurface Edge Trim Style and Finish are **not** available.

The 12" hanging file installs along the width only. The 15" cross file install along the depth only.

PRODUCT OPTIONS

Height	Configuration	Depth	Width	Worksurface Finish	Edge Trim Style	Edge Trim Finish
L 23" (low)	D Shared	20, 24	60, 66, 72, 78, 84	Source Laminate	6 Straight Trim	Edge Trim Colors (for trim style 6)
H 29" (high) (Shown)	L Left (Single-Sided) R Right (Single-Sided)			Foundation Laminate Flintwood	9 Flintwood Flat Trim	

SAMPLE ORDER CODE

RSCOD L	L	24	78	XS		
----------------	----------	-----------	-----------	-----------	--	--

PRODUCT OPTIONS CONTINUED

Case and Gable Finish	Drawer Front and Back Finish	Edge Trim Finish	Pull Style	Pull Finish	Cable Pass-Through/Grommet	Key Style
Source Laminate	Source Laminate Flintwood	Edge Trim Colors (for laminate drawer front)	1 Standard Expansion 2 Soft Touch 4 Standard T/O/S 6 Arched 7 Elliptical 9 Rectilinear	Foundation Accent Mica	N No Grommet/ No Cable Pass-Through	K Keyed Alike R Keyed Randomly N No Lock

SAMPLE ORDER CODE CONTINUED

XS	XS	ST	9	E	N	N
-----------	-----------	-----------	----------	----------	----------	----------

See Pricing on the following page.

R S C O D
Freestanding Credenza – Open with
Box/File Drawers (Continued)

DIMENSIONS
INCHES / MM

PRICING

DIMENSIONS INCHES / MM		23" (LOW)			
		SINGLE-SIDED (L / R)		SHARED (D)	
D	W	Source Laminate Front and Back	Flintwood Front and Back	Source Laminate Front and Back	Flintwood Front and Back
SOURCE LAMINATE WORKSURFACE					
20 / 508	60 / 1524	1632	2970	2095	4063
20 / 508	66 / 1676	1721	3181	2223	4349
20 / 508	72 / 1829	1815	3392	2343	4634
20 / 508	78 / 1981	n/a	n/a	2463	4915
20 / 508	84 / 2134	n/a	n/a	2588	5159
24 / 610	60 / 1524	1739	3082	2207	4177
24 / 610	66 / 1676	1839	3300	2342	4468
24 / 610	72 / 1829	1943	3522	2468	4763
24 / 610	78 / 1981	n/a	n/a	2598	5048
24 / 610	84 / 2134	n/a	n/a	2729	5301
29" (HIGH)					
DIMENSIONS INCHES / MM		29" (HIGH)			
		SINGLE-SIDED (L / R)		SHARED (D)	
D	W	Source Laminate Front and Back	Flintwood Front and Back	Source Laminate Front and Back	Flintwood Front and Back
FOUNDATION LAMINATE WORKSURFACE					
20 / 508	60 / 1524	1815	3154	2282	4248
20 / 508	66 / 1676	1920	3378	2417	4547
20 / 508	72 / 1829	2027	3606	2552	4848
20 / 508	78 / 1981	n/a	n/a	2689	5139
20 / 508	84 / 2134	n/a	n/a	2828	5396
24 / 610	60 / 1524	1957	3299	2426	4394
24 / 610	66 / 1676	2076	3535	2576	4701
24 / 610	72 / 1829	2196	3776	2723	5014
24 / 610	78 / 1981	n/a	n/a	2865	5316
24 / 610	84 / 2134	n/a	n/a	3015	5583
FLINTWOOD WORKSURFACE FINISH					
20 / 508	60 / 1524	2425	3764	2892	4858
20 / 508	66 / 1676	2592	4050	3089	5219
20 / 508	72 / 1829	2740	4319	3265	5561
20 / 508	78 / 1981	n/a	n/a	3440	5890
20 / 508	84 / 2134	n/a	n/a	3634	6202
24 / 610	60 / 1524	2650	3992	3119	5087
24 / 610	66 / 1676	2839	4298	3339	5464
24 / 610	72 / 1829	3029	4609	3556	5847
24 / 610	78 / 1981	n/a	n/a	3763	6214
24 / 610	84 / 2134	n/a	n/a	3981	6549

credenzas

Xpress

RSCLL

Freestanding Credenza – Lateral Files

This freestanding credenza provides lateral file storage and pigeonhole on one or both sides. It can also support the worksurfaces.

WHAT'S INCLUDED

1 credenza with gables and levelers, 2 lateral file drawers (as specified), 1 pull per drawer (as specified), grommets or cable pass-through ring (if specified), locks and keys, mounting hardware, and cross file bars are listed below:

Widths	
48" or 54"	60" – 84"

15" Cross File Bar 1 2 (per drawer)

Single-Sided Configuration (S) comes with two lateral file drawers on the same side. Shared Configuration (L or R) comes with one lateral file drawer on each side.

WHAT'S EXCLUDED

Cable Pass-Through Cover (if applicable).

NOTES

Grommets are finished to match the gables and Cable Pass-Through ring comes in a Platinum Coordinate.

With Cable Pass-Through option is only available on the 29" high (H), Single-Sided (S) and 24" deep configuration. See application guide for details.

Soft Touch (2) and Standard T/O/S (4) pulls are only available in limited Foundation colors. Refer to the specification software for details.

Worksurface Finish Source Laminate is only available with 23" (low) credenza. In this case, Worksurface Edge Trim Style and Finish are **not** available.

Included cross file bars are to be installed along the depth only.

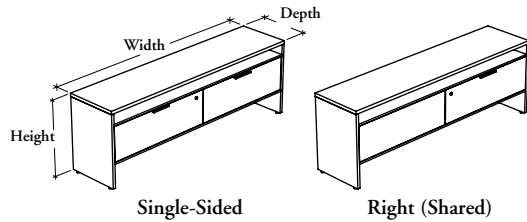

PRODUCT OPTIONS

Height	Configuration	Depth	Width	Worksurface Finish	Edge Trim Style	Edge Trim Finish
L 23" (low)	S Single-Sided	20, 24	48, 54, 60, 66, 72, 78, 84	Source Laminate	6 Straight Trim	Edge Trim Colors (for trim style 6)
H 29" (high) (Shown)	L Left (Shared) R Right (Shared)			Foundation Laminate Flintwood	9 Flintwood Flat Trim	

SAMPLE ORDER CODE

RSCLL H	S	24	72	LW	6	ST
----------------	----------	-----------	-----------	-----------	----------	-----------

PRODUCT OPTIONS CONTINUED

Case and Gable Finish	Drawer Front and Back Finish	Edge Trim Finish	Pull Style	Pull Finish	Cable Pass-Through/Grommet	Key Style
Source Laminate	Source Laminate Flintwood	Edge Trim Colors (for laminate drawer front)	1 Standard Expansion 2 Soft Touch 4 Standard T/O/S 6 Arched 7 Elliptical 9 Rectilinear	Foundation Accent Mica	G With Grommet N No Grommet/No Cable Pass-Through P With Cable Pass-Through	K Keyed Alike R Keyed Randomly N No Lock

SAMPLE ORDER CODE CONTINUED

XS	XS	ST	9	E	G	N
-----------	-----------	-----------	----------	----------	----------	----------

See Pricing on the following page.

R S C L L
Freestanding Credenza –
Lateral Files (Continued)

DIMENSIONS
INCHES / MM

D	W
20 / 508	48 / 1219
20 / 508	54 / 1372
20 / 508	60 / 1524
20 / 508	66 / 1676
20 / 508	72 / 1829
20 / 508	78 / 1981
20 / 508	84 / 2134
24 / 610	48 / 1219
24 / 610	54 / 1372
24 / 610	60 / 1524
24 / 610	66 / 1676
24 / 610	72 / 1829
24 / 610	78 / 1981
24 / 610	84 / 2134

20 / 508	48 / 1219
20 / 508	54 / 1372
20 / 508	60 / 1524
20 / 508	66 / 1676
20 / 508	72 / 1829
20 / 508	78 / 1981
20 / 508	84 / 2134
24 / 610	48 / 1219
24 / 610	54 / 1372
24 / 610	60 / 1524
24 / 610	66 / 1676
24 / 610	72 / 1829
24 / 610	78 / 1981
24 / 610	84 / 2134

20 / 508	48 / 1219
20 / 508	54 / 1372
20 / 508	60 / 1524
20 / 508	66 / 1676
20 / 508	72 / 1829
20 / 508	78 / 1981
20 / 508	84 / 2134
24 / 610	48 / 1219
24 / 610	54 / 1372
24 / 610	60 / 1524
24 / 610	66 / 1676
24 / 610	72 / 1829
24 / 610	78 / 1981
24 / 610	84 / 2134

PRICING

23" (LOW)			
SINGLE-SIDED (S)		SHARED (L / R)	
Source Laminate Front and Back	Flintwood Front and Back	Source Laminate Front and Back	Flintwood Front and Back
SOURCE LAMINATE WORKSURFACE			
1578	2720	n/a	n/a
1674	2949	n/a	n/a
1767	3195	1767	3195
1884	3461	1884	3461
1999	3731	1999	3731
2114	3988	2114	3988
2230	4210	2230	4210
1674	2815	n/a	n/a
1775	3052	n/a	n/a
1880	3306	1880	3306
2002	3581	2002	3581
2125	3856	2125	3856
2247	4126	2247	4126
2370	4353	2370	4353

29" (HIGH)			
SINGLE-SIDED (S)		SHARED (L / R)	
Source Laminate Front and Back	Flintwood Front and Back	Source Laminate Front and Back	Flintwood Front and Back
FOUNDATION LAMINATE WORKSURFACE			
1735	2878	n/a	n/a
1844	3122	n/a	n/a
1951	3378	1951	3378
2082	3660	2082	3660
2209	3938	2209	3938
2340	4215	2340	4215
2466	4449	2466	4449
1858	3001	n/a	n/a
1978	3257	n/a	n/a
2095	3525	2095	3525
2236	3819	2236	3819
2377	4105	2377	4105
2513	4393	2513	4393
2656	4634	2656	4634

FLINTWOOD WORKSURFACE			
2226	3369	n/a	n/a
2396	3674	n/a	n/a
2561	3988	2561	3988
2754	4332	2754	4332
2922	4651	2922	4651
3091	4966	3091	4966
3272	5255	3272	5255
2410	3553	n/a	n/a
2606	3885	n/a	n/a
2788	4218	2788	4218
2999	4582	2999	4582
3210	4938	3210	4938
3411	5291	3411	5291
3622	5600	3622	5600

credenzas

Xpress

RSCOL Freestanding Credenza – Open with Lateral Files

This freestanding credenza provides lateral file storage, open binder storage and pigeonhole on one or both sides. It can also support the worksurfaces.

WHAT'S INCLUDED

1 credenza with gables and levelers, 1 or 2 open compartments, 1 or 2 lateral file drawers, 1 pull per drawer (as specified), grommets or cable pass-through ring (as specified), locks and keys, mounting hardware, and hanging file bar listed below:

	Widths	
	Single-Sided Config.	Shared Config.
	60" – 84"	60" 66" – 84"
12" Hanging File Bar	n/a	1 n/a (per drawer)
15" Cross File Bar	2	n/a 1 (per drawer)

WHAT'S EXCLUDED

Cable Pass-Through Cover (if applicable).

NOTES

Grommets are finished to match the gables and Cable Pass-Through ring comes in a Platinum Coordinate.

With Cable Pass-Through option is only available on the 29" high (H), Single-Sided (L or R) and 24" deep configuration. See application guide for details.

Soft Touch (2) and Standard T/O/S (4) pulls are only available in limited Foundation colors. Refer to the specification software for details.

Worksurface Finish Source Laminate is only available with 23" (low) credenza. In this case, Worksurface Edge Trim Style and Finish are **not** available.

The 12" hanging file installs along the width only. The 15" cross file install along the depth only.

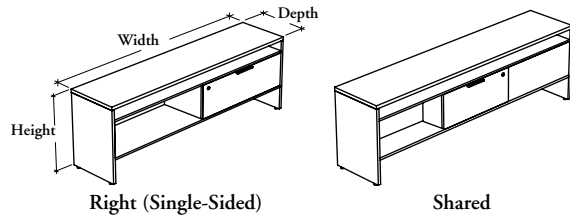

PRODUCT OPTIONS

Height	Configuration	Depth	Width	Worksurface Finish	Edge Trim Style	Edge Trim Finish
L 23" (low)	D Shared	20, 24	60, 66, 72, 78, 84	Source Laminate	6 Straight Trim	Edge Trim Colors (for trim style 6)
H 29" (high) (Shown)	L Left (Single-Sided) R Right (Single-Sided)			Foundation Laminate Flintwood	9 Flintwood Flat Trim	

SAMPLE ORDER CODE

RSCOL L	L	24	78	XN		
----------------	----------	-----------	-----------	-----------	--	--

PRODUCT OPTIONS CONTINUED

Case and Gable Finish	Drawer Front and Back Finish	Edge Trim Finish	Pull Style	Pull Finish	Cable Pass-Through/Grommet	Key Style
Source Laminate	Source Laminate Flintwood	Edge Trim Colors (for laminate drawer front)	1 Standard Expansion 2 Soft Touch 4 Standard T/O/S 6 Arched 7 Elliptical 9 Rectilinear	Foundation Accent Mica	G With Grommet N No Grommet/ No Cable Pass-Through P With Cable Pass-Through	K Keyed Alike R Keyed Randomly N No Lock

SAMPLE ORDER CODE CONTINUED

XS	XS	ST	9	E	N	N
-----------	-----------	-----------	----------	----------	----------	----------

See Pricing on the following page.

R S C O L Freestanding Credenza – Open with Lateral Files (Continued)

DIMENSIONS
INCHES / MM

D	W
20 / 508	60 / 1524
20 / 508	66 / 1676
20 / 508	72 / 1829
20 / 508	78 / 1981
20 / 508	84 / 2134
24 / 610	60 / 1524
24 / 610	66 / 1676
24 / 610	72 / 1829
24 / 610	78 / 1981
24 / 610	84 / 2134

PRICING

23" (LOW)			
SINGLE-SIDED (L / R)		SHARED (D)	
Source Laminate Front and Back	Flintwood Front and Back	Source Laminate Front and Back	Flintwood Front and Back
SOURCE LAMINATE WORKSURFACE			
1411	2480	1682	3111
1496	2678	1799	3377
1585	2883	1913	3646
1672	3082	2029	3908
1760	3246	2145	4127
1517	2588	1796	3220
1612	2799	1920	3495
1711	3009	2042	3775
1807	3216	2167	4043
1902	3388	2286	4270

29" (HIGH)			
SINGLE-SIDED (L / R)		SHARED (D)	
Source Laminate Front and Back	Flintwood Front and Back	Source Laminate Front and Back	Flintwood Front and Back
FOUNDATION LAMINATE WORKSURFACE			
1594	2663	1865	3293
1692	2878	1999	3575
1797	3093	2125	3856
1897	3306	2255	4132
2000	3487	2381	4366
1737	2807	2011	3442
1849	3033	2153	3734
1964	3261	2293	4023
2074	3483	2430	4308
2185	3673	2572	4552

FLINTWOOD WORKSURFACE FINISH			
2204	3273	2475	3903
2364	3550	2671	4247
2510	3806	2838	4569
2648	4057	3006	4883
2806	4293	3187	5172
2430	3500	2704	4135
2612	3796	2916	4497
2797	4094	3126	4856
2972	4381	3328	5206
3151	4639	3538	5518

20 / 508	60 / 1524
20 / 508	66 / 1676
20 / 508	72 / 1829
20 / 508	78 / 1981
20 / 508	84 / 2134
24 / 610	60 / 1524
24 / 610	66 / 1676
24 / 610	72 / 1829
24 / 610	78 / 1981
24 / 610	84 / 2134

credenzas

Xpress

R S C S S

Freestanding Credenza – Sliding Doors

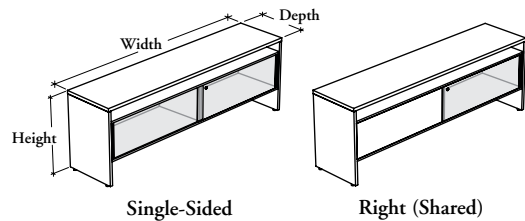

This freestanding credenza provides a closed convenient storage space and pigeonhole on one or both sides. It can also support the worksurfaces.

WHAT'S INCLUDED

1 credenza with gables and levelers, 2 sliding doors (as specified), 2 sliding door pulls, grommets or cable pass-through ring (as specified), mounting hardware, locks and keys.

Single Configuration (S) comes with two sliding doors on the same side.

Shared Configuration (L or R) comes with one sliding door on each side.

WHAT'S EXCLUDED

Cable Pass-Through Cover (if applicable).

NOTES

Grommets are finished to match the gables and Cable Pass-Through ring comes in a Platinum Coordinate.

With Cable Pass-Through option is only available on the 29" high (H), Single-Sided (S) and 24" deep configuration. See application guide for details

Worksurface Finish Source Laminate is only available with 23" (low) credenza. In this case, Worksurface Edge Trim Style and Finish are **not** available.

Frosted (FT) is a single-sided etched tempered glass which is facing inward of credenza.

Xpress Not all configurations are available as Xpress, Please see Xpress catalogue and/or specification software for details.

PRODUCT OPTIONS

Height	Configuration	Depth	Width	Worksurface Finish	Edge Trim Style	Edge Trim Finish	Case and Gable Finish
L 23" (low)	S Single-Sided	20, 24	36, 42, 48, 54, 60, 66, 72, 78, 84	Source Laminate	6 Straight Trim	Edge Trim Colors (for trim style 6)	Source Laminate
H 29" (high) (Shown)	L Left (Shared) R Right (Shared)			Foundation Laminate Flintwood	9 Flintwood Flat Trim		

SAMPLE ORDER CODE

RSCSS H	S	24	78	XG	6	SS	XG
----------------	----------	-----------	-----------	-----------	----------	-----------	-----------

PRODUCT OPTIONS CONTINUED

Back Finish	Sliding Rail Finish	Door Style	Door Finish	Edge Trim Finish	Pull Finish	Cable Pass-Through/Grommet	Key Style
Source Laminate Flintwood	Foundation Mica	F Flintwood G Glass L Laminate	Source Laminate Flintwood Standard Glass: CL Clear FT Frosted Back-Painted Glass	Edge Trim Colors (for laminate sliding doors)	Foundation Mica	G With Grommet N No Grommet/No Cable Pass-Through P With Cable Pass-Through	K Keyed Alike R Keyed Randomly N No Lock

SAMPLE ORDER CODE CONTINUED

XG	E	G	K1	E	N	K
-----------	----------	----------	-----------	----------	----------	----------

See Pricing on the following page.

R S C S S

Freestanding Credenza – Sliding Doors (Continued)

DIMENSIONS
INCHES / MM

PRICING

23" (LOW)
SINGLE-SIDED (S)

SOURCE LAMINATE WORKSURFACE

SOURCE LAMINATE BACK

FLINTWOOD BACK

D	W	Source Laminate Front	Clear (CL) Front	Frosted (FT)/ Back-Painted Front	Flintwood Front	Clear (CL) Front	Frosted (FT)/ Back-Painted Front	Flintwood Front
20 / 508	36 / 914	1184	1238	1376	1617	1670	1808	2049
20 / 508	42 / 1067	1302	1341	1482	1799	1836	1977	2294
20 / 508	48 / 1219	1423	1452	1592	1995	2024	2164	2567
20 / 508	54 / 1372	1542	1556	1696	2180	2194	2334	2818
20 / 508	60 / 1524	1661	1662	1803	2375	2377	2518	3090
20 / 508	66 / 1676	1760	1763	1902	2549	2553	2692	3339
20 / 508	72 / 1829	1857	1880	2021	2723	2747	2888	3590
20 / 508	78 / 1981	1956	1996	2136	2897	2934	3074	3835
20 / 508	84 / 2134	2056	2112	2253	3045	3104	3245	4037
24 / 610	36 / 914	1261	1317	1457	1696	1749	1889	2128
24 / 610	42 / 1067	1392	1429	1569	1887	1924	2064	2382
24 / 610	48 / 1219	1517	1546	1688	2090	2118	2260	2662
24 / 610	54 / 1372	1648	1660	1800	2284	2298	2438	2922
24 / 610	60 / 1524	1772	1777	1919	2488	2492	2634	3203
24 / 610	66 / 1676	1882	1882	2022	2669	2672	2812	3459
24 / 610	72 / 1829	1985	2004	2145	2849	2871	3012	3716
24 / 610	78 / 1981	2091	2127	2269	3030	3065	3207	3968
24 / 610	84 / 2134	2198	2254	2398	3189	3246	3390	4181

SHARED (L / R)

SOURCE LAMINATE WORKSURFACE

SOURCE LAMINATE BACK

FLINTWOOD BACK

D	W	Source Laminate Front	Clear (CL) Front	Frosted (FT)/ Back-Painted Front	Flintwood Front	Clear (CL) Front	Frosted (FT)/ Back-Painted Front	Flintwood Front
20 / 508	60 / 1524	2096	2098	2241	2813	2813	2956	3528
20 / 508	66 / 1676	2235	2240	2378	3025	3030	3168	3815
20 / 508	72 / 1829	2373	2398	2536	3240	3265	3403	4107
20 / 508	78 / 1981	2511	2549	2690	3452	3487	3628	4390
20 / 508	84 / 2134	2652	2709	2847	3646	3701	3839	4638
24 / 610	60 / 1524	2209	2210	2354	2923	2925	3069	3638
24 / 610	66 / 1676	2356	2357	2496	3145	3147	3286	3935
24 / 610	72 / 1829	2500	2524	2663	3365	3391	3530	4232
24 / 610	78 / 1981	2646	2683	2825	3586	3621	3763	4524
24 / 610	84 / 2134	2796	2848	2989	3784	3840	3981	4776

Pricing is continued on the following page.

R S C S S

Freestanding Credenza – Sliding Doors (Continued)

DIMENSIONS
INCHES / MM

PRICING

		29" (HIGH)						
		SINGLE-SIDED (S)						
		FOUNDATION LAMINATE WORKSURFACE						
		SOURCE LAMINATE BACK				FLINTWOOD BACK		
D	W	Source Laminate Front	Clear (CL) Front	Frosted (FT)/ Back-Painted Front	Flintwood Front	Clear (CL) Front	Frosted (FT)/ Back-Painted Front	Flintwood Front
20 / 508	36 / 914	1313	1368	1507	1750	1800	1939	2182
20 / 508	42 / 1067	1448	1487	1629	1944	1982	2124	2439
20 / 508	48 / 1219	1580	1608	1750	2152	2180	2322	2724
20 / 508	54 / 1372	1713	1725	1865	2354	2363	2503	2992
20 / 508	60 / 1524	1846	1847	1987	2557	2562	2702	3272
20 / 508	66 / 1676	1957	1962	2102	2748	2752	2892	3538
20 / 508	72 / 1829	2068	2090	2231	2937	2957	3098	3804
20 / 508	78 / 1981	2181	2219	2359	3122	3157	3297	4060
20 / 508	84 / 2134	2293	2349	2491	3285	3341	3483	4277
24 / 610	36 / 914	1420	1469	1608	1851	1901	2040	2283
24 / 610	42 / 1067	1564	1601	1740	2059	2096	2235	2554
24 / 610	48 / 1219	1706	1734	1876	2275	2306	2448	2847
24 / 610	54 / 1372	1849	1862	2004	2489	2500	2642	3127
24 / 610	60 / 1524	1989	1996	2136	2704	2711	2851	3419
24 / 610	66 / 1676	2116	2117	2256	2902	2907	3046	3692
24 / 610	72 / 1829	2236	2256	2400	3103	3123	3267	3970
24 / 610	78 / 1981	2358	2399	2537	3298	3337	3475	4236
24 / 610	84 / 2134	2484	2538	2676	3472	3530	3668	4464

		FLINTWOOD WORKSURFACE						
		SOURCE LAMINATE BACK				FLINTWOOD BACK		
D	W	Source Laminate Front	Clear (CL) Front	Frosted (FT)/ Back-Painted Front	Flintwood Front	Clear (CL) Front	Frosted (FT)/ Back-Painted Front	Flintwood Front
20 / 508	36 / 914	1668	1723	1862	2105	2155	2294	2537
20 / 508	42 / 1067	1871	1910	2052	2367	2405	2547	2862
20 / 508	48 / 1219	2071	2099	2241	2643	2671	2813	3215
20 / 508	54 / 1372	2265	2277	2417	2906	2915	3055	3544
20 / 508	60 / 1524	2456	2457	2597	3167	3172	3312	3882
20 / 508	66 / 1676	2629	2634	2774	3420	3424	3564	4210
20 / 508	72 / 1829	2781	2803	2944	3650	3670	3811	4517
20 / 508	78 / 1981	2932	2970	3110	3873	3908	4048	4811
20 / 508	84 / 2134	3099	3155	3297	4091	4147	4289	5083
24 / 610	36 / 914	1834	1883	2022	2265	2315	2454	2697
24 / 610	42 / 1067	2045	2082	2221	2540	2577	2716	3035
24 / 610	48 / 1219	2258	2286	2428	2827	2858	3000	3399
24 / 610	54 / 1372	2477	2490	2632	3117	3128	3270	3755
24 / 610	60 / 1524	2682	2689	2829	3397	3404	3544	4112
24 / 610	66 / 1676	2879	2880	3019	3665	3670	3809	4455
24 / 610	72 / 1829	3069	3089	3233	3936	3956	4100	4803
24 / 610	78 / 1981	3256	3297	3435	4196	4235	4373	5134
24 / 610	84 / 2134	3450	3504	3642	4438	4496	4634	5430

Pricing is continued on the following page.

R S C S S
Freestanding Credenza –
Sliding Doors (Continued)

DIMENSIONS
INCHES / MM

PRICING

29" (HIGH) (CONTINUED)

SHARED (L / R)

FOUNDATION LAMINATE WORKSURFACE

SOURCE LAMINATE BACK

FLINTWOOD BACK

D	W	Source Laminate Front	Clear (CL) Front	Frosted (FT)/ Back-Painted Front	Flintwood Front	Clear (CL) Front	Frosted (FT)/ Back-Painted Front	Flintwood Front
20 / 508	60 / 1524	2283	2286	2426	2997	3001	3141	3712
20 / 508	66 / 1676	2437	2438	2578	3222	3228	3368	4012
20 / 508	72 / 1829	2586	2605	2747	3450	3472	3614	4317
20 / 508	78 / 1981	2738	2775	2914	3676	3713	3852	4614
20 / 508	84 / 2134	2892	2944	3086	3880	3936	4078	4872
24 / 610	60 / 1524	2427	2428	2572	3140	3143	3287	3855
24 / 610	66 / 1676	2589	2590	2731	3378	3380	3521	4168
24 / 610	72 / 1829	2754	2774	2913	3617	3641	3780	4484
24 / 610	78 / 1981	2913	2952	3093	3855	3890	4031	4793
24 / 610	84 / 2134	3076	3133	3272	4068	4125	4264	5060

FLINTWOOD WORKSURFACE

SOURCE LAMINATE BACK

FLINTWOOD BACK

D	W	Source Laminate Front	Clear (CL) Front	Frosted (FT)/ Back-Painted Front	Flintwood Front	Clear (CL) Front	Frosted (FT)/ Back-Painted Front	Flintwood Front
20 / 508	60 / 1524	2893	2896	3036	3607	3611	3751	4322
20 / 508	66 / 1676	3109	3110	3250	3894	3900	4040	4684
20 / 508	72 / 1829	3299	3318	3460	4163	4185	4327	5030
20 / 508	78 / 1981	3489	3526	3665	4427	4464	4603	5365
20 / 508	84 / 2134	3698	3750	3892	4686	4742	4884	5678
24 / 610	60 / 1524	3120	3121	3265	3833	3836	3980	4548
24 / 610	66 / 1676	3352	3353	3494	4141	4143	4284	4931
24 / 610	72 / 1829	3587	3607	3746	4450	4474	4613	5317
24 / 610	78 / 1981	3811	3850	3991	4753	4788	4929	5691
24 / 610	84 / 2134	4042	4099	4238	5034	5091	5230	6026

credenzas

Xpress

RSCOS

Freestanding Credenza – Open with Sliding Doors

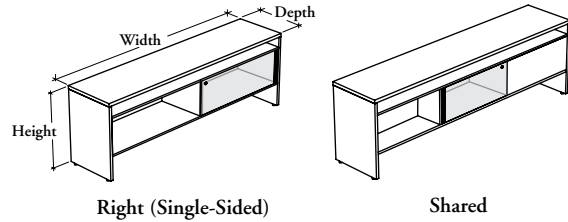

This freestanding credenza provides a closed convenient storage space, open binder storage and pigeonhole on one or both sides. It can also support the worksurfaces.

WHAT'S INCLUDED

1 credenza with gables and levelers, 1 or 2 open compartments, 1 or 2 sliding doors, 1 sliding door pull per sliding door (as specified), grommets or cable pass-through ring (as specified), mounting hardware, locks and keys.

WHAT'S EXCLUDED

Cable Pass-Through Cover (if applicable).

NOTES

Grommets are finished to match the gables and Cable Pass-Through ring comes in a Platinum Coordinate.

With Cable Pass-Through option is only available on the 29" high (H), Single-Sided (L or R) and 24" deep configuration. See application guide for details

Worksurface Finish Source Laminate is only available with 23" (low) credenza. In this case, Worksurface Edge Trim Style and Finish are **not** available.

Frosted (FT) is a single-sided etched tempered glass which is facing inward of credenza.

Xpress

Not all configurations are available as Xpress, Please see Xpress catalogue and/or specification software for details.

PRODUCT OPTIONS

Height	Configuration	Depth	Width	Worksurface Finish	Edge Trim Style	Edge Trim Finish	Case and Gable Finish
L 23" (low)	D Shared	20, 24	60, 66, 72, 78, 84	Source Laminate	6 Straight Trim	Edge Trim Colors (for trim style 6)	Source Laminate
H 29" (high) (Shown)	L Left (Single-Sided) R Right (Single-Sided)			Foundation Laminate Flintwood	9 Flintwood Flat Trim		

SAMPLE ORDER CODE

RSCOS L	R	20	66	XS			3D
----------------	----------	-----------	-----------	-----------	--	--	-----------

PRODUCT OPTIONS CONTINUED

Back Finish	Sliding Rail Finish	Door Style	Door Finish	Edge Trim Finish	Pull Finish	Cable Pass-Through/Grommet	Key Style
Source Laminate Flintwood	Foundation Mica	F Flintwood G Glass L Laminate	Source Laminate Flintwood Standard Glass: CL Clear FT Frosted Back-Painted Glass	Edge Trim Colors (for laminate sliding doors)	Foundation Mica	G With Grommet N No Grommet/No Cable Pass-Through P With Cable Pass-Through	K Keyed Alike R Keyed Randomly N No Lock

SAMPLE ORDER CODE CONTINUED

3D	7	L	3D	4D	7	N	N
-----------	----------	----------	-----------	-----------	----------	----------	----------

See Pricing on the following page.

R S C O S

Freestanding Credenza – Open with Sliding Doors (Continued)

DIMENSIONS
INCHES / MM

PRICING

23" (LOW)
SINGLE-SIDED (L / R)
SOURCE LAMINATE WORKSURFACE

		SOURCE LAMINATE BACK			FLINTWOOD BACK			
D	W	Source Laminate Front	Clear (CL) Front	Frosted (FT)/ Back-Painted Front	Flintwood Front	Clear (CL) Front	Frosted (FT) Back-Painted Front	Flintwood Front
20 / 508	60 / 1524	1496	1496	1565	2567	2211	2992	2992
20 / 508	66 / 1676	1587	1587	1656	2771	2377	3174	3174
20 / 508	72 / 1829	1680	1689	1759	2978	2556	3369	3378
20 / 508	78 / 1981	1772	1788	1858	3181	2726	3560	3576
20 / 508	84 / 2134	1861	1892	1964	3351	2884	3753	3784
24 / 610	60 / 1524	1605	1607	1679	2676	2322	3212	3214
24 / 610	66 / 1676	1708	1708	1777	2892	2498	3416	3416
24 / 610	72 / 1829	1805	1817	1886	3104	2684	3622	3634
24 / 610	78 / 1981	1906	1926	1998	3314	2864	3832	3852
24 / 610	84 / 2134	2006	2035	2105	3492	3027	4041	4070

SHARED (D)
SOURCE LAMINATE WORKSURFACE

		SOURCE LAMINATE BACK			FLINTWOOD BACK			
D	W	Source Laminate Front	Clear (CL) Front	Frosted (FT)/ Back-Painted Front	Flintwood Front	Clear (CL) Front	Frosted (FT)/ Back-Painted Front	Flintwood Front
20 / 508	60 / 1524	2057	2062	2155	2770	2422	4119	4124
20 / 508	66 / 1676	2196	2202	2294	2984	2634	4398	4404
20 / 508	72 / 1829	2330	2357	2450	3196	2852	4687	4714
20 / 508	78 / 1981	2470	2496	2605	3409	3068	4966	4992
20 / 508	84 / 2134	2612	2639	2763	3604	3277	5251	5278
24 / 610	60 / 1524	2169	2174	2267	2883	2534	4343	4348
24 / 610	66 / 1676	2315	2320	2413	3103	2752	4635	4640
24 / 610	72 / 1829	2459	2487	2579	3325	2982	4946	4974
24 / 610	78 / 1981	2604	2630	2740	3543	3202	5234	5260
24 / 610	84 / 2134	2753	2781	2903	3742	3419	5534	5562

29" (HIGH)
SINGLE-SIDED (L / R)
FOUNDATION LAMINATE WORKSURFACE

		SOURCE LAMINATE BACK			FLINTWOOD BACK			
D	W	Source Laminate Front	Clear (CL) Front	Frosted (FT)/ Back-Painted Front	Flintwood Front	Clear (CL) Front	Frosted (FT)/ Back-Painted Front	Flintwood Front
20 / 508	60 / 1524	1680	1682	1752	2749	2397	2467	3464
20 / 508	66 / 1676	1784	1784	1856	2970	2574	2646	3760
20 / 508	72 / 1829	1890	1902	1971	3189	2769	2838	4056
20 / 508	78 / 1981	1999	2015	2085	3406	2953	3023	4344
20 / 508	84 / 2134	2102	2130	2201	3587	3122	3193	4579
24 / 610	60 / 1524	1825	1827	1897	2897	2542	2612	3612
24 / 610	66 / 1676	1943	1945	2011	3126	2735	2801	3916
24 / 610	72 / 1829	2058	2068	2138	3357	2935	3005	4224
24 / 610	78 / 1981	2174	2196	2263	3581	3134	3201	4519
24 / 610	84 / 2134	2291	2321	2387	3778	3313	3379	4770

Pricing is continued on the following page.

RSCOS

Freestanding Credenza – Open with Sliding Doors (Continued)

DIMENSIONS
INCHES / MM

PRICING

29" (HIGH) (CONTINUED)

SINGLE-SIDED (L / R) (CONTINUED)

FLINTWOOD WORKSURFACE

SOURCE LAMINATE BACK

FLINTWOOD BACK

		Source Laminate Front	Clear (CL) Front	Frosted (FT) Back-Painted Front	Flintwood Front	Clear (CL) Front	Frosted (FT)/ Back-Painted Front	Flintwood Front
20 / 508	60 / 1524	2290	2292	2362	3359	3007	3077	4074
20 / 508	66 / 1676	2456	2456	2528	3642	3246	3318	4432
20 / 508	72 / 1829	2603	2615	2684	3902	3482	3551	4769
20 / 508	78 / 1981	2750	2766	2836	4157	3704	3774	5095
20 / 508	84 / 2134	2908	2936	3007	4393	3928	3999	5385
24 / 610	60 / 1524	2518	2520	2590	3590	3235	3305	4305
24 / 610	66 / 1676	2706	2708	2774	3889	3498	3564	4679
24 / 610	72 / 1829	2891	2901	2971	4190	3768	3838	5057

SHARED (D)

FOUNDATION LAMINATE WORKSURFACE

SOURCE LAMINATE BACK

FLINTWOOD BACK

D	W	Source Laminate Front	Clear (CL) Front	Frosted (FT)/ Back-Painted Front	Flintwood Front	Clear (CL) Front	Frosted (FT)/ Back-Painted Front	Flintwood Front
20 / 508	60 / 1524	2241	2247	2343	2953	2607	2703	3313
20 / 508	66 / 1676	2397	2401	2493	3182	2833	2925	3614
20 / 508	72 / 1829	2544	2571	2663	3408	3066	3158	3903
20 / 508	78 / 1981	2696	2721	2829	3634	3293	3401	4206
20 / 508	84 / 2134	2848	2877	3001	3837	3515	3639	4475
24 / 610	60 / 1524	2384	2397	2488	3098	2757	2848	3458
24 / 610	66 / 1676	2547	2552	2647	3335	2984	3079	3767
24 / 610	72 / 1829	2712	2734	2828	3575	3229	3323	4070
24 / 610	78 / 1981	2871	2899	3009	3813	3471	3581	4385
24 / 610	84 / 2134	3035	3066	3190	4026	3704	3828	4664

FLINTWOOD WORKSURFACE

SOURCE LAMINATE BACK

FLINTWOOD BACK

		Source Laminate Front	Clear (CL) Front	Frosted (FT)/ Back-Painted Front	Flintwood Front	Clear (CL) Front	Frosted (FT)/ Back-Painted Front	Flintwood Front
20 / 508	60 / 1524	2851	2857	2953	3563	3217	3313	3923
20 / 508	66 / 1676	3069	3073	3165	3854	3505	3597	4286
20 / 508	72 / 1829	3257	3284	3376	4121	3779	3871	4616
20 / 508	78 / 1981	3447	3472	3580	4385	4044	4152	4957
20 / 508	84 / 2134	3654	3683	3807	4643	4321	4445	5281
24 / 610	60 / 1524	3077	3090	3181	3791	3450	3541	4151
24 / 610	66 / 1676	3310	3315	3410	4098	3747	3842	4530
24 / 610	72 / 1829	3545	3567	3661	4408	4062	4156	4903
24 / 610	78 / 1981	3769	3797	3907	4711	4369	4479	5283
24 / 610	84 / 2134	4001	4032	4156	4992	4670	4794	5630

credenzas

Xpress

R S M D

Worksurface Drawer Support – Low Credenza

This product provides storage and is mounted between a 23" high (low) Freestanding Credenza and a worksurface, to support the worksurface.

WHAT'S INCLUDED

1 worksurface drawer support, 1 pencil tray, 1 pull, attachment hardware, lock and keys.

WHAT'S EXCLUDED

Credenza.

NOTES

Specify the depth according to the worksurface installed above.

Soft Touch (2) and Standard T/O/S (4) pulls are only available in limited Foundation colors. Refer to the specification software for details.

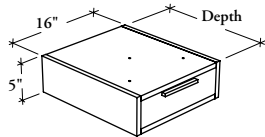

PRODUCT OPTIONS

Height	Depth	Width	Case Finish	Drawer Front and Back Finish	Edge Trim Finish	Pull Style	Pull Finish	Key Style
05	18 20" or 24" deep Worksurface	16	Source Laminate	Source Laminate Flintwood	Edge Trim Colors (for laminate drawer front)	1 Standard Expansion 2 Soft Touch 4 Standard T/O/S 6 Arched 7 Elliptical 9 Rectilinear	Foundation Accent Mica	K Keyed Alike R Keyed Randomly N No Lock
	24 30" deep Worksurface							

SAMPLE ORDER CODE

RSMD 05	24	16	LE	LE	ST	9	E	N
----------------	-----------	-----------	-----------	-----------	-----------	----------	----------	----------

**DIMENSIONS
INCHES / MM**

H	D	W
5 / 127	18 / 457	16 / 406
5 / 127	24 / 610	16 / 406

PRICING

Source Laminate	Flintwood
416	661
457	724

The Seat Cushion is removeable and is intended to provide casual guest seating when applied on a 23" high (low) Freestanding Credenza.

WHAT'S INCLUDED

1 seat cushion and hardware.

NOTES

RSSC20: Yardage requirement for com or col is 0.8 yards for two cushions.

RSSC24: Yardage requirement for com or col is 1 yards for two cushions.

**RSSC
Seat Cushion**

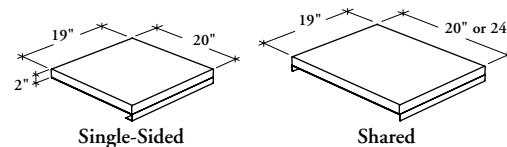

PRODUCT OPTIONS

Configuration	Depth	Width	Seat Upholstery Finish	Hardware Finish
S Single-Sided	20, 24	19	Fabric Leather	Foundation Accent Mica
D Shared				

SAMPLE ORDER CODE

RSSC S	20	19	L101	E
---------------	-----------	-----------	-------------	----------

**DIMENSIONS
INCHES / MM**

D	W
20 / 508	19 / 483

PRICING

SINGLE-SIDED (S)

Gr. 1	COM/ Gr. 2	COL/ Gr. 3	Gr. 4	Gr. 5	Gr. 6	Gr. 7	Gr. 8	Gr. 9	Gr. 10	Leather/ Gr. LA	Gr. LB	Gr. LC	Gr. LD
332	376	396	418	429	442	465	490	513	535	535	574	695	731

SHARED (D)

Gr. 1	COM/ Gr. 2	COL/ Gr. 3	Gr. 4	Gr. 5	Gr. 6	Gr. 7	Gr. 8	Gr. 9	Gr. 10	Leather/ Gr. LA	Gr. LB	Gr. LC	Gr. LD		
20 / 508	19 / 483	364	412	430	457	469	481	509	534	554	585	585	622	744	777
24 / 610	19 / 483	404	459	477	509	520	536	565	592	618	648	648	747	896	941

freestanding storage &
accessories

freestanding storage & accessories product map

R B H A T Supporting Tower with Lateral Access and Drawers

Page 450

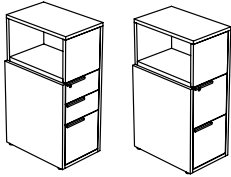

R B H S C Supporting Tower with Full Door

Page 451

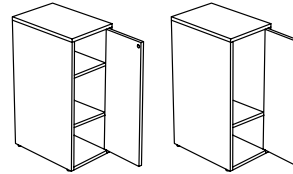

R B X T Extended Supporting Tower with Drawers

Page 452

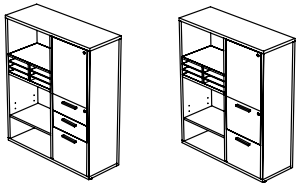

R B X T C Extended Supporting Tower with Full Door

Page 453

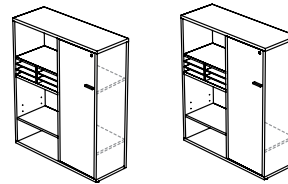

R B N S P Metal Pedestal

Page 454

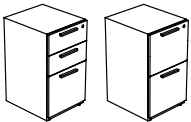

R B S P Pedestal

Page 455

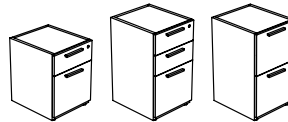

R B T P S Mobile Pedestal with Seat

Page 456



R B S S Suspended Pedestal

Page 457

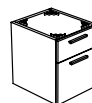

freestanding storage & accessories product map

R B A T Tower with Lateral Access and Drawers

Page 458

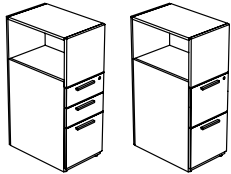

R B A T W Tower with Lateral Access, Drawers and Wardrobe

Page 459

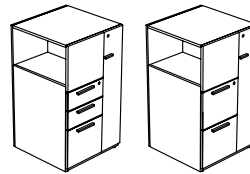

R B N C P Metal Combo Pedestal

Page 460



R B C P Combo Pedestal

Page 461

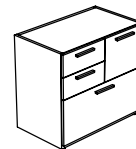

R B N L F Metal Lateral File

Page 462



R B L F Lateral File

Page 462



R B C D Storage Cabinet

Page 464

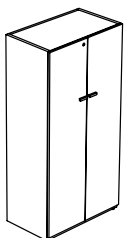

R B S D Storage Cabinet with Drawer(s)

Page 466

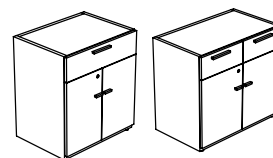

freestanding storage & accessories product map

R B S U B Underworksurface Bookcase

Page 467

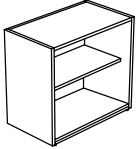

R B S F Half Wardrobe Filing Cabinet

Page 468



R B S C O Half Wardrobe Unit with Drawers – Open Shelves

Page 469

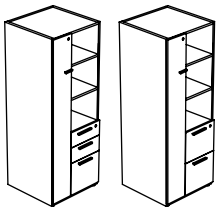

R B S C L Half Wardrobe Unit with Drawers – Solid Doors

Page 470

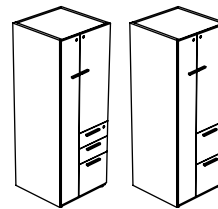

R B C G Half Wardrobe Unit with Drawers – Glass Door

Page 472

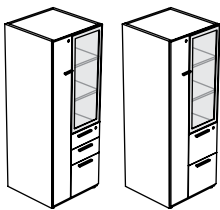

R B S U Storage Unit

Page 474

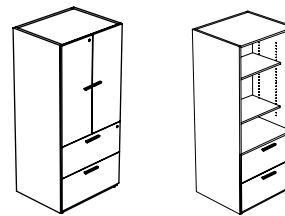

R B U S G Storage Unit – Glass Doors

Page 475

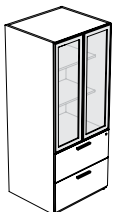

R B U W Storage Unit with Wardrobe – Solid Doors

Page 476

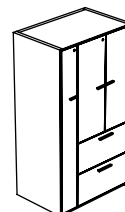

freestanding storage & accessories product map

R B S W Wardrobe Cabinet – Solid Doors

Page 477

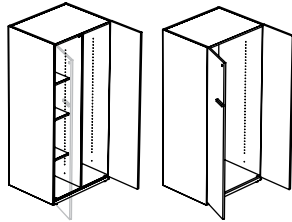

R B O B Bookcase

Page 478

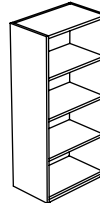

R A C M F Glass Markerboard – Freestanding Storage Mounted

Page 480

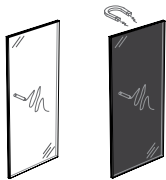

R B X S K Supported Pedestal Kit

Page 482

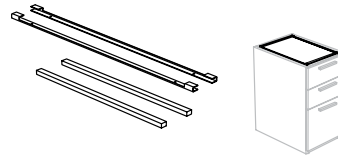

R B X H K Hang-On Kit

Page 483

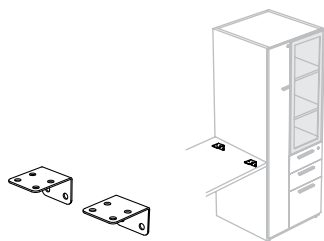

R S N R T Top for Metal Storage Cabinet

Page 484

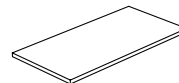

R S R T Top for Solid Storage Cabinet

Page 485



R S H E Shelf for Storage Cabinet

Page 486

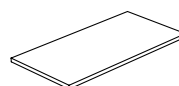

freestanding storage & accessories product map

R B G F Gap Filler for Pedestals

Page 487

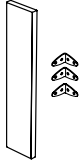

R S L B Hanging File Bar

Page 488

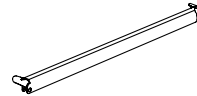

R B N S A Metal Storage Accessories

Page 489

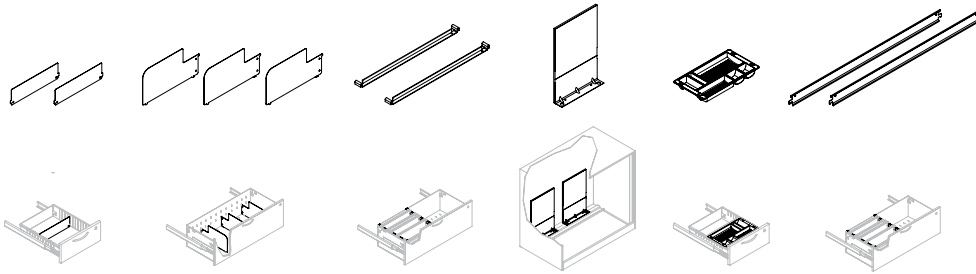

K Locks and Keys

Page 490

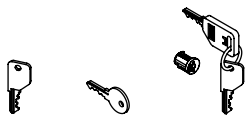

S O K L Set of Keys Alike

Page 491

freestanding storage & accessories

Xpress

RBHAT

Supporting Tower with Lateral Access and Drawers

This product provides different storage possibilities, while supporting the worksurface, for an integrated and refined look.

WHAT'S INCLUDED

1 tower, 1 cable pass-through ring (as specified), pulls, levelers, lock and keys, mounting hardware, and accessories as listed below:

	Heights			Drawer Configurations	
	42"	51"	66"	B	F
Compartment (Lateral Access)	1	1	2	1	n/a
Metal Shelves Section	n/a	1	1	1	n/a
				12" Hanging File Bar	1
					2

WHAT'S EXCLUDED

Cable Pass-Through Cover (if applicable).

NOTES

Specify the depth according to the worksurface on which the tower is installed.

When used with odd worksurface widths, total footprint will respect 6" increments.

Included hanging file bars are to be installed along the width only.

A4 binder does **not** fit, because upper shelf is fixed.

Soft Touch (2) and Standard T/O/S (4) pulls are only available in limited Foundation colors. Refer to the specification software for details.

With Cable Pass-Through option is **not** available on 20" deep configuration.

Cable Pass-Through ring comes in a Platinum Coordinate.

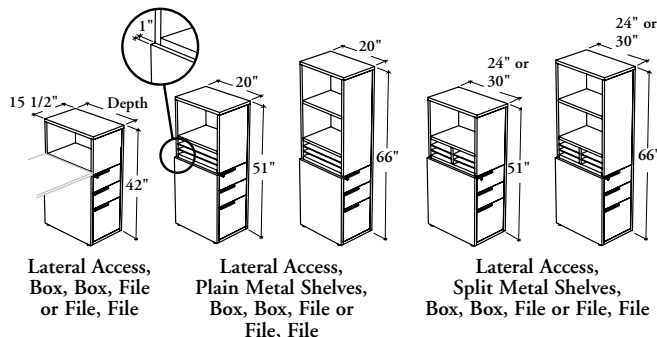

PRODUCT OPTIONS

Depth	Height	Drawer Configuration	Configuration	Drawer Front, Front Panel and Back Panel Finish	Edge Trim Finish (Drawer Front only)	Case Finish	Pull Style	Metal Shelf and Pull Finish	Key Style	Cable Pass-Through
20, 24, 30	42, 51, 66	B Box, Box, File (Shown) F File, File	L Left R Right (Shown)	Source Laminate Flintwood	Edge Trim Colors	Source Laminate	1 Standard Expansion 2 Soft Touch 4 Standard T/O/S 6 Arched 7 Elliptical 9 Rectilinear	Foundation Accent Mica	K Keyed Alike R Keyed Randomly N No Lock	N No Cable Pass-Through P With Cable Pass-Through

SAMPLE ORDER CODE

RBHAT 24	51	F	R	LW	ST	XS	9	P	K	N
-----------------	-----------	----------	----------	-----------	-----------	-----------	----------	----------	----------	----------

DIMENSIONS INCHES / MM

D	H
20 / 508	42 / 1067
20 / 508	51 / 1295
20 / 508	66 / 1676
24 / 610	42 / 1067
24 / 610	51 / 1295
24 / 610	66 / 1676
30 / 762	42 / 1067
30 / 762	51 / 1295
30 / 762	66 / 1676

PRICING

FILE, FILE (F)

Source Laminate	Flintwood
1286	1813
1614	2286
1862	2749
1356	1897
1739	2419
2008	2901
1481	2074
1945	2724
2254	3140

BOX, BOX, FILE (B)

Source Laminate	Flintwood
1334	1864
1662	2335
1912	2801
1411	1943
1792	2465
2058	2948
1522	2130
1985	2779
2293	3183

These products provide side storage capacity while supporting the worksurface, for an integrated and refined look.

RBHSC

Supporting Tower with Full Door

WHAT'S INCLUDED

Shelves tower style: 1 tower, pulls, levelers, lock and keys, mounting hardware, and shelves as listed below:

	Heights		
	42"	51"	66"
Fixed Shelf	1	1	1
Adjustable Shelf	n/a	2	2

Wardrobe tower style: 1 tower, 1 coat rod, 1 adjustable shelf, pulls, levelers, mounting hardware, lock and keys.

NOTES

- Specify the depth according to the worksurface on which the tower is installed.
- When used with odd worksurface widths, total footprint will respect 6" increments.
- Holes at 1 1/4" intervals on the inside walls of side panels allow for shelf adjustment.
- Soft Touch (2) and Standard T/O/S (4) pulls are only available in limited Foundation colors. Refer to the specification software for details.

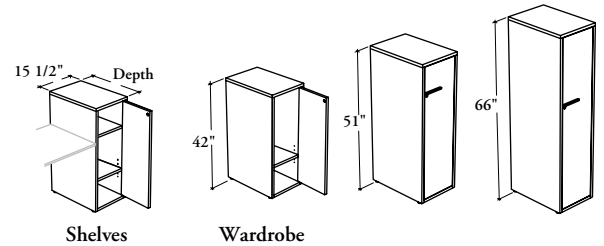

PRODUCT OPTIONS

Tower Style	Depth	Height	Configuration	Door and Back Panel Finish	Edge Trim Finish (Door only)	Case Finish	Pull Style	Pull Finish	Key Style
S Shelves	20, 24, 30	42, 51, 66	L Left	Source Laminate	Edge Trim Colors	Source Laminate	1 Standard Expansion	Foundation	K Keyed Alike
W Wardrobe			R Right (Shown)	Flintwood			2 Soft Touch 4 Standard T/O/S 6 Arched 7 Elliptical 9 Rectilinear	Accent Mica	R Keyed Randomly N No Lock

SAMPLE ORDER CODE

RBHSC W	24	51	R	2E	4E	2E	9	7	K
----------------	-----------	-----------	----------	-----------	-----------	-----------	----------	----------	----------

**DIMENSIONS
INCHES / MM**

D	H
20 / 508	42 / 1067
20 / 508	51 / 1295
20 / 508	66 / 1676
24 / 610	42 / 1067
24 / 610	51 / 1295
24 / 610	66 / 1676
30 / 762	42 / 1067
30 / 762	51 / 1295
30 / 762	66 / 1676

PRICING

SHELVES TOWER STYLE (S)	
Source Laminate	Flintwood
1038	1731
1252	2112
1478	2589
1158	1847
1370	2233
1601	2714
1324	2011
1535	2398
1825	2938

WARDROBE TOWER STYLE (W)	
Source Laminate	Flintwood
986	1679
1144	2004
1349	2463
1105	1796
1260	2124
1473	2586
1267	1960
1426	2286
1695	2807

freestanding storage & accessories

Xpress

RBXT

Extended Supporting Tower with Drawers

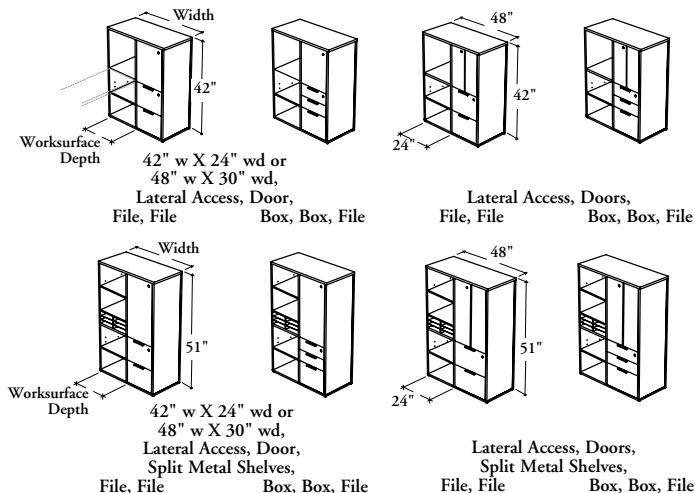

The Extended Supporting Tower with Drawers provides storage and drawers with the capability to support a Rectangular Worksurface.

WHAT'S INCLUDED

1 tower, 1 pencil drawer (as specified), 1 cable pass-through ring (as specified), pulls, levelers, lock and keys, mounting hardware, and accessories as listed below:

	Heights	
	42"	51"

Compartment (Lateral Access)	3	3
Metal Shelves Section	n/a	1
12" Hanging File Bar	1	1 (per file drawer)
Adj. Shelves	1	2

NOTES

Specify the worksurface depth according to the worksurface on which the tower is installed.

When used with odd worksurface widths, total footprint will respect 6" increments.

Left or right configuration is determined by the closed storage section.

Included hanging file bars are to be installed along the depth only.

Soft Touch (2) and Standard T/O/S (4) pulls are only available in limited Foundation colors. Refer to the specification software for details.

Cable Pass-Through ring comes in a Platinum Coordinate.

PRODUCT OPTIONS

Drawer Configuration	Depth	Worksurface Depth	Door, Divider and Side Finish	Case Finish	Pull Style	Metal Shelf and Pull Finish	Key Style	Cable Pass-Through
B Box/Box/File	15	24, 30	Source Laminate Flintwood	Source Laminate	1 Standard Expansion	Foundation Accent Mica	K Keyed Alike	P With Pass-Through
L Lateral File (Shown)	42, 48	Configuration			2 Soft Touch		R Keyed Randomly	N No Pass-Through
	42, 51	L Left R Right (Shown)			4 Standard T/O/S		N No Lock	
					6 Arched			
					7 Elliptical			
					9 Rectilinear			

SAMPLE ORDER CODE

RBXT B	15	48	51	24	L	3E	3E	9	7	K	P
---------------	-----------	-----------	-----------	-----------	----------	-----------	-----------	----------	----------	----------	----------

DIMENSIONS INCHES / MM

D	W	H
15 / 381	42 / 1067	42 / 1067
15 / 381	42 / 1067	51 / 1295
15 / 381	48 / 1219	42 / 1067
15 / 381	48 / 1219	51 / 1295

PRICING

LATERAL FILE (L)

24" WORKSURFACE DEPTH

Source Laminate	Flintwood
2066	3217
2407	3662
2350	3550
2709	4039

30" WORKSURFACE DEPTH

Source Laminate	Flintwood
n/a	n/a
n/a	n/a
2254	3406
2662	3916

BOX/BOX/FILE (B)

24" WORKSURFACE DEPTH

Source Laminate	Flintwood
2145	3297
2487	3741
n/a	n/a
n/a	n/a

30" WORKSURFACE DEPTH

Source Laminate	Flintwood
n/a	n/a
n/a	n/a
2329	3485
2739	3997

The Extended Supporting Tower with Full Door provides storage and wardrobe with the capability to support a Rectangular Worksurface.

RBXTC

Extended Supporting Tower with Full Door

WHAT'S INCLUDED

1 tower, 1 cable pass-through ring (as specified), 4 metal shelves (51" high only), pulls, levelers, lock and keys, mounting hardware, and accessories as listed below:

Shelves (S)	Wardrobe (W)
42" or 51" height	

Compartment (Lateral Access)	3	3
Adjustable Shelf (inside door section)	2	1
Adjustable Shelf (Lateral Access)	1	1
Coat Hook	n/a	1

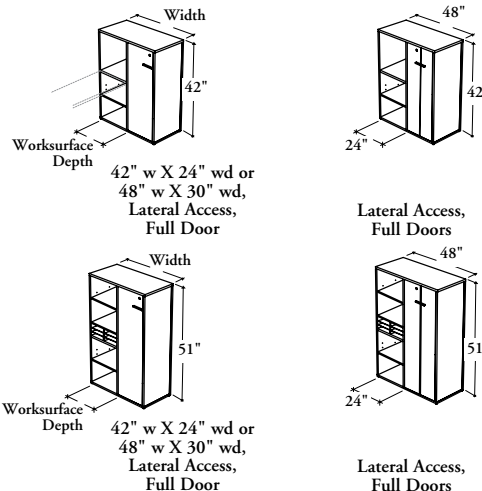
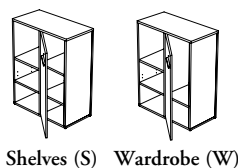

NOTES

Specify the worksurface depth according to the worksurface on which the tower is installed.

When used with odd worksurface widths, total footprint will respect 6" increments.

Left or right configuration is determined by the closed storage section.

Soft Touch (2) and Standard T/O/S (4) pulls are only available in limited Foundation colors. Refer to the specification software for details.

Cable Pass-Through ring comes in a Platinum Coordinate.

PRODUCT OPTIONS

Style	Depth	Height	Configuration	Door, Divider and Side Finish	Case Finish	Pull Style	Metal Shelf and Pull Finish	Key Style	Cable Pass-Through
S Shelves	15	42, 51	L Left	Source Laminate	Source Laminate	1 Standard Expansion	Foundation	K Keyed Alike	N No Cable Pass-Through
W Wardrobe	Width	Work-surface Depth	R Right (Shown)	Flintwood		2 Soft Touch	Accent	R Keyed Randomly	P With Cable Pass-Through
	36, 42, 48	24, 30				4 Standard T/O/S	Mica	N No Key	
						6 Arched			
						7 Elliptical			
						9 Rectilinear			

SAMPLE ORDER CODE

RBXTC											
S	15	36	42	24	L	XS	XS	1	7	N	P

DIMENSIONS

INCHES / MM

D	W	H
15 / 381	36 / 914	42 / 1067
15 / 381	36 / 914	51 / 1295
15 / 381	42 / 1067	42 / 1067
15 / 381	42 / 1067	51 / 1295
15 / 381	48 / 1219	42 / 1067
15 / 381	48 / 1219	51 / 1295

PRICING

WARDROBE STYLE (W)			
24" WORKSURFACE DEPTH		30" WORKSURFACE DEPTH	
Source Laminate	Flintwood	Source Laminate	Flintwood
1776	2695	n/a	n/a
2172	3175	n/a	n/a
1923	2890	1890	2808
2332	3405	2335	3343
2199	3239	2039	3007
2656	3809	2525	3591

SHELVES STYLE (S)			
24" WORKSURFACE DEPTH		30" WORKSURFACE DEPTH	
Source Laminate	Flintwood	Source Laminate	Flintwood
1788	2705	n/a	n/a
2230	3234	n/a	n/a
1960	2926	1904	2820
2443	3511	2399	3402
2259	3298	2076	3042
2808	3965	2629	3699

freestanding storage & accessories

Xpress

R B N S P

Metal Pedestal

This storage with metal casing is lockable and has a variety of drawer depths and configurations that provides storage below the worksurface. Refer to the Freestanding Storage Compatibility in the Application Guide.

WHAT'S INCLUDED

Stationary style (S): 1 pedestal, pulls, levelers with 1" adjustment, counterweight (if specified), lock and keys, and accessories listed below.

Mobile style (M): 1 pedestal, pulls, casters, counterweight, lock and keys, and accessories listed below:

Drawer Configurations	
6612	1212

Pencil Tray	1	n/a
Drawer Divider	1	n/a
12" Hanging File Bar	1	2

WHAT'S EXCLUDED

Top for Metal Storage Cabinet and Metal Storage Accessories.

NOTES

This pedestal has a central locking system and full-extension drawers that can accommodate both letter- and legal-size paper.

Coordinate colors for case are solid colors that can be used to match wood prints such as those of drawer fronts.

Counterweight must be specified for all stationary pedestals **not** under a worksurface.

Included hanging file bars are to be installed along the width only.

Drawer datum line will **not** match with any laminate storage when positioned side-by-side.

When Metal Storage are positioned side-by-side, ensure product is leveled. If front/door alignment is needed, it can be done by either releasing the front mounting screws, adjusting the front/door and tightening the screws, or by using hinge adjustments to ensure an equal gap.

The Coordinate Colors for case finish are available with Laminate Drawer Front Finishes only.

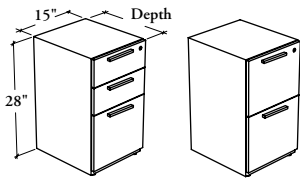

Box, Box File

File, File

PRODUCT OPTIONS

Xpress Drawer front finish is only available in limited finishes as Xpress. Please see Xpress catalogue and/or specification software for details.

Style	Depth	Height	Drawer Configuration	Drawer Front Finish	Edge Trim Finish (Laminate Front only)	Case Finish	Pull Style	Pull Finish	Key Style	Counterweight (Optional, for Stationary only)
M Mobile	18, 22	28	6612 Box, Box, File	Metal Front: • Foundation • Mica	Edge Trim Colors	Foundation Mica Coordinate Colors	1 Standard Expansion	Foundation Accent Mica	K Keyed Alike R Keyed Randomly	W Counterweight
S Stationary (Shown)			1212 File, File	Laminate Front: • Source Laminate • Foundation Laminate Flintwood Front: • Flintwood			6 Arched 7 Elliptical 9 Rectilinear			

SAMPLE ORDER CODE

RBNSP										
M	18	28	6612	2D	4D	E	1	E	R	

DIMENSIONS INCHES / MM

D	H
18 / 457	28 / 737
18 / 457	28 / 737
22 / 559	28 / 737
22 / 559	28 / 737

PRICING

STATIONARY (S)

CASE FINISH	DRAWER FRONT FINISH				
	Foundation	Mica	Source Laminate	Foundation Laminate	Flintwood
Foundation / Coordinate	548	565	639	681	1139
Mica	588	606	681	722	1180
Foundation / Coordinate	580	597	673	716	1169
Mica	622	638	716	756	1210

MOBILE (M)

CASE FINISH	DRAWER FRONT FINISH				
	Foundation	Mica	Source Laminate	Foundation Laminate	Flintwood
Foundation / Coordinate	706	722	773	815	1269
Mica	749	763	814	855	1311
Foundation / Coordinate	742	756	805	846	1303
Mica	783	796	846	889	1344

COUNTERWEIGHT

	67
	67
	67
	67

R B S P
Pedestal

This pedestal is a lockable storage unit with a variety of drawer depths and configurations that provides storage below the worksurface.

WHAT'S INCLUDED

1 pedestal, 1 cable pass-through ring (as specified), pulls, levelers (if stationary style specified) or casters (if mobile style specified), lock and keys, and accessories as listed below:

Drawer Configurations		
0612	6612	1212

Pencil Tray	1	1	n/a
Drawer Divider	1	1	n/a
12" Hanging File Bar	1	1	2

WHAT'S EXCLUDED

Top for Solid Storage Cabinet, Supported Pedestal Kit and Cable Pass-Through Cover (if applicable).

NOTES

Drawers for 30" deep pedestals are 20" deep.

Included hanging file bars are to be installed along the width only.

Soft Touch (2) and Standard T/O/S (4) pulls are only available in limited Foundation colors. Refer to the specification software for details.

With Cable Pass-Through option is available on stationary pedestals that are 24" or 30" deep and 28" high only.

Cable Pass-Through ring comes in a Platinum Coordinate.

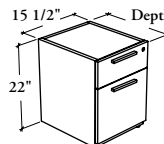

Box, File

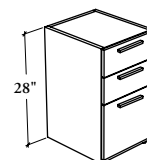

Box, Box, File

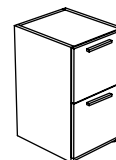

File, File

PRODUCT OPTIONS

Style	Depth	Height	Drawer Configuration	Drawer Front Finish	Edge Trim Finish	Case Finish	Pull Style	Pull Finish	Key Style	Cable Pass-Through
M Mobile	18, 20, 22, 24, 30	22, 28	0612 Box, File	Source Laminate	Edge Trim Colors	Source Laminate	1 Standard Expansion	Foundation Accent	K Keyed Alike	N No Cable Pass-Through
S Stationary (Shown)			6612 Box, Box, File 1212 File, File	Foundation Laminate Flintwood			2 Soft Touch 4 Standard T/O/S 6 Arched 7 Elliptical 9 Rectilinear	Mica	R Keyed Randomly	P With Cable Pass-Through

SAMPLE ORDER CODE

RBSP S	24	28	6612	LW	ST	LE	1	E	R	N
---------------	-----------	-----------	-------------	-----------	-----------	-----------	----------	----------	----------	----------

DIMENSIONS
INCHES / MM

D	H
18 / 457	22 / 559
22 / 559	22 / 559

18 / 457	28 / 737
20 / 508	28 / 737
22 / 559	28 / 737
24 / 610	28 / 737
30 / 762	28 / 737

PRICING

MOBILE (M)			STATIONARY (S)		
BOX, FILE (0612)					
Source Laminate	Foundation Laminate	Flintwood	Source Laminate	Foundation Laminate	Flintwood
683	756	1115	683	756	1115
718	791	1151	718	791	1151
FILE, FILE (1212)					
Source Laminate	Foundation Laminate	Flintwood	Source Laminate	Foundation Laminate	Flintwood
891	941	1416	891	941	1416
915	965	1453	915	965	1453
933	989	1482	933	989	1482
973	1027	1542	973	1027	1542
1095	1139	1713	1095	1139	1713
BOX, BOX, FILE (6612)					
Source Laminate	Foundation Laminate	Flintwood	Source Laminate	Foundation Laminate	Flintwood
934	981	1470	934	981	1470
962	1000	1502	962	1000	1502
989	1020	1529	989	1020	1529
1023	1060	1587	1023	1060	1587
1134	1169	1755	1134	1169	1755

freestanding storage & accessories

R B T P S

Mobile Pedestal with Seat

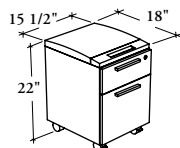

Box, File

The Mobile Pedestal with Seat is a small, personal storage unit providing temporary, casual seating within a workstation. It can be stored beneath any worksurface with a minimum height of 22".

WHAT'S INCLUDED

1 pedestal, pulls, casters, lock and keys, 1 pencil tray, 1 drawer divider and 1 12" hanging file bar.

NOTES

Included hanging file bars are to be installed along the width only.

Soft Touch (2) and Standard T/O/S (4) pulls are only available in limited Foundation colors. Refer to the specification software for details.

Yardage requirement for com or col is 0.7 yards for two cushions.

PRODUCT OPTIONS

Depth	Drawer Configuration	Seat Upholstery Finish	Drawer Front Finish	Edge Trim Finish	Case Finish	Pull Style	Pull Finish	Key Style
18	0612 Box, File	Fabrics Leather	Source Laminate Foundation Laminate Flintwood	Edge Trim Colors	Source Laminate	1 Standard Expansion 2 Soft Touch 4 Standard T/O/S 6 Arched 7 Elliptical 9 Rectilinear	Foundation Accent Mica	K Keyed Alike R Keyed Randomly

SAMPLE ORDER CODE

RBTPS 18	0612	L204	LW	ST	LE	4	E	R
----------	------	------	----	----	----	---	---	---

DIMENSIONS INCHES / MM

D	18 / 457
---	----------

18 / 457

18 / 457

PRICING

BOX, FILE (0612)

SOURCE LAMINATE DRAWER

Gr. 1	COM/ COL/		Gr. 4	Gr. 5	Gr. 6	Gr. 7	Gr. 8	Gr. 9	Gr. 10	Leather/			
	Gr. 2	Gr. 3								Gr. LA	Gr. LB	Gr. LC	Gr. LD
1231	1261	1353	1406	1470	1517	1568	1617	1632	1648	1648	1684	1805	1840

FOUNDATION LAMINATE DRAWER

1305	1335	1427	1480	1544	1591	1642	1691	1706	1722	1722	1758	1879	1914
------	------	------	------	------	------	------	------	------	------	------	------	------	------

FLINTWOOD DRAWER

1660	1690	1782	1835	1899	1946	1997	2046	2061	2077	2077	2113	2234	2269
------	------	------	------	------	------	------	------	------	------	------	------	------	------

This pedestal mounts under the worksurface to provide a suspended lockable storage unit.

WHAT'S INCLUDED

1 pedestal, 1 pencil tray, 1 drawer divider, 1 12" hanging file bar, pulls, lock and keys, and mounting hardware.

NOTES

Cannot be used in freestanding application.

Included hanging file bars are to be installed along the width only.

Soft Touch (2) and Standard T/O/S (4) pulls are only available in limited Foundation colors. Refer to the specification software for details.

RBSS
Suspended Pedestal

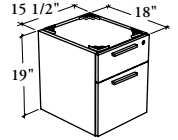

Box, File

PRODUCT OPTIONS

Depth	Drawer Configuration	Drawer Front Finish	Edge Trim Finish	Case Finish	Pull Style	Pull Finish	Key Style
18	0612 Box, File	Source Laminate Foundation Laminate Flintwood	Edge Trim Colors	Source Laminate	1 Standard Expansion 2 Soft Touch 4 Standard T/O/S 6 Arched 7 Elliptical 9 Rectilinear	Foundation Accent Mica	K Keyed Alike R Keyed Randomly

SAMPLE ORDER CODE

RBSS 18	0612	2E	4E	3E	1	E	K
----------------	-------------	-----------	-----------	-----------	----------	----------	----------

DIMENSIONS
INCHES / MM

D
18 / 457

PRICING

Source Laminate	Foundation Laminate	Flintwood
648	719	1079

freestanding storage & accessories

Xpress

R B A T

Freestanding Tower with Lateral Access and Drawers

This product provides different ways of storage, while supporting the worksurface, for an integrated and refined look.

WHAT'S INCLUDED

1 tower, 1 cable pass-through ring (as specified), pulls, levelers, lock and keys, mounting hardware and accessories as listed below:

	Heights			Drawer Configurations	
	42"	51"	66"	6612	1212
Compartment (Lateral Access)	1	1	2	Pencil Drawer 1	n/a
Metal Shelves Section	n/a	1	1	Drawer Divider 1	n/a
				12" Hanging File Bar 1	2

WHAT'S EXCLUDED

Top for Solid Storage Cabinet and Cable Pass-Through Cover (if applicable).

NOTES

Specify the depth according to the worksurface on which the tower is installed.

When used with odd worksurface widths, total footprint will respect 6" increments.

Included hanging file bars are to be installed along the width only.

A4 binder does **not** fit, because upper shelf is fixed.

Soft Touch (2) and Standard T/O/S (4) pulls are only available in limited Foundation colors. Refer to the specification software for details.

With Cable Pass-Through option is **not** available on 20" deep configuration.

Cable Pass-Through ring comes in a Platinum Coordinate.

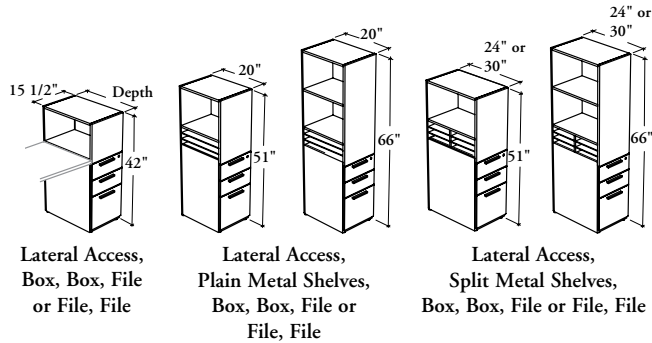

PRODUCT OPTIONS

Depth	Height	Drawer Configuration	Configuration	Drawer Front, Front Panel and Back Panel Finish	Edge Trim Finish	Case Finish	Pull Style	Pull and Metal Shelf Finish	Key Style	Cable Pass-Through
20, 24, 30	42, 51, 66	6612 Box, Box, File (Shown) 1212 File, File	L Left R Right (Shown)	Source Laminate Foundation Laminate Flintwood	Edge Trim Colors	Source Laminate	1 Standard Expansion 2 Soft Touch 4 Standard T/O/S 6 Arched 7 Elliptical 9 Rectilinear	Foundation Accent Mica	K Keyed Alike R Keyed Randomly N No Lock	N No Cable Pass-Through P With Cable Pass-Through

SAMPLE ORDER CODE

RBAT 30	51	6612	L	2E	4E	3E	2	E	R	P
----------------	-----------	-------------	----------	-----------	-----------	-----------	----------	----------	----------	----------

DIMENSIONS INCHES / MM

D	H
20 / 508	42 / 1067
20 / 508	51 / 1295
20 / 508	66 / 1676
24 / 610	42 / 1067
24 / 610	51 / 1295
24 / 610	66 / 1676
30 / 762	42 / 1067
30 / 762	51 / 1295
30 / 762	66 / 1676

PRICING

FILE, FILE (1212)		
Source Laminate	Foundation Laminate	Flintwood
1070	1121	1680
1393	1444	2170
1621	1670	2502
1116	1168	1753
1498	1550	2322
1750	1800	2702
1202	1247	1865
1663	1711	2567
1956	2002	3003

BOX, BOX, FILE (6612)		
Source Laminate	Foundation Laminate	Flintwood
1118	1159	1735
1440	1481	2224
1665	1708	2557
1166	1202	1801
1549	1581	2373
1799	1835	2749
1242	1278	1913
1706	1739	2611
1999	2032	3048

This product provides different ways of storage, while supporting the worksurface, for an integrated and refined look.

R B A T W

Freestanding Tower with Lateral Access, Drawers and Wardrobe

WHAT'S INCLUDED

1 tower, 1 wardrobe, 1 coat rod, pulls, levelers, lock and keys, hardware and accessories as listed below:

	Heights			Drawer Configurations	
	42"	51"	66"	6612	1212
Compartment (Lateral Access)	1	1	2	Pencil Drawer	1 n/a
Metal Shelves Section	n/a	1	1	Drawer Divider	1 n/a
				12" Hanging File Bar	1 2

WHAT'S EXCLUDED

Top for Solid Storage Cabinet.

NOTES

Specify the depth according to the worksurface on which the tower is installed.

Included hanging file bars are to be installed along the width only.

A4 binder does **not** fit, because upper shelf is fixed.

Soft Touch (2) and Standard T/O/S (4) pulls are only available in limited Foundation colors. Refer to the specification software for details.

11/16" thick construction.

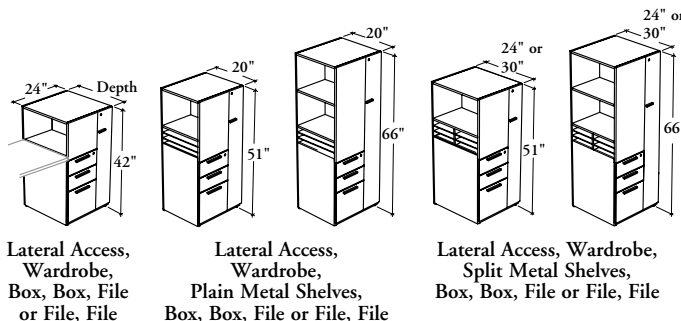

Lateral Access, Wardrobe, Box, Box, File or File, File

Lateral Access, Wardrobe, Plain Metal Shelves, Box, Box, File or File, File

Lateral Access, Wardrobe, Split Metal Shelves, Box, Box, File or File, File

PRODUCT OPTIONS

Depth	Height	Drawer Configuration	Configuration	Drawer Front, Front Panel and Back Panel Finish	Edge Trim Finish	Case Finish	Pull Style	Pull and Metal Shelf Finish	Key Style
20, 24, 30	42, 51, 66	6612 Box, Box, File (Shown) 1212 File, File	L Left R Right (Shown)	Source Laminate Foundation Laminate Flintwood	Edge Trim Colors	Source Laminate	1 Standard Expansion 2 Soft Touch 4 Standard T/O/S 6 Arched 7 Elliptical 9 Rectilinear	Foundation Accent Mica	K Keyed Alike R Keyed Randomly N No Lock

SAMPLE ORDER CODE

RBATW 20	51	6612	L	2E	4E	3E	2	E	R
-----------------	-----------	-------------	----------	-----------	-----------	-----------	----------	----------	----------

DIMENSIONS INCHES / MM

D	H
20 / 508	42 / 1067
20 / 508	51 / 1295
20 / 508	66 / 1676
24 / 610	42 / 1067
24 / 610	51 / 1295
24 / 610	66 / 1676
30 / 762	42 / 1067
30 / 762	51 / 1295
30 / 762	66 / 1676

PRICING

FILE, FILE (1212)		
Source Laminate	Foundation Laminate	Flintwood
1456	1492	2069
1819	1858	2600
2120	2158	3014
1536	1569	2173
1957	1995	2784
2286	2321	3239
1661	1695	2332
2169	2202	3071
2536	2572	3586

BOX, BOX, FILE (6612)		
Source Laminate	Foundation Laminate	Flintwood
1505	1543	2123
1871	1908	2648
2172	2210	3065
1586	1622	2224
2009	2044	2837
2335	2371	3287
1712	1747	2381
2216	2254	3122
2586	2619	3635

freestanding storage & accessories

Xpress

R B N C P

Metal Combo Pedestal

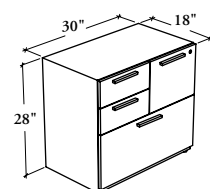

This pedestal with metal casing provides box and file drawer storage below the worksurface. Its full-extension drawers can accommodate both letter- and legal-size paper.

WHAT'S INCLUDED

1 combo pedestal (2 box drawers/1 – 15" file drawer/1 – 30" file drawer), 1 pencil tray, 1 drawer divider, 1 12" and 1 30" hanging file bars, pulls, levelers, counterweight (if specified), lock and keys.

WHAT'S EXCLUDED

Top for Metal Storage Cabinet and Metal Storage Accessories.

NOTES

File drawers have a central locking system and box drawers are **not** lockable.

The Combo Pedestal is a handed product and must be specified left or right. The handed end is determined by the location of the 15" file drawer.

Coordinate colors for case are solid colors that can be used to match wood prints such as those of drawer fronts.

Counterweight must be specified when pedestal will **not** be used under a worksurface.

Included hanging file bars are to be installed along the width only.

Drawer datum line will **not** match with any laminate storage when positioned side-by-side.

When Metal Storage are positioned side-by-side, ensure product is leveled. If front/door alignment is needed, it can be done by either releasing the front mounting screws, adjusting the front/door and tightening the screws, or by using hinge adjustments to ensure an equal gap

The Coordinate Colors for case finish are available with Laminate Drawer Front Finishes only.

Xpress Drawer front finish is only available in limited finishes as Xpress. Please see Xpress catalogue and/or specification software for details.

PRODUCT OPTIONS

Depth	Width	Height	Configuration	Drawer Front Finish	Edge Trim Finish (Laminate Front only)	Case Finish	Pull Style	Pull Finish	Key Style	Counterweight Option
18	30	28	L Left R Right (Shown)	Metal Front: • Foundation • Mica Laminate Front: • Source Laminate • Foundation Laminate Flintwood Front: • Flintwood	Edge Trim Colors	Foundation Mica Coordinate Colors	1 Standard Expansion 6 Arched 7 Elliptical 9 Rectilinear	Foundation Accent Mica	K Keyed Alike R Keyed Randomly	W Counterweight

SAMPLE ORDER CODE

RBNCP	18	30	28	R	2D	4D	7	7	7	R	
--------------	-----------	-----------	-----------	----------	-----------	-----------	----------	----------	----------	----------	--

DIMENSIONS
INCHES / MM

D	W	H
18 / 457	30 / 762	28 / 737
18 / 457	30 / 762	28 / 737

PRICING

	CASE FINISH		DRAWER FRONT FINISH		
	Foundation / Coordinate	Mica	Source Laminate	Foundation Laminate	Flintwood
Foundation / Coordinate	1469	1523	1557	1714	2917
Mica	1559	1614	1651	1806	3009

COUNTERWEIGHT

157
157

The Combo Pedestal provides file drawer storage below the worksurface.

WHAT'S INCLUDED

1 combo pedestal (2 box drawers/1 – 15" file drawer/1 – 30" file drawer), 1 pencil tray, 1 drawer divider, 1 12" hanging file bar, 2 15" cross file bars, pulls, levelers, lock and keys.

WHAT'S EXCLUDED

Top for Solid Storage Cabinet and Supported Pedestal Kit.

NOTES

The box drawers are **not** lockable.

The Combo Pedestal is a handed product and must be specified left or right. The handed end is determined by the location of the 15" file drawer.

The 12" hanging file bar installs along the width in the 15" file drawer.

The 15" cross file bars install along the depth in the 30" file drawer.

Soft Touch (2) and Standard T/O/S (4) pulls are only available in limited Foundation colors. Refer to the specification software for details.

**RBCP
Combo Pedestal**

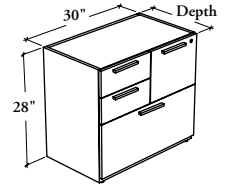

PRODUCT OPTIONS

Depth	Width	Height	Configuration	Drawer Front Finish	Edge Trim Finish	Case Finish	Pull Style	Pull Finish	Key Style
18, 20, 24	30	28	L Left R Right (Shown)	Source Laminate Foundation Laminate Flintwood	Edge Trim Colors	Source Laminate	1 Standard Expansion 2 Soft Touch 4 Standard T/O/S 6 Arched 7 Elliptical 9 Rectilinear	Foundation Accent Mica	K Keyed Alike R Keyed Randomly

SAMPLE ORDER CODE

RBCP 24	30	28	R	LW	ST	XS	6	P	R
----------------	-----------	-----------	----------	-----------	-----------	-----------	----------	----------	----------

**DIMENSIONS
INCHES / MM**

D	W	H
18 / 457	30 / 762	28 / 737
20 / 508	30 / 762	28 / 737
24 / 610	30 / 762	28 / 737

PRICING

Source Laminate	Foundation Laminate	Flintwood
1557	1714	2917
1608	1769	2970
1714	1876	3074

freestanding storage & accessories

Xpress

RBNLF

Metal Lateral File

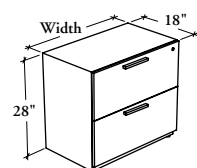

This storage unit with metal casing provides high density filing and organized storage.

WHAT'S INCLUDED

1 lateral file cabinet with 2 file drawers, 1 30" or 36" hanging file bar (per drawer), pulls, levelers, counterweight (as specified), lock and keys.

WHAT'S EXCLUDED

Top for Metal Storage Cabinet and Metal Storage Accessories.

NOTES

This storage unit has a central locking system and full-extension drawers than can accommodate both letter- and legal-size paper. It is also equipped with an interlock system that prevents opening more than one drawer at a time.

Coordinate colors for case are solid colors that can be used to match wood prints such as those of drawer fronts.

Counterweight must be specified when storage unit will **not** be used under a worksurface.

Included hanging file bars are to be installed along the width only.

Drawer datum line will **not** match with any laminate storage when positioned side-by-side.

When Metal Storage are positioned side-by-side, ensure product is leveled. If front/door alignment is needed, it can be done by either releasing the front mounting screws, adjusting the front/door and tightening the screws, or by using hinge adjustments to ensure an equal gap

The Coordinate Colors for case finish are available with Laminate Drawer Front Finishes only.

Xpress Drawer front finish is only available in limited finishes as Xpress. Please see Xpress catalogue and/or specification software for details.

PRODUCT OPTIONS

Depth	Width	Height	Drawer Front Finish	Edge Trim Finish (Laminate Front only)	Case Finish	Pull Style	Pull Finish	Key Style	Counterweight Option
18	30, 36	28	Metal Front: • Foundation • Mica Laminate Front: • Source Laminate • Foundation Laminate Flintwood Front: • Flintwood	Edge Trim Colors	Foundation Mica Coordinate Colors	1 Standard Expansion 6 Arched 7 Elliptical 9 Rectilinear	Foundation Accent Mica	K Keyed Alike R Keyed Randomly	W Counterweight

SAMPLE ORDER CODE

RBNLF										
18	30	28	2D	4D	E	1	E	R		

DIMENSIONS INCHES / MM

D	W	H
18 / 457	30 / 762	28 / 737
18 / 457	30 / 762	28 / 737
18 / 457	36 / 914	28 / 737
18 / 457	36 / 914	28 / 737

PRICING

CASE FINISH

Foundation / Coordinate
Mica
Foundation / Coordinate
Mica

DRAWER FRONT FINISH

Foundation	Mica	Source Laminate	Foundation Laminate	Flintwood
1009	1065	1072	1177	2130
1100	1158	1165	1268	2224
1102	1158	1161	1264	2263
1195	1248	1252	1358	2356

COUNTERWEIGHT

157
157
157
157

This storage unit is available in a variety of heights to provide high density filing and organized storage. The 28" high version is to be used under a worksurface.

RBLF Lateral File

WHAT'S INCLUDED

1 lateral file cabinet, 1 cable pass-through ring (as specified), pulls, levelers, lock and keys, and cross file bar as listed below:

	Widths		
	24"	30"	36"
15" Cross File Bar	1	2	2 (per drawer)

WHAT'S EXCLUDED

Top for Solid Storage Cabinet, Supported Pedestal Kit, Hang-On Kit and Cable Pass-Through Cover (if applicable).

NOTES

Included cross file bars are to be installed along the depth only.

Soft Touch (2) and Standard T/O/S (4) pulls are only available in limited Foundation colors. Refer to the specification software for details.

With Cable Pass-Through option is available on 24" deep and 28" high configurations only.

Cable Pass-Through ring comes in a Platinum Coordinate.

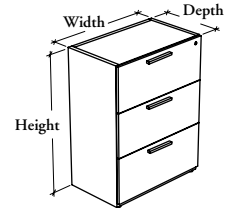

PRODUCT OPTIONS

Depth	Width	Height	Drawer Front Finish	Edge Trim Finish	Case Finish	Pull Style	Pull Finish	Key Style	Cable Pass-Through
18, 20, 24	24, 30, 36	28 Two Drawers (28")	Source Laminate	Edge Trim Colors	Source Laminate	1 Standard Expansion	Foundation Accent Mica	K Keyed Alike	N No Cable Pass-Through
		40 Three Drawers (40") (Shown)	Foundation Laminate			2 Soft Touch		R Keyed Randomly	P With Cable Pass-Through
		53 Four Drawers (53")	Flintwood			4 Standard T/O/S			
						6 Arched			
						7 Elliptical			
						9 Rectilinear			

SAMPLE ORDER CODE

RBLF 24	36	28	XS	ST	XS	1	J	K	N
----------------	-----------	-----------	-----------	-----------	-----------	----------	----------	----------	----------

DIMENSIONS INCHES / MM

D	W
18 / 457	24 / 610
20 / 508	24 / 610
24 / 610	24 / 610
18 / 457	30 / 762
20 / 508	30 / 762
24 / 610	30 / 762
18 / 457	36 / 914
20 / 508	36 / 914
24 / 610	36 / 914

PRICING

TWO DRAWERS (28)			THREE DRAWERS (40)			FOUR DRAWERS (53)		
Source Laminate	Foundation Laminate	Flintwood	Source Laminate	Foundation Laminate	Flintwood	Source Laminate	Foundation Laminate	Flintwood
1022	1137	1708	1676	1797	3053	2253	2368	4024
1078	1192	1760	n/a	n/a	n/a	n/a	n/a	n/a
1182	1295	1862	n/a	n/a	n/a	n/a	n/a	n/a
1072	1177	1767	1725	1837	3129	2298	2415	4103
1124	1234	1821	n/a	n/a	n/a	n/a	n/a	n/a
1234	1337	1927	n/a	n/a	n/a	n/a	n/a	n/a
1161	1264	1904	1821	1935	3290	2397	2503	4263
1211	1324	1957	n/a	n/a	n/a	n/a	n/a	n/a
1319	1427	2064	n/a	n/a	n/a	n/a	n/a	n/a

freestanding storage & accessories

Xpress

RBCD Storage Cabinet

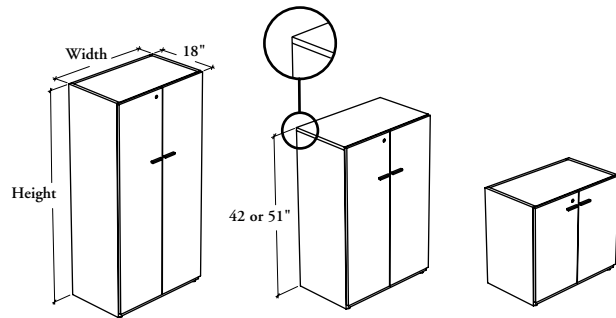

The Storage Cabinet provides a convenient, lockable storage area with shelving.

WHAT'S INCLUDED

1 storage cabinet, pulls, levelers, lock and keys, and adjustable shelf as listed below:

	Heights			
	28"	40" - 53"	66"	72"
Adjustable Shelf	1	2	3	4

WHAT'S EXCLUDED

Top for Solid Storage Cabinet, Supported Pedestal Kit and Hang-On Kit.

NOTES

Top on 42" and 51" heights overlaps side and back panels for a cleaner look and to fit with Elevated Desktop Cabinets.

Holes at 1 1/4" intervals on the inside walls of side panels allow for shelf adjustment.

Additional shelves (RSHE) are available and must be specified separately.

Soft Touch (2) and Standard T/O/S (4) pulls are only available in limited Foundation colors. Refer to the specification software for details.

PRODUCT OPTIONS

Depth	Width	Height	Door Finish	Edge Trim Finish	Case Finish	Pull Style	Pull Finish	Key Style
18, 20, 24	24, 30, 36	28, 40, 42, 51, 53, 66, 72	Source Laminate Foundation Laminate Flintwood	Edge Trim Colors	Source Laminate	1 Standard Expansion 2 Soft Touch 4 Standard T/O/S 6 Arched 7 Elliptical 9 Rectilinear	Foundation Accent Mica	K Keyed Alike R Keyed Randomly

SAMPLE ORDER CODE

RBCD 18	24	28	2D	4D	3D	2	E	K
---------	----	----	----	----	----	---	---	---

DIMENSIONS INCHES / MM

D	W	H
18 / 457	24 / 610	28 / 737
18 / 457	24 / 610	40 / 1016
18 / 457	24 / 610	42 / 1067
18 / 457	24 / 610	51 / 1295
18 / 457	24 / 610	53 / 1346
18 / 457	24 / 610	66 / 1676
18 / 457	24 / 610	72 / 1829
18 / 457	30 / 762	28 / 737
18 / 457	30 / 762	40 / 1016
18 / 457	30 / 762	42 / 1067
18 / 457	30 / 762	51 / 1295
18 / 457	30 / 762	53 / 1346
18 / 457	30 / 762	66 / 1676
18 / 457	30 / 762	72 / 1829
18 / 457	36 / 914	28 / 737
18 / 457	36 / 914	40 / 1016
18 / 457	36 / 914	42 / 1067
18 / 457	36 / 914	51 / 1295
18 / 457	36 / 914	53 / 1346
18 / 457	36 / 914	66 / 1676
18 / 457	36 / 914	72 / 1829

PRICING

Source Laminate	Foundation Laminate	Flintwood
774	860	1288
1130	1234	1844
1130	1234	1844
1253	1373	2059
1253	1373	2059
1556	1703	2550
1734	1888	2837
822	921	1380
1167	1284	1923
1167	1284	1923
1291	1426	2137
1291	1426	2137
1607	1767	2648
1788	1956	2938
869	991	1484
1199	1337	2004
1199	1337	2004
1295	1484	2224
1326	1484	2224
1651	1834	2749
1835	2029	3048

Pricing is continued on the following page.

R B C D

Storage Cabinet (Continued)

DIMENSIONS
INCHES / MM

D	W	H
20 / 508	24 / 610	28 / 737
20 / 508	24 / 610	42 / 1067
20 / 508	24 / 610	51 / 1295
20 / 508	30 / 762	28 / 737
20 / 508	30 / 762	42 / 1067
20 / 508	30 / 762	51 / 1295
20 / 508	36 / 914	28 / 737
20 / 508	36 / 914	42 / 1067
20 / 508	36 / 914	51 / 1295
24 / 610	24 / 610	28 / 737
24 / 610	24 / 610	42 / 1067
24 / 610	24 / 610	51 / 1295
24 / 610	30 / 762	28 / 737
24 / 610	30 / 762	42 / 1067
24 / 610	30 / 762	51 / 1295
24 / 610	36 / 914	28 / 737
24 / 610	36 / 914	42 / 1067
24 / 610	36 / 914	51 / 1295

PRICING

Source Laminate	Foundation Laminate	Flintwood
831	912	1340
1182	1284	1897
1321	1427	2126
877	973	1433
1240	1355	2235
1379	1945	2484
922	1043	1539
1288	1426	2093
1416	1605	2344
934	1017	1444
1235	1334	1946
1384	1492	2195
983	1080	1540
1308	1424	2304
1465	2032	2571
1028	1151	1646
1375	1514	2180
1539	1728	2465

freestanding storage & accessories

Xpress

R B S D

Storage Cabinet with Drawer(s)

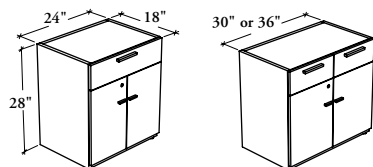

The Storage Cabinet with Drawer(s) provides a functional alternative to combo pedestals and storage cabinets.

WHAT'S INCLUDED

1 storage cabinet with drawers, 1 adjustable shelf, pulls, levelers, lock and keys.

WHAT'S EXCLUDED

Top for Solid Storage Cabinet and Supported Pedestal Kit.

NOTES

The box drawers are **not** lockable.

Holes at 1 1/4" intervals on the inside walls of side panels allow for shelf adjustment.

Additional shelves (RSHE) are available and must be specified separately.

Soft Touch (2) and Standard T/O/S (4) pulls are only available in limited Foundation colors. Refer to the specification software for details.

PRODUCT OPTIONS

Depth	Width	Height	Door Finish	Edge Trim Finish	Case Finish	Pull Style	Pull Finish	Key Style
18	24, 30, 36	28	Source Laminate Foundation Laminate Flintwood	Edge Trim Colors	Source Laminate	1 Standard Expansion 2 Soft Touch 4 Standard T/O/S 6 Arched 7 Elliptical 9 Rectilinear	Foundation Accent Mica	K Keyed Alike R Keyed Randomly

SAMPLE ORDER CODE

RBSD 18	24	28	3D	4D	3D	4	G	K
----------------	-----------	-----------	-----------	-----------	-----------	----------	----------	----------

**DIMENSIONS
INCHES / MM**

D	W	H
18 / 457	24 / 610	28 / 737
18 / 457	30 / 762	28 / 737
18 / 457	36 / 914	28 / 737

PRICING

Source Laminate	Foundation Laminate	Flintwood
1510	1604	2721
1537	1629	2767
1564	1655	2815

This bookcase may be installed under all Expansion Desking desks. It is a low storage in which you can store two rows of standard letter-size binders.

WHAT'S INCLUDED

1 open bookcase and 1 adjustable shelf.

WHAT'S EXCLUDED

Top for Solid Storage Cabinet and Supported Pedestal Kit.

NOTES

11/16" thick construction.

Holes at 1 1/4" intervals on the inside walls of side panels allow for shelf adjustment.

R B S U B
Underworksurface Bookcase

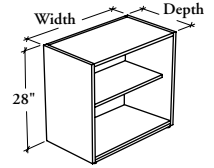

PRODUCT OPTIONS

Depth	Width	Height	Case and Shelf Finish
15, 18, 20, 24	24, 30, 36	28	Source Laminate

SAMPLE ORDER CODE

RBSUB 15	36	28	3E
-----------------	-----------	-----------	-----------

DIMENSIONS
INCHES / MM

D	W	H
15 / 381	24 / 610	28 / 737
15 / 381	30 / 762	28 / 737
15 / 381	36 / 914	28 / 737
18 / 457	24 / 610	28 / 737
18 / 457	30 / 762	28 / 737
18 / 457	36 / 914	28 / 737
20 / 508	24 / 610	28 / 737
20 / 508	30 / 762	28 / 737
20 / 508	36 / 914	28 / 737
24 / 610	24 / 610	28 / 737
24 / 610	30 / 762	28 / 737
24 / 610	36 / 914	28 / 737

PRICING

Source Laminate
532
573
619
585
628
674
637
677
725
724
767
815

freestanding storage & accessories

Xpress

R B S F

Half Wardrobe Filing Cabinet

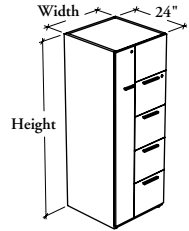

The Half Wardrobe Filing Cabinet with file drawers provides a lockable storage area for garments and other items combined with filing capabilities to accept legal- and letter-size paper.

WHAT'S INCLUDED

1 half wardrobe filing cabinet, 4 file drawers, 1 coat rod, 4 12" hanging file bars, pulls, levelers, lock and keys.

WHAT'S EXCLUDED

Top for Solid Storage Cabinet and Hang-On Kit.

NOTES

Only the storage unit above the file drawers is **not** lockable.

The Half Wardrobe Filing Cabinet is handed and must be specified left or right. The handed end is determined by the location of the drawers.

Width of drawers is fixed. Only the wardrobe width varies.

Hanging file bars are included along the width only.

Soft Touch (2) and Standard T/O/S (4) pulls are only available in limited Foundation colors. Refer to the specification software for details.

PRODUCT OPTIONS

Depth	Width	Height	Configuration	Door and Drawer Front Finish	Edge Trim Finish	Case Finish	Pull Style	Pull Finish	Key Style
24	24, 30, 36	66, 72	L Left R Right (Shown)	Source Laminate Foundation Laminate Flintwood	Edge Trim Colors	Source Laminate	1 Standard Expansion 2 Soft Touch 4 Standard T/O/S 6 Arched 7 Elliptical 9 Rectilinear	Foundation Accent Mica	K Keyed Alike R Keyed Randomly

SAMPLE ORDER CODE

RBSF 24	24	66	R	2D	4D	3D	7	N	K
----------------	-----------	-----------	----------	-----------	-----------	-----------	----------	----------	----------

**DIMENSIONS
INCHES / MM**

D	W	H
24 / 610	24 / 610	66 / 1676
24 / 610	24 / 610	72 / 1829
24 / 610	30 / 762	66 / 1676
24 / 610	30 / 762	72 / 1829
24 / 610	36 / 914	66 / 1676
24 / 610	36 / 914	72 / 1829

PRICING

Source Laminate	Foundation Laminate	Flintwood
2829	3076	5232
2923	3198	5440
3116	3384	5754
3216	3525	5990
3422	3720	6327
3532	3879	6591

Half Wardrobe Unit with Drawers – Open Shelves

The Half Wardrobe Unit provides a lockable storage area to store garments and other items combined with the filing capabilities of a pedestal (letter- and legal-size paper).

WHAT'S INCLUDED

1 half wardrobe unit, 1 coat rod, pulls, levelers, lock and keys, and accessories listed below:

	Drawer Configurations		Heights	
	6612	1212	51"	66" or 72"
Pencil Tray	1	n/a	Shelf	1
Drawer Divider	1	n/a		2
12" Hanging File Bar	1	2		

WHAT'S EXCLUDED

Top for Solid Storage Cabinet and Hang-On Kit.

NOTES

Top on 51" height overlaps side and back panels for a cleaner look and to fit with Elevated Desktop Cabinets.

Holes at 1 1/4" intervals on the inside walls of side panels of the top section allow for shelf adjustment.

The Half Wardrobe Unit is handed and must be specified left or right. The handed end is determined by the location of the drawers.

Width of drawers is fixed. Only the wardrobe width varies.

Hanging file bars are included along the width only.

Soft Touch (2) and Standard T/O/S (4) pulls are only available in limited Foundation colors. Refer to the specification software for details.

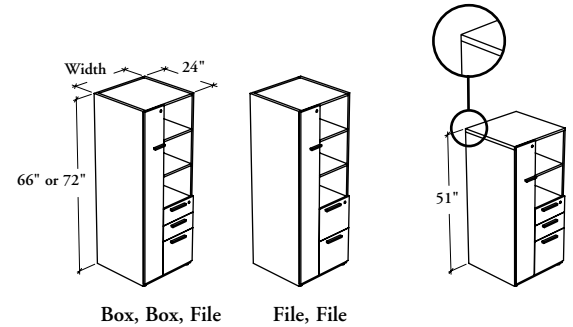

PRODUCT OPTIONS

Depth	Width	Height	Drawer Configuration	Configuration	Drawer Front and Door Finish	Edge Trim Finish	Case Finish	Pull Style	Pull Finish	Key Style
24	24, 30, 36	51, 66, 72	6612 Box, Box, File 1212 File, File	L Left R Right (Shown)	Source Laminate Foundation Laminate Flintwood	Edge Trim Colors	Source Laminate	1 Standard Expansion 2 Soft Touch 4 Standard T/O/S 6 Arched 7 Elliptical 9 Rectilinear	Foundation Accent Mica	K Keyed Alike R Keyed Randomly

SAMPLE ORDER CODE

RBSCO 24	24	66	6612	L	3D	4D	3D	1	N	R
---------------------------	-----------	-----------	-------------	----------	-----------	-----------	-----------	----------	----------	----------

DIMENSIONS INCHES / MM

D	W	H
24 / 610	24 / 610	51 / 1295
24 / 610	24 / 610	66 / 1676
24 / 610	24 / 610	72 / 1829
24 / 610	30 / 762	51 / 1295
24 / 610	30 / 762	66 / 1676
24 / 610	30 / 762	72 / 1829
24 / 610	36 / 914	51 / 1295
24 / 610	36 / 914	66 / 1676
24 / 610	36 / 914	72 / 1829

PRICING

FILE, FILE (1212)			BOX, BOX, FILE (6612)		
Source Laminate	Foundation Laminate	Flintwood	Source Laminate	Foundation Laminate	Flintwood
2074	2254	3822	2114	2286	3885
2234	2430	4130	2270	2463	4195
2315	2523	4284	2354	2551	4349
2347	2546	4345	2384	2580	4410
2518	2765	4705	2554	2801	4771
2604	2873	4885	2642	2909	4950
2629	2849	4850	2668	2885	4911
2823	3104	5275	2862	3135	5339
2920	3231	5490	2957	3262	5555

freestanding storage & accessories

Xpress

R B S C L

Half Wardrobe Unit with Drawers – Solid Doors

The Half Wardrobe Unit provides a lockable storage area to store garments and other items combined with the filing capabilities of a pedestal (letter- and legal-size paper).

WHAT'S INCLUDED

1 half wardrobe unit, 1 coat rod, pulls, levelers, lock and keys, and accessories listed below:

	Drawer Configurations		Heights	
	6612	1212	51"	66" or 72"
Pencil Tray	1	n/a	Shelf	1
Drawer Divider	1	n/a		2
12" Hanging File Bar	1	2		

WHAT'S EXCLUDED

Top for Solid Storage Cabinet and Hang-On Kit.

NOTES

Top on 51" height overlaps side and back panels for a cleaner look and to fit with Elevated Desktop Cabinets.

Holes at 1 1/4" intervals on the inside walls of side panels of the top section allow for shelf adjustment.

The Half Wardrobe Unit is handed and must be specified left or right. The handed end is determined by the location of the drawers.

Width of drawers is fixed. Only the wardrobe width varies.

Hanging file bars are included along the width only.

Soft Touch (2) and Standard T/O/S (4) pulls are only available in limited Foundation colors. Refer to the specification software for details.

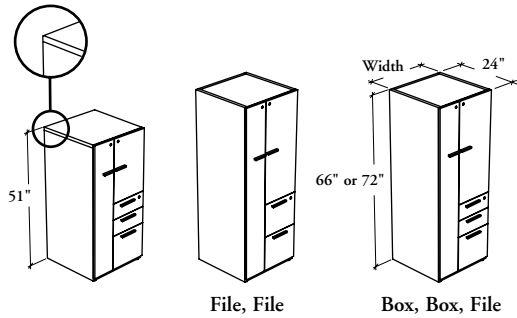

PRODUCT OPTIONS

Depth	Width	Height	Drawer Configuration	Configuration	Drawer Front and Door Finish	Edge Trim Finish	Case Finish	Pull Style	Pull Finish	Key Style
24	24, 30, 36	51, 66, 72	6612 Box, Box, File 1212 File, File	L Left R Right (Shown)	Source Laminate Foundation Laminate Flintwood	Edge Trim Colors	Source Laminate	1 Standard Expansion 2 Soft Touch 4 Standard T/O/S 6 Arched 7 Elliptical 9 Rectilinear	Foundation Accent Mica	K Keyed Alike R Keyed Randomly

SAMPLE ORDER CODE

RBSC 24	30	72	6612	R	3D	4D	3D	4	E	R
--------------------------	-----------	-----------	-------------	----------	-----------	-----------	-----------	----------	----------	----------

DIMENSIONS INCHES / MM

D	W	H
24 / 610	24 / 610	51 / 1295
24 / 610	24 / 610	66 / 1676
24 / 610	24 / 610	72 / 1829
24 / 610	30 / 762	51 / 1295
24 / 610	30 / 762	66 / 1676
24 / 610	30 / 762	72 / 1829
24 / 610	36 / 914	51 / 1295
24 / 610	36 / 914	66 / 1676
24 / 610	36 / 914	72 / 1829

PRICING

FILE, FILE (1212)

Source Laminate	Foundation Laminate	Flintwood
2246	2450	4147
2444	2674	4544
2543	2787	4741
2524	2738	4671
2727	3009	5119
2829	3145	5341
2805	3048	5169
3033	3348	5689
3147	3496	5948

BOX, BOX, FILE (6612)

Source Laminate	Foundation Laminate	Flintwood
2286	2485	4210
2484	2705	4603
2580	2823	4797
2559	2770	4736
2767	3043	5172
2870	3180	5401
2844	3083	5233
3072	3378	5744
3183	3532	6002

freestanding storage & accessories

Xpress

R B C G

Half Wardrobe Unit with Drawers – Glass Door

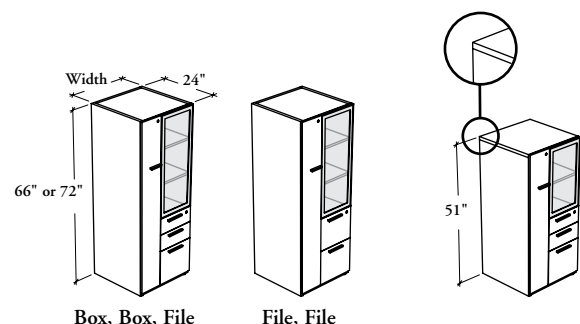

The Half Wardrobe Unit provides a lockable storage area to store garments and other items combined with the filing capabilities of a pedestal (letter- and legal-size paper).

WHAT'S INCLUDED

1 half wardrobe unit, 1 coat rod, pulls, levelers, lock and keys, and accessories listed below:

	Drawer Configurations		Heights	
	6612	1212	51"	66" or 72"
Pencil Tray	1	n/a	Shelf	1
Drawer Divider	1	n/a		2
12" Hanging File Bar	1	2		

WHAT'S EXCLUDED

Top for Solid Storage Cabinet and Hang-On Kit.

NOTES

Top on 51" height overlaps side and back panels for a cleaner look and to fit with Elevated Desktop Cabinets.

Holes at 1 1/4" intervals on the inside walls of side panels of the top section allow for shelf adjustment.

The Half Wardrobe Unit is handed and must be specified left or right. The handed end is determined by the location of the drawers.

Width of drawers is fixed. Only the wardrobe width varies.

Hanging file bars are included along the width only.

Frosted (FT) is a single-sided etched tempered glass which is facing inward of storage.

Soft Touch (2) and Standard T/O/S (4) pulls are only available in limited Foundation colors. Refer to the specification software for details.

Xpress Not all glass door finishes are available as Xpress, Please see Xpress catalogue and/or specification software for details.

PRODUCT OPTIONS

Configuration	Depth	Configuration	Drawer Front and Door Finish	Door Frame Finish	Glass Door Finish	Pull Style	Pull Finish	Key Style	Glass Door Lock
B Box, Box, File	24	L Left	Source Laminate	Foundation	Standard Glass: CL Clear	1 Standard Expansion	Foundation	K Keyed Alike	0 No
	Width		Foundation Laminate	Accent					
F File, File	24, 30, 36	R Right (Shown)	Flintwood	Mica	FT Frosted	4 Standard T/O/S	Mica		1 Yes
	Height		Edge Trim Finish	AC Clear Anodized	Back-Painted Glass				
	51, 66, 72		Edge Trim Colors			7 Elliptical			
			Case Finish			9 Rectilinear			
			Source Laminate						

SAMPLE ORDER CODE

RBCG														
F	24	36	72	R	FX	XG	AC	FT	9	E	R	1		

DIMENSIONS INCHES / MM

D	W	H
24 / 610	24 / 610	51 / 1295
24 / 610	24 / 610	66 / 1676
24 / 610	24 / 610	72 / 1829
24 / 610	30 / 762	51 / 51
24 / 610	30 / 762	66 / 1676
24 / 610	30 / 762	72 / 1829
24 / 610	36 / 914	51 / 51
24 / 610	36 / 914	66 / 1676
24 / 610	36 / 914	72 / 1829

PRICING

FILE, FILE (F)			FROSTED GLASS DOOR (FT)/ BACK-PAINTED GLASS DOOR		
CLEAR GLASS DOOR (CL)					
Source Laminate	Foundation Laminate	Flintwood	Source Laminate	Foundation Laminate	Flintwood
2335	2532	4233	2439	2636	4337
2777	2972	4671	2914	3109	4808
2901	3110	4872	3068	3277	5039
2618	2868	4811	2722	2972	4915
3061	3311	5250	3198	3448	5387
3195	3465	5475	3362	3632	5642
2816	3098	5271	2920	3202	5375
3365	3651	5821	3502	3788	5958
3508	3822	6078	3675	3989	6245

GLASS DOOR LOCK (1)

55
55
55
55
55
55
55
55
55
55
55

R B C G

Half Wardrobe Unit with Drawers –
Glass Door (Continued)

DIMENSIONS
INCHES / MM

D	W	H
24 / 610	24 / 610	51 / 1295
24 / 610	24 / 610	66 / 1676
24 / 610	24 / 610	72 / 1829
24 / 610	30 / 762	51 / 1295
24 / 610	30 / 762	66 / 1676
24 / 610	30 / 762	72 / 1829
24 / 610	36 / 914	51 / 1295
24 / 610	36 / 914	66 / 1676
24 / 610	36 / 914	72 / 1829

PRICING

BOX,BOX, FILE (F)					
CLEAR GLASS DOOR (CL)			FROSTED GLASS DOOR (FT)/ BACK-PAINTED GLASS DOOR		
Source Laminate	Foundation Laminate	Flintwood	Source Laminate	Foundation Laminate	Flintwood
2376	2574	4271	2480	2678	4375
2815	3008	4733	2952	3145	4870
2942	3141	4930	3109	3308	5097
2660	2906	4848	2764	3010	4952
3098	3344	5305	3235	3481	5442
3232	3496	5536	3399	3663	5703
2856	3138	5310	2960	3242	5414
3406	3682	5873	3543	3819	6010
3545	3851	6134	3712	4018	6301

GLASS DOOR
LOCK (1)

55
55
55
55
55
55
55
55
55

freestanding storage & accessories

Xpress

RBSU

Storage Unit

Storage Units combine the filing capabilities of a Lateral File with the flexibility of a storage unit.

WHAT'S INCLUDED

1 storage unit with 2 lateral file drawers, pulls, levelers, lock and keys, and accessories as listed below:

	Widths			Heights	
	24"	30"	36"	51"	66" or 72"
15" Cross File Bar	2	4	4	Shelf 1	2

WHAT'S EXCLUDED

Top for Solid Storage Cabinet and Hang-On Kit.

NOTES

Top on 51" height overlaps side and back panels for a cleaner look and to fit with Elevated Desktop Cabinets.

This Storage Unit with drawers accepts both letter- and legal-size paper.

Holes at 1 1/4" intervals on the inside walls of side panels allow for shelf adjustment.

Additional shelves (RSHE) are available and must be ordered separately.

Cross file bars are included along the depth only.

Soft Touch (2) and Standard T/O/S (4) pulls are only available in limited Foundation colors. Refer to the specification software for details.

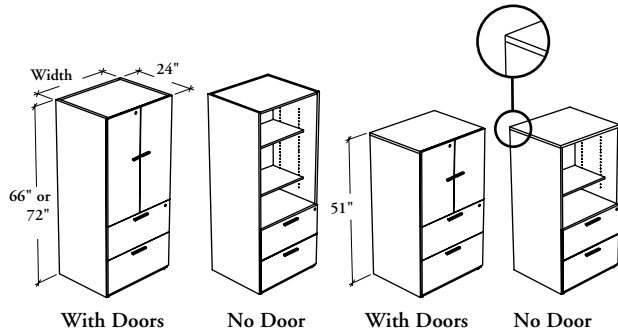

PRODUCT OPTIONS

Door Option	Depth	Width	Height	Drawer Front and Door Finish	Edge Trim Finish	Case Finish	Pull Style	Pull Finish	Key Style
D Door (Shown)	24	24, 30, 36	51, 66, 72	Source Laminate	Edge Trim Colors	Source Laminate	1 Standard Expansion	Foundation Accent	K Keyed Alike
O No Door				Foundation Laminate					
				Flintwood			2 Soft Touch	Mica	
							4 Standard T/O/S		
							6 Arched		
							7 Elliptical		
							9 Rectilinear		

SAMPLE ORDER CODE

RBSU D	24	24	66	2E	4E	3E	1	N	R
---------------	-----------	-----------	-----------	-----------	-----------	-----------	----------	----------	----------

DIMENSIONS
INCHES / MM

D	W	H
24 / 610	24 / 610	51 / 1295
24 / 610	24 / 610	66 / 1676
24 / 610	24 / 610	72 / 1829
24 / 610	30 / 762	51 / 1295
24 / 610	30 / 762	66 / 1676
24 / 610	30 / 762	72 / 1829
24 / 610	36 / 914	51 / 1295
24 / 610	36 / 914	66 / 1676
24 / 610	36 / 914	72 / 1829

PRICING

NO DOOR (O)		
Source Laminate	Foundation Laminate	Flintwood
1826	1894	3213
1956	2057	3493
2023	2138	3633
1909	2051	3416
2053	2189	3725
2123	2282	3879
1996	2246	3731
2196	2390	4062
2265	2492	4231

DOOR (D)		
Source Laminate	Foundation Laminate	Flintwood
1971	2108	3570
2152	2344	3981
2242	2463	4188
2076	2253	3848
2283	2537	4318
2384	2676	4551
2267	2582	4217
2463	2798	4753
2572	2958	5023

Storage Unit with Glass Doors combines the filing capabilities of a Lateral File with the flexibility of a storage unit.

WHAT'S INCLUDED

1 storage unit with 2 lateral file drawers, pulls, levelers, lock and keys, and accessories as listed below:

	Widths			Shelf	Heights	
	24"	30"	36"		51"	66" or 72"
15" Cross File Bar	2	4	4	1	2	

WHAT'S EXCLUDED

Top for Solid Storage Cabinet and Hang-On Kit.

NOTES

Top on 51" height overlaps side and back panels for a cleaner look and to fit with Elevated Desktop Cabinets.

This Storage Unit with drawers accepts both letter- and legal-size paper.

Holes at 1 1/4" intervals on the inside walls of side panels allow for shelf adjustment.

Additional shelves (RSHE) are available and must be ordered separately.

Cross file bars are included along the depth only.

Frosted (FT) is a single-sided etched tempered glass which is facing inward of storage.

Soft Touch (2) and Standard T/O/S (4) pulls are only available in limited Foundation colors. Refer to the specification software for details.

Xpress Not all glass door finishes are available as Xpress, Please see Xpress catalogue and/or specification software for details.

RBUSG
Storage Unit – Glass Doors

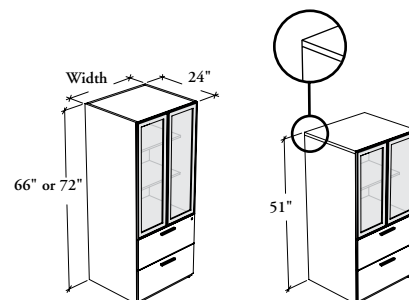

PRODUCT OPTIONS

Depth	Drawer Front Finish	Door Frame Finish	Glass Door Finish	Pull Style	Pull Finish	Key Style	Glass Door Lock
24	Source Laminate	Foundation	Standard Glass: CL Clear	1 Standard Expansion	Foundation	K Keyed Alike	0 No
Width	Foundation Laminate	Accent	FT Frosted	2 Soft Touch	Accent	R Keyed Randomly	1 Yes
	Flintwood	Mica	Back-Painted Glass	4 Standard T/O/S	Mica		
24, 30, 36	Edge Trim Finish	AC Clear Anodized		6 Arched			
Height	Edge Trim Colors			7 Elliptical			
	Case Finish			9 Rectilinear			
51, 66, 72	Source Laminate						

SAMPLE ORDER CODE

RBUSG	24	30	72	2E	4E	3E	AC	K7	1	E	R	0
--------------	-----------	-----------	-----------	-----------	-----------	-----------	-----------	-----------	----------	----------	----------	----------

DIMENSIONS
INCHES / MM

D	W	H
24 / 610	24 / 610	51 / 1295
24 / 610	24 / 610	66 / 1676
24 / 610	24 / 610	72 / 1829
24 / 610	30 / 762	51 / 1295
24 / 610	30 / 762	66 / 1676
24 / 610	30 / 762	72 / 1829
24 / 610	36 / 914	51 / 1295
24 / 610	36 / 914	66 / 1676
24 / 610	36 / 914	72 / 1829

PRICING

CLEAR GLASS DOOR (CL)		
Source Laminate	Foundation Laminate	Flintwood
2739	2840	4275
2958	3058	4495
3103	3217	4713
2886	3023	4554
3131	3268	4799
3285	3445	5041
2980	3173	4843
3348	3541	5214
3495	3724	5459

FROSTED GLASS DOOR (FT) / BACK-PAINTED GLASS DOOR		
Source Laminate	Foundation Laminate	Flintwood
2916	3017	4452
3170	3270	4707
3358	3472	4968
3063	3200	4731
3398	3535	5066
3605	3765	5361
3157	3350	5020
3668	3861	5534
3882	4111	5846

GLASS DOOR LOCK (1)
55
55
55
55
55
55
55
55
55
55

freestanding storage & accessories

Xpress

R B U W

Storage Unit with Wardrobe – Solid Doors

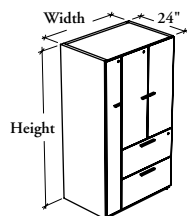

The Storage Unit with Wardrobe combines the organizational capabilities of a storage unit with the storage capacity of a Wardrobe Cabinet.

WHAT'S INCLUDED

1 half-wardrobe, 2 lateral file drawers, 1 storage unit, 2 adjustable shelves, 1 coat rod, 2 15" cross file bars, pulls, levelers, lock and keys.

WHAT'S EXCLUDED

Top for Solid Storage Cabinet and Hang-On Kit.

NOTES

This Storage Unit has drawers that accept both letter- and legal-size paper.

Holes at 1 1/4" intervals on the inside walls of side panels of the top section allow for shelf adjustment.

This Storage Unit is handed and must be specified left or right. The handed end is determined by the location of the drawers.

Cross file bars are included along the depth only.

Soft Touch (2) and Standard T/O/S (4) pulls are only available in limited Foundation colors. Refer to the specification software for details.

PRODUCT OPTIONS

Depth	Width	Height	Configuration	Door and Drawer Front Finish	Edge Trim Finish	Case Finish	Pull Style	Pull Finish	Key Style
24	30, 36	66, 72	L Left R Right (Shown)	Source Laminate Foundation Laminate Flintwood	Edge Trim Colors	Source Laminate	1 Standard Expansion 2 Soft Touch 4 Standard T/O/S 6 Arched 7 Elliptical 9 Rectilinear	Foundation Accent Mica	K Keyed Alike R Keyed Randomly

SAMPLE ORDER CODE

RB UW 24	30	66	L	LW	ST	XS	1	N	R
--------------------	-----------	-----------	----------	-----------	-----------	-----------	----------	----------	----------

DIMENSIONS
INCHES / MM

D	W	H
24 / 610	30 / 762	66 / 1676
24 / 610	30 / 762	72 / 1829
24 / 610	36 / 914	66 / 1676
24 / 610	36 / 914	72 / 1829

PRICING

Source Laminate	Foundation Laminate	Flintwood
2676	2957	5025
2760	3061	5204
2808	3151	5358
2897	3270	5560

The Wardrobe Cabinet, with or without a divider, provides a storage space for garments and other items.

R B S W

Wardrobe Cabinet – Solid Doors

WHAT'S INCLUDED

Divided wardrobe: 1 wardrobe cabinet, 1 coat rod, pulls, levelers, lock and keys and accessory listed below:

Heights	
42 or 51"	66" or 72"
Adjustable Shelf	2 3

Undivided wardrobe: 1 wardrobe cabinet, 1 coat rod, pulls, levelers, lock and keys.

WHAT'S EXCLUDED

Top for Solid Storage Cabinet and Hang-On Kit.

NOTES

Top on 42" and 51" heights overlaps side and back panels for a cleaner look and to fit with Elevated Desktop Cabinets.

Holes at 1 1/4" intervals on the inside walls of side panels of the top section allow for shelf adjustment.

Additional Shelves (RSHE) may be specified separately for the Undivided Wardrobe Cabinet (U).

Soft Touch (2) and Standard T/O/S (4) pulls are only available in limited Foundation colors. Refer to the specification software for details.

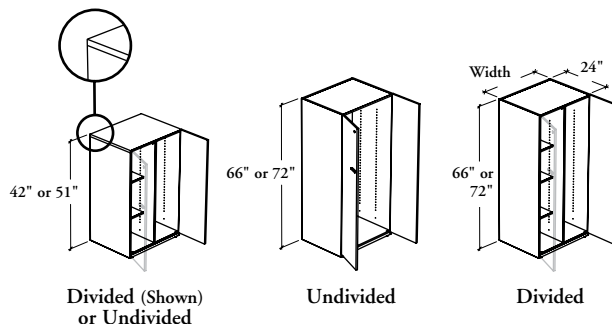

PRODUCT OPTIONS

Style	Depth	Width	Height	Door Finish	Edge Trim Finish	Case Finish	Pull Style	Pull Finish	Key Style
D Divided	24	24, 30, 36	42, 51, 66, 72	Source Laminate	Edge Trim Colors	Source Laminate	1 Standard Expansion	Foundation Accent	K Keyed Alike
U Undivided				Foundation Laminate					
				Flintwood			4 Standard T/O/S		
							6 Arched		
							7 Elliptical		
							9 Rectilinear		

SAMPLE ORDER CODE

RBSW D	24	30	66	FX		XG	1	E	K
---------------	-----------	-----------	-----------	-----------	--	-----------	----------	----------	----------

**DIMENSIONS
INCHES / MM**

D	W	H
24 / 610	24 / 610	42 / 1067
24 / 610	24 / 610	51 / 1295
24 / 610	24 / 610	66 / 1676
24 / 610	24 / 610	72 / 1829
24 / 610	30 / 762	42 / 1067
24 / 610	30 / 762	51 / 1295
24 / 610	30 / 762	66 / 1676
24 / 610	30 / 762	72 / 1829
24 / 610	36 / 914	42 / 1067
24 / 610	36 / 914	51 / 1295
24 / 610	36 / 914	66 / 1676
24 / 610	36 / 914	72 / 1829

PRICING

UNDIVIDED (U)			DIVIDED (D)		
Source Laminate	Foundation Laminate	Flintwood	Source Laminate	Foundation Laminate	Flintwood
1232	1329	1944	1600	1699	2315
1492	1612	2299	1760	1882	2569
1714	1862	3170	2201	2354	3995
1791	1970	3351	2294	2470	4202
1313	1429	2068	1592	1706	2346
1581	1717	2426	1909	2044	2754
1839	2052	3487	2398	2600	4422
1924	2173	3690	2493	2741	4661
1397	1536	2202	1665	1805	2470
1672	1859	2598	2010	2201	2939
1965	2234	3798	2576	2844	4836
2057	2373	4033	2681	3001	5103

freestanding storage & accessories

Xpress

RBOB Bookcase

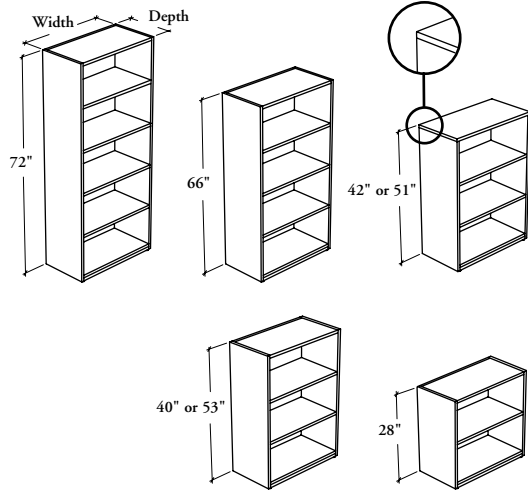

The Bookcase provides open storage space within the workstation.

WHAT'S INCLUDED

1 bookcase, levelers, and adjustable shelf as listed below:

Adjustable Shelves

28" high	1
40" to 53" high	2
66" high	3
72" high	4

WHAT'S EXCLUDED

Top for Solid Storage Cabinet, Supported Pedestal Kit, and Hang-On Kit.

NOTES

Top on 42" and 51" heights overlaps side and back panels for a cleaner look and to fit with Elevated Desktop Cabinets.

The 28" high Bookcase may be installed under worksurfaces.

Holes at 1 1/4" intervals on the inside walls of side panels allow for shelf adjustment.

The shelves and case construction are 1" thick.

Two rows of standard letter-size binders will **not** fit in the 28" high Bookcase.

The 12" deep Bookcase must be placed against and secured to a wall for stability.

PRODUCT OPTIONS

Depth	Width	Height	Case and Shelf Finish
12, 15, 18	24, 30, 36	28, 40, 42, 51, 53, 66, 72	Source Laminate

SAMPLE ORDER CODE

RBOB 15	36	72	3U
----------------	-----------	-----------	-----------

DIMENSIONS – INCHES FOR MM X BY 25.4

PRICING

			12" DEPTH	15" DEPTH	18" DEPTH
D	W	H	Source Laminate	Source Laminate	Source Laminate
12 / 15 / 18	24	28	570	590	610
12 / 15 / 18	24	40	810	848	889
12 / 15 / 18	24	42	810	848	889
12 / 15 / 18	24	51	848	889	928
12 / 15 / 18	24	53	848	889	928
12 / 15 / 18	24	66	1037	1081	1126
12 / 15 / 18	24	72	1166	1213	1260
12 / 15 / 18	30	28	616	637	657
12 / 15 / 18	30	40	841	884	923
12 / 15 / 18	30	42	841	884	923
12 / 15 / 18	30	51	887	925	963
12 / 15 / 18	30	53	887	925	963
12 / 15 / 18	30	66	1082	1130	1173
12 / 15 / 18	30	72	1210	1260	1313
12 / 15 / 18	36	28	665	686	704
12 / 15 / 18	36	40	879	920	960
12 / 15 / 18	36	42	879	920	960
12 / 15 / 18	36	51	928	964	1000
12 / 15 / 18	36	53	928	964	1000
12 / 15 / 18	36	66	1128	1173	1220
12 / 15 / 18	36	72	1260	1318	1370

freestanding storage & accessories

RACMF

Glass Markerboard – Freestanding Storage Mounted

This markerboard must be installed on the back or side of a freestanding storage.

WHAT'S INCLUDED

1 glass markerboard, 1 mounting extrusion, double face tape attachment, mounting hardware, and accessory listed below:

Starting Height	
01	30
Rare Earth Magnet (Magnetic Glass only)	8 4

WHAT'S EXCLUDED

Freestanding Storage

NOTES

Can be mounted onto a single storage only.

Can be mounted on back or side of the following storage units:

- Supporting Towers (RBHAT, RBHSC, RBXT, RBXTC)
- Freestanding Towers (RBAT, RBATW)

Can be mounted on back only of the following storage units:

- 53" high Lateral File only (RBLF)
- Storage Units (RBCD, RBSF, RBSCO, RBSCCL, RBCG, RBSU, RBUSG, RBUW)
- Wardrobe Cabinet (RBSW)
- Bookcase (RBOB)

Mounting extrusion match the glass finish.

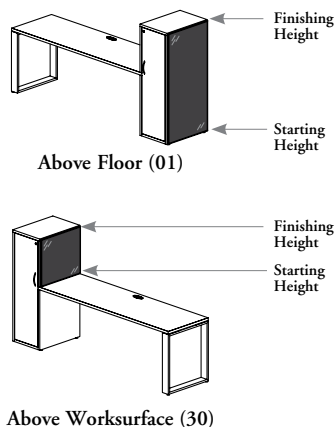
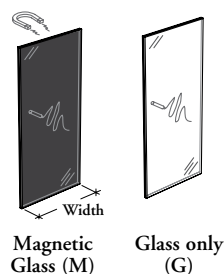

PRODUCT OPTIONS

Markerboard Style	Starting Height	Finishing Height	Width	Glass Finish
G Glass only	01 Above Floor	42, 51, 66, 72	15, 20, 24, 30, 36, 42, 48	Back-Painted
M Magnetic Glass	30 Above Worksurface			

SAMPLE ORDER CODE

RACMF M	30	42	36	K8
----------------	-----------	-----------	-----------	-----------

DIMENSIONS INCHES / MM

H	W
42 / 1067	15 / 381
42 / 1067	20 / 508
42 / 1067	24 / 610
42 / 1067	30 / 762
42 / 1067	36 / 914
42 / 1067	42 / 1067
42 / 1067	48 / 1219

PRICING

ABOVE WORKSURFACE (30)		ABOVE FLOOR (01)	
GLASS ONLY (G)	MAGNETIC GLASS (M)	GLASS ONLY (G)	MAGNETIC GLASS (M)
Back-Painted Glass	Back-Painted Glass	Back-Painted Glass	Back-Painted Glass
235	327	399	501
245	340	493	625
253	347	573	701
277	371	690	843
319	416	807	1009
364	462	922	1126
405	506	1039	1245

Pricing is continued on the following page.

R A C M F
Glass Markerboard – Freestanding
Storage Mounted (Continued)

DIMENSIONS
INCHES / MM

H	W
51 / 1295	15 / 381
51 / 1295	20 / 508
51 / 1295	24 / 610
51 / 1295	30 / 762
51 / 1295	36 / 914
51 / 1295	42 / 1067
51 / 1295	48 / 1219
66 / 1676	15 / 381
66 / 1676	20 / 508
66 / 1676	24 / 610
66 / 1676	30 / 762
66 / 1676	36 / 914
72 / 1829	24 / 610
72 / 1829	30 / 762
72 / 1829	36 / 914

PRICING

ABOVE WORKSURFACE (30)		ABOVE FLOOR (01)	
GLASS ONLY (G)	MAGNETIC GLASS (M)	GLASS ONLY (G)	MAGNETIC GLASS (M)
Back-Painted Glass	Back-Painted Glass	Back-Painted Glass	Back-Painted Glass
232	339	465	571
287	414	579	710
328	459	672	803
396	525	811	965
461	593	950	1155
525	660	1053	1256
590	724	1231	1433
339	441	575	704
420	550	722	876
490	618	839	1041
592	747	1014	1216
694	896	1192	1537
552	684	907	1110
669	822	1095	1297
786	991	1286	1633

Xpress

R B X S K

Supported Pedestal Kit

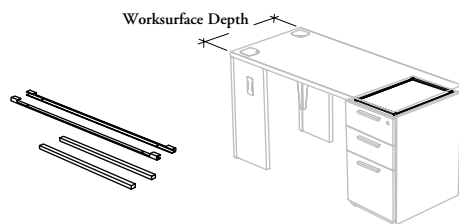

The Supported Pedestal Kit attaches a pedestal to the underside of a worksurface.

WHAT'S INCLUDED

1 supported pedestal kit and mounting hardware.

NOTES

This kit is always included with compatible worksurfaces. It is available here as a spare part.

Kit is finished in Black.

PRODUCT OPTIONS

Worksurface Depth	Case Style
20, 24, 30	L Laminate M Metal

SAMPLE ORDER CODE

RBXSK 30	M
-----------------	----------

**DIMENSIONS
INCHES / MM**

D
20 / 508
24 / 610
30 / 762

PRICING

84
84
84

The Hang-On Kit attaches a worksurface on the side or back of a storage cabinet.

WHAT'S INCLUDED

1 hang-on kit and mounting hardware.

NOTES

This kit is always included with compatible worksurfaces. It is available here as a spare part.

Kit is finished in Black.

R B X H K
Hang-On Kit

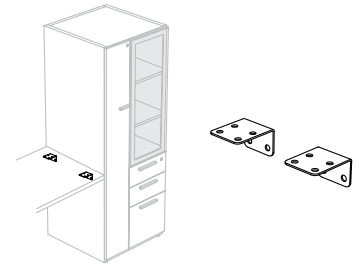

PRODUCT OPTIONS

Worksurface Depth

20, 24, 30

SAMPLE ORDER CODE

RBXHK 30

DIMENSIONS
INCHES / MM

PRICING

D	
20 / 508	42
24 / 610	42
30 / 762	42

freestanding storage & accessories

Xpress

RSNRT

Top for Metal Storage Cabinet

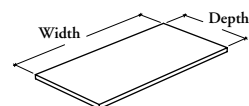

The Top for Metal Storage Cabinet serves as a workspace or as a finishing feature on metal storage units.

WHAT'S INCLUDED

1 rectangular top with mounting hardware.

NOTES

This product is compatible with the following storage units:

- Metal Pedestal (RBNSP)
- Metal Combo Pedestal (RBNCPC)
- Metal Lateral File (RBNLF)

The depth and width of the top specified must equal the depth and the width of the storage unit.

PRODUCT OPTIONS

Depth	Width	Worksurface Finish	Edge Trim Style	Edge Trim Finish
18, 22	15, 30, 36, 60, 66, 72	Foundation Laminate Flintwood	6 Straight Trim 9 Flintwood Flat Trim	Edge Trim Colors (for trim style 6)

SAMPLE ORDER CODE

RSNRT 22	30	2D	6	4D
-----------------	-----------	-----------	----------	-----------

**DIMENSIONS
INCHES / MM**

D	W
18 / 457	15 / 381
18 / 457	30 / 762
18 / 457	36 / 914
18 / 457	60 / 1524
18 / 457	66 / 1676
18 / 457	72 / 1829
22 / 559	15 / 381

PRICING

	Foundation Laminate	Flintwood
	237	512
	320	690
	368	790
	542	1167
	600	1291
	657	1411
	252	541

The Top for Solid Storage Cabinet serves as a worksurface or as a finishing feature on pedestals, storage cabinets, and bookcases.

RSRT

Top for Solid Storage Cabinet

WHAT'S INCLUDED

1 rectangular top with mounting hardware.

NOTES

42" or 51" heights of other storage products.

This product is compatible with all laminate storage, except with following products:

- Supporting Tower with Lateral Access and Drawers (RBHAT)
- Supporting Tower with Door (RBHSC)
- Mobile Pedestal with Seat (RBTPS)
- Suspended Pedestal (RBSS)
- Extended Supporting Tower with Drawer (RBXT)
- Extended Supporting Tower with Full Door (RBXTC)

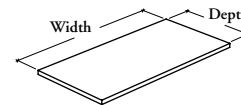

PRODUCT OPTIONS

Depth	Width	Worksurface Finish	Edge Trim Style	Edge Trim Finish
12, 15, 18, 20, 22, 24, 30	15, 24, 30, 36, 48, 54, 60, 66, 72	Foundation Laminate Flintwood	6 Straight Trim 9 Flintwood Flat Trim	Edge Trim Colors (for trim style 6)

SAMPLE ORDER CODE

RSRT 18	72	2D	6	4D
----------------	-----------	-----------	----------	-----------

**DIMENSIONS – INCHES
FOR MM X BY 25.4**

PRICING

D	W	12" DEPTH		15" DEPTH		18" DEPTH		20" DEPTH	
		Foundation Laminate	Flintwood	Foundation Laminate	Flintwood	Foundation Laminate	Flintwood	Foundation Laminate	Flintwood
12 / 15 / 18 / 20	15	n/a	n/a	225	469	237	512	249	534
12 / 15 / 18 / 20	24	248	534	262	589	293	632	299	640
12 / 15 / 18 / 20	30	289	619	311	657	320	690	333	717
12 / 15 / 18 / 20	36	311	668	338	724	368	790	389	834
12 / 15 / 18 / 20	48	n/a	n/a	385	822	435	937	471	1014
12 / 15 / 18 / 20	54	n/a	n/a	429	925	491	1056	532	1141
12 / 15 / 18 / 20	60	n/a	n/a	471	1022	542	1167	588	1260
12 / 15 / 18 / 20	66	n/a	n/a	528	1133	600	1291	650	1397
12 / 15 / 18 / 20	72	n/a	n/a	575	1239	657	1411	708	1522

D	W	22" DEPTH		24" DEPTH		30" DEPTH	
		Foundation Laminate	Flintwood	Foundation Laminate	Flintwood	Foundation Laminate	Flintwood
22 / 24 / 30	15	252	541	262	594	264	571
22 / 24 / 30	24	303	672	319	715	354	786
22 / 24 / 30	30	345	741	355	763	391	835
22 / 24 / 30	36	408	876	428	920	534	1151
22 / 24 / 30	48	506	1089	542	1167	643	1397
22 / 24 / 30	54	572	1231	611	1313	749	1604
22 / 24 / 30	60	635	1360	677	1458	815	1747
22 / 24 / 30	66	698	1502	748	1607	907	1948
22 / 24 / 30	72	761	1634	813	1750	970	2090

freestanding storage & accessories

Xpress

RSHE Shelf for Storage Cabinet

This shelf is an organizational tool for use in wardrobe and high storage cabinets.

WHAT'S INCLUDED

1 shelf with mounting hardware.

NOTES

This product is compatible with the following products:

- Storage Cabinet (RBCD)
- Storage Cabinet with Drawer(s) (RBSD)
- Storage Units (RBSUD, RBSUO or RBUSG)
- Wardrobe Cabinet – Undivided (RBSWU)

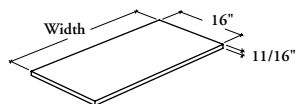

PRODUCT OPTIONS

Depth	Width	Shelf Finish
16	24, 30, 36	Source Laminate

SAMPLE ORDER CODE

RSHE 16	30	LY
---------	----	----

DIMENSIONS INCHES / MM

D	W
16 / 406	24 / 610
16 / 406	30 / 762
16 / 406	36 / 914

PRICING

Source Laminate
108
133
165

The Gap Filler for Pedestals is used to allow storage units with tops to be aligned with freestanding desks of different depths.

WHAT'S INCLUDED

1 gap filler and mounting hardware.

NOTES

The Gap Filler is for use with 28" high underworksurface storage products. It is **not** compatible with metal casing units.

The depth of the Gap Filler specified is the difference between the depth of the worksurface and the depth of the storage product.

R B G F
Gap Filler for Pedestals

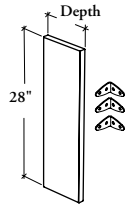

PRODUCT OPTIONS

Depth	Height	Filler Finish
06, 08, 12, 14, 18	28	Source Laminate

SAMPLE ORDER CODE

RBGF 06	28	XK
----------------	-----------	-----------

DIMENSIONS
INCHES / MM

D	H
6 / 152	28 / 737
8 / 203	28 / 737
12 / 305	28 / 737
14 / 356	28 / 737
18 / 457	28 / 737

PRICING

Source Laminate
74
84
108
122
143

freestanding storage & accessories

Xpress

R S L B

Hanging File Bar

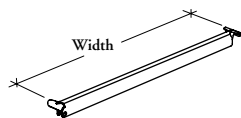

Hanging File Bars are installed in file drawers to allow hanging of letter-size files.

WHAT'S INCLUDED

1 metal hanging file bar.

NOTES

Dimensions are nominal. Specify the width according to the width of the storage cabinet.

12" hanging file bar is used for file drawers in pedestals and is to be installed along the width only.

15" cross file bar is used for lateral file drawers and is to be installed along the depth only.

24", 30" and 36" hanging file bars are used for lateral file drawers and are to be installed along the width only.

For laminate casing units only.

Finished in Black only.

PRODUCT OPTIONS

Width

12, 15, 24, 30, 36

SAMPLE ORDER CODE

RSLB 24

DIMENSIONS INCHES / MM

W
12 / 305
15 / 381
24 / 610
30 / 762
36 / 914

PRICING

10
13
16
27
28

RBNSA

Metal Storage Accessories

These accessories are organizational tools for use in metal storage products.

WHAT'S INCLUDED

Divider for Box Drawer: 2 dividers.

Divider Plates for Lateral File: 3 full-height divider plates.

Cross File Bars: 2 bars.

Counterweight: 1 counterweight with mounting hardware

Pencil Tray: 1 pencil tray.

Hanging File Bars: 2 bars.

NOTES

Divider Plates for Lateral File (02) are designed to fit with lateral metal fronts only.

Number of counterweights required for each product:

Stationary Pedestal	1
Combo Pedestal	2
Lateral File 30" wide	2
Lateral File 36" wide	2

These products are compatible with the following storage units:

- Metal Pedestal (RBNSP)
- Metal Combo Pedestal (RBNCPP)
- Metal Lateral File (RBNLF)

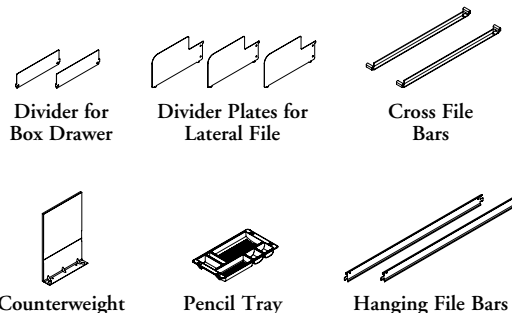

PRODUCT OPTIONS

Style
01 Divider for Box Drawer
02 Divider Plates for Lateral Files
03 Cross File Bars 15" deep
04 Counterweight
05 Pencil Tray
06 Hanging File Bars (15" wide storage)
07 Hanging File Bars (30" wide storage)
08 Hanging File Bars (36" wide storage)

SAMPLE ORDER CODE

RBNSA 03

STYLES	PRICING
01	35
02	39
03 (15" / 381 mm)	39
04	99
05	51
06 (15" / 381 mm)	38
07 (30" / 762 mm)	42
08 (36" / 914 mm)	46

freestanding storage & accessories

Xpress

K **Locks and Keys**

WHAT'S INCLUDED

Style M: 1 Master Key.

Style R: 1 Lock Removal Key.

Style C: 1 Lock Core and Keys.

NOTES

The Master Key unlocks any storage unit.

The Lock Removal Key removes lock cores from storage units.

Lock Cores and Keys are replacements for those currently installed.



Master Key



Lock Removal Key



Lock Core and Keys

PRODUCT OPTIONS

Style

M Master Key

R Lock Removal Key

C Lock Core and Keys

SAMPLE ORDER CODE

K C

STYLES

M
R
C

PRICING

7
7
29

SOKL

Set of Keys Alike

WHAT'S INCLUDED

Each set of cores include a lock & core and 2 identical keys.

NOTES

All storage furniture is shipped with the lock housing pre-installed in each unit ready to receive the required lock plug cores. Based on the product option, lock cores and keys are shipped either numbered randomly or in "keyed-alike" sets. Quantity of lock cores and keys will match the quantities required for the locking components on the order.

SPECIFICATION NOTES

Count the number of locking components in each workstation. Enter the number of locks into the Quantity column, and then assign a SET to each quantity.

Office Number	Quantity	Set #	Set Total
T1	4	SOKL - 4	1
T2	2	SOKL - 2	1
T3	4	SOKL - 4	1
T4	3	SOKL - 3	1

Total the number of SOKL (Sets of Keys Alike) quantities and transfer each total quantity to your Purchase Order.

Sets ordered in the incorrect quantities that are required for the order may result in the order being placed on hold.

Please verify the quantity by reviewing the plan carefully to ensure that all products with locks have been identified. Remember that some products may have more than one lock core per unit based on size and configuration.

For further details on how to specify locks, please see the Teknion Lock Specification Guide on our website.

PRODUCT OPTIONS

Number of Sets of Cores			
01 1 Set of Cores	07 7 Sets of Cores	13 13 Sets of Cores	19 19 Sets of Cores
02 2 Sets of Cores	08 8 Sets of Cores	14 14 Sets of Cores	20 20 Sets of Cores
03 3 Sets of Cores	09 9 Sets of Cores	15 15 Sets of Cores	
04 4 Sets of Cores	10 10 Sets of Cores	16 16 Sets of Cores	
05 5 Sets of Cores	11 11 Sets of Cores	17 17 Sets of Cores	
06 6 Sets of Cores	12 12 Sets of Cores	18 18 Sets of Cores	

SAMPLE ORDER CODE

SOKL 02

lighting, electrics &
communications

lighting, electrics & communications product map

R L E D Linear LED Light

Page 496

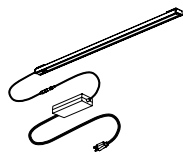

R L Y T U Tangent Undercabinet Light

Page 497

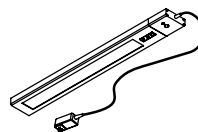

R L S A Shelf Adapter for Universal Light

Page 498

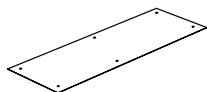

R L W T Cable Tray

Page 499



R L U D B Communication Box

Page 500

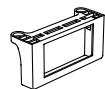

R L D C C Worksurface Power and Communication Center

Page 502

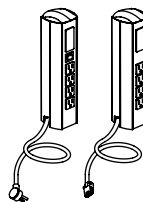

R L P P Underworksurface Plug-In Power Bar

Page 501

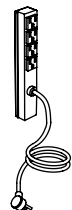

R L D M C Power/Data Center

Page 503

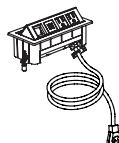

lighting, electrics & communications product map

R L D U Power Box

Page 504

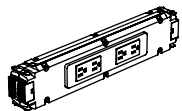

R L C U Chicago Power Box

Page 505

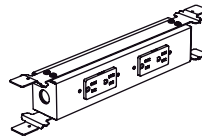

R L D S B Distribution Box

Page 506

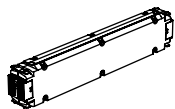

R L D E C Beam Cover

Page 507

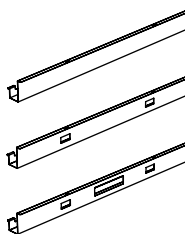

R L D S Power Harness Extension

Page 508

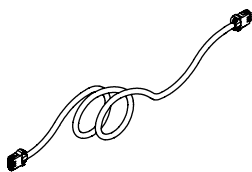

R L D C Power Harness

Page 510

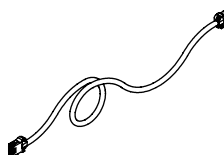

R L D B Base Feed

Page 512

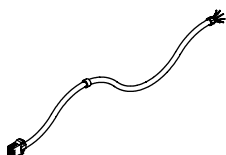

R L B S NYC Split Base Feed

Page 514

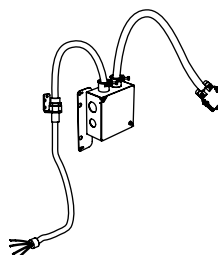

lighting, electrics & communications product map

R L D F Ceiling Feed

Page 516

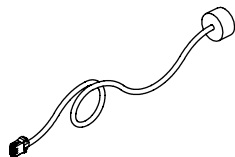

R L S P Column-Mounted Power Pole

Page 520

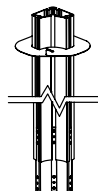

R L S D Power Pole Divider

Page 521

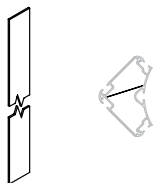

R L P S Lateral Power Pole

Page 522

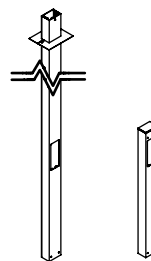

R A G Desking Grommet

Page 523

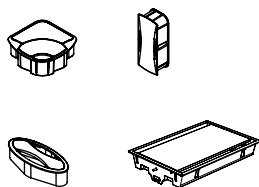

R A G C Rectangular Grommet

Page 524



R A W P C Cable Pass-Through Cover

Page 525

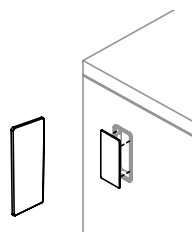

Xpress

RLED

Linear LED Light

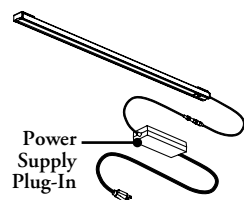

The Linear LED Light is mounted to the underside of all Elevated Desktop Cabinets, Overhead Cabinets and Shelves. It provides local task or ambiance lighting.

WHAT'S INCLUDED

1 light fixture with lens and switch, 1 power supply plug-in, 1 wire manager extrusion, 5 wire management channels, and mounting hardware.

NOTES

For countries other than those listed, contact Teknion's Customer Service.

The width should be one size smaller than the width of the cabinet or shelf under which the light is mounted.

PRODUCT OPTIONS

Width	Plug Option	Mounting Option	Optional Feature	Country of Installation	Finish
24, 36, 48	0 Standard	S Standard	0 Light Only	A Canada/U.S.A	AC Clear Anodized

SAMPLE ORDER CODE

RLED 24	0	S	0	A	AC
----------------	----------	----------	----------	----------	-----------

DIMENSIONS INCHES / MM

W
24 / 610
36 / 914
48 / 1219

PRICING

244
343
440

This light is mounted to the underside of an overhead cabinet, solid or metal shelf, or elevated desktop cabinet. It provides task lighting for the worksurface.

WHAT'S INCLUDED

1 tangent undercabinet light of specified width, attachment hardware for both metal and wood overhead cabinets (magnets, mounting plates and screws), and 10' cord with detachable power adapter face.

NOTES

- Color temperature of 3500K.
- Dimming of ON/OFF, 100%, 60%, 30%.
- Lifespan of 50,000 hours.
- Color Rendering Index (CRI) of 80+.
- Generates 900 Lux.
- UL/c-UL certified.
- Optional PIR Occupancy Sensor with override for on and off.
- Input voltage 100 - 240 V.
- Output voltage 24 V 1A.
- 20" wide light can be used with 24" to 84" wide overheads.
- 23" wide light can be used with 30" to 84" wide overheads.
- 30" and 33" wide lights can be used with 42" to 84" wide overheads.
- 40" wide light can be used with overhead 48" to 84" wide overheads.
- 43" wide light can be used with overhead 54" to 84" wide overheads.

R L Y T U
Tangent Undercabinet Light

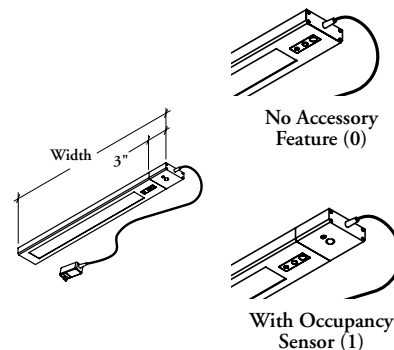

PRODUCT OPTIONS

Accessory Feature	Width	Country of Installation	Finish
0 No Accessory Feature	20, 23, 30, 33, 40, 43	A Canada / U.S.A.	AC Clear Anodized
1 With Occupancy Sensor			

SAMPLE ORDER CODE

RLYTU 24	20	A	AC
-----------------	-----------	----------	-----------

DIMENSIONS
INCHES / MM

W
20 / 508
23 / 584
30 / 762
33 / 838
40 / 1016
43 / 1092

PRICING

NO ACCESSORY FEATURE (0)	WITH OCCUPANCY SENSOR (1)
268	n/a
n/a	340
367	n/a
n/a	437
466	n/a
n/a	535

Xpress

RLSA Shelf Adapter for Universal Light

The Shelf Adapter for Universal Light is mounted under column-mounted laminate shelves to allow for the installation of a Universal Light.

WHAT'S INCLUDED

1 shelf adapter with mounting hardware.

NOTES

The specified width must be less than or equal to the width of the shelf under which the adapter is mounted.

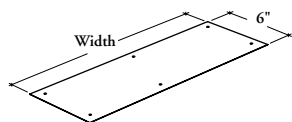

PRODUCT OPTIONS

Width	Finish
24, 30, 36, 42, 48, 54, 60, 66, 72, 78, 84	Foundation Mica

SAMPLE ORDER CODE

RLSA 24	G
---------	---

DIMENSIONS INCHES / MM

W
24 / 610
30 / 762
36 / 914
42 / 1067
48 / 1219
54 / 1372
60 / 1524
66 / 1676
72 / 1829
78 / 1981
84 / 2134

PRICING

	Foundation	Mica
	38	42
	39	45
	41	46
	46	51
	46	51
	79	89
	79	89
	81	93
	90	107
	90	107
	94	113



RLWT Cable Tray

The Cable Tray attaches to the underside of a worksurface to manage excess wires.

WHAT'S INCLUDED

1 cable tray and mounting hardware.

WHAT'S EXCLUDED

Underworksurface Plug-In Power Bar.

NOTES

The Underworksurface Plug-In Power Bar (RLPP) can be clipped to this product.

Available in black only.

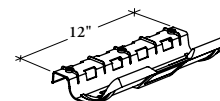

PRODUCT OPTIONS

Width
12

SAMPLE ORDER CODE

RLWT 12

DIMENSIONS INCHES / MM	PRICING
W	
12 / 305	21

Xpress

RLUDB

Communication Box

The Communication Box can be screwed under the worksurface at the desired location.

WHAT'S INCLUDED

1 communication box

WHAT'S EXCLUDED

Voice/data faceplates and jacks (must be field supplied and installed) and Wire Management Clips.

NOTES

The communication box has an opening of 2.71" x 1.38" (69 mm x 35 mm).

Finished in a Platinum Coordinate.

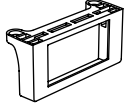

PRICING

38

RLPP

Underworksurface Plug-In Power Bar

This power bar has four outlets and may be connected to a wall outlet multi-outlet strip or power source.

WHAT'S INCLUDED

1 underworksurface plug-in power bar.

WHAT'S EXCLUDED

Wire Management Clips and Cable Tray.

NOTES

This product has a flat 45° plug.

This product is finished in Clear Anodized.

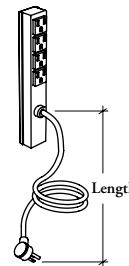

PRODUCT OPTIONS

Length (Inches)

72, 180

SAMPLE ORDER CODE

RLPP 180

**DIMENSIONS
INCHES / MM**

PRICING

L	
72 / 1829	303
180 / 4572	217

Xpress

RLDCC

Worksurface Power and Communication Center

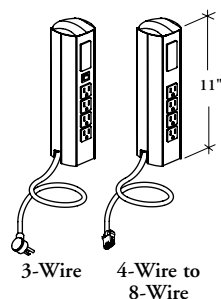

Outlet Configurations	
Wiring Systems	Simplex (from bottom)
3P	1111
4B	1122
5D	1123
7G	1255
8N	1255
8T	1235
8K	1256

The Worksurface Power and Communication Center provides access to electrics and data at worksurface height.

WHAT'S INCLUDED

1 worksurface power and communication center, and mounting hardware.

WHAT'S EXCLUDED

Wire Management Clips, Structural Column and Voice/Data faceplates and jacks.

NOTES

The 3-Wire option (3P) has a flat 45° plug.

The data cut-out is designed to accept a data faceplate.

This product is finished in anodized aluminum with black top cap.

Cannot be mounted on a Spine Desk.

PRODUCT OPTIONS

Wire System	Length	Country of Installation
3P 3-Wire (Plug In) 4B 4-Wire 5D 5-Wire 7G 7-Wire, Isolated Ground 8T 8-Wire, Isolated Ground 8N 8-Wire, Separate Neutral 8K 8-Wire, Dual Isolated	021, 024, 027, 030, 033, 036, 042, 048, 054, 060, 066, 072, 078, 084, 090, 096, 102, 108, 114, 120, 126, 132, 138, 144	A Canada / U.S.A.

SAMPLE ORDER CODE

RLDCC 4B	078	A
-----------------	------------	----------

DIMENSIONS INCHES / MM

L
21 / 533
24 / 610
27 / 686
30 / 762
33 / 838
36 / 914
42 / 1067
48 / 1219
54 / 1372
60 / 1524
66 / 1676
72 / 1829
78 / 1981
84 / 2134
90 / 2286
96 / 2438
102 / 2591
108 / 2743
114 / 2896
120 / 3048
126 / 3200
132 / 3353
138 / 3505
144 / 3658

PRICING

3-Wire (3P)	4- or 5-Wire (4B or 5D)	7- to 8-Wire (7G to 8K)
n/a	216	222
n/a	219	225
n/a	222	227
n/a	225	232
n/a	227	235
n/a	232	239
n/a	237	244
n/a	241	249
n/a	248	253
n/a	252	258
n/a	256	263
210	262	268
n/a	267	275
n/a	271	280
n/a	278	284
n/a	283	289
n/a	288	293
244	292	297
n/a	296	304
n/a	303	309
n/a	307	314
n/a	312	319
n/a	318	324
275	321	328

The Power/Data Center is used to provide quick power, data and USB access at the worksurface level.

WHAT'S INCLUDED

1 power/data center, voice/data adapters, and template.

**RLDMC
Power/Data Center**

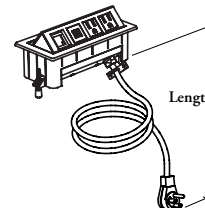

PRODUCT OPTIONS

Length	Configuration	Finish
072, 120	221 2 Power / 2 USB / 1 Data	B Soft Gris
	301 3 Power / 0 USB / 1 Data	E Ebony

SAMPLE ORDER CODE

RLDMC 072	221	B
------------------	------------	----------

**DIMENSIONS
INCHES / MM**

L
72 / 1829
120 / 3048

PRICING

CONFIGURATION	
221	301
292	222
313	241

lighting, electrics & communications

Xpress

RLDU Power Box

The Power Box provides either single- or double-sided power access in a Modular or Spine Desk.

WHAT'S INCLUDED

1 power box (single or double sided, as specified) and support brackets.

NOTES

Two duplexes are available on each side (as specified).

Equipped with four female connectors in order to facilitate one "in" and up to three "out" in a non-directional configuration.

This Power Box must be specified with the same wire system as the Base Feed, Ceiling Feed or harnesses.

A Double-Sided Power Box **cannot** be mounted on a Single-Sided Spine Desk.

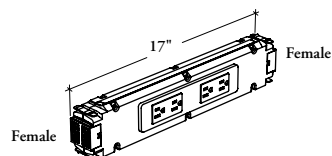

PRODUCT OPTIONS

Mounting Option	Wire System	Single-Sided Outlet Configuration	Double-Sided Outlet Configuration	Country of Installation
M Modular Desk	4B 4-Wire	11 Circuit 1 & 1	1111 Circuit 1	A Canada/U.S.A.
	5D 5-Wire	12 Circuit 1 & 2	1122 Circuit 1 & 2	
S Spine Desk	7G 7-Wire Isolated Ground	13 Circuit 1 & 3 (for use with 5D or 8T only)	1133 Circuit 1 & 3 (for use with 5D or 8T only)	
		15 Circuit 1 & 5 (for use with 7G, 8T, 8N or 8K only)	1155 Circuit 1 & 5 (for use with 7G, 8T, 8N or 8K only)	
Application	8T 8-Wire Isolated Ground	16 Circuit 1 & 6 (for use with 8K only)	1166 Circuit 1 & 6 (for use with 8K only)	
		22 Circuit 2 & 2	1212 Circuit 1 & 2	
S Single-Sided	8N 8-Wire Separate Neutral	23 Circuit 2 & 3 (for use with 5D or 8T only)	1313 Circuit 1 & 3 (for use with 5D or 8T only)	
		25 Circuit 2 & 5 (for use with 7G, 8T, 8N or 8K only)	1515 Circuit 1 & 5 (for use with 7G, 8T, 8N or 8K only)	
D Double-Sided	8K 8-Wire Dual Isolated	26 Circuit 2 & 6 (for use with 8K only)	1516 Circuit 1, 5 & 6 (for use with 8K only)	
		33 Circuit 3 & 3 (for use with 5D or 8T only)	1525 Circuit 1, 2 & 5 (for use with 7G, 8T, 8N or 8K only)	
		35 Circuit 3 & 5 (for use with 8T only)	1526 Circuit 1,2, 5 & 6 (for use with 8K only)	
		55 Circuit 5 & 5 (for use with 7G, 8T, 8N or 8K only)	1535 Circuit 1, 3 & 5 (for use with 8T only)	
		56 Circuit 5 & 6 (for use with 8K only)	1616 Circuit 1 & 6 (for use with 8K only)	
		66 Circuit 6 & 6 (for use with 8K only)	1625 Circuit 1, 2, 5 & 6 (for use with 8K only)	
			1626 Circuit 1, 2 & 6 (for use with 8K only)	
			2222 Circuit 2	
			2323 Circuit 2 & 3 (for use with 5D or 8T only)	
			2525 Circuit 2 & 5 (for use with 7G, 8T, 8N or 8K only)	
			2526 Circuit 2, 5 & 6 (for use with 8K only)	
			2535 Circuit 2, 3 & 5 (for use with 8T only)	
			2626 Circuit 2 & 6 (for use with 8K only)	
			3333 Circuit 3 (for use with 5D or 8T only)	
			3355 Circuit 3 & 5 (for use with 8T only)	
			3535 Circuit 3 & 5 (for use with 8T only)	
			5555 Circuit 5 (for use with 7G, 8T, 8N or 8K only)	
			5556 Circuit 5 & 6 (for use with 8K only)	
			5656 Circuit 5 & 6 (for use with 8K only)	
			6666 Circuit 6 (for use with 8K only)	

SAMPLE ORDER CODE

RLDU				
M	D	8T	1111	A

APPLICATION

PRICING

	4- or 5-Wire (4B or 5D)	7- to 8-Wire (7G to 8K)
S	283	311
D	306	333

The Chicago Power Box provides either single- or double-sided power access in a Modular or Spine Desk.

WHAT'S INCLUDED

1 power box (single- or double-sided, as specified) and support brackets.

WHAT'S EXCLUDED

Wires and Connectors.

NOTES

Two duplexes on each side (as specified).

A Double-Sided Power Box **cannot** be mounted on a Single-Sided Spine Desk.

Connections must be done on-site by a certified electrician.

RLCU
Chicago Power Box

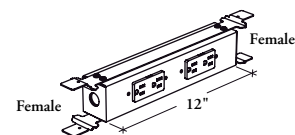

PRODUCT OPTIONS

Mounting Option	Application	Country of Installation
M Modular Desk	D Double-Sided	A Canada / U.S.A.
S Spine Desk	S Single-Sided	

SAMPLE ORDER CODE

RLCU S	S	A
---------------	----------	----------

APPLICATION	PRICING
S	283
D	306

Xpress

RLDSB

Distribution Box

This Distribution Box is used to split the power entry at the beginning of a workstation cluster to provide power for multiple workstations.

WHAT'S INCLUDED

1 distribution box and 2 support brackets.

NOTES

Is equipped with four female connectors in order to facilitate one "in" and up to three "out" in a non-directional configuration.

This Distribution Box must be specified with the same wire system as the Base Feed, Ceiling Feed or harnesses.

Cannot be mounted under a Spine Desk.

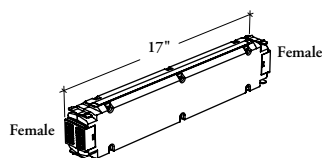

PRODUCT OPTIONS

Wire System	Country of Installation
4B 4-Wire	A Canada / U.S.A.
5D 5-Wire	
7G 7-Wire Isolated Ground	
8T 8-Wire Isolated Ground	
8N 8-Wire Separate Neutral	
8K 8-Wire Dual Isolated	

SAMPLE ORDER CODE

RLDSB 7G	A
----------	---

PRICING

4-Wire (4B)	5-Wire (5D)	7-Wire (7G)	8-Wire (8T to 8K)
264	268	293	296



RLDEC Beam Cover

The Beam Cover is used to hide wires under a desk.

WHAT'S INCLUDED

1 beam cover (with or without power and data, as specified) and 1 grey data blank per data cut-out.

WHAT'S EXCLUDED

Structural Beam (comes with desk), Voice/Data faceplates and jacks (must be field supplied and installed).

NOTES

Beam Cover width should match the width of the desk under which it is being applied.

Power and Data Access is **not** available on 24" or 30" wide cover and do **not** include data access on 36".

With Data Access and No Power includes one centered cut-out for widths between 24" and 36".

The Data Access has a standard opening of 2.71" x 1.38" (69 mm x 35 mm).

Coordinate colors for cover are solid colors that can be used to match wood prints such as those of modesty panel or gable.

Compatible with Modular Desks only.

With Power and Data Access

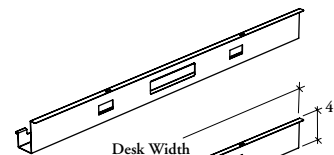

With Data Access and No Power



No Power or Data Access

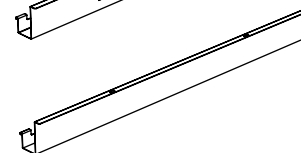

PRODUCT OPTIONS

Desk Width	Power	Finish
24, 30, 36, 42, 48, 54, 60, 66, 72, 78, 84	N No Power or Data Access D With Data Access and No Power P With Power and Data Access	Foundation Mica Coordinate Colors

SAMPLE ORDER CODE

RLDEC 54	P	N2
-----------------	----------	-----------

DIMENSIONS INCHES / MM

PRICING

W	NO POWER OR DATA ACCESS (N)		WITH DATA ACCESS AND NO POWER (D)		WITH POWER AND DATA ACCESS (P)	
	Foundation/ Coordinate Colors	Mica	Foundation/ Coordinate Colors	Mica	Foundation/ Coordinate Colors	Mica
24 / 610	50	56	50	56	n/a	n/a
30 / 762	56	68	56	68	n/a	n/a
36 / 914	68	79	68	79	68	79
42 / 1067	78	85	78	85	78	85
48 / 1219	82	94	82	94	82	94
54 / 1372	90	103	90	103	90	103
60 / 1524	96	116	96	116	96	116
66 / 1676	108	123	108	123	108	123
72 / 1829	116	131	116	131	116	131
78 / 1981	123	139	123	139	123	139
84 / 2134	131	150	131	150	131	150

Xpress

RLDS

Power Harness Extension

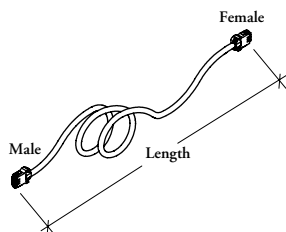

The Power Harness Extension brings power from the Ceiling Feed (RLDF) or Base Feed (RLDB) to the first Power Box (RLDU) in Modular or Spine Desks.

WHAT'S INCLUDED

1 power harness extension.

WHAT'S EXCLUDED

Base Feed, Ceiling Feed, Power Harness, Power Box and Distribution Box.

NOTES

The wire system for the Power Harness Extension must be specified to correspond to the components and infeeds being used in the configuration.

Check local codes for limits and restrictions on harness length.

See application guide for proper length calculation.

PRODUCT OPTIONS

Mounting Option	Wire System	Length	Country of Installation
M Modular Desk	4B 4-Wire	024, 027, 030, 033, 036, 039, 042, 045, 048, 051, 054, 057, 060, 063, 066, 069, 072, 075, 078, 081, 084, 087, 090, 093, 096, 099, 102, 105, 108, 111, 114, 117, 120, 123, 126, 129, 132, 135, 138	A Canada / U.S.A.
S Spine Desk	5D 5-Wire		
	7G 7-Wire Isolated Ground		
	8T 8-Wire Isolated Ground		
	8N 8-Wire Separate Neutral		
	8K 8-Wire Dual Isolated		

SAMPLE ORDER CODE

RLDS M	7G	114	A
---------------	-----------	------------	----------

**DIMENSIONS
INCHES / MM**

L
24 / 610
27 / 686
30 / 762
33 / 838
36 / 914
39 / 991
42 / 1067
45 / 1143
48 / 1219
51 / 1295
54 / 1372
57 / 1448
60 / 1524
63 / 1600
66 / 1676
69 / 1753
72 / 1829
75 / 1905
78 / 1981
81 / 2057
84 / 2134
87 / 2210
90 / 2286
93 / 2362
96 / 2438
99 / 2515

PRICING

4-Wire (4B)	5-Wire (5D)	7-Wire (7G)	8-Wire (8T)	8-Wire (8N)	8-Wire (8K)
133	144	174	202	211	213
137	150	177	205	213	220
137	150	177	205	213	220
139	154	182	211	217	229
139	154	182	211	217	229
139	157	191	213	220	240
139	157	191	213	220	240
148	166	196	226	239	251
148	166	196	226	239	251
150	167	198	229	241	253
150	167	198	229	241	253
154	173	209	237	249	262
154	173	209	237	249	262
165	174	213	240	252	267
165	174	213	240	252	267
169	193	222	248	260	271
169	193	222	248	260	271
171	194	227	251	262	282
171	194	227	251	262	282
174	198	233	262	277	289
174	198	233	262	277	289
176	200	237	264	278	297
176	200	237	264	278	297
179	204	241	277	289	307
179	204	241	277	289	307
182	209	249	282	292	318

Pricing is continued on the following page.

R L D S
Power Harness Extension
(Continued)

DIMENSIONS
INCHES / MM

PRICING

L	4-Wire (4B)	5-Wire (5D)	7-Wire (7G)	8-Wire (8T)	8-Wire (8N)	8-Wire (8K)
102 / 2591	182	209	249	282	292	318
105 / 2667	193	217	256	293	309	327
108 / 2743	193	217	256	293	309	327
111 / 2819	197	219	263	297	312	339
114 / 2896	197	219	263	297	312	339
117 / 2972	203	226	271	312	331	349
120 / 3048	203	226	271	312	331	349
123 / 3124	209	233	278	319	338	354
126 / 3200	209	233	278	319	338	354
129 / 3277	213	237	283	324	341	361
132 / 3353	213	237	283	324	341	361
135 / 3429	217	241	288	331	346	365
138 / 3505	217	241	288	331	346	365

lighting, electrics & communications

Xpress

RLDC

Power Harness

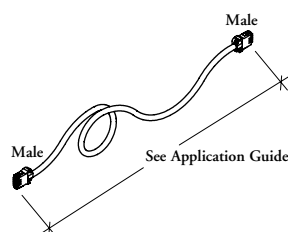

The Power Harness connects Power Box (RLDU) to each other.

WHAT'S INCLUDED

1 power harness.

WHAT'S EXCLUDED

Power Box, Distribution Box and Power Harness Extension.

NOTES

The wire system for the Power Harness must be specified to correspond to the components and infeeds being used in the configuration.

It can also be used with a Distribution Box.

Check local codes for limits and restrictions on harness length.

See application guide for proper length calculation.

30" and 33" lengths harness are **not** available with Modular Desk option (M).

Actual Length of Power Harness will be 12" to 15" less than Nominal Length specified.

PRODUCT OPTIONS

Mounting Option	Wire System	Nominal Length	Country of Installation
M Modular Desk	4B 4-Wire	030, 033, 036, 039, 042, 045, 048, 051, 054, 057, 060, 063, 066, 069, 072, 075, 078, 081, 084, 087, 090, 093, 096, 099, 102, 105, 108, 111, 114, 117, 120, 123, 126, 129, 132, 135, 138, 141, 144, 147, 150, 153, 156	A Canada / U.S.A.
S Spine Desk	5D 5-Wire		
	7G 7-Wire Isolated Ground		
	8T 8-Wire Isolated Ground		
	8N 8-Wire Separate Neutral		
	8K 8-Wire Dual Isolated		

SAMPLE ORDER CODE

RLDC S	7G	072	A
---------------	-----------	------------	----------

DIMENSIONS INCHES / MM

L
30 / 762
33 / 838
36 / 914
39 / 991
42 / 1067
45 / 1143
48 / 1219
51 / 1295
54 / 1372
57 / 1448
60 / 1524
63 / 1600
66 / 1676
69 / 1753
72 / 1829
75 / 1905
78 / 1981
81 / 2057
84 / 2134
87 / 2210
90 / 2286
93 / 2362
96 / 2438
99 / 2515

PRICING

4-Wire (4B)	5-Wire (5D)	7-Wire (7G)	8-Wire (8T)	8-Wire (8N)	8-Wire (8K)
139	154	182	211	217	229
139	154	182	211	217	229
139	154	182	211	217	229
139	157	191	213	220	240
139	157	191	213	220	240
148	166	196	226	239	251
148	166	196	226	239	251
150	167	198	229	241	253
150	167	198	229	241	253
154	173	209	237	249	262
154	173	209	237	249	262
165	174	213	240	252	267
165	174	213	240	252	267
169	193	222	248	260	271
169	193	222	248	260	271
171	194	227	251	262	282
171	194	227	251	262	282
174	198	233	262	277	289
174	198	233	262	277	289
176	200	237	264	278	297
176	200	237	264	278	297
179	204	241	277	289	307
179	204	241	277	289	307
182	209	249	282	292	318

Pricing is continued on the following page.

R L D C
Power Harness (Continued)

DIMENSIONS
INCHES / MM

PRICING

L	4-Wire (4B)	5-Wire (5D)	7-Wire (7G)	8-Wire (8T)	8-Wire (8N)	8-Wire (8K)
102 / 2591	182	209	249	282	292	318
105 / 2667	193	217	256	293	309	327
108 / 2743	193	217	256	293	309	327
111 / 2819	197	219	263	297	312	339
114 / 2896	197	219	263	297	312	339
117 / 2972	203	226	271	312	331	349
120 / 3048	203	226	271	312	331	349
123 / 3124	209	233	278	319	338	354
126 / 3200	209	233	278	319	338	354
129 / 3277	213	237	283	324	341	361
132 / 3353	213	237	283	324	341	361
135 / 3429	217	241	288	331	346	365
138 / 3505	217	241	288	331	346	365
141 / 3581	220	245	292	338	351	371
144 / 3658	220	245	292	338	351	371
147 / 3734	225	251	296	341	361	376
150 / 3810	225	251	296	341	361	376
153 / 3886	229	255	303	348	368	383
156 / 3962	229	255	303	348	368	383

lighting, electrics & communications

Xpress

RLDB

Base Feed

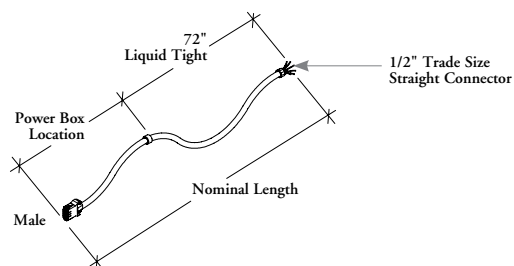

The Base Feed connects to the building supply and routes power into the workstation from the wall or floor.

WHAT'S INCLUDED

1 base feed harness and mounting hardware.

WHAT'S EXCLUDED

Power Harness Extension, Power Box and Distribution Box.

NOTES

The connection to the building power supply must be executed by a qualified electrician.

The same wire system must be specified for all electrical components in a configuration.

Check local codes for limits or restrictions on harness length.

PRODUCT OPTIONS

Mounting Option	Wire System	Desk Width (Not applicable with mounting option (A))	Country of Installation
M Modular Desk	4B 4-Wire	24, 30, 36, 42, 48, 54, 60, 66, 72, 78, 84	A Canada / U.S.A.
A Spine Desk – Adjacent Power Position	5D 5-Wire		
C Spine Desk – Centered Power Position	7G 7-Wire Isolated Ground		
O Spine Desk – Opposite Power Position	8T 8-Wire Isolated Ground		
	8N 8-Wire Separate Neutral		
	8K 8-Wire Dual Isolated		

SAMPLE ORDER CODE

RLDB M	7G	66	A
---------------	-----------	-----------	----------

**DIMENSIONS
INCHES / MM**

Dw
24 / 610
30 / 762
36 / 914
42 / 1067
48 / 1219
54 / 1372
60 / 1524
66 / 1676
72 / 1829
78 / 1981
84 / 2134

PRICING

MODULAR DESK MOUNTING OPTION (M)

4-Wire (4B)	5-Wire (5D)	7-Wire (7G)	8-Wire (8T to 8K)
291	295	333	340
293	297	333	343
295	299	340	347
296	304	343	349
298	307	346	351
299	311	349	356
303	312	351	361
306	316	355	364
307	318	361	369
311	320	364	371
312	324	368	374

Pricing is continued on the following page.

R L D B
Base Feed (Continued)

DIMENSIONS
INCHES / MM

PRICING

SPINE DESK MOUNTING OPTION – CENTERED POWER POSITION (C)

Dw	4-Wire (4B)	5-Wire (5D)	7-Wire (7G)	8-Wire (8T to 8K)
30 / 762	293	297	333	343
36 / 914	295	299	340	347
42 / 1067	296	304	343	349
48 / 1219	298	307	346	351
54 / 1372	299	311	349	356
60 / 1524	303	312	351	361
66 / 1676	306	316	355	364
72 / 1829	307	318	361	369
78 / 1981	311	320	364	371
84 / 2134	312	324	368	374

SPINE DESK MOUNTING OPTION – OPPOSITE POWER POSITION (O)

	4-Wire (4B)	5-Wire (5D)	7-Wire (7G)	8-Wire (8T to 8K)
48 / 1219	306	316	355	364
54 / 1372	311	320	364	371
60 / 1524	318	328	371	379
66 / 1676	326	339	378	391
72 / 1829	333	346	389	400
78 / 1981	343	351	396	408
84 / 2134	349	361	403	418

SPINE DESK MOUNTING OPTION – ADJACENT POWER POSITION (A)

293	297	333	343
-----	-----	-----	-----

Xpress

RLBS

NYC Split Base Feed

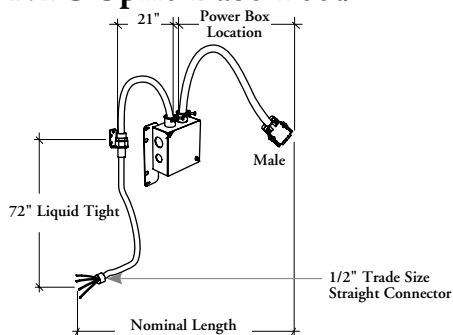

The NYC Split Base Feed connects to the building supply and routes power into the workstation from the wall or floor.

WHAT'S INCLUDED

1 base feed harness with junction box and mounting hardware.

WHAT'S EXCLUDED

Power Harness Extension, Power Box and Distribution Box.

NOTES

The connections in the junction box and to the building power supply must be executed by a qualified electrician.

The same wire system must be specified for all electrical components in a configuration.

Check local codes for limits or restrictions on harness length.

For use in the United States only.

PRODUCT OPTIONS

Mounting Option	Wire System	Desk Width (Not applicable with mounting option (A))	Country of Installation
M Modular Desk	4B 4-Wire	24, 30, 36, 42, 48, 54, 60, 66, 72, 78, 84	A U.S.A.
A Spine Desk – Adjacent Power Position	5D 5-Wire		
C Spine Desk – Centered Power Position	7G 7-Wire Isolated Ground		
O Spine Desk – Opposite Power Position	8T 8-Wire Isolated Ground		
	8N 8-Wire Separate Neutral		
	8K 8-Wire Dual Isolated		

SAMPLE ORDER CODE

RLBS M	7G	66	A
---------------	-----------	-----------	----------

DIMENSIONS INCHES / MM

Dw
24 / 610
30 / 762
36 / 914
42 / 1067
48 / 1219
54 / 1372
60 / 1524
66 / 1676
72 / 1829
78 / 1981
84 / 2134

PRICING

MODULAR DESK MOUNTING OPTION (M)

4-Wire (4B)	5-Wire (5D)	7-Wire (7G)	8-Wire (8T to 8K)
451	457	493	501
454	461	496	506
456	464	499	510
457	466	506	515
459	469	510	517
462	471	513	520
464	474	517	524
466	477	520	527
469	481	523	529
471	485	527	535
474	488	532	541

Pricing is continued on the following page.

NYC Split Base Feed (Continued)

DIMENSIONS
INCHES / MM

PRICING

SPINE DESK MOUNTING OPTION – CENTERED POWER POSITION (C)

Dw	4-Wire (4B)	5-Wire (5D)	7-Wire (7G)	8-Wire (8T to 8K)
30 / 762	454	461	496	506
36 / 914	456	464	499	510
42 / 1067	457	466	506	515
48 / 1219	459	469	510	517
54 / 1372	462	471	513	520
60 / 1524	464	474	517	524
66 / 1676	466	477	520	527
72 / 1829	469	481	523	529
78 / 1981	471	485	527	535
84 / 2134	474	488	532	541

SPINE DESK MOUNTING OPTION – OPPOSITE POWER POSITION (O)

	4-Wire (4B)	5-Wire (5D)	7-Wire (7G)	8-Wire (8T to 8K)
48 / 1219	474	486	527	536
54 / 1372	484	492	535	546
60 / 1524	490	499	544	553
66 / 1676	496	510	550	567
72 / 1829	506	517	559	574
78 / 1981	515	524	568	586
84 / 2134	522	532	574	596

SPINE DESK MOUNTING OPTION – ADJACENT POWER POSITION (A)

	4-Wire (4B)	5-Wire (5D)	7-Wire (7G)	8-Wire (8T to 8K)
	457	466	506	515

lighting, electrics & communications

Xpress

RLDF

Ceiling Feed

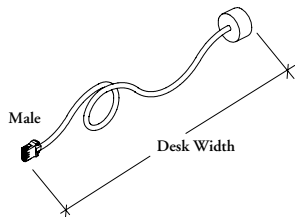

The Ceiling Feed includes a Junction Box to connect to the building supply and routes power into the workstation from the ceiling.

WHAT'S INCLUDED

1 ceiling feed harness, 1 junction box, and mounting hardware.

WHAT'S EXCLUDED

Power Harness Extension, Power Box, Distribution Box and Power Pole.

NOTES

The connection to the building power supply must be executed by a qualified electrician.

The same wire system must be specified for all electrical components in a configuration.

Can be routed from the ceiling to the workstation through a Column-Mounted Power Pole (RLSP) or Lateral Power Pole (RLPS).

Check local codes for limits and restrictions on harness length.

PRODUCT OPTIONS

Mounting Option	Wire System	Height (Power Pole)	Desk Width (Not applicable with mounting option (A))	Country of Installation
M Modular Desk	4B 4-Wire	048, 054, 096, 120, 144	24, 30, 36, 42, 48, 54, 60, 66, 72, 78, 84	A Canada / U.S.A.
A Spine Desk – Adjacent Power Position	5D 5-Wire			
C Spine Desk – Centered Power Position	7G 7-Wire Isolated Ground			
O Spine Desk – Opposite Power Position	8T 8-Wire Isolated Ground			
	8N 8-Wire Separate Neutral			
	8K 8-Wire Dual Isolated			

SAMPLE ORDER CODE

RLDF M	8T	048	78	A
---------------	-----------	------------	-----------	----------

**DIMENSIONS
INCHES / MM**

H	Dw
48 / 1219	24 / 610
48 / 1219	30 / 762
48 / 1219	36 / 914
48 / 1219	42 / 1067
48 / 1219	48 / 1219
48 / 1219	54 / 1372
48 / 1219	60 / 1524
48 / 1219	66 / 1676
48 / 1219	72 / 1829
48 / 1219	78 / 1981
48 / 1219	84 / 2134
54 / 1372	24 / 610
54 / 1372	30 / 762
54 / 1372	36 / 914
54 / 1372	42 / 1067
54 / 1372	48 / 1219
54 / 1372	54 / 1372
54 / 1372	60 / 1524
54 / 1372	66 / 1676
54 / 1372	72 / 1829
54 / 1372	78 / 1981
54 / 1372	84 / 2134

PRICING

MODULAR DESK MOUNTING OPTION (M)

4-Wire (4B)	5-Wire (5D)	7-Wire (7G)	8-Wire (8T to 8K)
191	213	252	271
194	216	255	277
196	219	258	280
198	222	262	283
200	224	263	284
200	224	263	287
204	227	268	289
209	232	271	293
213	237	278	297
217	240	282	303
222	245	287	307
196	219	258	280
198	222	262	283
200	224	263	284
200	224	263	287
204	227	268	289
209	232	271	293
213	237	278	297
217	240	282	303
222	245	287	307
225	249	289	312
229	253	293	318

Pricing is continued on the following page.

R L D F
Ceiling Feed (Continued)

DIMENSIONS
INCHES / MM

H	Dw
96 / 2438	24 / 610
96 / 2438	30 / 762
96 / 2438	36 / 914
96 / 2438	42 / 1067
96 / 2438	48 / 1219
96 / 2438	54 / 1372
96 / 2438	60 / 1524
96 / 2438	66 / 1676
96 / 2438	72 / 1829
96 / 2438	78 / 1981
96 / 2438	84 / 2134
120 / 3048	24 / 610
120 / 3048	30 / 762
120 / 3048	36 / 914
120 / 3048	42 / 1067
120 / 3048	48 / 1219
120 / 3048	54 / 1372
120 / 3048	60 / 1524
120 / 3048	66 / 1676
120 / 3048	72 / 1829
120 / 3048	78 / 1981
120 / 3048	84 / 2134
144 / 3658	24 / 610
144 / 3658	30 / 762
144 / 3658	36 / 914
144 / 3658	42 / 1067
144 / 3658	48 / 1219
144 / 3658	54 / 1372
144 / 3658	60 / 1524
144 / 3658	66 / 1676
144 / 3658	72 / 1829
144 / 3658	78 / 1981
144 / 3658	84 / 2134

PRICING

MODULAR DESK MOUNTING OPTION (M) (CONTINUED)			
4-Wire (4B)	5-Wire (5D)	7-Wire (7G)	8-Wire (8T to 8K)
181	203	232	251
181	203	233	253
183	204	237	255
190	208	241	258
190	209	245	262
190	211	249	264
191	212	251	268
191	213	252	271
194	216	255	277
196	219	258	280
200	224	263	287
196	219	258	280
198	222	262	283
200	224	263	284
200	224	263	287
204	227	268	289
209	232	271	293
213	237	278	297
217	240	282	303
222	245	287	307
225	249	289	312
229	253	293	318
217	240	282	303
222	245	287	307
225	249	289	312
229	253	293	318
356	396	465	532
361	399	471	544
362	400	473	536
365	403	477	544
369	405	484	549
371	408	487	553
374	412	491	564

Pricing is continued on the following page.

Xpress

R L D F

Ceiling Feed (Continued)

DIMENSIONS
INCHES / MM

PRICING

DIMENSIONS		SPINE DESK MOUNTING OPTION – CENTERED POWER POSITION (C)			
H	Dw	4-Wire (4B)	5-Wire (5D)	7-Wire (7G)	8-Wire (8T to 8K)
96 / 2438	30 / 762	181	203	233	253
96 / 2438	36 / 914	183	204	237	255
96 / 2438	42 / 1067	190	208	241	258
96 / 2438	48 / 1219	190	209	245	262
96 / 2438	54 / 1372	190	211	249	264
96 / 2438	60 / 1524	191	212	251	268
96 / 2438	66 / 1676	191	213	252	271
96 / 2438	72 / 1829	194	216	255	277
96 / 2438	78 / 1981	196	219	258	280
96 / 2438	84 / 2134	200	224	263	287
120 / 3048	30 / 762	198	222	262	283
120 / 3048	36 / 914	200	224	263	284
120 / 3048	42 / 1067	200	224	263	287
120 / 3048	48 / 1219	204	227	268	289
120 / 3048	54 / 1372	209	232	271	293
120 / 3048	60 / 1524	213	237	278	297
120 / 3048	66 / 1676	217	240	282	303
120 / 3048	72 / 1829	222	245	287	307
120 / 3048	78 / 1981	225	249	289	312
120 / 3048	84 / 2134	229	253	293	318
144 / 3658	30 / 762	222	245	287	307
144 / 3658	36 / 914	225	249	289	312
144 / 3658	42 / 1067	229	253	293	318
144 / 3658	48 / 1219	356	396	465	532
144 / 3658	54 / 1372	361	399	471	544
144 / 3658	60 / 1524	362	400	473	536
144 / 3658	66 / 1676	365	403	477	544
144 / 3658	72 / 1829	369	405	484	549
144 / 3658	78 / 1981	371	408	487	553
144 / 3658	84 / 2134	374	412	491	564

Pricing is continued on the following page.

R L D F
Ceiling Feed (Continued)

DIMENSIONS
INCHES / MM

H	Dw
96 / 2438	48 / 1219
96 / 2438	54 / 1372
96 / 2438	60 / 1524
96 / 2438	66 / 1676
96 / 2438	72 / 1829
96 / 2438	78 / 1981
96 / 2438	84 / 2134
120 / 3048	48 / 1219
120 / 3048	54 / 1372
120 / 3048	60 / 1524
120 / 3048	66 / 1676
120 / 3048	72 / 1829
120 / 3048	78 / 1981
120 / 3048	84 / 2134
144 / 3658	48 / 1219
144 / 3658	54 / 1372
144 / 3658	60 / 1524
144 / 3658	66 / 1676
144 / 3658	72 / 1829
144 / 3658	78 / 1981
144 / 3658	84 / 2134

PRICING

SPINE DESK MOUNTING OPTION – OPPOSITE POWER POSITION (O)				
4-Wire (4B)	5-Wire (5D)	7-Wire (7G)	8-Wire (8T to 8K)	
194	216	263	277	
200	224	268	284	
204	227	271	289	
213	237	278	297	
222	245	282	307	
229	253	287	318	
333	369	432	506	
222	245	282	307	
229	253	287	318	
348	389	464	534	
349	390	466	536	
354	398	477	546	
362	399	484	550	
369	414	490	553	
370	406	470	548	
372	412	480	564	
376	416	481	570	
378	418	485	572	
385	427	493	579	
393	428	498	586	
399	445	509	590	

SPINE DESK MOUNTING OPTION – ADJACENT POWER POSITION (A)				
4-Wire (4B)	5-Wire (5D)	7-Wire (7G)	8-Wire (8T to 8K)	
183	204	237	255	
200	224	263	287	
225	249	289	312	

Xpress

RLSP

Column-Mounted Power Pole

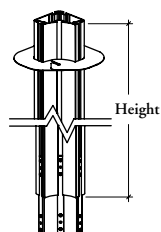

The Column-Mounted Power Pole is used to safely route power and communication cables from the top of a Structural Column to the ceiling.

WHAT'S INCLUDED

1 column-mounted power pole, 3 mounting rods, ceiling plates, and mounting hardware.

WHAT'S EXCLUDED

Ceiling Feed.

NOTES

If the same pole is used to route both power and communication cables, a Power Pole Divider (RLSD) is available.

The 48" long pole accommodates ceilings up to 9'.

The 54" long pole accommodates ceilings up to 9 1/2'.

The opening can accommodate up to 36 Data Cables cat5 and 1 Ceiling Feed

PRODUCT OPTIONS

Height	Finish
48, 54	Foundation Mica

SAMPLE ORDER CODE

RLSP 48	G
----------------	----------

**DIMENSIONS
INCHES / MM**

H
48 / 1219
54 / 1372

PRICING

	Foundation	Mica
	202	222
	222	244

The Power Pole Divider separates power cables from communication cables inside a Column-Mounted Power Pole.

WHAT'S INCLUDED

1 power pole divider.

WHAT'S EXCLUDED

Column-Mounted Power Pole.

NOTES

The Power Pole Divider extends beyond the length of a Column-Mounted Power Pole to separate power and communication cables below the worksurface.

Cannot be used in a lateral Power Pole.

RLSD
Power Pole Divider

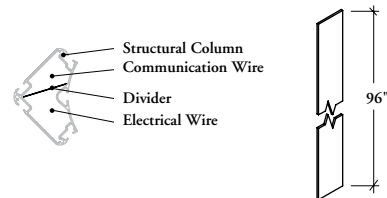

PRODUCT OPTIONS

Length
96

SAMPLE ORDER CODE

RLSD 96

DIMENSIONS
INCHES / MM

PRICING

L	
96 / 2438	53

Xpress

RLPS

Lateral Power Pole

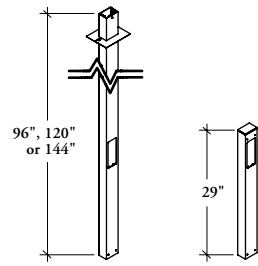

(Ceiling Feeds) (Base Feeds)

The Lateral Power Pole is used to safely route power and communication cables from the top of a worksurface, freestanding screen, freestanding storage or credenzas to the ceiling.

WHAT'S INCLUDED

1 lateral power pole, 1 divider, ceiling plates, and mounting hardware.

WHAT'S EXCLUDED

Ceiling Feed.

NOTES

The 29\"/>

The 96\"/>

The opening can accommodate up to 36 Data Cables cat5 and 1 Ceiling Feed.

Can mount on gables with grommets or on the Cable Pass-Through ring of a 2\"/>

PRODUCT OPTIONS

Mounting Hardware Option	Height	Finish
U Universal (Gables, Freestanding Storage, Credenza, 1\"/>	029, 096, 120, 144	Foundation Mica
Y 2\"/>		

SAMPLE ORDER CODE

RLPS U	144	E
---------------	------------	----------

**DIMENSIONS
INCHES / MM**

H
29 / 737
96 / 2438
120 / 3048
144 / 3658

PRICING

298
490
582
640

The Desking Grommets can be field-installed when cable management is needed.

WHAT'S INCLUDED

1 grommet or access door.

NOTES

Access Door style (A) is **not** available in Source Laminate.

RAG
Desking Grommets

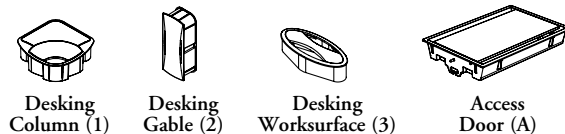

PRODUCT OPTIONS

Style	Finish
1 Desking Column	Source Laminate
2 Desking Gable	Foundation
3 Desking Worksurface	Mica
A Access Door	

SAMPLE ORDER CODE

RAG 1	3D
--------------	-----------

STYLE

PRICING

1	28
2	13
3	13
A	187

Xpress

RAGC

Rectangular Grommet

The grommet can be field installed when cable management is needed.

WHAT'S INCLUDED

1 grommet.

NOTES

Grommets can also be specified as an option on worksurface or tables.

Can be interchangeable with the Desking Worksurface Grommet (RAG3).

The grommet ring finish is Ebony only (Cover Finish as specified).



PRODUCT OPTIONS

Cover Finish

Foundation

Mica

SAMPLE ORDER CODE

RAGC 7

PRICING

28

The Cable Pass-Through Cover is mounted on a Cable Pass-Through ring on screens, freestanding storage or credenzas.

WHAT'S INCLUDED
1 cable pass-through cover.

RAWPC
Cable Pass-Through Cover

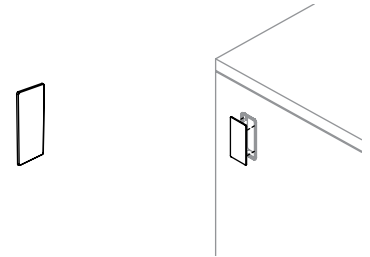

PRODUCT OPTIONS

Finish
Foundation
Mica
Coordinate Colors

SAMPLE ORDER CODE

RAWPC 7

PRICING

international electricians

international electrics product map

V E D Outlet Box

Page 528

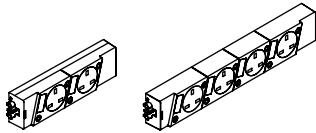

V C C Interconnecting Power Cable

Page 529

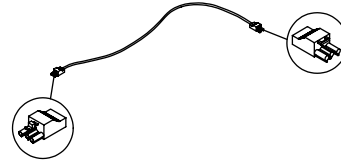

V E P Input Power Cable

Page 530

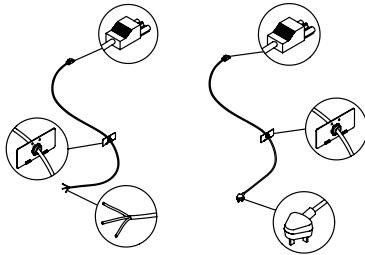

V V D Voice and Data Box

Page 531

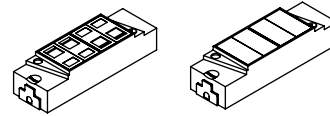

V D O Voice and Data Outlets

Page 532

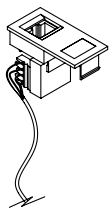

V A C Electric Accessories

Page 533

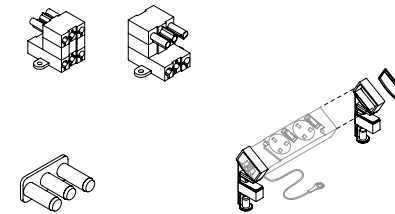

R L I _ B Desking Adapter for International Electrics

Page 534

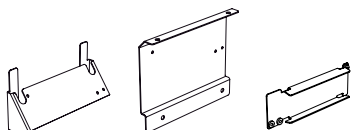

VED Outlet Box

Provides access to power at worksurface height. It can be mounted to the edge of a desk or table using the Desking Adapter for International Electric (RLI_B).

WHAT'S INCLUDED

1 outlet box.

WHAT'S EXCLUDED

Power Input Cable, Interconnecting Power Cable, and Desking Adapter for International Electric must be ordered separately.

NOTES

Socket Angles will always be 15°.

If desk-mounted option is desired, Desk-Mounting Clip (VACB6) (Electric Accessories VAC) must be purchased separately.

UPS option is only available with UK Outlets (G).

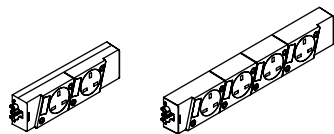

Two Outlets

Four Outlets

PRODUCT OPTIONS

Number of Outlets	Power Type	Fuse and Switch Option	Mounting Bracket	Country of Installation
2 2 Outlets	S Standard	M Master Fuse and Master Switch	N None	F Germany
4 4 Outlets	U UPS	N No Fuse and Switch		G U.K./Ireland
		S Individual Fuse and Individual Switch		I Australia and Argentina

SAMPLE ORDER CODE

VED 2	S	N	N	F
--------------	----------	----------	----------	----------

NUMBER OF OUTLETS

PRICING

	NO MOUNTING BRACKET (N)		
	No Fuse and Switch (N)	Master Fuse and Master Switch (M)	Individual Fuse and Individual Switch (S)
2	110	152	194
4	176	248	303

Routes power between Outlet Boxes and also carries power through the adjacent desk.

WHAT'S INCLUDED

1 interconnecting power cable.

VCC
Interconnecting Power Cable

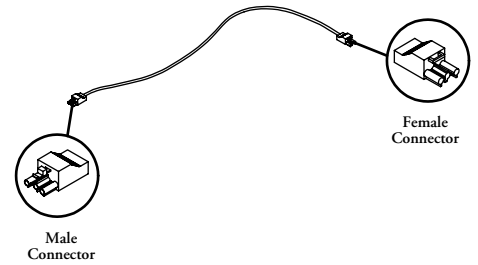

PRODUCT OPTIONS

Length	Power Type
10 1 Meter	S Standard
20 2 Meters	U UPS
30 3 Meters	

SAMPLE ORDER CODE

VCC 10	U
--------	---

DIMENSIONS

L
10 (1 Meter)
20 (2 Meters)
30 (3 Meters)

PRICING

66
79
92

VEP

Input Power Cable

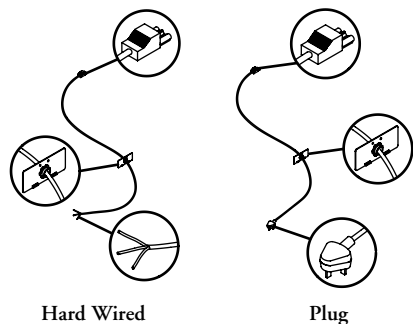

The Input Power Cable brings power from the workstation.

WHAT'S INCLUDED

1 input power cable with strain relief.

WHAT'S EXCLUDED

Power Input Cable and Interconnecting Power Cable must be ordered separately.

NOTES

Country of Installation required when Plug option is chosen.

PRODUCT OPTIONS

Length	Plug Type	Power Type	Country of Installation
10 1 Meter	H Hard Wired	S Standard	F Germany
20 2 Meters	P Plug	U UPS	G U.K./Ireland
30 3 Meters			I Australia

SAMPLE ORDER CODE

VEP 10	P	S	G
---------------	----------	----------	----------

DIMENSIONS

L
10 (1 Meter)
20 (2 Meters)
30 (3 Meters)

PRICING

	Hard Wired (H)	Plug (P)
	90	125
	97	132
	118	153

The Voice and Data Box is designed to bring access to communications and data to the user.

WHAT'S INCLUDED

1 voice and data box with blank or shutter faces (as specified).

WHAT'S EXCLUDED

Voice and Data Outlets with drop leads and Desking Adapter for International Electrics must be ordered separately.

VVD
Voice and Data Box

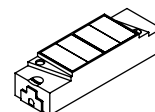

Four Blank Fascias

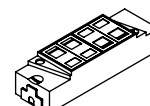

Four Shutters

PRODUCT OPTIONS

Configuration		Shutter (If applicable)
BBBB	4 Blank Fascias	K Keystone A AT&T N Nordx
SSSS	4 Shutters	

SAMPLE ORDER CODE

VVD BBBB	K
-----------------	----------

CONFIGURATION

PRICING

BBBB	56
SSSS	79

V D O

Voice and Data Outlets

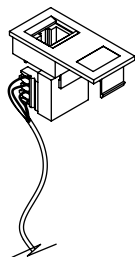

The Voice and Data Outlets are inserted into the Voice and Data Box (VVD).

WHAT'S INCLUDED

1 voice or data outlet with appropriate length drop lead (if specified).

WHAT'S EXCLUDED

Voice and Data Boxes (VVD) must be ordered separately.

NOTES

One must remove the blank facades in the boxes to allow placement of these items.

Drop Lead may be specified according to the size required.

Cannot be mounted on Spine Desks.

PRODUCT OPTIONS

Outlet Type	Voice Outlet (Applies to Voice Type only)	Data Outlet (Applies to Data Type only)	Drop Lead Option
V Voice	01 RJ11	05 RJ45 Cat 5e Unshielded	2 2 Meters
D Data			3 3 Meters
			8 8 Meters
			N None

SAMPLE ORDER CODE

VDO D		05	3
--------------	--	-----------	----------

OUTLET TYPES

PRICING

	None	2 Meters	3 Meters	8 Meters
V	58	75	79	110
D	58	124	126	176

The Distribution Block redirects power distribution. The Cover Cap is a safety cover for Outlet Boxes and Distribution Blocks. The Desk-Mounted Clips attach an Outlet Box to a desk or worksurface.

V A C Electric Accessories

WHAT'S INCLUDED

1 distribution block or 1 cover cap or 1 desk-mounting clips for outlet box.

WHAT'S EXCLUDED

Outlet Box and all Interconnecting and Power Input Cables must be ordered separately.

NOTES

The Distribution Block has one male connector that directs power in and three female connectors that direct power out.

Cannot be mounted on Spine Desks.



Distribution Block



Cover Cap

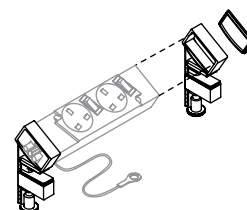

Desk-Mounted Clips for Outlet Box

PRODUCT OPTIONS

Accessory Type	Power Option (For Distribution Block)
EB Distribution Block	S Standard
EC Cover Cap	U UPS
B6 Desk-Mounted Clips for Outlet Box	

SAMPLE ORDER CODE

VAC EB	S
---------------	----------

ACCESSORY TYPES

PRICING

EC	9
B6	56
EB	108

RLI_B

Desking Adapter for International Electric

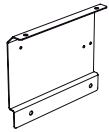

Spine Desk – Shared (D)



Modular Desk (M)

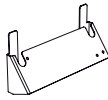

Spine Desk – Single-Sided (S)

This adapter attaches the Outlet Box (VED) or the Voice and Data Box (VVD) to a desk.

WHAT'S INCLUDED

1 desking adapter for international electric and mounting hardware.

WHAT'S EXCLUDED

Outlet Box and Voice and Data Box.

NOTES

Mounting option must be specified according to the desk configuration under which the adapter is installed.

Mounting option Spine Desks – Shared (D) allows mounting a Single Outlet Box on one side of the desk.

This product is finished in Platinum.

PRODUCT OPTIONS

Mounting Option	Compatibility Option
D Spine Desk – Shared M Modular Desk S Spine Desk – Single-Sided	A VED VVD

SAMPLE ORDER CODE

RLIMB	A
--------------	----------

PRICING

teknion

www.teknion.com

IN CANADA:

1150 Flint Road
Toronto, Ontario
M3J 2J5 Canada
Tel 866.teknion
866.835.6466

IN THE USA:

350 Fellowship Road
Mt Laurel, New Jersey
08054 USA
Tel 877.teknion
877.835.6466

OTHER OFFICES LOCATED IN:

Europe, South and Central America
Middle East, Asia and Russia
For regional contact information
go to www.teknion.com

CAN/US/INT 09-25

©Teknion 2023

®, ™ trade marks of Teknion Corporation and/or its subsidiaries or licensed to it. Patents may be pending.

Some products may not be available in all markets. Contact your local Teknion Representative for availability.

SEP23-EXPDESK